

Title: Beetle-cm-32u4	Code: DFR0816
Drawn: lfwag-CD	Revision: V0.2
Page: 1 of 1	Date: 2021/5/31
Size: A4	Time: 10:47:32

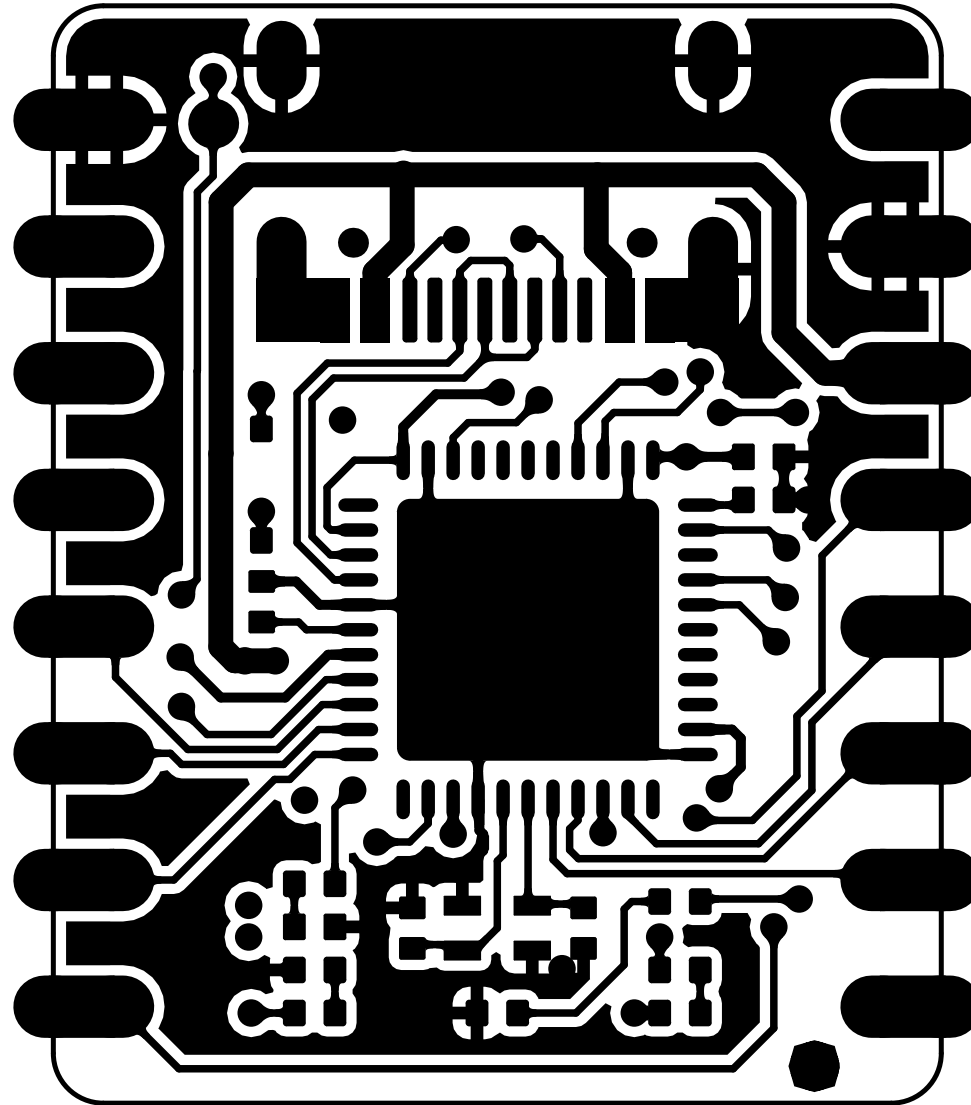

1

<b>PCB Information</b>	Name:DFR0816[V0.2]	Thickness: 1.0mm
Engineer:lfwag_CD	Top SolderMask: Black	Bottom SolderMask: Black
Date:20210531	Top Silkscreen: White	Bottom Silkscreen: White

4

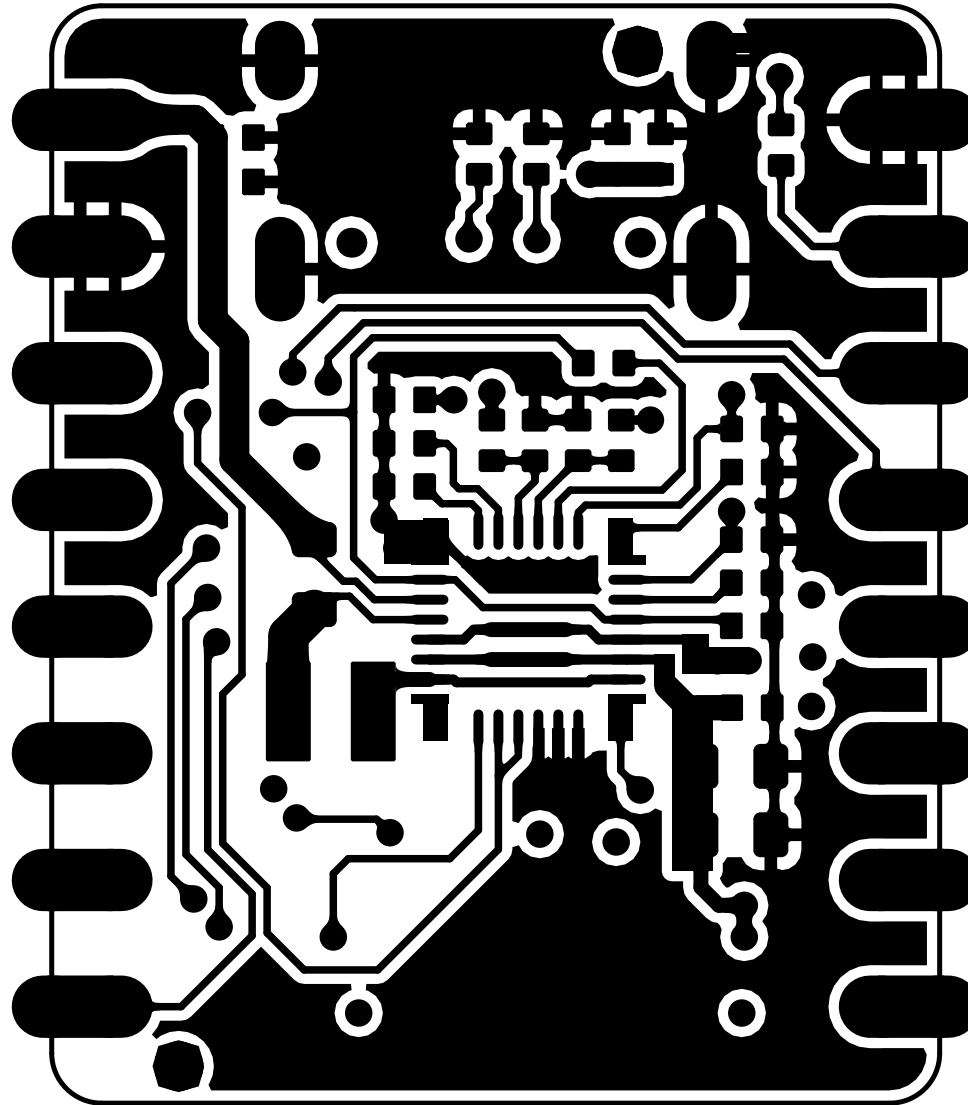

<b>PCB Information</b>	Name:DFR0816[V0.2]	Thickness: 1.0mm
Engineer:lfwag_CD	Top SolderMask: Black	Bottom SolderMask: Black
Date:20210531	Top Silkscreen: White	Bottom Silkscreen: White

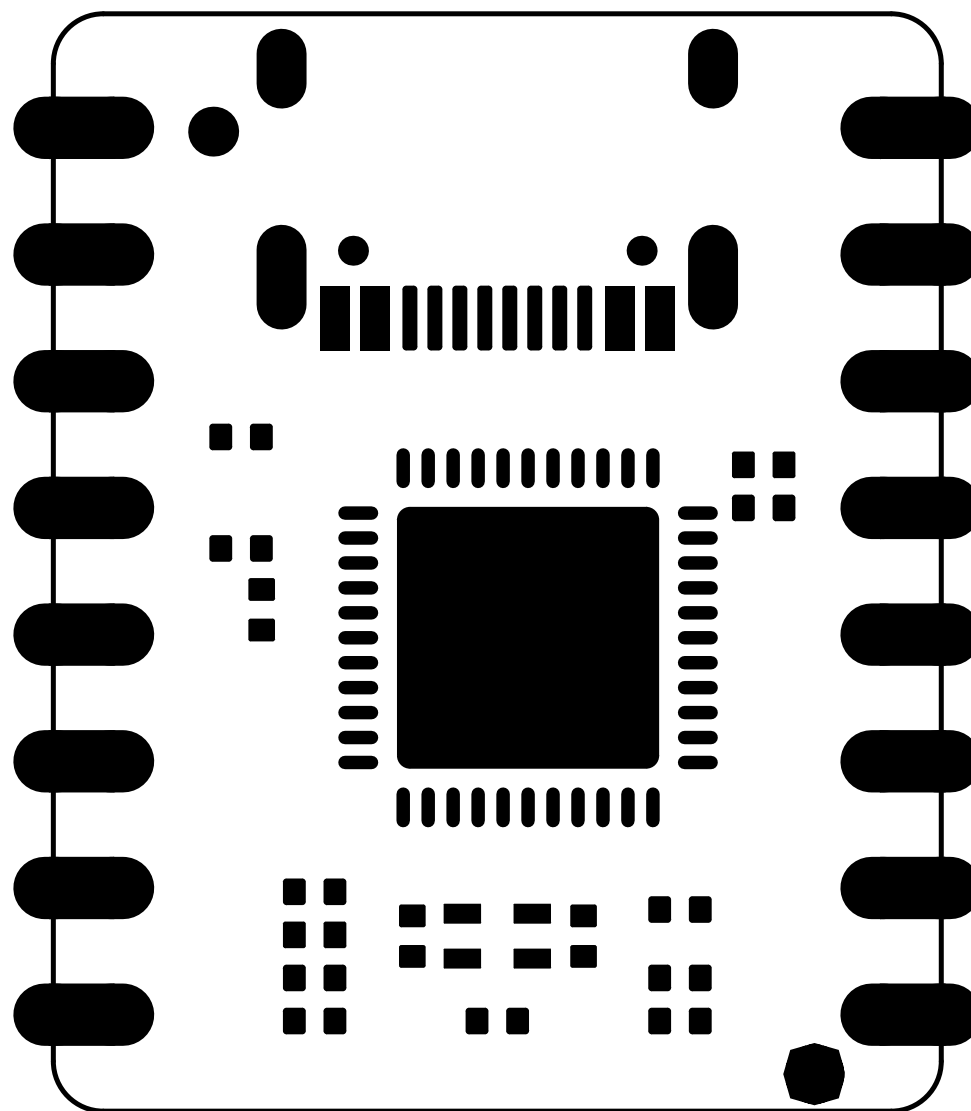

<b>PCB Information</b>	Name:DFR0816[V0.2]	Thickness: 1.0mm
Engineer:lfwag_CD	Top SolderMask: Black	Bottom SolderMask: Black
Date:20210531	Top Silkscreen: White	Bottom Silkscreen: White

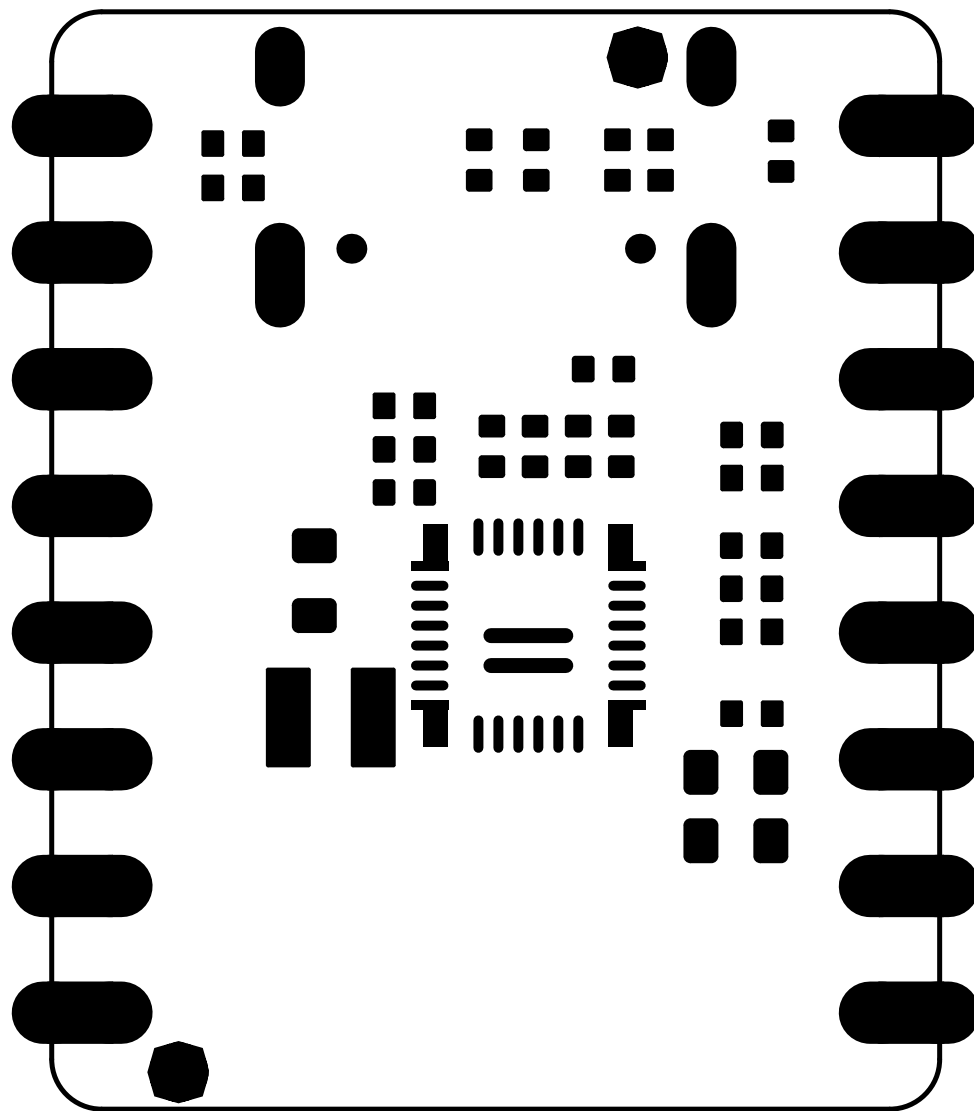

<b>PCB Information</b>	Name:DFR0816[V0.2]	Thickness: 1.0mm
Engineer:lfwag_CD	Top SolderMask: Black	Bottom SolderMask: Black
Date:20210531	Top Silkscreen: White	Bottom Silkscreen: White

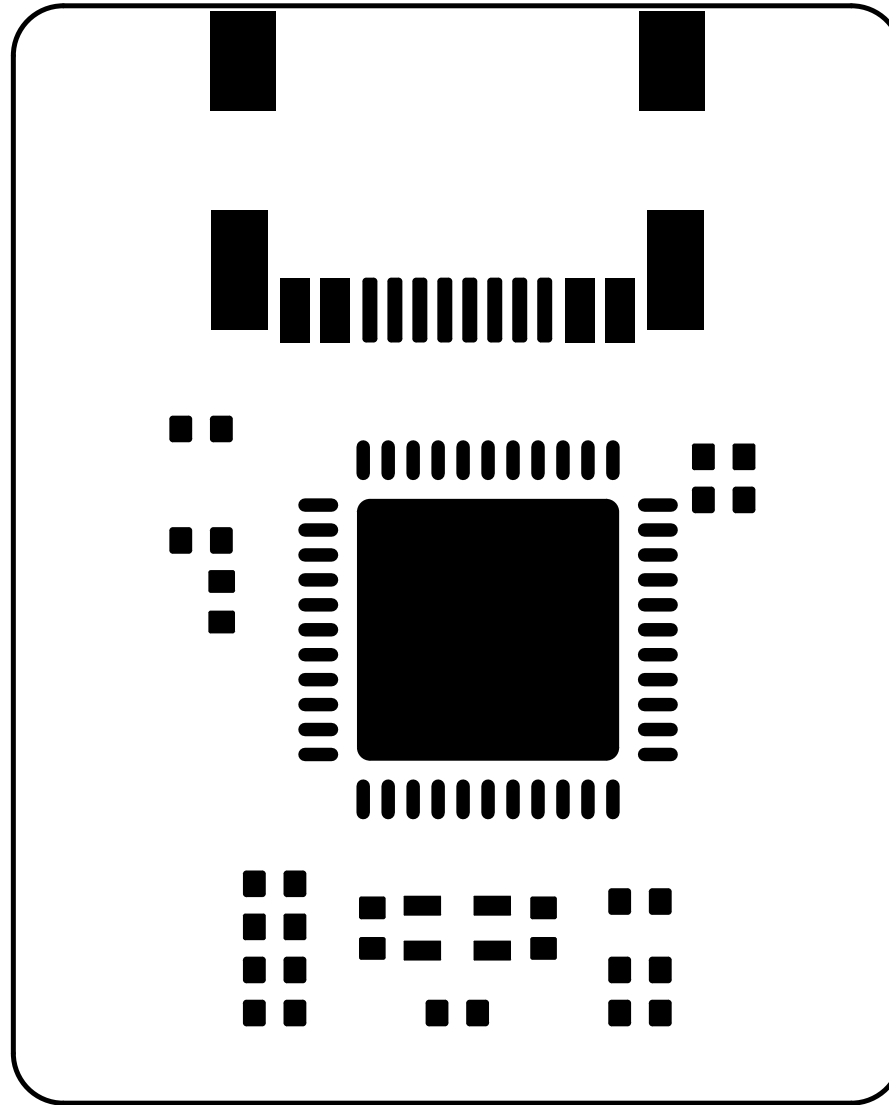

<b>PCB Information</b>	Name:DFR0816[V0.2]	Thickness: 1.0mm
Engineer:lfwag_CD	Top SolderMask: Black	Bottom SolderMask: Black
Date:20210531	Top Silkscreen: White	Bottom Silkscreen: White

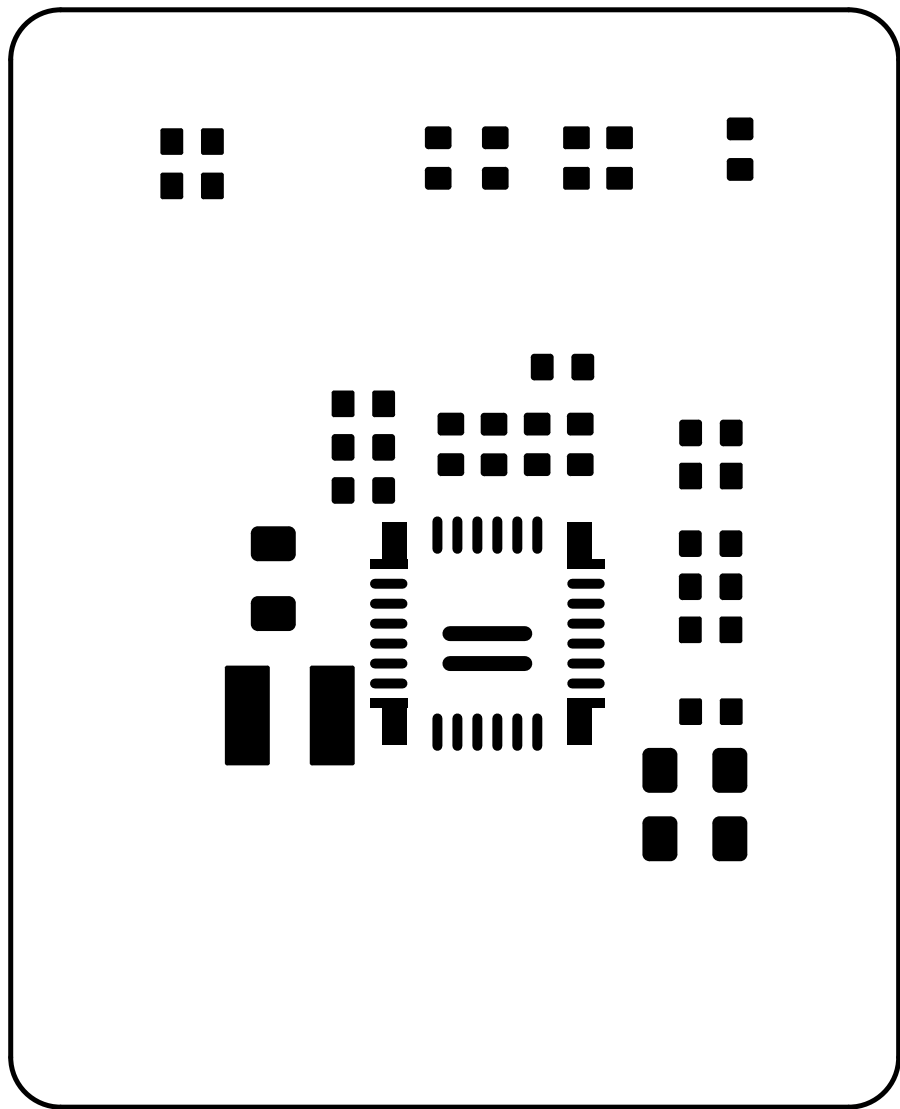

<b>PCB Information</b>	Name:DFR0816[V0.2]	Thickness: 1.0mm
Engineer:Ifwag_CD	Top SolderMask: Black	Bottom SolderMask: Black
Date:20210531	Top Silkscreen: White	Bottom Silkscreen: White

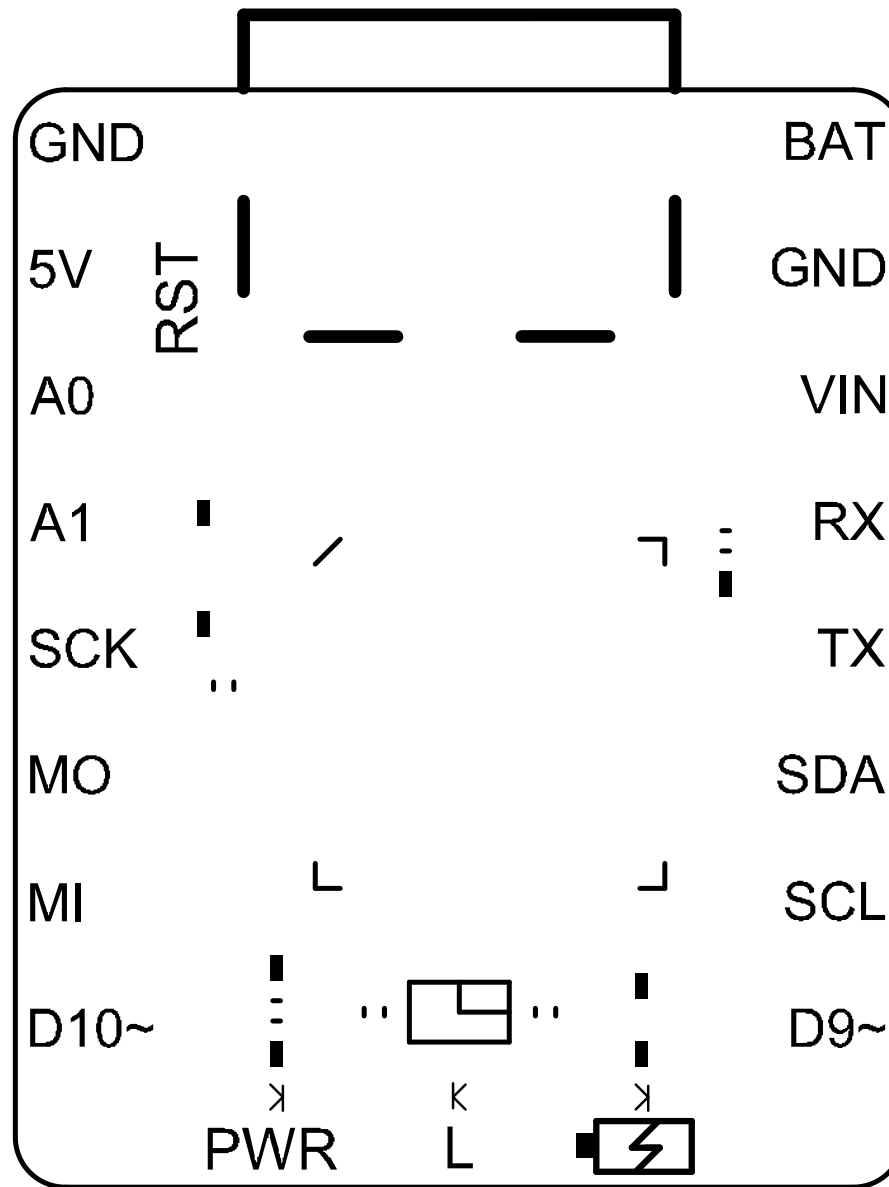

<b>PCB Information</b>	Name:DFR0816[V0.2]	Thickness: 1.0mm
Engineer:lfwag_CD	Top SolderMask: Black	Bottom SolderMask: Black
Date:20210531	Top Silkscreen: White	Bottom Silkscreen: White



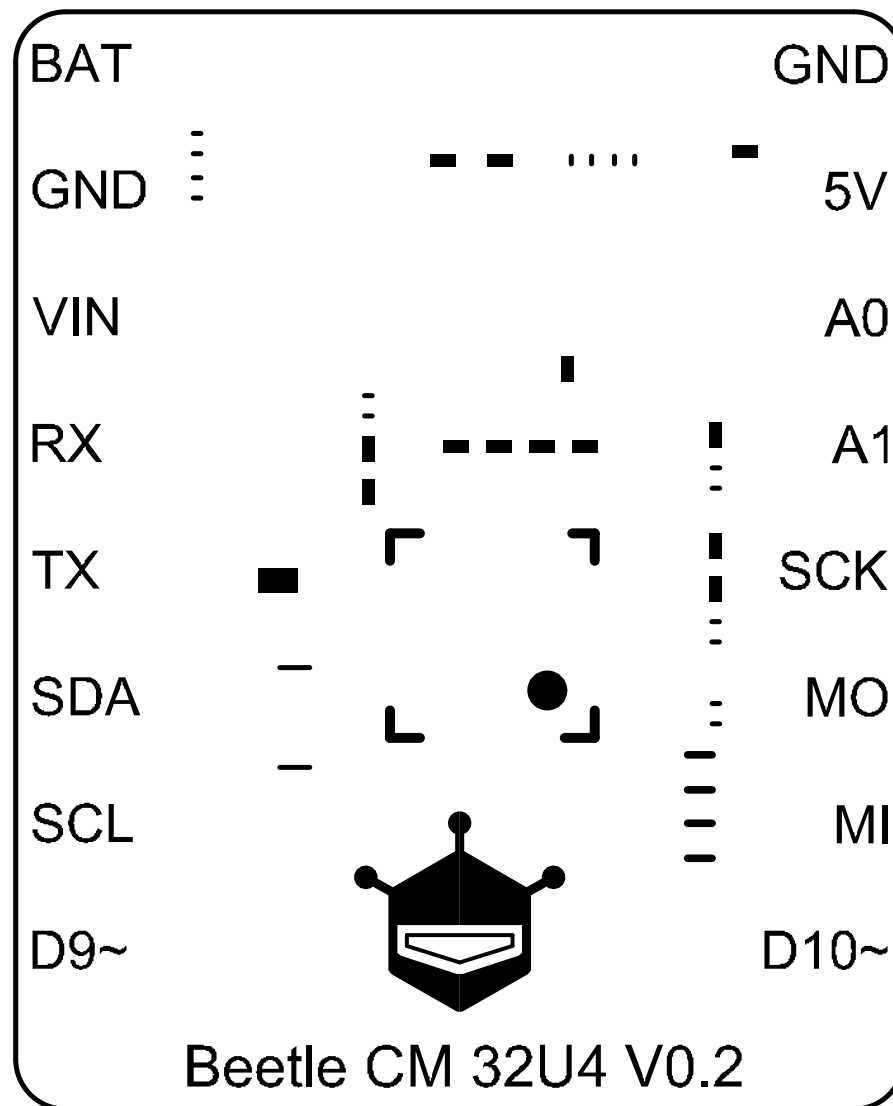

<b>PCB Information</b>	Name:DFR0816[V0.2]	Thickness: 1.0mm
Engineer:lfwag_CD	Top SolderMask: Black	Bottom SolderMask: Black
Date:20210531	Top Silkscreen: White	Bottom Silkscreen: White

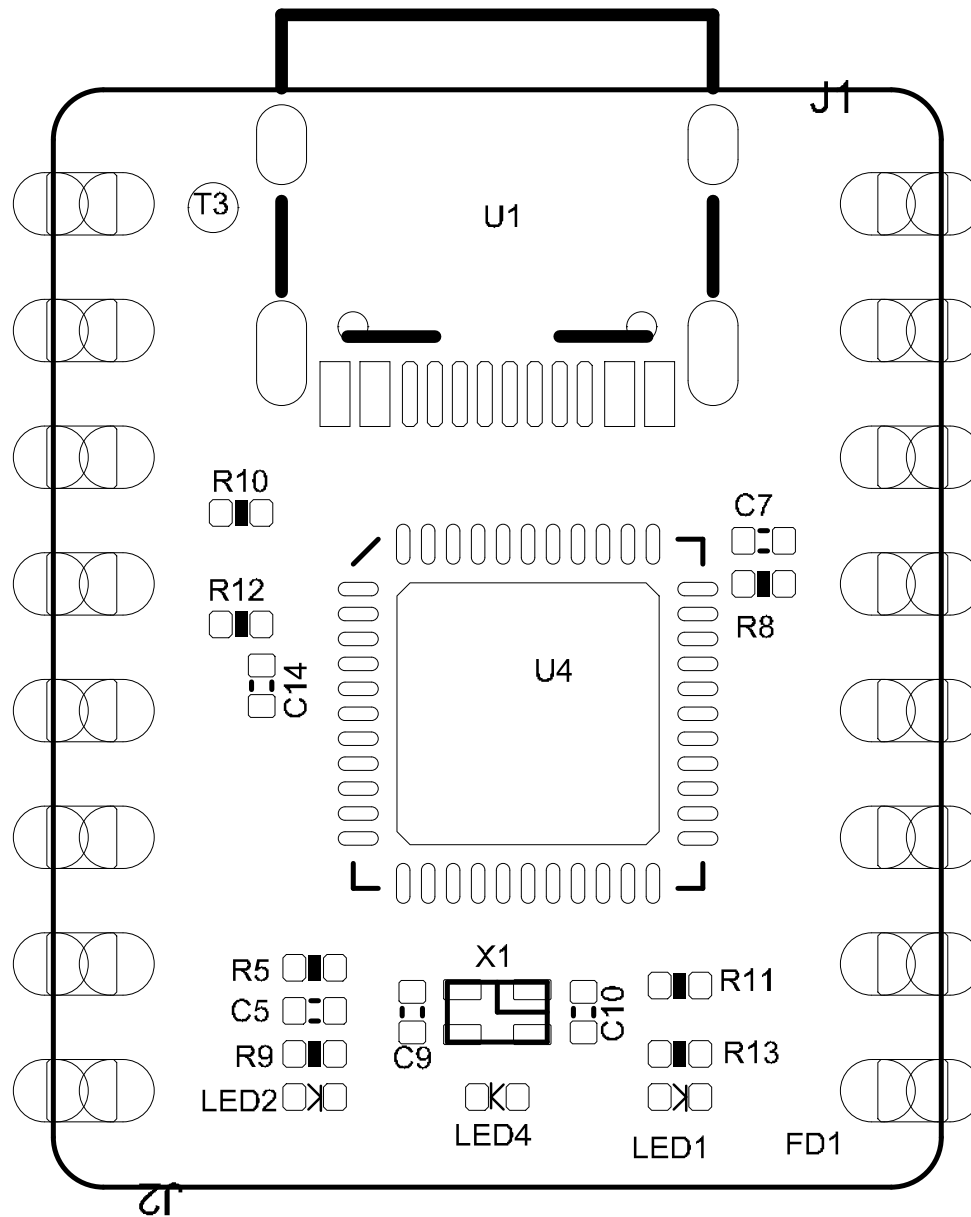

<b>PCB Information</b>	Name:DFR0816[V0.2]	Thickness: 1.0mm
Engineer:lfwag_CD	Top SolderMask: Black	Bottom SolderMask: Black
Date:20210531	Top Silkscreen: White	Bottom Silkscreen: White

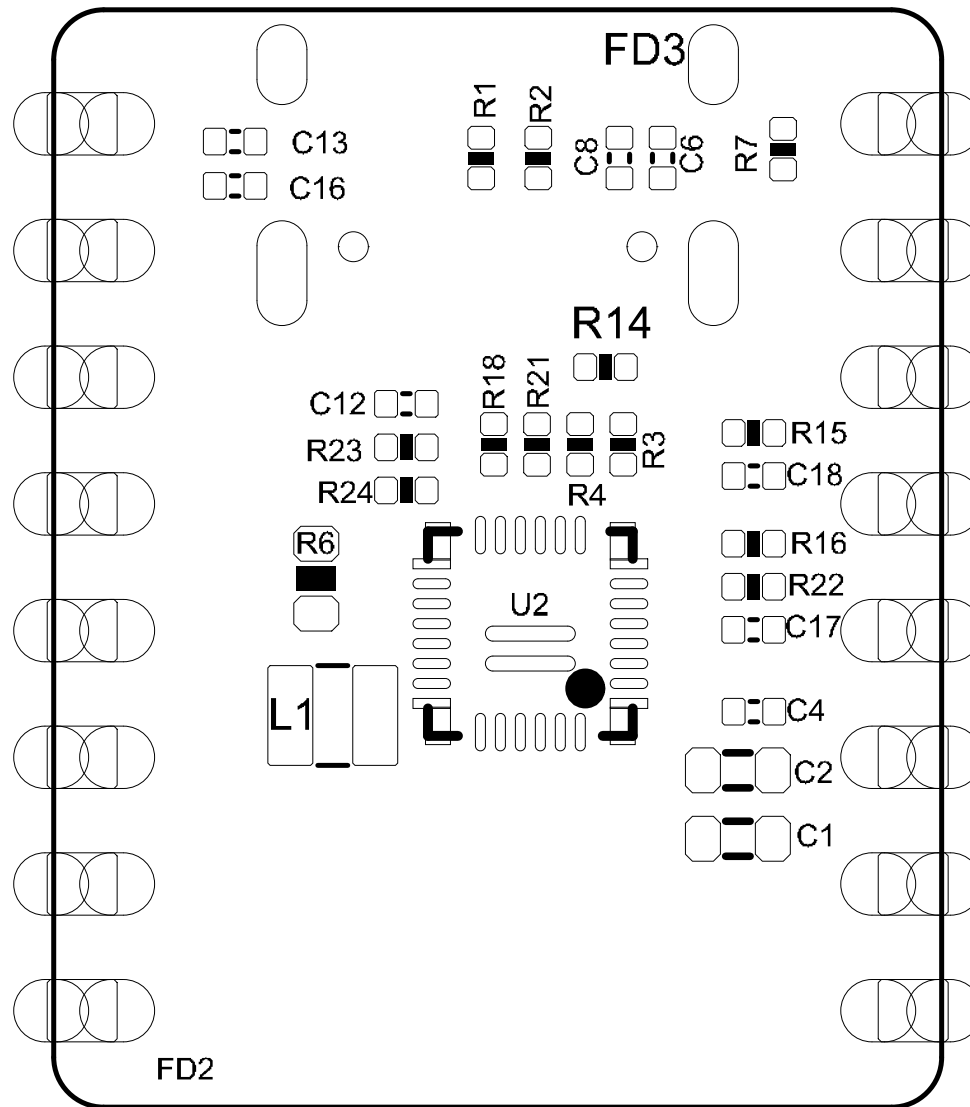

<b>PCB Information</b>	Name:DFR0816[V0.2]	Thickness: 1.0mm
Engineer:lfwag_CD	Top SolderMask: Black	Bottom SolderMask: Black
Date:20210531	Top Silkscreen: White	Bottom Silkscreen: White

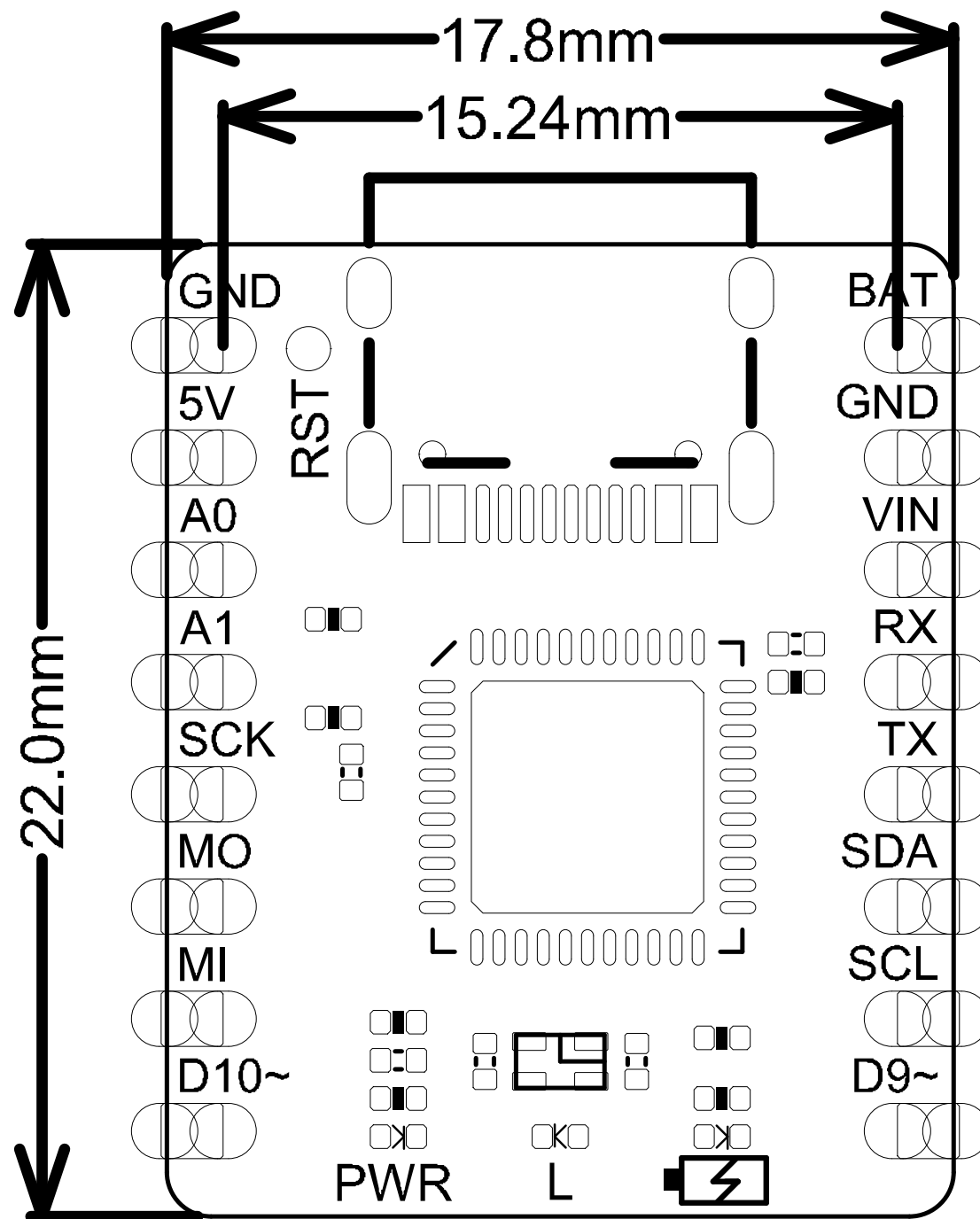

<b>PCB Information</b>	Name:DFR0816[V0.2]	Thickness: 1.0mm
Engineer:lfwag_CD	Top SolderMask: Black	Bottom SolderMask: Black
Date:20210531	Top Silkscreen: White	Bottom Silkscreen: White

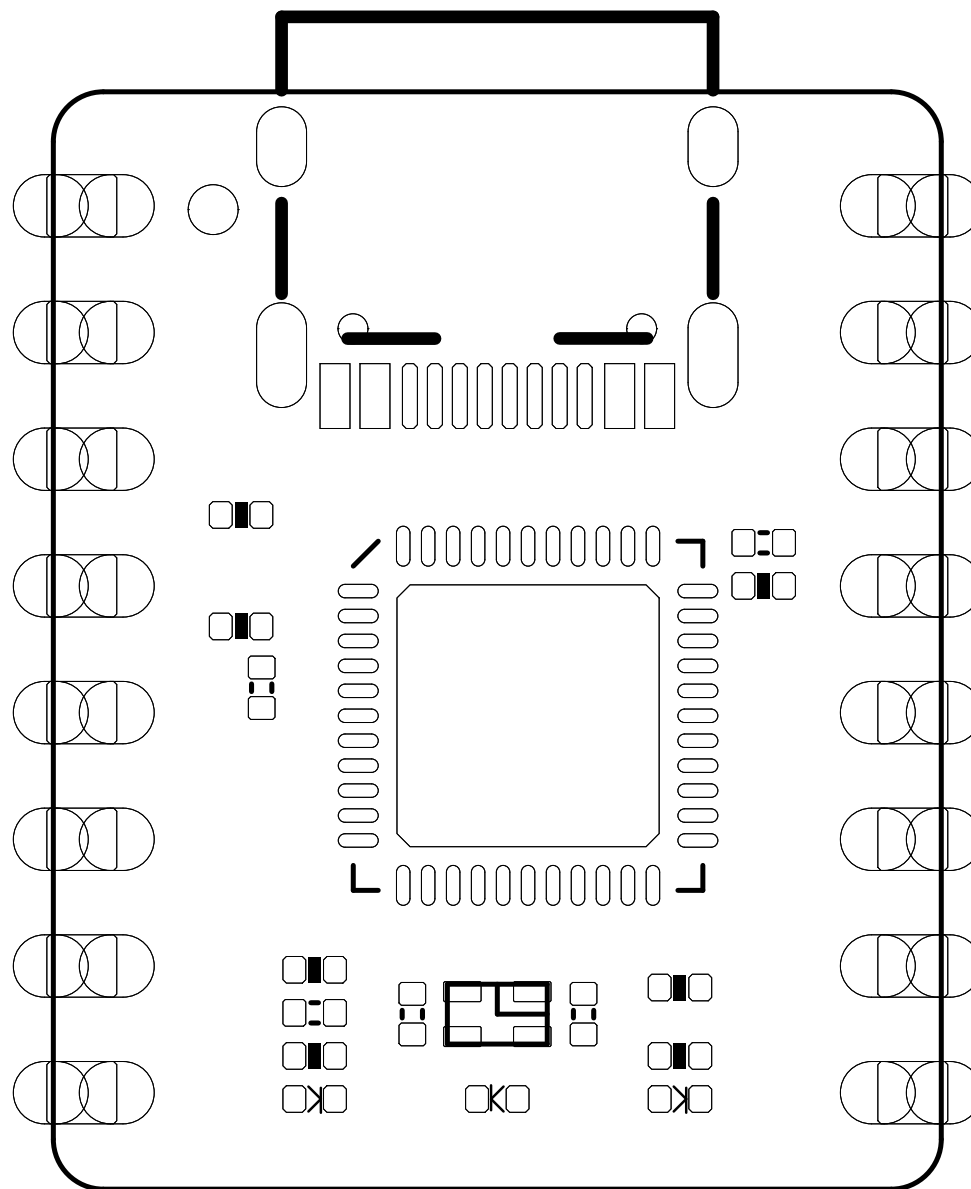

<b>PCB Information</b>	Name:DFR0816[V0.2]	Thickness: 1.0mm
Engineer:lfwag_CD	Top SolderMask: Black	Bottom SolderMask: Black
Date:20210531	Top Silkscreen: White	Bottom Silkscreen: White

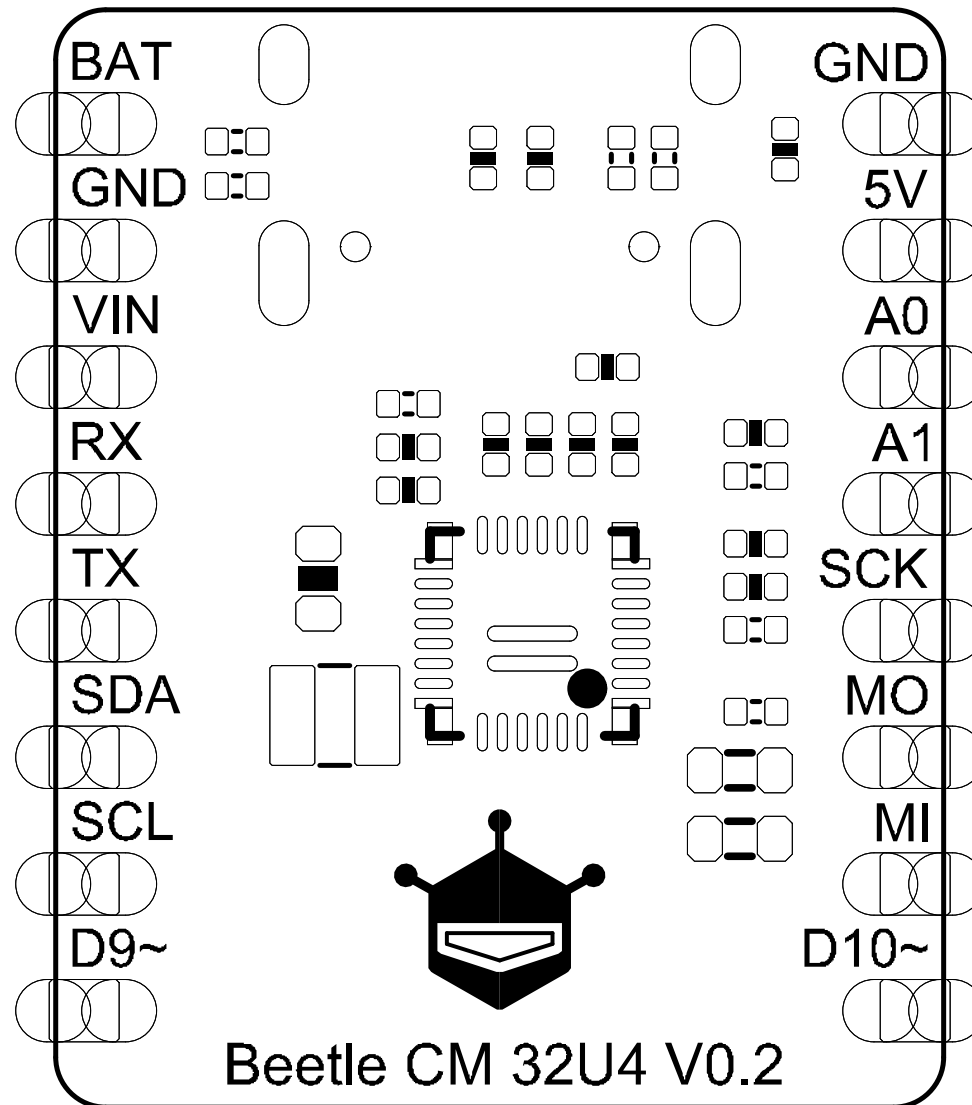

<b>PCB Information</b>	Name:DFR0816[V0.2]	Thickness: 1.0mm
Engineer:lfwag_CD	Top SolderMask: Black	Bottom SolderMask: Black
Date:20210531	Top Silkscreen: White	Bottom Silkscreen: White