

U1			
GPIO0	1	GPIO0	VBUS
GPIO1	2	GPIO1	VSYS
GND	3	GND	GND
GPIO2	4	GPIO2	3V3_EN
GPIO3	5	GPIO3	3V3
GPIO4	6	GPIO4	ADC_VREF
SDIO_CLK	7	GPIO5	IO28/ADC2
GND	8	GND	AGND
GPIO6	9	GPIO6	IO27/ADC1
GPIO7	10	GPIO7	IO26/ADC0
LCD_DC	11	GPIO8	RUN
LCD_CS	12	GPIO9	GPIO22
GND	13	GND	GND
CLK	14	GPIO10	GPIO21
MOSI	15	GPIO11	GPIO20
MISO	16	GPIO12	GPIO19
LCD_BL	17	GPIO13	GPIO18
GND	18	GND	GND
GPIO14	19	GPIO14	GPIO17
RESET	20	GPIO15	GPIO16
		40	VBUS
		39	VSYS
		38	GND
		37	3V3_EN
		36	Pico3V3
		35	P35
		34	GPIO28
		33	GND
		32	GPIO27
		31	GPIO26
		30	RUN
		29	SDIO D3/SD CS
		28	GND
		27	SDIO D2
		26	SDIO D1
		25	SDIO D0
		24	SDIO_CMD
		23	GND
		22	TP_IRQ
		21	TP_CS

Pi pico (40P)

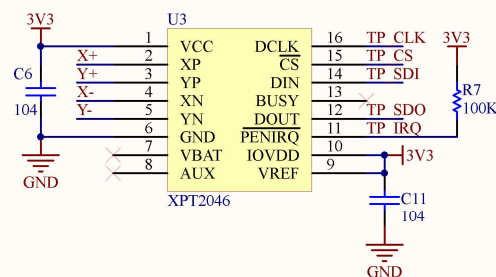

Pico-ResTouch-LCD-2.8



H5 Identification

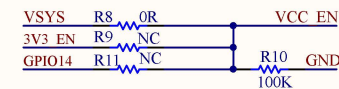
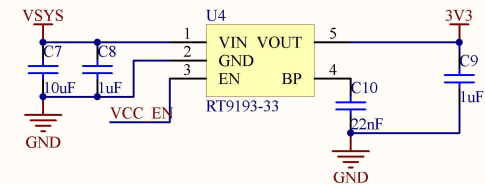
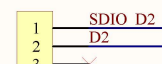
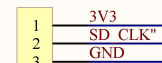
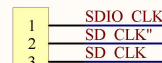
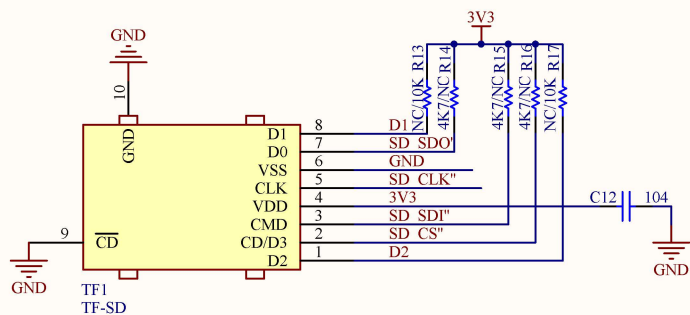
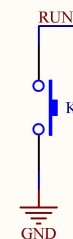

Pico3V3

