

Title: Gravity: PAJ7620U2 Gesture Sensor	SKU: SEN0315
Drawn: HDJ	Revision: V1.0
Page: 1/1	Date: 2019/9/5/周四
	Time: 17:05:57

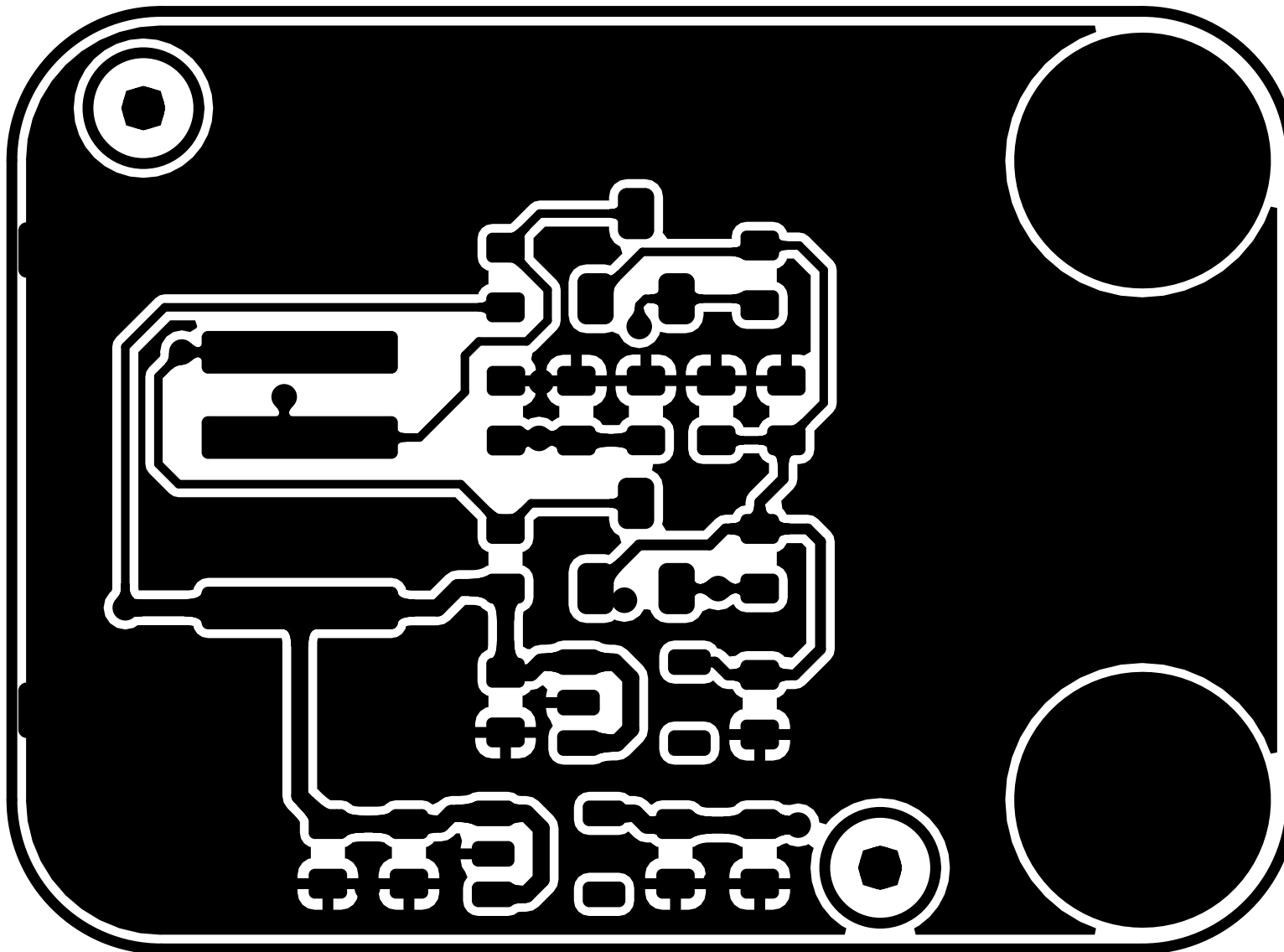

PCB Information	Name: SEND315[V1.0]	Thickness: 1.0mm
Engineer: HDJ	Top SolderMask: Black	Bottom SolderMask: Black
Date: 20190905	Top Silkscreen: White	Bottom Silkscreen: White

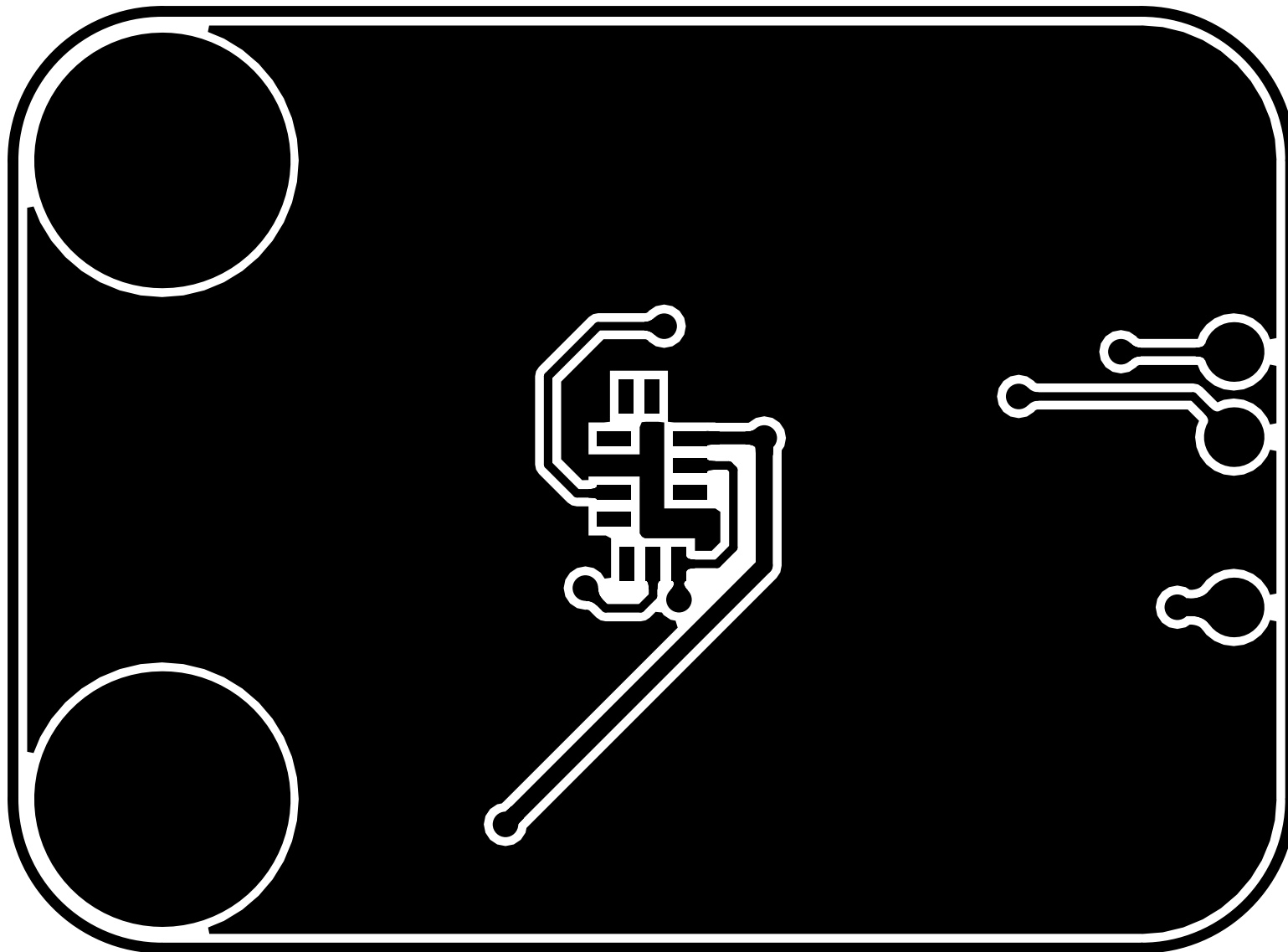

PCB Information	Name: SEND315[V1.0]	Thickness: 1.0mm
Engineer: HDJ	Top SolderMask: Black	Bottom SolderMask: Black
Date: 20190905	Top Silkscreen: White	Bottom Silkscreen: White

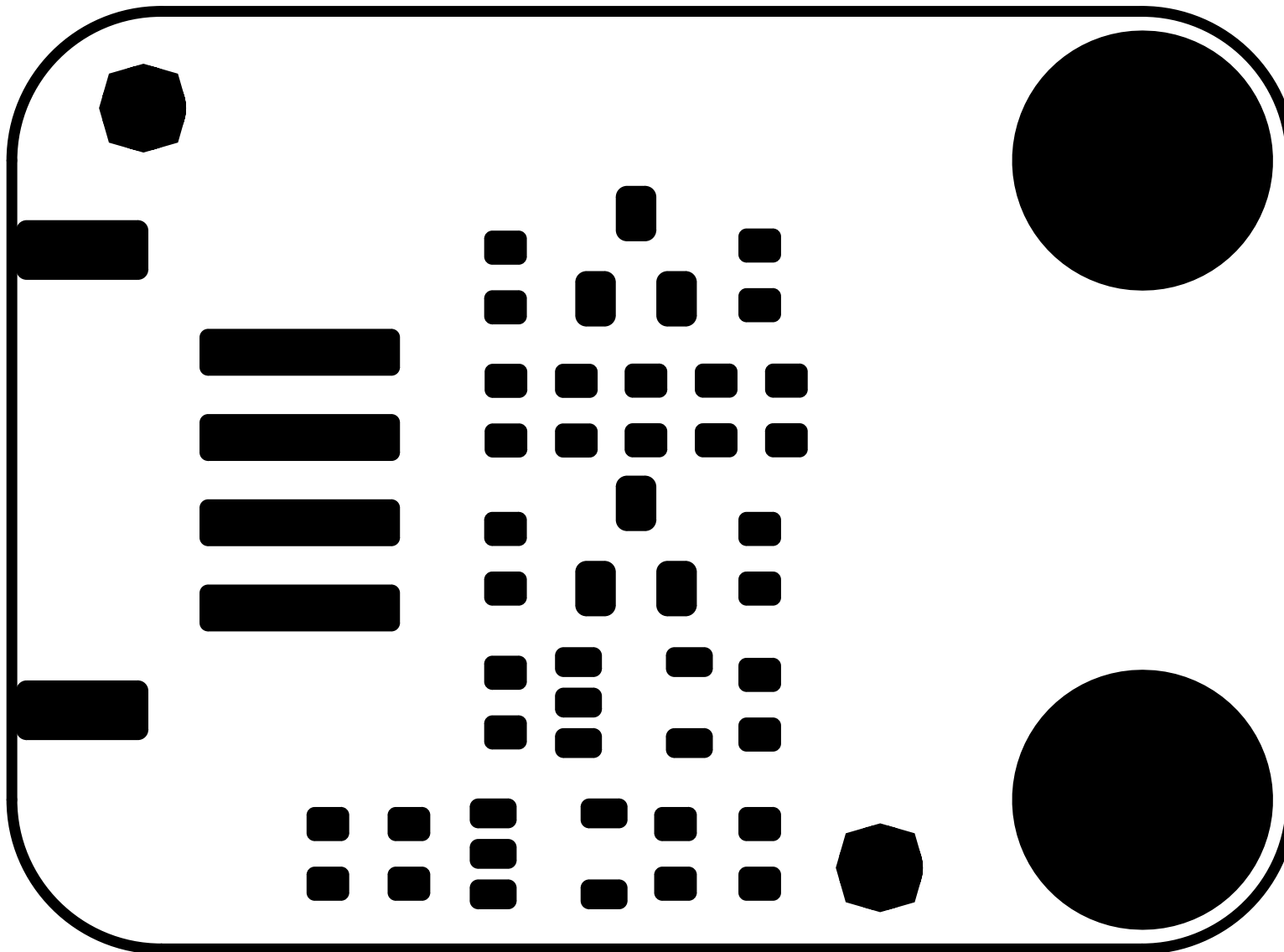

PCB Information	Name:SEND315[V1.0]	Thickness: 1.0mm
Engineer: HDJ	Top SolderMask: Black	Bottom SolderMask: Black
Date: 20190905	Top Silkscreen: White	Bottom Silkscreen: White

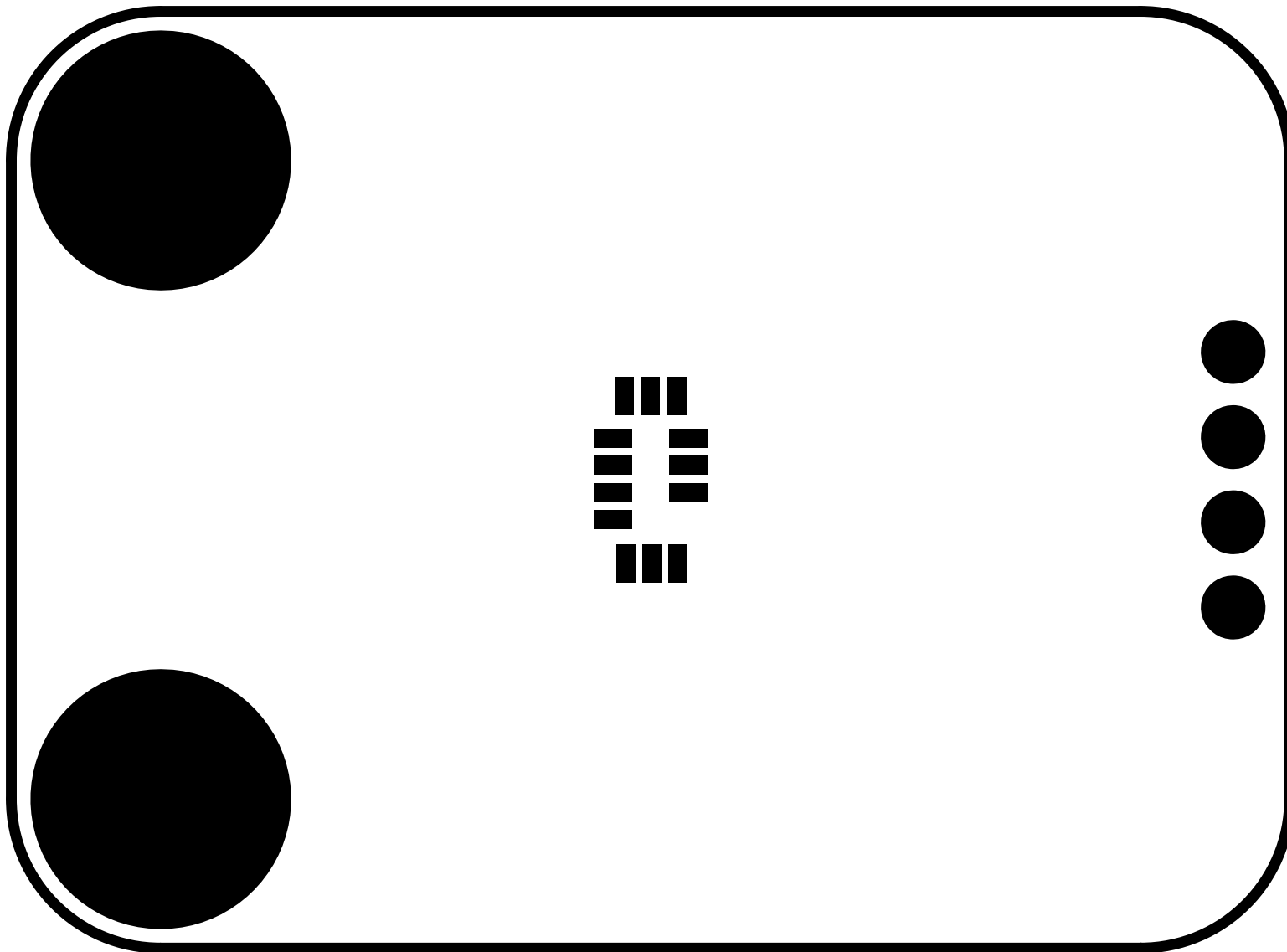

PCB Information	Name: SEND315[V1.0]	Thickness: 1.0mm
Engineer: HDJ	Top SolderMask: Black	Bottom SolderMask: Black
Date: 20190905	Top Silkscreen: White	Bottom Silkscreen: White

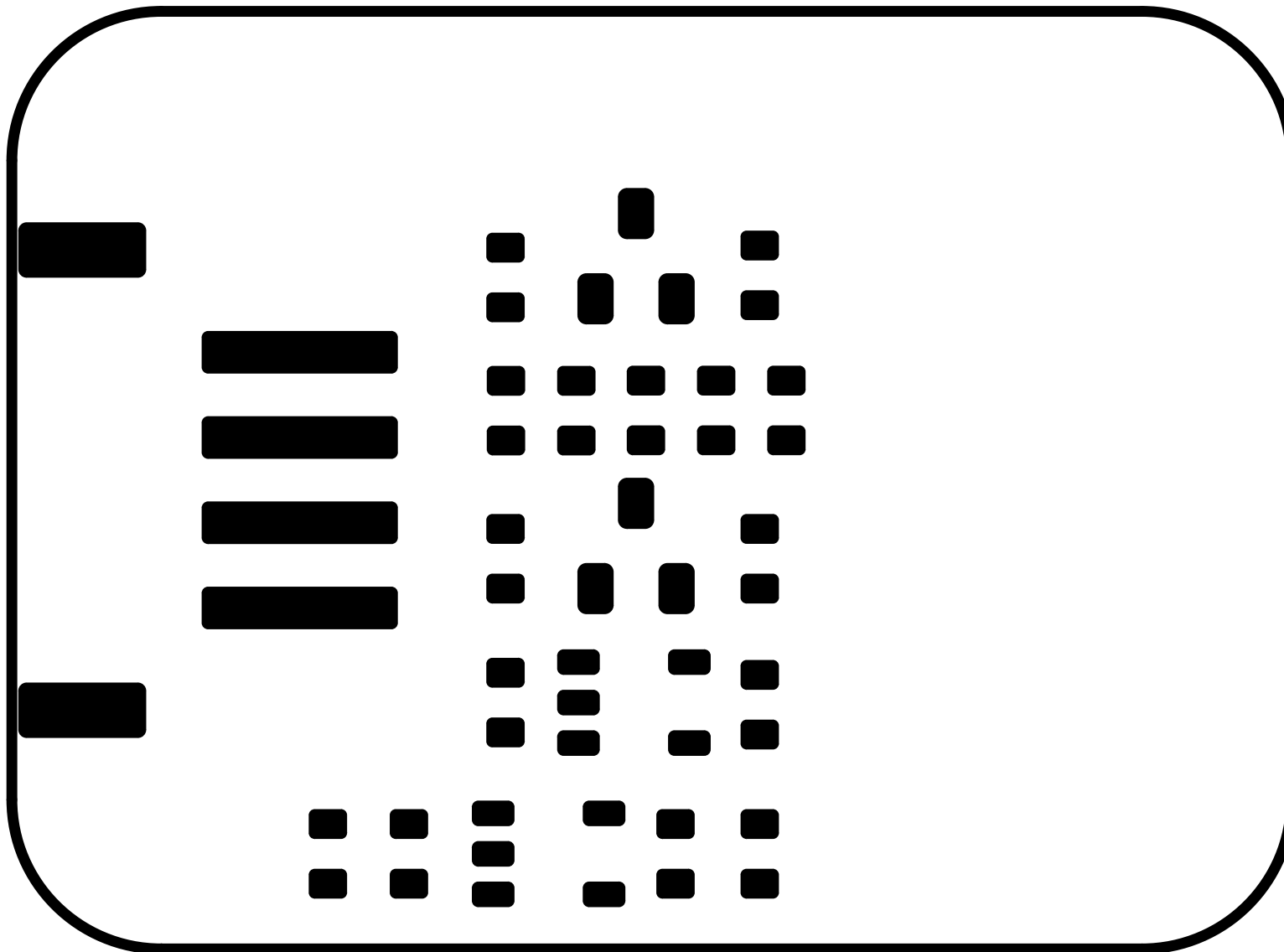

PCB Information	Name: SEND315[V1.0]	Thickness: 1.0mm
Engineer: HDJ	Top SolderMask: Black	Bottom SolderMask: Black
Date: 20190905	Top Silkscreen: White	Bottom Silkscreen: White

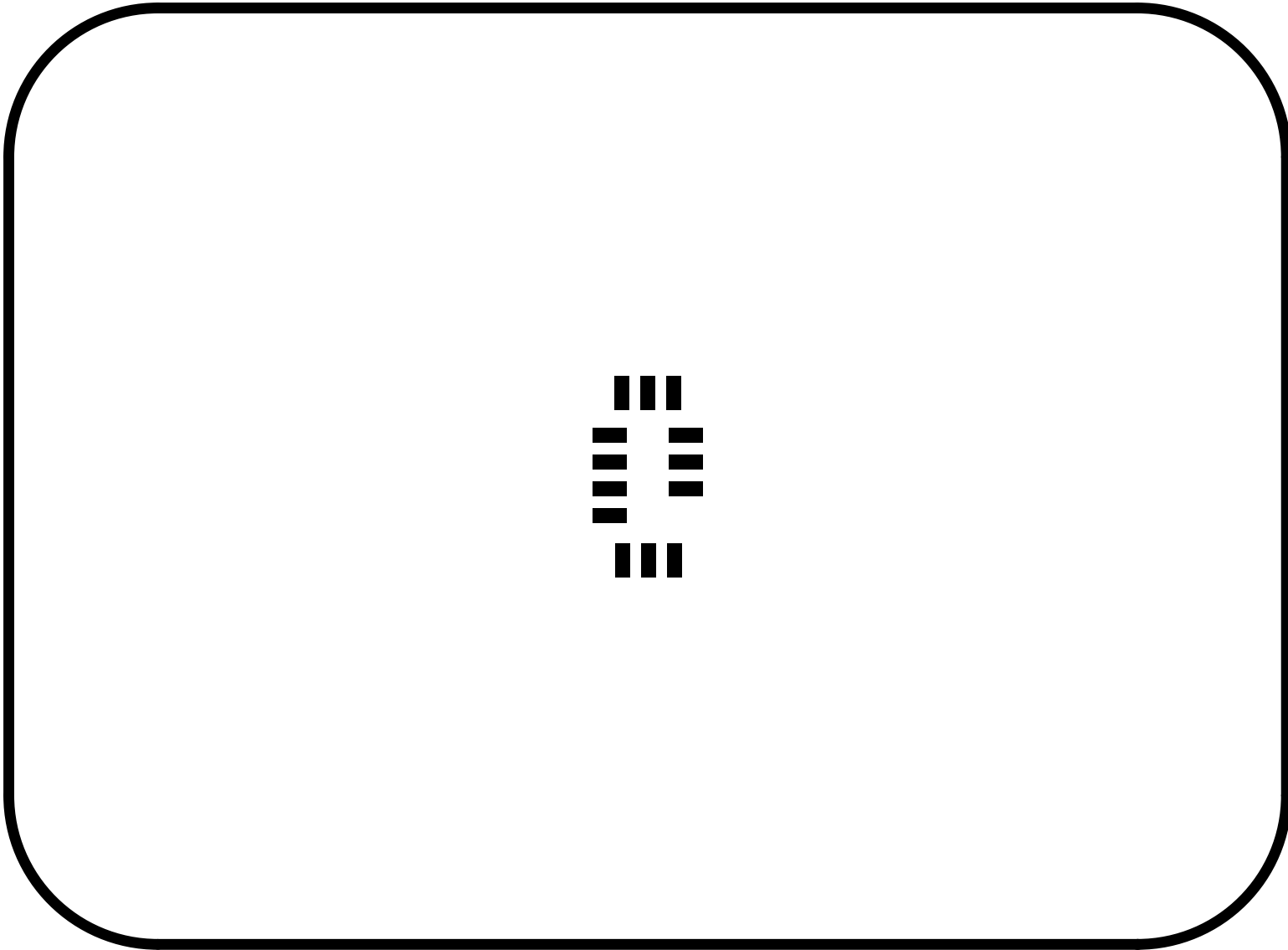

PCB Information	Name: SEND315[V1.0]	Thickness: 1.0mm
Engineer: HDJ	Top SolderMask: Black	Bottom SolderMask: Black
Date: 20190905	Top Silkscreen: White	Bottom Silkscreen: White

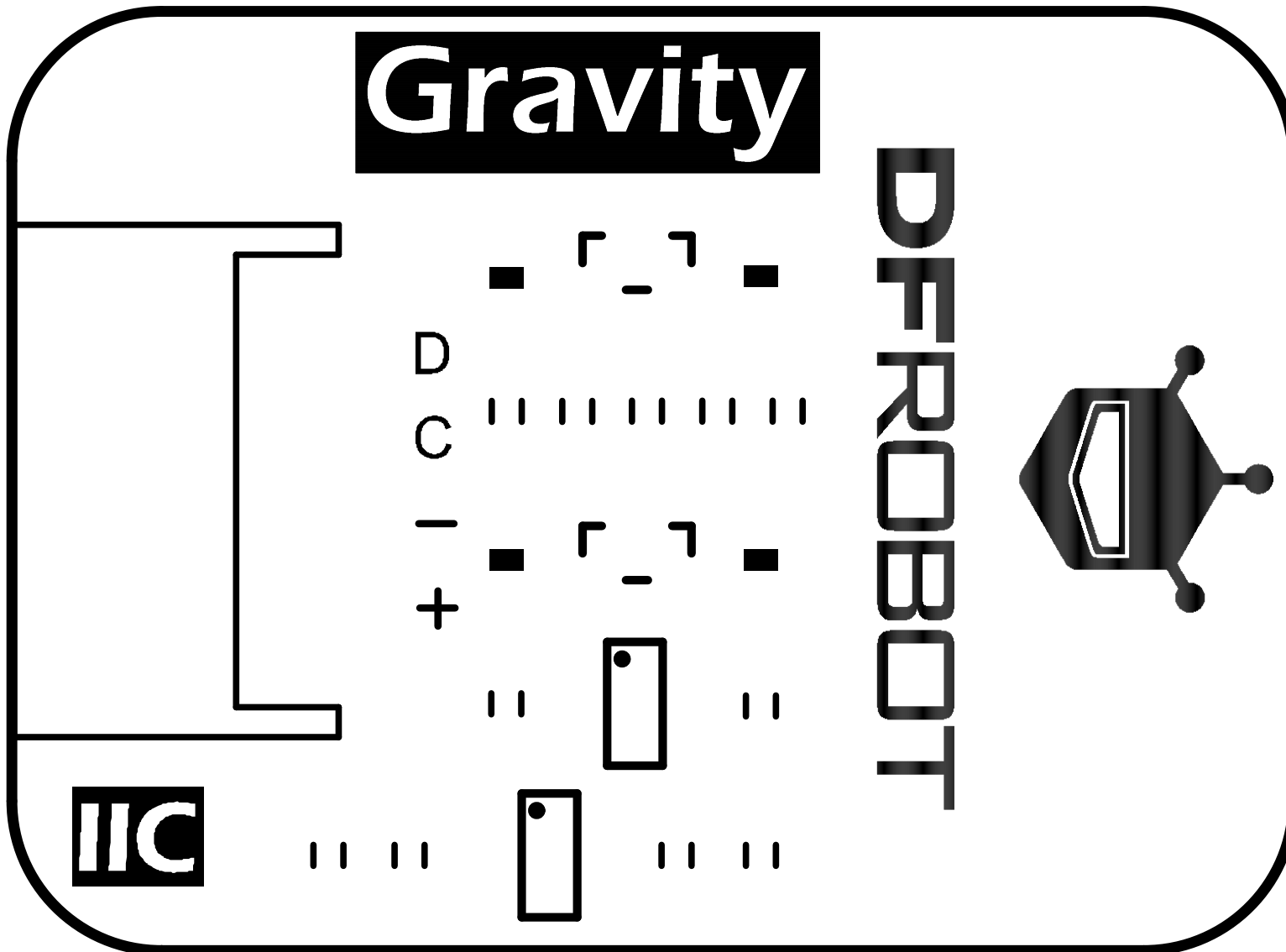

PCB Information	Name: SEND315[V1.0]	Thickness: 1.0mm
Engineer: HDJ	Top SolderMask: Black	Bottom SolderMask: Black
Date: 20190905	Top Silkscreen: White	Bottom Silkscreen: White

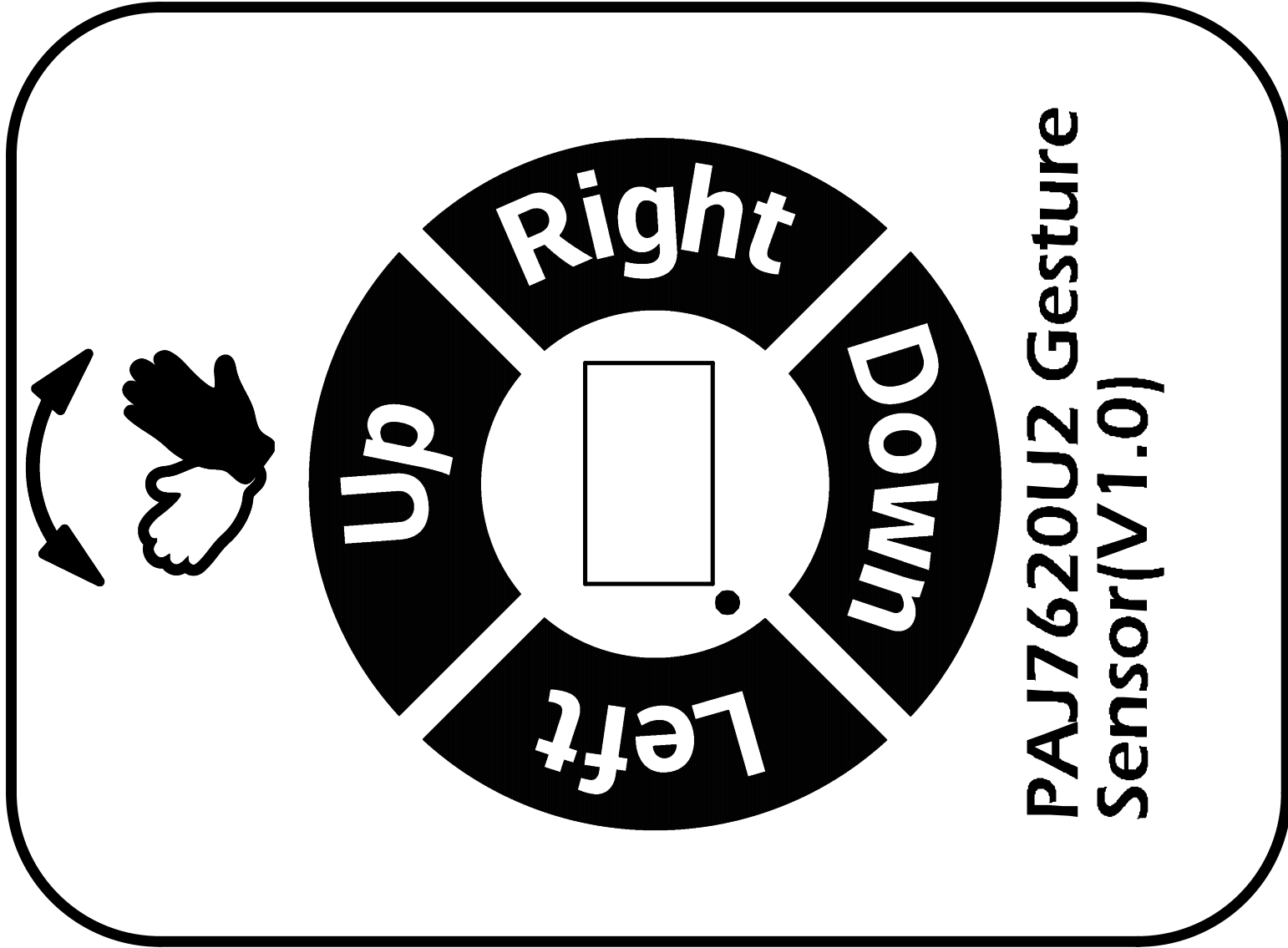

PCB Information	Name: SEND315[V1.0]	Thickness: 1.0mm
Engineer: HDJ	Top SolderMask: Black	Bottom SolderMask: Black
Date: 20190905	Top Silkscreen: White	Bottom Silkscreen: White

Gravity

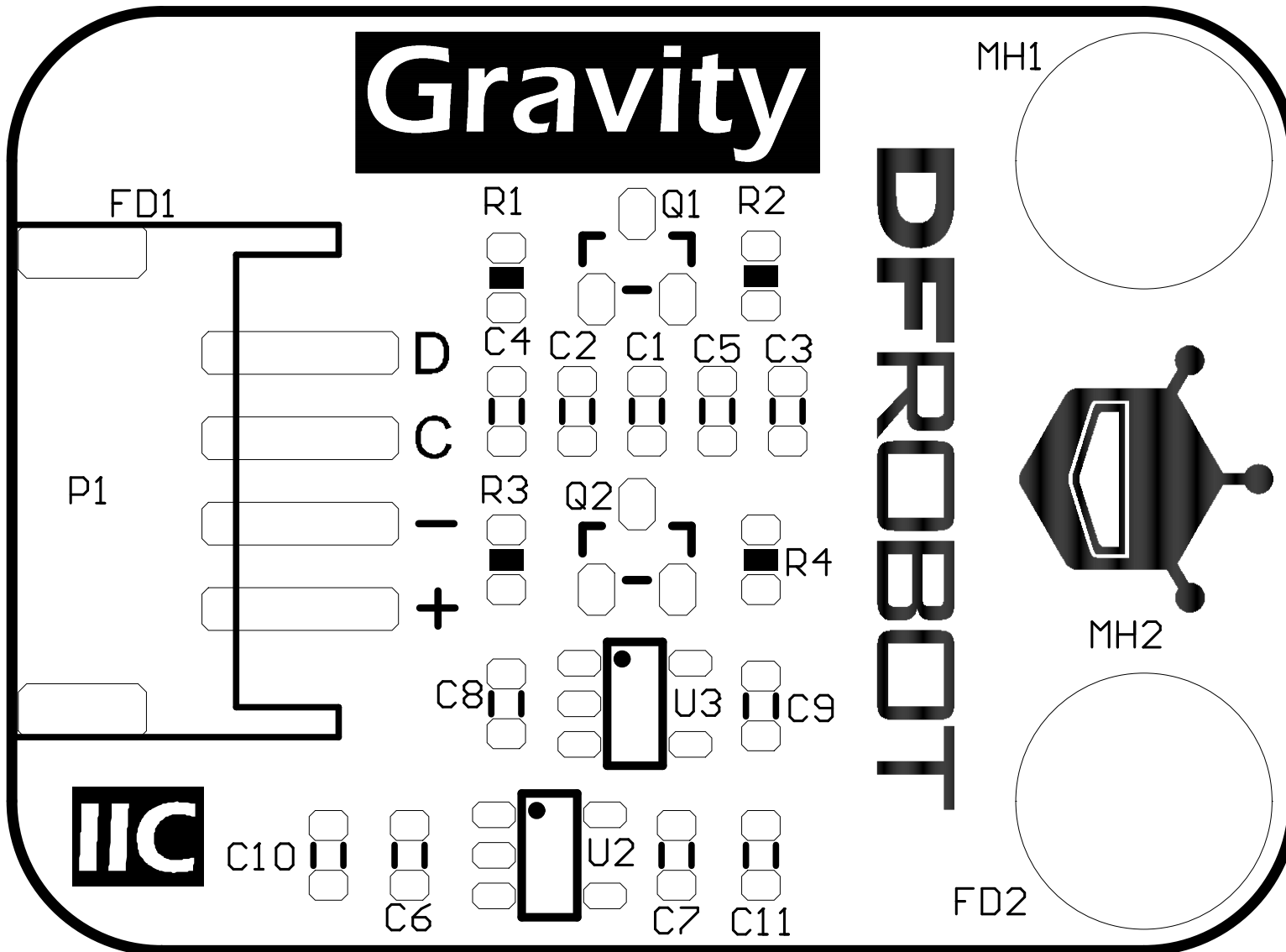

PCB Information	Name: SEND315[V1.0]	Thickness: 1.0mm
Engineer: HDJ	Top SolderMask: Black	Bottom SolderMask: Black
Date: 20190905	Top Silkscreen: White	Bottom Silkscreen: White

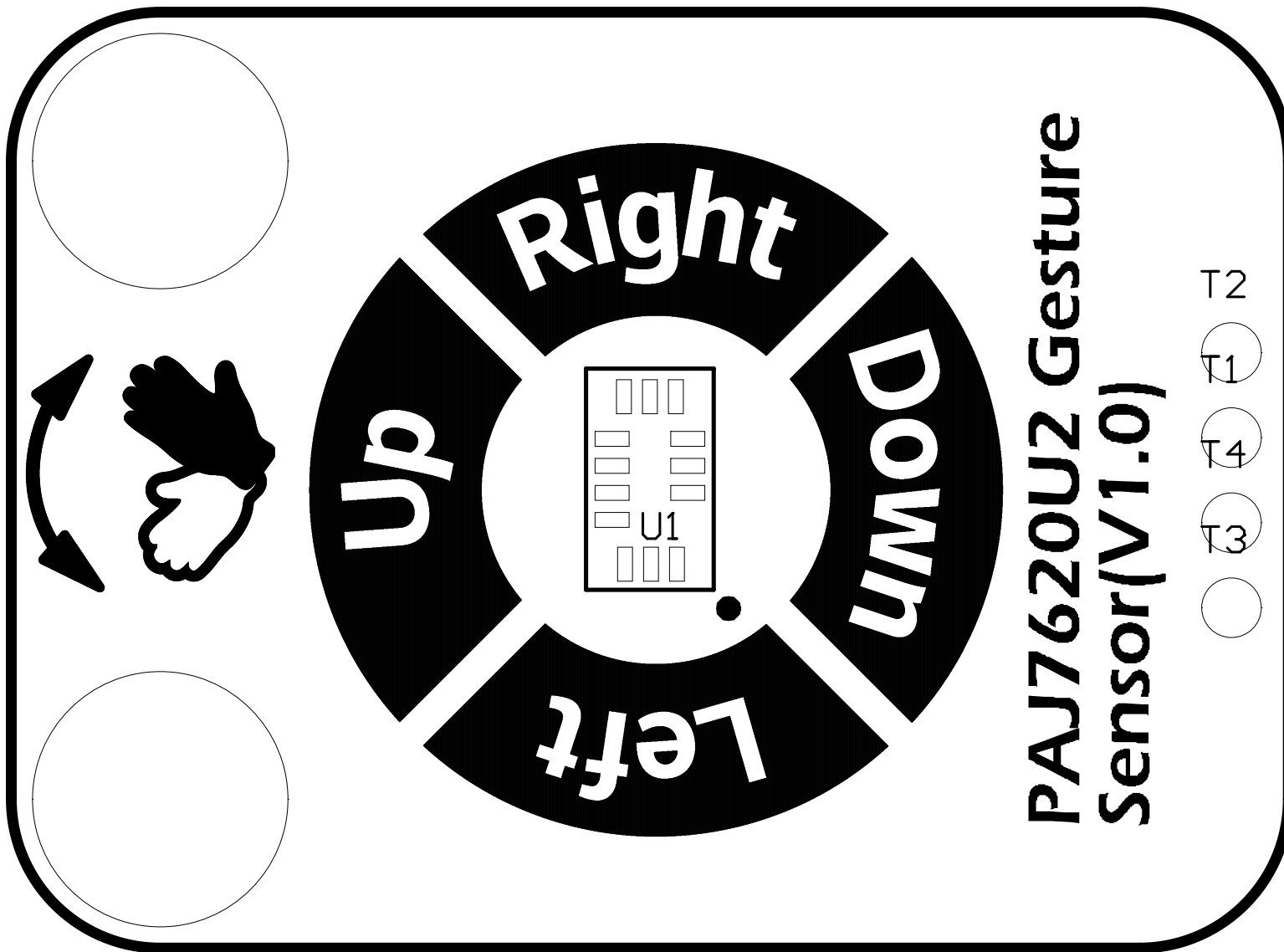

PCB Information	Name: SEND315[V1.0]	Thickness: 1.0mm
Engineer: HDJ	Top SolderMask: Black	Bottom SolderMask: Black
Date: 20190905	Top Silkscreen: White	Bottom Silkscreen: White

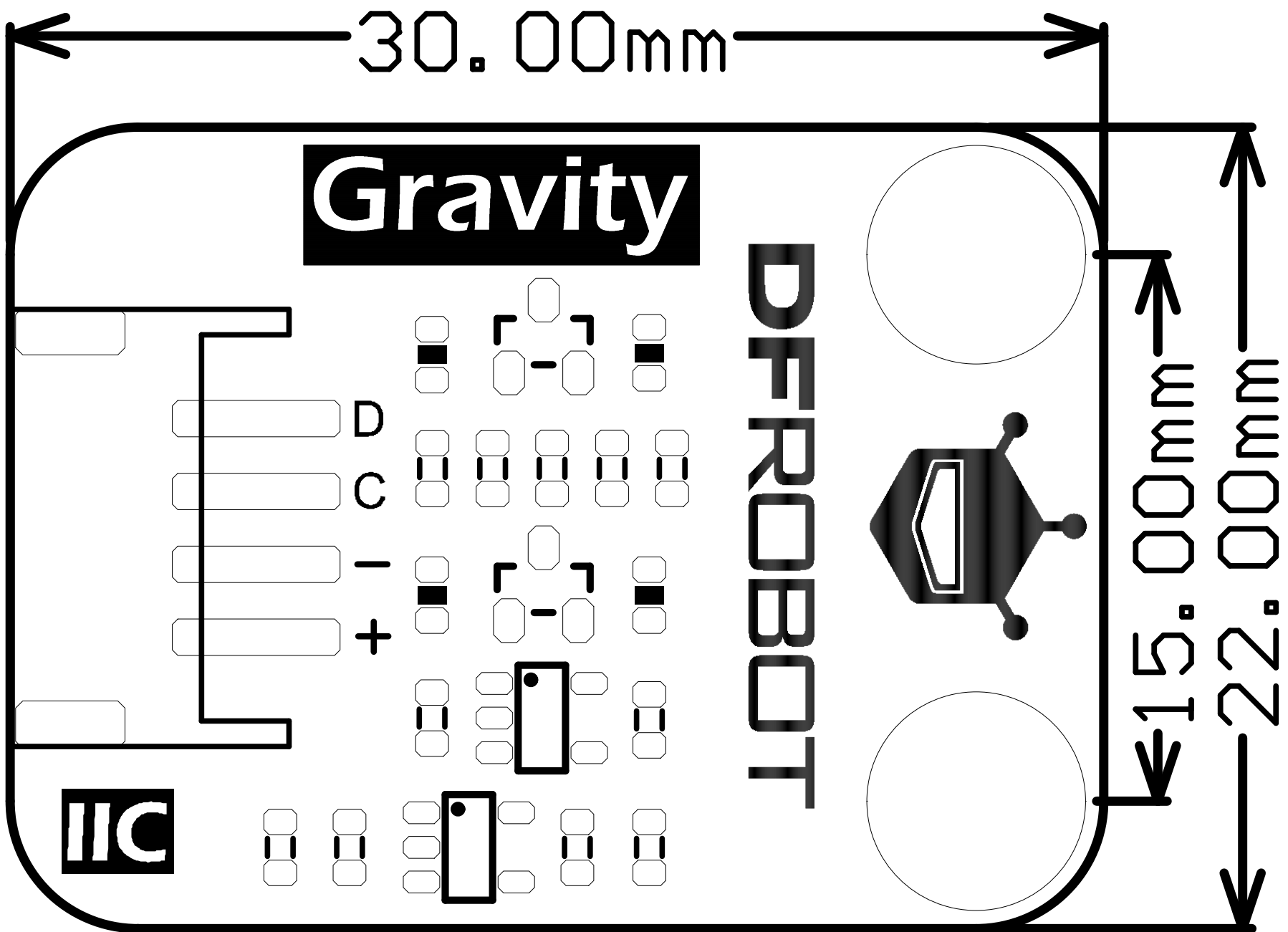

PCB Information	Name: SEND315[V1.0]	Thickness: 1.0mm
Engineer: HDJ	Top SolderMask: Black	Bottom SolderMask: Black
Date: 20190905	Top Silkscreen: White	Bottom Silkscreen: White

Gravity

DFROBOT

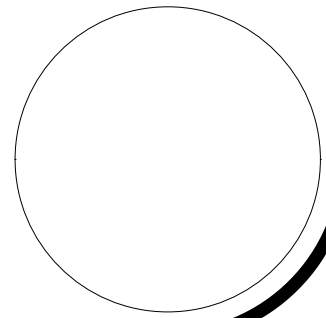
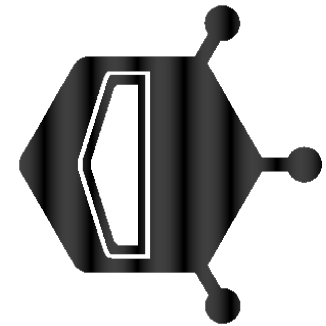
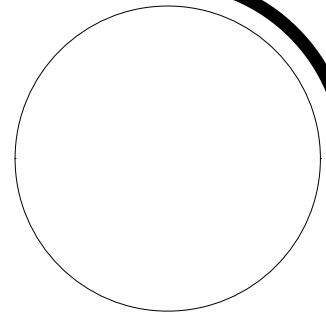

IIC

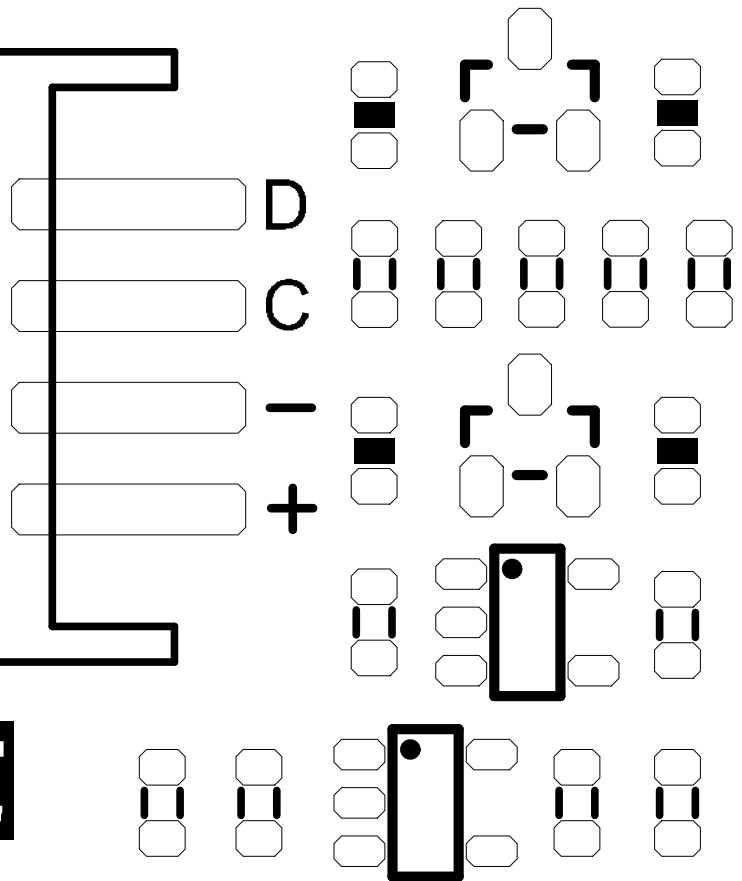

PCB Information	Name: SEND315[V1.0]	Thickness: 1.0mm
Engineer: HDJ	Top SolderMask: Black	Bottom SolderMask: Black
Date: 20190905	Top Silkscreen: White	Bottom Silkscreen: White

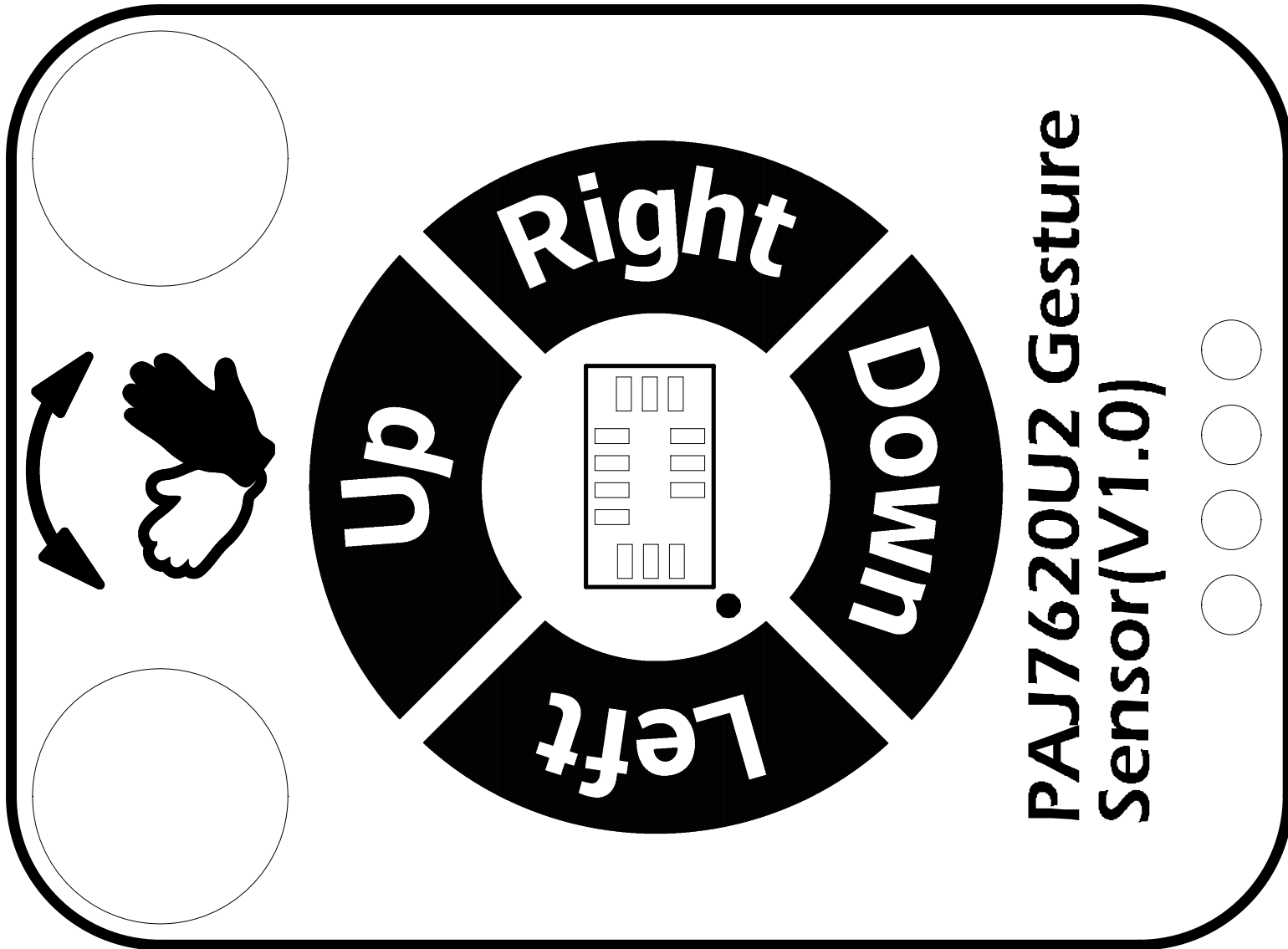

PCB Information	Name: SEND315[V1.0]	Thickness: 1.0mm
Engineer: HDJ	Top SolderMask: Black	Bottom SolderMask: Black
Date: 20190905	Top Silkscreen: White	Bottom Silkscreen: White