

BLACK 黑



UNI-T®



UTG2000A OPERATING MANUAL

Function/Arbitrary
Waveform Generator

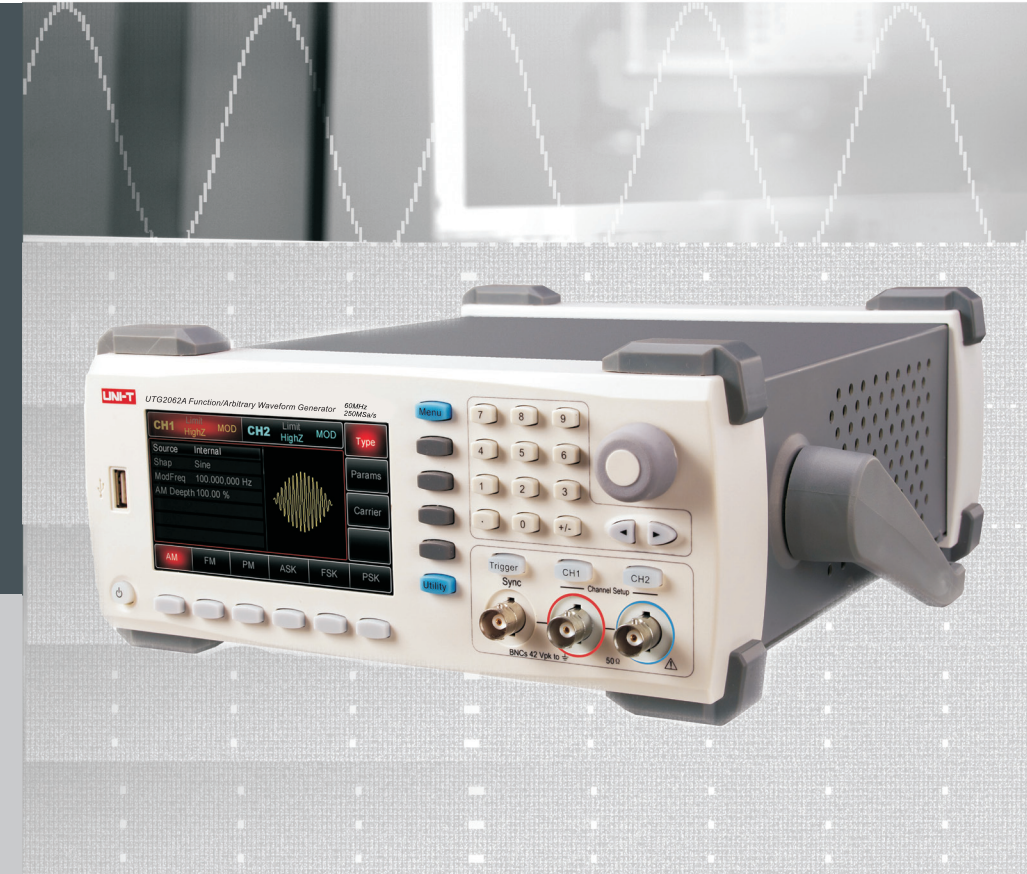

PN: 110401104725X
MAY.2018 REV. 4

Introduction

Dear users:

Thank you for purchasing UNI-T product. To operate the instrument correctly, please read this Operating Manual carefully and especially its “Safety Notice” before use.

Afer reading it, you are suggested to keep the manual properly. Please keep it with the instrument together or place it in an accessible location for future use.

Contents

Item	Page
Table of Contents	
Chapter 1 Safety Information	1
Safety Terms and Symbols.....	1
Safety Overview.....	2
Chapter 2 Introduction to UTG2000A	4
Key Features.....	4
Panels and Keypad	5
FrontPanel.....	5
Rear Panel.....	10
Displa Interface.....	12
Chapter 3 Quick Start	16
General Check.....	16
Checking for Any Damage in Transit.....	16
Checking the Accessories.....	16
Checking the Whole Instrument	16
Adjusting the Carrying Handle	17
Outputting Basic Waveforms	18

UTG2000A user manual

Item	Page
Setting Output Frequency.....	18
Setting Output Amplitude.....	19
Setting DC Offset Voltage.....	20
Setting the Squarewave	21
Setting the Pulse Waveform.....	21
Setting DC Volts.....	23
Setting the Ramp Waveform.....	24
Setting the Noise Waveform.....	24
Frequency Measurement.....	25
Using Built-in Help System.....	26
Chapter 4 Advanced Applications.....	27
Outputting Modulated Waveforms	27
Amplitude Modulation	27
Frequency Modulation(FM).....	36
Phase Modulation (PM)	44
Amplitude-Shift Keying(ASK) Modulation	51
Frequency-Shift Keying(FSK)Modulation.....	57

Item	Page
Phase-Shift Keying(PSK) Modulation.....	64
Pulse Width Modulation(PWM)	71
Outputting Frequency Sweep Waveforms	79
Selecting Frequency Sweep.....	79
Start Frequency and Stop Frequency	80
Sweep Mode.....	81
Sweep Time.....	82
Trigger Source.....	82
Trigger Out.....	83
Trigger Edge.....	84
Applications.....	84
Outputting Burst Waveforms.....	88
Selecting Burst.....	88
Burst Type.....	89
Burst Phase.....	92
Burst Period.....	92
Burst Count.....	93
Trigger Source.....	93

UTG2062A user manual

Item	Page
Trigger Out.....	94
Trigger Edge.....	95
Applications.....	95
Outputting Arbitrary Waveforms.....	99
Enabling Arbitrary Waveform Function.....	100
Point-by-Point Output/Play Mode.....	100
Selecting Arbitrary Waveform.....	101
Creating and Editing Arbitrary Waveform.....	102
Chapter 5 Troubleshooting.....	103
No Display on the Screen(Blank Screen).....	103
No Waveform Output.....	103
Unable to Recognize U Flash Drive.....	104
Chapter 6 Service and Support.....	104
Updating the Instrument.....	104
Appendix A: Factory Default Settings.....	106
Appendix B: Technical Specifications.....	108
Appendix C: Accessories List.....	113
Appendix D: Maintenance.....	114

Chapter 1 Safety Information

Safety Terms and Symbols

Terms in the manual

Following terms may appear in this manual:

Warning: a Warning specifies conditions and actions that may pose hazards to the user.

Caution: a Caution identifies conditions and actions that may cause damage to the product or other properties.

Terms on the product

Following terms may show on the product:

DANGER indicates any injury hazard immediately accessible as you read the marking.

WARNING indicates any injury hazard not immediately accessible as you read the marking.

CAUTION indicates any damage may happen to the product or other properties

Symbols on the product

Following symbols may show on the product:

- ~ Alternating Current
- ⏏ Measuring Ground Terminal
- ⏏ Chassis Ground
- ⏏ On/Off Button
- ⚠ Risk of Electric Shock
- ⚠ Caution, refer to the manual
- ⏏ Protective Conductor Terminal
- CE CE is a registered trademark of European Community.
- CSA CSA is a registered trademark of CSA International.
-  C-tick is a registered trademark of Spectrum Management Agency of Australia. It states the compliance with Australian EMC Framework regulations under the terms of Audio Communication Act of 1992.

UTG2000A user manual

- Contains one or more of six hazardous substances over maximum concentration value (MCV) and 40 environment protection use period (EPUP)

1SM1-A This text shows the instrument is an “Industrial Science and Medical Group 1 Class A Product” (CISPER11, Clause 4)

ICES/NMB-001 This text signifies the instrument complies with Canadian Interference-Causing Equipment Standard (ICES-001).

Safety Overview

The Generator is strictly designed and manufactured as per safety/compliances: GB4793 safety requirements for electronic measuring instruments, IEC61010-1, Overvoltage CAT II 1000V and Pollution Degree II.

Please read through safety precautions before use:

- Use only the power cable and power adaptor specified for the Generator and certified by the country of use.
- The product is grounded through protective grounding conductor of power cable. To avoid electric shock, grounding conductor must be connected to the earth. Please make sure the product is properly grounded before make connections to its input or output terminal.
- Use the product as specified to prevent any potential hazards, personal injury or any damage to the product or device connected to the product.
- To avoid fire or electric shock, please check all the rated values and markings on the product, and read the manual for details before making any connection to the product.
- Do not apply working voltage higher than rated values of the product

- ALL Front BNC Output Only
- Please check the accessories for any mechanical damage. Make the replacement if any damage is found.
- Use only the accessories supplied for the product, do not use them if any damage is found.
- Do not plug any metal object into the input or output connectors of the product.
- Please have it checked by qualified servicing staff if you doubt the product does not work normally.
- Do not operate without covers open.
- Do not operate in damp environment.
- Do not operate in flammable or explosive environment.
- Keep the product surface clean and dry.

Chapter 2 Introduction to UTG2000A Series Function / Arbitrary Waveform Generator

UTG2000A Series Function/Arbitrary Waveform Generator adopts DDS technique into its design and is capable of generating accurate and stable waveforms with the resolution down to 1 μ Hz. It is a type of function/arbitrary waveform generator with high performance-price ratio and multiple functions integrated just into one instrument. The output is accurate, stable and pure with minimum distortion. The squarewave offered is high in frequency and has a very fast rising and falling edges. Superb technical specifications, easy-to-use operating panel and humanized graphic display are all perfectly combined into UTG2000A model, making it possible to get your work done faster and more efficiently, and it is a

versatile solution for your needs at present and in the future.

Key Features

- 60MHz (or 25MHz) sinewave output, down to 1 μ Hz resolution for full frequency range.
- 25MHz (or 5MHz) pulse waveform with adjustable rise & fall time and duty cycle
- 250MSa/s (or 125MSa/s) sample rate and 14-bit vertical resolution
- 6-digit high precision frequency meter that compatible with TTL level signal
- Standard dual channels with independent output mode
- 1M (or 8K) arbitrary waveform memory and 48 waveforms non-volatile storage.
- Multiple modulation types: AM, FM, PM, ASK, FSK, PSK, PWM.
- Powerful software available to use in PC.
- 4.3inch high-resolution TFT color display

- Standard interfaces: USB Host, USB Device, optional LAN
- Dual channels can be applied with at the same time or independently: internal/external modulation, internal/external/manual trigger
- Support frequency sweep and burst output
- Ease-of-use multipurpose knob and numeric keypad

Notes: UTG2025A is not equipped with LAN port.

Panels and Keypad

Front Panel

UTG2000A Series Function/Arbitray Waveform Generator offers a clear and intuitive front panel design to simplify users operations, See Figure 2-1 for details:

UTG2000A user manual

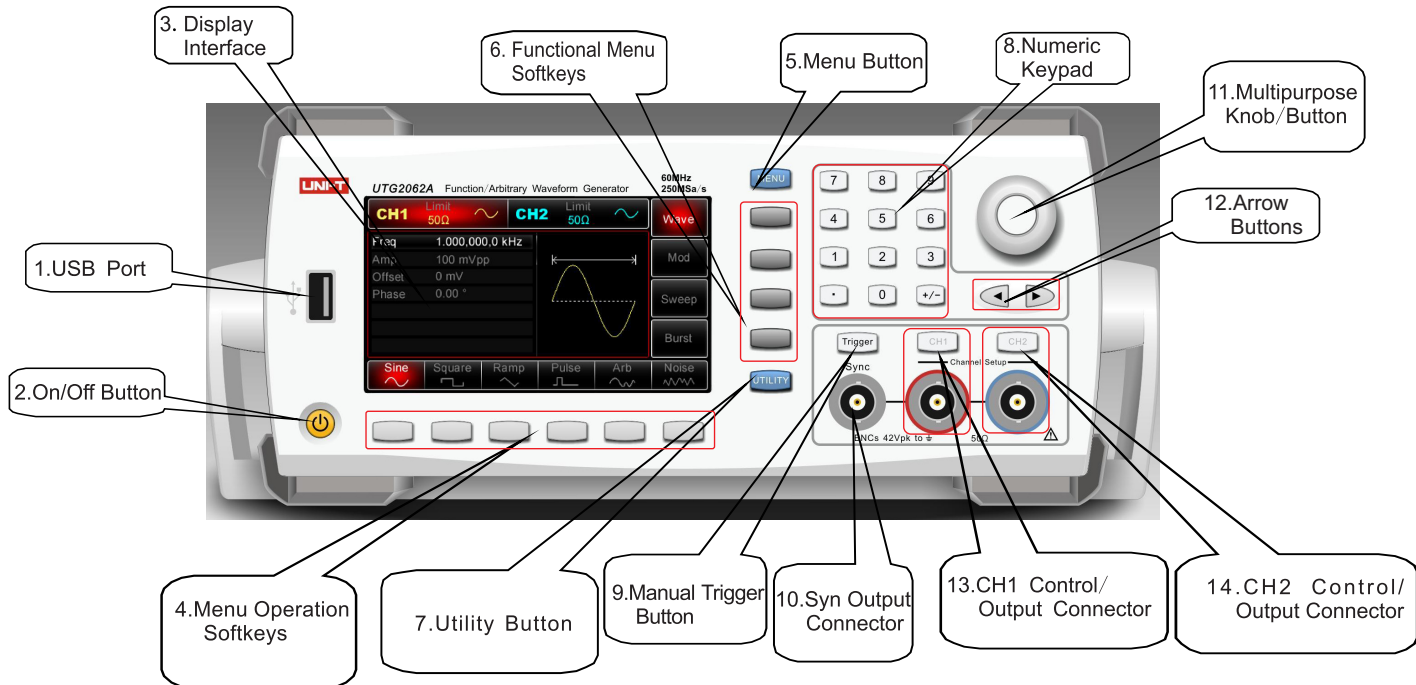

Figure 2-1

1. USB Port

The Generator supports U flash drive in FAT16 and FAT32 format. Through this USB port, the Generator can read any saved waveforms from USB flash drive or store current data into the flash drive.

2. On/Off Button

To power on /off the Generator. Press down, the button is illuminated (orange) and the Generator accesses power-on interface and then functional display. To avoid any shut-down caused by accidental pushing on the button, it is designed to be pressed down and held for 500ms so as to power off the Generator. The button backlight and display will turn off simultaneously after power-down.

Note: On/Off button can be effective only after the Generator has been energized normally and its master power switch on the rear panel is set to "I"

status. To disconnect AC power supply from the generator, you need to set the master power switch to "O" or unplug the power cord.

3. Display Interface

The Generator offers 4.3-inch high-resolution TFT color display and distinguishes output status, menus and other important informations between CH1 and CH2 using different colors, which make human-machine interaction much easier and gets your work done efficiently.

4. Menu Operation Softkeys

To select or check the option that corresponds to every softkey (at the bottom of display screen). They can work with numeric keypad or multipurpose knob or arrow buttons to set up a parameter.

5. Menu Button

Press it and four functional labels pop out: **Wave**, **Mod**, **Sweep** and **Burst**. To select one of these

UTG2000A user manual

functions, press functional menu softkey corresponding to every label.

6. Functional Menu Softkeys

To select function labels that correspond to the softkeys (on the right of display screen).

7. Utility Button

Pressing the button can access four function labels: **CH1Setting**, **CH2Setting**, **I/O (or Freq Meter)** and **System**, the highlighted label (central background in grey and characters in pure white) is followed by sub-labels on the bottom of display screen. These sub-labels can help you know more what the highlighted label is related to. Pressing the bottom softkeys that correspond to sub-labels can enter into specific setup or information, for instance: to set up channels (eg: set output impedance within 1Ω --10 kΩ or to high impedance), to specify voltage limit or configure syn output, language, power-on

parameters, backlight, DHCP (dynamic host configuration protocol) compatible interface, storage or recall, system information, help topic lists, etc.

8. Numeric Keypad

To enter parameter value using 0~9, decimal point “.”, and “+/-” buttons. The decimal point “.” can be used to switch quickly between units. Arrow buttons can backspace and clear the digit prior to current input.

9. Manual Trigger Button

To set up trigger. Manual trigger is enabled when the button backlight flashes.

10. Syn Output Connector

To output synchronous signals for all standard functions (except DC and noise) in a normal manner.

11. Multipurpose Knob/Button

To modify a number (clockwise increase) or used as arrow buttons. Pressing the knob can select functions or confirm the parameter that has been set.

12. Arrow Buttons

To scroll or clear the digit prior to the current input or move the cursor (to the right or left) when working with the multifunction knob to set up parameters.

13. CH1 Control/Output Connector

To quickly change the current channel displayed on the screen (When CH1 label is highlighted, CH1 is chosen currently and all displayed parameters are CH1-related and ready to be set up). If the current channel is CH1 (highlighted CH1 label), then you can press **CH1** button to turn on/off CH1 output, or press **Utility** to pop up **CH1 Setting** label and use the softkey to set CH1 settings. Under this status, **CH1** button is illuminated, current output mode

shows to the right of CH1 label (“wave”, or “Mod”, or “Sweep”, or “Burst” icon) and CH1 connector output is enabled. With CH1 button switched off, the button backlight turns off, “Off” icon shows to the right of CH1 label and CH1 connector is disabled.

14. CH2 Control/Output Connector

To quickly change the current channel displayed on the screen (When CH2 label is highlighted, CH1 is chosen currently and all displayed parameters are CH2-related and ready to be set up). If the current channel is CH2 (highlighted CH2 label), then you can press **CH2** button to turn on/off CH2 output, or press **Utility** to pop up **CH2 Setting** label and use the softkey to set CH2 settings. Under this status, **CH2** button is illuminated, current output mode shows to the right of CH2 label (“wave”, or “Mod”, or “Sweep”, or “Burst” icon) and CH2 connector output is enabled. With CH2 button switched off, the

UTG2000A user manual

button backlight turns off, “Off” icon shows to the right of CH2 label and CH2 connector is disabled.

Rear Panel

Check details for rear panel in following Figure 2-2

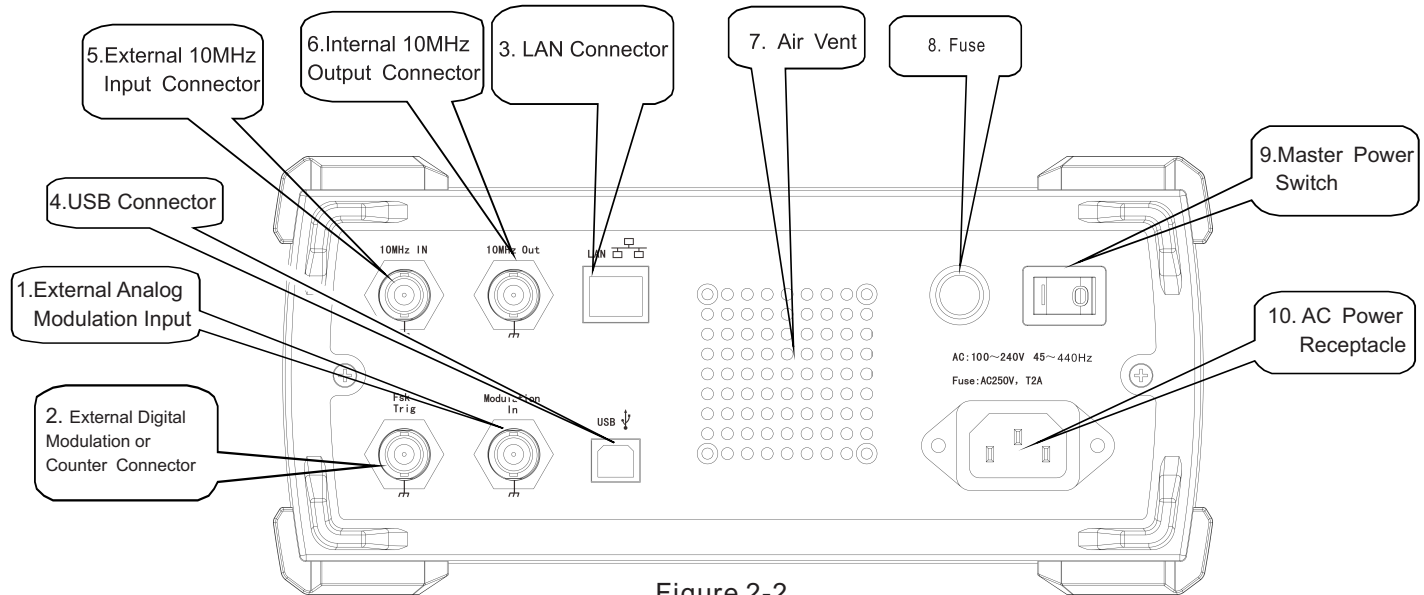

Figure 2-2

1. External Analog Modulation Input Connector

For AM, FM, PM or PWM modulation type, the terminal is used for the signal input when external source is selected. The modulation depth or deviation value (frequency, phase or duty cycle) will be controlled by $\pm 5V$ signal level present on this input terminal.

2. External Digital Modulation or Counter Connector

For ASK, FSK or PSK modulation type, this connector is used for signal input when external source is selected. Output amplitude, frequency and phase will be controlled by signal level present on this connector. For Sweep or Burst mode, when you select external source, it is used to accept polarized TTL pulse that can enable the sweep or N-cycle burst. Or if the burst is gated, you can input gated signal using this connector. When use the frequency meter function, you can also use the connector to input signal (compatible with TTL level

signal) or output trigger signal when under Sweep or Burst mode. (When external trigger source is selected, Trigger Out option in the parameter list will be ignored, since this connector cannot be used for input and output terminals at the same time)

3. LAN Connector

To Connect the Generator to local network for remote control.

4. USB Connector

To Connect the Generator to PC using USB cable. You can control your Generator through PC (for instance, it can be used to upgrade the Generator system program so as to ensure your function/ arbitrary generator has the latest program released by the company).

5. External 10MHz Input Connector

To input external 10MHz reference signal after the Generator clock source is set up externally.

UTG2000A user manual

When you want to synchronize multiple UTG2000A function/arbitrary waveform generators or synchronize the Generator and external 10 MHz reference signal, use this external input connector.

6. Internal 10MHz Output Connector

To output 10 MHz reference signal after the Generator clock source is set up internally. When you want to synchronize multiple UTG2000A function /arbitrary waveform generators or output 10 MHz reference frequency signal, use this internal output connector.

7. Air Vent

To ensure the Generator has good ventilation. Do not block these holes.

8. Fuse

To avoid disastrous damage to the Generator when the power current is extremely large due to thunderstroke or component aging. The fuse will melt down to disrupt the power supply when the input AC current exceeds 2A.

9. Master Power Switch

To energize the Generator when set to “I”; otherwise set to “O” to dis-energize AC input (On/Off button on the front panel will not work).

10. AC Power Receptacle

AC power specification for the Generator:
100~240V, 45~440Hz, power fuse: 250V, T2 A.

Display Interface

Refer to display interface shown in Figure 2-3

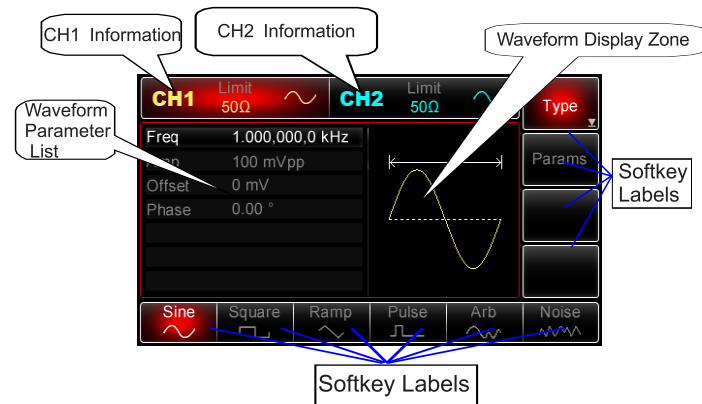

Figure 2-3

Detail Description:

■ **CH1 Information:** When the display is highlighted (central label in red), it indicates only CH1 information is enabled and CH1 parameters are ready to set up. No CH1 setup is allowed if CH1 information is not highlighted. To switch on CH1 information directly, press **[CH1]** button. On the upper display of CH1 information, there is “Limit” icon that represents the output amplitude limit which is effective in white and off in grey. On the lower display is the impedance value that the output terminal needs to match (adjustable within $1\Omega\sim 10\text{ k}\Omega$, or set to high impedance that is 50Ω by default). To the right is the display of currently effective waveform (waveform shape, or “Mod”, “Sweep” or “Burst” icon) or “Off” in grey (CH1 output connector has switched off).

■ **CH2 Information:** When the display is highlighted (central label in blue), it indicates only CH2 information is enabled and CH2 parameters are

ready to set up. No CH2 setup is allowed if Ch2 information is not highlighted. To switch on CH2 information directly, press **[CH2]** button. On the upper display of CH2 information, there is “Limit” icon that represents the output amplitude limit which is effective in white and off in grey. On the lower display is the impedance value that the output terminal needs to match (adjustable within $1\Omega\sim 10\text{ k}\Omega$, or set to high impedance that is 50Ω by default). To the right is the display of currently effective waveform (waveform shape, or “Mod”, “Sweep” or “Burst” icon) or “Off” in grey (CH2 output connector has switched off).

■ **Softkey Labels:** To indicate the current functions which correspond to the functional menus and menu operation softkeys on the side and bottom of display. Highlighted: The display will be in the color corresponding to that of the current channel or in system grey on the center and the characters are in pure white.

UTG2000A user manual

1) Labels on the Right of Screen: The label has been selected if it is highlighted, and then 6 softkey labels on the bottom of screen will display options related to the label. (**Note:** if the currently selected label has more than one sub-catalogs, displayed options on the bottom of screen are not necessarily the sub-catalogs of the label. For instance, if **Type** softkey label is highlighted, on the bottom of screen will be sub-labels for types of waveforms, which are the sub-catalog of **Type**. If you press **Menu** button now, **Wave** label will be highlighted, however, labels on the bottom of screen keep unchanged, which doesn't mean they are sub-catalogs of **Wave** because sub-catalogs for **Wave** label are **Type** and **Params**.) When the label on the right includes more than six options (that is more than 6 softkey sub-labels on the bottom of screen,  icon will show on lower corner of the label), press the label again to access the next screen if you want to view more options.

2) Sub-Labels on the Bottom of Screen: When sub-label options belong to sub-catalogs of **Type** label on the right of screen, these labels will be highlighted if selected. If sub-label options are sub-catalogs of **Params** Label on the right of screen (or sub-catalogs of one of **Ch1Setting**, **CH2 Setting**, **I/O (or Freq Meter)** and **System** labels popped up after pressing **Utility** button), you will find these sub-label options correspond to the parameters one by one in the parameter list and are also marked around the edges with the same color with that of the current channel (it is grey when setting the system) and with words in pure white (words in parameter list turn white if selected) if the sub-label has been selected; if you press sub-label softkeys or multipurpose knob at the moment, the sub-label labels will be highlighted to indicate that the parameter that corresponds to the sub-label is ready to edit. Use the multipurpose knob if you want to modify the parameter, then press the

knob to confirm and exit the editing after the setting is finished. If the sub-label has been “selected” but not under editing status yet, turning the multifunction knob or pressing arrow buttons can allow you to toggle between different labels (switch between different parameters accordingly in parameter list); To modify parameter with digits and units under selected or editing status, you can also enter the numbers directly using the numeric keypad (Left arrow button can be used to clear the digit prior to the current input) and select desired unit on the bottom of screen, then press the sub-label softkey or multipurpose knob to confirm and exit the editing.

■ **Waveform Parameter List:** All parameters related to the current waveform will be listed on the screen. If one of parameters turns white, it indicates you can set up the parameter using menu operation softkeys, numeric keypad, arrow buttons and multipurpose knob. If the current character has the

same color with that of the current channel (it is white when setting the system), it indicates the character is ready to edit using arrow button or numeric keypad or multipurpose knob.

■ **Waveform Display Zone:** To display waveform graphic with the current settings of the channel (you can identify which channel has been selected through checking the color or the highlighted display of CH1/CH2 information area. And the parameters on the left display of screen are related parameters of the waveform). **Note:** No waveform displays when setting the system, so the waveform graphic zone are left out for the parameter list.

UTG2000A user manual

Chapter 3 Quick Start

General Check

Following procedures are expected to proceed when you get a new function/arbitrary waveform generator.

Checking for Any Damage in Transit

Contact distributor or local representative office immediately if the packing carton or foamed plastic cushion is seriously damaged.

When the product is damaged due to the transit, keep the package and inform the shipping agency and distributor, and the distributor will arrange the maintenance or replacement for you.

Checking the Accessories

The accessories supplied with UTG2000A model include: power cable(applicable for the country/region of destination); USB cable, 1pc; BNC cable (1m), 2pcs; users manual, 1pc; CD disk, 1pc;

Please contact distributor or local representative office if any accessory is damaged or missing.

Checking the Whole Instrument

If the Generator is found damaged externally or it does not work normally or pass any performance test, contact distributor or local representative office.

Adjusting the Carrying Handle

UTG2000A series Function/Arbitrary Waveform Generator is designed with a carrying handle that can be adjusted freely. To adjust the carrying handle, hold the handle by two sides and pull outward. You can adjust the handle to the location as desired. Please refer to Figure 3-1:

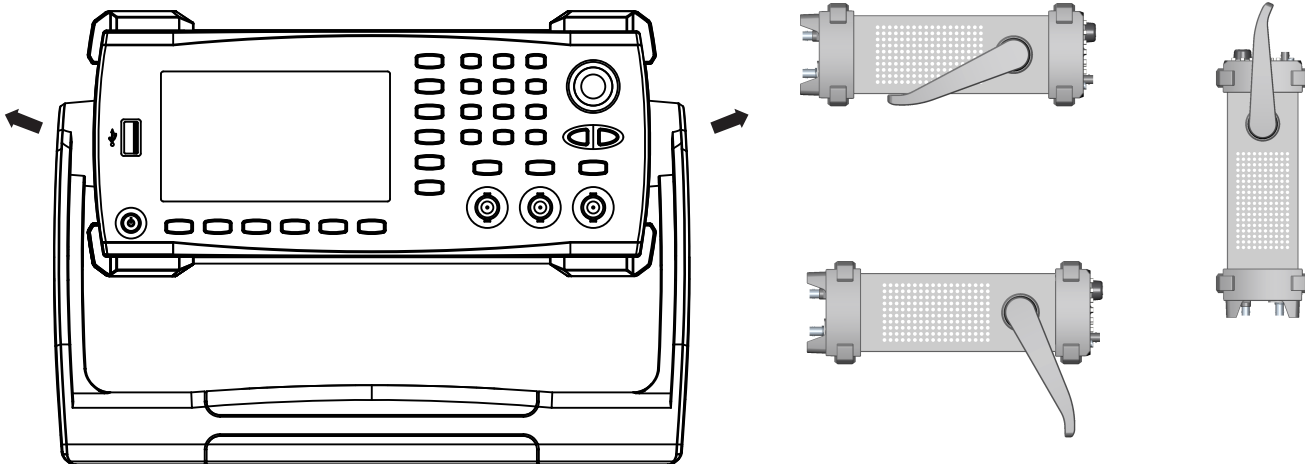

Figure 3-1

UTG2000A user manual

Outputting Basic Waveforms

Setting Output Frequency

At power-on, the Generator configures a default sine wave with 100 mVp-p amplitude at a frequency of 1kHz (into a 50Ω termination) . To change the frequency to 2.5MHz, follow steps as shown below:

1. Press **Menu**→**Wave**→**Params**→**Freq** button or softkey(if **Freq** label doesn't pop out on the bottom of screen after pressing **Params** softkey, please press **Params** again to access next screen). When you change the frequency, the same frequency is used if the current frequency value is valid for the new application. To modify the waveform period at this moment, please press **Freq** softkey again to toggle between **Period**and **Freq** labels.

2. Enter the desired number 2.5 using numeric keypad.

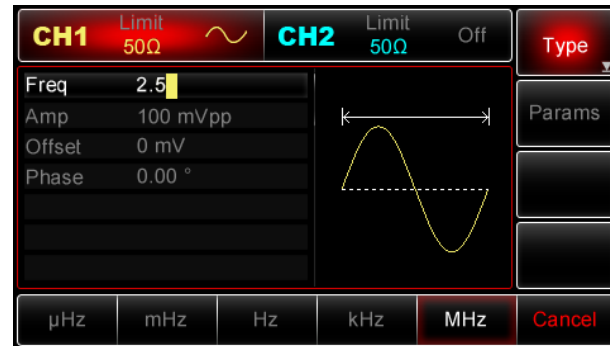

3. Select the desired unit

Press the softkey that corresponds to the desired unit. When you select the unit, the Generator outputs the waveform with the displayed frequency (if the output has been enabled). In this example, press MHz softkey.

Note: You can also use the multipurpose knob and arrow buttons together to modify the frequency.

Setting Output Amplitude

At power-on, the Generator configures a default sine wave with 100 mVp-p amplitude (into a 50Ω termination) . To change the amplitude to 300mVpp, follow steps as shown below:

1. Press **Menu** → **Wave** → **Params** → **Amp** button or softkey (if **Amp** label doesn't pop out on the bottom of screen after pressing **Params** softkey, please press **Params** again to access next screen). When you change the amplitude, the same amplitude is used if the current amplitude value is valid for the new application. Press **Amp** softkey again to quickly access different units (Vpp, Vrms and dBm)
2. Enter the desired number 300 using numeric keypad.

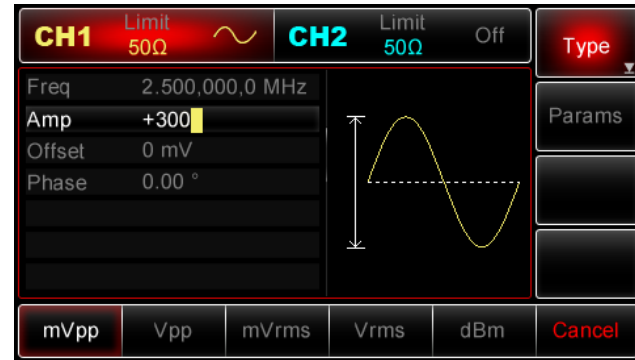

3. Select the desired unit

Press the softkey that corresponds to the desired unit. When you select the unit, the Generator outputs the waveform with the displayed amplitude (if the output has been enabled). In this example, press **mVpp** softkey.

Note: You can also use the multipurpose knob and arrow buttons together to modify the amplitude.

UTG2000A user manual

Setting DC Offset Voltage

At power-on, the Generator configures a default sine wave with 0V DC offset voltage (into a 50Ω termination). To change DC offset to -150mV, follow steps as shown below:

1. Press **Menu** → **Wave** → **Params** → **Offset** button or softkey (if **Offset** label doesn't pop out on the bottom of screen after pressing **Params** softkey, please press **Params** again to access next screen). When you change the DC offset, the same DC offset is used if the current DC offset value is valid for the new application. Press **Offset** softkey again and you will find the original waveform that are defined by the amplitude and DC offset will change into the one using high level (Max.) and low level (Min.), a very convenient way for digital applications.
2. Enter the desired number -150mV using numeric keypad.

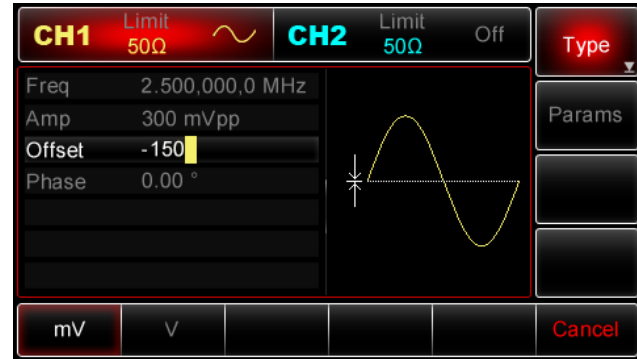

3. Select the desired unit

Press the softkey that corresponds to the desired unit. When you select the unit, the Generator outputs the waveform with the displayed DC offset (if the output has been enabled). In this example, press **mV** softkey.

Note: You can also use the multipurpose knob and arrow buttons together to modify DC offset.

Setting the Squarewave

The duty cycle of squarewave represents the amount of time per cycle that the squarewave is at a high level (suppose the waveform is not inverted). At power-on, the duty cycle of squarewave defaults at 50%. The duty cycle is limited by 20ns (or 40ns) minimum pulse width. To set the frequency to 1kHz, amplitude to 1.5Vpp, DC offset to 0V and duty cycle to 70% for the squarewave, follow steps as shown below:

Press **Menu** → **Wave** → **Type** → **Square** → **Params** button or softkey (If **Type** label is not highlighted, press **Type** softkey again to select). In order to set up required parameters, press the softkey that corresponds to the parameter, then enter desired value and finally select desired unit.

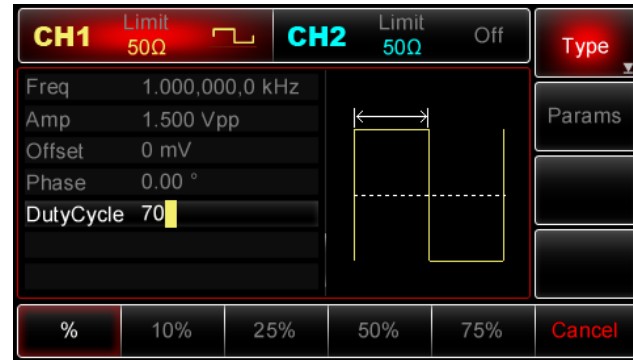

Note: You can also use the multipurpose knob and arrow buttons together to modify the parameters.

Setting the Pulse Waveform

The duty cycle of pulse waveform represents the amount of time from 50% threshold of rising edge to 50% threshold of next falling edge (Suppose the waveform is not inverted). You can configure the Generator to output a pulse waveform with variable pulse width and edge time. At power-on, the duty

UTG2000A user manual

cycle of pulse waveform is 50% and rising/falling edge time is 1us by default. To set the period to 2ms, the amplitude to 1.5Vpp, DC offset to 0V, duty cycle (limited by 20ns (or 40ns) minimum pulse width) to 25%, rising edge time to 200us and falling edge time to 200us for the pulse waveform, follow steps as shown below:

Press **Menu** → **Wave** → **Type** → **Square** → **Params** button or softkey (If **Type** label is not highlighted, press **Type** softkey again to select). then press **Freq** softkey to switch from frequency to period. Next enter period value and select the desired unit. To enter duty cycle value, you can press the softkey that corresponds to **25%** on the bottom of screen to directly enter the number, or you can also enter the number 25 and press **%** to complete the input. To set up the falling edge time, press **Params** softkey again or turn the multipurpose knob clockwise to access

next screen when the sub-labels are under selected status (sub-label surrounding edges are in the color same with that of current channel if it is selected status, the sub-label is highlighted when under editing status, refer to Section “**Sub-Label on the Bottom of Screen**” for details.), and then press **TailEdge** softkey, enter the desired value and select the desired unit.

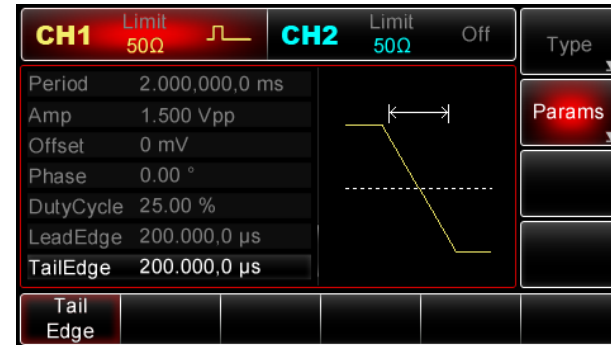

Note: You can also use the multipurpose knob and arrow buttons together to modify the parameters.

Setting DC Volts

In fact, DC voltage varies with DC offset that has been set hereinbefore. So modifying DC offset mentioned before has already changed default value of DC voltage (DC offset). At power-on, DC voltage is 0V. To set DC voltage to 3V, follow steps as shown below:

1. Press **Menu**→**Wave**→**Type**→**DC**(If **Type** label isn't highlighted after pressing **Wave**, please press **Type** softkey twice, the first time is to highlight the label, the second time is to display next screen of sub-labels). When you change DC Volts (DC offset), the same DC Volts (DC offset) is used if the current DC voltage (DC offset) is valid for the new application.
2. Enter the number 3 using the numeric keypad.



3. Select the desired unit

Press the softkey that corresponds to the desired unit. When you select the unit, the Generator outputs the waveform with the displayed DC offset (if the output has been enabled). In this example, press **V** softkey.

Note: You can also use the multipurpose knob and arrow buttons together to modify DC offset.

UTG2000A user manual

Setting the Ramp Waveform

Symmetry represents the amount of time per cycle that the ramp is positive. At power-on, the ramp symmetry is 100% by default. To configure triangle waveform with the frequency set to 10kHz, the amplitude to 2V, DC offset to 0V and duty cycle to 50%, follow steps as shown below:

Press **Menu**→**Wave**→**Type**→**Ramp**→**Params** (if **Type** label is not highlighted, press **Type** softkey again to select). To set the required parameters, press the corresponding softkey, then enter the desired value and the desired unit. When entering the symmetry value, you can press the softkey corresponding to **50%** label to directly input or key in 50 and press **%** to complete the input.



Note: You can also use the multipurpose knob and arrow buttons together to modify the parameters.

Setting the Noise Waveform

The standard Gaussian noise in UTG2000A Generator has a 100mVpp amplitude and 0mV DC offset by default. The default noise waveform also changes accordingly if the amplitude and DC offset functions of other waveforms have been modified. Only the amplitude and DC offset of the noise

waveform are available to modify. To set standard Gaussian noise amplitude to 300mVpp, and DC offset to 1V, follow steps as shown below:

Press **Menu** → **Wave** → **Type** → **Noise** → **Params** (if **Type** label is not highlighted, press **Type** again to select). To set the required parameters, press the corresponding softkey, and then enter the desired value and the desired unit.

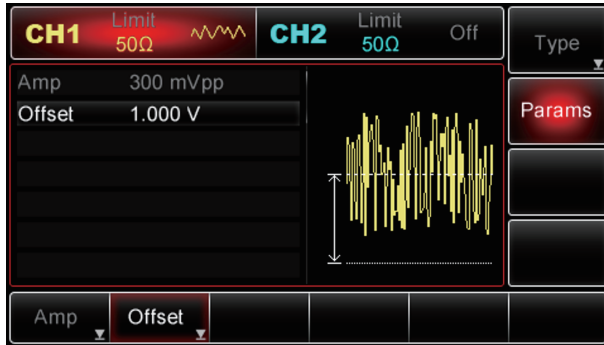

Note: You can also use the multipurpose knob and arrow buttons together to modify the parameters.

Frequency Measurement

The generator can measure the frequency (ranging from 100mHz~200MHz) of compatible TTL level signal, including the duty cycle of it. When using frequency meter function, compatible TTL level signal is input through external digital modulation or through frequency meter port (FSK Trig/CNT connector). By pressing **Utility** → **Freq Meter**, frequency, cycle and duty cycle can be readout from parameter list. Previous measured value is displayed in parameter list as always when there is no signal input. Frequency meter display refreshes only if compatible TTL level signal is input through external digital modulation or frequency meter port.

UTG2000A user manual

Using Built-in Help System

The built-in help system offered by the Generator provides a context-sensitive assistance on any front-panel button or menu softkey. The design of help topics list also helps you with some front-panel operations.

1. View help information for a function key

Long press any softkey or button, for instance, the **Menu** button. If the information contains more than will fit on one screen, press “**▶**” softkey or turn the multipurpose knob to check next screen.

Press **Return** to exit the help

2. View the list of help topics

Press **Utility**→**System**→**System**→**Help** to check available help topics list. Select “Get HELP on any key”. Press **Return** softkey to exit.

3. View help information for displayed messages

The function/arbitrary generator will display a

message whenever the limit is exceeded or any configuration is not valid. The built-in help system offers additional information about the latest messages. Press **Utility**→**System**→**System**→**Help** to view available help topics list. Then select “View the last displayed message”. Press **Return** to exit.

Note:

Local Language Help: Built-in help system is available in Simple Chinese, Traditional Chinese and English. All messages, context-sensitive help information and help topics are displayed in the selected language. To select local language, please press **Utility**→**System**→**Language**, then press the arrow label softkey to select the desired language (or turn multipurpose knob to select).

Chapter 4 Advanced Applications

Outputting Modulated Waveforms

Amplitude Modulation

In AM, modulated waveform consists of a carrier and modulating waveform. The carrier amplitude is varied by the changing amplitude of modulating waveform. CH1 and CH2 of the Generator can be modulated independently with modulation types applied the same or differently.

Selecting AM

Press **Menu** → **Mod** → **Type** → **AM** to enable AM function (If **Type** label is not highlighted, press **Type** softkey again to select), with AM enabled, the Generator will output the modulated waveform according to current settings of modulating waveform and the carrier.

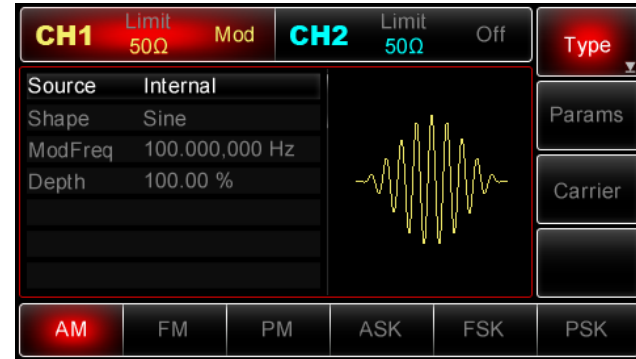

Selecting the Carrier

The AM carrier shape can be: sinewave, squarewave, ramp or arbitrary waveform (except DC). It is sinewave by default. When AM is selected, press **Carrier** to access carrier waveforms to be selected

UTG2000A user manual

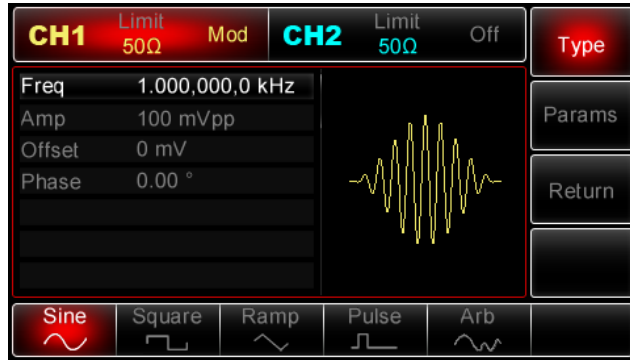

Setting Carrier Frequency

Carrier frequency ranges could be different and depend on different functions to be selected. The default is at 1kHz for all functions. Refer to the following table for details:

Functions	Frequency			
	UTG2062A		UTG2025A	
	Min. Value	Max. Value	Min. Value	Max. Value
Sine	1uHz	60MHz	1uHz	25MHz

Square	1uHz	25MHz	1uHz	5MHz
Ramp	1uHz	400kHz	1uHz	400KHz
Pulse	500uHz	25MHz	500uHz	5MHz
Arbitrary	1uHz	12MHz	1uHz	5MHz

To set the carrier frequency, please select the carrier waveform first and then use multipurpose knob and arrow buttons to set up the parameter or press **Params** → **Freq** softkeys, enter the desired frequency value, select the desired unit to complete the input.

Selecting Modulating Source

UTG2000A Generator can select internal or external source for the modulation. With AM enabled, the modulating source defaults at Internal. To modify the parameter, switch on AM interface first, then turn the multipurpose knob or press **Params** → **Source** → **Ext** softkeys to select

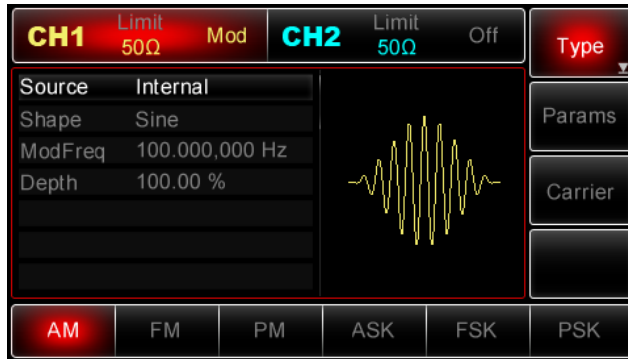

1) Internal Source

When you select internal source, modulating waveform can be: sine, square, upramp, downramp, arbitrary, noise. The default is sine. So after AM is enabled, the modulating shape defaults at sine. To modify the parameter, switch on AM interface first, then turn the multipurpose knob or press **Params** → **Shape** softkeys to select

- Square: 50% Duty Cycle

- UpRamp: 100% Symmetry
- DownRamp: 0% Symmetry
- Arbitrary: when arbitrary waveform is selected as the modulating shape, the waveform is automatically sampled and limited to 1kpts.
- Noise: White Gaussian

2) External Source

When you select external source for the modulation, modulating shape and modulating frequency items are hid from parameter list and the carrier is modulated by external waveform. AM modulating depth is controlled by $\pm 5V$ signal level present on external analog modulation connector (Modulation In) on the rear panel. For instance, modulation depth in the parameter list has been set to 100%, when +5V external modulation signal is applied, AM output amplitude goes up to maximum value; AM output amplitude is down to

UTG2000A user manual

the minimum with external signal applied at -5V.

Setting Modulating Waveform Frequency

Modulating frequency is available to set up when you select internal modulating source. With AM enabled, the modulating frequency defaults at 100Hz. To change the frequency, switch on AM interface first, then use the multipurpose knob and arrow buttons or press **Params**→**ModFreq** softkeys to select between 2mHz~50kHz. If the source is chosen externally, modulating waveform and frequency options don't show on the parameter list. In this case, the carrier is modulated by an external waveform at a frequency of 0Hz~20kHz.

Setting Modulating Depth

Modulating depth is expressed as a percentage and represents amplitude variation. AM amplitude depth can be selectable from 0%~120%, the default is 100%. When modulating depth is at 0%, the output

amplitude is constant value (half of set value of carrier amplitude). At 100%, the output amplitude varies with the modulating waveform. At greater than 100%, the Generator will not exceed $\pm 5V$ Peak-Peak voltage output (into 50 Ω termination). To modify modulation depth, switch on AM function interface first, then use the multipurpose knob and arrow buttons or Press **Params**→**Depth** When you select external source for the modulation, the output amplitude is also controlled by $\pm 5V$ signal level present on External Analog Modulation Input (**Modulation In**) Connector. For instance, modulating depth in the parameter list has been set to 100%. When modulating signal is +5V, AM output is at the maximum amplitude; at -5V, AM output will go down to the minimum amplitude.

Applications

First of all, please enable AM mode of the Generator. To set a 200Hz sinewave from internal

source as modulating signal, to set a squarewave with 200mVpp amplitude and 45% duty cycle at a frequency of 10 kHz as the carrier and modulating depth at 80%, please follow steps as below:

1) Enabling AM Function

Press **Menu** → **Mod** → **Type** → **AM** (if **Type** label is not highlighted, press **Type** softkey again to select) to enable the AM function.

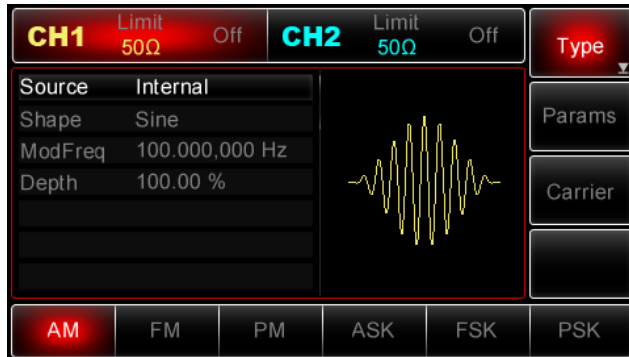

2) Setting Modulating Waveform Parameters

With AM function enabled, use multipurpose knob and arrow buttons to complete the setup. Or you can also press **Params** in AM interface to pop up the display as below:

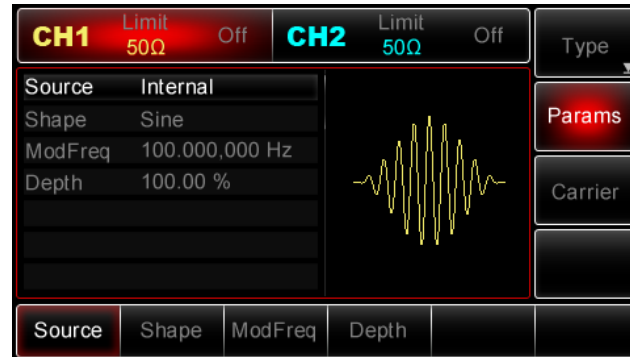

UTG2000A user manual

To set desired parameter, press corresponding softkey, then enter in desired value and select the unit as required.

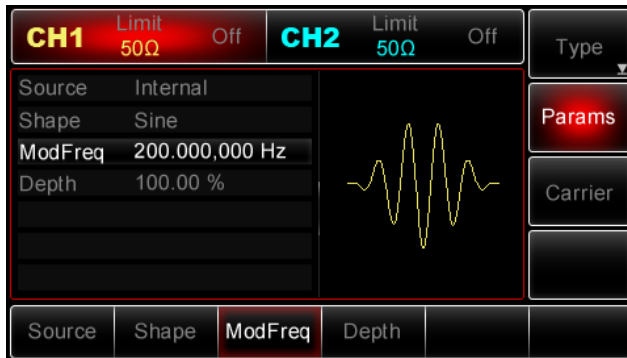

3) Setting Carrier Parameters

Press **Carrier** → **Type** → **Square** (If **Type** label is not highlighted, press **Type** softkey again to select) to select the squarewave as the carrier shape.

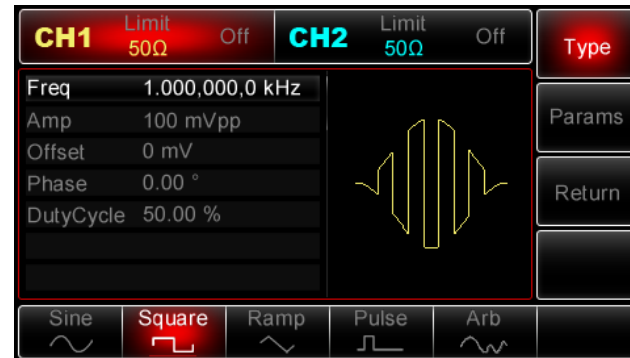

Use multipurpose knob and arrow buttons to complete the setup. Or you can also press **Params** in the interface above to pop up the display as below:

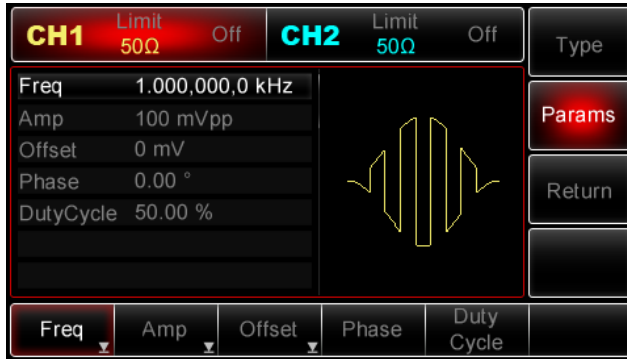

To set desired parameter, press the corresponding softkey, then enter in desired value and select the unit as required.

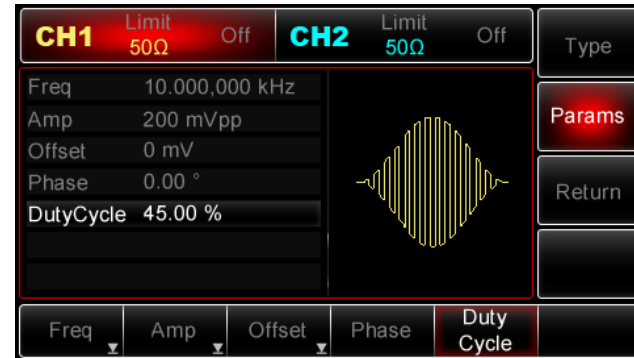

UTG2000A user manual

4) Setting Modulating Depth

With the carrier setup finished, press **Return** softly to return to the following interface and then set modulating depth.

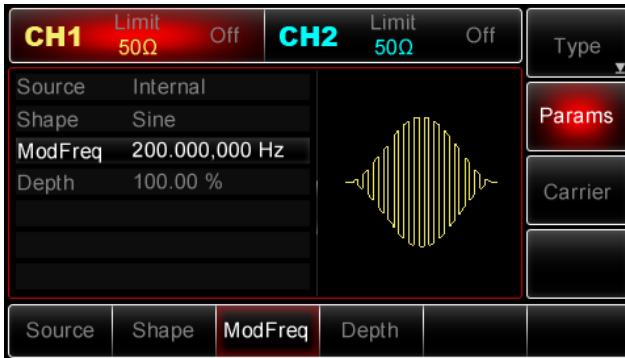

Use multipurpose knob and arrow buttons to complete the setup. Or you can press **Params** → **Depth** softkeys, then key in 80 using numeric keypad and press **%** softkey to finish the setting.

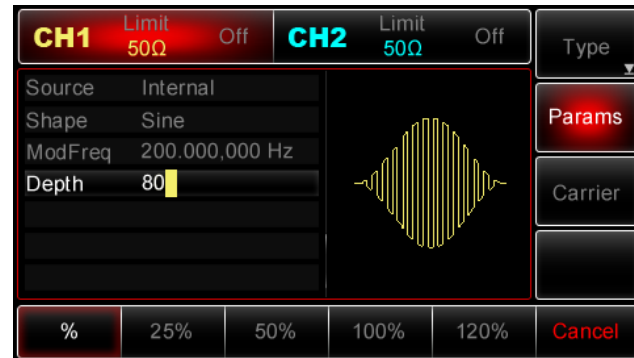

5) Enabling Channel Output

Press **CH1** button on the front panel to switch on CH1 output directly, or you can press **Utility** → **CH1 Setting** to enable the output. With CH1 output enabled, **Ch1** button is illuminated, and “Off” icon in grey and to the right of CH1 label changes into “Mod” in yellow, indicating CH1 output has been enabled.

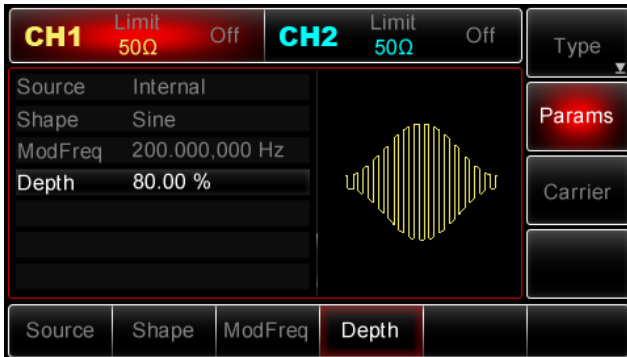

View AM modulated waveform with use of an Oscilloscope shown as below:

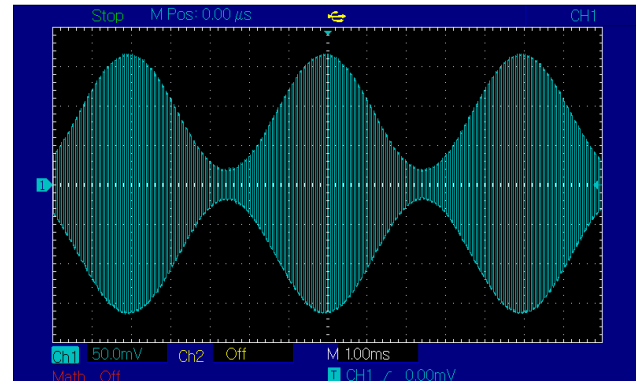

UTG2000A user manual

Frequency Modulation(FM)

In FM, modulated waveform consists of the carrier and modulating waveform. The carrier frequency is varied by the changing amplitude of modulating waveform. CH1 and CH2 of the Generator can be modulated independently with modulation types applied the same or differently.

Selecting FM

Press **Menu**→**Mod**→**Type**→**FM** to enable FM function (If **Type** label is not highlighted, press **Type** softkey again to select). With FM enabled already, the Generator will output the modulated waveform according to current settings of modulating waveform and the carrier.

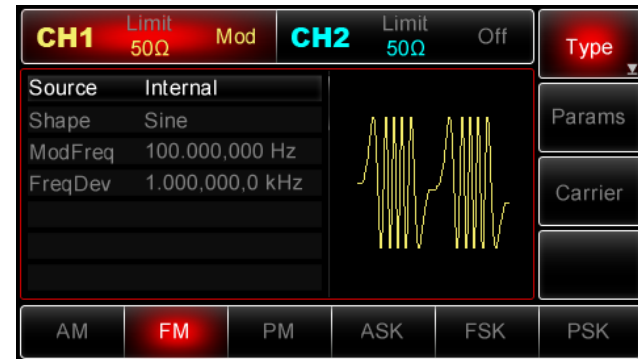

Selecting the Carrier

The FM carrier shape can be: sine, square, ramp or arbitrary waveform (except DC). The default is sine. When FM is selected, press **Carrier** to access carrier waveforms to be selected

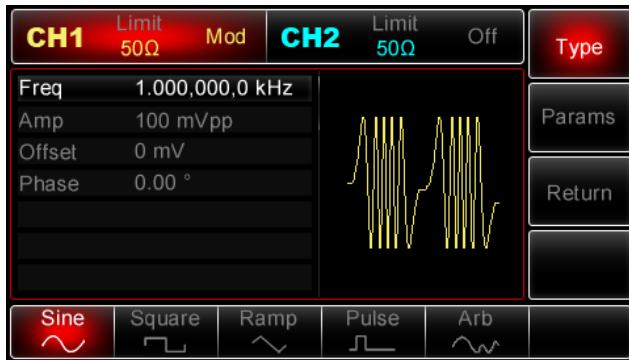

Setting Carrier Frequency

Carrier frequency ranges could be different and depend on different functions to be selected. The default is at 1kHz for all functions. Refer to the following table for details:

Functions	Frequency			
	UTG2062A		UTG2025A	
	Min. Value	Max. Value	Min. Value	Max. Value
Sine	1uHz	60MHz	1uHz	25MHz
Square	1uHz	25MHz	1uHz	5MHz
Ramp	1uHz	400kHz	1uHz	400KHz
Pulse	500uHz	25MHz	500uHz	5MHz
Arbitrary	1uHz	12MHz	1uHz	5MHz

To set the carrier frequency, please select the carrier waveform first and then use multipurpose knob and arrow buttons to set up the parameter or press **Params** → **Freq** softkeys, enter the desired frequency value and select the desired unit to complete the setting.

UTG2000A user manual

Selecting Modulating Source

UTG2000A Generator can offer an internal or external modulating source. With FM enabled, the modulating source defaults at Internal. To modify the parameter, switch on FM interface first, then turn the multipurpose knob or press **Params**→**Source**→**Ext** softkeys to select.

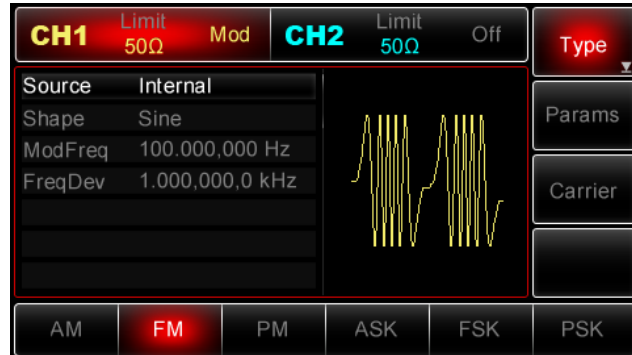

1) Internal Source

When you select internal source, modulating waveform can be: sine, square, upramp, downramp, arbitrary, noise. The default is sine. After FM is enabled, the modulating shape defaults at sine. To modify the parameter, switch on FM interface, turn the multipurpose knob or press **Params**→**Shape** softkeys to select

- Square: 50% Duty Cycle
- UpRamp: 100% Symmetry
- DownRamp: 0% Symmetry
- Arbitrary: When arbitrary waveform is selected as the modulating shape, the waveform is automatically sampled and limited to 1kpts.
- Noise: White Gaussian

2) External Source

When you select external modulating source, modulating shape and modulating frequency items

don't show on the parameter list and the carrier is modulated by an external waveform. FM frequency deviation is controlled by $\pm 5V$ signal level present on External Analog Modulation Input (**Modulation In**) connector on the rear panel. When the signal level is positive, the Generator will output an output frequency greater than the carrier frequency, or less than the carrier frequency if the signal level is negative. External signal with lower level generates smaller deviation. For example, frequency deviation in the parameter list is set to 1 kHz. When external modulating waveform is at +5V, FM output frequency equals Carrier Frequency + 1kHz; at -5V, FM output frequency equals Carrier Frequency - 1kHz.

Setting Modulating Waveform Frequency

Modulating frequency is available to set up when you select internal modulating source. With FM enabled, the modulating frequency defaults at

100Hz. To change the frequency, switch on FM interface first, then use the multipurpose knob and arrow buttons or press **Params** → **ModFreq** softkeys to select between 2mHz~50kHz. If the source is chosen externally, modulating waveform and frequency options don't show on the parameter list. In this case, the carrier is modulated by an external waveform at a frequency from 0Hz~20 kHz.

Setting Frequency Deviation

Frequency deviation represents the variation of the frequency of modulated waveform from the carrier frequency. FM frequency deviation can be settable from 1uHz to a half of the maximum frequency value of the current carrier. The default is 1kHz. To change the deviation, switch on FM interface, use multipurpose knob and arrow buttons together or press **Params** → **FreqDev** to set up the parameter.

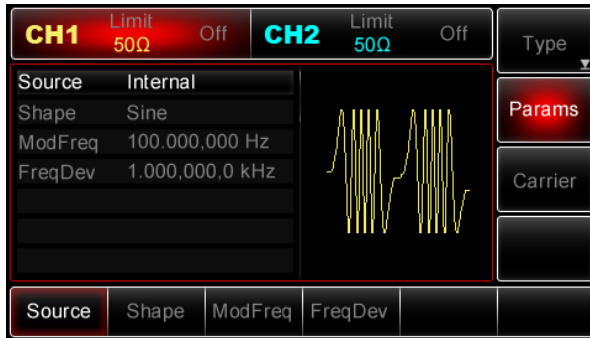

To set desired parameter, press corresponding softkey, then enter in desired value and select the unit as required.

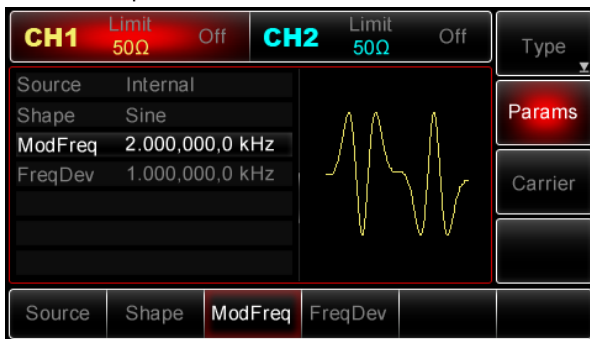

3) Setting Carrier Parameters

Press **Carrier**→**Type**→**Sine** (If **Type** label is not highlighted, press **Type** softkey again to select) to select the sinewave as the carrier shape. The default is sine. So there is no need to modify

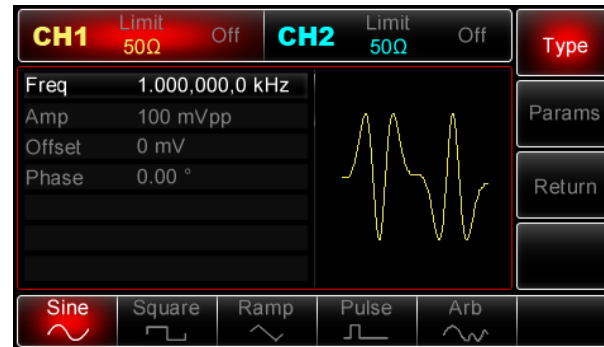

Use multipurpose knob and arrow buttons to complete the setup, or you can press **Params** softkey in the interface above to pop up the display as below:

UTG2000A user manual

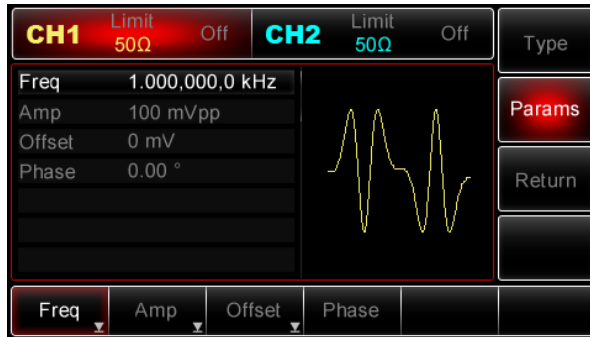

To set desired parameter, press the corresponding softkey, then enter in desired value and select the unit as required.

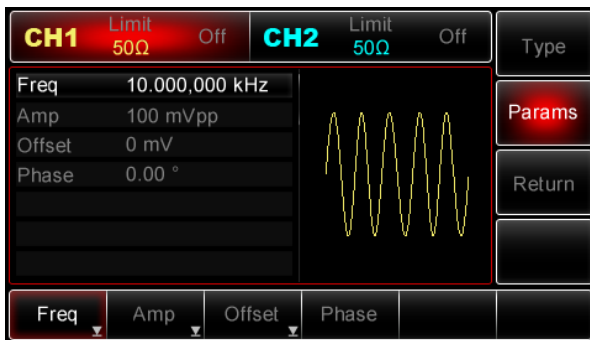

4) Setting Frequency Deviation

With the carrier setup finished, press **Return** softkey to return to the following interface and set frequency deviation.

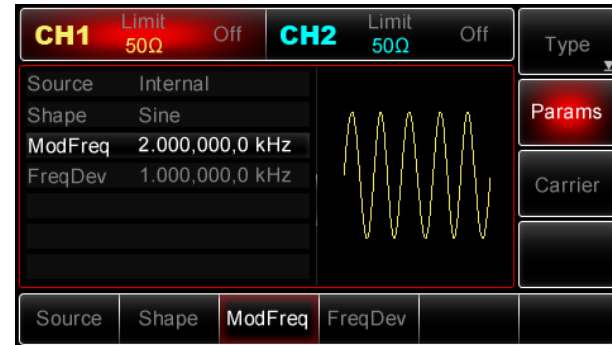

Use multipurpose knob and arrow buttons to complete the setup, or you can press **Params** → **FreqDev** softkeys, then key in 5 using numeric keypad and press **kHz** softkey to finish the setting.

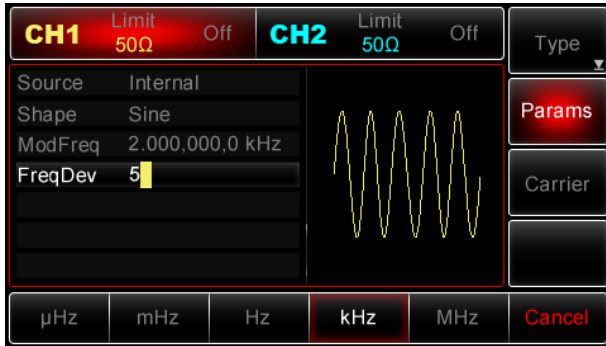

5) Enabling Channel Output

Press **CH1** button on the front panel to switch on CH1 output directly, or you can press **Utility** → **CH1Setting** to enable the output. With CH1 output enabled, **CH1** button is illuminated and “Off” in grey and to the right of CH1 label changes into “Mod” in yellow, indicating CH1 output has been enabled.

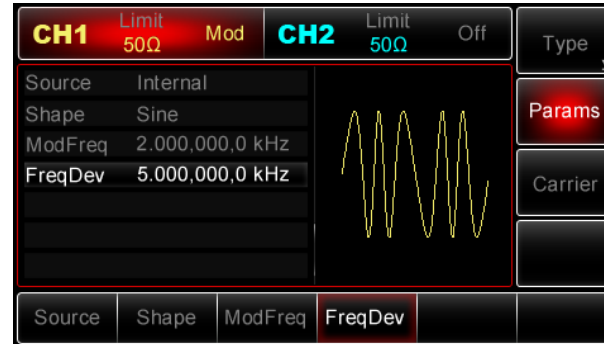

UTG2000A user manual

View FM modulated waveform with use of an Oscilloscope shown as below:

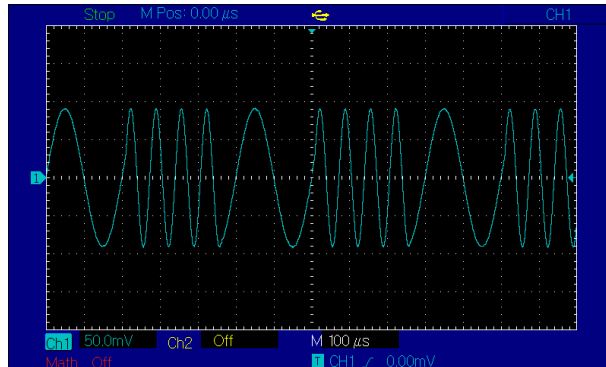

Phase Modulation (PM)

In PM, modulated waveform consists of the carrier and modulating waveform. The carrier amplitude is varied by the changing amplitude of modulating waveform. CH1 and CH2 of the Generator can be modulated independently with modulation types applied the same or differently.

Selecting PM

Press **Menu** → **Mod** → **Type** → **PM** to enable PM function (If **Type** label is not highlighted, press **Type** softkey again to select). With PM enabled, the Generator will output the modulated waveform according to current settings of modulating waveform and the carrier.

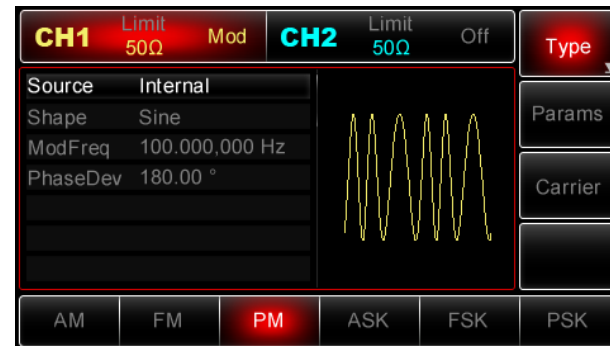

Selecting the Carrier

The PM carrier shape can be: sinewave, squarewave, ramp or arbitrary waveform (except DC). It is sine by default. When PM is selected, press **Carrier** to access carrier waveforms to be selected

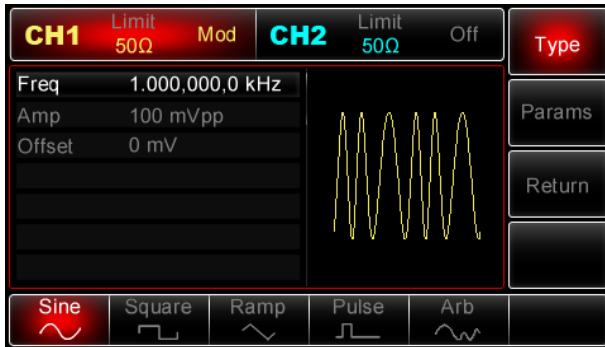

Setting Carrier Frequency

Carrier frequency ranges could be different and depend on different functions to be selected. The default is at 1kHz for all functions. Refer to the

following table for details:

Functions	Frequency			
	UTG2062A		UTG2025A	
	Min.Value	Max. Value	Min.Value	Max. Value
Sine	1uHz	60MHz	1uHz	25MHz
Square	1uHz	25MHz	1uHz	5MHz
Ramp	1uHz	400kHz	1uHz	400KHz
Pulse	500uHz	25MHz	500uHz	5MHz
Arbitrary	1uHz	12MHz	1uHz	5MHz

To set the carrier frequency, please select the carrier waveform first, and then use multipurpose knob and arrow buttons to set up the parameter or press **Params** → **Freq** softkeys, enter the desired frequency value, select the desired unit to complete the setting.

Selecting Modulating Source

UTG2000A Generator can offer an internal or external modulating source. With PM enabled, the modulating source defaults at Internal. To modify

the parameter, switch on PM interface, turn the multipurpose knob interface or press **Params**→**Source**→**Ext** softkeys to select

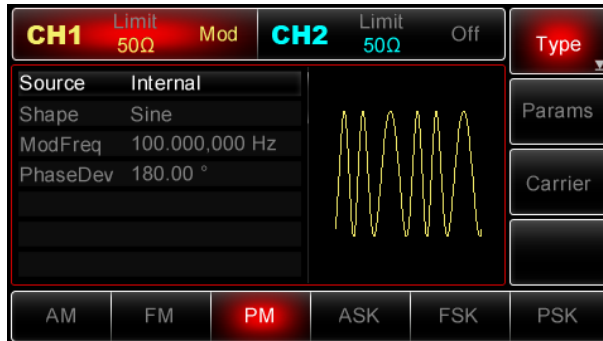

1) Internal Source

When you select internal source, modulating waveform can be: sine, square, upramp, downramp, arbitrary, noise. The default is sine. So after PM is enabled, the modulating shape defaults at sine. To modify the parameter, switch on PM interface, turn the multipurpose knob or press **Params**→**Shape**

softkeys to select

- Square: 50% Duty Cycle
- UpRamp: 100% Symmetry
- DownRamp: 0% Symmetry
- Arbitrary: When arbitrary waveform is selected as the modulating shape, the waveform is automatically sampled and limited to 1kpts.
- Noise: White Gaussian

2) External Source

When you select external source for the modulation, modulating shape and frequency items don't show on the parameter list and the carrier is modulated by external waveform. Phase Deviation is controlled by $\pm 5V$ signal level present on external analog input (**Modulation In**) connector on the rear panel. For instance, phase deviation in the parameter list is set to 180%, when external modulation signal +5V is applied, PM deviation will

be 180°, for external signal with lower level, the deviation will be smaller.

Setting Modulating Waveform Frequency

Modulating frequency is available to set up when you select internal modulating source. With PM enabled, the modulating frequency is 100Hz by default. To change the frequency, switch on PM interface, use the multipurpose knob and arrow buttons or press **Params**→**ModFreq** softkeys to select between 2mHz~50kHz. If the source is chosen externally, modulating shape and modulating frequency options don't show on the parameter list, and the carrier is modulated by an external waveform at a frequency from 0Hz~20 kHz.

Setting Phase Deviation

Phase deviation represents variation of the phase of PM modulated waveform from the carrier phase. PM phase deviation can be settable from 0°~360°.

The default is at 180°, To modify the parameter, turn on PM interface, use multipurpose knob and arrow buttons or press **Params**→**PhaseDev** to change.

Applications

First of all, please enable PM mode of the Generator. To set a 200Hz sinewave from internal source as modulating signal, to set a sinewave with an amplitude of 100mVpp at 900Hz as the carrier and phase deviation at 200°, please follow steps as below:

1) Enabling PM Function

Press **Menu**→**Mod**→**Type**→**PM** (if **Type** label is not highlighted, press **Type** softkey again to select) to switch on PM function.

UTG2000A user manual

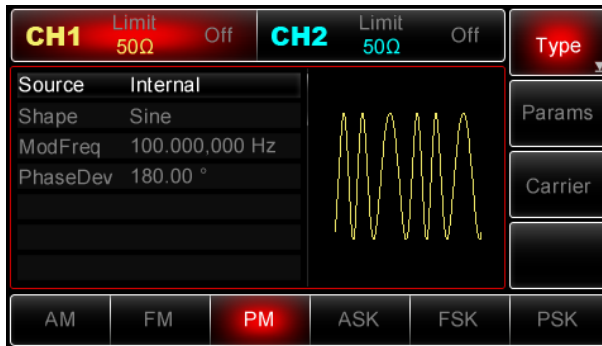

2) Setting Modulating Waveform Parameters

With PM function switched enabled above, use multipurpose knob and arrow buttons to complete the setup or you can press **Params** in the interface above to pop up the display as below:

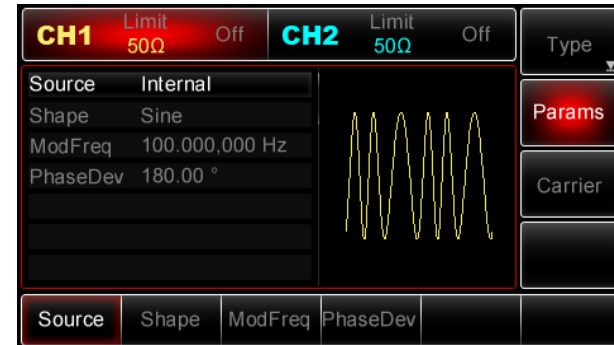

To set desired parameter, press corresponding softkey, then enter in desired value and select the unit as required.

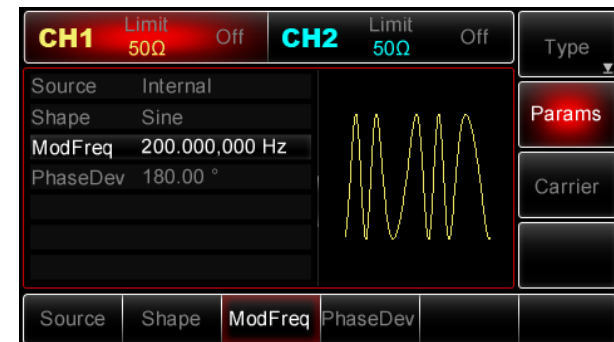

3) Setting Carrier Parameters

Press **Carrier** → **Type** → **Sine** (If **Type** label is not highlighted, press **Type** softkey again to select) to select sinewave as carrier shape. The default is sinewave, so in this case, there is no need to modify.

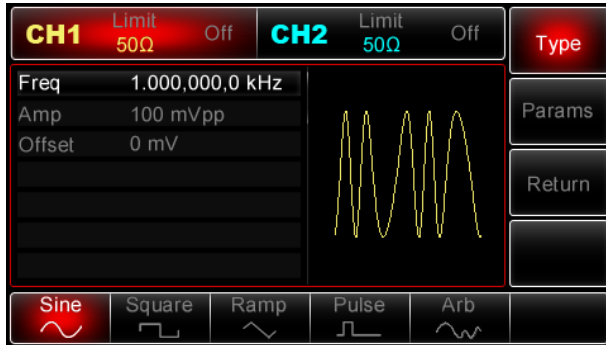

Use multipurpose knob and arrow buttons to complete the setup or you can also press **Params** in the interface above to pop up the display as below (compared with FM, PM parameter list doesn't have Phase option):

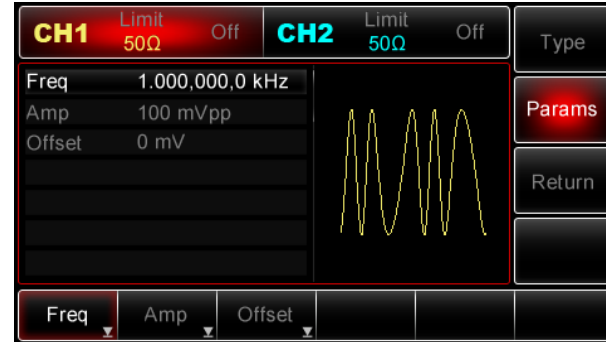

To set desired parameter, press the corresponding softkey, then enter in desired value and select the unit as required.

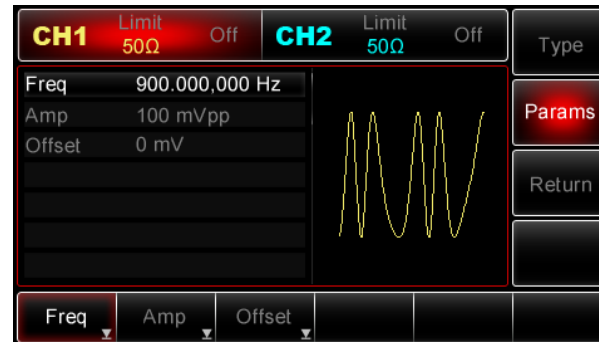

UTG2000A user manual

4) Setting Phase Deviation

With the carrier setup finished, press **Return** softly to return to the following interface and then set phase deviation.

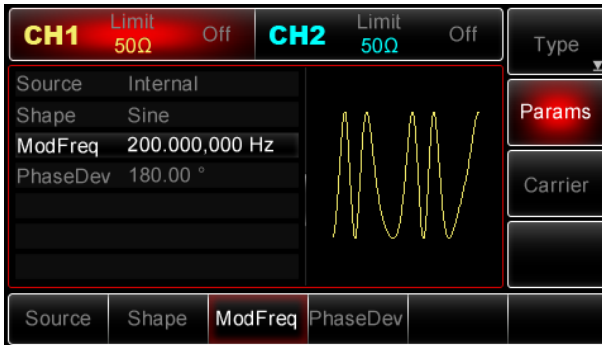

Use multipurpose knob and arrow buttons to complete the setup, or you can also press **Params** → **PhaseDev** softkeys, then key in 200 using numeric keypad and press **°** softkey to finish the setting.

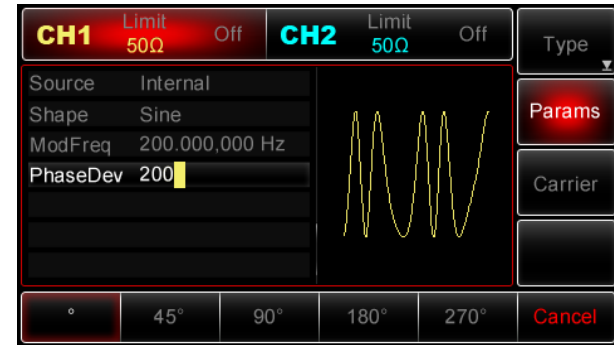

5) Enabling Channel Output

Press **CH1** button on the front panel to switch on CH1 output directly, or you can press **Utility** → **Ch1 Setting** to enable the output. With CH1 output enabled, **CH1** button is illuminated and “ Off ” in grey and to the right of CH1 label changes into “ Mod ” in yellow, indicating CH1 output has been enabled.

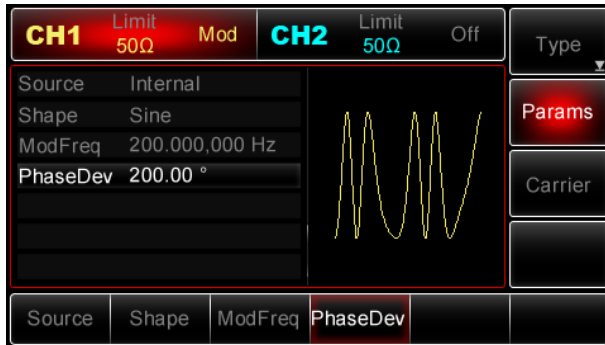

View PM modulated waveform with use of an Oscilloscope shown as below:

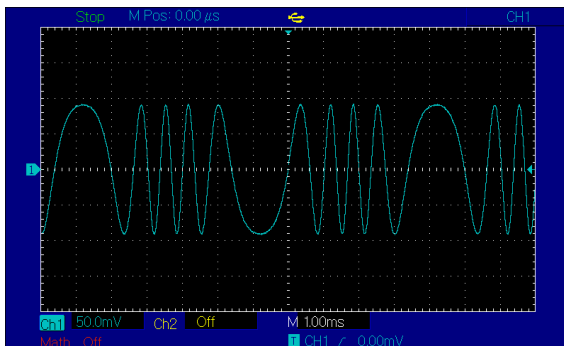

Amplitude-Shift Keying(ASK) Modulation

In ASK, the amplitude variation applied on the carrier signal can reflect the state of digital signal “0” and “1”. The high/low logic of modulating signal controls the output of carrier signal in different amplitude. CH1 and CH2 of the Generator can be modulated independently with modulation types applied the same or differently.

Selecting ASK

Press **Menu**→**Mod**→**Type**→**ASK** to enable ASK function(If **Type** label is not highlighted, press **Type** softkey again to select), with ASK enabled, the Generator will output the modulated waveform according to current settings of ASK rate and the carrier .

UTG2000A user manual

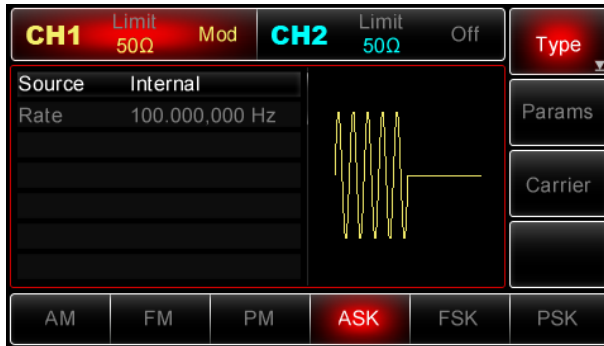

Selecting the Carrier

The ASK carrier shape can be: sinewave, squarewave, ramp or arbitrary waveform (except DC). It is sinewave by default. When ASK is selected, press Carrier to access **carrier** waveforms to be chosen.

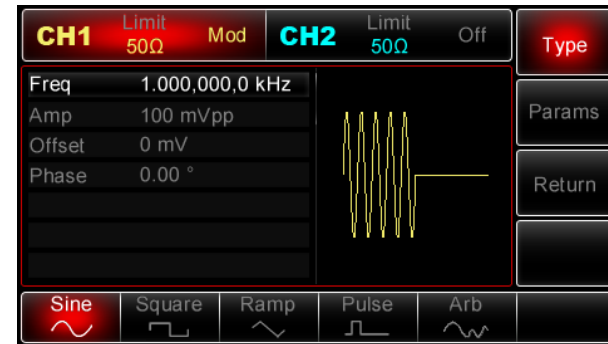

Setting Carrier Frequency

Carrier frequency ranges could be different and depend on different functions to be selected. The default is at 1kHz for all functions. Refer to the following table for details:

Functions	Frequency			
	UTG2062A		UTG2025A	
	Min. Value	Max. Value	Min. Value	Max. Value
Sine	1uHz	60MHz	1uHz	25MHz
Square	1uHz	25MHz	1uHz	5MHz
Ramp	1uHz	400kHz	1uHz	400KHz
Pulse	500uHz	25MHz	500uHz	5MHz
Arbitrary	1uHz	12MHz	1uHz	5MHz

To set the carrier frequency, please select the carrier waveform first and then use multipurpose knob and arrow buttons to set up the parameter or press **Params**→**Freq** softkeys, enter the desired frequency value and select the desired unit to complete the setting.

Selecting Modulating Source

UTG2000A Generator can offer an internal or external modulating source. With ASK enabled, the modulating source defaults at Internal. To modify the parameter, turn on ASK interface, turn the

multipurpose knob or press **Params**→**Source**→**Ext** softkeys to select.

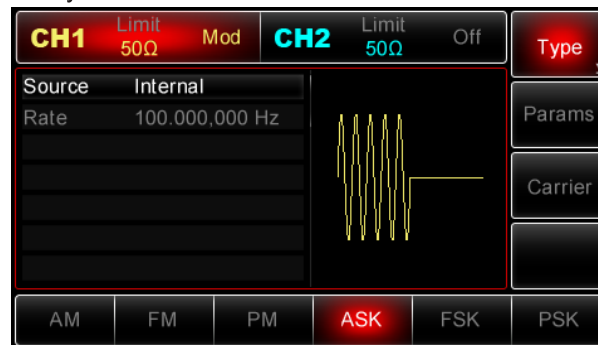

1) Internal Source

When you select internal modulating source, the modulating waveform is the squarewave (built-in and unchangeable) with 50% of duty cycle. You can change ASK rate to define the rate at which modulated waveform shifts

2) External Source

When you select external modulating source,

UTG2000A user manual

Rate option doesn't show on the parameter list and the carrier is modulated by an external waveform. ASK output amplitude is controlled by logic level present on external digital modulation (**FSK Trig**) connector on the rear panel. For instance, when low external logic level input is present, ASK output amplitude is current set carrier signal amplitude; when high external logic level input is present, ASK output amplitude is less than current set carrier signal amplitude.

Setting ASK Rate

ASK Rate is available to set up when you select internal modulating source. With ASK enabled, ASK Rate is 100Hz by default and is available to set up within 2mHz~100kHz. To change the parameter, switch on ASK interface first, then use the multipurpose knob and arrow buttons or press **Params**→**Rate** softkeys to select.

Applications

First of all, please switch on ASK mode of the Generator. To set a 300Hz logic signal as modulating signal from the Generator itself, and to set a sinewave with amplitude of 2Vpp at 15 kHz as the carrier, follow steps as below:

Note: Logic signal is determined by the internal rate generator, and you can only set up its frequency in order to change ASK rate, actually this frequency represents the rate at which the output shifts.

1) Enabling ASK

Press **Menu**→**Mod**→**Type**→**ASK** (if **Type** label is not highlighted, press **Type** softkey again to select) to switch on ASK function.

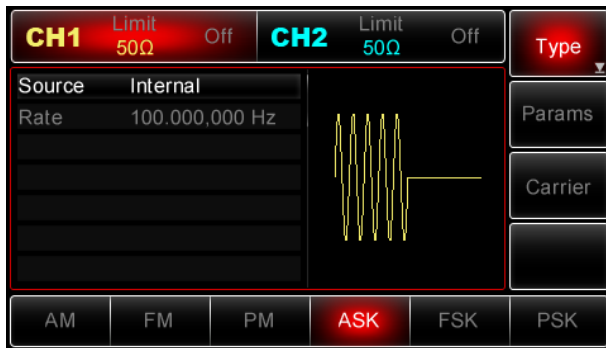

2) Setting Carrier Parameters

Press **Carrier** → **Type** → **Sine** (If **Type** label is not highlighted, press **Type** softkey again to select) to select the sinewave as the carrier shape. Since the default is sine, so there is no need to modify in this case.

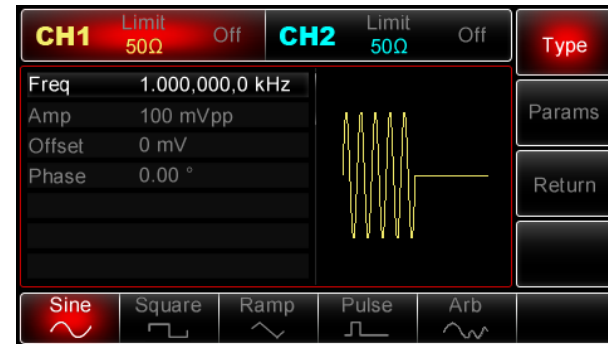

Use multipurpose knob and arrow buttons to complete the setup or you can also press **Params** in the interface above to pop up the display as below:

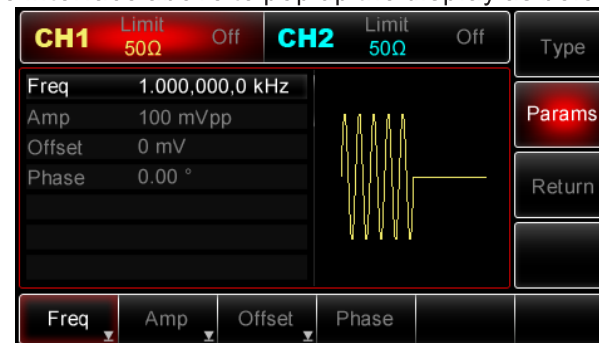

UTG2000A user manual

To set desired parameter, press the corresponding softkey, then enter in desired value and select the unit as required.

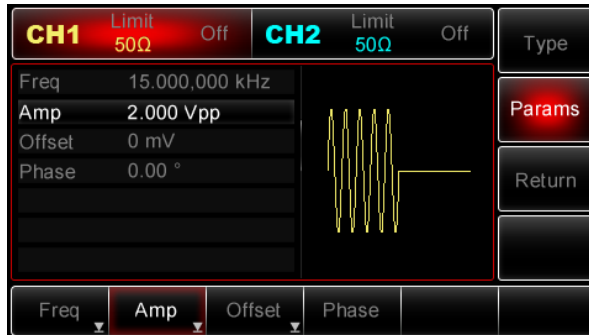

3) Setting ASK Rate

With the carrier setup finished, press **Return** softkey to return to the following interface and then set ASK rate

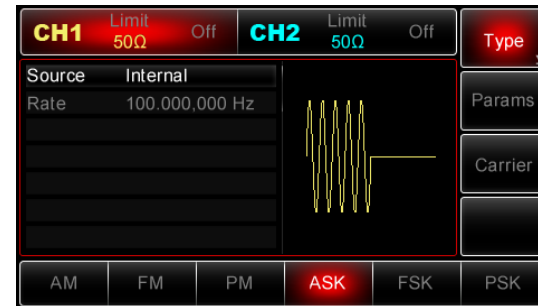

Use multipurpose knob and arrow buttons to complete the setup, or you can also press **Params** → **Rate** softkeys, then enter in 300 using numeric keypad and press **Hz** softkey to set ASK rate.

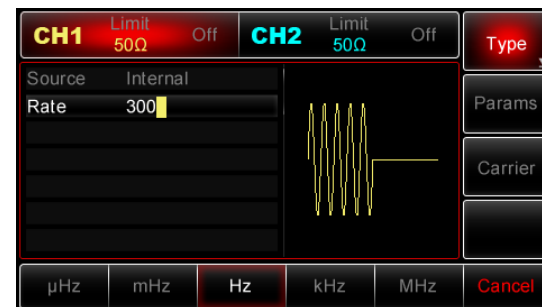

4) Enabling Channel Output

Press **CH1** button on the front panel to switch on CH1 output directly, or you can press **Utility** → **CH1 Setting** to enable the output. With CH1 output enabled, **CH1** button is illuminated and “Off” in grey and to the right of CH1 label changes into “Mod” in yellow, indicating CH1 output has been enabled.

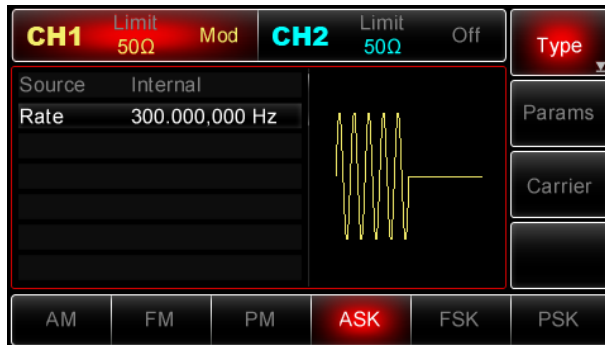

Views ASK modulated waveform with use of an Oscilloscope shown as below:

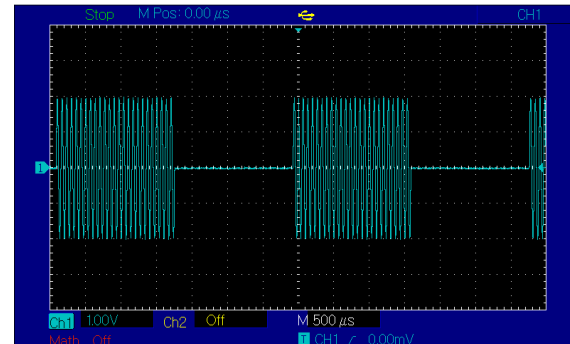

Frequency-Shift Keying(FSK)Modulation

In FSK, the Generator output shifts between two preset frequency values (carrier frequency and hop frequency). The logic high/low level determines to output the carrier frequency or hop frequency. CH1 and CH2 of the Generator can be modulated independently with modulation types applied the same or differently

UTG2000A user manual

Selecting FSK

Press **Menu** → **Mod** → **Type** → **FSK** to enable FSK function (If **Type** label is not highlighted, press **Type** softkey again to select), with FSK enabled, the Generator will output the modulated waveform according to current settings.

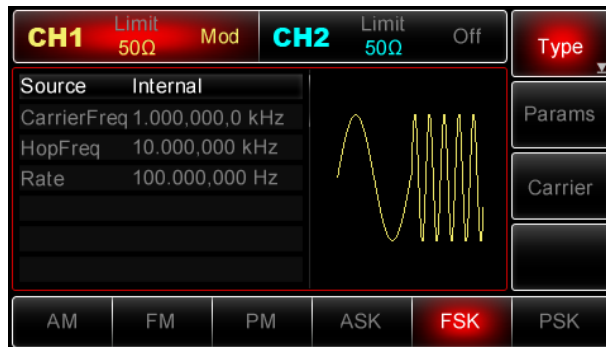

Selecting the Carrier

FSK carrier shape can be: sinewave, squarewave, ramp or arbitrary waveform (except DC). It is sine by default. When FSK is selected, press **Carrier** to access carrier waveforms to be chosen.

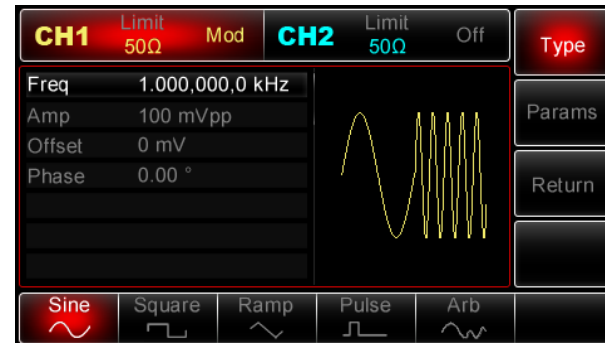

Setting Carrier Frequency

Carrier frequency ranges could be different and depend on different functions to be selected. The default is at 1kHz for all functions. Refer to the following table for details:

Functions	Frequency			
	UTG2062A		UTG2025A	
	Min.Value	Max. Value	Min.Value	Max. Value
Sine	1uHz	60MHz	1uHz	25MHz
Square	1uHz	25MHz	1uHz	5MHz
Ramp	1uHz	400kHz	1uHz	400KHz
Pulse	500uHz	25MHz	500uHz	5MHz
Arbitrary	1uHz	12MHz	1uHz	5MHz

To set the carrier frequency, please select the carrier waveform first, and then use multipurpose knob and arrow buttons to set up the parameter or press **Params** → **Freq** softkeys, enter the desired frequency value and select the desired unit to finish the setting. If current carrier waveform is exactly what you need, you just need to set up carrier frequency and make the input more directly and flexibly.

Selecting Modulating Source

UTG2000A Generator can offer an internal or external modulating source. With FSK enabled, the modulating source defaults at Internal. To modify the parameter, switch on FSK interface, turn the multipurpose knob or press **Params** → **Source** → **Ext** softkeys to select.

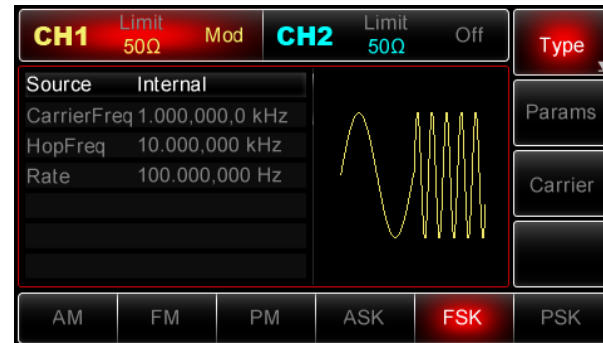

UTG2000A user manual

1) Internal Source

When you select internal modulating source, the modulating waveform is squarewave (built-in and unchangeable) with 50% of duty cycle. You can change FSK rate to specify the rate at which modulated waveform shifts between the carrier frequency and hop frequency.

2) External Source

When you select external modulating source, Rate option doesn't show on the parameter list and the carrier is modulated by an external waveform. The output frequency is controlled by logic level present on external digital modulation (**FSK Trig**) connector on the rear panel. For instance, when logic low level is present, carrier frequency is output; with a logic high level, hop frequency is output.

Setting Hop Frequency

With FSK enabled, the hop frequency is 10 kHz

by default. To modify the parameter, turn on FSK interface first, then use multipurpose knob and arrow buttons or press **Params** → **HopFreq** to select. Hop frequency ranges depend on the function selected, please refer to the following table for details:

Functions	Frequency			
	UTG2062A		UTG2025A	
	Min. Value	Max. Value	Min. Value	Max. Value
Sine	1uHz	60MHz	1uHz	25MHz
Square	1uHz	25MHz	1uHz	5MHz
Ramp	1uHz	400kHz	1uHz	400KHz
Pulse	500uHz	25MHz	500uHz	5MHz
Arbitrary	1uHz	12MHz	1uHz	5MHz

Setting FSK Rate

ASK Rate, at which the output shifts between the carrier frequency and hop frequency, is available to set up when you select internal modulating source. With FSK enabled, ASK Rate defaults at 100Hz and

ranges from 2mHz~100kHz. To change the parameter, switch on FSK interface, use the multipurpose knob and arrow buttons or press **Params**→**Rate** softkeys to select.

Note: Enable FSK function first before modifying FSK rate, press **Menu**→**Mod**→**Type**→**FSK** (If **Type** label is not highlighted, press **Type** softkey again to select) to enable FSK mode.

Applications

First of all, please enable ASK mode of the Generator. To set a sinewave at 2kHz and 1Vpp as the carrier, to set hop frequency at 800Hz and the rate at 200Hz that's used to shift between carrier frequency and hop frequency, follow steps as shown below:

1) Enabling FSK Function

Press **Menu**→**Mod**→**Type**→**FSK** (if **Type** label is not highlighted, press **Type** softkey again to select)

to switch on FSK function.

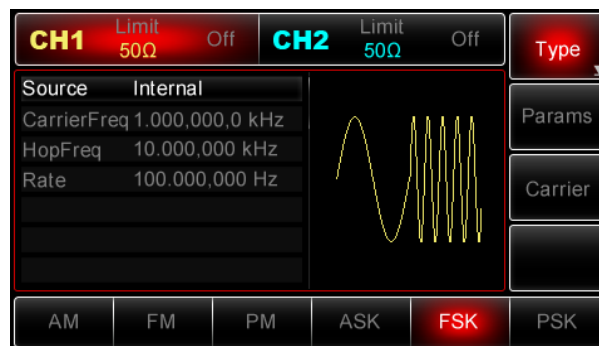

2) Setting Carrier Parameters

Press **Carrier**→**Type**→**Sine** (If **Type** label is not highlighted, press **Type** softkey again to select) to select the sinewave as the carrier shape. Since the default is sine, so there is no need to modify in this case.

UTG2000A user manual

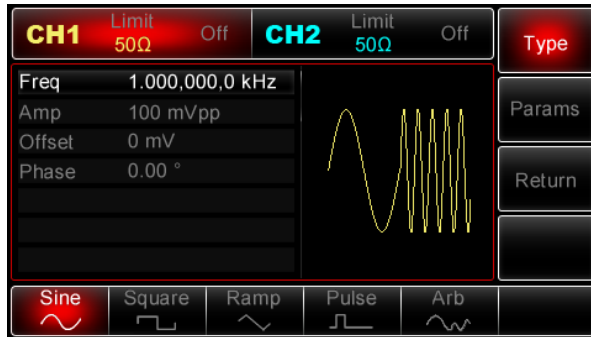

Use multipurpose knob and arrow buttons to complete the setup or you can also press **Params** in the interface above to pop up the display as below:

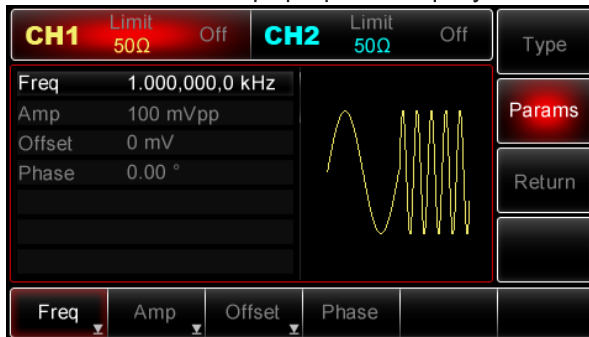

To set desired parameter, press the corresponding softkey, then enter in desired value and select the unit as required.

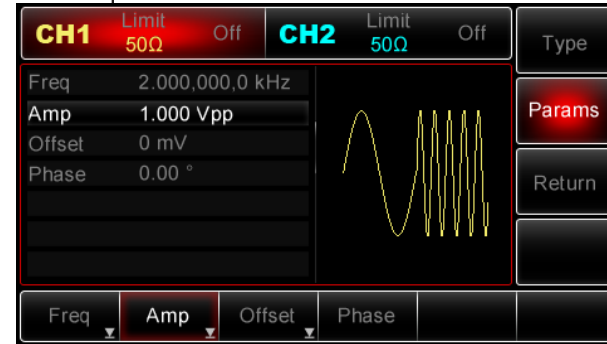

3) Setting Hop Frequency and FSK Rate

With the carrier setup finished, press **Return** softkey to return to the following interface:

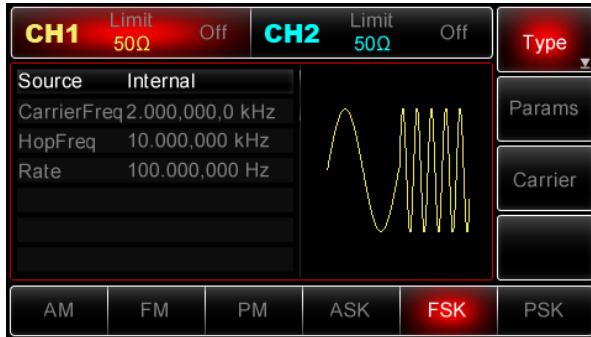

Use multipurpose knob and arrow buttons to complete the setup, or you can also press **Params** softkey to pop out the interface as follows:

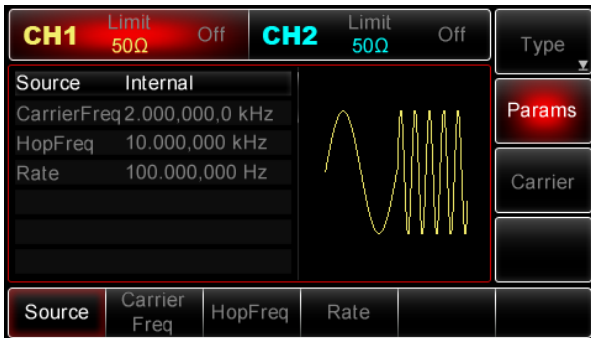

To set desired parameter, press the corresponding softkey, then enter in desired value and select the unit as required.

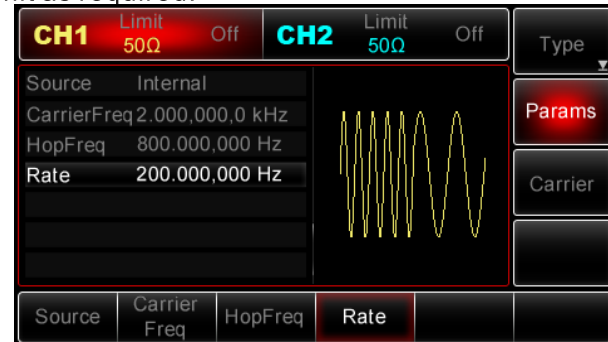

4) Enabling Channel Output

Press **[CH1]** button on the front panel to switch on CH1 output directly, or you can press **Utility** → **CH1Setting** to enable the output. With CH1 output enabled, **[CH1]** button is illuminated and “Off” in grey and to the right of CH1 label changes into “Mod” in yellow, indicating CH1 output has been enabled.

UTG2000A user manual

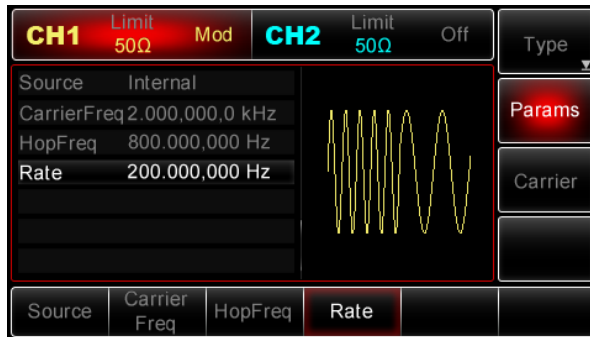

View FSK modulated waveform with use of an Oscilloscope as shown below:

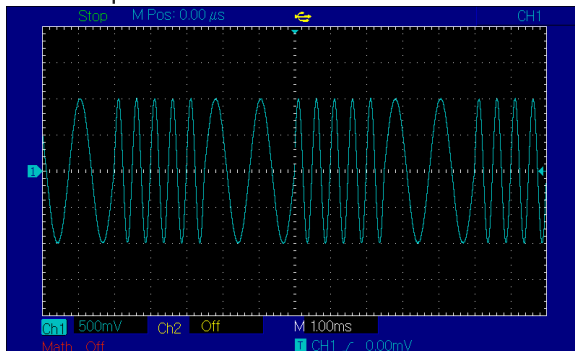

Phase-Shift Keying(PSK) Modulation

In PSK, you can configure the Generator to shift the output phase between present phase values (carrier phase and modulating phase). The logic high/low level of modulating signal determines to output the carrier/modulating phase. CH1 and CH2 of the Generator can be modulated independently with modulation types applied the same or differently.

Selecting PSK

Press **Menu** → **Mod** → **Type** → **PSK** to enable PSK function (If **Type** label is not highlighted, press **Type** softkey again to select), with PSK enabled, the Generator will output the modulated waveform according to the phase of current carrier (default at 0° and unadjustable) and modulating phase.

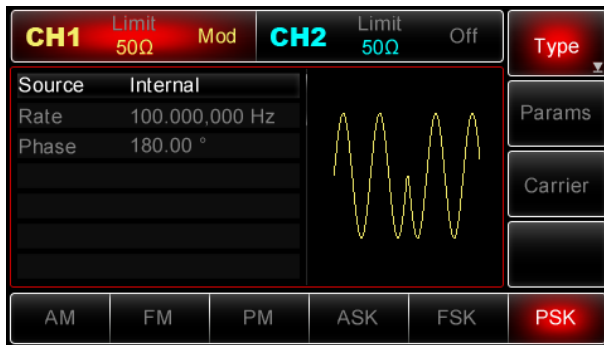

Selecting the Carrier

The PSK carrier shape can be: sinewave, squarewave, ramp or arbitrary waveform (except DC). It is sine by default. When ASK is selected, press **Carrier** to access carrier waveforms to be chosen.

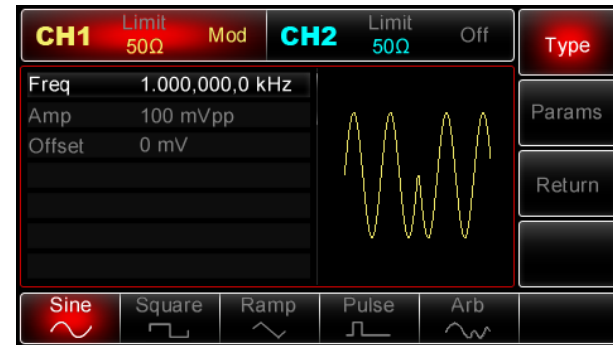

Setting Carrier Frequency

Carrier frequency ranges could be different and depend on different functions to be selected. The default is at 1kHz for all functions. Refer to the following table for details:

Functions	Frequency			
	UTG2062A		UTG2025A	
	Min.Value	Max. Value	Min.Value	Max. Value
Sine	1uHz	60MHz	1uHz	25MHz
Square	1uHz	25MHz	1uHz	5MHz
Ramp	1uHz	400kHz	1uHz	400kHz
Pulse	500uHz	25MHz	500uHz	5MHz
Arbitrary	1uHz	12MHz	1uHz	5MHz

To set the carrier frequency, please select the carrier waveform first, and then use multipurpose knob and arrow buttons to set up the parameter or press **Params**→**Freq** softkeys, enter the desired frequency value and select the desired unit to finish the setting.

Selecting Modulating Source

UTG2000A Generator can offer an internal or external modulating source. With PSK enabled, the modulating source defaults at Internal. To modify the parameter, turn on PSK interface first, turn the multipurpose knob or press **Params**→**Source**→**Ext** softkeys to select

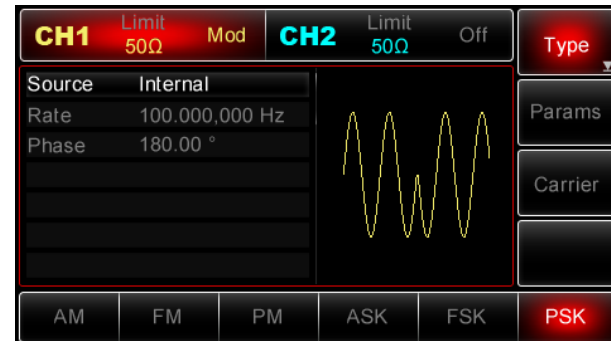

UTG2000A user manual

1) Internal Source

When internal source is selected, internal modulating signal is the squarewave (built-in and unadjustable) with 50% duty cycle. You can modify PSK rate to define the frequency at which the output shifts between carrier phase and modulating phase.

2) External Source

When you select external modulating source, Rate option doesn't show on the parameter list and the carrier is modulated by an external waveform. PSK output phase is controlled by logic level present on external digital modulation (**FSK Trig**) connector on the rear panel. For instance, when logic low level is present, carrier phase is output; when logic high level is present, modulating phase is output.

Setting PSK Rate

PSK Rate is available to set up when you select internal modulating source. With PSK enabled, PSK

Rate is 100Hz by default and ranges from 2mHz~100kHz. To change the parameter, switch on PSK interface first, then use the multipurpose knob and arrow buttons or press **Params**→**Rate** softkeys to finish the setting.

Setting Modulating Phase

Modulating Phase represents the phase variation of shifted waveform from carrier waveform. It ranges from 0°~360° and defaults at 180°. To modify the parameter, switch on PSK interface, then use multipurpose knob and arrow buttons or press **Params**→**Rate** softkeys to finish the setting.

Applications

First of all, please switch on PSK mode of the Generator. To set up a sinewave at 2kHz and 2Vpp as the carrier from the Generator itself, and PSK rate 1kHz at which the output shifts between carrier phase and modulating phase, please follow steps as shown below:

1) Enabling PSK

Press **Menu**→**Mod**→**Type**→**PSK** (if **Type** label is not highlighted, press **Type** softkey again to select) to switch on PSK function.

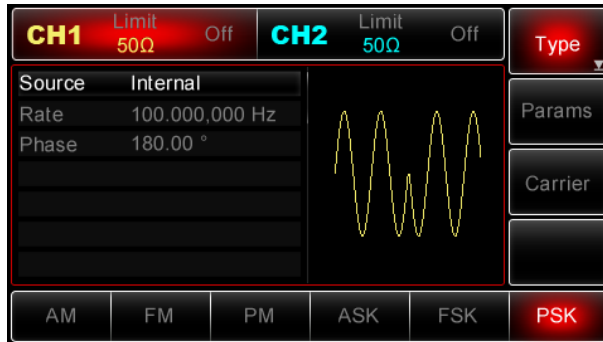

2) Setting Carrier Parameters

Press **Carrier**→**Type**→**Sine** (If **Type** label is not highlighted, press **Type** softkey again to select) to select the sinewave as the carrier shape. Since the default is sine, so there is no need to modify in this case.

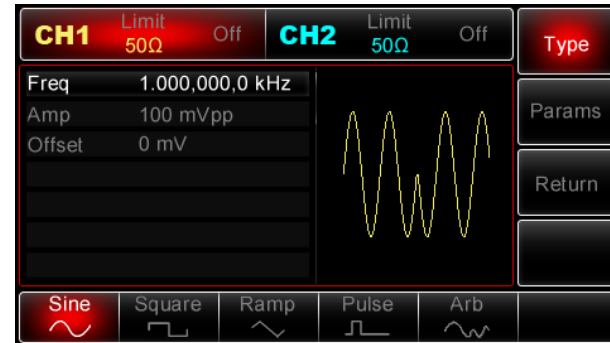

Use multipurpose knob and arrow buttons to complete the setup, or you can also press **Params** in the interface above to pop up the display as below:

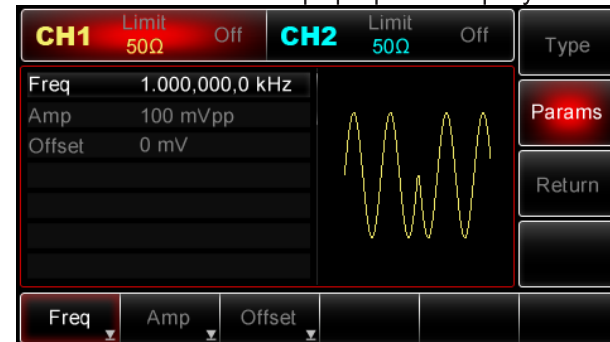

To set desired parameter, press the corresponding softkey, then enter in desired value and select the unit as required.

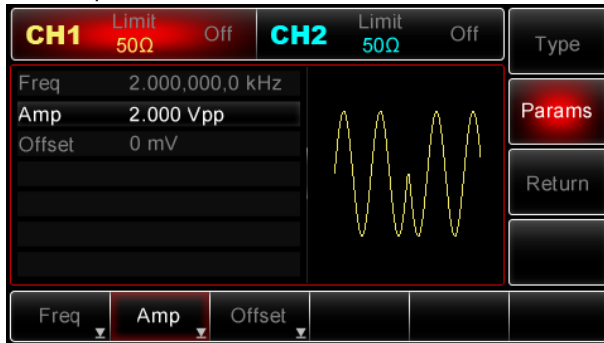

3) Setting PSK Rate and Modulating Phase

With the carrier setup finished, press **Return** softkey to return to the following interface.

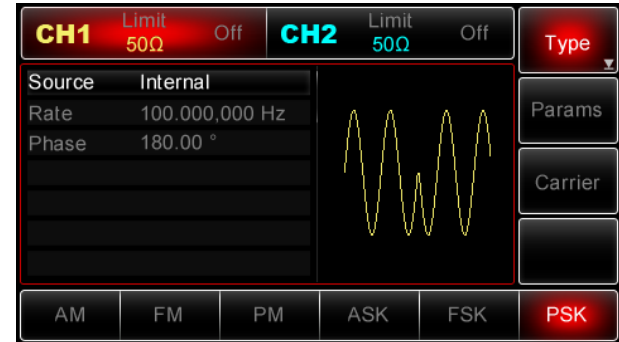

Use multipurpose knob and arrow buttons to complete the setup, or you can also press **Params** to pop up the following interface:

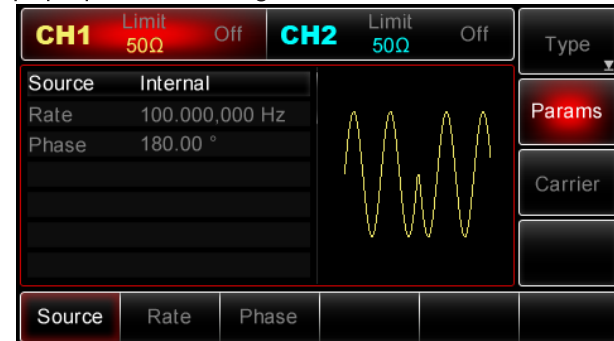

To set desired parameter, press the corresponding softkey, then enter in desired value and select the unit as required.

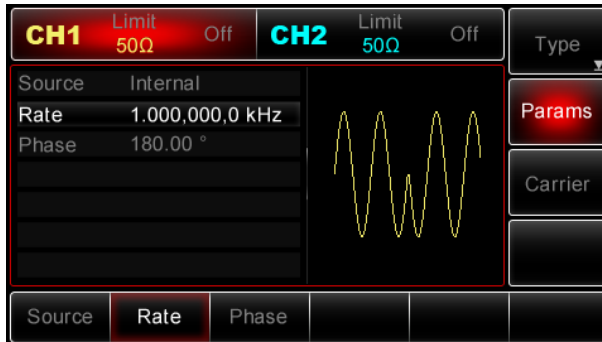

4) Enabling Channel Output

Press **[CH1]** button on the front panel to switch on CH1 output directly, or you can press **[Utility]** → **[CH1Setting]** to enable the output. With CH1 output enabled, **[CH1]** button is illuminated and “Off” in grey and to the right of CH1 label changes into “Mod” in yellow, indicating CH1 output has been enabled.

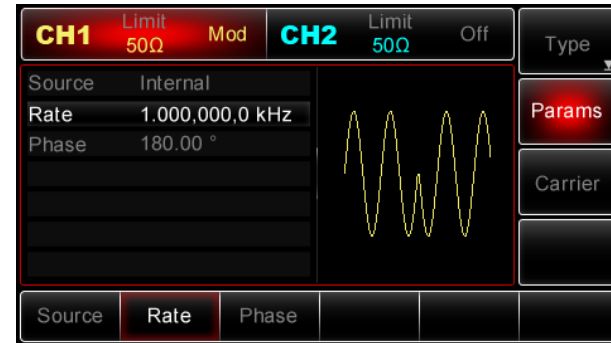

View PSK modulated waveform with use of an Oscilloscope shown as below:

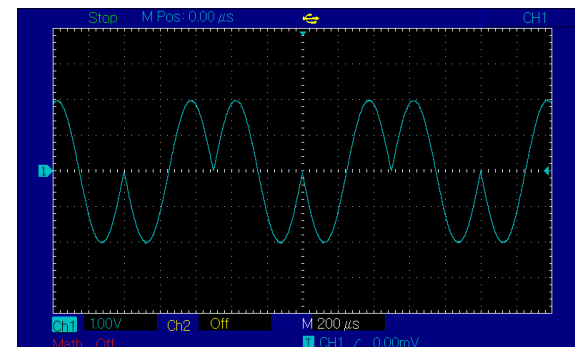

Pulse Width Modulation(PWM)

In PWM, modulated waveform consists of the carrier and modulating waveform. Pulse Width of the carrier is varied by the changing amplitude of modulating waveform. CH1 and CH2 of the Generator can be modulated independently with modulation types applied the same or differently

Selecting PWM

Press **Menu** → **Mod** → **Type** → **PWM** to enable PWM function (If **Type** label is not highlighted, press **Type** softkey twice in order to access next screen). With PWM enabled already, the Generator will output the modulated waveform according to current settings of modulating waveform and the carrier.

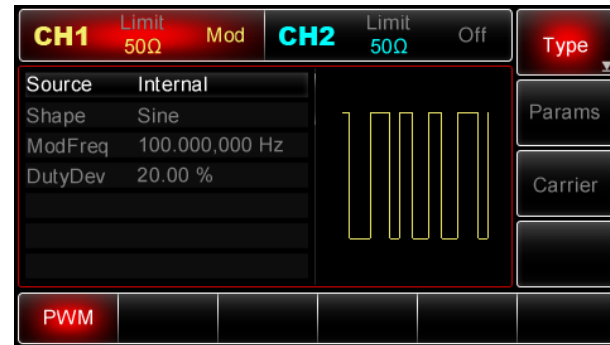

Carrier Waveform

PWM carrier can choose pulse waveform only. When PWM is selected, press **Carrier** to access carrier waveforms selection interface, **Pulse** label is automatically chosen.

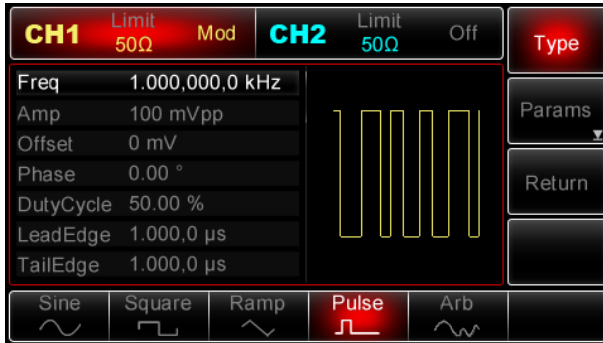

Setting Carrier Frequency

The frequency of pulse waveform ranges from 500uH~25MHz and defaults at 1kHz. To set the parameter, press **Carrier** softkey to pop up corresponding interface, then use multipurpose knob&arrow buttons to complete setup, or press **Params**→**Freq** softkeys and then enter desired value, select desired unit to finish the setting.

Setting Carrier Duty Cycle

Duty cycle of pulse waveform can be set from

0.01%~99.99% and defaults at 50%. To set up the duty cycle of the carrier, press **Carrier** softkey to pop up corresponding interface, then use multipurpose knob&arrow buttons to complete setup, or press **Params**→**DutyCycle** softkeys and then enter desired value, select desired unit to finish the setting.

Selecting Modulating Source

UTG2000A Generator can offer an internal or external modulating source. With PWM enabled, the modulating source defaults at Internal. To modify the parameter, turn the multipurpose knob after switching on PWM interface or Press **Params**→**Source**→**Ext** softkeys to select.

Note: Enable PWM function first before selecting modulating source. Press **Menu**→**Mod**→**Type**→**PWM** (If **Type** label is not highlighted, press **Type** softkey twice in order to access next screen display) to switch on PWM function.

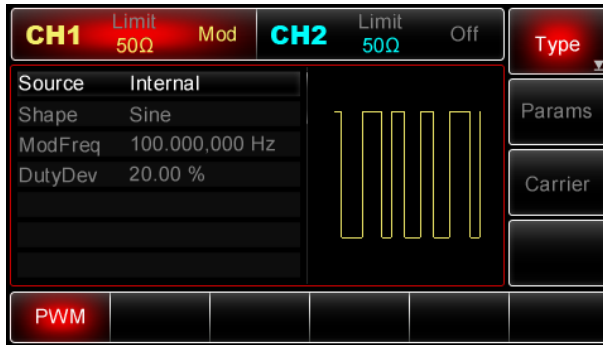

1) Internal Source

When you select internal source, modulating waveform can be: sine, square, upramp, downramp arbitrary, noise. The default is sine. So after PWM is enabled, the modulating shape defaults at sine. To modify the parameter, turn on PWM interface, then turn the multipurpose knob or press **Params**→**Shape** softkeys to select.

- Square: 50% Duty Cycle

- UpRamp: 100% Symmetry
- DownRamp: 0% Symmetry
- Arbitrary: when arbitrary waveform is selected as the modulating shape, the waveform is automatically sampled and limited to 1kpts.
- Noise: White Gaussian

2) External Source

When you select external source, modulating shape and modulating frequency items don't show on the parameter list and the carrier is modulated by external waveform. PWM duty cycle deviation is controlled by $\pm 5V$ signal level present on external analog input (**Modulation In**) connector on the rear panel. For instance, duty cycle deviation in the parameter list is set to 15%, when external modulation signal +5V is applied, duty cycle of the carrier (Pulse waveform) will increase by 15%; the deviation will be smaller for external signal with lower level.

Setting Modulating Frequency

When internal source is selected, modulating frequency is available to set up. With PWM enabled, the modulating frequency is 100Hz by default. To modify the parameter, switch on PWM interface, then use multipurpose knob and arrow buttons or press **Params**→**ModFreq** to select. The modulating frequency range is 2mHz~50kHz. If external source is selected, modulating shape and modulating frequency don't show on the parameter, and the carrier (pulse) will be modulated by external waveform with a modulating frequency from 0Hz~20 kHz.

Setting Duty Cycle Deviation

Duty cycle deviation represents the variation in duty cycle of modulated waveform from duty cycle of current carrier. The deviation can be settable from 0%~49.99% and defaults at 20%. To modify the

parameter, switch on PWM interface, then use multipurpose knob and arrow buttons or press

Params→**DutyDev** to select

- Duty cycle deviation represents the variation of duty cycle of modulated waveform from duty cycle of the original pulse waveform. (expressed as a percentage)
- Duty cycle deviation can not exceed the duty cycle of current pulse waveform.
- Duty cycle deviation plus duty cycle of current pulse waveform $\leq 99.99\%$
- Duty cycle deviation is limited by the minimum value of duty cycle of pulse and the present edge time

Applications

First of all, please enable PM mode of the Generator. To set a 1kHz sinewave from the internal

generator as modulating signal; to use a pulse waveform with 2Vpp amplitude at a frequency of 10kHz , duty cycle at 50% and rising/falling time at 100ns for the carrier, and to set duty cycle deviation at 40%. Please follow steps as shown below:

1) Enabling PWM Function

Press **Menu**→**Mod**→**Type**→**PWM** (if **Type** label is not highlighted, press **Type** softkey twice to access next screen display) to switch on PWM function.

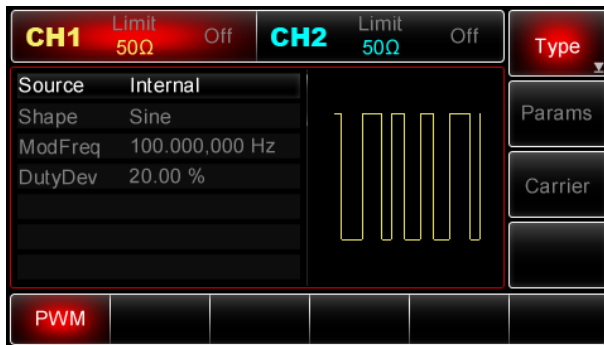

2) Setting Modulating Waveform Parameters

With PWM function enabled, use multipurpose knob and arrow buttons to complete the setup or you can also press **Params** in the interface above to pop up the display as below:

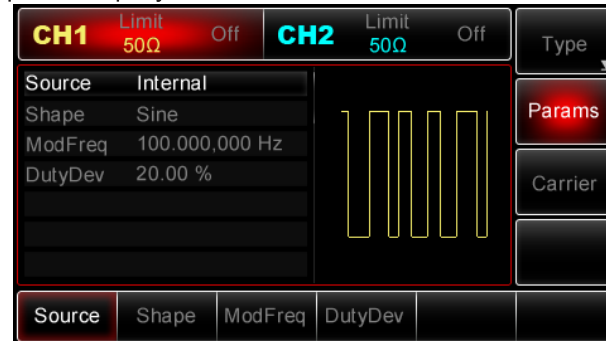

To set desired parameter, press corresponding softkey, then enter in desired value and select the unit as required.

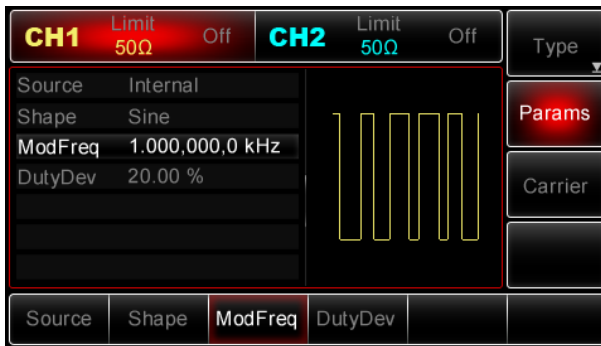

3) Setting Carrier Parameters

With PWM interface displayed, press **Carrier** softkey to access carrier parameter setting interface.

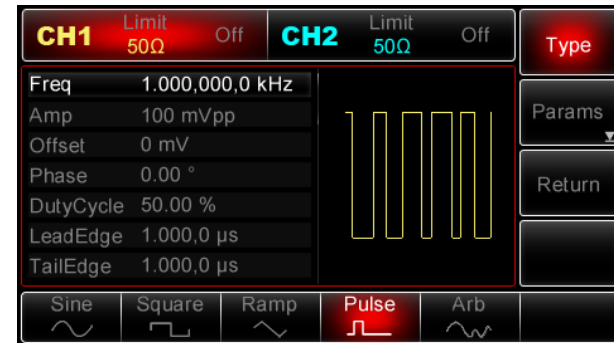

Use multipurpose knob and arrow buttons to complete the setup or you can also press **Params** in the interface above to pop up the display as below:

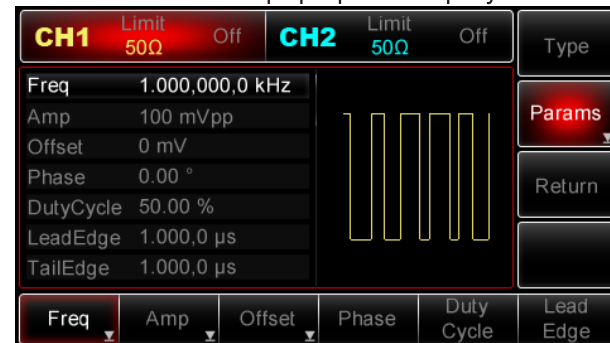

UTG2000A user manual

To set desired parameter, press corresponding softkey, then enter in desired value and select the unit as required.

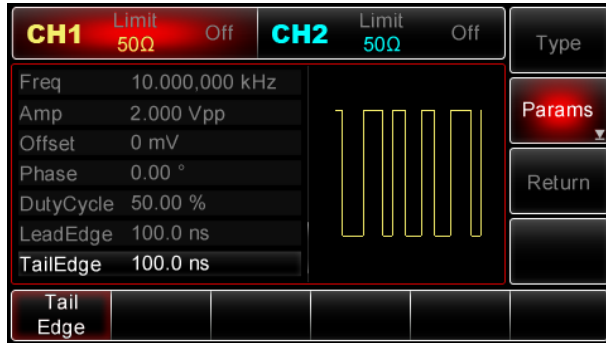

4) Setting Duty Cycle Deviation

With the carrier setup finished, press **Return** softkey to return to the following interface and then set duty cycle deviation.

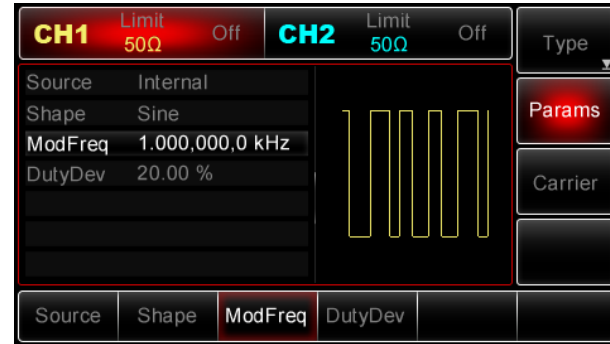

Use multipurpose knob and arrow buttons to complete the setup, or you can also press **Params** → **DutyDev** softkeys, then enter in 40 using numeric keypad and press **%** softkey to finish the setting.



View PWM modulated waveform with use of an oscilloscope as shown below:

5) Enabling Channel Output

Press **[CH1]** button on the front panel to switch on CH1 output directly, or you can press **[Utility]** → **CH1Setting** to enable the output. With CH1 output enabled, **[CH1]** button is illuminated and “Off” in grey and to the right of CH1 label changes into “Mod” in yellow, indicating CH1 output has been enabled.

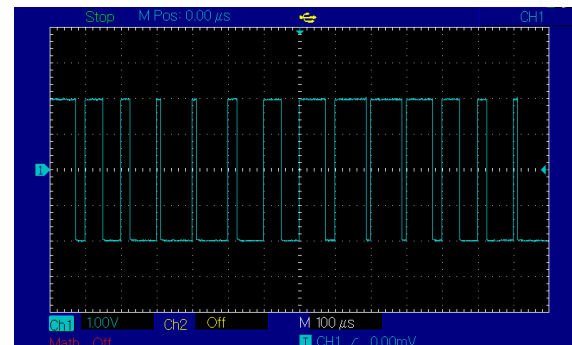

Outputting Frequency Sweep Waveforms

In Frequency Sweep, the Generator, within the specified sweep time, steps from start frequency to stop frequency with linear or logarithmic spacing. Internal, external and manual trigger source are available to select. The Generator can sweep Sine, square, ramp and arbitrary waveforms. Its CH1 and CH2 can be modulated independently with modulation types applied the same or differently.

Selecting Frequency Sweep

1) Enabling Frequency Sweep

Press **Menu** → **Sweep** to enable the Sweep function. With the function enabled, the Generator will output sweep waveform according to current settings.

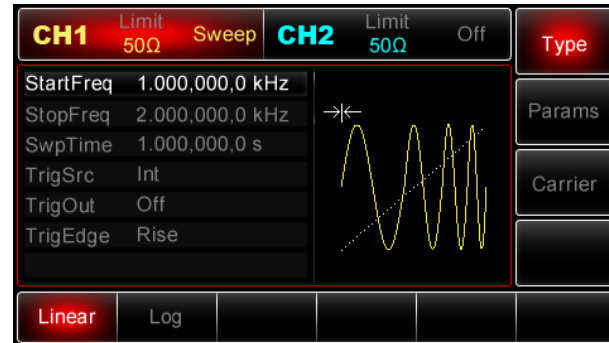

2) Selecting Sweep Waveforms

With Sweep enabled, press **Carrier** to access sweep waveforms and pop up interface shown as below:

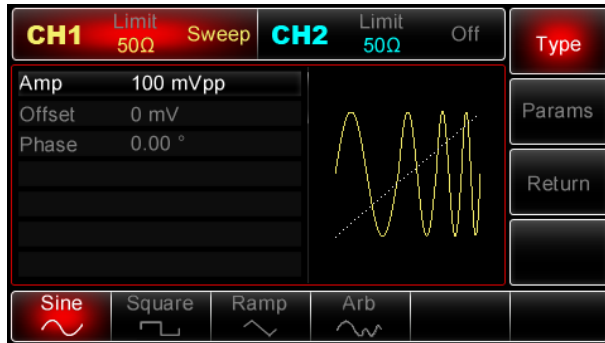

Start Frequency and Stop Frequency

The start frequency and stop frequency specify the high and low limits for frequency sweep. The Generator always moves from the start frequency to stop frequency, and returns to start frequency again. To set start frequency or stop frequency, press **Return** button to return to Sweep interface after finishing sweep waveform setup, then use multipurpose knob and arrow buttons to perform the setting or press **Params**→**StartFreq** to select, then

enter in the desired value using numeric keypad, press corresponding softkey to select desired unit and finish the setup.

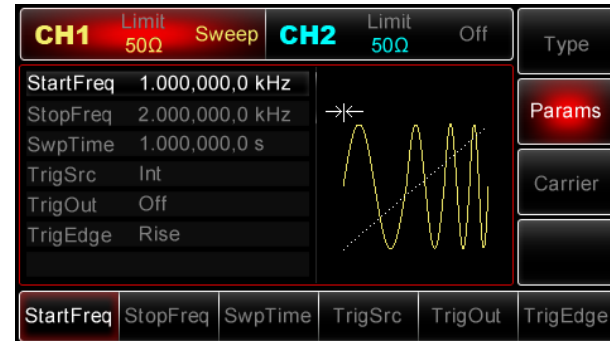

- Start frequency < Stop Frequency: the Generator sweeps up in frequency.
- Start frequency > Stop Frequency: the Generator sweeps down in frequency.
- Start frequency = Stop Frequency: the Generator outputs a fixed frequency.

UTG2000A user manual

- Syn signal for Sweep mode is kept high spacing from the start point to half of sweep time and becomes low from this middle point to the stop point at which the sweep time just elapses.

The default start frequency is 1kHz, and stop frequency defaults at 2kHz. Start frequency and stop frequency ranges depend on functions selected; refer to the following table for details:

Functions	Frequency			
	UTG2062A		UTG2025A	
	Min. Value	Max. Value	Min. Value	Max. Value
Sine	1uHz	60MHz	1uHz	25MHz
Square	1uHz	25MHz	1uHz	5MHz
Ramp	1uHz	400kHz	1uHz	400KHz
Pulse	500uHz	25MHz	500uHz	5MHz
Arbitrary	1uHz	12MHz	1uHz	5MHz

Sweep Mode

For linear sweep, the Generator varies the output frequency linearly during sweep; for logarithmic

sweep, the Generator varies the output frequency logarithmically during sweep. The default is linear. To modify the parameter, press **Type** → **Log** softkeys after switching on Sweep interface (If it is sweep waveform selection interface currently, press **Return** softkey first)

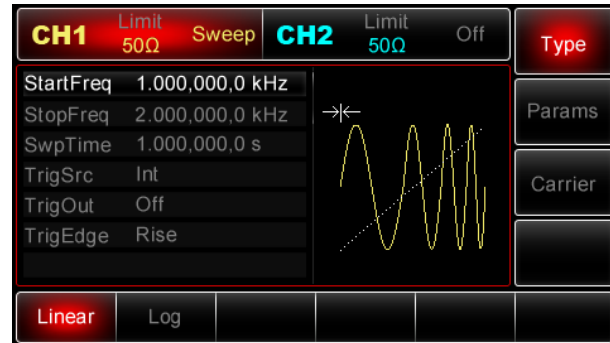

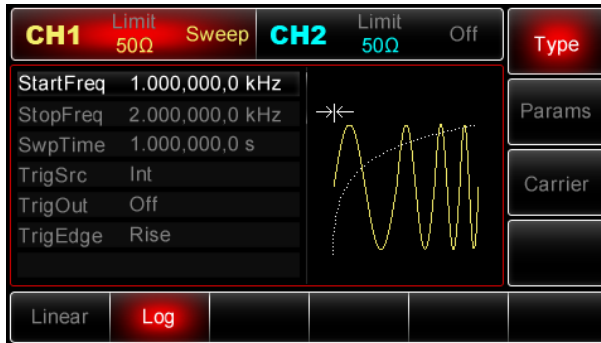

Sweep Time

It is the amount of time needed from start frequency to stop frequency. Sweep time defaults at 1s and is settable from 1ms~500s. To modify the parameter, enable Sweep interface, then use multipurpose knob and arrow buttons to set up or press **Params**→**SwpTime** to select, enter into desired value using numeric keypad, finally use softkeys to choose corresponding unit.

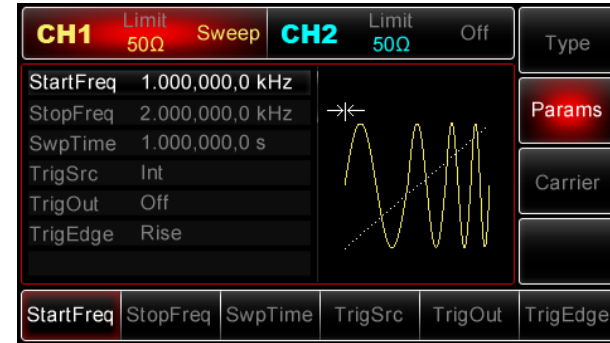

Trigger Source

The Generator will produce one sweep once it receives a trigger signal, and then wait for next trigger. There are internal, external or manual trigger sources available for your option. To change the parameter, switch on Sweep interface, then operate multipurpose knob together with arrow buttons or press **Params**→**TrigSrc** to complete the setup.

UTG2000A user manual

- 1) When internal triggering is selected, the Generator will output a continuous sweep at a rate determined by the sweep time.
- 2) When external triggering is selected, the Generator will accept a hardware trigger applied on external digital modulation connector (**FSK Trig**). Every time the Generator receives a polarized TTL pulse, it will enable a single sweep. **Note:** When you select external trigger source, trigger out option doesn't show in the parameter list, because trigger out is executed using **FSK Trig** connector which cannot be used as external trigger input and internal trigger output at the same time.
- 3) When manual triggering is selected, the Generator will output one sweep each time **Trigger** button is pressed down, and **Trigger** button on the front panel flashes.

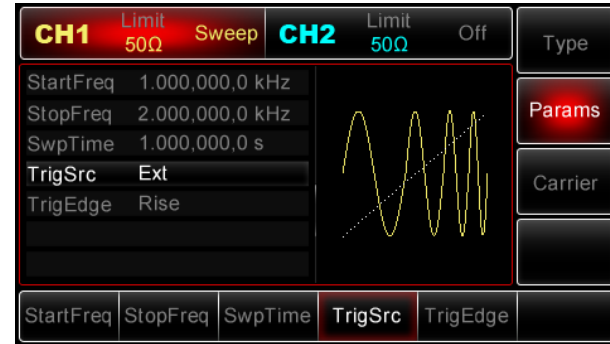

Trigger Out

When internal or manual trigger source is selected, the Generator outputs TTL-compatible signal (Squarewave). Trigger Out is “Off” by default. To change the parameter, enable sweep interface, then use multipurpose knob and arrow buttons or press **Params**→**TrigOut**→**On** to complete the setup.

- When internal trigger is selected, the Generator outputs a squarewave with 50% duty cycle from external digital modulation connector (FSK Trig) at

the start of the sweep. Trigger period is determined by specified sweep time.

- When manual trigger is selected, the Generator outputs a pulse with pulse width $> 1\mu\text{s}$ from external digital modulation connector (FSK Trig) at the start of the sweep.
- When external trigger is selected, Trigger Out option doesn't show on the parameter list, because Trigger Out is executed through external digital modulation connector (FSK Trig) which cannot function for both trigger input and output connector at the same time.

Trigger Edge

No matter external digital modulation connector (FSK Trig) is used as Trigger In or Out connector, the edge can be specified for both situations. When it is used as Trigger In connector (external trigger source is selected), “Rise” represents the Generator triggers

on the rising edge of external signal to output one sweep, and “Fall” indicates the Generator triggers on the falling edge of external signal. When it is used as Trigger Out connector (internal or manual trigger source is selected and Trigger Out is enabled), “Rise” means trigger signal with rising edge is output, and “Fall” is that trigger signal with falling edge is output.. It defaults at Rise. To modify the parameter, enable the sweep interface, then use multipurpose knob together with arrow buttons or press **Params** → **TrigEdge** → **Fall** to complete the setup

Applications

First of all, please enable Frequency Sweep function. To set a squarewave with 1Vpp amplitude and 50% duty cycle as the sweep waveform, sweep mode to linear, start frequency at 1kHz, stop frequency at 50kHz, sweep time for 2ms and to

UTG2000A user manual

trigger on rising edge of internal source, follow steps shown as below:

1) Enabling Frequency Sweep

Press **Menu** → **Sweep** → **Type** → **Linear** (if **Type** label is not highlighted, press **Type** softkey again to select) to switch on linear sweep function.

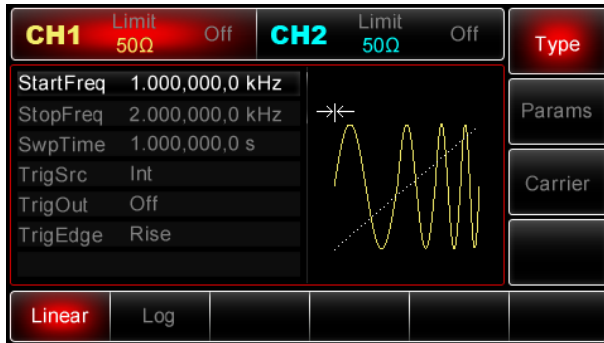

2) Selecting Sweep Waveforms

With linear sweep enabled, press **Carrier** → **Square** softkeys, and following interface pops up:

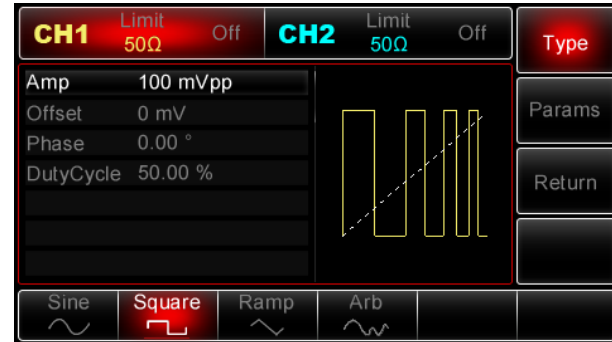

In this interface, use multipurpose knob and arrow buttons to set the amplitude, or you can also press **Params** to pop up the display as below:

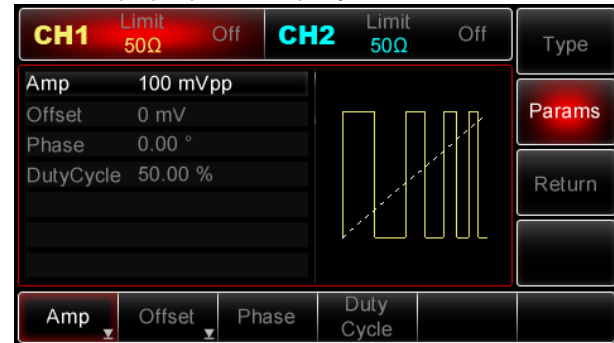

To set desired parameter, press corresponding softkey, then enter in desired value and select the unit as required.

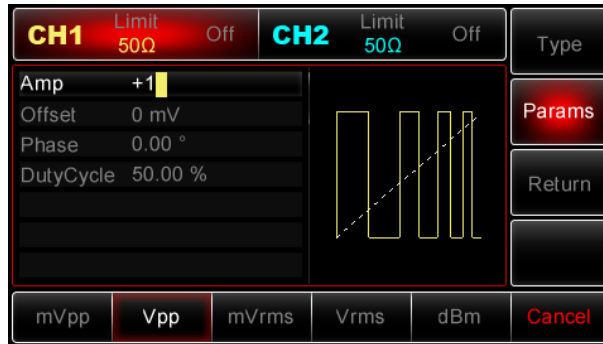

3) Setting Start/Stop Frequency, Sweep Time, Trigger Source and Trigger Edge

With sweep waveform and its parameters set up, press **Return** softkey to return to following interface:

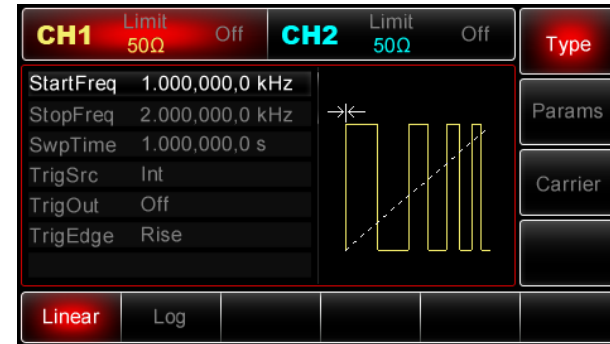

In the interface above, use multipurpose knob and arrow buttons to perform the setting, or you can also press **Params** to pop up the following interface:

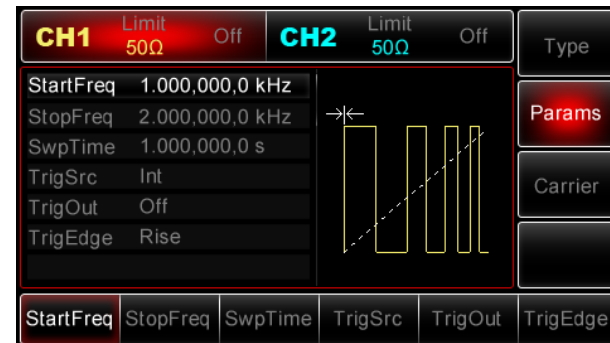

UTG2000A user manual

To set desired parameter, press corresponding softkey, then enter in desired value and select the unit as required.

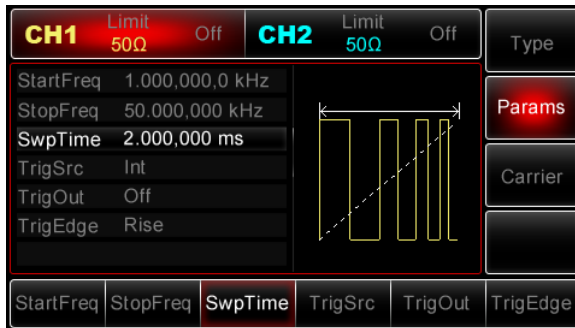

4) Enabling Channel Output

Press **CH1** button on the front panel to switch on CH1 output directly, or you can press **Utility** → **CH1Setting** to enable the output. With CH1 output enabled, **CH1** button backlight turns on and “Off” in grey and to the right of CH1 label changes into “Sweep” in yellow, indicating CH1 output has been enabled.

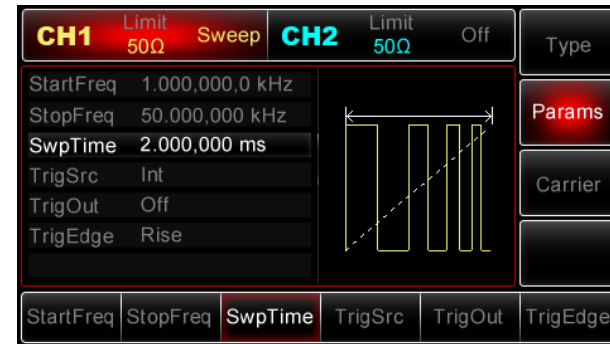

View sweep waveform with use of an Oscilloscope shown as below:

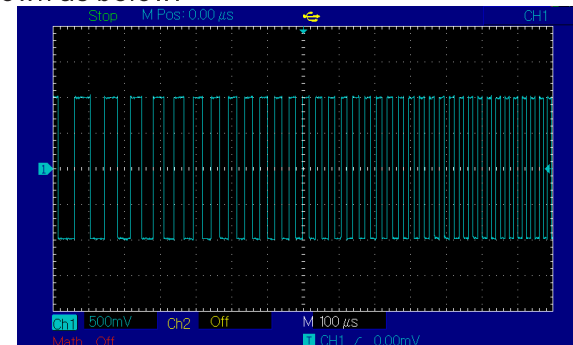

Outputting Burst Waveforms

The Generator can create a cycle-specified waveform (named “Burst”). Internal, manual and external triggerings are available to output the burst. There are three types of bursts: N-Cycle, Gated, and Infinite. The burst can be produced using sine, square, ramp, pulse, arbitrary (except DC) or noise (applicable for Gated type only) waveforms. CH1 and CH2 of the Generator can be modulated independently with modulation types applied the same or differently.

Selecting Burst

1) Enabling Burst Function

Press **Menu** → **Burst** to enable burst function, the Generator will output the burst according to current settings.

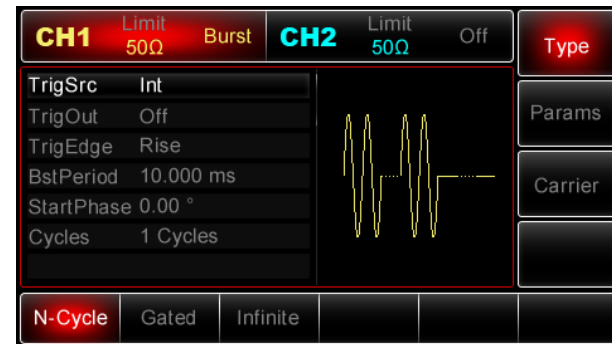

2) Selecting Waveforms

- N-Cycle Mode: Support sine, square, ramp, pulse, arbitrary (except DC).
- Gated Mode: Support sine, square, ramp, pulse, arbitrary (except DC) and noise.
- Infinite Mode: Support sine, square, ramp, pulse, arbitrary (except DC).

With burst function enabled, press **Carrier** softkey to select burst waveform, following interface pops out:

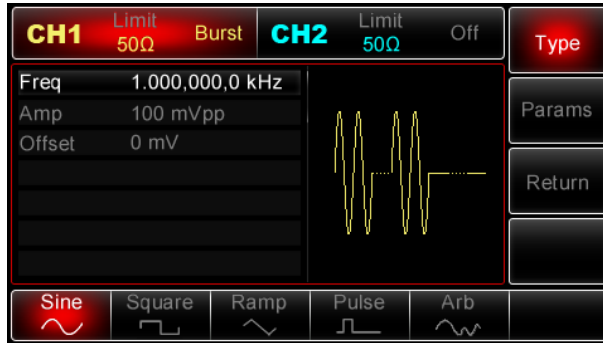

3) Setting Waveform Frequency

In N-Cycle and Gated Modes, waveform frequency defines the signal frequency during burst. In N-Cycle, burst is output with specified numbers of cycles at waveform frequency. In Gated mode, burst is output at waveform frequency when trigger signal is defined at high level.

Note: Waveform frequency is different from burst period, burst period is used to define the interval between specified bursts (for N-Cycle only). It

defaults at 1kHz for all functions, refer to following table for details:

Functions	Frequency			
	UTG2062A		UTG2025A	
	Min.Value	Max. Value	Min.Value	Max. Value
Sine	1uHz	60MHz	1uHz	25MHz
Square	1uHz	25MHz	1uHz	5MHz
Ramp	1uHz	400kHz	1uHz	400KHz
Pulse	500uHz	25MHz	500uHz	5MHz
Arbitrary	1uHz	12MHz	1uHz	5MHz

To set waveform frequency, please select the waveform first, and then use multipurpose knob and arrow buttons to set up the parameter or press **Params** → **Freq** softkeys, enter the desired frequency value and select the desired unit to finish the setting.

Burst Type

UTG2000A can output three types of bursts: N-Cycle, Gated and Infinite. It defaults at N-Cycle.

1) N-Cycle

Enable burst function, then press **Type**→**N-Cycle** softkeys to access N-Cycle mode(if you are in burst waveform selection interface currently, press **Return** softkey first). In N-Cycle mode, the Generator will output a waveform with specified number of cycles (Burst) every time it receives a trigger. After specified cycles are output, the Generator will stop and wait for next trigger. Internal, external or manual triggering source can be selected for burst output. To modify the source, enter into burst type interface (See the figure below), then use multipurpose knob and arrow buttons or press **Params**→**Source** softkeys to complete the setup.

Note: When external trigger source is selected, Trigger Out option doesn't show on the parameter list, because Trigger Out is executed through external digital modulation connector (FSK Trig)

which cannot function for trigger input and output connectors at the same time.

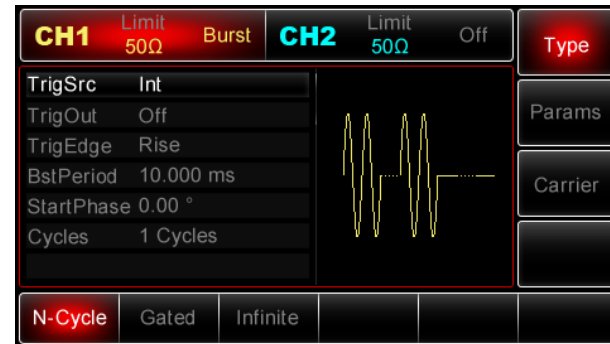

2) Gated Mode

Enable burst function, then press **Type**→**Gated** softkeys to access Gated mode(if you are in burst waveform selection interface currently, press **Return** softkey first). In Gated mode, Trigger Source, Trigger Out, Trigger Edge, Burst Period and Cycle Count options don't show on the parameter list. Since only external source can be applied, the

UTG2000A user manual

Generator will output based on the hardware trigger applied on external digital modulation connector (FSK Trig). When the polarity is set to positive and trigger input signal goes at high level, the Generator will output a continuous waveform; when trigger input signal goes low, current waveform cycle is finished first, and then the Generator will stop and remain on the level corresponding to the start phase of selected waveform. For noise waveform, the gated signal goes false, the output will stop immediately. To modify the polarity, access Gated mode interface (See the figure below), then use multipurpose knob and arrow buttons or press **Params**→**Polarity** softkeys to complete the setup.

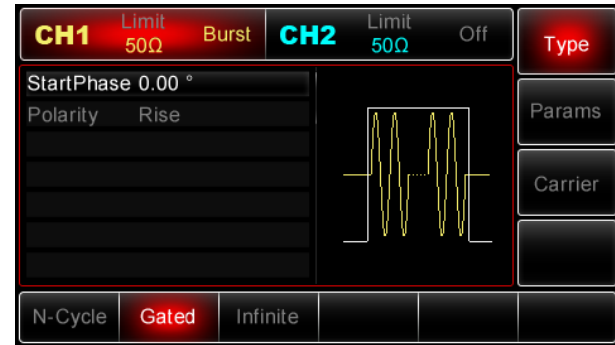

3) Infinite Mode

Enable burst function, then press **Type**→**Infinite** softkeys to access Infinite mode(if you are in burst waveform selection interface currently, press **Return** softkey first). In Infinite mode, Burst Period and Cycle count don't show on the parameter list, it means increasing the number of waveform cycles to infinite count. The Generator will output continuous waveform when it receives the trigger signal. Trigger source can be internal, external or

manual. To modify the parameter, enter into burst type interface(See the figure below), use multipurpose knob and arrow buttons or press **Params**→**TrigSrc** to complete the setup.

Note: When external trigger source is selected, Trigger Out option doesn't show on the parameter list, because Trigger Out is executed through external digital modulation connector (FSK Trig) which cannot function for trigger input and output connector at the same time.

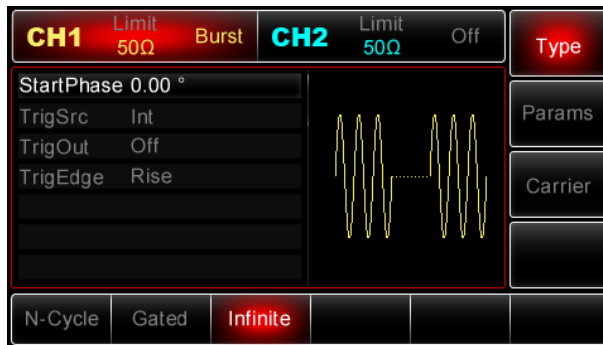

Burst Phase

Burst phase is the start phase of burst and ranges from -360° ~ $+360^{\circ}$. It defaults at 0° . To modify the parameter, enter into burst type interface, then use multipurpose knob and arrow buttons or press **Params**→**StartPhase** to complete the setup.

- For sine, square, ramp and pulse waveforms, 0° represents the point at which the waveform crosses 0V (or DC offset) in forward direction.
- For arbitrary waveform, 0° is the first point of waveform downloaded into the memory.
- Start phase has no impact on noise waveform.

Burst Period

Burst period is applicable for N-Cycle mode only, which defines the amount of time from the start of one burst to the start of next burst. When external or manual trigger source is selected, Burst Period doesn't show on the parameter list. Burst period

ranges from 1us~500s and defaults at 10ms. To modify the parameter, set burst type to N-Cycle first, then use use multipurpose knob and arrow buttons or press **Params**→**BstPeriod** to complete the setup.

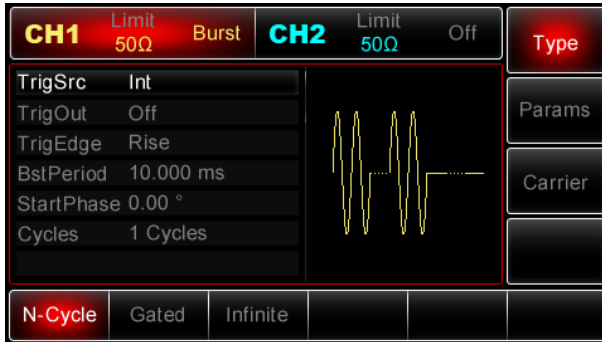

- Burst Period $\geq 1 \text{ ms} + \text{Waveform period} \times \text{Cycle Count}$. Waveform period is $1/\text{waveform frequency}$ which has been mentioned in Section Selecting Burst.
- If burst period is too short, the Generator will automatically increase the period in order to

output the specified numbers of cycles.

Burst Count

In N-Cycle mode, burst count is used to specify the number of waveform cycles. It can be set from 1~50000 cycles. The default is 1. To modify the parameter, set burst type to “N-Cycle” first, then use use multipurpose knob and arrow buttons or press **Params**→**Cycles** to complete the setup.

- $\text{Cycles} \leq \text{Burst Period} \times \text{waveform frequency}$
- If Cycles goes beyond the limit, the Generator will automatically increase burst period so as to adapt to the specified burst count (however waveform frequency keeps unchanged.)

Trigger Source

The Generator will output one burst once it receives one trigger signal, after that, it stops and waits for next trigger. Burst trigger source can be internal, external or manual. To modify the

parameter, enter into burst type interface first, then use use multipurpose knob and arrow buttons or press **Params**→**TrigSrc** to complete the setup.

1) When internal triggering is selected, burst is output at a specified frequency determined by burst period. The Generator can output “N-Cycle” or “Infinite” type of burst.

2) When external triggering is selected, the Generator will accept a hardware trigger applied on external digital modulation connector (**FSK Trig**) on the rear panel. Every time the connector receives a polarized TTL pulse, the Generator will output one burst. The burst can be N-Cycle, Gated or Infinite type.

Note: When you select external triggering, Trigger Out option is ignored and doesn't show on the parameter list, because Trigger Out is executed through external digital modulation connector

(**FSK Trig**) which cannot function for trigger input and output connectors at the same time.

3) When manual triggering is selected, the Generator will one burst each time Trigger button on the backlight is pressed down, and Trigger backlight flashes. The Generator can output “N-Cycle” or “Infinite” type of burst.

Trigger Out

When internal or manual trigger source is selected, the Generator outputs TTL-compatible signal (Squarewave). Trigger Out is set to “Off” by default. To modify the parameter, enter into burst type interface first, then use multipurpose knob and arrow buttons or press **Params**→**TrigOut**→**On** to complete the setup.

- When internal trigger is selected, the Generator outputs a squarewave with 50% duty cycle from external digital modulation connector (**FSK Trig**)

UTG2000A user manual

at the start of burst. Waveform period equals to specified burst period.

- When manual triggering is selected, the Generator outputs a pulse with pulse width $> 1\mu\text{s}$ from external digital modulation connector (FSK Trig) at the start of burst.
- When external triggering is selected, Trigger Out option doesn't show on the parameter list, because Trigger Out is executed through external digital modulation connector (FSK Trig) which cannot function for both trigger input and output connector at the same time.

Trigger Edge

No matter external digital modulation connector (FSK Trig) is used as Trigger In or Out connector, Trigger Edge can be specified for both situations. When it is used as Trigger In connector (external trigger source is selected), "Rise" represents the

Generator triggers on the rising edge of external signal to output one burst, and "Fall" is that the Generator triggers on the falling edge of external signal. In Gated mode, if the polarity is "Pos", the Generator trigger on high level to output one burst, otherwise it triggers on low level to output one burst if it is "Neg". When the connector is used as Trigger Out connector (internal or manual trigger source is selected and Trigger Out is enabled), "Rise" means trigger signal with rising edge is output, and "Fall" is that trigger signal with falling edge is output. It defaults at Rise. To modify the parameter, enter into burst type interface first, then use multipurpose knob or arrow buttons or press **Params** → **TrigEdge** → **Fall** (Gated mode: press **Params** → **Polarity** → **Neg**) to complete the setup.

Applications

First of all, please enable burst function. To set

a sine waveform with 500mVpp amplitude, 5ms period as burst waveform, and set burst type to N-Cycle, burst period to 15ms and cycle count to 2, please follow steps shown as below:

1) Enabling Burst Function

Press **Menu** → **Burst** → **Type** → **N-Cycle** (if **Type** label is not highlighted, press **Type** softkey again to select) to set to burst type to “N-Cycle” mode

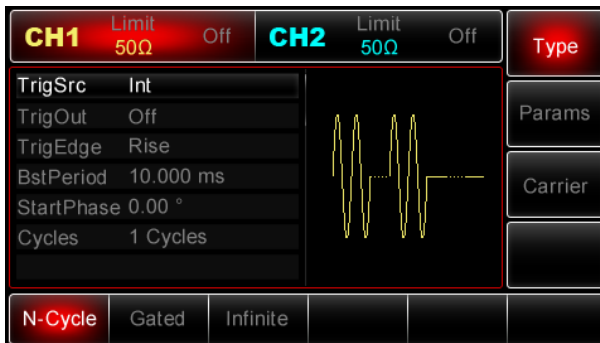

2) Selecting Burst Waveforms

With N-Cycle mode enabled, press **Carrier** → **Type** → **Sine** softkey to set sine waveform as the carrier signal (if **Type** label is not highlighted, press **Type** softkey again to select). Since default burst waveform is sine, there is no need to modify in this case.

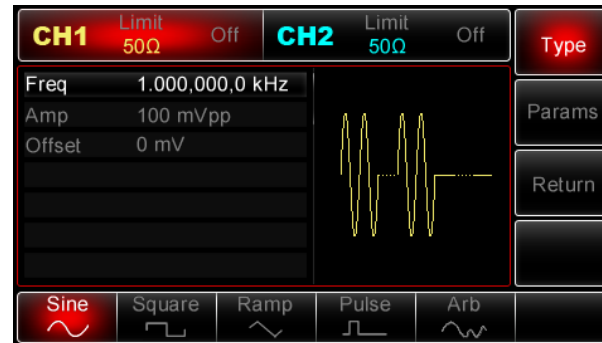

At the moment, you can use multipurpose knob and arrow buttons to set the amplitude (**Note:** if there is only frequency option available on the display, that is no toggling between frequency and period here, in order to set the period to 2ms, please set display frequency to 500Hz, since they are in reciprocal relation, namely, $T=1/f$). Or you can also press **Params** → **Freq** → **Freq** softkeys (second pressing on **Freq** is to toggle between frequency and period on the parameter list), then following interface will show as below:

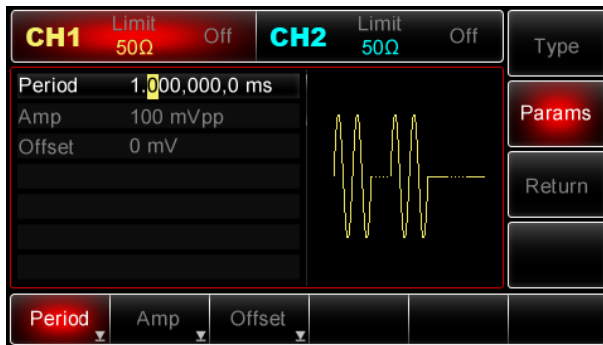

To set desired parameter, press the corresponding softkey, then enter in desired value and select the unit as required.

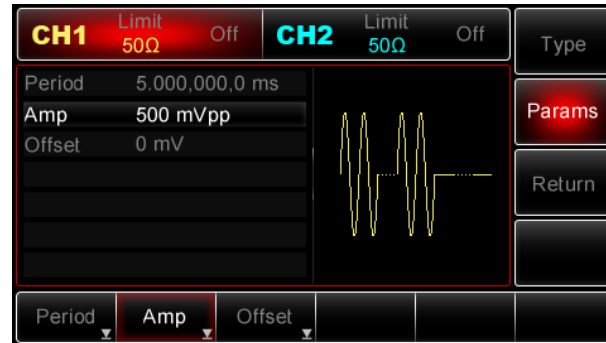

3) Setting Burst Period and Cycle Count

After completing the setup of burst waveform and relative parameters, press **Return** softkey to go back to the interface as below:

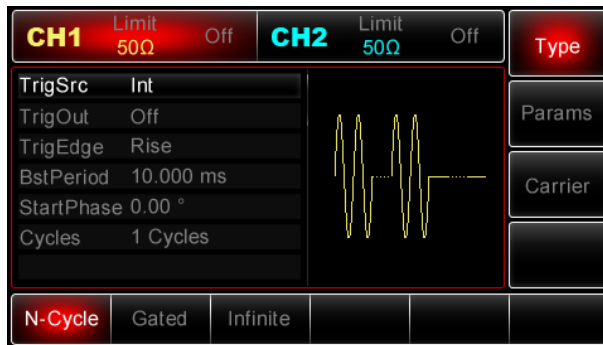

Then use the multipurpose knob and arrow buttons together to perform the setting, or you can also press **Params** softkey to pop up the interface as follows:

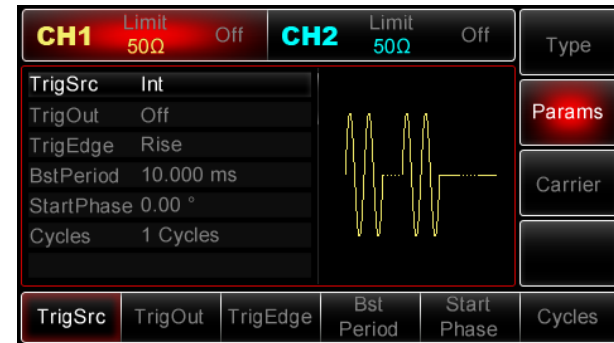

To set desired parameter, press the corresponding softkey, then enter in desired value and select the unit as required.

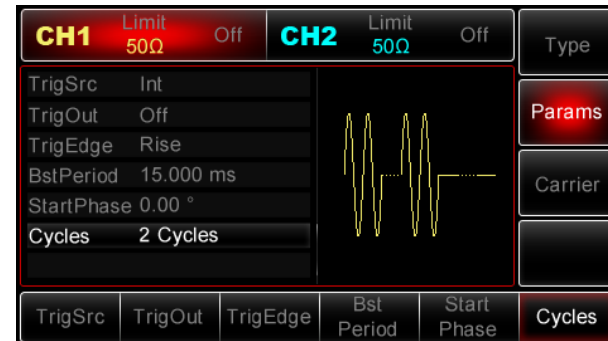

4) Enabling Channel Output

Press **CH1** button on the front panel to switch on CH1 output directly, or you can press **Utility** → **CH1Setting** to enable the output. With CH1 output enabled, **CH1** button is illuminated and “Off” in grey and to the right of CH1 label changes into “Burst” in yellow, indicating CH1 output has been enabled.

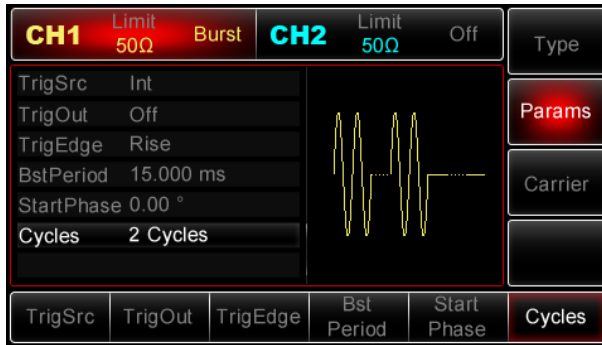

View burst waveform with use of an Oscilloscope as shown below::

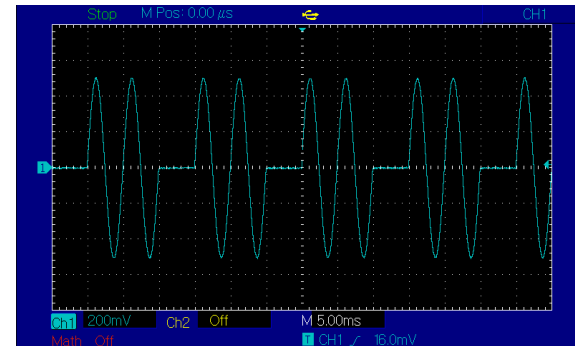

Outputting Arbitrary Waveforms

There are up to 48 types of standard waveforms stored in non-volatile memory of UTG2000A. Please refer to Table 4-1 for detailed information. The Generator can create and edit arbitrary waveforms through remote control software, and read any arbitrary waveform file stored in USB flash drive using USB port on the front panel.

Enabling Arbitrary Waveform Function

Press **Menu** → **Wave** → **Type** → **Arb** (if **Type** label is not highlighted, press **Type** softkey again to select) to enable arbitrary waveform function. With arbitrary waveform enabled, UTG2000A function/ arbitrary generator will output arbitrary waveform according to current settings.

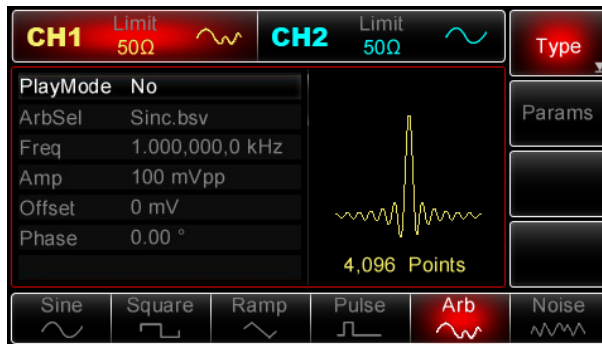

Point-by-Point Output/Play Mode

UTG2000A supports point-by-point mode of arbitrary waveform output. Under Point-By-Point output, the Generator will work out the output frequency (238.4185791015625Hz) based on waveform length (1,048,576 points) and sample rate, and then output waveform point by point using this frequency, which can avoid loss of important waveform points during output. The default is Off, under Off status, through working together with its supplied software, the Generator will automatically interpolate or sample points to output a arbitrary waveform based on a fixed waveform length (4,096 points) and the frequency defined on parameter list. To change the play mode to On, please enable arbitrary waveform function first, then use multipurpose knob along with arrow buttons or press **Params** → **PlayMode** to set it up. Under “On” status, frequency and phase option will be ignored

and doesn't show on the parameter list.

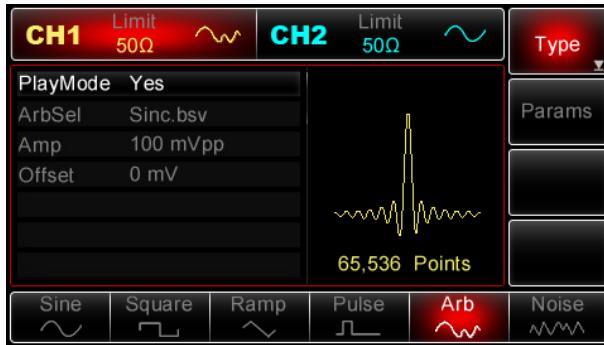

Notes: UTG2025A has no point-by-point mode, instead, it automatically interpolate or sample points to output a arbitrary waveform based on a fixed waveform length (8192 points) and the frequency defined on parameter list.

Selecting Arbitrary Waveform

UTG2000A allows users to output arbitrary waveforms from internal or external memory. To select the desired arbitrary waveform, please

enable arbitrary waveform function first, then use multipurpose knob and arrow buttons or press **Params**→**ArbSel** softkey.

Note: To select a desired arbitrary waveform from U disk, please plug the U disk into USB connector on the front panel, use the multipurpose and arrow buttons together or press **Params**→**ArbSel** to select the memory type first, and then choose the arbitrary waveform. UTG2062A Generator supports *.csv file with arbitrary waveform length less than 400K points or *.bsv file with arbitrary waveform length less than 1M points, while UTG2025A Generator supports *.csv file with arbitrary waveform length less than 8K points or *.bsv file.

Table 4-1 Built-in Waveform List

Type	Name
Common Function	Sin
	Square
	Ramp
	NegRamp
	PPulse
	Npulse
	Noise
	Sinc
	Cardiac
	EEG
	DualTone
	AbsSine
	StairDn
	StairUp
	Trapezia
Math Function	ExpFall
	ExpRise
	Log
	Ln
	HaverSine
	Lorentz
	Dlorentz
	Sqrt
	ARB_X2
	Cubic
Gauss	

Math Function	LogNormal
	Laplace
Trigonometric Function	SinH
	CosH
	CosInt
	Cot
	Tan
	TanH
	ASin
	ASinH
	ACos
	ACosH
	Atan
	AtanH
	Window Function
Triang	
Blackman	
ChebWin	
FlatTopWin	
Hamming	
Hanning	
Kaiser	

Creating and Editing Arbitrary Waveform

UTG2000A is capable of creating and editing complex arbitrary waveforms using the powerful analysis software (with the amplitude and waveform shape designed arbitrarily), please refer to "UTG2000A Software Operating Manual" for detail operations.

Chapter 5 Troubleshooting

This chapter lists out failures that may happen to UTG2000A when in use as well as the solutions to track down the causes. Please follow corresponding steps shown as below when you run into those similar failures. If those steps don't solve your problem, please contact distributor that sells this product or local representative office and offer information about your instrument to us (To collect instrument information: Press **Utility** → **System** → **System** → **About**)

No Display on the Screen(Blank Screen)

The Generator screen is still blank and has no display even after On/Off button is pressed down.

- 1) Make sure power supply is firmly connected to the instrument.
- 2) Make sure master power switch has good contact and has been switched to “I”.

- 3) Check if On/Off button on the front panel works normally.
- 4) Restart the instrument.
- 5) If the instrument still doesn't work, please contact distributor or local representative office for servicing.

No Waveform Output

The settings are correct, but there is no waveform output.

- 1) Make sure BNC cable is properly connected to channel output connector.
- 2) Make sure **CH1** or **CH2** button has been pressed down
- 3) Save current settings of the Generator to U disk, then resume “the factory default settings” and reboot the instrument.
- 4) If the instrument still doesn't work, please contact distributor or local representative office for servicing.

Unable to Recognize U Flash Drive

- 1) Make sure U flash drive can work normally.
- 2) Make sure U disk you have is Flash type, rather than hard-disk type that the instrument doesn't support
- 3) Reboot the instrument and insert U flash drive for second check
- 4) If the instrument is still unable to recognize the U disk, please contact distributor or local representative office for servicing.

Chapter 6 Service and Support

Updating the Instrument

Contact UNI-T or log into our website to obtain the latest program package, unzip the package and apply embedded program update system to update the current program of your function/arbitrary generator. Make sure your generator enjoys the latest version of program issued already by UNI-T

1. Turn on your UTG2000A generator, press **Utility** → **System** → **System** → **About** to collect information about your instrument such as the generator model, hardware version, software version, etc.
2. Obtain the program package and updating instruction file from UNI-T company or



UTG2000A user manual

website. Make sure they have the same model number with the Generator to be updated. Follow the updating instruction to upgrade your Generator.

AppendixA: Factory Default Settings

Parameters	Factory Default Settings	Parameters	Factory Default Settings
Channel Parameters			
Current Carrier	Sine	OutLoad	50 Ω
SyncOut	CH1	CH1/CH2 Output	OFF
Inverted Channel Output	OFF	Output Limit	OFF
Limit High	+5V	Limit Low	-5V
Basic Waveforms			
Frequency	1kHz	Amplitude	100mVpp
DC Offset	0mV	Start Phase	0°
Duty Cycle of Squarewave	50%	Ramp Symmetry	100%
Duty Cycle of Pulse	50%	Rising Edge of Pulse	1us
Falling Edge of Pulse	1us		

Arbitrary Waveform			
Built-in Arbitrary Waveform	Sinc	Play Mode	OFF
AM			
Modulation Source	Internal	Modulation Shape	Sine
Modulation Frequency	100Hz	Modulation Depth	100%
FM			
Modulation Source	Internal	Modulation Shape	Sine
Modulation Frequency	100Hz	Frequency Deviation	1kHz
PM			
Modulation Source	Internal	Modulation Shape	Sine
Modulation Frequency	100Hz	Phase Deviation	180°

UTG2000A user manual

PWM			
Modulation Source	Internal	Modulation Shape	Pulse
Modulation Frequency	100Hz	Duty Cycle Deviation	20%
ASK			
Modulation Source	Internal	ASK Rate	100Hz
FSK			
Modulation Source	Internal	FSK Rate	100Hz
Hop Frequency	10kHz		
PSK			
Modulation Source	Internal	PSK Rate	100Hz
PSK Phase	180°		
Frequency Sweep			
Sweep Type	Linear	Start Frequency	1kHz
Stop Frequency	2kHz	Sweep Time	1s

Trigger Source	Linear	Trigger Out	OFF
Trigger Edge	Rise		
Burst			
Burst Mode	N-Cycle	Start Phase	0°
Burst Period	10ms	Burst Count	1
Gated Polarity	Pos	Trigger Source	Internal
Trigger Out	OFF	Trigger Edge	Rise
System Parameters			
IP Type	DHCP	Clock Source	Internal
Clock Out	OFF	Beep	On
Number Separator	,	Backlight	100%
Language*	Depends on factory setup		

AppendixB: Technical Specifications

Model	UTG2062A	UTG2025A		
Channel	Dual	Dual		
Max. Frequency	60MHz	25MHz		
Sample Rate	250MSa/s	125MSa/s		
Waveforms	Sine, Square, Ramp, Pulse, Noise, DC, Arbitrary			
Working Modes	Gated, Continuous, Modulation, Sweep, Burst			
Modulation Types	AM,FM,PM,ASK,FSK,PSK,PWM			
Waveform Characteristics				
Sine				
Frequency Range	1μHz~60MHz	1uHz~25MHz		
Resolution	1uHz			
Accuracy	90days:±50ppm, 1year: ±100ppm (18°C~28°C)			
Harmonic Distortion (Typical)	Test condition: output power 0dBm			
	DC~20kHz	-70dBc	DC~100kHz	-60dBc
	20kHz~100kHz	-65dBc	100kHz~1MHz	-50dBc
	100kHz~1MHz	-50dBc	1MHz~25MHz	-35dBc

Harmonic Distortion (Typical)	1MHz~20MHz	-40dBc	
	20MHz~60MHz	-35dBc	
Total Harmonic Distortion (Typical)	DC~20kHz, 1Vpp<0.2%		
Spurious Signal (Non-Harmonic, Typical)	DC~10MHz, <-70dBc	DC~1MHz, <-70dBc	
	10MHz~60MHz <-70dBc+6dB/oct ave	1MHz~5MHz, <-40dBc	
		5MHz~25MHz, <-50dBc	
Phase Noise (Typical)	1kHz Offset: -105dBc/Hz		
	10kHz Offset:-115dBc/Hz		
	100kHz Offset:-125dBc/Hz		
Square			
Frequency Range	1μHz~25MHz	1μHz~5MHz	
Resolution	1uHz		
Rise/Fall Time	<13ns (Typical, 1kHz, 1Vpp)		<24ns (Typical,1kHz, 1Vpp)
Overshoot (Typical)	<2%		

UTG2000A user manual

Symmetry (below 50% Duty Cycle)	1% of period +4ns	
Jitter (Typical)	1ns+ 100ppm of Period	
Ramp		
Frequency Range	1μHz~400kHz	
Resolution	1uHz	
None-Linearity	<0.1% of Peak out(Typical, 1kHz, 1Vpp, 100%Symmetry)	
Symmetry	0.0%~100.0%	
Pulse		
Frequency Range	500μHz~25MHz	500μHz~5MHz
Resolution	1uHz	
Pulse Width	20ns~2000s	40ns~2000s
Variable Edge	12ns~2ms	20ns~2ms (typical 24ns)
Overshoot (Typical)	<2%	
Jitter	1ns+100ppm of Period	
Gaussian Noise		
Bandwidth	60MHz(-3dB), Typical	Bandwidth 25MHz(-3dB) Typical value

DC Offset		
Range (Peak AC+DC)	±5V(50Ω) ±10V (High Impedance)	
Offset Accuracy	± (1% of Offset Setting + 0.5% of Amplitude +5mV)	
Arbitrary Waveform Characteristics		
Frequency Range	1μHz~12MHz	1μHz~5MHz
Resolution	1uHz	
Waveform Length	2~1M point	2~8k point
Vertical Resolution	14bits(Including Sign)	
Sample Rate	250MSa/s	125MSa/s
Min. Rise/ Fall Time	35ns, Typical	
Jitter(RMS, Typical)	6ns+30ppm	15ns+ 100ppm
Non-Volatile Memory	48 Waveforms	
Output Characteristics		
Amplitude Range	0~10MHz : 1mVpp~10Vpp;10MHz~60MHz: 1mVpp~5Vpp (50Ω)	

Amplitude Range	0~10MHz : 2mVpp~20Vpp;10MHz~60MHz: 2mVpp~10Vpp(High Impedance)	
Accuracy (1kHz Sinewave)	±(1% of Setting+2mVpp)	
Amplitude Flatness (Relative to 1kHz Sine, 1Vpp/50Ω)	<200kHz 0.1dB	<100kHz 0.1dB
	200kHz~60MHz 0.2dB	100kHz~25MHz 0.2dB
Waveform Output		
Impedance	50Ω Typical	
Insulation	Max. 42Vpk to earth	
Protection	Short-circuited protection,ALL Front BNC Output Only	
Modulation Types		
AM		
Carrier Waveforms	Sine, Square, Ramp, Arbitrary,	
Source	Internal/External	
Modulating Waveforms	Sine, Square, Ramp, Noise, Arbitrary,	
Modulating Frequency	2mHz~50kHz	
Modulating Depth	0%~120%	

FM		
Carrier Waveforms	Sine, Square, Ramp, Arbitrary,	
Source	Internal/External	
Modulating Waveforms	Sine, Square, Ramp, Noise, Arbitrary,	
Modulating Frequency	2mHz~50kHz	
Frequency Deviation	1μHz~30MHz	1μHz~12.5MHz
PM		
Carrier Waveforms	Sine, Square, Ramp, Arbitrary,	
Source	Internal/External	
Modulating Waveforms	Sine, Square, Ramp, Noise, Arbitrary,	
Modulating Frequency	2mHz~50kHz	
Phase Deviation	0°~360°	
ASK		
Carrier Waveforms	Sine, Square, Ramp, Arbitrary,	
Source	Internal/External	
Modulating Waveforms	Squarewave, 50% Duty Cycle	

UTG2000A user manual

Modulating Frequency	2mHz~100kHz
FSK	
Carrier Waveforms	Sine, Square, Ramp, Arbitrary,
Source	Internal/External
Modulating Waveforms	Squarewave, 50% Duty Cycle
Modulating Frequency	2mHz~100kHz
PWM	
Carrier Waveforms	Pulse
Source	Internal/External
Modulating Waveforms	Sine, Square, Ramp, Noise, Arbitrary,
Modulating Frequency	2mHz~50kHz
Pulse Width Deviatio	0%~49.99% of pulse width
Frequency Sweep	
Carrier Waveforms	Sine, Square, Ramp, Arbitrary,
Mode	Linear, Logarithmic
Sweep Time	1ms~500s±0.1%

Trigger Source	Internal, External, Manual	
Burst		
Waveforms	Sine, Square, Ramp, Pulse, Noise, Arbitrary,	
Type	Counted(1~50000 Cycle) , Infinite, Gated	
Start Phase	-360°~ +360°	
Internal Period	1us~500s±1%	
Gated Source	External Trigger	
Trigger Source	Internal, External, Manual	
Sync Output		
Output Level	TTL-Compatible	
Output Frequency	1uHz~60MHz	1uHz~25MHz
Output Impedance	50Ω, Typical	
Coupling	DC	
Connectors on the Rear Panel		
Modulation Input	±5Vpk full scale	
	20kΩ Input Impedance	

10MHz Input/Output Frequency Range	10MHz±500Hz	
10MHz Input/Output Level Range	TTL compatible	
10MHz Input/Output Impedance	10KΩ(input)/50Ω (output), Typical, input DC coupling, output AC coupling	10KΩ(input)/50Ω(output), typical, input DC coupling, output AC coupling
Lock Time	<2s, Typical	
External Trigger	TTL-Compatible	
Trigger Input		
Input Level	TTL-Compatible	
Slope	Rise or Fall, selectable	
Pulse Width	>100ns	
Input Impedance	>10kΩ, DC-coupled	
Latency	Sweep < 500us, Typical	
	Sweep < 500us, Typical	

Trigger Output	
Level	TTL-Compatible to 50Ω
Pulse Width	>400ns, Typical
Output Impedance	50Ω, Typical
Max. Frequency	1MHz
Frequency Meter	
Input Level	TTL-Compatible
Input Frequency Range	100mHz~200MHz
Accuracy	±51ppm
Resolution	6bit/s
Coupling	DC, AC
General Specifications	
Display	
Display Type	4.3inch, TFT color LCD
Display Resolution	480 Horizontal × 272 Vertical
Power	
Power Voltage	100~240 VAC · 45~440Hz, CAT II

UTG2000A user manual

Power Consumption	<50W	<40W
Fuse	2A , T-Level , 250V	
Environment		
Temperature	Operating: 10°C~+40°C	
	Non-Operating: -20°C~+60°C	
Cooling Method	Forced fan cooling	
Humidity Range	<+35°C: ≤90% RH	
	+35°C~+40°C: ≤60% RH	
Altitude	Operating: Up to 3000m	
	Non-Operating: Up to 15000m	
Mechanical		
Size	305mm×230mm×93mm	
Weight (Net Weight)	3.10kg(Packing not include)	
	4.10kg(Packing Include)	

Appendix C: Accessories List

Model	UTG2000A (dual channels)
Standard	Power cable(applicable for the country/region of destination), 1pc
	USB cable, 1pc
	BNC cable(1m), 2pcs
	Users manual, 1pc
	CD disk, 1pc
Optional	LAN port for UTG2062A

Appendix D: Maintenance

General Service

- Do not store or place the instrument in places that may make its LCD exposed to direct sunshine for a long time.
- To avoid any damage to the instrument or connection wires, do not place them into fog liquid or solvent.

Cleaning

- Clean the instrument regularly as real situation requires
- Disconnect the power before cleaning, then clean it with damped cloth, no water drop from the cloth is allowed(mild agent or water is recommended to use in cleaning dust on the instrument, do not apply any chemical or agent with benzene, methyl benzene,

dimethylbenzene, acetone, or other strong substances)

- Be carefull not to scratch LCD protective layer when cleaning the LCD of the instrument.
- Do not use any corrosives or abrasives that may cause any damage to the instrument.

Warning: To avoid any short circuit or even personal injury arised from residual water, please make sure the instrument is totally dry before powering it on



UTG2000A user manual

The information is subject to changes without prior notice if manual content varies.

UNI-T®

UTG2000A user manual

UNI-T®

UNI-TREND TECHNOLOGY (CHINA) CO., LTD.

No6, Gong Ye Bei 1st Road,
Songshan Lake National High-Tech Industrial
Development Zone, Dongguan City,
Guangdong Province, China
Tel: (86-769) 8572 3888
<http://www.uni-trend.com>

序号	项目	内容	
1	尺寸	外形尺寸: (210x145) ± 1mm	
2	材质	封面、封底用230g铜版纸, 内页用80g书纸,	
3	颜色	黑色	
4	外观要求	印刷完整清晰, 版面整洁. 无分层. 残损. 毛边等缺陷.	
5	装订方式	胶装	
6	表面处理	封底和封面过光胶	
7	修改	REV. 1 韦英锁2015/04/21 修改内容 REV. 2 韦英锁2015/09/22 1.修改内容 REV. 3 韦英锁2015/12/12 1. 在第3页增加: ALL Front BNC Output Only 2. 在第110页Waveform Output项的 Short-circuited protection 后面增加一句: "ALL Front BNC Output Only" 3. 修改封底	
版本		REV. 4	
DWH 设计	李丹2018-5-28	MODEL UTG2000A系列 机型: 英文说明书	Part NO. 物料编号: 110401104725X
CHK 审核			
APPRO. 批准		UNI-T® 优利德科技(中国)股份有限公司 UNI-TREND TECHNOLOGY (CHINA) CO.,LTD	