

UNI-T®

UT191E/T



Certificate No. QAC0956661

Operating Manual



Professional Multimeter

P/N:110401107044X



Table of Content

I. Introduction	1
II. Open Box Inspection	2
III. Safety Instructions	3
IV. Symbols	5
V. General specifications	6
VI. Structure	7
VII. LCD display	8
VIII. Functional dial and buttons	10
IX. Operation instructions	13
X. Technical specifications	28
XI. Maintenance	34

I. Introduction

UT191E/T is a reliable and safe multifunctional industrial digital multimeter.

The special features of this series are:

Multifunctional measurement: AC/DC voltage and current, resistance, diode, continuity, capacitance, frequency, and duty ratio.

- Accurate temperature measurement with resolution up to 0.1°C.
- IP65 rated, 2m drop test.
- Large LCD screen, 6000 display count, sampling rate: 3 times/s
- Error protection for up to 6kV electric shock.
- True RMS AC voltage/current and non-linear signal measurement
- Peak value AC voltage/current measurement
- Support measurement of up to 600V/20A voltage/current.
- Low pass filter (LPF) function
- LoZ voltage measurement
- MAX/MIN value display
- REL mode
- Auto/manual measurement
- Backlight
- GS/CE/cTUVus certified

II. Open Box Inspection

Open the package box and take out the device. Please check whether the following items are deficient or damaged, and contact your supplier immediately if they are.

User manual ----- 1 pc
Test leads----- 1 pair
K-type thermocouple (UT191T)----- 1 pc
9V alkaline battery ----- 1 pc

III. Safety Instructions

Safety Standards

CE (EMC, LVD, RoHS), GS, cTUVus

- EN 61326-1:2013; EN 61326-2-2:2013
- EN 61010-1:2010; EN 61010-2-030:2012; EN 61010-2-031:2015
- UL 61010-1, 3rd ed., 2012
CAN/CSA-C22.2 NO. 61010-1-12
- UL 61010-031, 2nd ed., 2017
CAN/CSA-C22.2 No. 61010-031:17
- UL 61010-2-033, 1st ed., 2014
CAN/CSA-C22.2 NO. 61010-2-033:14
- AfPS GS 2014:01
- EN 60529:1991+A1+A2
- CAT III 600V, double insulation standard, pollution grade II

Safety Instructions

- 1) Do not use the device if the rear cover is not covered up or it will pose a shock hazard
- 2) Do not use the device if the device or test leads appear damaged or if you suspect that the device is not operating properly. Pay particular attention to the insulation layers.
- 3) To avoid false reading, replace the battery when the battery indicator appears.
- 4) Functional dial should be switched to proper position.
- 5) Never input voltage and current exceeding the value listed on the device.
- 6) Do not switch the functional dial during measuring.
- 7) After each measure, disconnect the test leads with the circuit. For measuring current, switch off the power supply before test leads disconnection, especially important for measuring large current.
- 8) Use caution to measure voltage > DC 60V or AC 30Vrms.

- 9) Do not use or store the device in high temperature, high humidity, flammable, explosive, or strong magnetic field environments.
- 10) Do not change the internal circuit of the device in order to avoid the damage to the device and users.
- 11) Use damp cloth to clean the case; do not use detergent containing solvents or abrasives.
- 12) Please operate the device according to this manual.
- 13) Replace the test lead if the insulation layer is damaged.

Application

This device complies with CAT III 600V measurement category.

CAT III is used in outdoor three-phase power supply devices, such as power distribution of power plant, protection system of electric meters and connecting devices of outdoor buildings.









The rated voltage of probe kit for measurement should comply with IEC 61010-031 category III, and that should be the maximum voltage of the circuit being measured.

This device should be used in applications listed in this manual. Any misuse of device may result in accident or damage to the device, and may void any rights to dealer claims and warranty.

The manufacturer will not liable for property damage and personal injury caused by following reasons:

1. Operations not following the instruction manual
2. Modifying the device without prior approval from manufacturer
3. Using 3rd party accessories without prior approval from the manufacturer
4. Using this instrument under the influence of alcohol, drugs, or other judgment impairment substances.
5. Using the device in potential explosive and high moisture/rainfall environment.

IV. Symbols

	AC/DC
	Warning
	Double insulation
	High voltage
	Grounding
	Complies with European Union Directives
	Tested and approved by TÜV Product Services
	cTUVus certification

V. General specifications

- 1) Max voltage between input terminal and earth grounding: 600V
- 2) Fuse Type:
 - 20A Jack: FF 11A H 1000V Fuse (Φ10x38) mm
 - mA/μA Jack: FF 600mA H 600V Fuse (Φ6x32) mm
- 3) Display count: 6000

Others:

- 1) Range: Auto/manual
- 2) Polarity: Auto
- 3) Display updates 3 times for every second. Over-range Indicator: "OL"
- 4) Operating temperature: 0°C~40°C (32°F~104°F)
Storage temperature: -10°C~50°C (14°F~122°F)
Relative humidity: ≤75% at 0°C~30°C; ≤50% at 30°C~40°C
- 5) Operating altitude: 0~2000m
- 6) Battery type: 9V GP 1604A
- 7) Low power indicator:
- 8) Dimension: 180mm×87mm×59mm
- 9) Weight: 428g (with battery)
- 10) Electromagnetic compatibility:
 - RF ≤ 1V/m, overall accuracy = specified accuracy + 5% of range.
 - RF > 1V/m, no specified calculation.

VI. Structure

- ① Backlight sensing window
- ② LCD screen
- ③ Functional buttons
- ④ Multifunctional dial
- ⑤ Input jacks
- ⑥ Hook
- ⑦ Flashlight
- ⑧ Test leads holding stand
- ⑨ Battery cover screw
- ⑩ Case holder

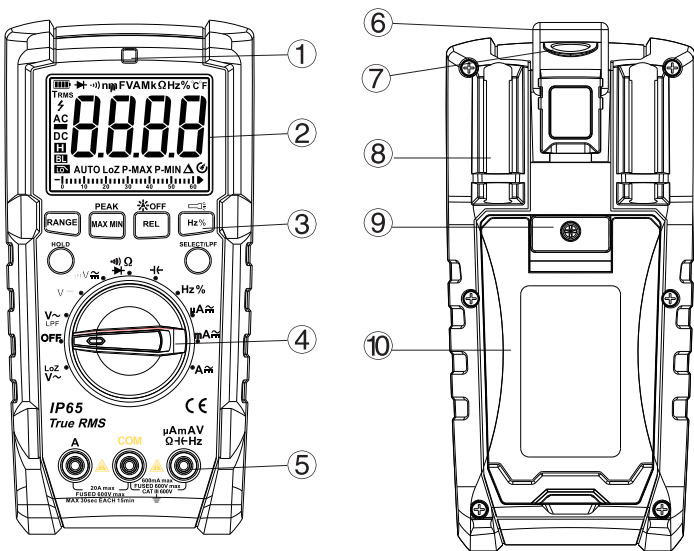

VII. LCD display



Symbol	Note
TRMS	True RMS value measurement
H	High voltage
⚡	Reading in hold status
P-MAX/P-MIN	Peak value
-	Negative number

AC/DC	AC or DC measurement
LoZ	AC low impedance
	Power indicator
AUTO	Auto range selection
	Diode measurement/Continuity measurement
	LPF
Ω , $k\Omega$, $M\Omega$	Unit of resistance
Hz, kHz, MHz	Unit of frequency
%	Unit of duty ratio
mV, V	Unit of voltage
μA , mA, A	Unit of current
nF, μF , mF	Unit of capacitance
$^{\circ}C/^{\circ}F$	Celsius degree/Fahrenheit degree
BL	Backlight
	Auto power off
	31 segments of bar graph
	Reading
	Relative value measurement

VIII. Functional dial and buttons

Position	Note
V \sim , V \approx , mV \approx	Voltage measurement (AC/DC)
Ω	Resistance measurement
	Diode measurement
	Continuity measurement
	Capacitance measurement
Hz	Frequency measurement
%	Duty ratio measurement
$^{\circ}C/^{\circ}F$	Temperature measurement
$\mu A \approx$ mA \approx A \approx	AC/DC measurement
LPF V \sim	Variable frequency voltage measurement (Low pass filter)
LoZ V \sim	Low impedance voltage measurement
OFF	Shutdown

Buttons :

Valid press: buzzer goes off once; invalid press: buzzer goes off twice.

*.RANGE : Switch the range mode to auto/manual and then cycle through all ranges.

To exit auto/manual mode, press the button for 2 seconds or switch the functional dial.

(only for V_{\sim} , V_{\square} , Ω , Hz, μA_{\square} , mA_{\square} , A_{\square})

MAX/MIN :

1. Starts and stops Max/Min recording. To exit this mode, press the button for 2 seconds or switch the functional dial. (only for LOZ V_{\sim} , LPF V_{\sim} , V_{\sim} , V_{\square} , mV_{\square} , Ω , μA_{\square} , mA_{\square} , A_{\square} , $^{\circ}C/^{\circ}F$ (UT191T))

2. Long press this button to obtain/exit peak value. Short press this button to cycle through P-MAX, P-MIN value. (only for V_{\sim} , mV_{\sim} , μA_{\sim} , mA_{\sim} , A_{\sim})

REL :

1. Save the first reading as reference value. The second reading=second measurement value-reference value. To exit his mode, press the button for 2 seconds.

(only for LOZ V_{\sim} , LPF V_{\sim} , V_{\sim} , V_{\square} , mV_{\square} , Ω , $^{\circ}C/^{\circ}F$ (UT191T), μA_{\square} , mA_{\square} , A_{\square} measurement);

when measuring capacitance, REL button is only used for eliminating intrinsic value.

2. Long press REL to turn on/off backlight

Hz/% :

1. At Hz% position, press the button to cycle through frequency and duty ratio measurement.

2. At other position, press this button to cycle through frequency, duty ration and the present position. (only for LOZ V_{\sim} , LPF V_{\sim} , V_{\sim} , mV_{\sim} , μA_{\sim} , mA_{\sim} , A_{\sim})

3. Long press this button to turn on off the flashlight

SELECT :



1. Select functions.

2. Disable auto off function: Long press this button and turn on the device to disable auto off function,  disappears. Restart the device to recover auto off function (do not press SELECT).

HOLD :

Press the button once to hold the reading. Press again to unlock the reading and enter general measurement modes.

IX. Operation instructions

To avoid false reading, replace the battery if the battery low power symbol  appears. Also pay special attention to the warning sign  besides the test lead housing, indicating that the tested voltage or current must not exceed the values listed on the device.

1. AC/DC voltage measurement

- 1) Switch the dial and press SELECT to select position.(V~, V-, mV~, mV- or LPF V~)
- 2) Insert the red test lead to $\mu\text{A mV}$ or $\mu\text{A mV C}^{\text{F}}$ jack(UT191T), black to COM jack.
- 3) Connect test leads with the load in parallel.
- 4) Reading is displayed.

Warnings:

- Do not input voltage over 600Vrms, or it may pose shock hazard.
- Be cautious when measuring high voltage

Notes:

- Before using the device, it is suggested to measure a known voltage for verification.
- When input impedance about 10M Ω , there is measurement errors. Input impedance $\leq 10\text{k}\Omega$, measurement errors can be ignored ($\leq 0.1\%$)
- At DCmV position, if input impedance $\geq 1\text{G}\Omega$, there is higher measurement frequency. When the test leads is disconnected, there may be some digits appear. This will not influence measurement.
- Under ACV mode, press SELECT button to enter LPF function to filter high frequency interference signal. (applicable for variable frequency voltage)
- Readings of AC voltage measurement are true RMS.
- At AC voltage position, long press PEAK to enable peak value function. Response time: 1ms. Short press to cycle through P-MAX, P-MIN value.
- At AC voltage position, press Hz% button to enter frequency measurement. Testing range is 40Hz~400Hz. During frequency measurement, input scale $\geq \text{Rang} \times 10\%$.

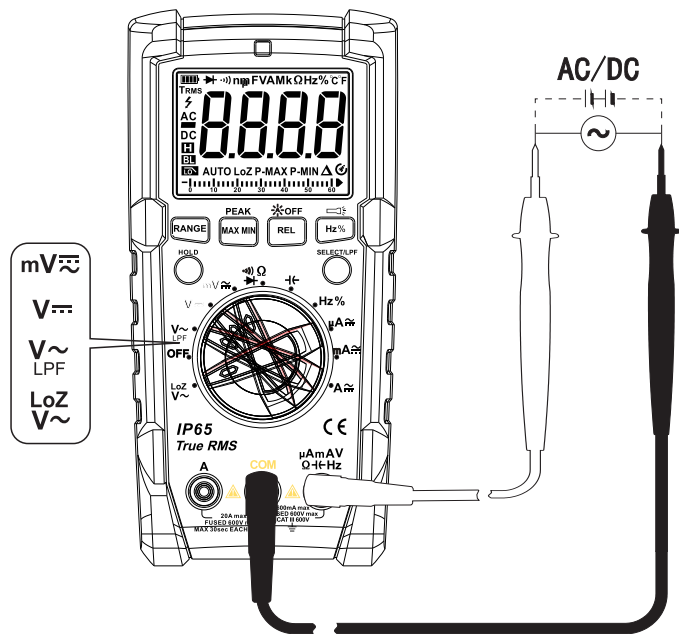

2. LoZ (low impedance) ACV measurement

- 1) Switch the dial to V_{LoZ} , select LoZ position.
- 2) Insert the red test lead to $\mu A m A V$ or $\mu A m A V \Omega Hz$ jack (UT191T), black to COM jack.
- 3) Connect test leads with the load in parallel.
- 4) Reading is displayed.

⚠ Notes:

- Do not input over 600Vrms or it may damage the device.
- Pay attention when measuring high voltage.
- Before using the device, it is suggested to measure a known voltage for verification.
- After using LoZ function, wait for 3 minutes for next operation.
- In order to eliminate fake voltage, LoZ provides low impedance (300k Ω) for accurate measurement
- AC measurement displays True RMS value.

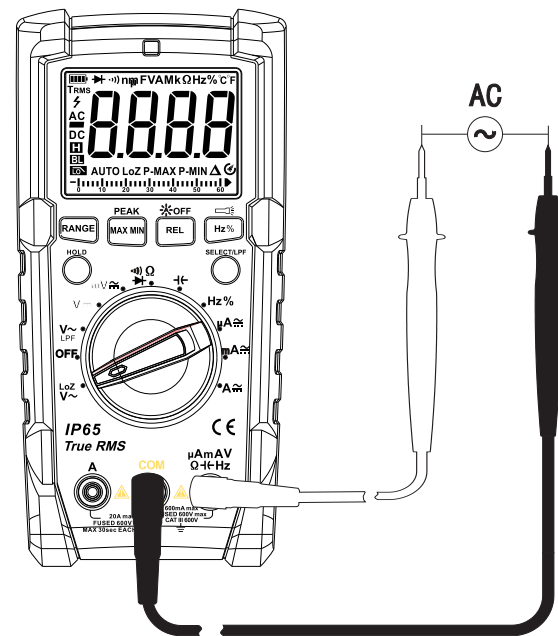

3. Resistance measurement

- 1) Switch the dial to Ω or $\frac{\Omega}{10}$ (UT191T)
- 2) Press SELECT to enable resistance measurement
- 3) Insert the red test lead to $\mu\text{A/mA/V}$ or $\mu\text{A/mA/V/Hz}$ (UT191T) jack, black to COM jack.
- 4) Connect test leads with the load in parallel.
- 5) Reading is displayed.

⚠ Notes:

- If the resistor is open or over the range, the "OL" symbol will be displayed on the screen.
- Before measuring resistance, switch off the power supply of the circuit, and fully discharge all capacitors.
- When measuring low resistance, the test leads will produce 0.1 Ω ~0.2 Ω measurement error.
To obtain accurate measurement, short the test leads and use REL function.
- If the resistance when shorted is more than 0.5 Ω , please check if test leads are loosened or damaged.
- When measuring high resistance above 60M Ω , it is normal to take a few seconds to steady the readings.

4. Continuity measurement

- 1) Switch the dial to Ω or $\frac{\Omega}{10}$ (UT191T)
- 2) Press SELECT to enable continuity measurement
- 3) Insert the red test lead to $\mu\text{A/mA/V}$ or $\mu\text{A/mA/V/Hz}$ (UT191T) jack, black to COM jack.
- 4) Connect test leads with the load in parallel.
- 5) Reading is displayed. Measured resistance >100 Ω , circuit is broken, buzzer does not go off. Measured resistance $\leq 30\Omega$, circuit is in good conduction status, buzzer will go off continuously. If OL appears on the screen, circuit is in open status.

⚠ Warnings:

- Switch off the power supply to the circuit, and fully discharge all capacitors
- Do not input over 60V DC or 30V AC or it will pose shock hazard.

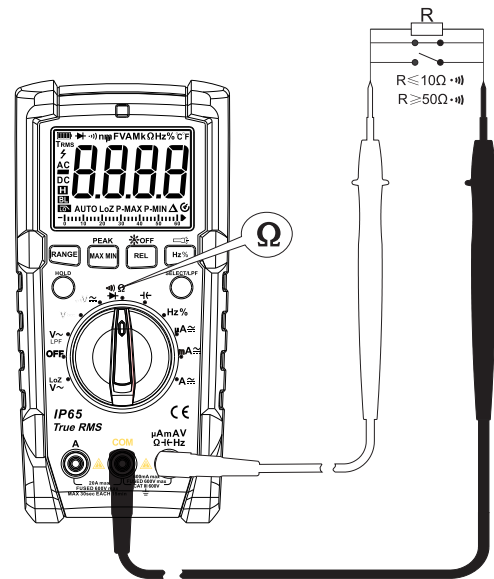

5. Diode measurement

- 1) Switch the dial to \rightarrow or \rightarrow (UT191T)
- 2) Press SELECT to enable diode measurement
- 3) Insert the red test lead to μ A mA V or μ A mA V Ω Hz (UT191T) jack, black to COM jack.
- 4) Red test lead to positive pole, black to negative pole.
- 5) Reading is displayed.
- 6) "OL" symbol appears when the diode is open or polarity is reversed. For silicon PN junction, normal value: 500 ~ 800mV (0.5 ~ 0.8V).

⚠ Warnings:

- Do not input over 60V DC or 30V AC or it will pose shock hazard.

⚠ Notes:

- Switch off the power supply to the circuit, and fully discharge all capacitors
- Voltage for testing diode is about 3V.

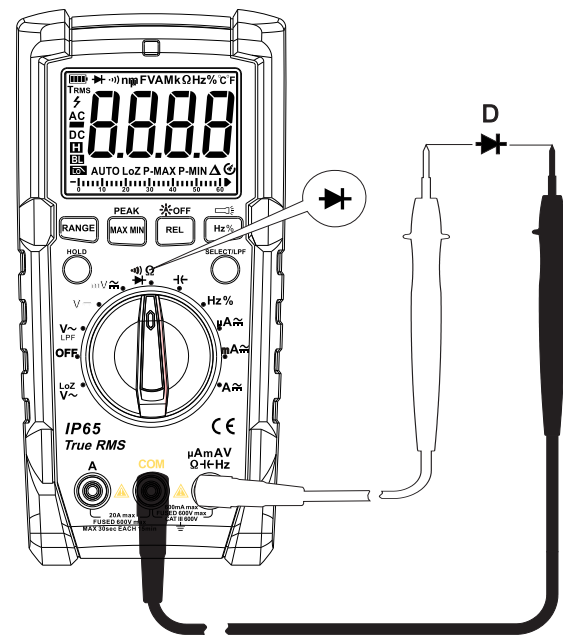

6. Capacitance measurement

- 1) Switch the dial to Ω or $\frac{\mu\text{A}}{\Omega-\text{Hz}}$ (UT191T)
- 2) Press SELECT to enable capacitance measurement
- 3) Insert the red test lead to $\frac{\mu\text{A}}{\Omega-\text{Hz}}$ or $\frac{\mu\text{A}}{\Omega-\text{Hz}}\text{C}^{\text{F}}$ (UT191T) jack, black to COM jack.
- 4) Connect test leads to the pins of capacitor
- 5) Reading is displayed.

⚠ Notes:

- Switch off the power supply to the circuit, and fully discharge all capacitors
- Before measuring capacitors (especially for high voltage capacitors), please fully discharge them.
- If the tested capacitor is shorted or its capacity is over the specified range "OL" symbol will be displayed on the screen.
- When measuring large capacitors, it may take a few seconds to obtain steady readings.
- When there is no input, the device displays a fixed value (intrinsic capacitance). For small capacitance measurement, to ensure measurement accuracy, the measured value must be subtracted from intrinsic capacitance. Or users can measure small capacity capacitors with relative measurement function (REL) (the device will automatically subtract the intrinsic capacitance)

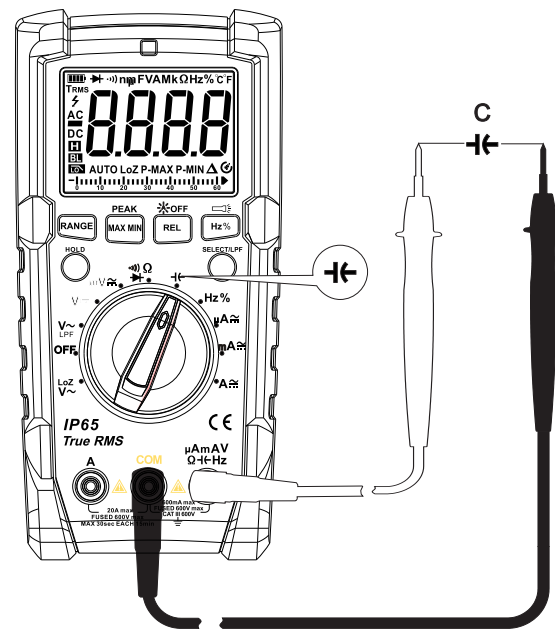

7. Frequency/ Duty Ratio measurement (Only for AC positions)

- 1) Switch the dial to Hz% position
- 2) Insert the red test lead to μAmAV or $\mu\text{AmAV}^{\circ}\text{C}^{\circ}\text{F}$ (UT191T) jack, black to COM jack.
- 3) Connect the test leads with tested points
- 4) Short press Hz% or SELECT to switch between frequency or duty ratio measurement.
- 5) During AC current/voltage measurement, press Hz% to switch between frequency and duty ratio
- 6) Reading is displayed.

⚠ Warnings:

- Do not input over 60V DC or 30V AC or it will pose shock hazard.

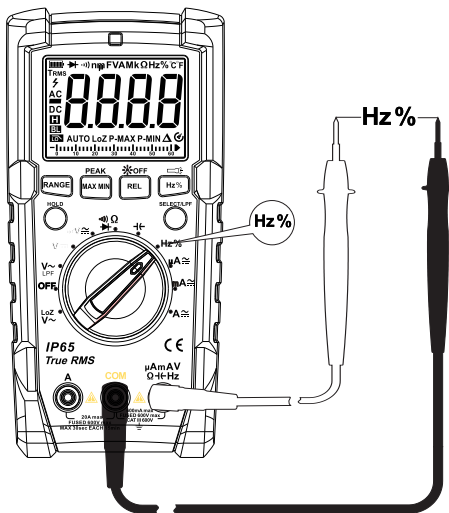

8. Temperature measurement

- 1) Switch the dial to $^{\circ}\text{C}^{\circ}\text{F}$
- 2) Insert K-type thermocouple to $\mu\text{AmAV}^{\circ}\text{C}^{\circ}\text{F}$ jack ("+" end) and COM jack.
- 3) Reading is displayed.
- 4) Press SELECT to switch temperature unit.

⚠ Note:

- Only K-type thermocouple is applicable.
- The measured temperature should be less than $400^{\circ}\text{C}/752^{\circ}\text{F}$ ($^{\circ}\text{F} = ^{\circ}\text{C} * 1.8 + 32$)
- Turn on the device, after "OL" symbol appears.

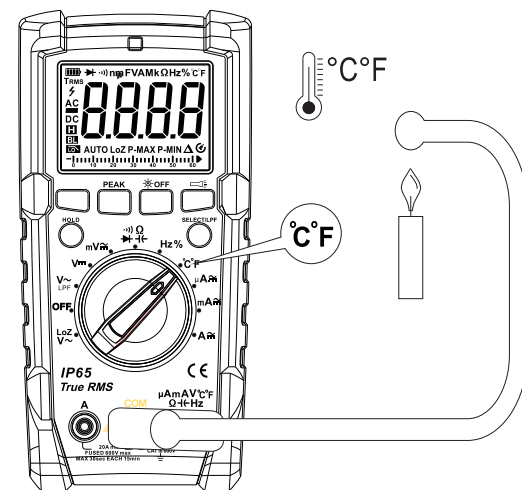

9. AC/DC current measurement

- 1) Switch the dial to μA , mA , A .
- 2) Press SELECT to switch between AC and DC current.
- 3) According to the current being measured. Insert the red test lead to A jack or $\mu\text{A}/\text{mA}$, black to COM jack.
- 4) Connect test leads with the circuit in series.
- 5) Reading is displayed.

⚠ Notes:

- Before measuring, switch off the power supply of the circuit.
- If connect test leads with the circuit in series, please power off the circuit in advance.
- If the range of the measured current is unknown, select the maximum range and then accordingly reduce.
- There are fuses inside 20A jack and mA/ μA jack. Do not connect the test leads with any circuits in parallel.
- Under AC mode, readings are true RMS.
- If the tested current is 10A~20A, each measurement time is about 10 seconds (less than 30s) and the next test should be after 15 minutes.
- At AC current position, long press PEAK to enable peak value acquisition, response time 1ms, short press to switch between P-MAX, P-MIN value.
- When measuring AC current, press Hz/% button to display AC frequency or duty ratio. Frequency range: 40Hz~400Hz, input amplitude \geq min. range $\times 50\%$

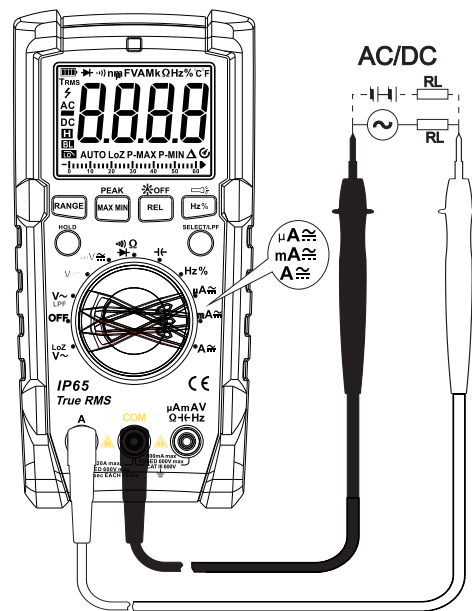

10.Others:

Auto power off: The device automatically shuts down if there is no operation for 15 minutes. You can wake up the device by pressing any key. To disable auto shutdown, switch the dial to OFF position, long press SELECT button and turn on the device. Recover the auto-off function by restarting the device.

- Auto backlight: Under dark circumstance (Illuminance \leq 30~50Lux), LCD backlight will be activated automatically (last 30s). Under bright circumstance (Illuminance $>$ 50Lux), backlight will automatically shut down.
- Buzzer: When AC/DC voltage $>$ 600V, current $>$ 10A, buzzer will go off intermittently.
- Low voltage alarm: when voltage $<$ 6.1V,  appears.

X. Technical specifications**⚠ Notes:**

*. To ensure accuracy, operating temperature should be within 18°C~28°C.

Temperature Coefficient= 0.1

* (specified accuracy)/°C (<18°C or >28°C)

1. DC voltage

Range	Resolution	Accuracy
600.0mV	0.1mV	$\pm (0.7\% + 3)$
6.000V	0.001V	$\pm (0.5\% + 3)$
60.00V	0.01V	$\pm (0.7\% + 3)$
600.0V	0.1V	

⚠ Input impedance: *mV mode: \geq 1000M Ω , *other mode: about 10M Ω mV.

Results might be unstable at mV range when no load is connected.

The value becomes stable once the load is connected. (Allow \leq 5 digits at shorted mV position, 0 digit at other positions.)

Max input voltage: \pm 600V

2. AC voltage

Range	Resolution	Accuracy
600.0mV	0.1mV	$\pm (1.0\%+4)$
6.000V	0.001V	$\pm (0.7\%+3)$
60.00V	0.01V	$\pm (1.0\%+3)$
600.0V	0.1V	$\pm (1.0\%+3)$
AC LoZ 600.0V	0.1V	$\pm (2.0\%+5)$
ACV LPF 600.0V	0.1V	$\pm (2\%+5)$

- ⚠** ● Input impedance: about 10M Ω
- Display sine wave true RMS. Frequency response: 40Hz~200Hz. After using LoZ function, please cool down the device for 1 minutes.
 - Accuracy guarantee range: 1~100% of the range, shorted circuit allows least significant digit ≤ 10 crest factor at Max range=3.0
- Non-sinusoidal waveform : crest factor=1.0~2.0 additional accuracy: 3.0%
- Non-sinusoidal waveform: 2.0~2.5 additional accuracy: 5.0%
- Non-sinusoidal waveform: 2.5~3.0 additional accuracy: 7.0%
- Max input voltage: 600Vrms.



3. Resistance measurement

Range	Resolution	Accuracy
600.0 Ω	0.1 Ω	$\pm (1.0\%+2)$
6.000k Ω	1 Ω	$\pm (0.8\%+2)$
60.00k Ω	10 Ω	
600.0k Ω	100 Ω	
6.000M Ω	1k Ω	$\pm (1.2\%+3)$
60.00M Ω	10k Ω	$\pm (2.5\%+5)$

* Measurement result = reading of resistor – reading of shorted test leads

⚠ Overload protection: 600V

4. Continuity, Diode

Range	Resolution	Accuracy
	0.1 Ω	Set Value: Open circuit: resistance $\geq 100\Omega$, no beep. Well-connected circuit: resistance $\leq 30\Omega$, continuous beeps.
	1mV	Open circuit voltage: 3.0V Silicon PN junction voltage: 0.5 ~ 0.8V.

⚠ Overload protection: 600V

5. Capacitance

Range	Resolution	Accuracy
6.000nF	1pF	REL mode: (4%+8)
60.00nF~600.0μF	10pF~0.1μF	±(3%+5)
6.000mF~60.00mF	1μF~10μF	±10%

⚠ Overload protection: 600V
Test capacitance ≤ 1μF, adapt REL mode.

6. Frequency/Duty ratio

Range	Resolution	Accuracy
10.00Hz~1.00MHz	0.01Hz~0.001MHz	±(0.1%+4)
0.1%~99.9%	0.1%	±(2%+5)

⚠ Overload protection: 600V
Input range: (DC level=0)
≤ 100kHz: 200mVrms ≤ a ≤ 30Vrms
> 100kHz~1MHz: 600mVrms ≤ a ≤ 30Vrms

Duty ratio% : Waveform must be square wave and frequency ≤ 10kHz. Amplitude:
1Vpp ≤ Input amplitude ≤ 30Vpp
Frequency ≤ 1kHz, duty ratio: 10.0%~95.0%
Frequency > 1kHz, duty ratio: 30.0%~70.0%

7. Temperature (UT191T)

Range		Resolution	Accuracy	
°C	-40~400°C	-40~300°C	0.1°C~1°C	±(1.0%+2°C)
		300~400°C		±(1.0%+2°C)
°F	-40~752°F	-40~572°F	0.2°F~2°F	±(1.0%+4°F)
		572~752°F		±(1.0%+4°F)

⚠ Overload protection: 600V
K-type thermocouple is only applicable for temperature less than 400°C/752°F.

8. DC current

Range		Resolution	Accuracy
μA	600.0μA	0.1μA	±(0.8%+3)
	6000μA	1μA	
mA	60.00mA	10μA	
	600.0mA	0.1mA	
A	6.000A	1mA	±(1.0%+3)
	20.00A	10mA	±(1.2%+5)

Warning: Please do not measure current above 10A for more than 30s. Cool down the device for twice the measurement time for another measurement.

⚠ Overload protection:
μA mA range: F1 Fuse (φ6×32) mm FF 600mA H 600V (CE)
20A range: F2 Fuse (φ10×38) mm FF 11A H 1000V (CE)

9. AC current

	Range	Resolution	Accuracy	
μA	600.0μA	0.1μA	± (1.0%+3)	
	6000μA	1μA		
mA	60.00mA	10μA		
	600.0mA	0.1mA		
A	6.000A	1mA		± (1.2%+3)
	20.00A	10mA		± (1.5%+5)

Warning: Please do not measure current above 10A for more than 30s. Cool down the device for twice the measurement time for another measurement.

Frequency response: 40~400Hz

Display: true RMS

Accuracy guarantee range: 1 -100% of the range, shorted circuit allows least significant digit \leq 2

*crest factor can reach up to 3.0 at Max range

Non-sinusoidal waveform: Crest factor=1.0~2.0 additional accuracy: 3.0%

Non-sinusoidal waveform: 2.0~2.5 additional accuracy: 5.0%

Non-sinusoidal waveform: 2.5~3.0 additional accuracy: 7.0%

 Overload protection: (similar to DC current)

10. Peak value

Function	Response time	Accuracy	Remark
ACV	1ms	± (2%+100)	Display positive and negative peak value of AC signal.
ACA	1ms	± (3%+100)	

XI. Maintenance

 Warning: Before opening the rear cover, switch off the power supply (remove test leads from the input terminal and the circuit).

1. General maintenance

- 1) Clean the case with a damp cloth and detergent. Do not use abrasives or solvents
- 2) If there is any malfunction, stop using the device and send it to maintenance.
- 3) The maintenance and service must be implemented by qualified professionals or designated departments.

2. Replacements

Battery replacement:

To avoid false reading, replace the battery when the battery indicator  appears.

Battery Specification: Alkaline GP 1604A

- 1) Switch the dial to "OFF" position and remove the test leads from the input terminal.
- 2) Take off the protective case. Loosen the screw on battery cover; remove the cover to replace the battery. Please identify the positive and negative pole.

Fuse replacement:

- 1) Switch the dial to "OFF "position and remove the test leads from the input terminal
- 2) Loosen the both screws on the rear cover, and then remove the rear cover to replace the fuse

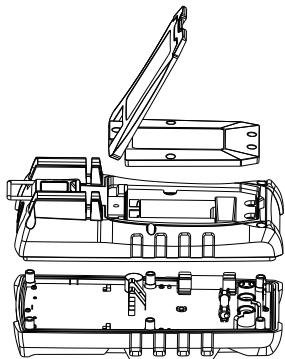

Fuse specification

F1 Fuse $\phi 6 \times 32\text{mm}$ FF 600mA H 600V (CE)F2 Fuse $\phi 10 \times 38\text{mm}$ FF 11A H 1000V (CE)

Uni-Trend reserves the right to update the content of this manual without further notice.

UNI-T[®]**UNI-TREND TECHNOLOGY (CHINA) CO., LTD.**

No6, Gong Ye Bei 1st Road,
Songshan Lake National High-Tech Industrial
Development Zone, Dongguan City,
Guangdong Province, China
Tel: (86-769) 8572 3888
<http://www.uni-trend.com>



彩盒 菲林做货要求：

序号	项目	内容	备注
1	尺寸	尺寸:150*118mm	
2	材质	封面128g铜板 + 内页60g书纸	
3	颜色	单色双面	
4	外观要求	完整清晰、版面整洁，无斑墨、残损、毛边、刀线错位等缺陷。	
5	装订方式	钉装	
6	表面处理		
7	其它	无	
版本		REW	
DWH 设计	宣浩	MODEL 机型: UT191E/T	Part NO. 物料编号: 110401107044X
CHK 审核		 优利德科技(中国)有限公司 UNI-TREND TECHNOLOGY (CHINA) LIMITED	
APPRO. 批准			