

Preliminary Data Sheet SHT3x-ARP

Humidity and Temperature Sensor

- Fully calibrated, linearized, and temperature compensated digital output
- Wide supply voltage range, from 2.4 to 5.5 V
- 10 to 90% ratiometric analog voltage output
- Typical accuracy of $\pm 2\%RH$ and $\pm 0.3^{\circ}C$
- Parallel measurement of temperature and humidity at separate pins
- Tiny 8-Pin DFN package



Product Summary

SHT3x-ARP is the next generation of Sensirion's temperature and humidity sensors. It builds on a new CMOSens® sensor chip that is at the heart of Sensirion's new humidity and temperature platform. The SHT3x-ARP has increased intelligence, reliability and improved accuracy specifications compared to its predecessor. Its functionality includes enhanced signal

processing, temperature and humidity can be read out at different pins. The DFN package has a footprint of 2.5 x 2.5 mm while keeping a height of 0.9 mm. This allows for integration of the SHT3x-ARP into a great variety of applications. Additionally, the wide supply voltage range of 2.4 to 5.5 V guarantees compatibility with diverse assembly situations. All in all, the SHT3x-ARP incorporates 15 years of knowledge of Sensirion, the leader in the humidity sensor industry.

Benefits of Sensirion's CMOSens® Technology

- High reliability and long-term stability
- Industry-proven technology with a track record of more than 15 years
- Designed for mass production
- High process capability
- Low signal noise

Content

1	Sensor Performance.....	2
2	Specifications	4
3	Pin Assignment	5
4	Operation and Communication.....	5
5	Packaging.....	7
6	Shipping Package	9
7	Quality	10
8	Ordering Information.....	10
9	Further Information.....	10

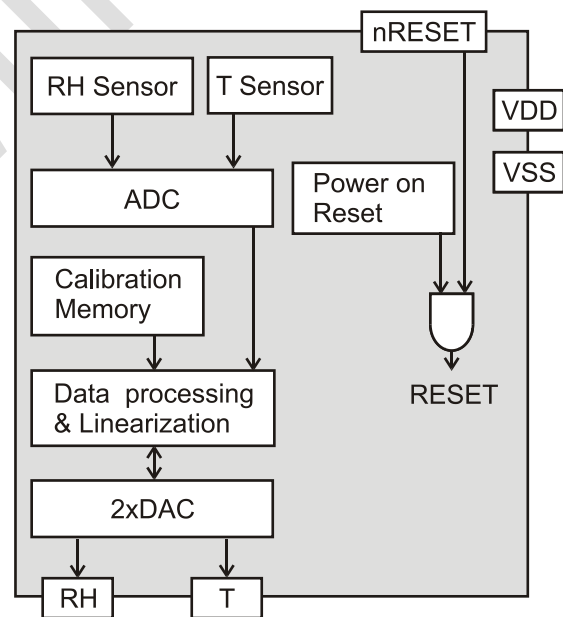

Figure 1 Functional block diagram of the SHT3x-ARP. The sensor signals for humidity and temperature are factory calibrated, linearized and compensated for temperature and supply voltage dependencies.

1 Sensor Performance

1.1 Humidity Sensor Performance

Parameter	Conditions	Value	Units
SHT30 Accuracy tolerance ¹	Typ.	±3	%RH
	Max.	Figure 2	%RH
SHT31 Accuracy tolerance ¹	Typ.	±2	%RH
	Max.	Figure 4	%RH
Repeatability ²		0.2	%RH
Resolution		14	bit
Integrated Non-Linearity ³	Max.	0.2	%RH
Hysteresis	at 25°C	±0.8	%RH
Specified range ⁴	extended ⁵	0 to 100	%RH
Response time ⁶	$\tau_{63\%}$	8	s
Long-term drift	Typ. ⁷	<0.25	%RH/yr

Table 1 Humidity sensor specification

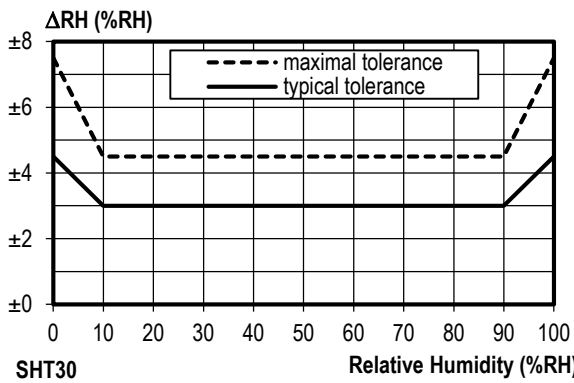

Figure 2 Tolerance of RH at 25°C for SHT30

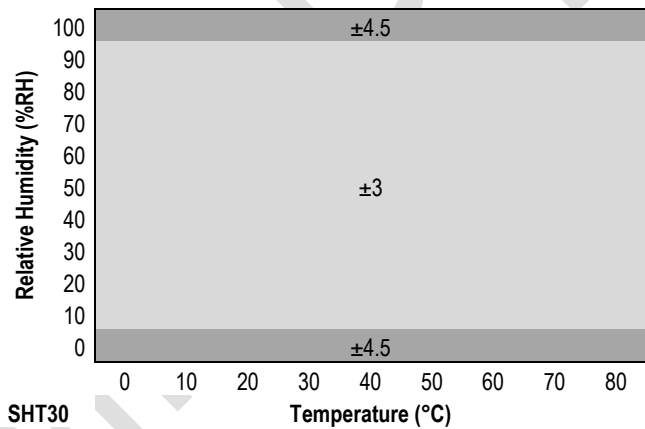

Figure 3 Typical tolerance of RH over T for SHT30

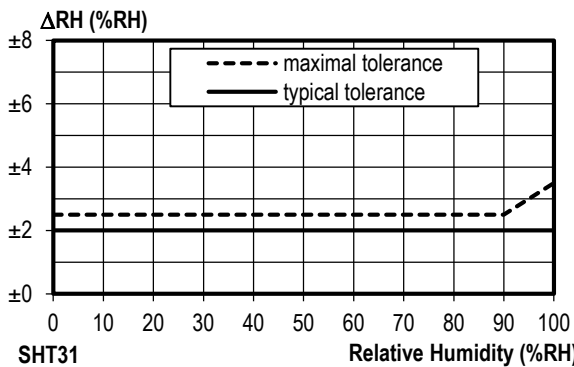

Figure 4 Tolerance of RH at 25°C for SHT31

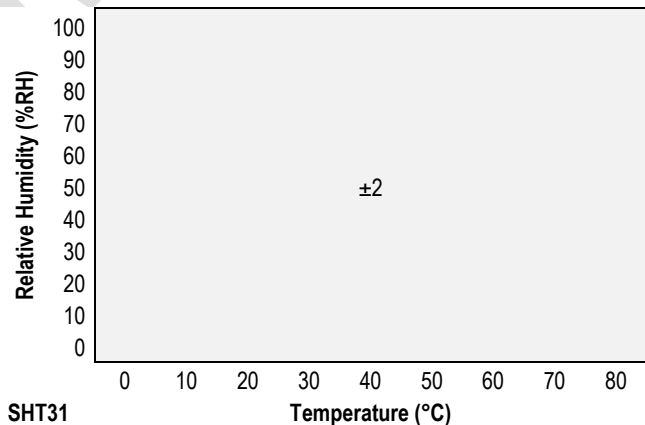

Figure 5 Typical tolerance of RH over T for SHT31

¹ For definition of typical and maximum accuracy tolerance, please refer to the document "Sensirion Humidity Sensor Specification Statement".

² The stated repeatability is 3 times the standard deviation (3σ) of multiple consecutive measurements at constant conditions. It is a measure for the noise on the physical sensor output.

³ Maximum deviation from the ideal shape (linear curve)

⁴ Specified range refers to the range for which the humidity or temperature sensor specification is guaranteed.

⁵ For details about recommended humidity and temperature operating range, please refer to section 0.

⁶ Time for achieving 63% of a humidity step function, valid at 25°C and 1m/s airflow. Humidity response time in the application depends on the design-in of the sensor.

⁷ Typical value for operation in normal RH/T operating range, see section 1.2. Maximum value is < 0.5 %RH/yr. Value may be higher in environments with vaporized solvents, out-gassing tapes, adhesives, packaging materials, etc. For more details please refer to Handling Instructions.

1.2 Temperature Sensor Performance

Parameter	Condition	Value	Units
Accuracy tolerance ¹	Typ. 10 to +55	±0.3	°C
Repeatability ²		0.05	°C
Resolution	Typ.	14	bit
Specified Range	-	-40 to 125	°C
Response time ⁸	$\tau_{63\%}$	>2	s
Long Term Drift	-	<0.03	°C/yr

Table 2 Temperature sensor specification; values are target specs and not confirmed by measurements yet

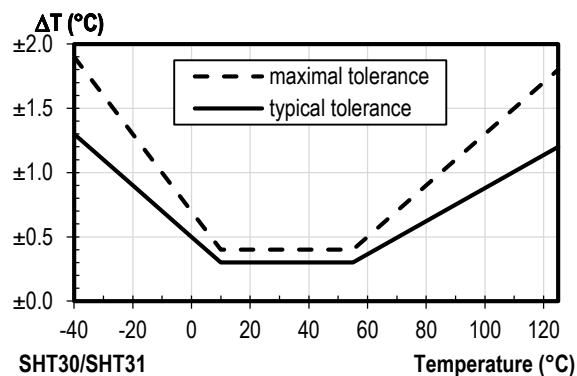

Figure 6 Tolerance of the temperature sensor in °C for the SHT30 and SHT31

1.3 Recommended Operating Condition

The sensor shows best performance when operated within recommended normal temperature and humidity range of 5 – 60 °C and 20 – 80 %RH, respectively. Long term exposure to conditions outside normal range, especially at high humidity, may temporarily offset the RH signal (e.g. +3%RH after 60h at >80%RH). After returning into the normal temperature and humidity range the sensor will slowly come back to calibration state by itself. Prolonged exposure to extreme conditions may accelerate ageing. To ensure stable operation of the humidity sensor, the conditions described in the document “SHTxx Assembly of SMD Packages”, section “Storage and Handling Instructions” regarding exposure to volatile organic compounds have to be met. Please note as well that this does apply not only to transportation and manufacturing, but also to operation of the SHT3x-ARP.

⁸ Temperature response times strongly depends on the design-in of the sensor in the final application. Minimal response time can be achieved when the thermalized sensor at T1 is placed on a well conducting surface with temperature T2.

2 Specifications

2.1 Electrical Specifications

Parameter	Symbol	Condition	Min	Typ.	Max	Units	Comments
Supply voltage	V _{DD}		2.4	3.3	5.5	V	
Power-up/down level	V _{POR}		2.22	2.35	2.4	V	
Supply current	I _{DD}	Average		217		μA	At a measurement rate of 2 Hz. Depends on the resistive load on the output pins
Output current	AO _{IOUT}		-100		100	μA	
Capacitive load	C _L				5	nF	Capacitance that can be driven by the sensor on the signal lines
Duration of reset pulse	t _{RESETN}		350			ns	See section 3.3

Table 3 Electrical specifications, Specification are at 25°C and typical VDD

2.2 Timing Specification for the Sensor System

Parameter	Symbol	Conditions	Min.	Typ.	Max.	Units	Comments
Power-up time	t _{PU}	After hard reset, V _{DD} ≥ V _{POR}			15	ms	Time between V _{DD} reaching V _{POR} and first measurement signal available
Analog output settling time	AO _{settle}	For a step of VDD/2		0.3		ms	Time needed for adapting to a changing supply voltage and measurement value. Value depends on output load. Typical value is for a load of 1nF.

Table 4 System Timing Specification, Specification are at 25°C and typical VDD

2.3 Absolute Minimum and Maximum Ratings

Stress levels beyond those listed in Table 5 may cause permanent damage to the device or affect the reliability of the sensor. These are stress ratings only and functional operation of the device at these conditions cannot be guaranteed.

Parameter	Rating	Units
Supply voltage V _{DD}	-0.5 to 6	V
Max Voltage on pins (pin 1 (RH); pin 2 (R); pin 3 (R); pin 4(T); pin 6(nRESET))	-0.5 to VDD+0.5	V
Input current on any pin	±100	mA
Operating temperature range	-40 to 125	°C
Storage temperature range	-40 to 150	°C
ESD HBM (human body model)	4	kV
ESD MM (machine model)	200	V
ESD CDM (charge device model)	750	V

Table 5 Absolute minimum and maximum ratings; values are target specs and not confirmed by measurements yet

3 Pin Assignment

The SHT3x-ARP comes in a tiny 8-pin DFN package – see Table 6.

Pin	Name	Comments
1	RH	Analog voltage out; output
2	R	No electrical function; recommended to connected to VSS
3	R	No electrical function; recommended to connected to VSS
4	T	Analog voltage out; output
5	VDD	Supply voltage; input
6	nRESET	Reset pin active low; Input; if not used it is recommended to connect to VDD
7	R	No electrical function; recommended to connected to VSS
8	VSS	Ground

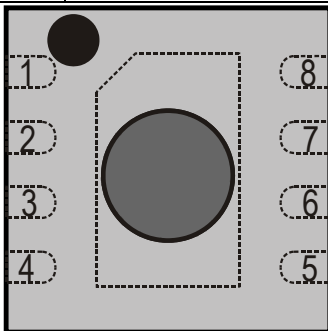

Table 6 SHT3x-ARP pin assignment (Transparent top view). Dashed lines are only visible from the bottom. The die pad is internally connected to VSS.

3.1 Power Pins (VDD, VSS)

The electrical specifications of the SHT3x-ARP are shown in Table 3. The power supply pins must be decoupled with a 100 nF capacitor that shall be placed as close to the sensor as possible – see Figure 7 for a typical application circuit.

3.2 Temperature and Humidity Pin

The physical output of temperature and humidity can be read out at separated pins, as shown in Table 6. Data is supplied as ratiometric voltage output, ranging from 10 to 90% of VDD. The specification of the Analog voltage signal and its conversion to physical values is explained in Section 4.

3.3 nRESET Pin

The nReset pin may be used to generate a reset of the sensor. A minimum pulse duration of 350 ns is required to reliably trigger a reset of the sensor. If not used it is recommended to connect to VDD.

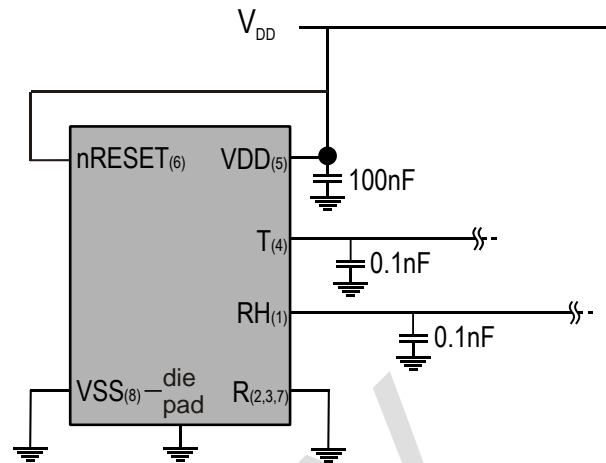

Figure 7 Typical application circuit. Please note that the positioning of the pins does not reflect the position on the real sensor. This is shown in Table 6.

3.4 Die Pad (center pad)

The die pad or center pad is visible from below and located in the center of the package. It is electrically connected to VSS. Hence electrical considerations do not impose constraints on the wiring of the die pad. However, due to mechanical reasons it is recommended to solder the center pad to the PCB. For more information on design-in, please refer to the document “SHTxx Design Guide”.

4 Operation and Communication

4.1 Start-up of the sensor

As a first step, the sensor needs to be powered up to VDD (between 2.4 and 5.5 V). After power-up, the sensor needs at most 15 ms for providing data as voltage output on the respective output pins. During that time the temperature and humidity pins have an undefined state.

4.2 Conversion of the Signal Output

The physical values as measured by the sensor are mapped to a ratiometric voltage output (V_x , $x=T, RH$ as 10 to 90% of V_{DD}). Prior to conversion into a voltage signal, the physical values are linearized and compensated for temperature and supply voltage effects by the sensor. Additionally, the voltage output is calibrated for each sensor. Hence the relationship between temperature and humidity and the voltage output is the same for each sensor, within the limits given by the accuracy.

This allows to describe the relationship between physical values (RH and T) and the voltage output for temperature and humidity (V_x , $x=T, RH$) through a generic linear formula shown in Equation 1 (for RH) and Equation 2 (for T), its graphical representation can be found in Figure 8 & Figure 9.

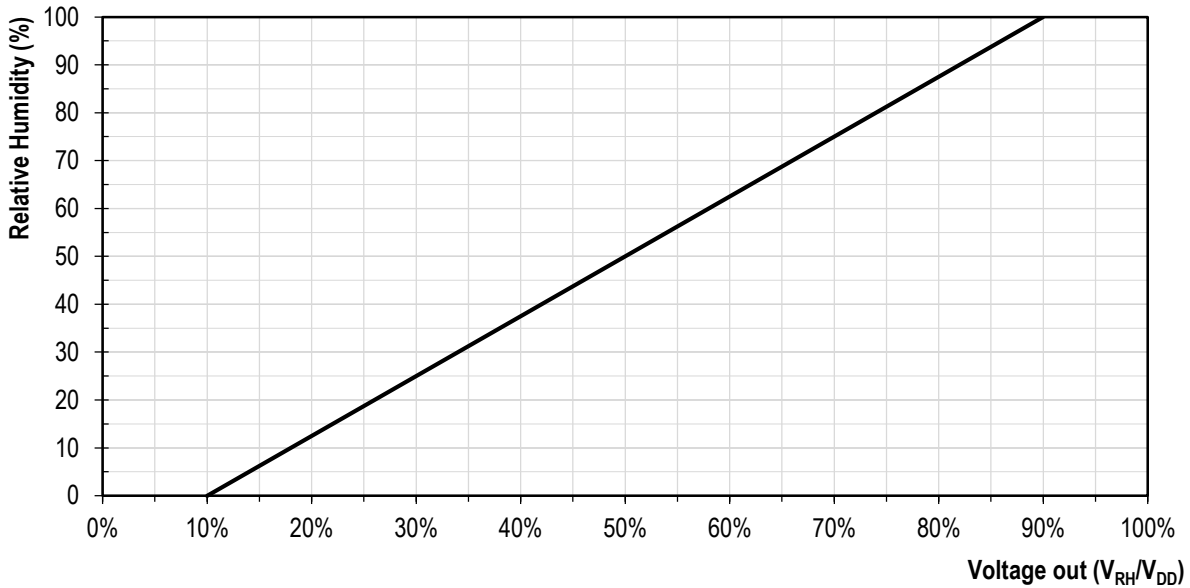

Figure 8 Relationship between the ratiometric analog voltage output and the measured relative humidity

$$RH = -12.5 + 125 \cdot \frac{V_{RH}}{V_{DD}} = -\frac{10}{0.8} + \frac{100}{0.8} \cdot \frac{V_{RH}}{V_{DD}}$$

Equation 1 Relative humidity conversion formula (result in %RH):

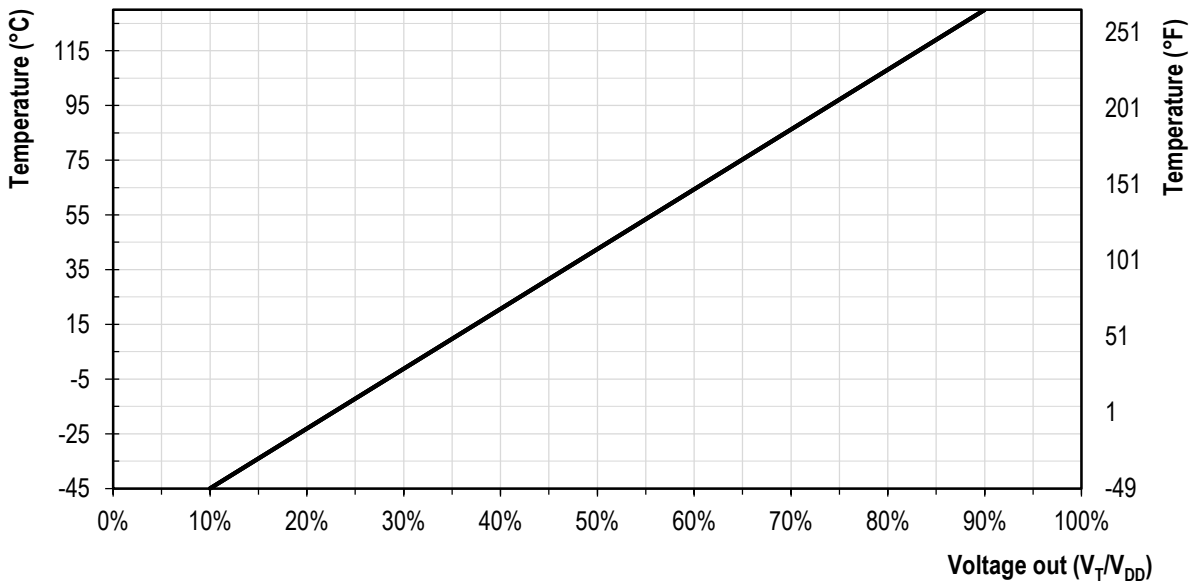

Figure 9 Relationship between the ratiometric analog voltage output and the measured temperature

$$T [^{\circ}C] = -66.875 + 218.75 \cdot \frac{V_T}{V_{DD}} = -45 - \frac{17.5}{0.8} + \frac{175}{0.8} \cdot \frac{V_T}{V_{DD}}$$

$$T [^{\circ}F] = -88.375 + 393.75 \cdot \frac{V_T}{V_{DD}} = -49 - \frac{31.5}{0.8} + \frac{315}{0.8} \cdot \frac{V_T}{V_{DD}}$$

Equation 2 Temperature conversion formula (result in °C and °F respectively)

5 Packaging

SHT3x-ARP sensors are provided in a DFN package. DFN stands for dual flat no leads. The humidity sensor opening is centered on the top side of the package.

The sensor chip is made of silicon and is mounted to a lead frame. The latter is made of Cu plated with Ni/Pd/Au. Chip and lead frame are overmolded by an epoxy-based mold compound leaving the central die pad and I/O pins exposed for mechanical and electrical connection. Please note that the side walls of the sensor are diced and therefore these diced lead frame surfaces are not covered with the respective plating.

5.1 Traceability

All SHT3x-ARP sensors are laser marked for easy identification and traceability. The marking on the sensor top side consists of a pin-1 indicator and two lines of text.

The top line consist of the pin-1 indicator which is located in the top left corner and the product name. The small letter x stands for the accuracy class.

The bottom line consists of 6 letters. The first two digits XY (=AR) describe the output mode. The third letter (A) represents the manufacturing year (4 = 2014, 5 = 2015,

etc). The last three digits (BCD) represent an alphanumeric tracking code. That code can be decoded by Sensirion only and allows for tracking on batch level through production, calibration and testing – and will be provided upon justified request.

If viewed from below pin 1 is indicated by triangular shaped cut in the otherwise rectangular die pad. The dimension of the triangular cut are shown in Figure 11 through the labels T1 & T2.

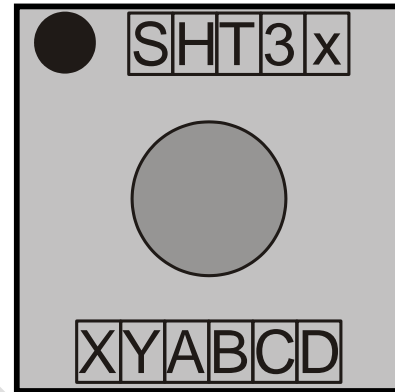

Figure 10 Top View of the SHT3x-ARP illustrating the laser marking.

5.2 Package Outline

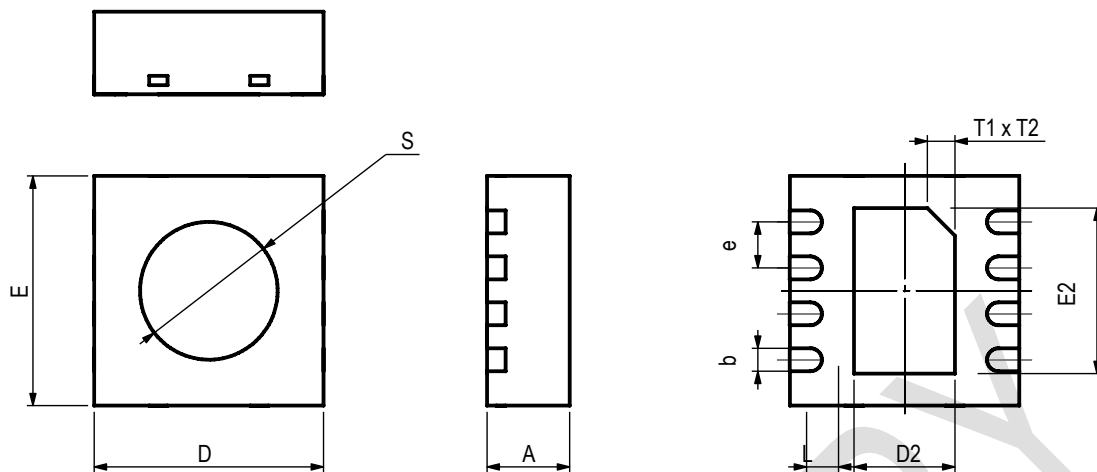

Figure 11 Dimensional drawing of SHT3x-ARP sensor package

Parameter	Symbol	Min	Nom.	Max	Units	Comments
Package height	A	0.8	0.9	1	mm	
Leadframe height	A3		0.2		mm	Not shown in the drawing
Pad width	b	0.2	0.25	0.3	mm	
Package width	D	2.4	2.5	2.6	mm	
Center pad length	D2	1	1.1	1.2	mm	
Package length	E	2.4	2.5	2.6	mm	
Center pad width	E2	1.7	1.8	1.9	mm	
Pad pitch	e		0.5		mm	
Pad length	L	0.3	0.35	0.4	mm	
Max cavity	S			1.5	mm	Only as guidance. This value includes all tolerances, including displacement tolerances. Typically the opening will be smaller.
Center pad marking	T1xT2		0.3x45°		mm	indicates the position of pin 1

Table 7 Package outline

5.3 Land Pattern

Figure 12 shows the land pattern. The land pattern is understood to be the metal layer on the PCB, onto which the DFN pads are soldered.

The solder mask is understood to be the insulating layer on top of the PCB covering the copper traces. It is recommended to design the solder mask as a Non-Solder Mask Defined (NSMD) type. For NSMD pads, the solder mask opening should provide a 60 µm to 75 µm design clearance between any copper pad and solder mask. As the pad pitch is only 0.5 mm we recommend to have one solder mask opening for all 4 I/O pads on one side.

For solder paste printing it is recommended to use a laser-cut, stainless steel stencil with electro-polished trapezoidal walls and with 0.1 or 0.125 mm stencil thickness. The length of the stencil apertures for the I/O pads should be the same as the PCB pads. However, the position of the stencil apertures should have an offset of 0.1 mm away from the center of the package. The die pad aperture should cover about 70 – 90 % of the die pad area –thus it should have a size of about 0.9 mm x 1.6 mm.

For information on the soldering process and further recommendation on the assembly process please consult the Application Note HT_AN_SHTxx_Assembly_of_SMD_Packages , which can be found on the Sensirion webpage.

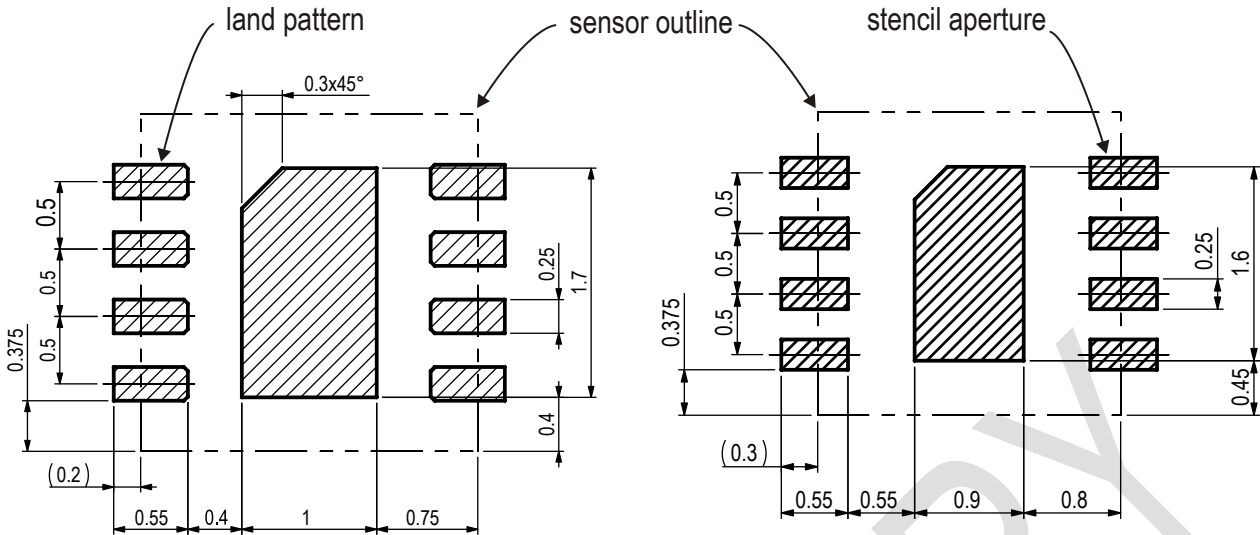

Figure 12 Recommended metal land pattern and stencil apertures for the SHT3x-ARP. The dashed lines represent the outer dimension of the DFN package. The PCB pads and stencil apertures are indicated through the shaded areas.

6 Shipping Package

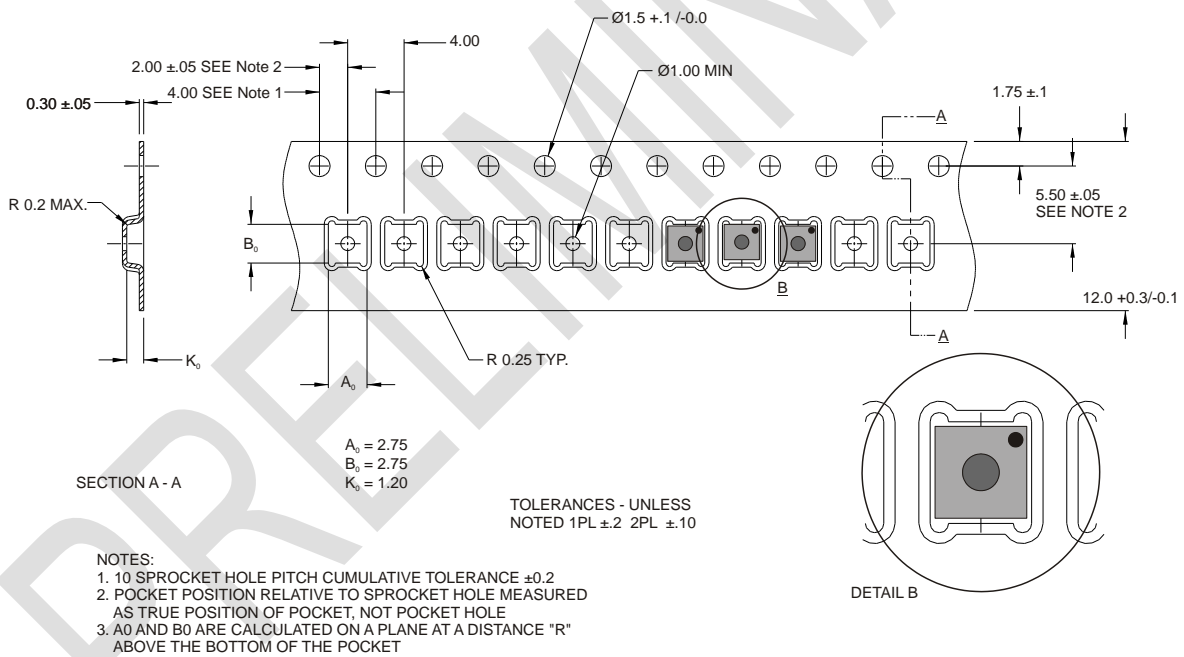

Figure 13 Technical drawing of the packaging tape with sensor orientation in tape. Header tape is to the right and trailer tape to the left on this drawing. Dimensions are given in millimeters.

7 Quality

Qualification of the SHT3x-ARP is performed based on the AEC Q 100 qualification test method.

7.1 Material Contents

The device is fully RoHS and WEEE compliant, e.g. free of Pb, Cd, and Hg.

8 Ordering Information

This sensor cannot be ordered so far. Samples are available upon request. Please contact Sensirion.

9 Further Information

For more in-depth information on the SHT3x-ARP and its application please consult the following documents:

Document Name	Description	Source
SHT3x Shipping Package	Information on Tape, Reel and shipping bags (technical drawing and dimensions)	Available upon request
SHTxx Assembly of SMD Packages	Assembly Guide (Soldering Instruction,)	Available for download at the Sensirion humidity sensors download center: www.sensirion.com/humidity-download
SHTxx Design Guide	Design guidelines for designing SHTxx humidity sensors into applications	Available for download at the Sensirion humidity sensors download center: www.sensirion.com/humidity-download
SHTxx Handling Instructions	Guidelines for proper handling of SHTxx humidity sensors (Reconditioning Procedure)	Available for download at the Sensirion humidity sensors download center: www.sensirion.com/humidity-download
Sensirion Humidity Sensor Specification Statement	Definition of sensor specifications.	Available for download at the Sensirion humidity sensors download center: www.sensirion.com/humidity-download

Table 8 Documents containing further information relevant for the SHT3x-ARP.

Revision History

Date	Version	Page(s)	Changes
	0.9		Initial release

Headquarters and Subsidiaries

SENSIRION AG
Laubisruestr. 50
CH-8712 Staefa ZH
Switzerland

phone: +41 44 306 40 00
fax: +41 44 306 40 30
info@sensirion.com
www.sensirion.com

Sensirion AG (Germany)
phone: +41 44 927 11 66
info@sensirion.com
www.sensirion.com

Sensirion Inc., USA
phone: +1 805 409 4900
info_us@sensirion.com
www.sensirion.com

Sensirion Japan Co. Ltd.
phone: +81 3 3444 4940
info@sensirion.co.jp
www.sensirion.co.jp

Sensirion Korea Co. Ltd.
phone: +82 31 337 7700 3
info@sensirion.co.kr
www.sensirion.co.kr

Sensirion China Co. Ltd.
phone: +86 755 8252 1501
info@sensirion.com.cn
www.sensirion.com.cn

To find your local representative, please visit
<http://www.sensirion.com/contact>

PRELIMINARY