

Title: FireBeetle Covers-ePaper Black&White Display Module(SPI)	SKU: DFR0511
Drawn: Lf-CD	Revision: V1.0
Page: 1 of 1	Size: A4
Date: 2017/11/14	Time: 9:23:16

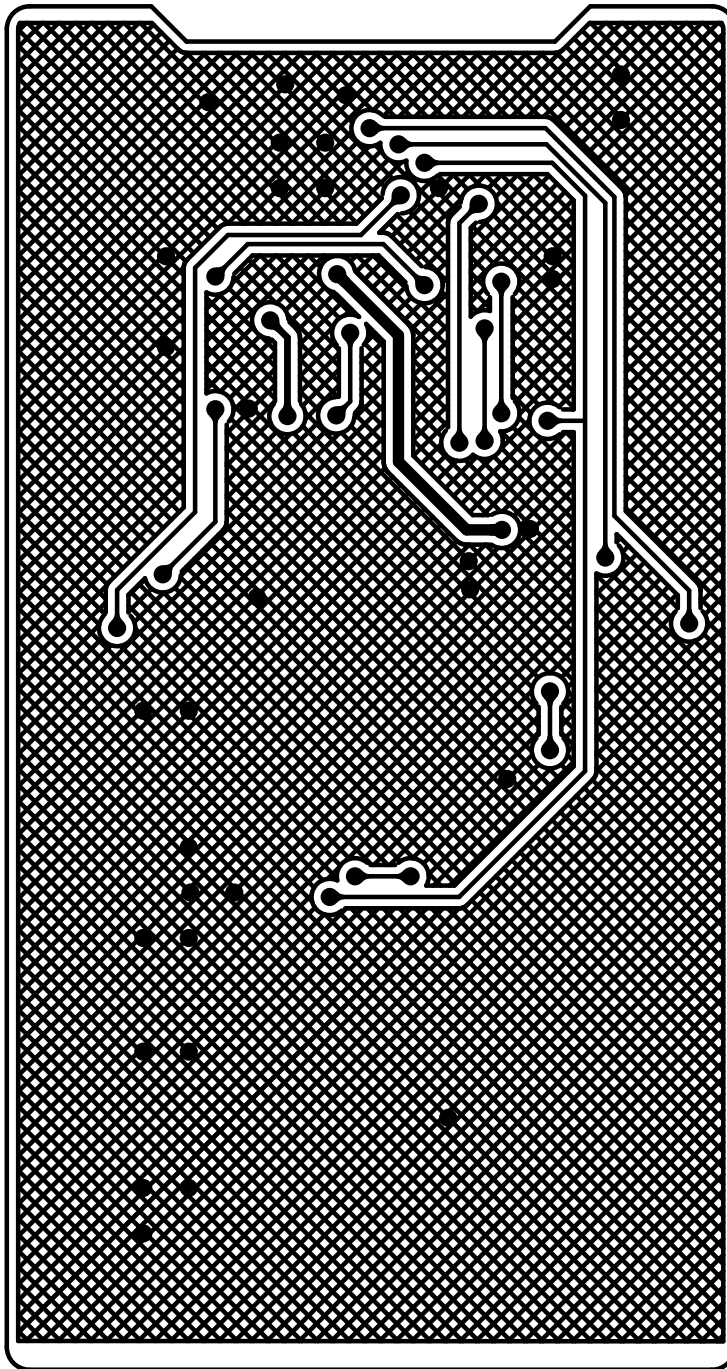

<b>PCB Information</b>	Name:DFR05H(V1.0)	Thickness: 1.6mm
Engineer: LF_CD	Top SolderMask: Black	Bottom SolderMask: Black
Date: 2017/1/3	Top Silkscreen: White	Bottom Silkscreen: White

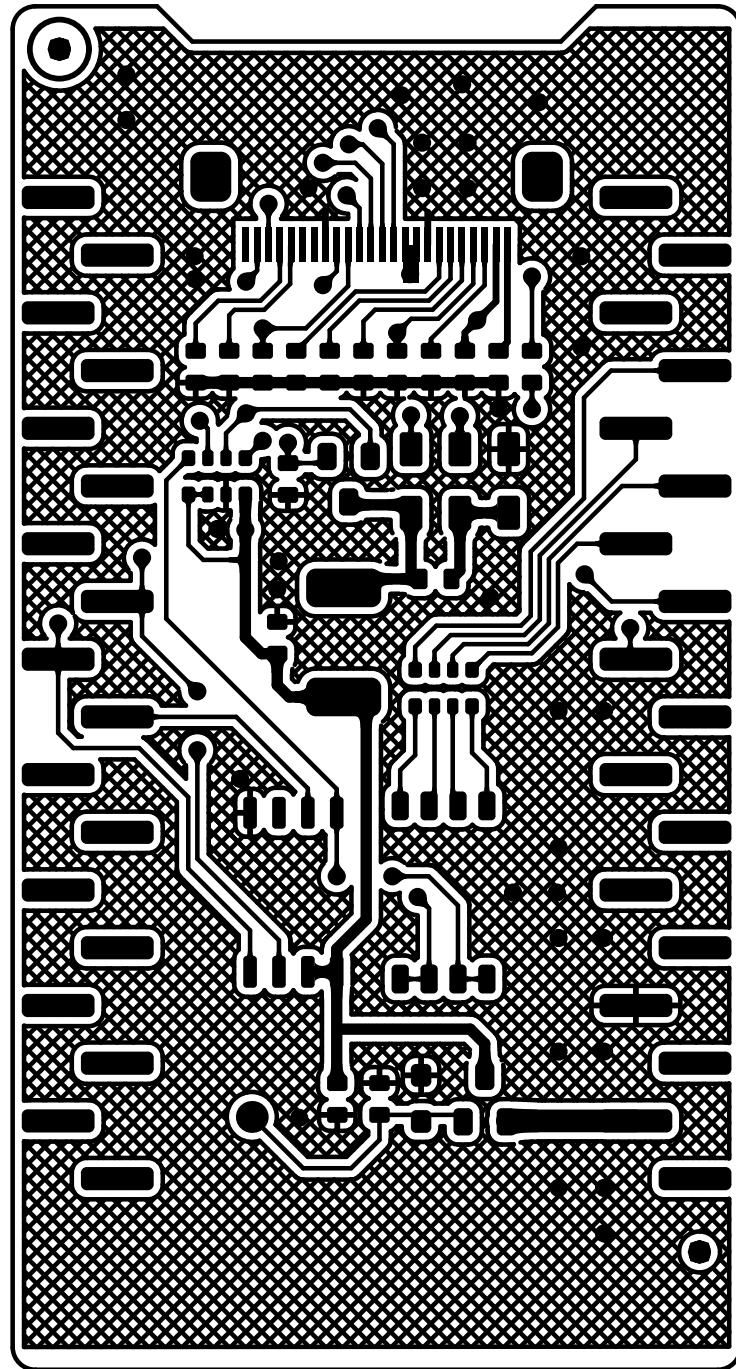

<b>PCB Information</b>	Name: DFR051(V1.0)	Thickness: 1.6mm
Engineer: LF_CD	Top SolderMask: Black	Bottom SolderMask: Black
Date: 2017/11/3	Top Silkscreen: White	Bottom Silkscreen: White

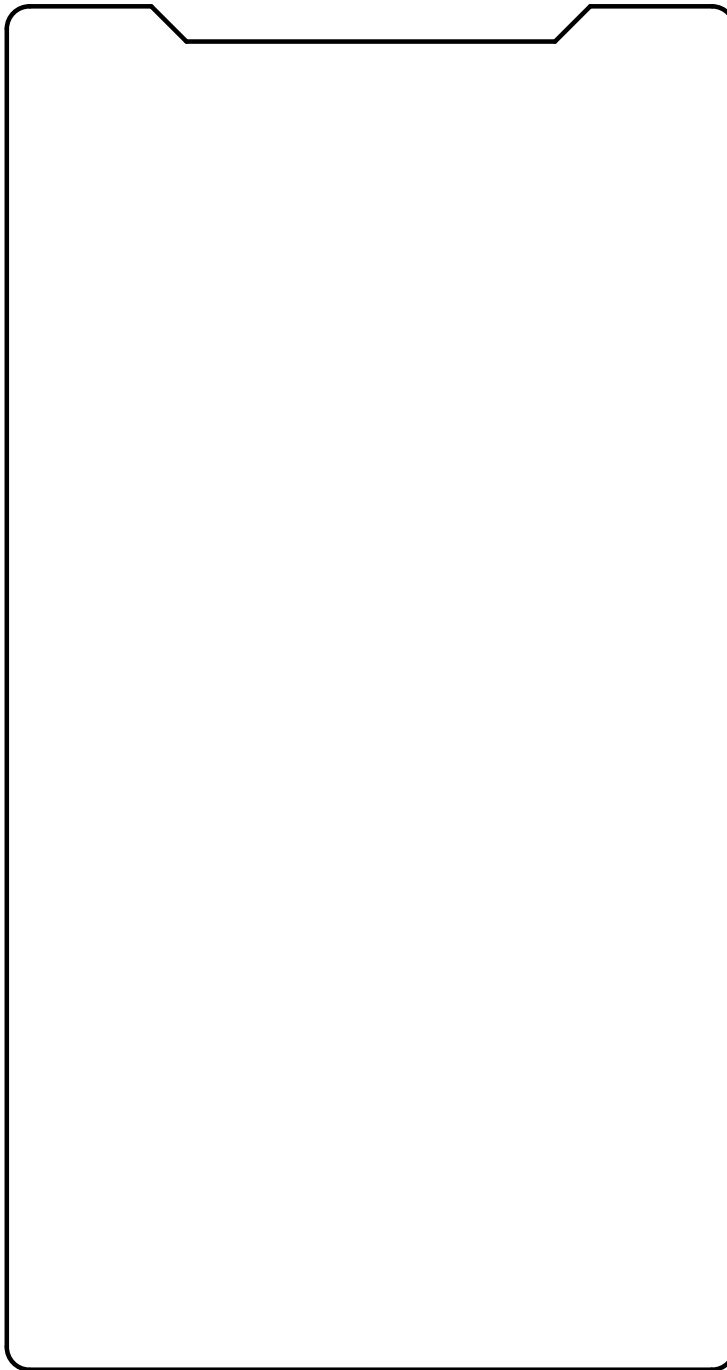

<b>PCB Information</b>	Name:DFR05H(V1.0)	Thickness: 1.6mm
Engineer: LF_CD	Top SolderMask: Black	Bottom SolderMask: Black
Date: 2017/11/3	Top Silkscreen: White	Bottom Silkscreen: White

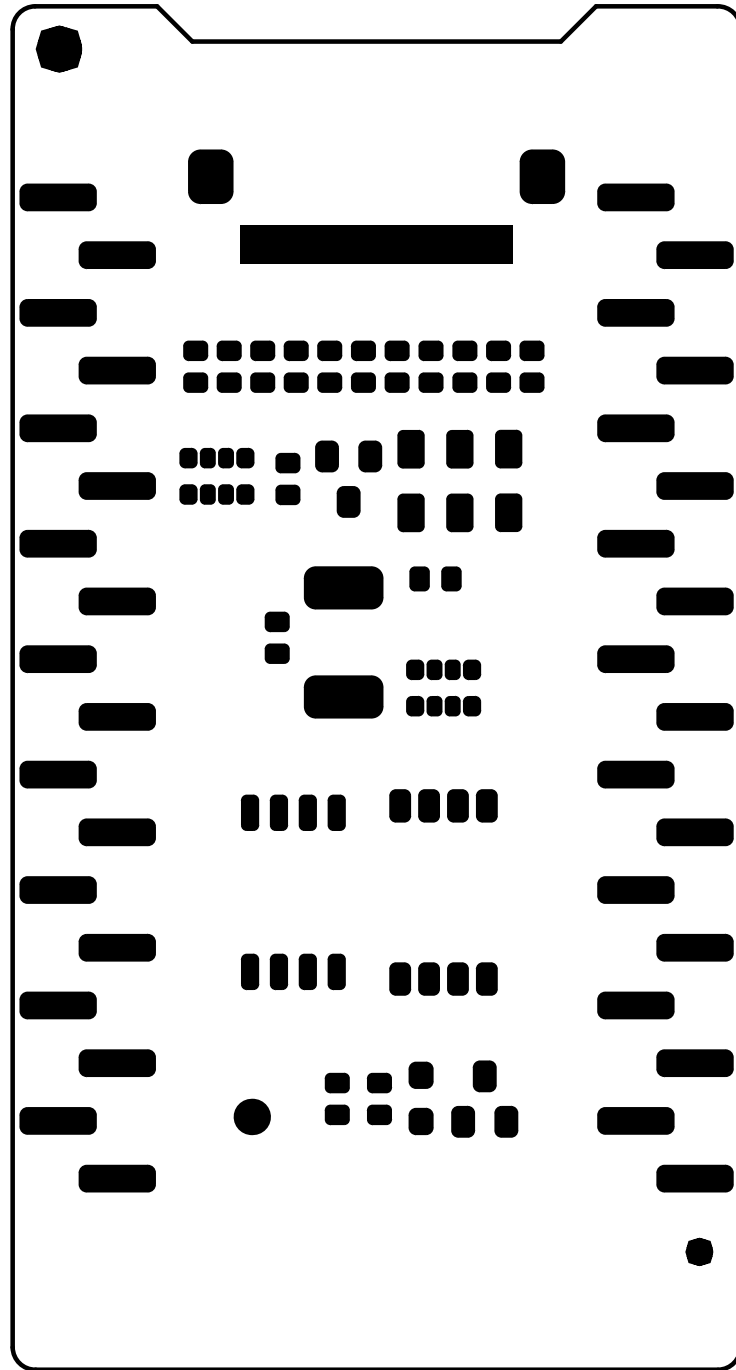

<b>PCB Information</b>	Name: DFR051[V1.0]	Thickness: 1.6mm
Engineer: LF_CD	Top SolderMask: Black	Bottom SolderMask: Black
Date: 2017/11/3	Top Silkscreen: White	Bottom Silkscreen: White

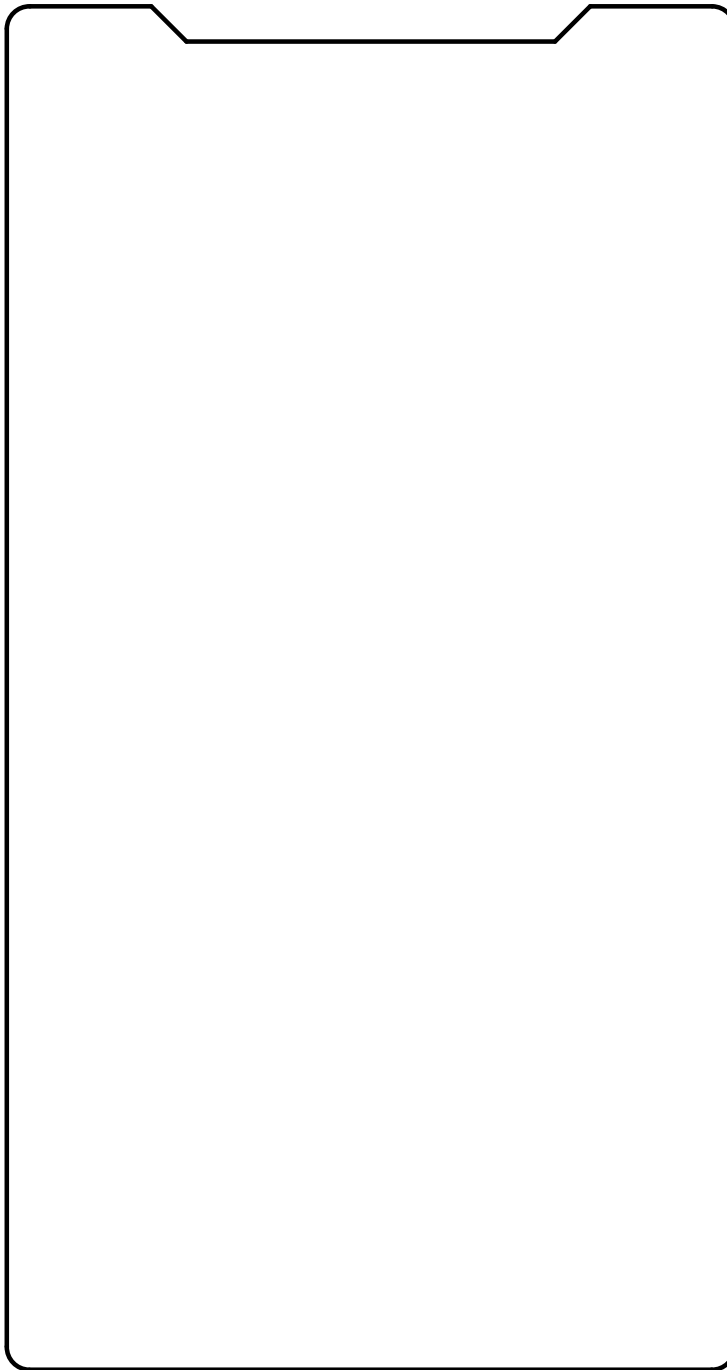

<b>PCB Information</b>	Name:DFR05H(V1.0)	Thickness: 1.6mm
Engineer: LF_CD	Top SolderMask: Black	Bottom SolderMask: Black
Date: 2017/11/3	Top Silkscreen: White	Bottom Silkscreen: White

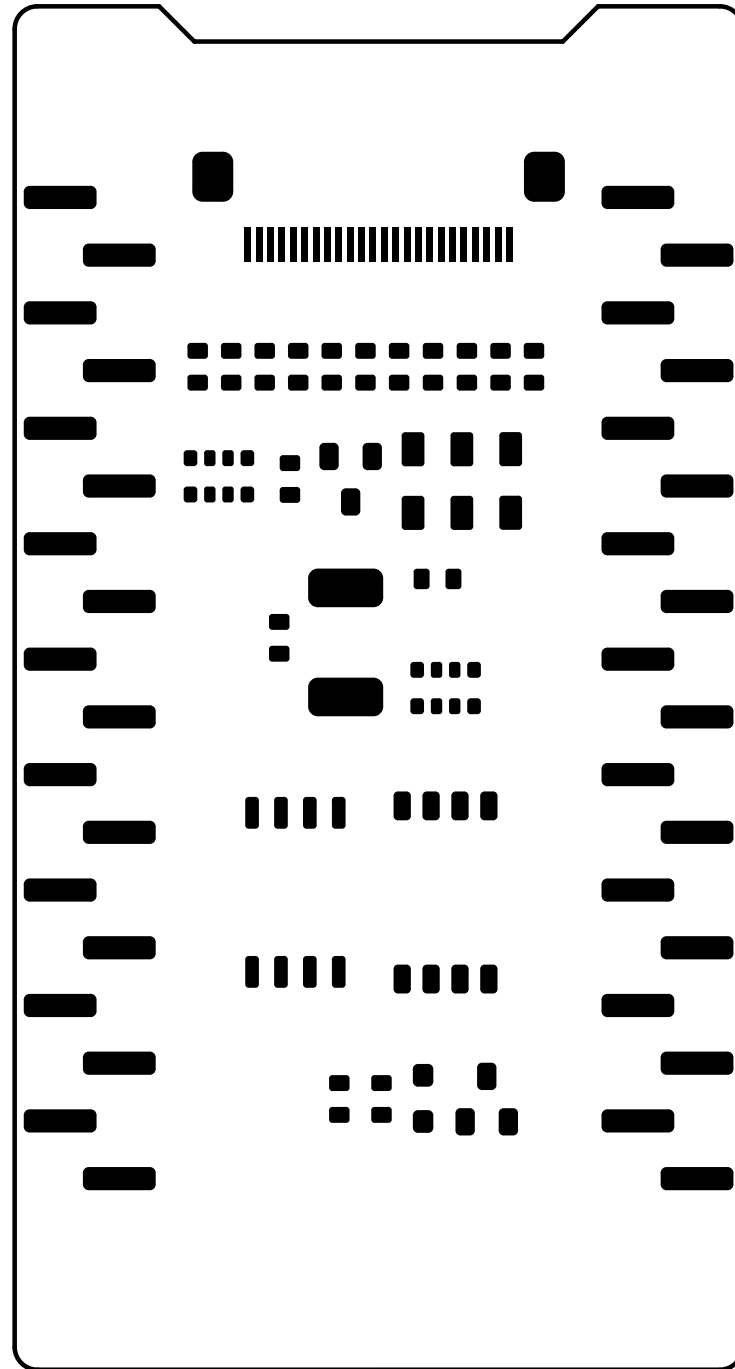

<b>PCB Information</b>	Name: DFR051[V1.0]	Thickness: 1.6mm
Engineer: LF_CD	Top SolderMask: Black	Bottom SolderMask: Black
Date: 2017/11/3	Top Silkscreen: White	Bottom Silkscreen: White

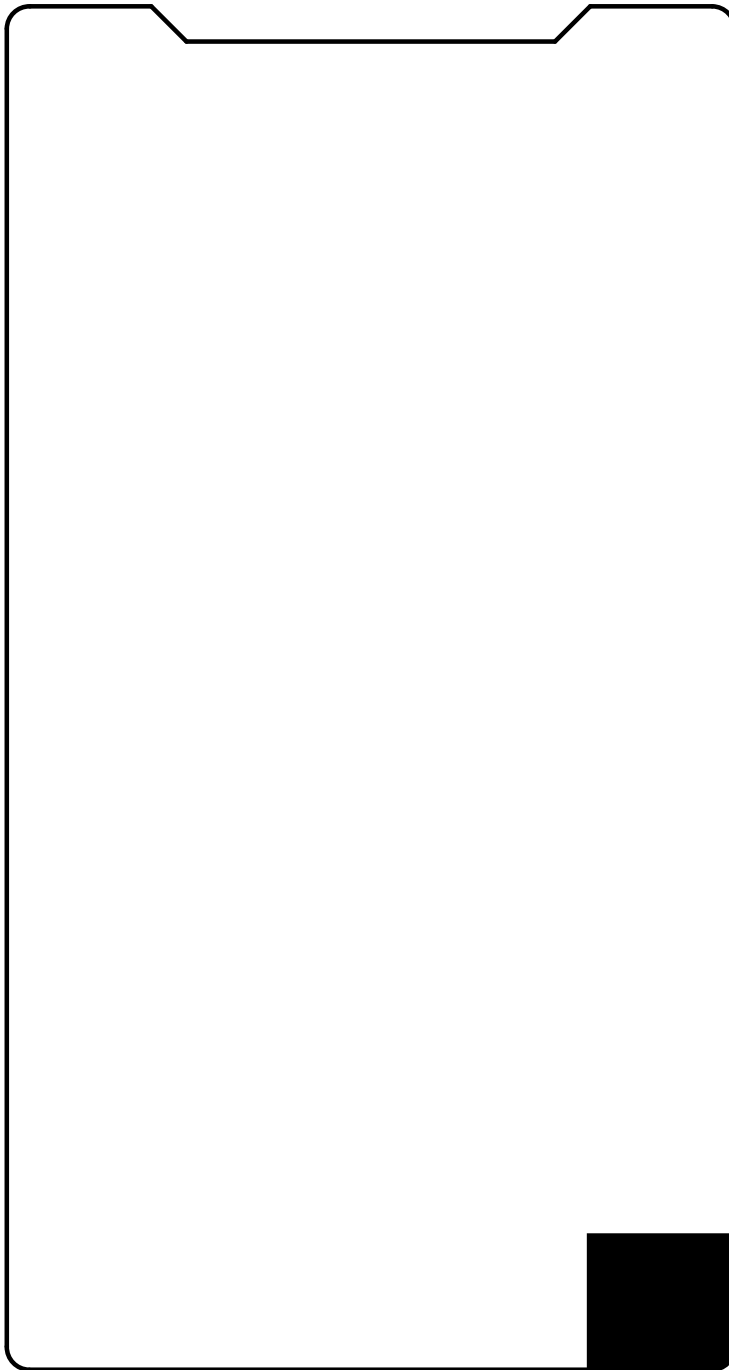

<b>PCB Information</b>	Name:DFR05H(V1.0)	Thickness: 1.6mm
Engineer: LF_CD	Top SolderMask: Black	Bottom SolderMask: Black
Date: 2017/11/3	Top Silkscreen: White	Bottom Silkscreen: White



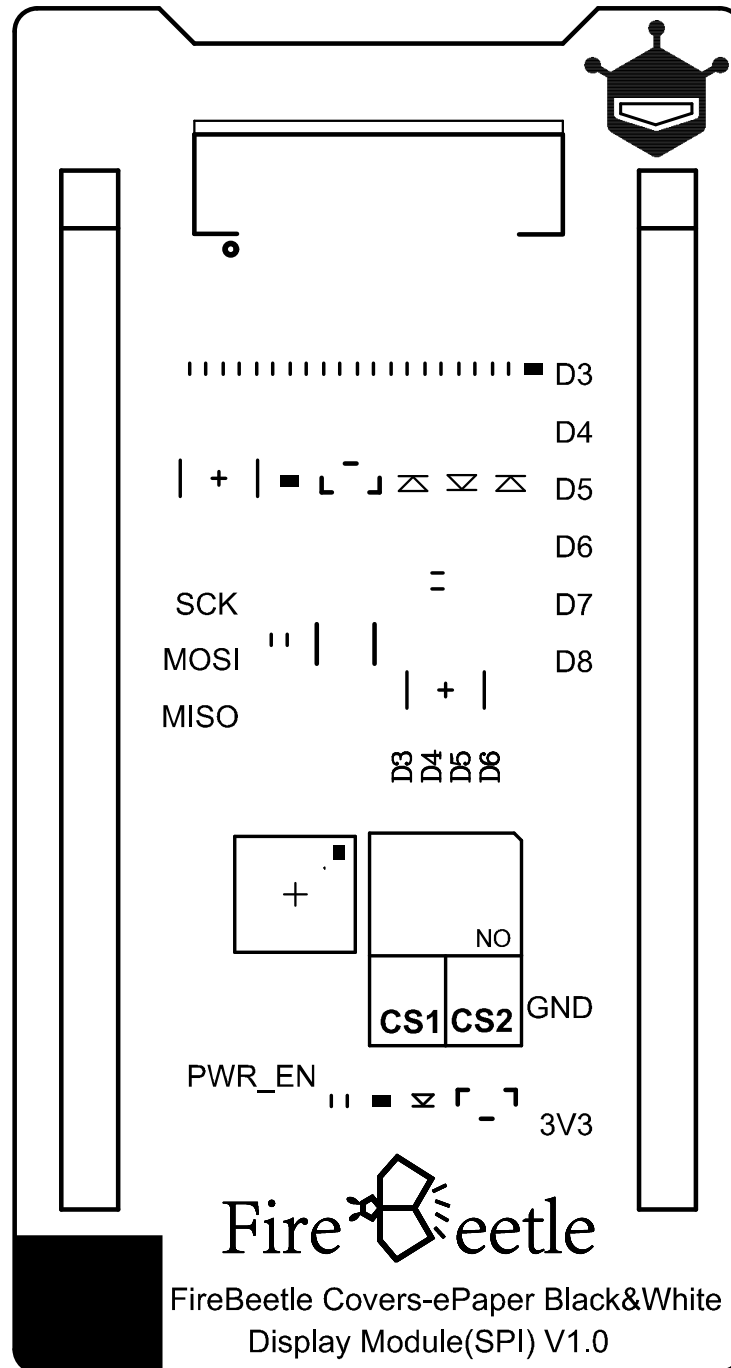

PCB Information	Name:DFR051[V1.0]	Thickness: 1.6mm
Engineer: LF_CD	Top SolderMask: Black	Bottom SolderMask: Black
Date:20171113	Top Silkscreen: White	Bottom Silkscreen: White

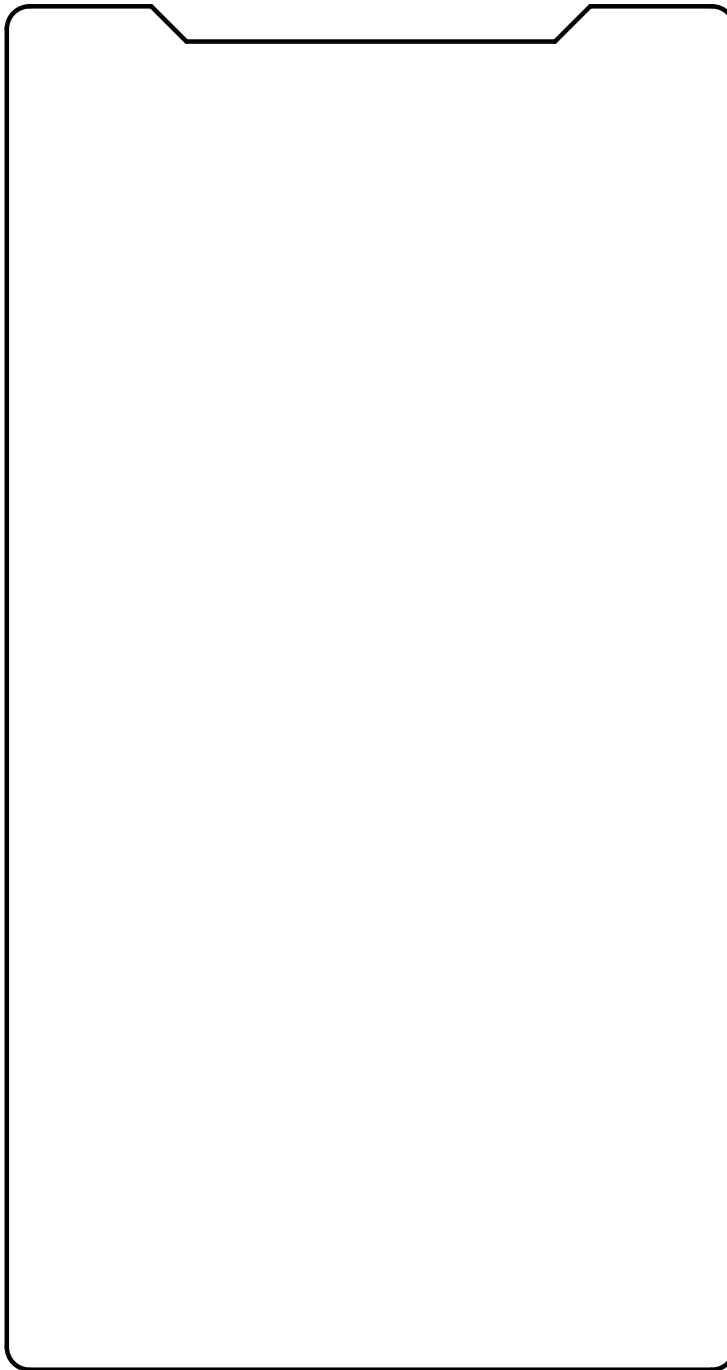

<b>PCB Information</b>	Name:DFR05H(V1.0)	Thickness: 1.6mm
Engineer: LF_CD	Top SolderMask: Black	Bottom SolderMask: Black
Date: 2017/11/3	Top Silkscreen: White	Bottom Silkscreen: White

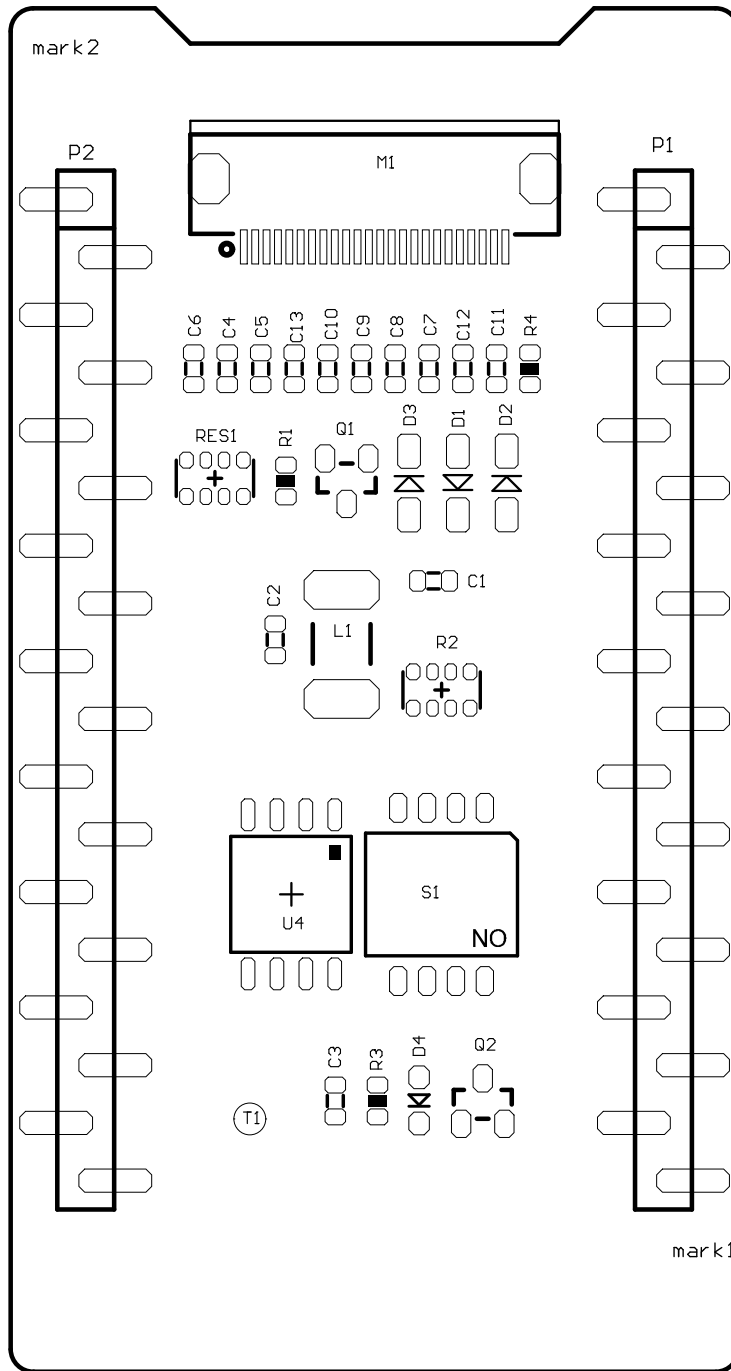

PCB Information	Name:DFR051(V1.0)	Thickness: 1.6mm
Engineer: LF_CD	Top SolderMask: Black	Bottom SolderMask: Black
Date:20171113	Top Silkscreen: White	Bottom Silkscreen: White

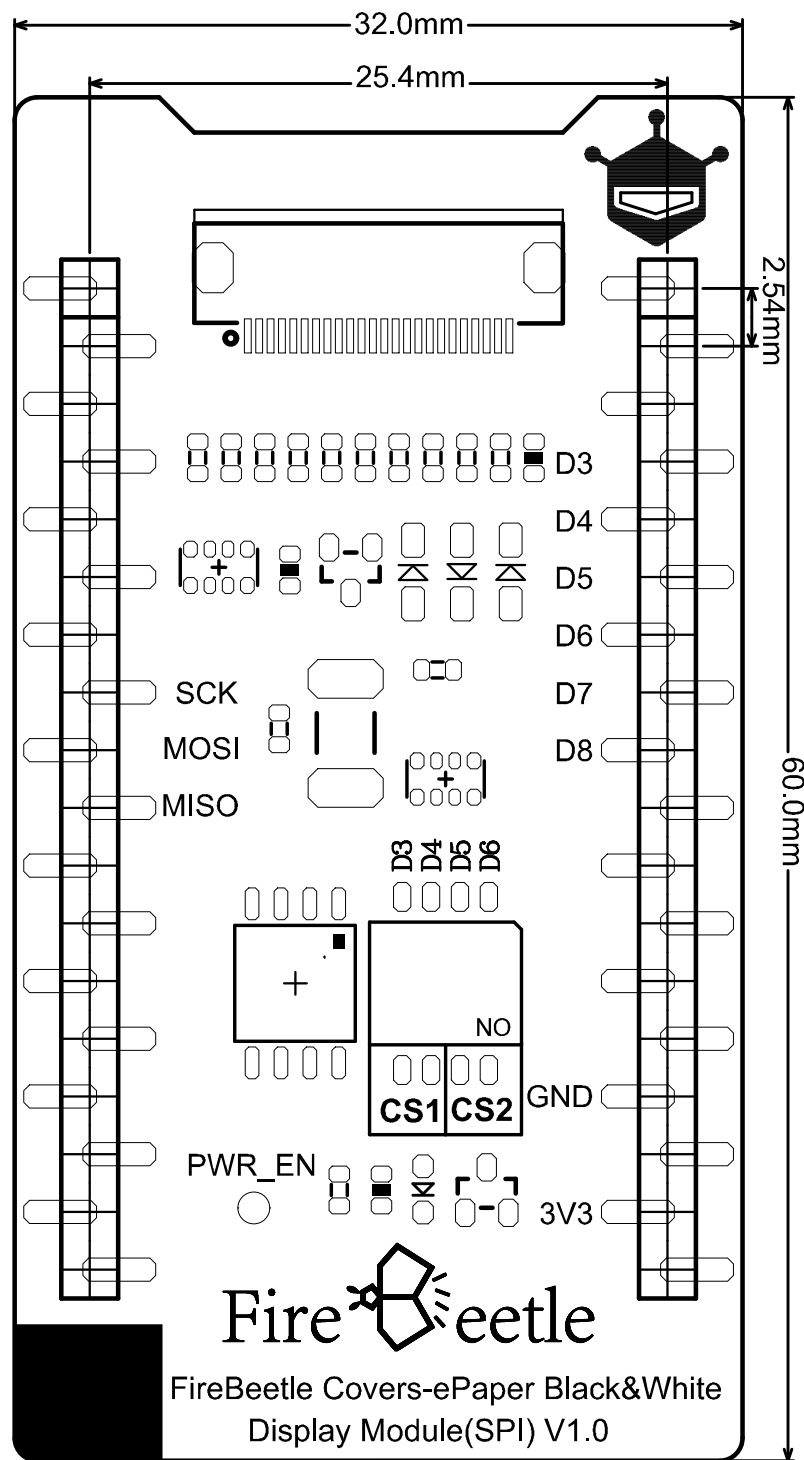

<b>PCB Information</b>	Name:DFR051(V1.0)	Thickness: 1.6mm
Engineer: LF_CD	Top SolderMask: Black	Bottom SolderMask: Black
Date:20171113	Top Silkscreen: White	Bottom Silkscreen: White

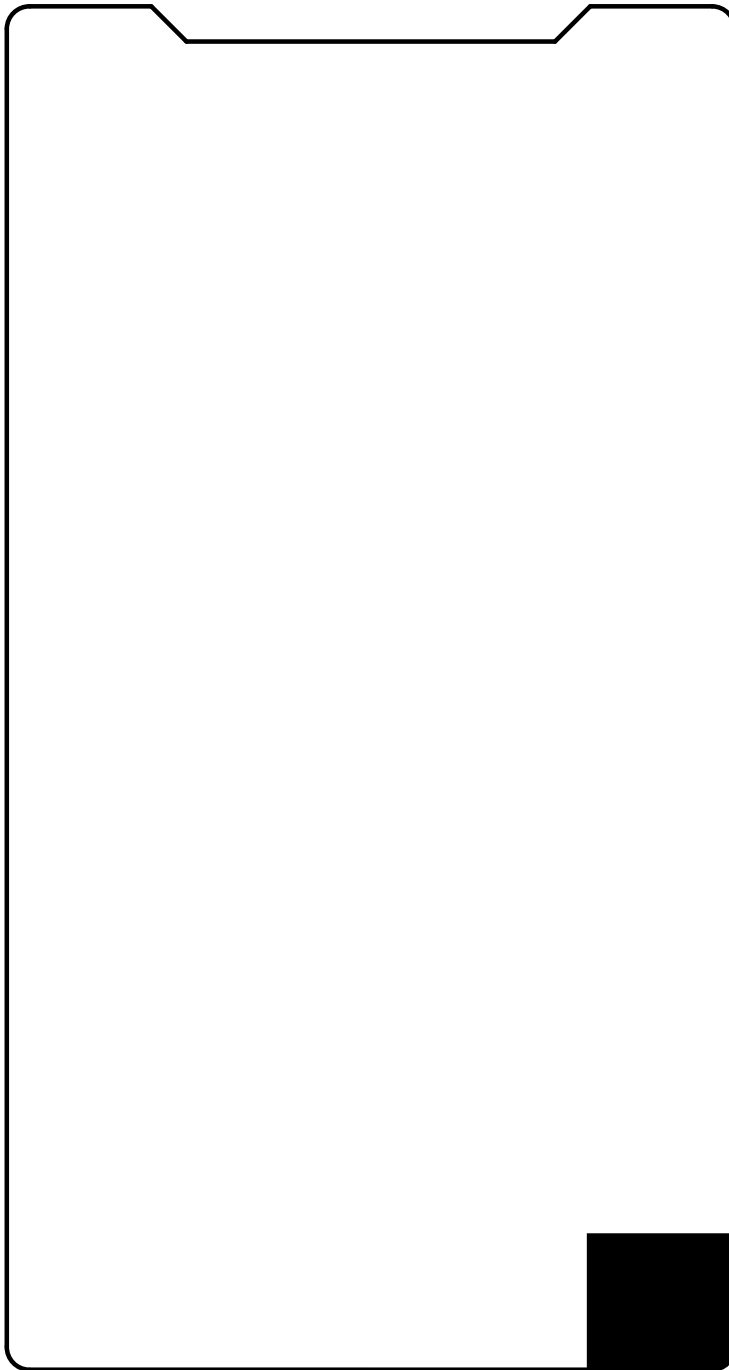

<b>PCB Information</b>	Name:DFR05H(V1.0)	Thickness: 1.6mm
Engineer: LF_CD	Top SolderMask: Black	Bottom SolderMask: Black
Date: 2017/11/3	Top Silkscreen: White	Bottom Silkscreen: White

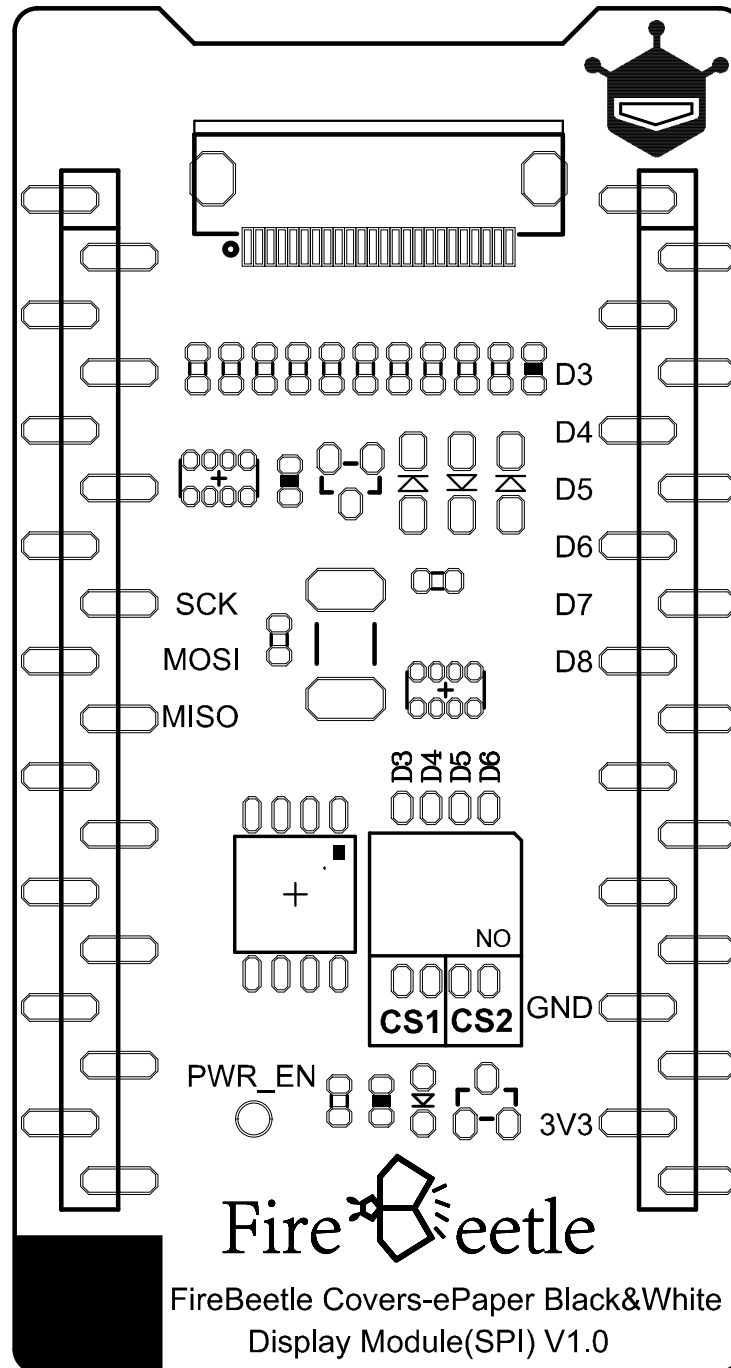

PCB Information	Name:DFR051(V1.0)	Thickness: 1.6mm
Engineer: LF_CD	Top SolderMask: Black	Bottom SolderMask: Black
Date:20171113	Top Silkscreen: White	Bottom Silkscreen: White