

# POWER

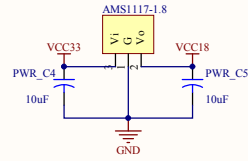

# UART

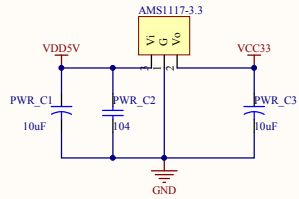
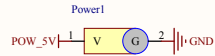
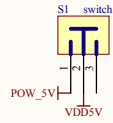
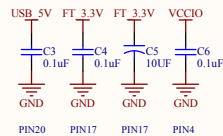
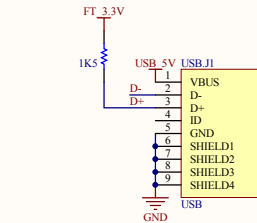
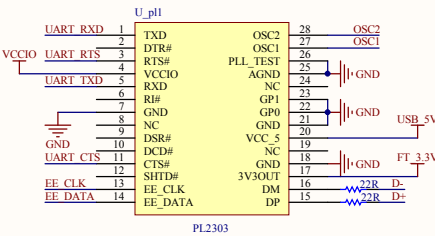
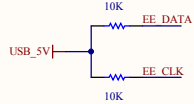
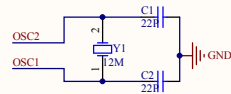

# WIFI

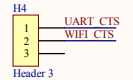
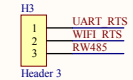
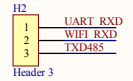
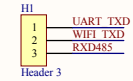
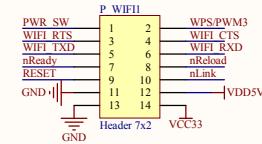
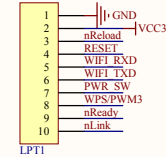
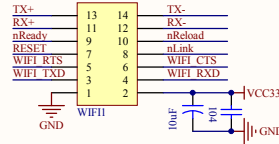

# KEY

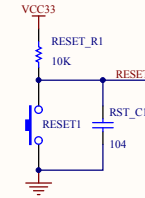
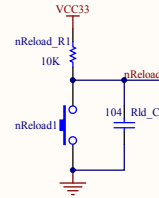

# LED

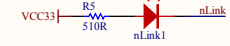
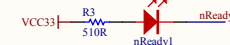
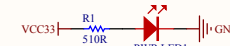

# RJ45

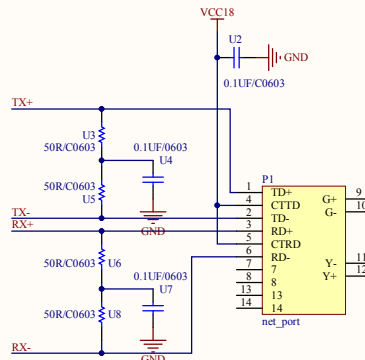

# 485

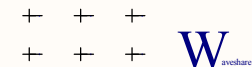
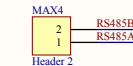
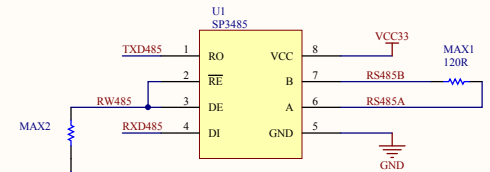

Title		
Size	Number	Revision
A3		
Date:	2014/5/29	Sheet of
File:	F:\PCB- \_\WIF1501.SchDoc	Drawn By: