

UNO I/O PIN\_PART

OUTSIDE CIRCUIT\_PART

COMMUNICATION PIN\_PART

OUTPUT PIN\_PART

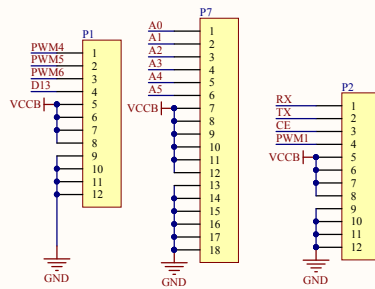
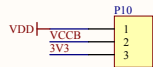
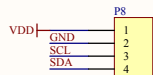

PIN\_PART

POWER\_PART

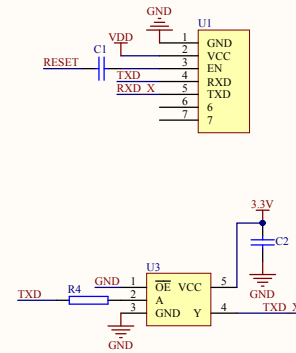
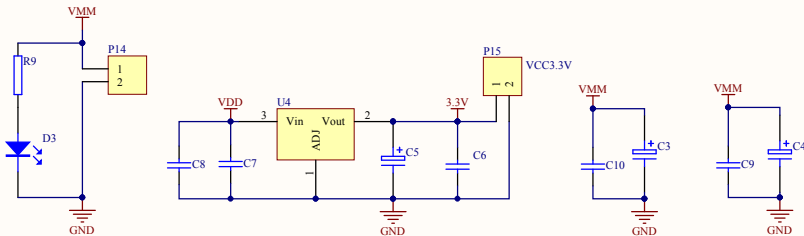

XBEE\_PART

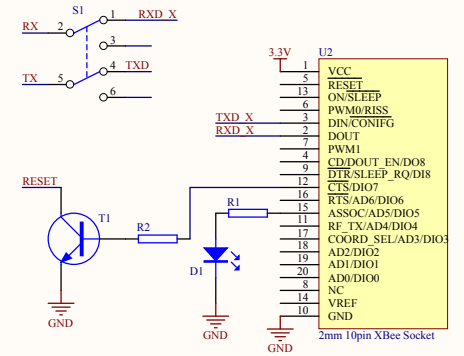

DRIVER\_PART

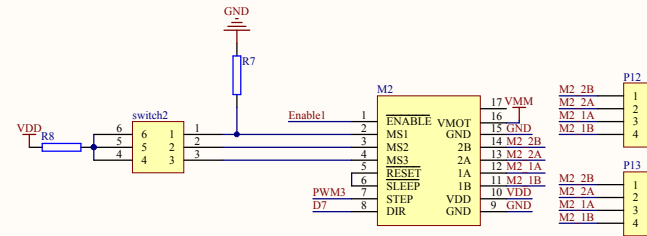
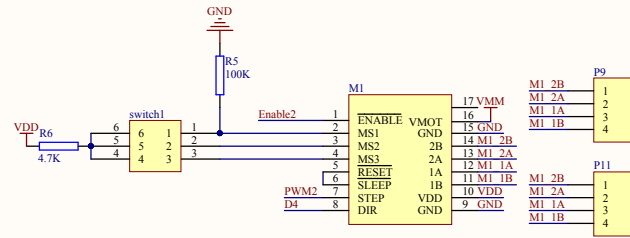

Title		
Stepper Motor Shield		
Size	Number	Revision
A3		V2.0
Date:	8/5/2015	Sheet of
File:	E:\我的文档\Stepper Motor Shield V2\01原理图\SchDoc	