

1 KEY TOUCH PAD DETECTOR IC

GENERAL DESCRIPTION

The TTP223 is a touch pad detector IC which offers 1 touch key. The touching detection IC is designed for replacing traditional direct button key with diverse pad size. Low power consumption and wide operating voltage are the contact key features for DC or AC application.

FEATURES

- Operating voltage 2.0V~5.5V
- Operating current @VDD=3V, no load, SLRFTB=1
At low power mode typical 1.5uA, maximum 3.0uA
At fast mode typical 3.5uA, maximum 7.0uA
@VDD=3V, no load, SLRFTB=0
At low power mode typical 2.0uA, maximum 4.0uA
At fast mode typical 6.5uA, maximum 13.0uA
- The response time max about 60mS at fast mode, 220mS at low power mode @VDD=3V
- Sensitivity can adjust by the capacitance(0~50pF) outside
- Have two kinds of sampling length by pad option(SLRFTB pin)
- Stable touching detection of human body for replacing traditional direct switch key
- Provides Fast mode and Low Power mode selection by pad option(LPMB pin)
- Provides direct mode 、toggle mode by pad option(TOG pin)
Open drain mode by bonding option, OPDO pin is open drain output,
Q pin is CMOS output
- All output modes can be selected active high or active low by pad option(AHLB pin)
- Have the maximum on time 100sec by pad option(MOTB pin)
- Have external power on reset pin(RST pin)
- After power-on have about 0.5sec stable-time, during the time do not touch the key pad,
And the function is disabled
- Auto calibration for life
And the re-calibration period is about 4.0sec, when key has not be touched

APPLICATION

- Wide consumer products
- Water proofed electric products
- Button key replacement

BLOCK DIAGRAM

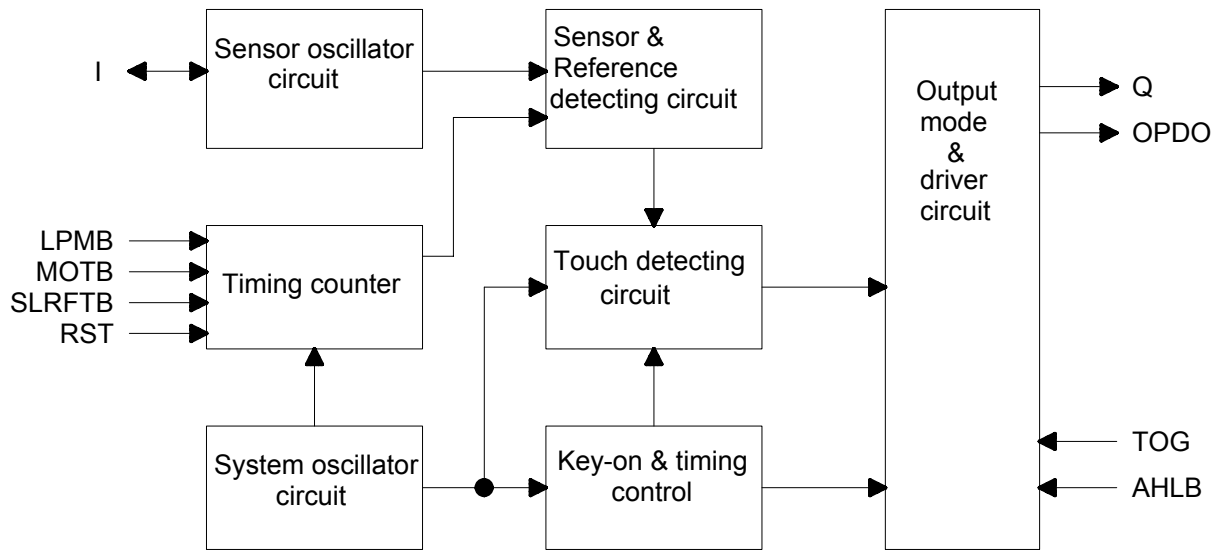

PAD DESCRIPTION

Pad No.	Pad Name	I/O Type	Pad Description
1	Q	O	CMOS output pin
2	OPDO	O	Open drain output pin
3	VSS	P	Negative power supply, ground
4	LPMB	I-PH	Low power mode selection, 1=>Fast mode; 0=>Low power mode
5	TOG	I-PL	Output type option pin, 1=>Toggle mode; 0=>Direct mode
6	VDD	P	Positive power supply
7	AHLB	I-PL	Output active high or low selection, 1=>Active low; 0=>Active high
8	RST	I-PL	External power on reset pin
9	SLRFTB	I-PH	Selecting the sampling length, 1=>about 1.6msec; 0=>about 3.2msec
10	MOTB	I-PH	Maximum on time 100sec selection, 1=>Disable, 0=>Enable
11	I	I/O	Input sensor port

ELECTRICAL CHARACTERISTICS

• **Absolute Maximum Ratings**

Parameter	Symbol	Conditions	Value	Unit
Operating Temperature	T _{OP}	—	-20 ~ +70	°C
Storage Temperature	T _{STG}	—	-50 ~ +125	°C
Power Supply Voltage	VDD	T _a =25°C	VSS-0.3 ~ VSS+5.5	V
Input Voltage	V _{IN}	T _a =25°C	VSS-0.3 ~ VDD+0.3	V
Note : VSS symbolizes for system ground				

• **DC/AC Characteristics** : (Test condition at room temperature=25°C)

Parameter	Symbol	Test Condition	Min.	Typ.	Max.	Unit	
Operating Voltage	VDD		2.0	3	5.5	V	
System oscillator	F _{FAST}	VDD=3V	-	512K	-	Hz	
	F _{LOW}			16K			
Sensor oscillator	F _{SEN}	VDD=3V no load	-	1M	-	Hz	
Operating Current	I _{OP}	VDD=3V at low power mode and output no load	SLRFTB =1	-	1.5	3.0	uA
			SLRFTB =0	-	2.0	4.0	
	VDD=3V at fast mode and output no load	SLRFTB =1	-	3.5	7.0		
		SLRFTB =0		6.5	13.0		
Input Ports	V _{IL}	Input Low Voltage	0	-	0.2	VDD	
Input Ports	V _{IH}	Input High Voltage	0.8	-	1.0	VDD	
Output Port Sink Current	I _{OL}	VDD=3V, V _{OL} =0.6V	-	8	-	mA	
Output Port Source Current	I _{OH}	VDD=3V, V _{OH} =2.4V	-	-4	-	mA	
Output Response Time	T _R	VDD=3V, At fast mode			60	mS	
		VDD=3V, At low power mode			220		
Input Pin Pull-high Resistor	R _{PH}	VDD=3V, (LPMB, MOTB, SLRFTB)		35K		ohm	
Input Pin Pull-low Resistor	R _{PL}	VDD=3V, (TOG, AHLB)		28K		ohm	
		VDD=3V, (RST)		200K			

FUNCTION DESCRIPTION

1. Sensitivity adjustment

The total loading of electrode size and capacitance of connecting line on PCB can affect the sensitivity. So the sensitivity adjustment must according to the practical application on PCB. The TTP223 offers some methods for adjusting the sensitivity outside.

1-1 by the electrode size

Under other conditions are fixed. Using a larger electrode size can increase sensitivity. Otherwise it can decrease sensitivity. But the electrode size must use in the effective scope.

1-2 by the panel thickness

Under other conditions are fixed. Using a thinner panel can increase sensitivity. Otherwise it can decrease sensitivity. But the panel thickness must be below the maximum value.

1-3 by the value of Cs (please see the down figure)

Under other conditions are fixed. When do not use the Cs to VSS, the sensitivity is most sensitive. When adding the values of Cs will reduce sensitivity in the useful range ($0 \leq C_s \leq 50\text{pF}$).

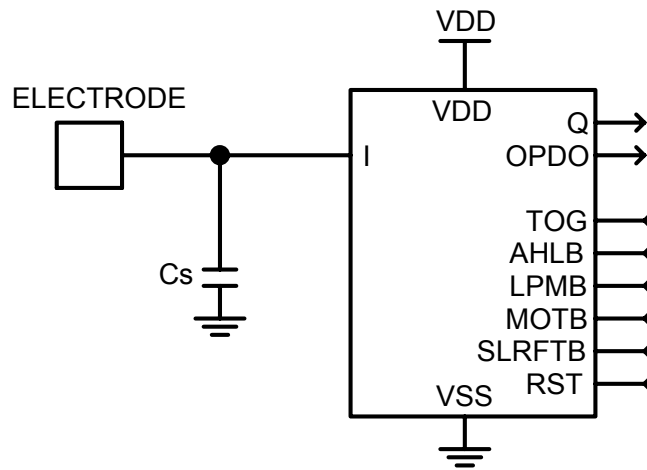

2. Output mode

The TTP223 has direct mode active high or low by AHLB pad option. And has toggle mode by TOG pad option. Another has open drain mode by bonding option. Pad Q is digital output, pad OPDO is open drain output.

TOG	AHLB	Pad Q option features	Pad OPDO option features
0	0	Direct mode, CMOS active high output	Direct mode, Open drain active high output
0	1	Direct mode, CMOS active low output	Direct mode, Open drain active low output
1	0	Toggle mode, Power on state=0	Toggle mode, Power on state high-Z, Active high
1	1	Toggle mode, Power on state=1	Toggle mode, Power on state high-Z, Active low

3. Maximum key on duration time (By MOTB pad option)

If some objects cover in the sense pad, and causing the change quantity enough to be detected. To prevent this, the TTP223 sets a timer to monitor the detection. The timer is the maximum on duration time. It is set about 100sec at 3V. When the detection is over the timer, the system will return to the power-on initial state, and the output becomes inactive until the next detection.

MOTB	Option features
1	Infinite(Disable maximum on time)
0	Maximum on time 100sec

4. Fast and Low power mode selection (By LPMB pad option)

The TTP223 has Fast mode and Low Power mode to be selected. It depends on the state of LPMB pad. When the LPMB pin is opened or connected to VDD, the TTP223 runs in Fast mode. When the LPMB pin is connected to VSS, the TTP223 runs in Low Power mode.

In the Fast mode response time is faster, but the current consumption will be increased. In the Low Power mode it will be saving power, but will be slowing response time for first touch. When it awaked in fast mode, the response time is the same the fast mode. In this mode when detecting key touch, it will switch to Fast mode. Until the key touch is released and will keep a time about 12sec. Then it returns to Low Power mode.

The states and timing of two modes please see below figure.

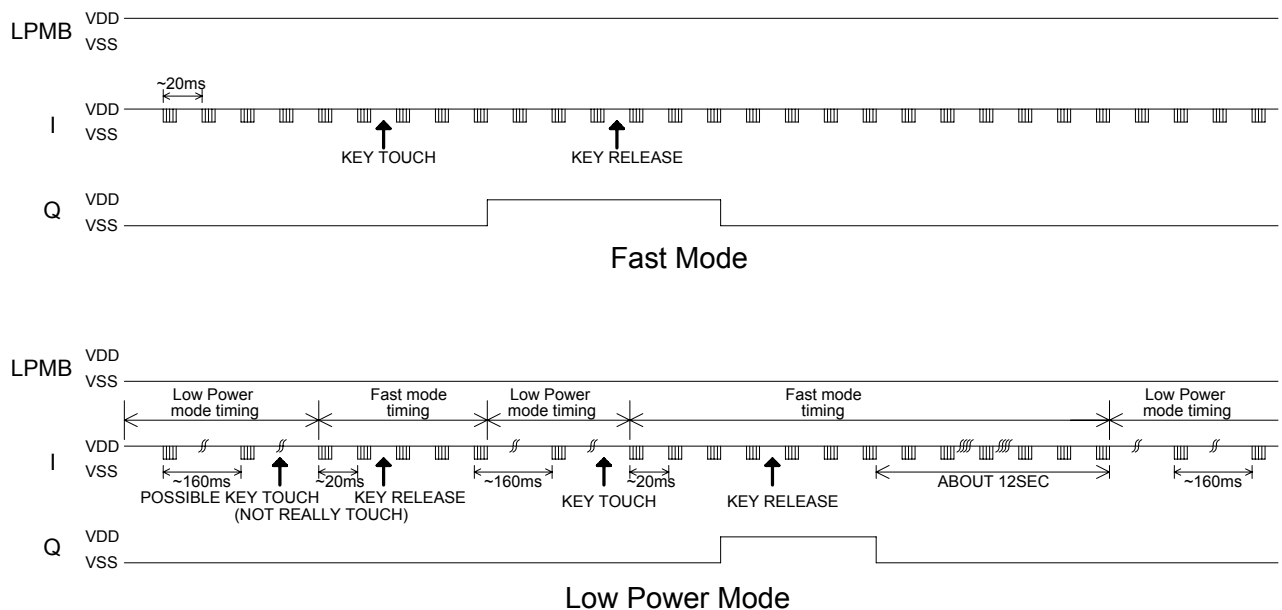

LPMB	Option features
1	Fast mode
0	Low Power mode

5. Sampling length selection (By SLRFTB pad option)

The TTP223 has two kinds of sampling length to be selected. It depends on the state of SLRFTB pad. When the SLRFTB pin is opened or connected to VDD, the sampling length is about 1.6msec. When the SLRFTB pin is connected to VSS, the sampling length is about 3.2msec.

When selecting 3.2msec sampling length the sensitivity will be better, but the current consumption will be increased. Recommend to use 1.6msec sampling length.

SLRFTB	Option features
1	Sampling length = 1.6msec
0	Sampling length = 3.2msec

6. Option pin

For power saving concern and package bonding option consideration, all the feature option pins with latch type design and initial states are 0 or 1 as power on. If those pins are forced to VDD or VSS, the states will be changed to 1 or 0 without any current leakage to conflict the power saving issue.

Feature option pins	Initial state by Power on
AHLB	0
TOG	0
LPMB	1
MOTB	1
SLRFTB	1

APPLICATION CIRCUIT

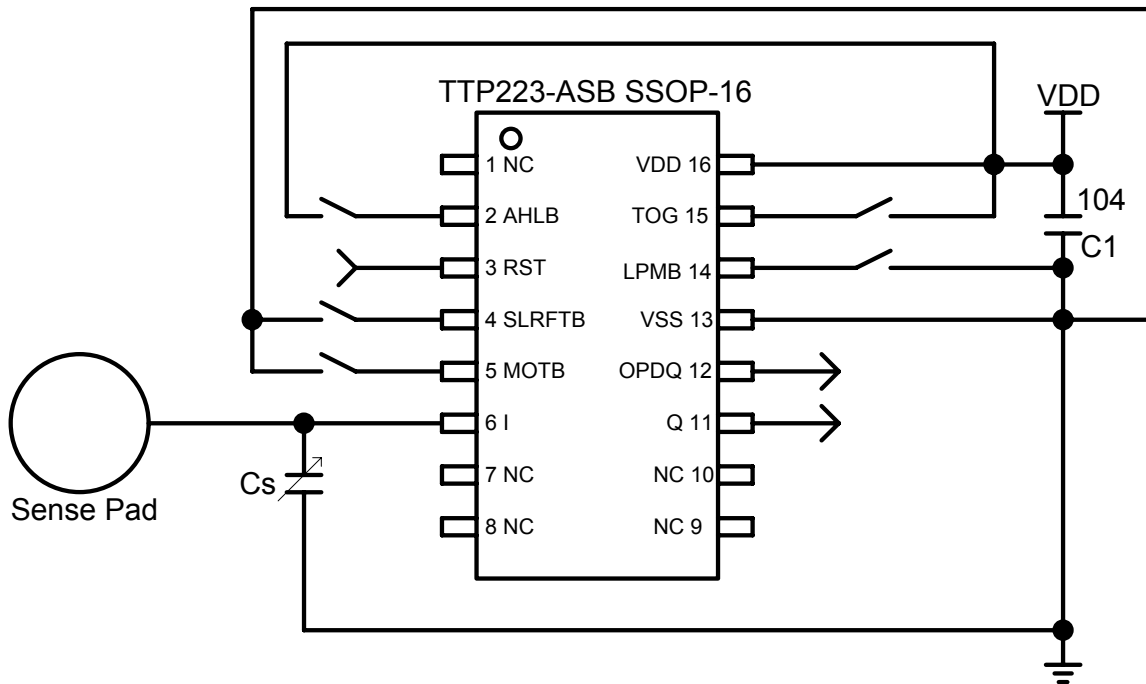

- PS : 1. On PCB, the length of lines from touch pad to IC pin shorter is better.
 And the lines do not parallel and cross with other lines.
2. The power supply must be stable. If the supply voltage drift or shift quickly, maybe causing sensitivity anomalies or false detections.
 3. The material of panel covering on the PCB can not include the metal or the electric element. The paints on the surfaces are the same.
 4. The capacitance Cs can be used to adjust the sensitivity. The value of Cs use smaller, then the sensitivity will be better. The sensitivity adjustment must according to the practical application on PCB. The range of Cs value is 0~50pF.

PACKAGE LIST

1. TTP223-ASB

Package Item	Package Type	Option Features							
		AHLB	TOG	LPMB	MOTB	SLRFTB	RST	Q	OPDO
TTP223-ASB	SSOP-16	V	V	V	V	V	V	V	V

P.S.: The mark of "V" express that package item has the option feature pin.

TTP223-ASB PACKAGE CONFIGURATION

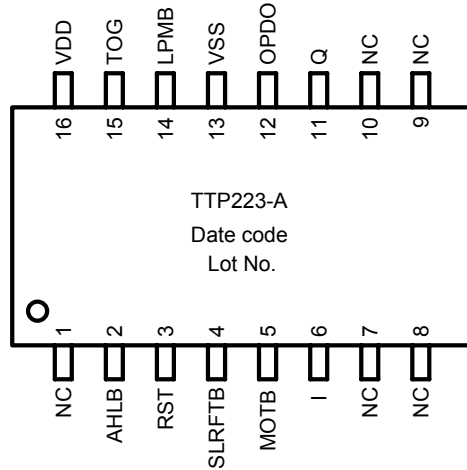

Package Outline Dimension

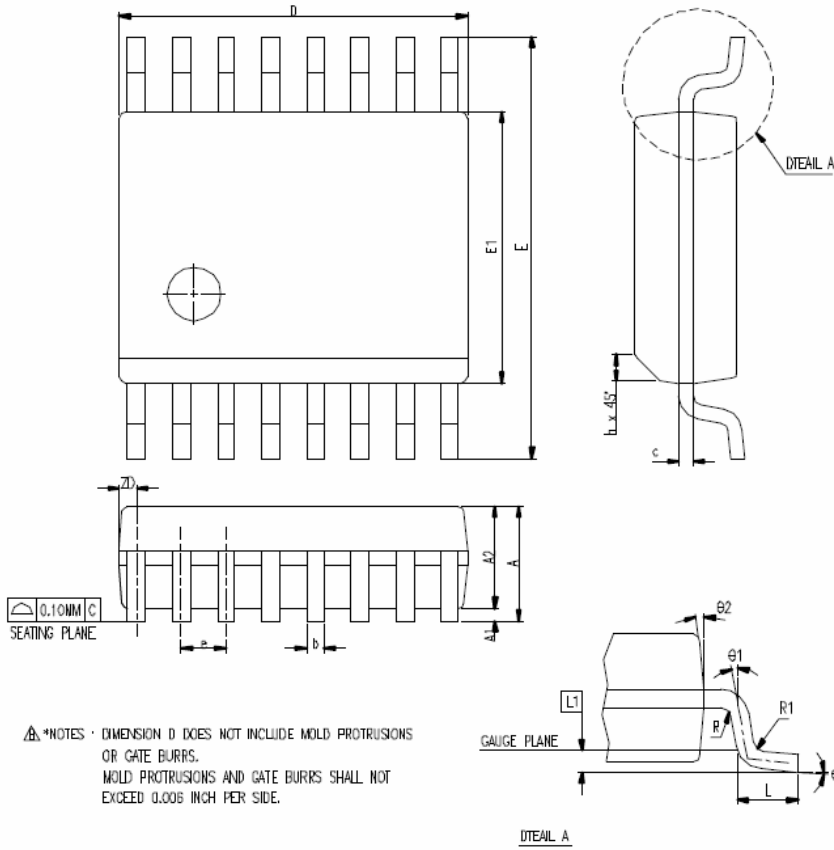

SYMBOL	DIMENSION IN MM			DIMENSION IN INCH		
	MIN.	NOM.	MAX.	MIN.	NOM.	MAX.
A	1.35	1.63	1.75	0.053	0.064	0.069
A1	0.10	0.15	0.25	0.004	0.006	0.010
A2			1.50			0.059
b	0.20		0.30	0.008		0.012
c	0.18		0.25	0.007		0.010
e	0.635 BASIC			0.025 BASIC		
D	4.80	4.90	5.00	0.189	0.193	0.197
E	5.79	5.99	6.20	0.228	0.236	0.244
E1	3.81	3.91	3.99	0.150	0.154	0.157
L	0.41	0.635	1.27	0.016	0.025	0.050
h	0.25		0.50	0.010		0.020
L1	0.254 BASIC			0.010 BASIC		
ZD	0.229 REF			0.009 REF		
R1	0.20		0.33	0.008		0.013
R	0.20			0.008		
theta	0°		8°	0°		8°
theta1	0°			0°		
theta2	5°	10°	15°	5°	10°	15°
JEDEC	MO-137 (AB)					

*NOTES: DIMENSION D DOES NOT INCLUDE MOLD PROTRUSIONS OR GATE BURRS. MOLD PROTRUSIONS AND GATE BURRS SHALL NOT EXCEED 0.006 INCH PER SIDE.

2. TTP223-BA6

Package Item	Package Type	Option Features							
		AHLB	TOG	LPMB	MOTB	SLRFTB	RST	Q	OPDO
TTP223-BA6	SOT-23-6L	V	V	0	1	1	X	V	X

P.S.: The mark of "V" express that package item has the option feature pin.
 The mark of "X" express that package item has no the option feature pin.
 The mark of "0" express that the state of option pin is fixed to VSS in the package item.
 The mark of "1" express that the state of option pin is fixed to VDD in the package item.

TTP223-BA6 PACKAGE CONFIGURATION

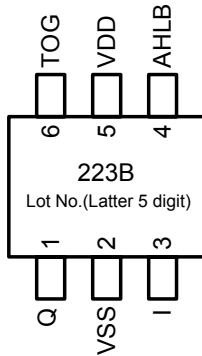

Package Outline Dimension

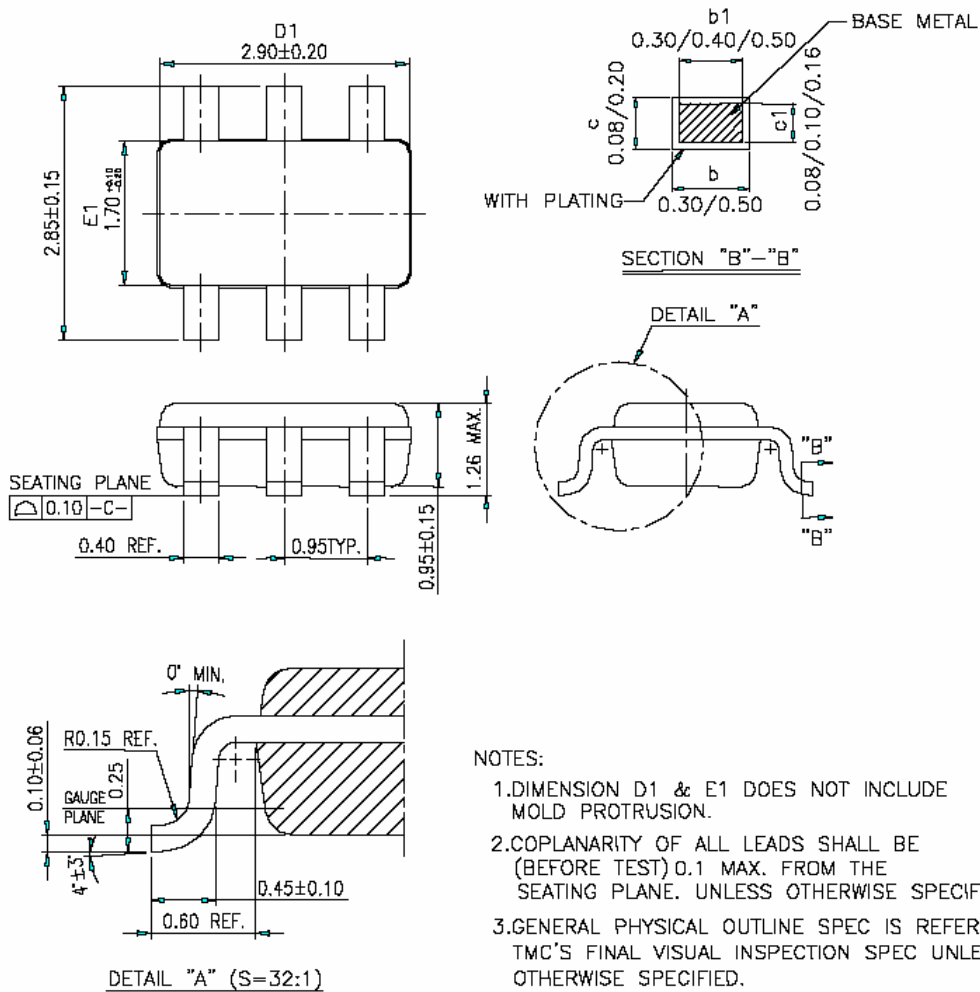

3. TTP223-DO8

Package Item	Package Type	Option Features							
		AHLB	TOG	LPMB	MOTB	SLRFTB	RST	Q	OPDO
TTP223-DO8	SOP-8	V	V	V	V	1	X	V	X

P.S.: The mark of "V" express that package item has the option feature pin.
 The mark of "X" express that package item has no the option feature pin.
 The mark of "0" express that the state of option pin is fixed to VSS in the package item.
 The mark of "1" express that the state of option pin is fixed to VDD in the package item.

TTP223-DO8 PACKAGE CONFIGURATION

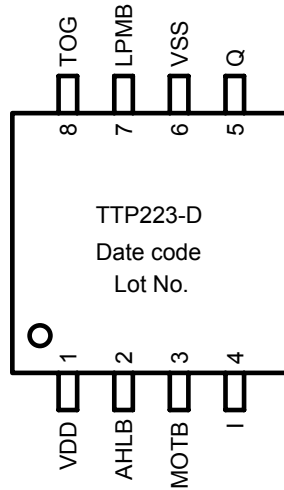

Package Outline Dimension

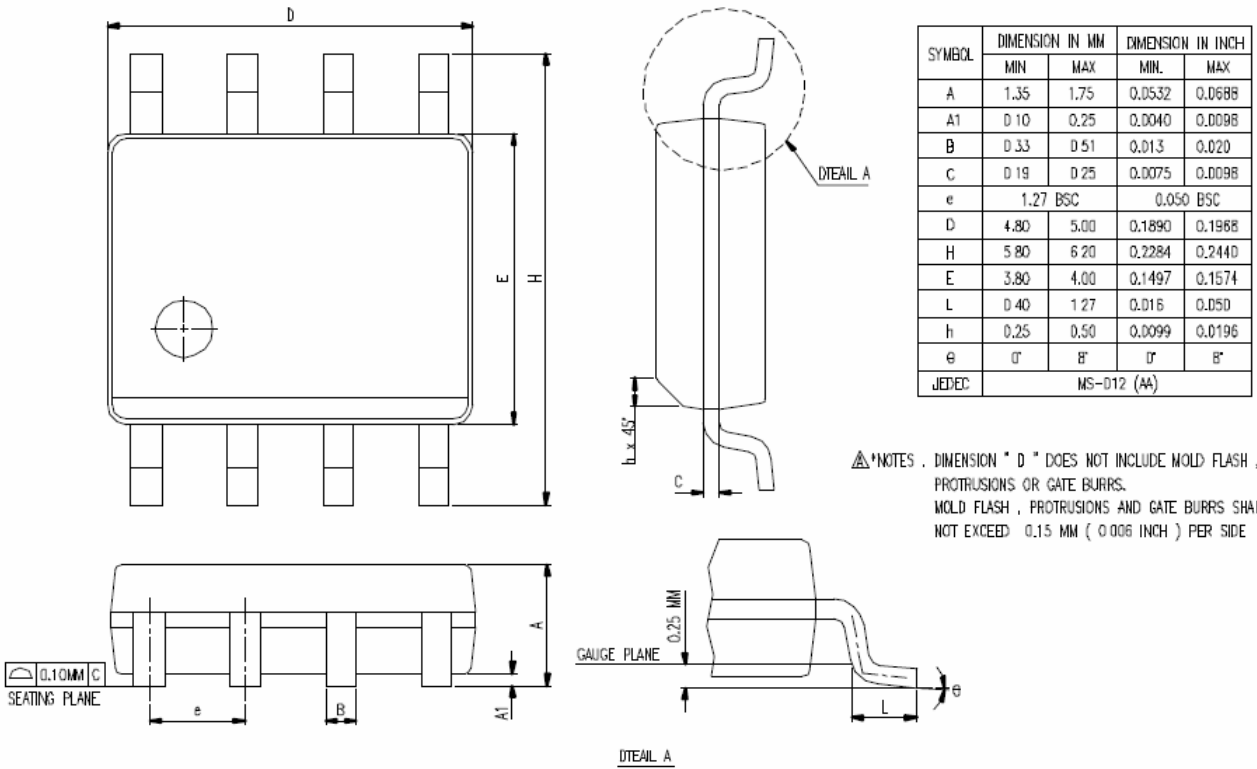



ORDER INFORMATION

- a. Package form: TTP223-XXX
- b. Chip form: TCP223
- c. Wafer base: TDP223

REVISE HISTORY

- 1. 2008/04/07
-Original version : V_1.0