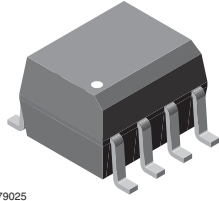
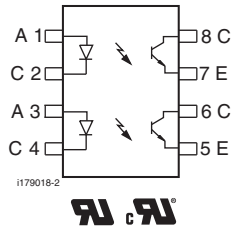




Optocoupler, Phototransistor Output, Dual Channel, SOIC-8 Package



i179025



FEATURES

- Two channel coupler
- SOIC-8 surface mountable package
- Standard lead spacing of 0.05"
- Available only on tape and reel option (conforms to EIA standard 481-2)
- Isolation test voltage, 4000 V_{RMS}
- Compatible with dual wave, vapor phase and IR reflow soldering
- Compliant to RoHS Directive 2002/95/EC and in accordance to WEEE 2002/96/EC



RoHS COMPLIANT

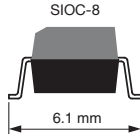
DESCRIPTION

The ILD205T, ILD206T, ILD207T, ILD211T, ILD213T, ILD217T are optically coupled pairs with a gallium arsenide infrared LED and a silicon NPN phototransistor. Signal information, including a DC level, can be transmitted by the device while maintaining a high degree of electrical isolation between input and output. The ILD205T, ILD206T, ILD207T, ILD211T, ILD213T, ILD217T come in a standard SOIC-8 small outline package for surface mounting which makes it ideally suited for high density applications with limited space. In addition to eliminating through-holes requirements, this package conforms to standards for surface mounted devices.

A specified minimum and maximum CTR allows a narrow tolerance in the electrical design of the adjacent circuits. The high BV_{CEO} of 70 V gives a higher safety margin compared to the industry standard of 30 V.

AGENCY APPROVALS

- UL1577, file no. E52744 system code Y
- cUL - file no. E52744, equivalent to CSA bulletin 5A

ORDERING INFORMATION						
I	L	D	2	#	#	T
PART NUMBER						
AGENCY CERTIFIED/PACKAGE	CTR (%)					
	10 mA				1 mA	
UL, cUL	40 to 80	63 to 125	100 to 200	≥ 20	≥ 100	≥ 100
SOIC-8	ILD205T	ILD206T	ILD207T	ILD211T	ILD213T	ILD217T

ABSOLUTE MAXIMUM RATINGS (T _{amb} = 25 °C, unless otherwise specified)				
PARAMETER	TEST CONDITION	SYMBOL	VALUE	UNIT
INPUT				
Peak reverse voltage		V _R	6	V
Peak pulsed current	1 μs, 300 pps		1	A
Continuous forward current per channel		I _F	30	mA
Power dissipation		P _{diss}	50	mW



ABSOLUTE MAXIMUM RATINGS (T _{amb} = 25 °C, unless otherwise specified)				
PARAMETER	TEST CONDITION	SYMBOL	VALUE	UNIT
OUTPUT				
Collector emitter breakdown voltage		BV _{CEO}	70	V
Emitter collector breakdown voltage		BV _{ECO}	7	V
Power dissipation per channel		P _{diss}	125	mW
COUPLER				
Isolation test voltage	t = 1 s	V _{ISO}	4000	V _{RMS}
Total package dissipation ambient (2 LEDs and 2 detectors, 2 channels)		P _{tot}	350	mW
Storage temperature		T _{stg}	- 55 to + 150	°C
Operating temperature		T _{amb}	- 55 to + 100	°C
Soldering time from 260 °C ⁽¹⁾		T _{slt}	10	s

Notes

- Stresses in excess of the absolute maximum ratings can cause permanent damage to the device. Functional operation of the device is not implied at these or any other conditions in excess of those given in the operational sections of this document. Exposure to absolute maximum ratings for extended periods of the time can adversely affect reliability.
- ⁽¹⁾ Refer to reflow profile for soldering conditions for surface mounted devices.

ELECTRICAL CHARACTERISTICS (T _{amb} = 25 °C, unless otherwise specified)							
PARAMETER	TEST CONDITION	PART	SYMBOL	MIN.	TYP.	MAX.	UNIT
INPUT							
Forward voltage	I _F = 10 mA		V _F		1.2	1.55	V
Reverse current	V _R = 6 V		I _R		0.1	100	µA
Capacitance	V _R = 0 V		C _O		25		pF
OUTPUT							
Collector emitter breakdown voltage	I _C = 10 µA		BV _{CEO}	70			V
Emitter collector breakdown voltage	I _E = 10 µA		BV _{ECO}	7			V
Collector emitter leakage current	V _{CE} = 10 V, I _F = 0 A		I _{CEO}		5	50	nA
Collector emitter capacitance	V _{CE} = 0 V		C _{CE}		10		pF
COUPLER							
Collector emitter saturation voltage	I _F = 10 mA, I _C = 2.5 mA		V _{CEsat}			0.4	V
Capacitance (input to output)			C _{IO}		0.5		pF
Resistance (input to output)			R _{IO}		100		GΩ

Note

- Minimum and maximum values were tested requirements. Typical values are characteristics of the device and are the result of engineering evaluations. Typical values are for information only and are not part of the testing requirements.

CURRENT TRANSFER RATIO (T _{amb} = 25 °C, unless otherwise specified)							
PARAMETER	TEST CONDITION	PART	SYMBOL	MIN.	TYP.	MAX.	UNIT
DC current transfer ratio	V _{CE} = 5 V, I _F = 10 mA	ILD205T	CTR _{DC}	40		80	%
		ILD206T	CTR _{DC}	63		125	%
		ILD207T	CTR _{DC}	100		200	%
		ILD211T	CTR _{DC}	20			%
		ILD213T	CTR _{DC}	100			%
	V _{CE} = 5 V, I _F = 1 mA	ILD205T	CTR _{DC}	13	30		%
		ILD206T	CTR _{DC}	22	45		%
		ILD207T	CTR _{DC}	34	70		%
		ILD217T	CTR _{DC}	100	120		%

SWITCHING CHARACTERISTICS ($T_{amb} = 25\text{ }^{\circ}\text{C}$, unless otherwise specified)						
PARAMETER	TEST CONDITION	SYMBOL	MIN	TYP.	MAX	UNIT
Delay time	$V_S = 5\text{ V}$, $I_C = 2\text{ mA}$, $R_L = 100\ \Omega$, (see figure 1)	t_d		3		μs
Rise time	$V_S = 5\text{ V}$, $I_C = 2\text{ mA}$, $R_L = 100\ \Omega$, (see figure 1)	t_r		3		μs
Fall time	$V_S = 5\text{ V}$, $I_C = 2\text{ mA}$, $R_L = 100\ \Omega$, (see figure 1)	t_f		4.7		μs
Storage time	$V_S = 5\text{ V}$, $I_C = 2\text{ mA}$, $R_L = 100\ \Omega$, (see figure 1)	t_s		0.3		μs
Turn-on time	$V_S = 5\text{ V}$, $I_C = 2\text{ mA}$, $R_L = 100\ \Omega$, (see figure 1)	t_{on}		6		μs
Turn-off time	$V_S = 5\text{ V}$, $I_C = 2\text{ mA}$, $R_L = 100\ \Omega$, (see figure 1)	t_{off}		5		μs
Turn-on time	$V_S = 5\text{ V}$, $I_F = 10\text{ mA}$, $R_L = 1\text{ k}\Omega$, (see figure 2)	t_{on}		3		μs
Turn-off time	$V_S = 5\text{ V}$, $I_F = 10\text{ mA}$, $R_L = 1\text{ k}\Omega$, (see figure 2)	t_{off}		10		μs



95 10804

Fig. 1 - Test Circuit, Non-Saturated Operation

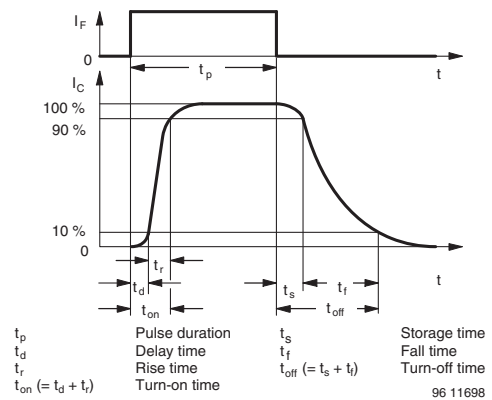
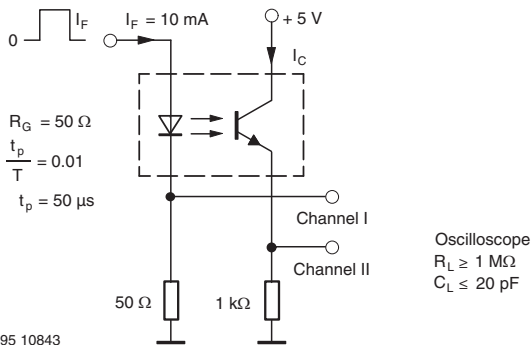


Fig. 3 - Switching Times



95 10843

Fig. 2 - Test Circuit, Saturated Operation

SAFETY AND INSULATION RATINGS						
PARAMETER	TEST CONDITION	SYMBOL	MIN.	TYP.	MAX.	UNIT
Climatic classification (according to IEC 68 part 1)				55/100/21		
Comparative tracking index		CTI	175		399	
V_{IOTM}			6000			V
V_{IORM}			560			V
P_{SO}					350	mW
I_{SI}					150	mA
T_{SI}					165	°C
Creepage distance			4			mm
Clearance distance			4			mm
Insulation thickness			0.2			mm

Note

- As per IEC 60747-5-2, §7.4.3.8.1, this optocoupler is suitable for “safe electrical insulation” only within the safety ratings. Compliance with the safety ratings shall be ensured by means of protective circuits.

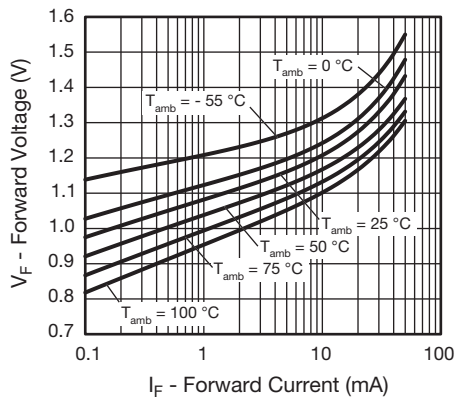
TYPICAL CHARACTERISTICS ($T_{amb} = 25\text{ °C}$, unless otherwise specified)


Fig. 4 - Forward Voltage vs. Forward Current

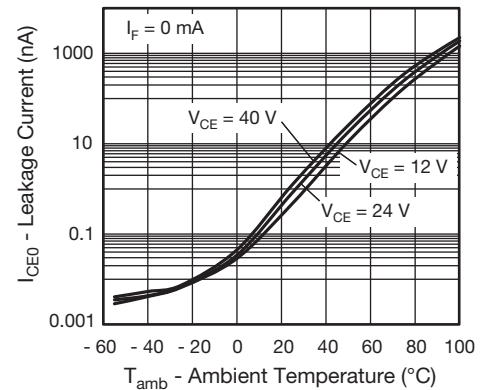


Fig. 6 - Leakage Current vs. Ambient Temperature

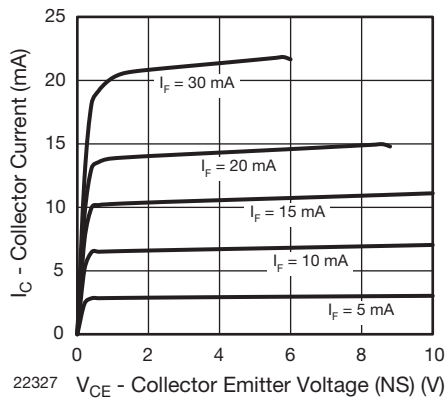


Fig. 5 - Collector Current vs. Collector Emitter Voltage (NS)

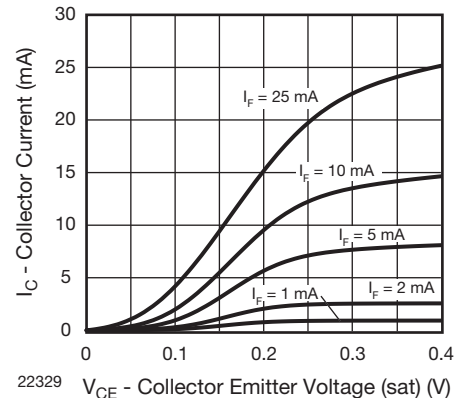


Fig. 7 - Collector Current vs. Collector Emitter Voltage (sat)

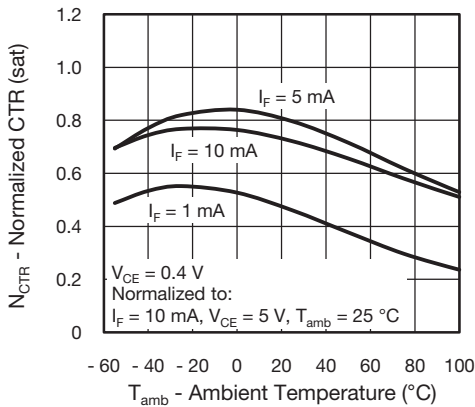


Fig. 8 - Normalized CTR (sat) vs. Ambient Temperature

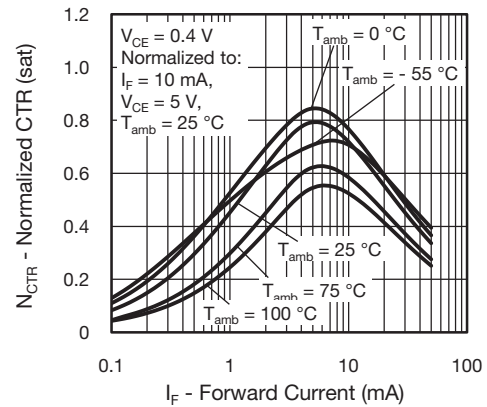


Fig. 11 - Normalized CTR (sat) vs. Forward Current



Fig. 9 - Normalized CTR (NS) vs. Ambient Temperature

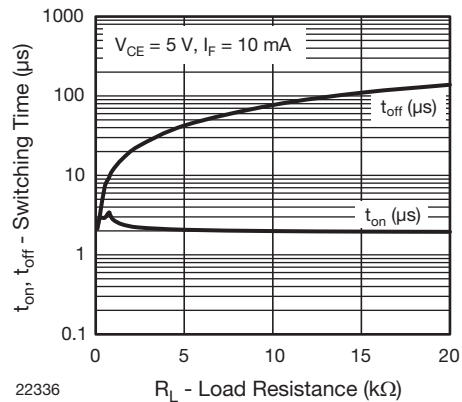


Fig. 12 - Switching Time vs. Load Resistance

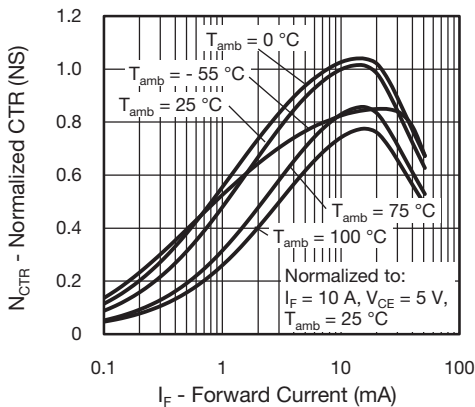


Fig. 10 - Normalized CTR (NS) vs. Forward Current

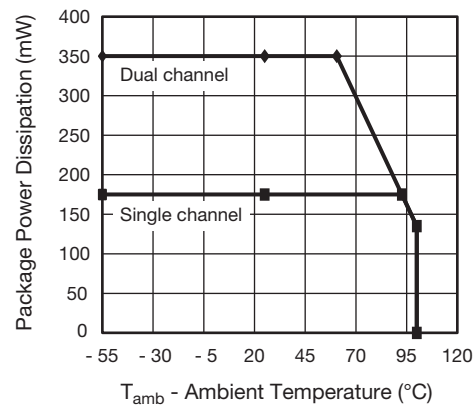
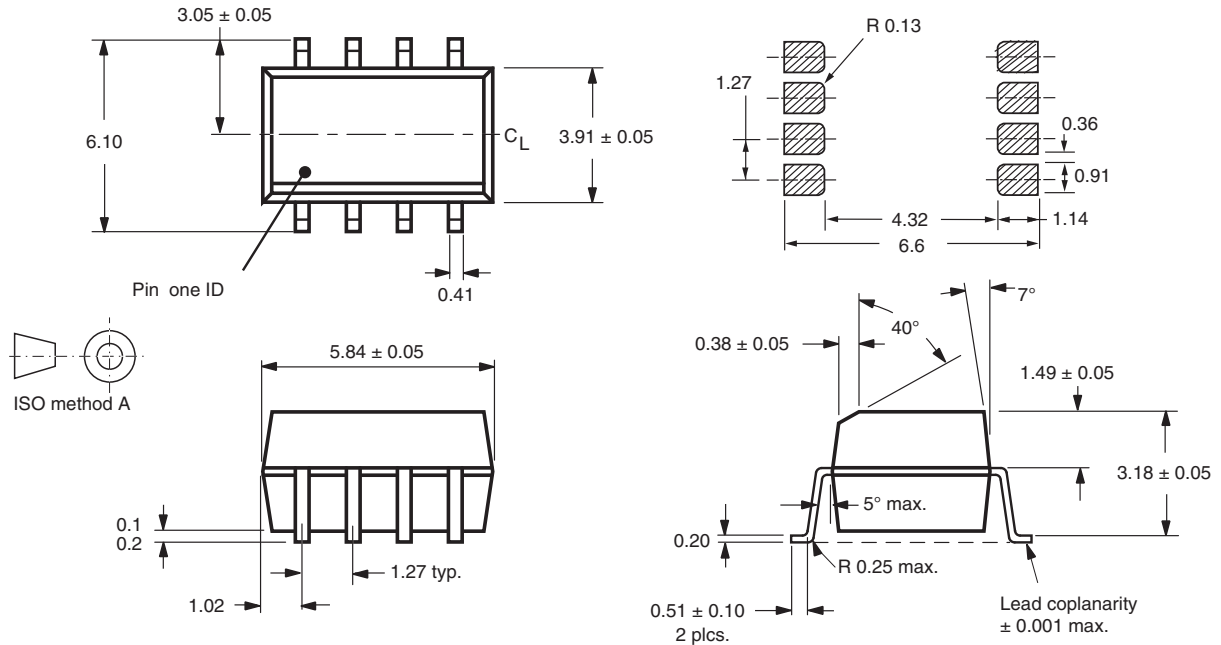


Fig. 13 - Power Dissipation vs. Ambient Temperature

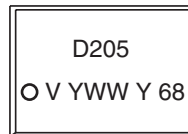


PACKAGE DIMENSIONS in millimeters



i178020

PACKAGE MARKING (example)



21764-105

Note

- Tape and reel suffix (T) is not part of the package marking.



Disclaimer

ALL PRODUCT, PRODUCT SPECIFICATIONS AND DATA ARE SUBJECT TO CHANGE WITHOUT NOTICE TO IMPROVE RELIABILITY, FUNCTION OR DESIGN OR OTHERWISE.

Vishay Intertechnology, Inc., its affiliates, agents, and employees, and all persons acting on its or their behalf (collectively, "Vishay"), disclaim any and all liability for any errors, inaccuracies or incompleteness contained in any datasheet or in any other disclosure relating to any product.

Vishay makes no warranty, representation or guarantee regarding the suitability of the products for any particular purpose or the continuing production of any product. To the maximum extent permitted by applicable law, Vishay disclaims (i) any and all liability arising out of the application or use of any product, (ii) any and all liability, including without limitation special, consequential or incidental damages, and (iii) any and all implied warranties, including warranties of fitness for particular purpose, non-infringement and merchantability.

Statements regarding the suitability of products for certain types of applications are based on Vishay's knowledge of typical requirements that are often placed on Vishay products in generic applications. Such statements are not binding statements about the suitability of products for a particular application. It is the customer's responsibility to validate that a particular product with the properties described in the product specification is suitable for use in a particular application. Parameters provided in datasheets and/or specifications may vary in different applications and performance may vary over time. All operating parameters, including typical parameters, must be validated for each customer application by the customer's technical experts. Product specifications do not expand or otherwise modify Vishay's terms and conditions of purchase, including but not limited to the warranty expressed therein.

Except as expressly indicated in writing, Vishay products are not designed for use in medical, life-saving, or life-sustaining applications or for any other application in which the failure of the Vishay product could result in personal injury or death. Customers using or selling Vishay products not expressly indicated for use in such applications do so at their own risk. Please contact authorized Vishay personnel to obtain written terms and conditions regarding products designed for such applications.

No license, express or implied, by estoppel or otherwise, to any intellectual property rights is granted by this document or by any conduct of Vishay. Product names and markings noted herein may be trademarks of their respective owners.

Material Category Policy

Vishay Intertechnology, Inc. hereby certifies that all its products that are identified as RoHS-Compliant fulfill the definitions and restrictions defined under Directive 2011/65/EU of The European Parliament and of the Council of June 8, 2011 on the restriction of the use of certain hazardous substances in electrical and electronic equipment (EEE) - recast, unless otherwise specified as non-compliant.

Please note that some Vishay documentation may still make reference to RoHS Directive 2002/95/EC. We confirm that all the products identified as being compliant to Directive 2002/95/EC conform to Directive 2011/65/EU.

Vishay Intertechnology, Inc. hereby certifies that all its products that are identified as Halogen-Free follow Halogen-Free requirements as per JEDEC JS709A standards. Please note that some Vishay documentation may still make reference to the IEC 61249-2-21 definition. We confirm that all the products identified as being compliant to IEC 61249-2-21 conform to JEDEC JS709A standards.