

CC3200 SimpleLink™ Wi-Fi® and IoT Solution with MCU LaunchPad Hardware

User's Guide



Literature Number: SWRU372

June 2014

1	Introduction	4
1.1	CC3200 LaunchPad	4
1.2	Key Features	4
1.3	What's Included	5
1.4	FCC/IC Regulatory Compliance.....	5
2	Hardware Description	5
2.1	Block Diagram	6
2.2	Hardware Features.....	6
2.3	Connecting a BoosterPack.....	7
2.4	Jumpers, switches and LEDs.....	7
2.5	Power.....	14
2.6	Measure CC3200 Current Draw	16
2.7	RF Connections.....	19
2.8	Design Files	19
3	Software Examples	20
3.1	Development Environment Requirements.....	20
4	Additional Resources	20
4.1	LaunchPad Wiki.....	20
4.2	Information on the CC3200.....	20
4.3	Download CCS, IAR.....	21
4.4	The CC3200 Code Examples	21
4.5	CC3200 Application Notes	21
4.6	The Community	21
5	Known Limitations	21
5.1	Hardware Limitations.....	21

List of Figures

1	CC3200 LaunchPad EVM Overview	5
2	CC3200 Block Diagram	6
3	Pn-1 Marking on the LaunchPad (white triangle).....	7
4	JTAG Headers	7
5	I2C Connections	8
6	UART Signals	9
7	SOP Jumpers	10
8	2x20 Pin Connector	14
9	Powering From USB	15
10	Battery Power.....	16
11	Measuring Low Power	17
12	Measuring Active Power.....	18
13	Radiated Testing Using Chip Antenna	19
14	Board Set for Conducted Testing	19

List of Tables

1	JTAG Headers	8
2	Jumper Settings.....	8
3	Default I2C Addresses	9
4	Jumper Settings.....	9
5	UART Signals	9
6	SOP Lines.....	10
7	Miscellaneous Settings	11
8	Push Buttons.....	12
9	LEDs	13
10	Change Log	20

CC3200 SimpleLink™ Wi-Fi® and IoT Solution with MCU LaunchPad Hardware

1 Introduction

1.1 CC3200 LaunchPad

The high performance CC3200 is the industry's first single-chip Microcontroller (MCU) with built-in Wi-Fi connectivity for the LaunchPad™ ecosystem. Created for the Internet of Things (IoT), the SimpleLink Wi-Fi CC3200 device is a wireless MCU that integrates a high-performance ARM® Cortex®-M4 MCU allowing customers to develop an entire application with a single IC. With on-chip Wi-Fi, internet and robust security protocols, no prior Wi-Fi experience is needed for faster development.

The CC3200 LaunchPad is a low-cost evaluation platform for ARM® Cortex™-M4F-based microcontrollers. The LaunchPad design highlights the CC3200 Internet-on-a-chip™ solution and WiFi capabilities. The CC3200 LaunchPad also features programmable user buttons, RGB LED for custom applications and onboard emulation for debugging. The stackable headers of the CC3200 LaunchPad XL interface demonstrate how easy it is to expand the functionality of the LaunchPad when interfacing with other peripherals on many existing BoosterPack add-on boards such as graphical displays, audio codec, antenna selection, environmental sensing, and much more. [Figure 1](#) shows a photo of the CC3200 LaunchPad.

Free software development tools are also available, including TI's Eclipse-based [Code Composer Studio™](#) and [IAR Embedded Workbench®](#). More information about the LaunchPad, the supported BoosterPacks, and the available resources can be found at [TI's LaunchPad portal](#). Also visit the [CC3200 Wiki page](#) for design resources and example projects.

NOTE: The antennas used for this transmitter must be installed to provide a separation distance of at least 20 cm from all persons and must not be co-located or operating in conjunction with any other antenna or transmitter.

1.2 Key Features

- CC3200, SimpleLink Wi-Fi, internet-on-a-chip™ solution with integrated MCU
- 40-pin LaunchPad standard that leverages the BoosterPack ecosystem
- FTDI based JTAG emulation with serial port for Flash programming
- Two buttons and three LEDs for user interaction
- Backchannel universal asynchronous receiver/transmitter (UART) through USB to PC
- On-board chip antenna with U.FL for conducted testing
- On-board accelerometer and temperature sensor for out-of-box demo
- Micro USB connector for power and debug connections

SimpleLink, LaunchPad, Code Composer Studio are trademarks of Texas Instruments.
ARM® Cortex is a trademark of ARM Limited.
ARM, Cortex are registered trademarks of ARM Limited.
IAR Embedded Workbench is a registered trademark of IAR Systems AB.
Wi-Fi is a registered trademark of Wi-Fi Alliance.
All other trademarks are the property of their respective owners.

1.3 What's Included

Kit Contents

- CC3200 LaunchPad development tool
- Micro USB cable
- Quick start guide

1.4 FCC/IC Regulatory Compliance

The CC3200 SimpleLink Wi-Fi and IoT solution with MCU LaunchPad hardware is FCC Part 15 and IC ICES-003 Class A compliant.

2 Hardware Description

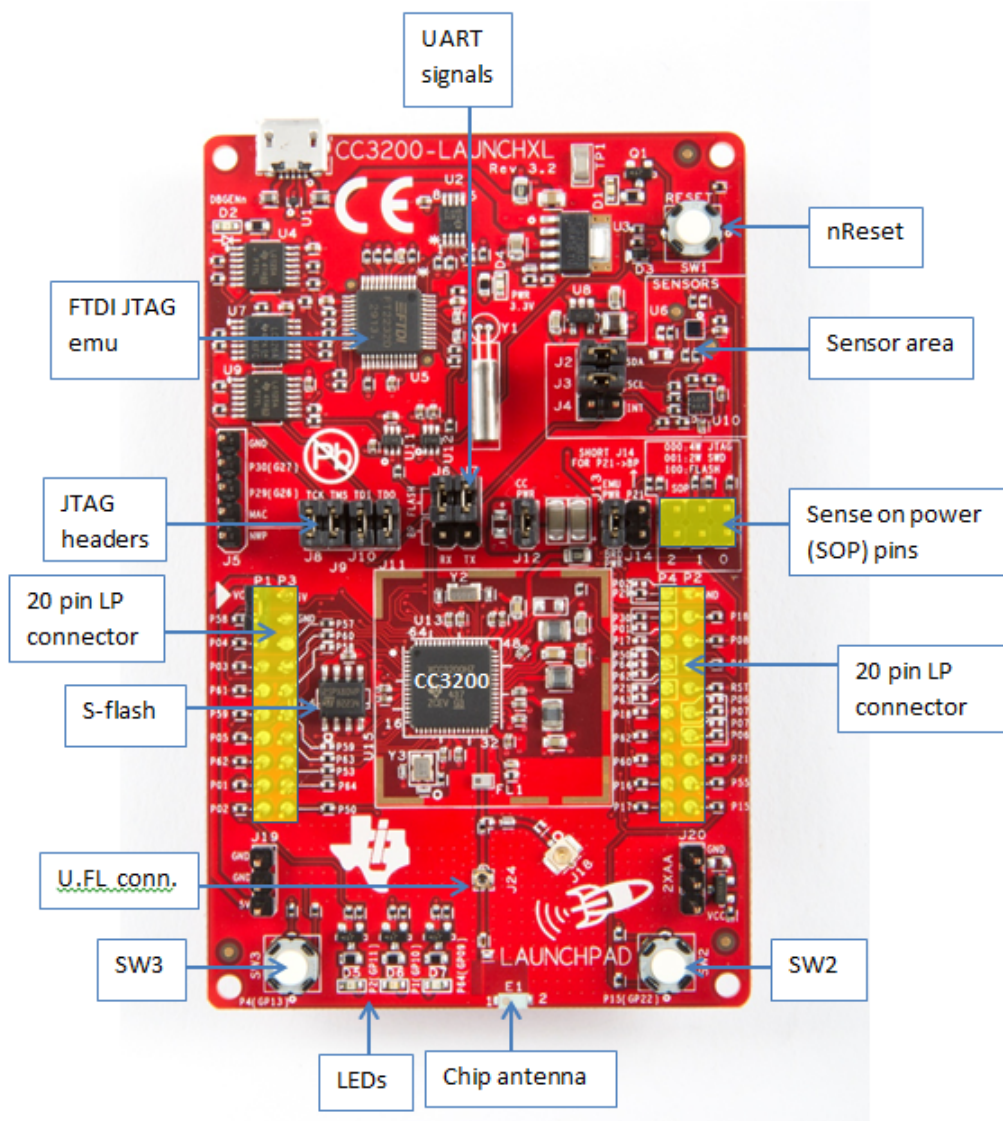

Figure 1. CC3200 LaunchPad EVM Overview

2.1 Block Diagram

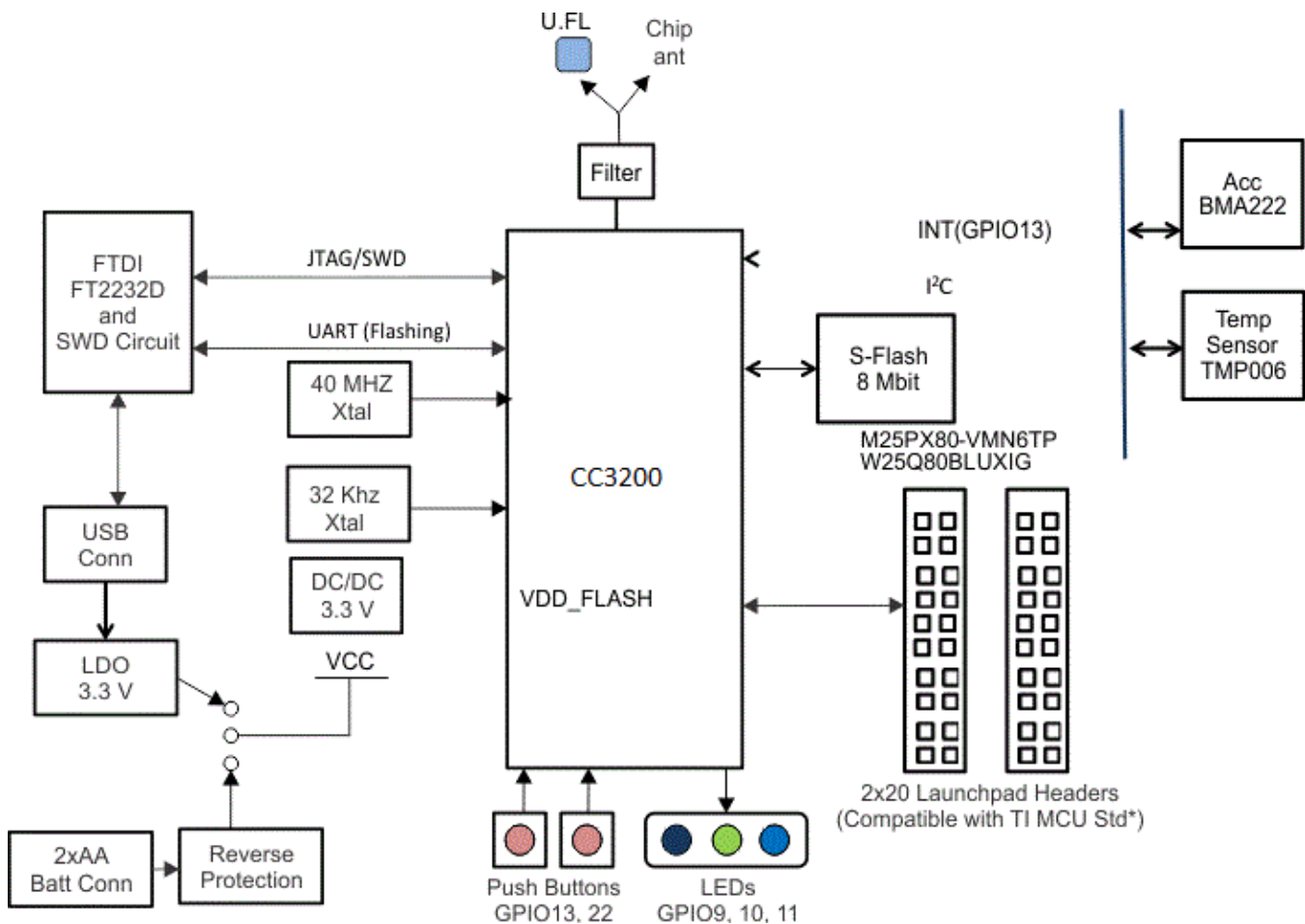

Figure 2. CC3200 Block Diagram

2.2 Hardware Features

- CC3200, SimpleLink Wi-Fi, internet-on-a-chip solution with integrated MCU40-pin LaunchPad standard that leverages the BoosterPack ecosystem
- FTDI-based JTAG emulation with serial port for Flash programming
- Supports both 4-wire JTAG and 2-wire SWD
- Two buttons and three LEDs for user interaction
- Virtual COM port UART through USB on PC
- On-board chip antenna with U.FL for conducted testing
- On-board accelerometer and temperature sensor for out-of-box demo with option to isolate them from the inter-integrated circuit (I2C) bus
- Micro USB connector for power and debug connections
- Headers for current measurement and external JTAG connection
- Bus-powered device with no external power required for Wi-Fi
- Long range transmission with highly optimized antenna (200m typical in open air with a 6dBi antenna AP)
- Can be powered externally, with 2xAA or 2xAAA alkaline batteries working down to 2.3V typical (typ)

2.3 Connecting a BoosterPack

A compatible BoosterPack can be stacked on top of the LaunchPad using the 2x20 pin connectors. Note that the connectors do not have a “key” to prevent the misalignment of the pins or reverse connection. Ensure that Vcc and 5V pins, are aligned with the BoosterPack header pins. On the CC3200 LaunchPad, a small white triangle symbol is provided near Pin-1 (see Figure 3) to orient all BoosterPacks. This same marking, provided on compatible BoosterPacks, needs to be aligned before powering up the boards.

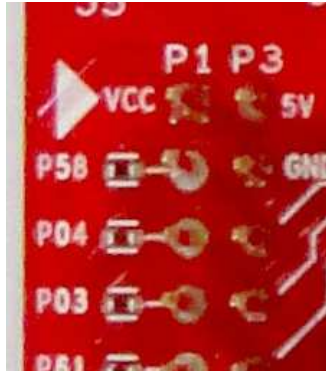

Figure 3. Pn-1 Marking on the LaunchPad (white triangle)

2.4 Jumpers, switches and LEDs

2.4.1 JTAG Headers

The headers are provided on the board to isolate the CC3200 device from the mounted FTDI JTAG emulator. These jumpers are shorted by default when the board is shipped from TI. To connect an external emulator, remove these jumpers and place the external emulator on the pins closer to the CC3200 device.



Figure 4. JTAG Headers

Table 1. JTAG Headers

Reference	Usage	Comments
J8 (TCK) ⁽¹⁾	JTAG	Short : Routes the on-board emulator to the CC3200
J9 (TMS) ⁽¹⁾		
J10 (TDI)		Open: Isolate the on-board emulator from the CC3200.
J11(TDO)		

⁽¹⁾ For the SWD mode, only TCK and TMS need to be shorted to the CC3200.

When a battery is used, be sure to disconnect all the JTAG headers to prevent any reverse leakage current.

2.4.2 I2C Connections

The board features an accelerometer and a temperature sensor for the out-of-box demo. These are connected to the I2C bus and can be isolated using the jumpers provided.

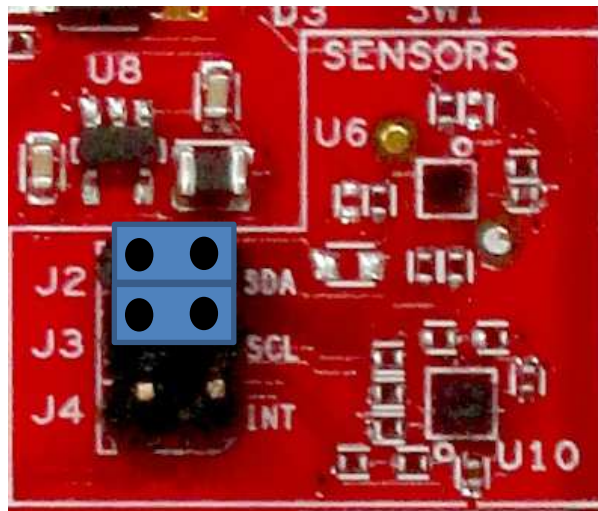

Figure 5. I2C Connections

By removing J2 and J3, the accelerometer and the temperature sensors are isolated from the I2C bus. Note that this also removes any pull-up resistor from the I2C bus.

2.4.2.1 Jumper Settings

Table 2. Jumper Settings

Reference	Usage	Comments
J2	I2C SDA	Short : Connect the CC3200 I2C bus to the on-board sensors with pull-up Open : Isolate the sensors from the CC3200
J3	I2C SCL	Short : Connect the CC3200 I2C bus to the on-board sensors with pull-up Open : Isolate the sensors from the CC320
J4	INT	Short : Connect the accelerometer interrupt to the CC3200 on GPIO13

2.4.2.2 Default I2C Address

Table 3. Default I2C Addresses

Sensor Type	Ref	Part Number	Slave Address
Temp sensor	U6	TMP008	0x41
Accelerometer	U10	BMA222	0x18

2.4.3 Power Connections

The board can be powered by using the on-board micro USB connector. An on-board LDO provides 3.3 V for the CC3200 and the rest of the board to operate. This supply can be isolated from the LDO using the jumpers on the board.

Table 4. Jumper Settings

Reference	Usage	Comments
J12	Current measurement	Measures the current flowing into the CC3200 device.
J13	Board power	Short: Supply the board power from the on-board LDO. Open: Supply the board power from the J20 (battery connector)
J19	5 V power	5 V output from the USB VBUS (has a diode drop of up to 0.4 V)
J20	3.3 V power input	Can be used to power the board from an external 2XAA battery pack. It has in-built reverse voltage protection to prevent the battery from being plugged in the reverse manner.

2.4.4 UART Signals

The board supports a USB-based virtual COM port, which is used on the FTDI device FT2232D. There are two ports on the FT2232: the first port is dedicated for the emulation (JTAG/SWD) and the second port is used for the virtual COM port. The UART can also be routed to the 20-pin connector and the selection is performed using jumpers on the board.

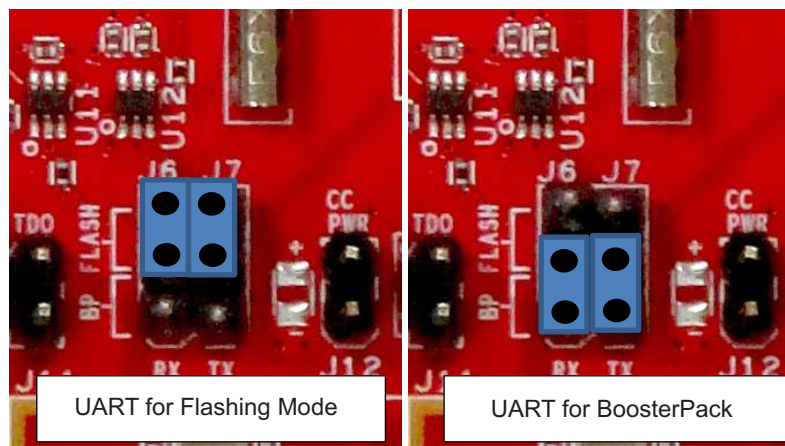
Figure 6. UART Signals
Table 5. UART Signals

Reference	Usage	Comments
J6, J7	UART for Flash programming	Short 1-2: Route the signals to the 20 pin connector. Short 2-3: Route the signals to the FTDI for Flash programming.

2.4.5 Sense on Power

The CC3200 can be set to operate in three different modes based on the state of the Sense on Power (SOP) lines. These are pins 21, 34, 35 on the CC3200 device. The state of the device is described in [Table 6](#).

Table 6. SOP Lines

Usage	Comments
SOP[2:0]	100 = Flash programming 000 = Functional mode + 4 Wire JTAG 001 = Functional mode + 2 Wire JTAG

Note: SOP[2:0] corresponds to J15, J16, and J17, in the LaunchPad schematic design.

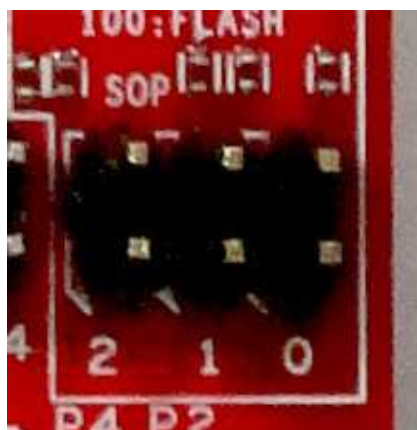

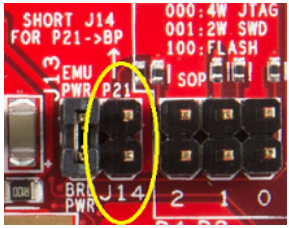

Figure 7. SOP Jumpers

2.4.6 Other Miscellaneous

Table 7. Miscellaneous Settings

Reference	Usage	Comments	
J4	Accelerometer Interrupt	Short = Route the Accelerometer sensor interrupt to the GPIO_13 Open = Isolates the Interrupt to the GPIO_13	
J5	Debug Header	To observe the Network Processor (NWP), MAC Logs.	
J14	SOP2 Isolation	Isolate SOP2 (GPIO_25) from the 20 pin connector	

2.4.7 Push Buttons and LEDs
Table 8. Push Buttons



Reference	Usage	Comments	
SW1	RESET	This is used to RESET the CC3200 device. This signal is also output on the 20-pin connector to RESET any external BoosterPack which may be stacked.	
SW2	GPIO_22	When pushed, the GPIO_22 will be pulled to VCC.	
SW3	GPIO_13	When pushed, the GPIO_13 will be pulled to VCC.	

Table 9. LEDs

Reference	Color	Usage	Comments	
D1	Yellow	nRESET	This LED is used to indicate the state of nRESET pin. If this LED is glowing, the device is functional.	
D2	Green	Debug	This LED glows whenever the debugging is enabled over the JTAG	
D4	RED	Power	Indicates when the 3.3 V power is supplied to the board.	
D5	GREEN	GPIO_11 ⁽¹⁾	Glowes when the GPIO is logic-1	
D6	YELLOW	GPIO_10 ⁽¹⁾	Glowes when the GPIO is logic-1	
D7	RED	GPIO_09	Glowes when the GPIO is logic-1	

⁽¹⁾ GPIO_10 and GPIO_11 are used as I2C also. So whenever the pull-ups are enabled, the LEDs would glow.

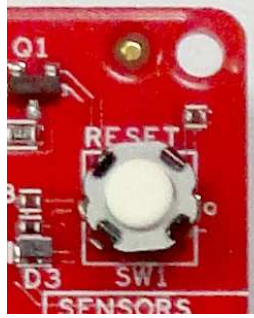
2.4.8 2x20 Pin Connector Assignment

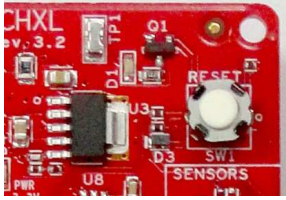
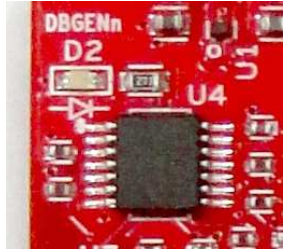
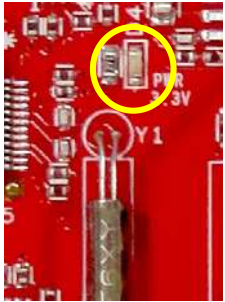
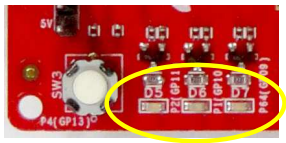
The signal assignment on the 2x20 pin connector is shown in Figure 8. The P1-Pn naming convention is used for 2x20 pin connectors only.

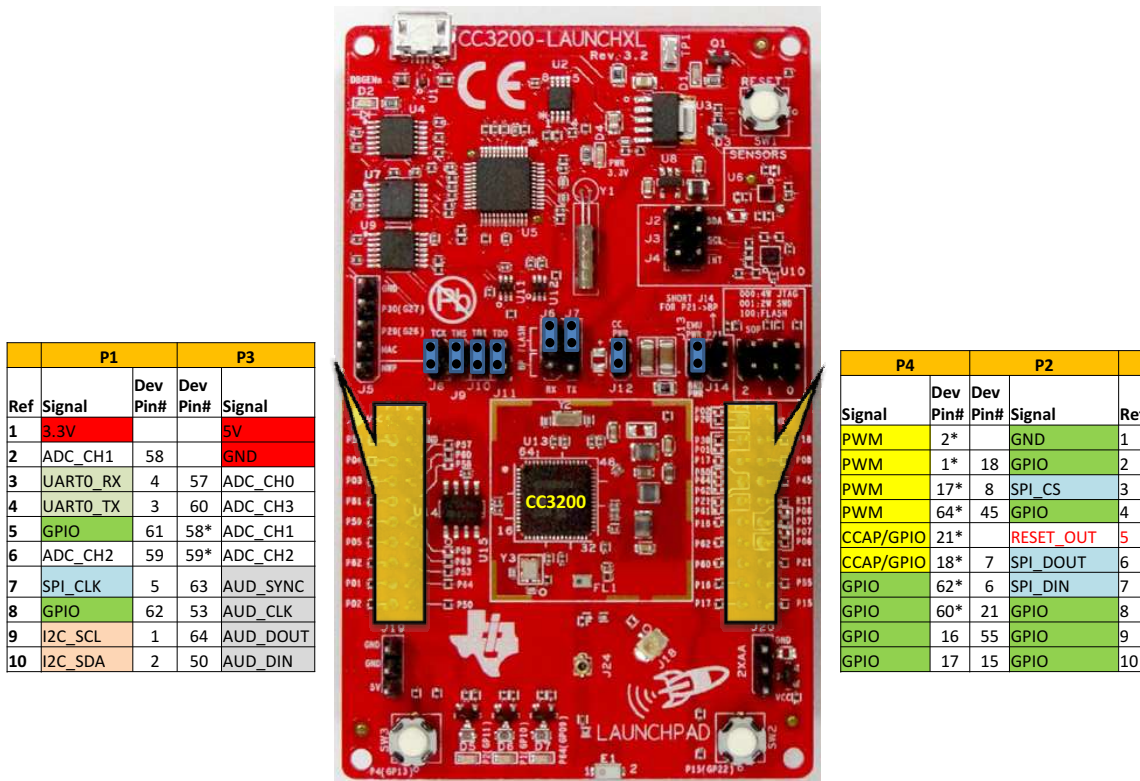

Figure 8. 2x20 Pin Connector

The signal mappings are as indicated in above table shown in Figure 8. All the signals are referred by the pin number in the SDK and Figure 8 shows the default mappings. Note that some of the pins are repeated across the connector. For instance, pin 62 is available on P1 and P4, but only P1 is connected by default. The signal on P4 is marked with a *(star) to signify that it is not connected by default. It can be routed to the pin by using a 0 Ω resistor in the path. For the exact resistor placement, see the [schematics and placement diagram](#).

2.5 Power

The LaunchPad is designed such that it can be powered by the USB connection or by external 2xAA/2xAAA batteries.

2.5.1 USB Power

The LaunchPad is designed to work from the USB provided power supply. The LaunchPad will enumerate as a bus-powered device on the computer. When the board is powered from the USB connector, make sure that the jumpers are placed on the following headers, as shown in [Figure 9](#).

J12 (shorted)

J13 (shorted)

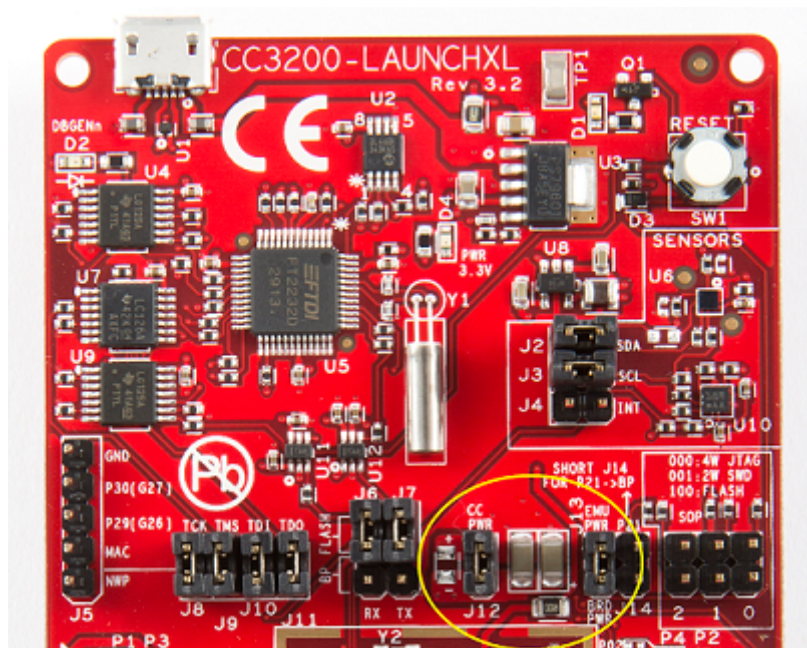

Figure 9. Powering From USB

2.5.2 Battery Power (2 x 1.5 V)

The LaunchPad can also be powered from an external battery pack by feeding the voltage on the J20 header. This input features reverse voltage protection to ensure that the board is not damaged due to an accidental reverse voltage. The following care should be taken while using the board with a battery

1. Remove the USB cable.
2. Plug-in the battery pack on J20 with correct polarity (see [Figure 10](#)).

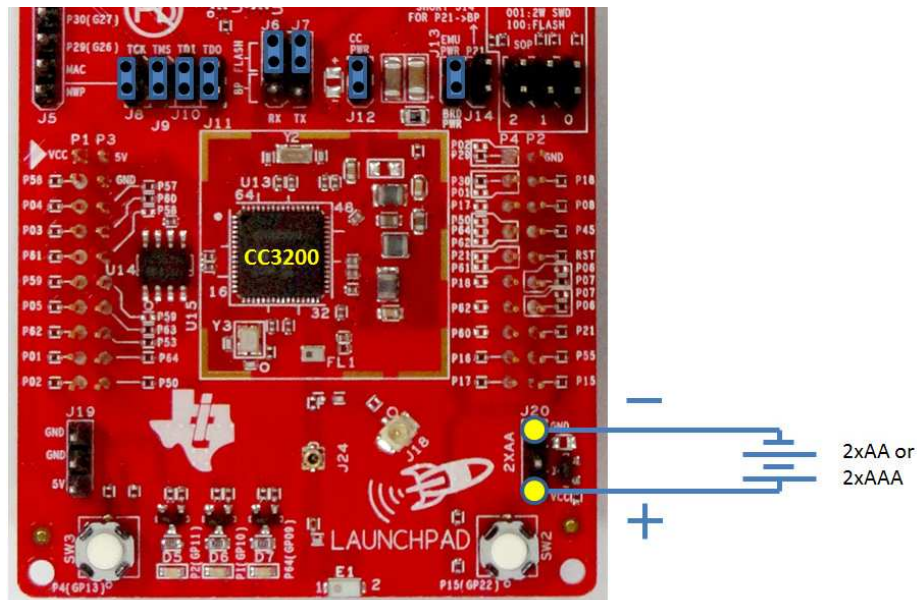

Figure 10. Battery Power

2.5.3 BoosterPack Power Supply

The CC3200 LaunchPad can be powered by a stacked booster-pack which can provide a 3.3 V power on P1.1. During this mode, ensure that the J13 is removed so that the on-board LDO is not overloaded.

2.6 Measure CC3200 Current Draw

To measure the current draw of the CC3200, use the 3V3 jumper on the jumper isolation block. (J12). The current measured in this mode includes only the CC3200 current and no external blocks. However, if a GPIO of the CC3200 is driving a high current load like LED, then that is also included in this measurement.

2.6.1 Measuring Low Power (< 1mA)

Follow these steps to measure ultra-low power:

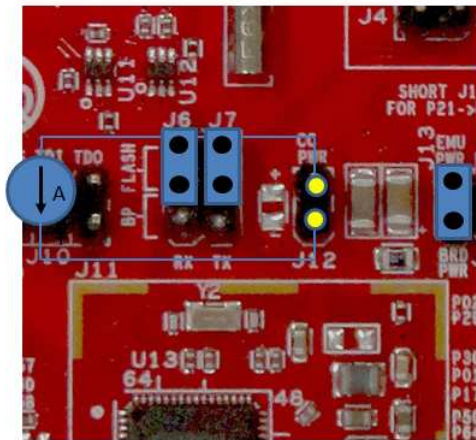

Figure 11. Measuring Low Power

1. Remove the 3V3 jumper (J12); attach an ammeter across this jumper.
2. Make sure that the CC3200 is not driving any high current loads directly like an LED as this can cause large current drawn.
3. Begin target execution and set the device to low-power modes (LPDS or Hibernate).
4. Measure the current. (Keep in mind that if the current levels are fluctuating, it may be difficult to get a stable measurement. It is easier to measure quiescent states.)

2.6.2 Measuring Active Power

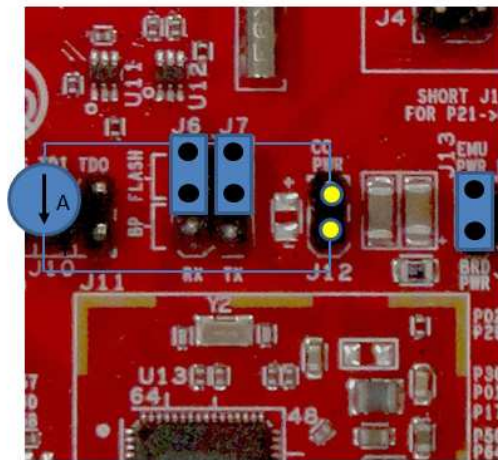

Figure 12. Measuring Active Power

1. Remove the 3V3 jumper (J12).
2. Solder a 0.1 Ω resistor on the board at R62. Or, attach a jumper wire between J12 so that it can be used with a current probe.
3. Measure the voltage across the R62 using an oscilloscope with a differential probe. (For the current probe, coil the wire around the sensor multiple times for good sensitivity).
4. An ammeter can also be used for this measurement, but the results may be erroneous due to the switching nature of the current.

2.7 RF Connections

2.7.1 Radiated Testing (AP connection)

By default the board ships with the RF signals routed to the on-board chip antenna. An on-board u.fl (Murata) connector provides a means to perform the testing in the lab using a compatible cable.

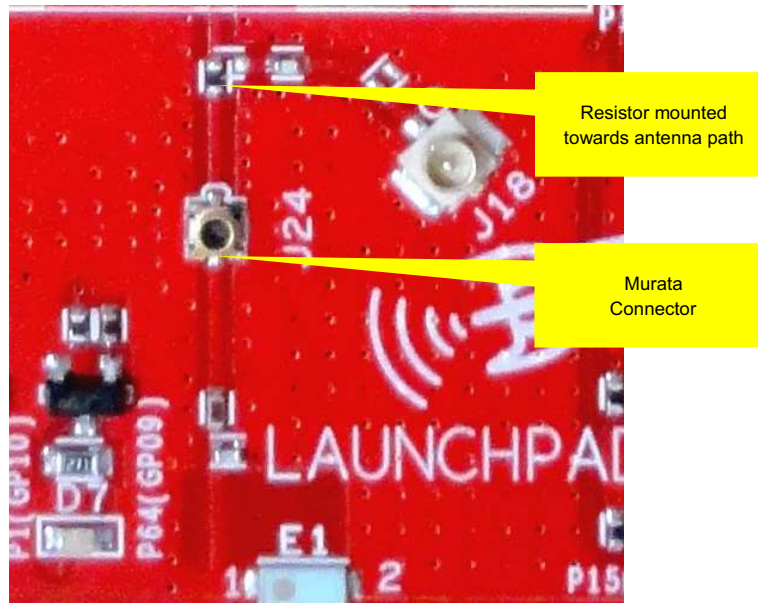

Figure 13. Radiated Testing Using Chip Antenna

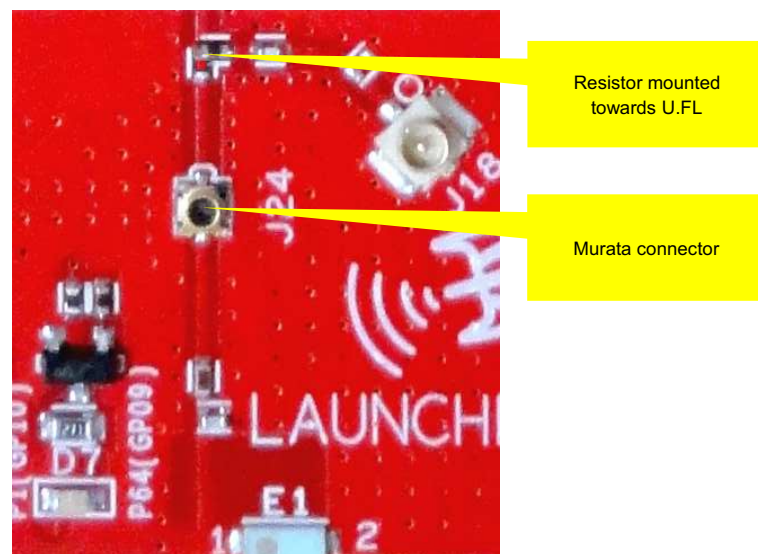

Figure 14. Board Set for Conducted Testing

2.8 Design Files

2.8.1 Hardware

All design files include schematics, layout, Bill of Materials (BOM), Gerber files and documentation, which are made available for download from the following URL: <http://www.ti.com/tool/cc3200-launchxl-rd>.

2.8.2 Revision History

Table 10. Change Log

PCB Revision	Description
Rev 3.0B	<ul style="list-style-type: none"> • First baseline revision
Rev 3.1	<p>The main changes pertain to the bill of materials (BOM) and the layout:</p> <ul style="list-style-type: none"> • Replaced the caps C23, C24 with ceramic ones to minimize leakage current • R62 is made to DNP by default so that the jumper is used to measure the hibernate current • Misc silk screen changes in order to clearly annotate components on the board.
Rev 3.2	<ul style="list-style-type: none"> • Layout changes for the DC-DC section in order to improve the mask margin • Updated the silk screen to reflect the final markings.

2.8.3 Software

All design files including firmware patches, software example projects, and documentation are made available from the [SimpleLink Wi-Fi Platform page](#).

The Software Development Kit (SDK) to use with the CC3200 LaunchPad can be obtained from <http://www.ti.com/tool/cc3200sdk>.

3 Software Examples

3.1 Development Environment Requirements

To use any of the following software examples with the LaunchPad, you must have an integrated development environment (IDE) that supports the CC3200 device.

For more details on where to download the latest IDE, see [Section 4.3](#).

The CC3200 Programmer's guide ([SWRU369](#)) has detailed information on software environment setup, and examples. Please refer to this document for further details on the software sample examples.

3.1.1 CCS

CCS 6.0 or higher is required. When CCS has been launched, and a workspace directory chosen, use *Project* → *Import Existing CCS Eclipse Project*. Direct it to the desired demo's project directory containing main.c.

3.1.2 IAR

IAR 6.70 or higher is required. To open the demo in IAR, simply choose *File* → *Open* → *Workspace...*, and direct it to the *.eww workspace file inside the \IAR subdirectory of the desired demo. All workspace information is contained within this file.

The subdirectory also has an *.ewp project file; this file can be opened into an existing workspace, using *Project* → *Add-Existing-Project...*

4 Additional Resources

4.1 LaunchPad Wiki

Most updated information would be available on the [CC3200 Wiki page](#).

4.2 Information on the CC3200

For more information on CC3200 visit the product page (<http://www.ti.com/product/cc3200>) (datasheet and key documents like the technical reference manual (TRM)) and Wiki (<http://www.ti.com/simplelinkwifi-wiki>) (Organize information for Getting started, Hardware details, Software details including porting information, Test/Certification and Support and Community).

4.3 Download CCS, IAR

Although the files can be viewed with any text editor, more can be done with the projects if they're opened with a [development environment](#) like [Code Composer Studio \(CCS\)](#), [IAR](#), or Energia.

CCS and IAR are each available in a full version, or a free, code-size-limited version. The full out-of-box demo cannot be built with the free version of CCS or IAR (IAR Kickstart) due to the code size limit. To bypass this limitation, a code-size-limited CCS version is provided, that has most functionality integrated into a library. The code that is built into the library is able to be viewed by the user, but it cannot be edited. For full functionality download the full version of either CCS or IAR.

4.4 The CC3200 Code Examples

The user's guide for each example can be found within the [Software Development Kit \(SDK\)](#), or on the [Simplelink Wiki](#).

4.5 CC3200 Application Notes

There are many application notes with practical design examples and topics located at the [SimpleLink\(TM\) Wi-Fi\(R\) main wiki page](#), and the [main landing page](#).

4.6 The Community

4.6.1 TI E2E Community

Search the forums at e2e.ti.com. If you cannot find your answer, post your question to the community!

5 Known Limitations

5.1 Hardware Limitations

5.1.1 Floating S-Flash Lines

The SPI lines routed from the CC3200 to the on-board serial Flash are not pulled up/down using resistors on the board. When the device enters "Hibernate" state these pins can be floating and high currents can be drawn by the serial Flash.

5.1.2 Floating IO

All the GPIO outputs from the CC3200 device would float while the device enters hibernate state. This can cause glitches on the lines if they are not pulled externally.

IMPORTANT NOTICE

Texas Instruments Incorporated and its subsidiaries (TI) reserve the right to make corrections, enhancements, improvements and other changes to its semiconductor products and services per JESD46, latest issue, and to discontinue any product or service per JESD48, latest issue. Buyers should obtain the latest relevant information before placing orders and should verify that such information is current and complete. All semiconductor products (also referred to herein as "components") are sold subject to TI's terms and conditions of sale supplied at the time of order acknowledgment.

TI warrants performance of its components to the specifications applicable at the time of sale, in accordance with the warranty in TI's terms and conditions of sale of semiconductor products. Testing and other quality control techniques are used to the extent TI deems necessary to support this warranty. Except where mandated by applicable law, testing of all parameters of each component is not necessarily performed.

TI assumes no liability for applications assistance or the design of Buyers' products. Buyers are responsible for their products and applications using TI components. To minimize the risks associated with Buyers' products and applications, Buyers should provide adequate design and operating safeguards.

TI does not warrant or represent that any license, either express or implied, is granted under any patent right, copyright, mask work right, or other intellectual property right relating to any combination, machine, or process in which TI components or services are used. Information published by TI regarding third-party products or services does not constitute a license to use such products or services or a warranty or endorsement thereof. Use of such information may require a license from a third party under the patents or other intellectual property of the third party, or a license from TI under the patents or other intellectual property of TI.

Reproduction of significant portions of TI information in TI data books or data sheets is permissible only if reproduction is without alteration and is accompanied by all associated warranties, conditions, limitations, and notices. TI is not responsible or liable for such altered documentation. Information of third parties may be subject to additional restrictions.

Resale of TI components or services with statements different from or beyond the parameters stated by TI for that component or service voids all express and any implied warranties for the associated TI component or service and is an unfair and deceptive business practice. TI is not responsible or liable for any such statements.

Buyer acknowledges and agrees that it is solely responsible for compliance with all legal, regulatory and safety-related requirements concerning its products, and any use of TI components in its applications, notwithstanding any applications-related information or support that may be provided by TI. Buyer represents and agrees that it has all the necessary expertise to create and implement safeguards which anticipate dangerous consequences of failures, monitor failures and their consequences, lessen the likelihood of failures that might cause harm and take appropriate remedial actions. Buyer will fully indemnify TI and its representatives against any damages arising out of the use of any TI components in safety-critical applications.

In some cases, TI components may be promoted specifically to facilitate safety-related applications. With such components, TI's goal is to help enable customers to design and create their own end-product solutions that meet applicable functional safety standards and requirements. Nonetheless, such components are subject to these terms.

No TI components are authorized for use in FDA Class III (or similar life-critical medical equipment) unless authorized officers of the parties have executed a special agreement specifically governing such use.

Only those TI components which TI has specifically designated as military grade or "enhanced plastic" are designed and intended for use in military/aerospace applications or environments. Buyer acknowledges and agrees that any military or aerospace use of TI components which have **not** been so designated is solely at the Buyer's risk, and that Buyer is solely responsible for compliance with all legal and regulatory requirements in connection with such use.

TI has specifically designated certain components as meeting ISO/TS16949 requirements, mainly for automotive use. In any case of use of non-designated products, TI will not be responsible for any failure to meet ISO/TS16949.

Products

Audio	www.ti.com/audio
Amplifiers	amplifier.ti.com
Data Converters	dataconverter.ti.com
DLP® Products	www.dlp.com
DSP	dsp.ti.com
Clocks and Timers	www.ti.com/clocks
Interface	interface.ti.com
Logic	logic.ti.com
Power Mgmt	power.ti.com
Microcontrollers	microcontroller.ti.com
RFID	www.ti-rfid.com
OMAP Applications Processors	www.ti.com/omap
Wireless Connectivity	www.ti.com/wirelessconnectivity

Applications

Automotive and Transportation	www.ti.com/automotive
Communications and Telecom	www.ti.com/communications
Computers and Peripherals	www.ti.com/computers
Consumer Electronics	www.ti.com/consumer-apps
Energy and Lighting	www.ti.com/energy
Industrial	www.ti.com/industrial
Medical	www.ti.com/medical
Security	www.ti.com/security
Space, Avionics and Defense	www.ti.com/space-avionics-defense
Video and Imaging	www.ti.com/video

TI E2E Community

e2e.ti.com