

## 50 ohm nominal input / conjugate match balun to Spirit1, with integrated harmonic filter

Datasheet – production data

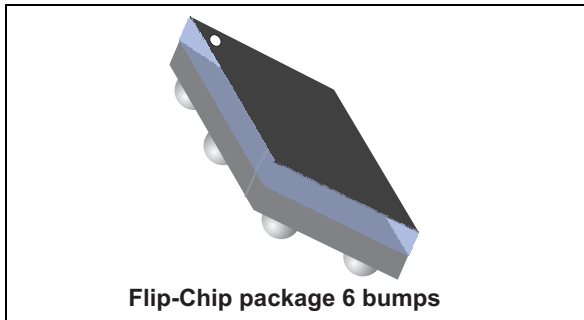

Figure 1. Pin coordinates (top view)

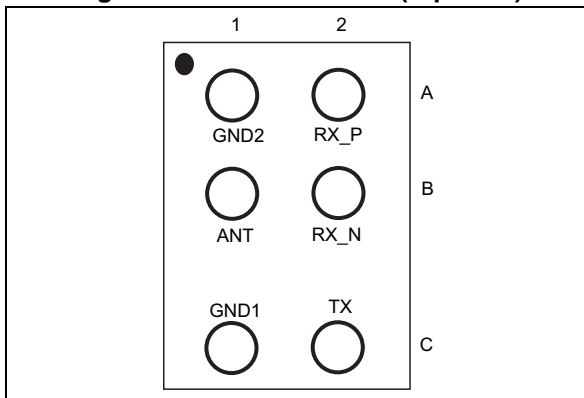
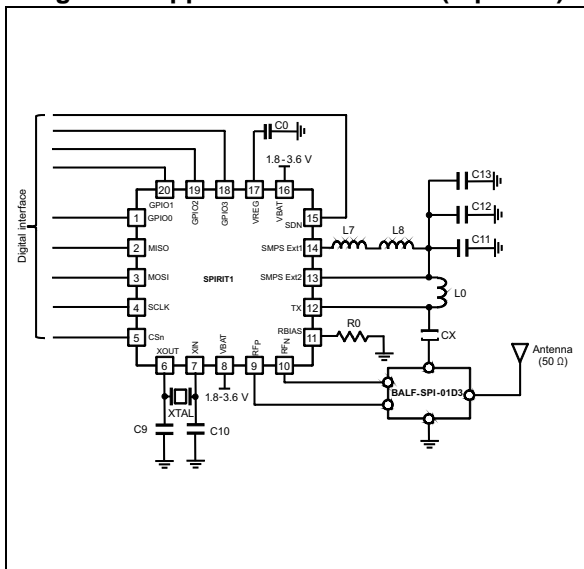

Figure 2. Application schematic (top view)



### Features

- 50 Ω nominal input / conjugate match to Spirit1
- Low insertion loss
- Low amplitude imbalance
- Low phase imbalance
- Small footprint

### Benefits

- Very low profile (< 670 μm)
- High RF performance
- RF BOM and area reduction

### Applications

- 868 MHz and 915 MHz impedance matched balun filter
- Optimized for Spirit1 sub GHz RFIC

### Description

STMicroelectronics BALF-SPI-01D3 is an ultraminiature balun. The BALF-SPI-01D3 integrates matching network and harmonics filters. Matching impedance has been customized for the Spirit1 ST transceiver.

The BALF-SPI-01D3 uses STMicroelectronics IPD technology on non-conductive glass substrate which optimize RF performances.

# 1 Characteristics

**Table 1. Absolute maximum ratings (limiting values)**

Symbol	Parameter	Value			Unit
		Min.	Typ.	Max.	
P <sub>IN</sub>	Input power RFIN			20	dBm
V <sub>ESD</sub>	ESD ratings human body model (JESD22-A114-C), all I/O one at a time while others connected to GND	2000			V
	ESD ratings machine model, all I/O	200			
T <sub>OP</sub>	Operating temperature (JESD22-A115-C), all I/O	-40		+85	°C

**Table 2. Impedances (T<sub>amb</sub> = 25 °C)**

Symbol	Parameter	Value			Unit
		Min.	Typ.	Max.	
Z <sub>RX</sub>	Nominal differential RX balun impedance		match to Spirit1		Ω
Z <sub>TX</sub>	Nominal TX filter impedance				
Z <sub>ANT</sub>	Antenna impedance		50		Ω

**Table 3. RF performance (T<sub>amb</sub> = 25 °C)**

Symbol	Parameter	Test condition	Value			Unit
			Min.	Typ.	Max.	
F	Frequency range (bandwidth)		779	868	956	MHz
S <sub>21</sub> <sub>RX-ANT</sub>	Insertion loss in bandwidth without mismatch loss (RX balun)			-1.7	-2	dB
S <sub>21</sub> <sub>TX-ANT</sub>	Insertion loss in bandwidth without mismatch loss (TX filter)			-1.4	-2	dB
S <sub>11</sub> <sub>ANT</sub>	Input return loss in bandwidth (RX balun)			-23	-15	dB
S <sub>11</sub> <sub>ANT</sub>	Input return loss in bandwidth (TX filter)			-15	-12	dB
Φ <sub>imb</sub>	Output phase imbalance (RX balun)		5	10	15	°
A <sub>imb</sub>	Output amplitude imbalance (RX balun)			0.35	0.8	dB
Att	Harmonic levels (TX filter)	Attenuation at 2fo		-35		dBm
		Attenuation at 3fo		-40		

### 1.1 RF measurement (Rx balun)

Figure 3. Insertion loss ( $T_{amb} = 25\text{ }^{\circ}\text{C}$ )

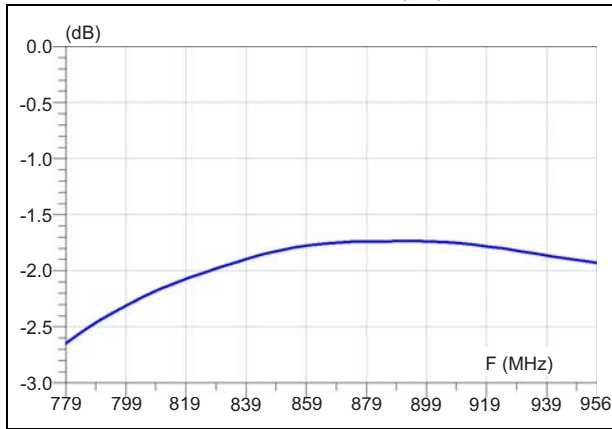

Figure 4. Return loss antenna ( $T_{amb} = 25\text{ }^{\circ}\text{C}$ )

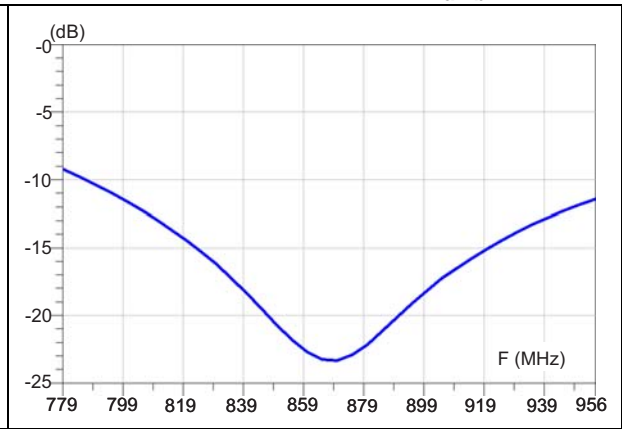

Figure 5. Phase imbalance ( $T_{amb} = 25\text{ }^{\circ}\text{C}$ )

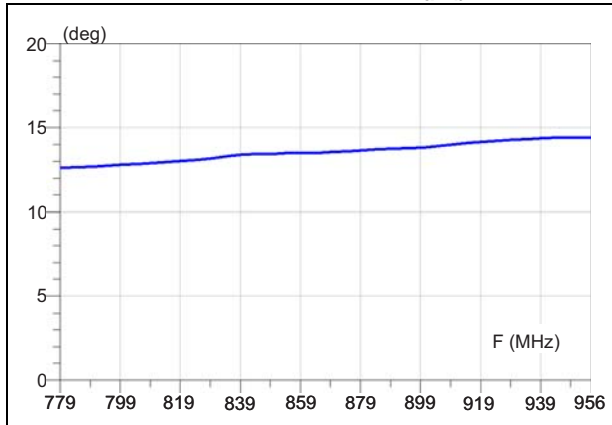
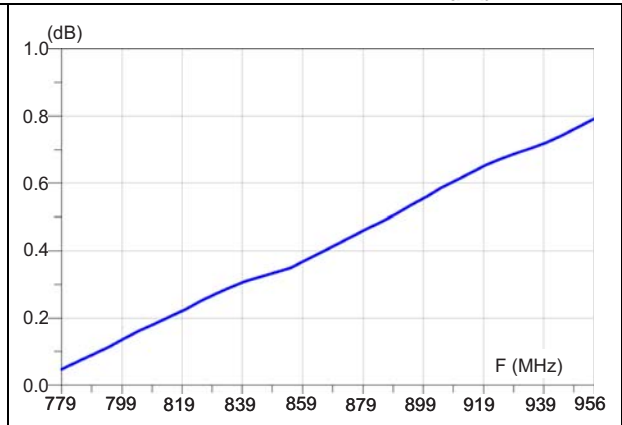

Figure 6. Amplitude imbalance ( $T_{amb} = 25\text{ }^{\circ}\text{C}$ )



## 1.2 RF measurement (Tx filter)

Figure 7. Transmission ( $T_{amb} = 25\text{ }^{\circ}\text{C}$ )

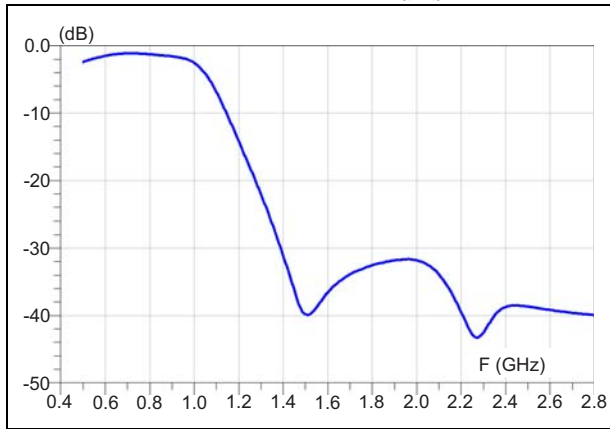

Figure 8. Insertion loss ( $T_{amb} = 25\text{ }^{\circ}\text{C}$ )

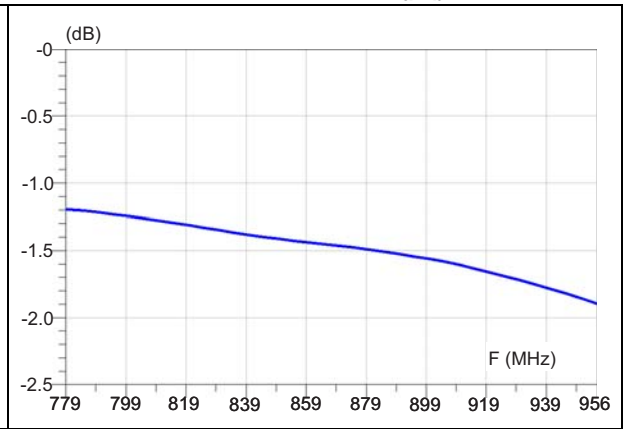

Figure 9. Attenuation ( $T_{amb} = 25\text{ }^{\circ}\text{C}$ )

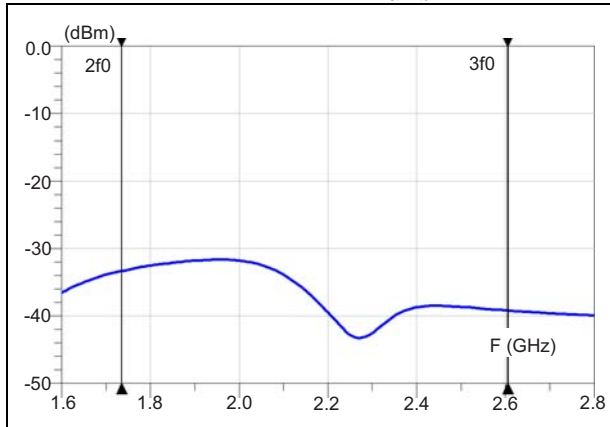
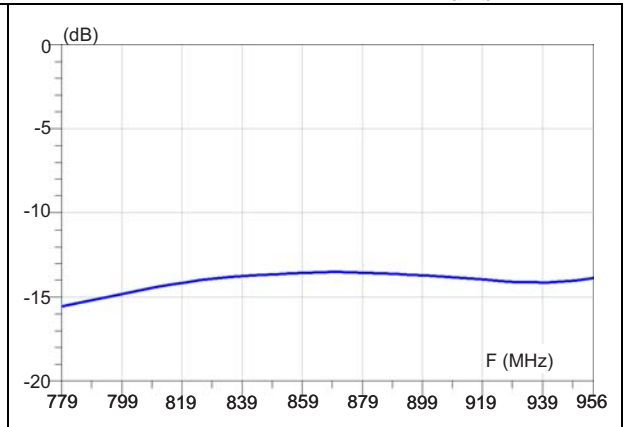

Figure 10. Return loss antenna ( $T_{amb} = 25\text{ }^{\circ}\text{C}$ )



## 2 Application information

Figure 11. Application board EVB (4 layers)

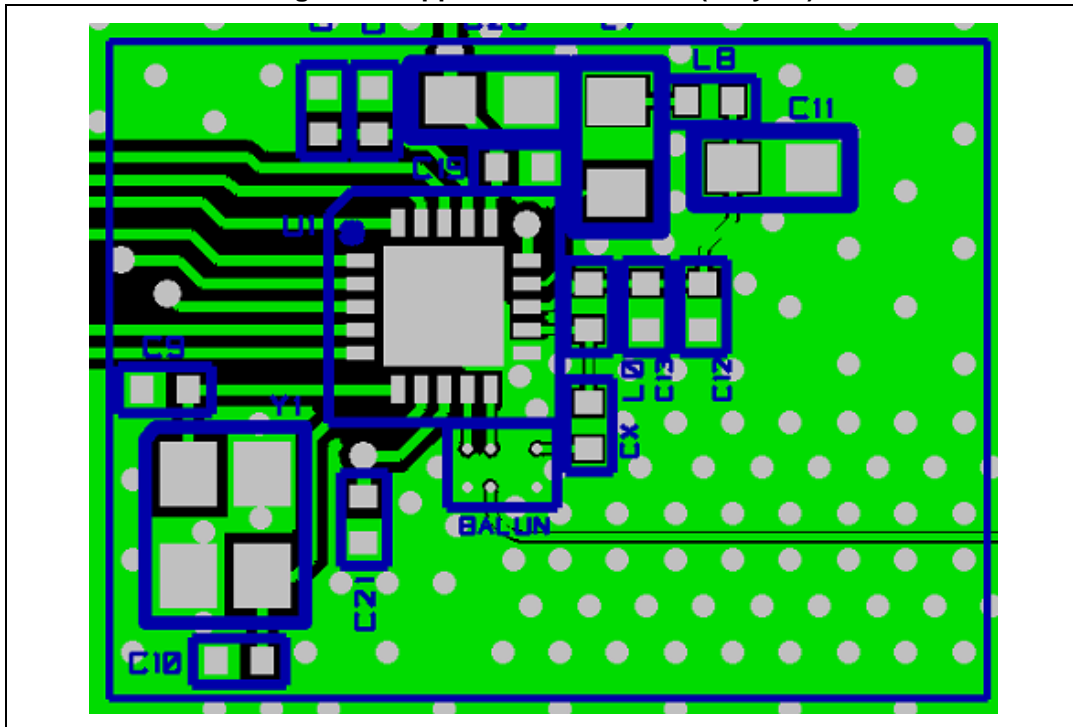

Figure 12. TX output measurements with BALF-SPI-01D3 at 868 MHz

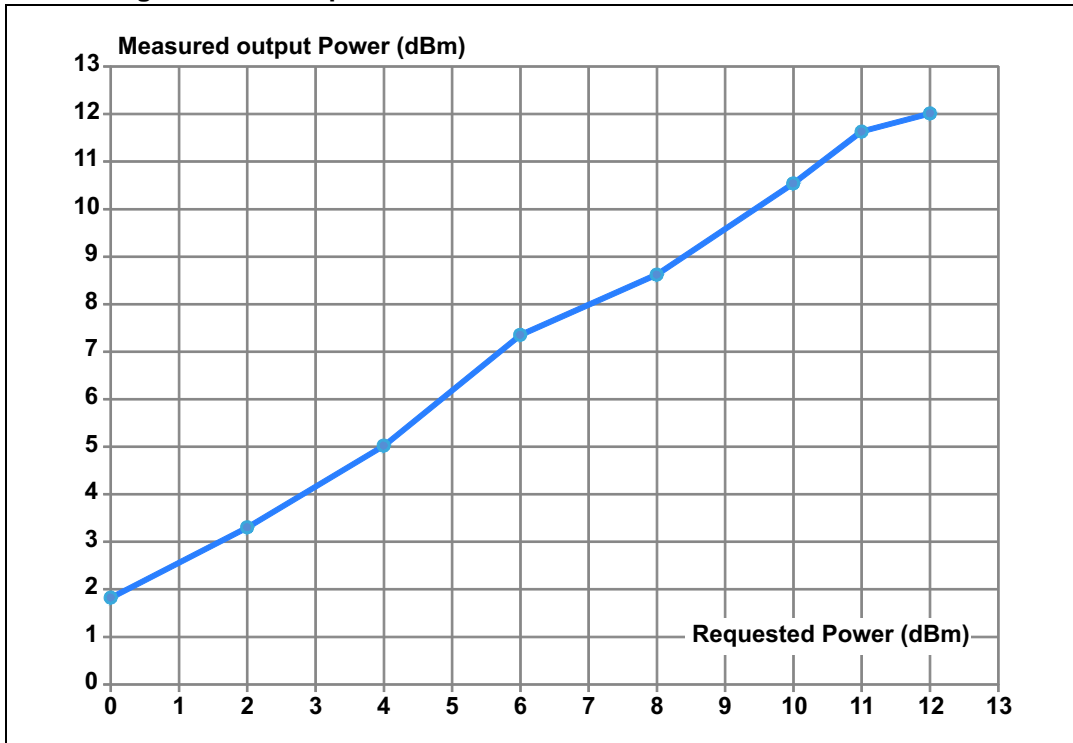

Figure 13. TX output power measurements over frequency with BALF-SPI-01D3

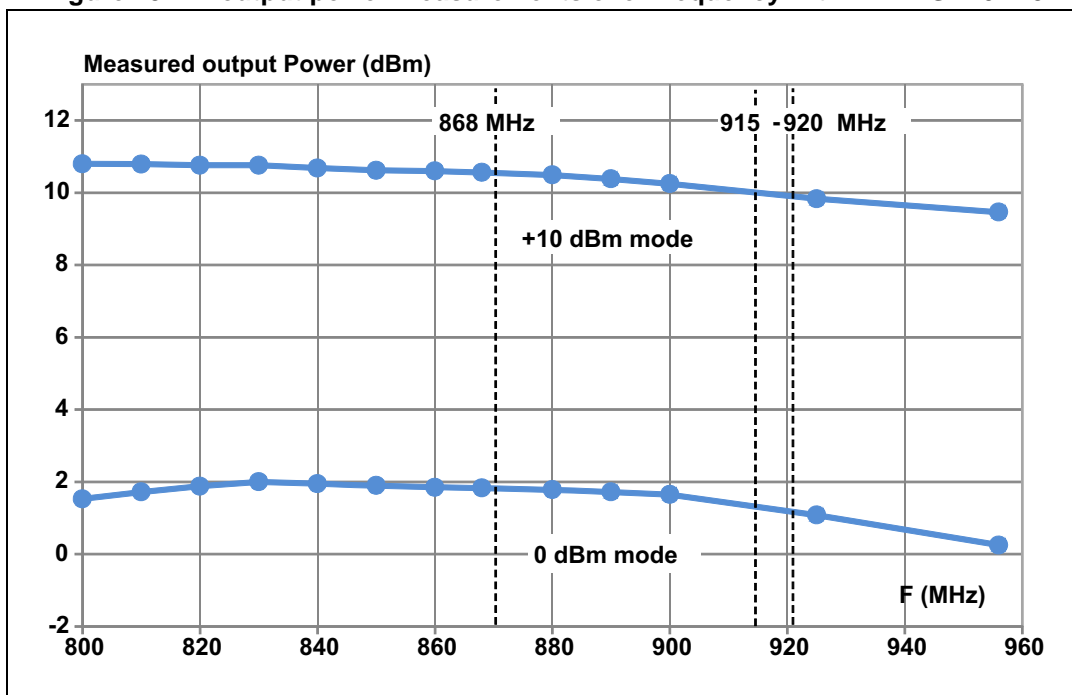
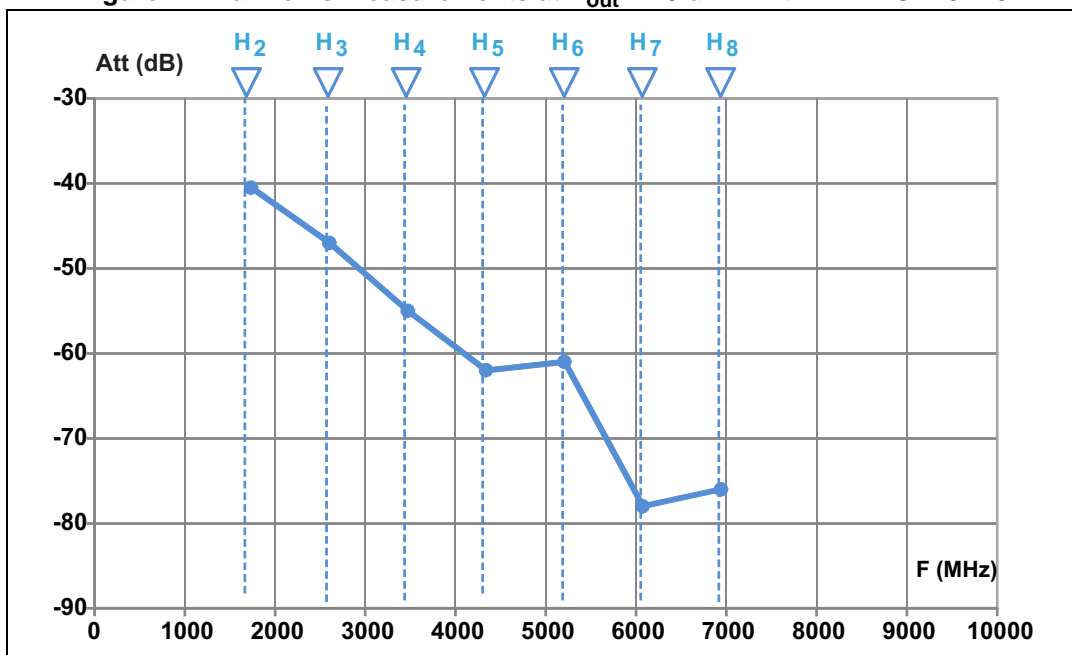

Figure 14. Harmonic measurements at  $P_{out} = 10$  dBm with BALF-SPI-01D3



### 3 Package information

- Epoxy meets UL94, V0
- Lead-free package

In order to meet environmental requirements, ST offers these devices in different grades of ECOPACK<sup>®</sup> packages, depending on their level of environmental compliance. ECOPACK<sup>®</sup> specifications, grade definitions and product status are available at: [www.st.com](http://www.st.com). ECOPACK<sup>®</sup> is an ST trademark.

Figure 15. Package dimensions (top and side view)

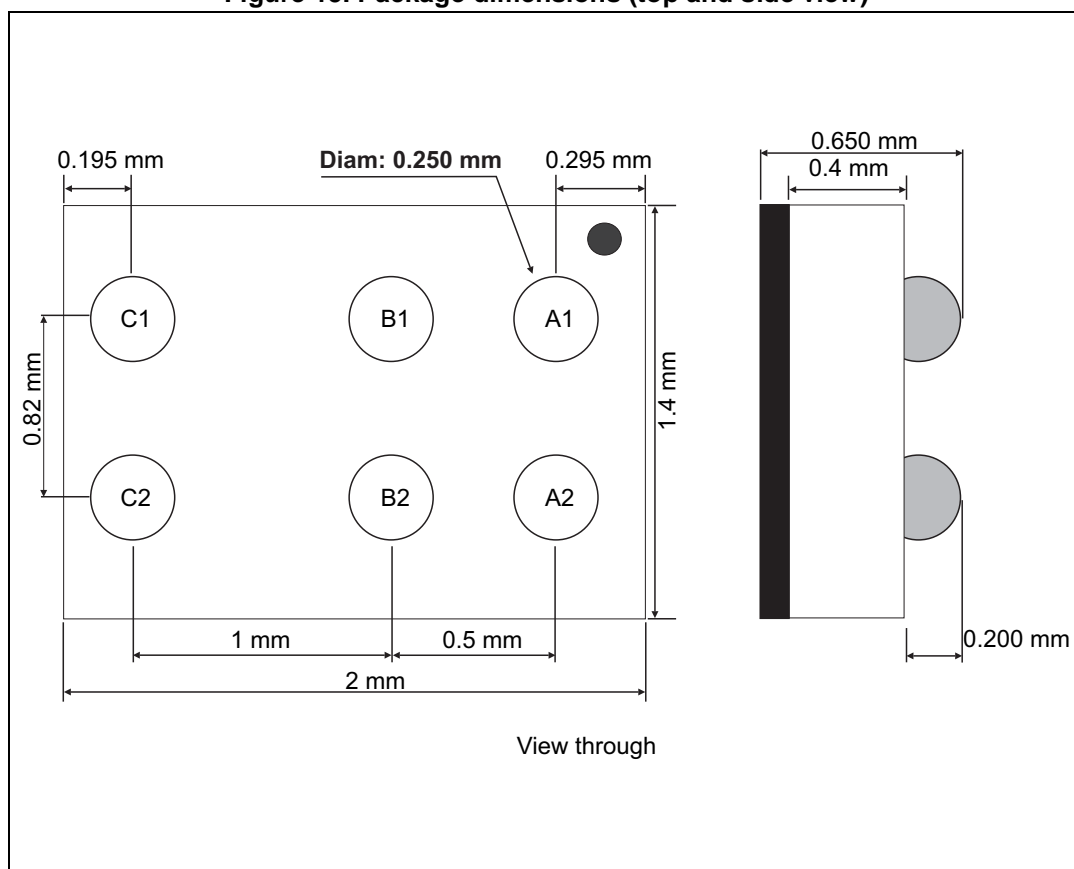

Figure 16. Recommended balun land pattern

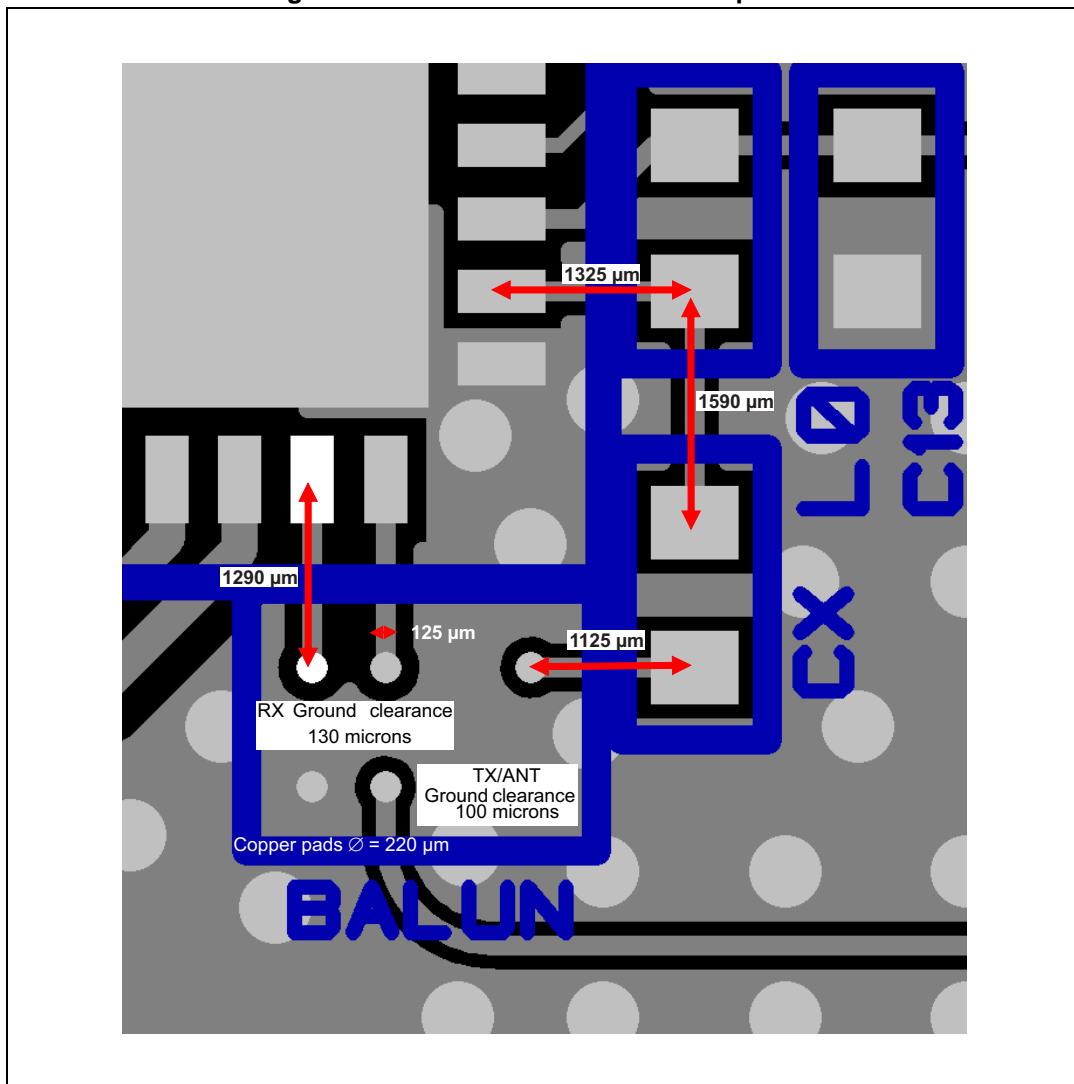

Figure 17. Footprint - non solder mask defined

Figure 18. Footprint - solder mask defined

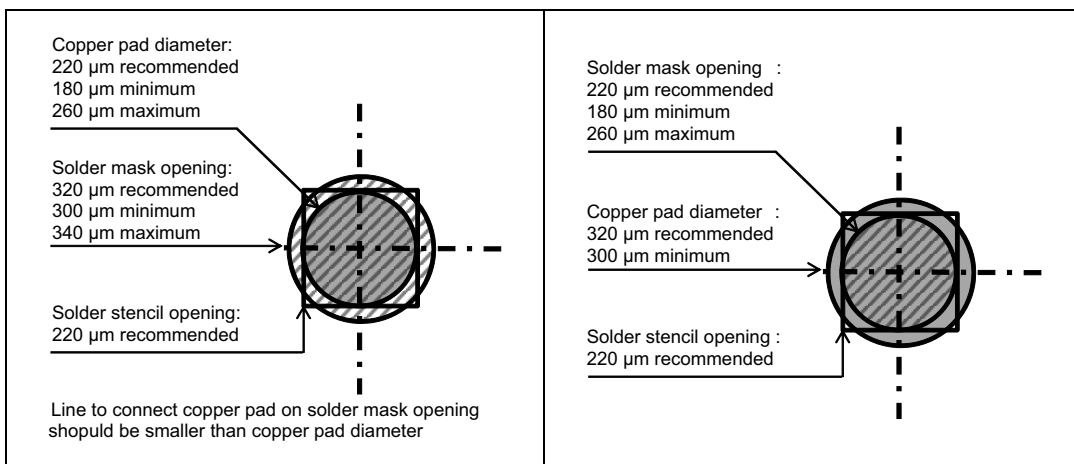



Figure 19. Marking

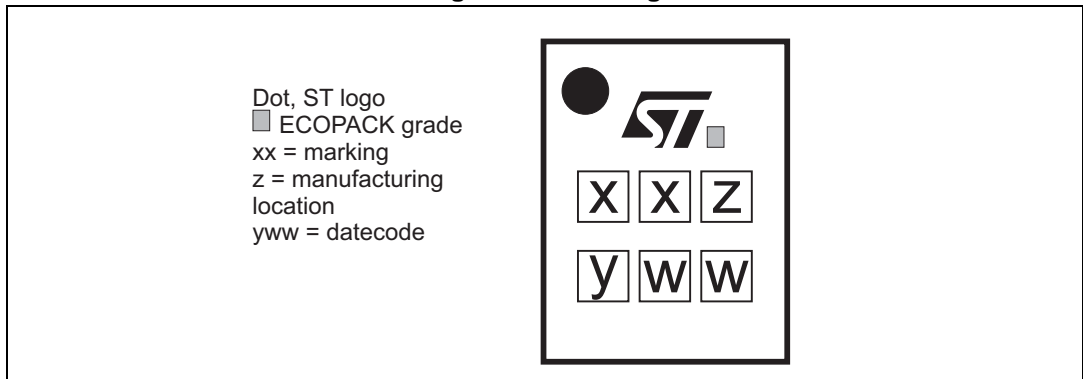
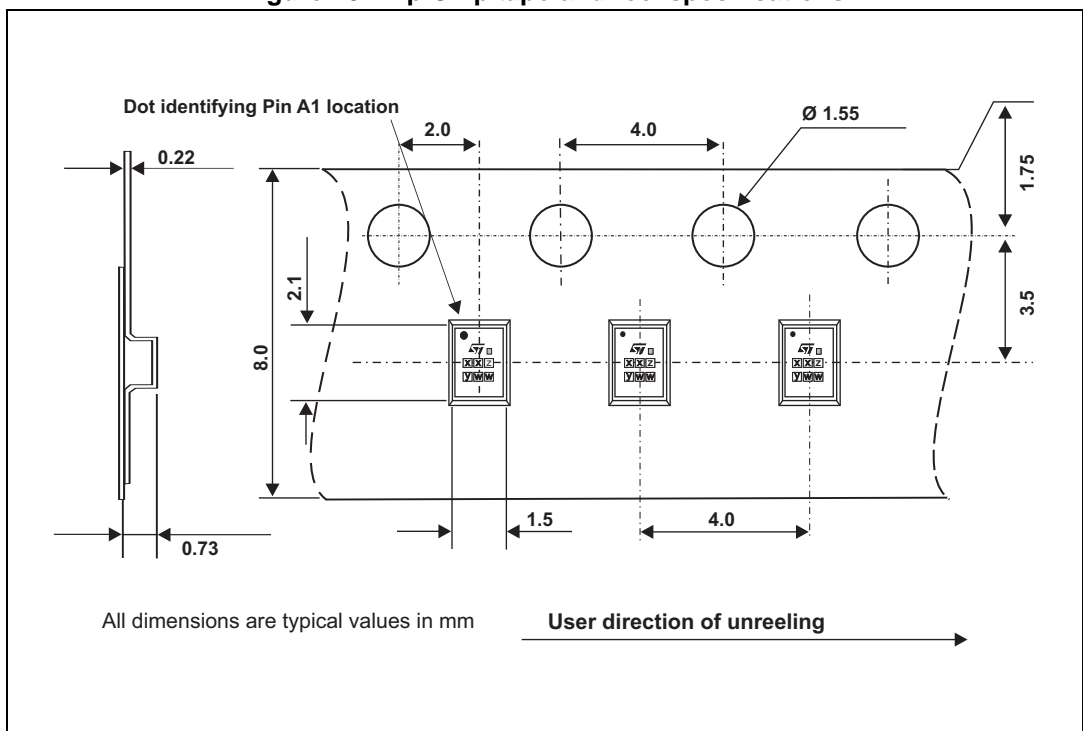

Figure 20. Flip Chip tape and reel specifications



Note: More information is available in the STMicroelectronics Application note: AN2348 Flip-Chip: "Package description and recommendations for use"

## 4 Ordering information

Table 4. Ordering information

Order code	Marking	Weight	Base Qty	Delivery mode
BALF-SPI-01D3	SJ	3.0 mg	5000	Tape and Reel

## 5 Revision history

Table 5. Document revision history

Date	Revision	Changes
27-Aug-2013	1	Initial release
03-Oct-2013	2	Updated document title. Updated <a href="#">Table 1</a> with JESD22 references.

**Please Read Carefully:**

Information in this document is provided solely in connection with ST products. STMicroelectronics NV and its subsidiaries ("ST") reserve the right to make changes, corrections, modifications or improvements, to this document, and the products and services described herein at any time, without notice.

All ST products are sold pursuant to ST's terms and conditions of sale.

Purchasers are solely responsible for the choice, selection and use of the ST products and services described herein, and ST assumes no liability whatsoever relating to the choice, selection or use of the ST products and services described herein.

No license, express or implied, by estoppel or otherwise, to any intellectual property rights is granted under this document. If any part of this document refers to any third party products or services it shall not be deemed a license grant by ST for the use of such third party products or services, or any intellectual property contained therein or considered as a warranty covering the use in any manner whatsoever of such third party products or services or any intellectual property contained therein.

**UNLESS OTHERWISE SET FORTH IN ST'S TERMS AND CONDITIONS OF SALE ST DISCLAIMS ANY EXPRESS OR IMPLIED WARRANTY WITH RESPECT TO THE USE AND/OR SALE OF ST PRODUCTS INCLUDING WITHOUT LIMITATION IMPLIED WARRANTIES OF MERCHANTABILITY, FITNESS FOR A PARTICULAR PURPOSE (AND THEIR EQUIVALENTS UNDER THE LAWS OF ANY JURISDICTION), OR INFRINGEMENT OF ANY PATENT, COPYRIGHT OR OTHER INTELLECTUAL PROPERTY RIGHT.**

**ST PRODUCTS ARE NOT DESIGNED OR AUTHORIZED FOR USE IN: (A) SAFETY CRITICAL APPLICATIONS SUCH AS LIFE SUPPORTING, ACTIVE IMPLANTED DEVICES OR SYSTEMS WITH PRODUCT FUNCTIONAL SAFETY REQUIREMENTS; (B) AERONAUTIC APPLICATIONS; (C) AUTOMOTIVE APPLICATIONS OR ENVIRONMENTS, AND/OR (D) AEROSPACE APPLICATIONS OR ENVIRONMENTS. WHERE ST PRODUCTS ARE NOT DESIGNED FOR SUCH USE, THE PURCHASER SHALL USE PRODUCTS AT PURCHASER'S SOLE RISK, EVEN IF ST HAS BEEN INFORMED IN WRITING OF SUCH USAGE, UNLESS A PRODUCT IS EXPRESSLY DESIGNATED BY ST AS BEING INTENDED FOR "AUTOMOTIVE, AUTOMOTIVE SAFETY OR MEDICAL" INDUSTRY DOMAINS ACCORDING TO ST PRODUCT DESIGN SPECIFICATIONS. PRODUCTS FORMALLY ESCC, QML OR JAN QUALIFIED ARE DEEMED SUITABLE FOR USE IN AEROSPACE BY THE CORRESPONDING GOVERNMENTAL AGENCY.**

Resale of ST products with provisions different from the statements and/or technical features set forth in this document shall immediately void any warranty granted by ST for the ST product or service described herein and shall not create or extend in any manner whatsoever, any liability of ST.

ST and the ST logo are trademarks or registered trademarks of ST in various countries.  
Information in this document supersedes and replaces all information previously supplied.

The ST logo is a registered trademark of STMicroelectronics. All other names are the property of their respective owners.

© 2013 STMicroelectronics - All rights reserved

STMicroelectronics group of companies

Australia - Belgium - Brazil - Canada - China - Czech Republic - Finland - France - Germany - Hong Kong - India - Israel - Italy - Japan - Malaysia - Malta - Morocco - Philippines - Singapore - Spain - Sweden - Switzerland - United Kingdom - United States of America

[www.st.com](http://www.st.com)