

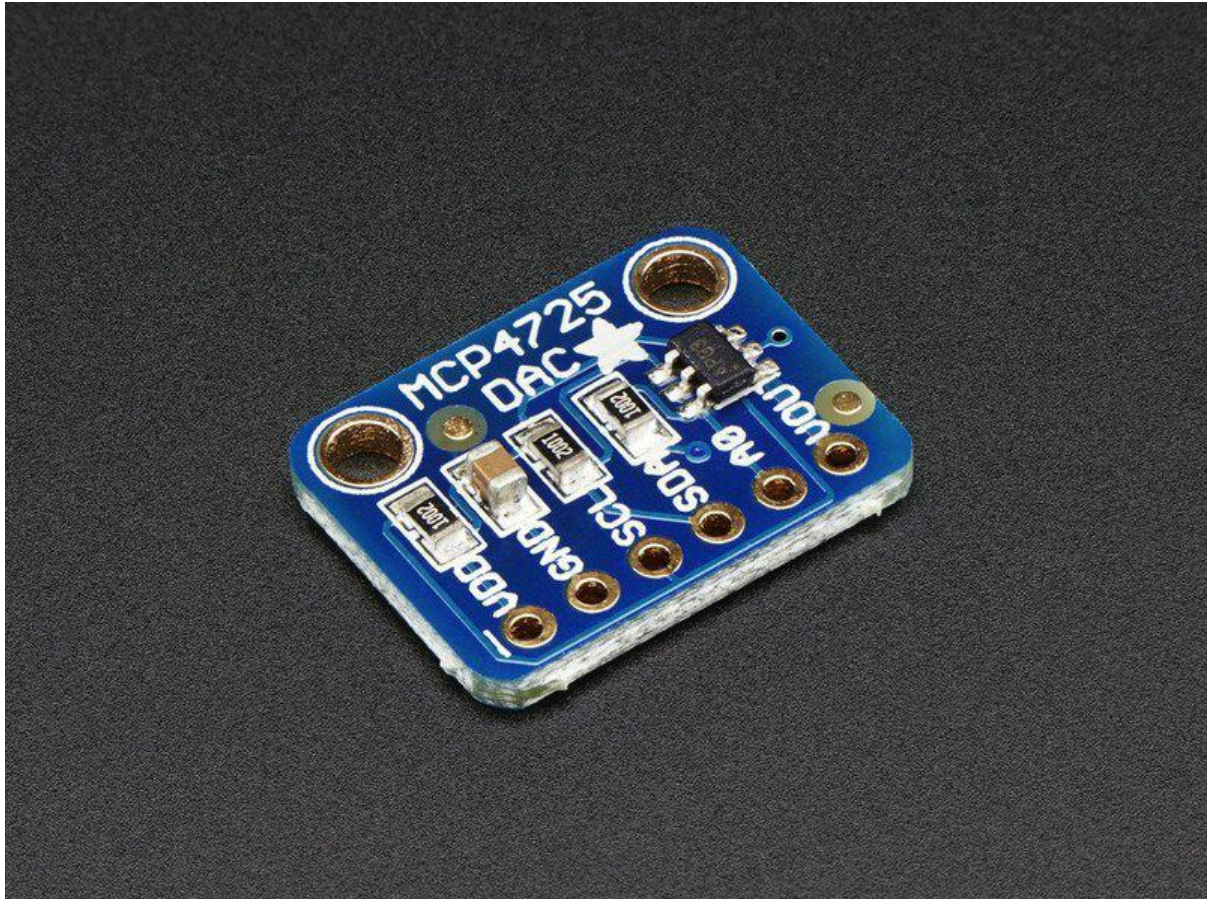

# MCP4725 12-Bit DAC Tutorial

Created by lady ada



<https://learn.adafruit.com/mcp4725-12-bit-dac-tutorial>

Last updated on 2021-11-15 05:51:37 PM EST

# Table of Contents

<a href="#">Overview</a>	3
<a href="#">Wiring</a>	3
<a href="#">Arduino Code</a>	6
• <a href="#">Increasing the speed</a>	7
• <a href="#">Using the library</a>	7
<a href="#">Python &amp; CircuitPython</a>	8
• <a href="#">CircuitPython Microcontroller Wiring</a>	8
• <a href="#">Python Computer Wiring</a>	8
• <a href="#">CircuitPython Installation of MCP4725 Library</a>	9
• <a href="#">Python Installation of MCP4725 Library</a>	10
• <a href="#">CircuitPython &amp; Python Usage</a>	10
• <a href="#">Full Example Code</a>	12
<a href="#">Python Docs</a>	12
<a href="#">Download</a>	13
• <a href="#">Files</a>	13
• <a href="#">Schematic &amp; Fabrication Print</a>	13

---

# Overview

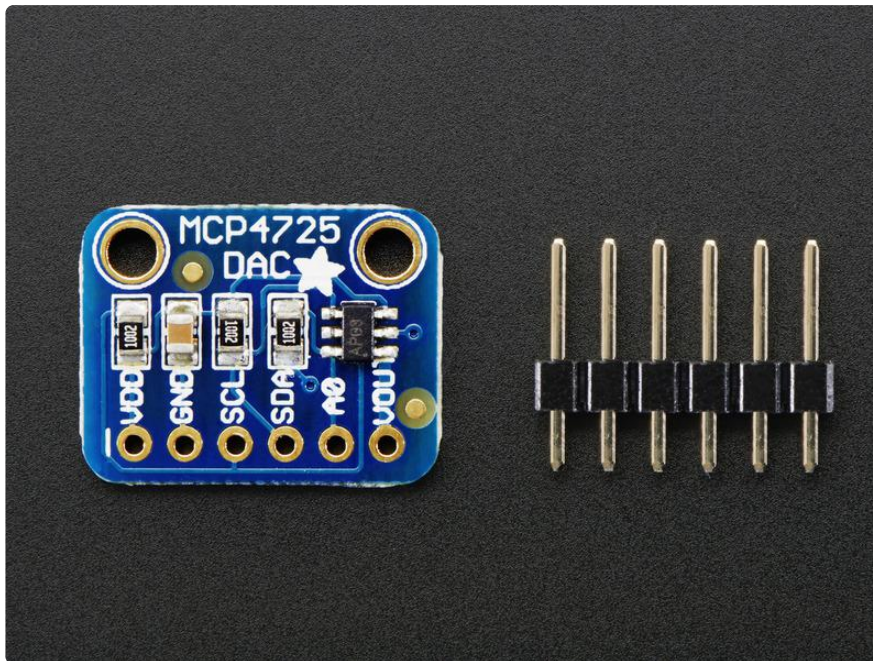

Your microcontroller probably has an ADC (analog -> digital converter) but does it have a DAC (digital -> analog converter)??? Now it can! This breakout board features the easy-to-use MCP4725 12-bit DAC. Control it via I2C and send it the value you want it to output, and the VOUT pin will have it. Great for audio / analog projects, such as when you can't use PWM but need a sine wave or adjustable bias point.

We break out the ADDR pin so you can connect two of these DACs on one I2C bus, just tie the ADDR pin of one high to keep it from conflicting. Also included is a 6-pin header, for use in a breadboard. Works with both 3.3V or 5V logic.

Some nice extras with this chip: for chips that have 3.4Mbps Fast Mode I2C (Arduino's don't) you can update the Vout at ~200 KHz. There's an EEPROM so if you write the output voltage, you can 'store it' so if the device is power cycled it will restore that voltage. The output voltage is rail-to-rail and proportional to the power pin so if you run it from 3.3V, the output range is 0-3.3V. If you run it from 5V the output range is 0-5V.

[Available from the Adafruit shop! \(http://adafru.it/935\)](http://adafru.it/935)

---

# Wiring

Wiring up the MCP4725 breakout PCB is super easy. To start, we'll attach the breakout headers so we can plug it into a breadboard.

Break off a strip of 6-pins of 0.1" male header and stick the LONG pins down into a breadboard

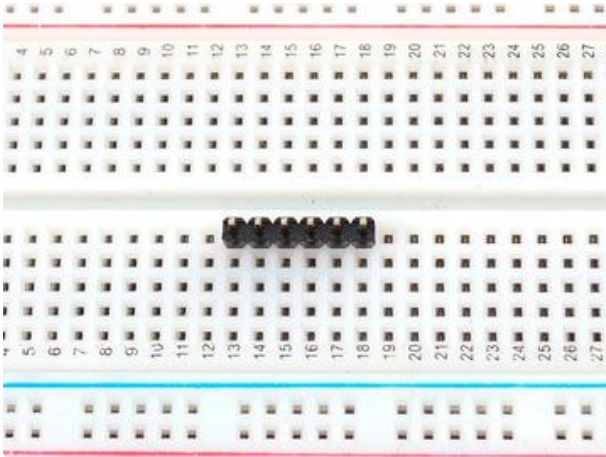

Break off a strip of 6-pins of 0.1" male header and stick the LONG pins down into a breadboard

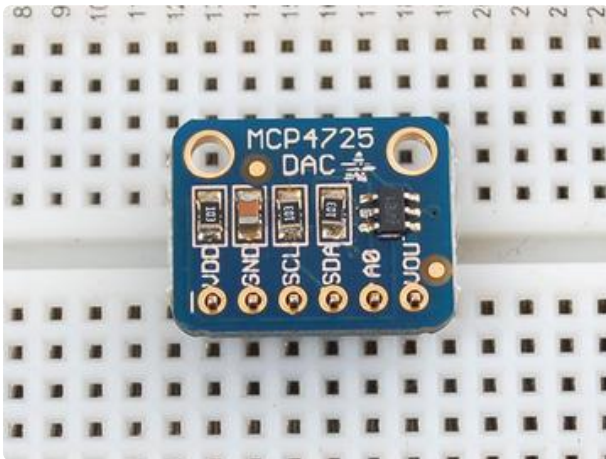

Place the breakout board on top so the short ends of the header stick up through the pads

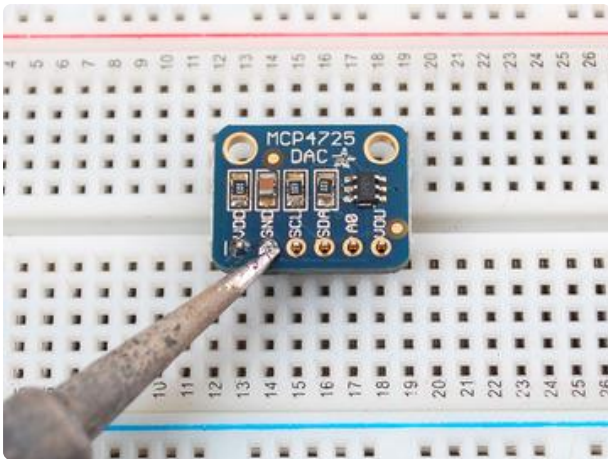

Solder each pin using a soldering iron and solder, to make solid connection on each pin.

This part is not optional! You cannot 'press fit' the header on, it must be attached permanently

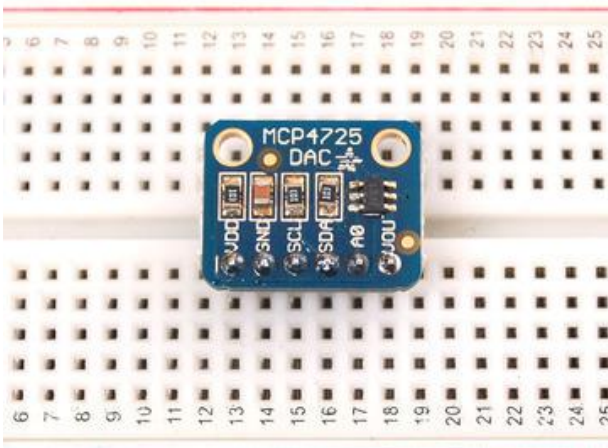

Now that the header is attached, we can wire it up. We'll demonstrate using an Arduino.

First, connect VDD (power) to a 3-5V power supply, and GND to ground.

The DAC uses I2C, a two-pin interface that can have up to 127 unique sensors attached (each must have a different ADDRESS).

- SDA to I2C Data (on the Uno, this is A4 on the Mega it is 20 and on the Leonardo digital 2)
- SCL to I2C Clock (on the Uno, this is A5 on the Mega it is 21 and on the Leonardo digital 3)

There's two other pins remaining.

- A0 allow you to change the I2C address. By default (nothing attached to A0) the address is hex 0x62. If A0 is connected to VDD the address is 0x63. This lets you have two DAC boards connected to the same SDA/SCL I2C bus pins.

- VOUT is the voltage out from the DAC! The voltage will range from 0V (when the DAC value is 0) to VDD (when the DAC 'value' is the max 12-bit number: 0xFFF)

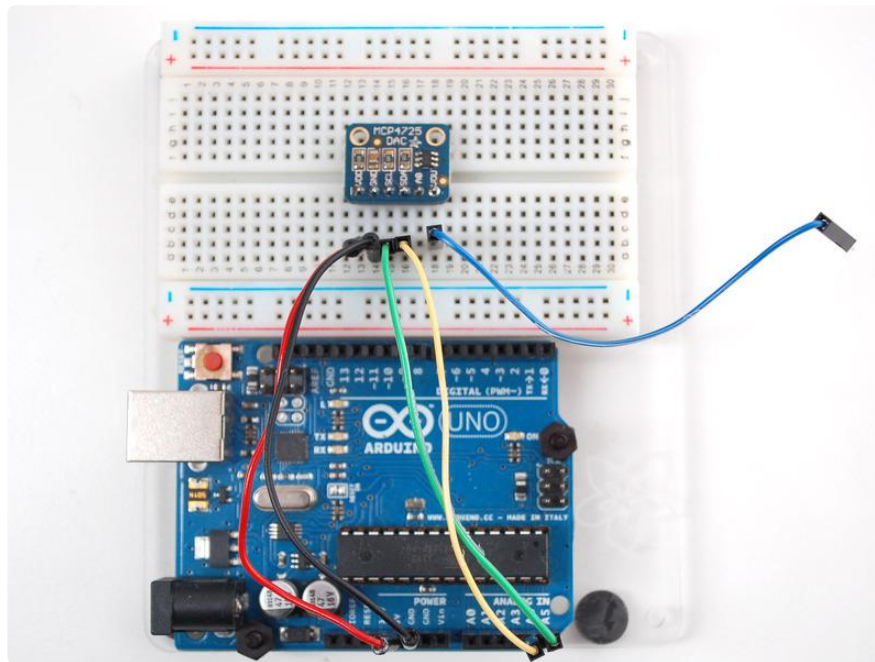

---

## Arduino Code

Next up, download the Adafruit MCP4725 library. This library does all of the interfacing, so you can just "set and forget" the DAC output. It also has some examples to get you started

[The library is available on GitHub \(https://adafru.it/aPz\)](https://adafru.it/aPz). You can download it by clicking the button below.

Download Adafruit\_MCP4725  
Library

<https://adafru.it/cDA>

Rename the uncompressed folder Adafruit\_MCP4725. Check that the Adafruit\_MCP4725 folder contains Adafruit\_MCP4725.cpp and Adafruit\_MCP4725.h

Place the Adafruit\_MCP4725 library folder your sketchbookfolder/libraries/ folder. You may need to create the libraries subfolder if its your first library. You can figure out your sketchbookfolder by opening up the Preferences tab in the Arduino IDE.

Restart the IDE.

Open up the File→Examples→Adafruit\_MCP4725→trianglewave sketch and upload it to the Arduino. Then connect your oscilloscope (or an LED + resistor if you don't have access to an oscilloscope)

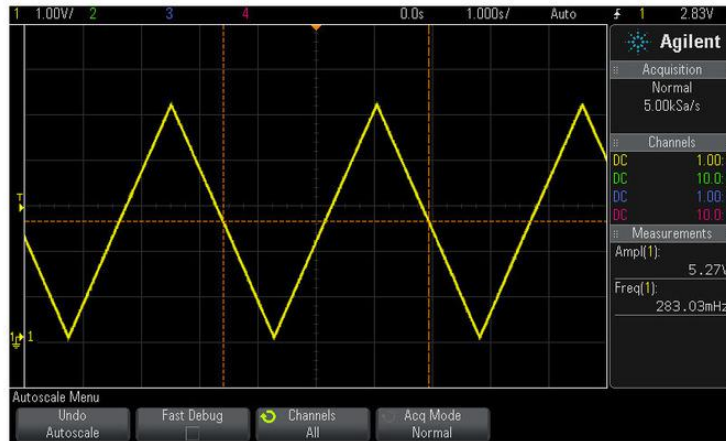

We also have a sine wave version showing how to use a lookup table to create a more complex waveform.

## Using the library

The library is very simple, so you can adapt it very quickly.

First, be sure to call `begin(addr)` where `addr` is the i2c address (default is 0x62, if A0 is connected to VCC its 0x63). Then call `setVoltage(value, storeflag)` to set the DAC output. `value` should range from 0 to 0xFFFF. `storeflag` indicates to the DAC whether it should store the value in EEPROM so that next time it starts, it'll have that same value output. You shouldn't set the flag to true unless you require it as it will take longer to do, and you could wear out the EEPROM if you write it over 20,000 times.

## Increasing the speed

One thing that's a little annoying about the Arduino Wire library in this case is it is set for 100kHz transfer speed. In the MCP4725 library we update the speed to 400kHz by setting the TWBR

```
TWBR = 12; // 400 khz
```

You can speed this up a bit more, if you'd like, check the ATmega328 datasheet for how to calculate the TWBR register.

---

## Python & CircuitPython

It's easy to use the MCP4725 digital to analog converter with Python and CircuitPython, and the [Adafruit CircuitPython MCP4725 \(https://adafru.it/C3P\)](https://adafru.it/C3P) module. This module allows you to easily write Python code that controls the output voltage from the DAC.

You can use this sensor with any CircuitPython microcontroller board or with a computer that has GPIO and Python [thanks to Adafruit\\_Blinka, our CircuitPython-for-Python compatibility library \(https://adafru.it/BSN\)](https://adafru.it/BSN).

## CircuitPython Microcontroller Wiring

First wire up a MCP4725 to your board exactly as shown on the previous pages for Arduino using an I2C connection. Here's an example of wiring a Feather M0 to the sensor with I2C:

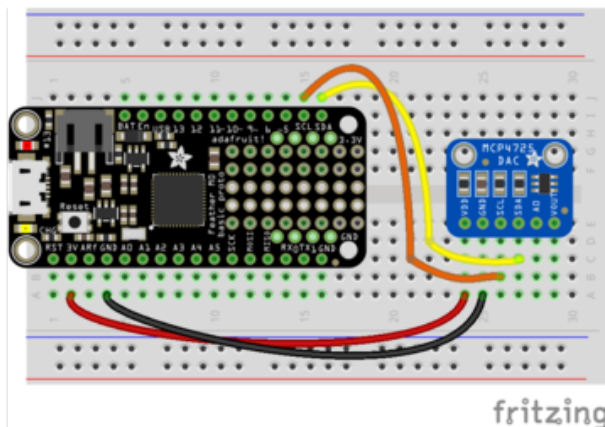

- Board 3V to sensor VIN
- Board GND to sensor GND
- Board SCL to sensor SCL
- Board SDA to sensor SDA

## Python Computer Wiring

Since there's dozens of Linux computers/boards you can use we will show wiring for Raspberry Pi. For other platforms, [please visit the guide for CircuitPython on Linux to see whether your platform is supported \(https://adafru.it/BSN\)](https://adafru.it/BSN).

Here's the Raspberry Pi wired with I2C:

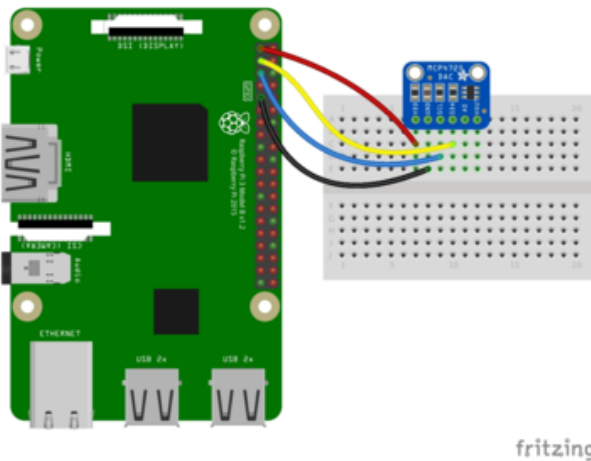

- Pi 3V3 to sensor VIN
- Pi GND to sensor GND
- Pi SCL to sensor SCK
- Pi SDA to sensor SDA

## CircuitPython Installation of MCP4725 Library

Next you'll need to install the [Adafruit CircuitPython MCP4725 \(https://adafru.it/C3P\)](https://adafru.it/C3P) library on your CircuitPython board. Make sure you are running the [latest version of Adafruit CircuitPython \(https://adafru.it/tBa\)](https://adafru.it/tBa) for your board before starting..

You'll need to install the necessary libraries to use the hardware--carefully follow the steps to find and install these libraries from [Adafruit's CircuitPython library bundle \(https://adafru.it/zdx\)](https://adafru.it/zdx). For example the Circuit Playground Express guide has [a great page on how to install the library bundle \(https://adafru.it/Bf2\)](https://adafru.it/Bf2) for both express and non-express boards.

Remember for non-express boards like the Trinket M0, Gemma M0, and Feather/Metro M0 basic you'll need to manually install the necessary libraries from the bundle:

- adafruit\_mcp4725.mpy

You can also download the adafruit\_mcp4725.mpy from [its releases page on Github \(https://adafru.it/C3Q\)](https://adafru.it/C3Q).

Before continuing make sure your board's lib folder or root filesystem has the adafruit\_mcp4725.mpy file copied over.

Next [connect to the board's serial REPL \(https://adafru.it/pMf\)](https://adafru.it/pMf) so you are at the CircuitPython >>> prompt.

# Python Installation of MCP4725 Library

You'll need to install the Adafruit\_Blinka library that provides the CircuitPython support in Python. This may also require enabling I2C on your platform and verifying you are running Python 3. [Since each platform is a little different, and Linux changes often, please visit the CircuitPython on Linux guide to get your computer ready \(https://adafru.it/BSN\)](https://adafru.it/BSN)!

Once that's done, from your command line run the following command:

- `sudo pip3 install adafruit-circuitpython-mcp4725`

If your default Python is version 3 you may need to run 'pip' instead. Just make sure you aren't trying to use CircuitPython on Python 2.x, it isn't supported!

## CircuitPython & Python Usage

To demonstrate the usage of the DAC we'll initialize it and set the output voltage from the board's Python REPL. Run the following code to import the necessary modules and initialize the I2C connection with the sensor:

```
import board
import busio
import adafruit_mcp4725
i2c = busio.I2C(board.SCL, board.SDA)
dac = adafruit_mcp4725.MCP4725(i2c)
```

Now you can set the output voltage just like controlling a DAC with CircuitPython's built-in AnalogOut class and the value property. Simply set this to any 16-bit value (0-65535) and the output of the Vout pin will change to a voltage proportional to 0-3.3V. For example to set the output to 1.65V or about halfway within its range:

```
dac.value = 32767
```



Hook up a multimeter to the Vout pin of the board (positive/red lead to Vout, ground/black lead to board GND) and you should see about 1.65 volts DC output. Try setting `dac.value` to other numbers like 0 or 65535 to see how the voltage changes.

Hook up a multimeter to the Vout pin of the board (positive/red lead to Vout, ground/black lead to board GND) and you should see about 1.65 volts DC output. Try setting `dac.value` to other numbers like 0 or 65535 to see how the voltage changes.

You can use the MCP4725 instance anywhere you might use the AnalogOut class!

However you might prefer a few other simpler properties to change the output voltage:

- `normalized_value` - Set this to a floating point number between 0 and 1.0. A value of 0 is ground/0V and 1.0 is Vdd or max voltage/3.3V. Anything in-between is a proportional voltage. This is handy for scaling the output value without having to worry about how many bits of resolution it has.
- `raw_value` - Set this to a 12-bit value 0-4095 to control the raw 12-bit output of the DAC. Unlike the value property this `raw_value` exposes the true 12-bit resolution of the DAC and is free from quantization errors. If you need the most precise output use the `raw_output` value for setting voltage.

```
dac.normalized_value = 0.5 # ~1.65V output
dac.raw_output = 2047 # Also ~1.65V output
```

That's all there is to using the MCP4725 DAC with CircuitPython!

Below is a complete example that shows changing the DAC voltage to a triangle wave that goes up and down repeatedly. Save this as `code.py` on your board and connect a multimeter to measure the Vout pin voltage to see it oscillate up and down from 0 to 3.3V and back.

# Full Example Code

```
# SPDX-FileCopyrightText: 2018 Tony DiCola for Adafruit Industries
# SPDX-License-Identifier: MIT

# Simple demo of setting the DAC value up and down through its entire range
# of values.
import board
import busio

import adafruit_mcp4725

# Initialize I2C bus.
i2c = busio.I2C(board.SCL, board.SDA)

# Initialize MCP4725.
dac = adafruit_mcp4725.MCP4725(i2c)
# Optionally you can specify a different address if you override the A0 pin.
# amp = adafruit_max9744.MAX9744(i2c, address=0x63)

# There are a three ways to set the DAC output, you can use any of these:
dac.value = 65535 # Use the value property with a 16-bit number just like
# the AnalogOut class. Note the MCP4725 is only a 12-bit
# DAC so quantization errors will occur. The range of
# values is 0 (minimum/ground) to 65535 (maximum/Vout).

dac.raw_value = 4095 # Use the raw_value property to directly read and write
# the 12-bit DAC value. The range of values is
# 0 (minimum/ground) to 4095 (maximum/Vout).

dac.normalized_value = 1.0 # Use the normalized_value property to set the
# output with a floating point value in the range
# 0 to 1.0 where 0 is minimum/ground and 1.0 is
# maximum/Vout.

# Main loop will go up and down through the range of DAC values forever.
while True:
    # Go up the 12-bit raw range.
    print("Going up 0-3.3V...")
    for i in range(4095):
        dac.raw_value = i
    # Go back down the 12-bit raw range.
    print("Going down 3.3-0V...")
    for i in range(4095, -1, -1):
        dac.raw_value = i
```

---

## Python Docs

[Python Docs \(https://adafru.it/C3S\)](https://adafru.it/C3S)

---

# Download

## Files

- [For more details about the chip, please check out the MCP4725 datasheet \(http://adafru.it/aRW\)](http://adafru.it/aRW)
- [MCP4725 Arduino Library is on GitHub \(https://adafru.it/aPz\)](https://adafru.it/aPz)
- [Fritzing object in the Adafruit Fritzing library \(https://adafru.it/aP3\)](https://adafru.it/aP3)
- [EagleCAD PCB files on GitHub \(https://adafru.it/rMC\)](https://adafru.it/rMC)

## Schematic & Fabrication Print

