

Hall Effect Linear Current Sensor with Overcurrent Fault Output for <100 V Isolation Applications

Features and Benefits

- No external sense resistor required; single package solution
- 1.2 mΩ internal conductor resistance; reduced power loss
- Economical low- and high-side current sensing
- Output voltage proportional to AC or DC currents
- ±12.5 A and ±25 A full scale sensing ranges
- Overcurrent FAULT trips and latches at 100% of full-scale current
- Low-noise analog signal path
- 100 kHz bandwidth
- Small footprint, low-profile SOIC8 package
- 3.0 to 5.5 V, single supply operation
- Integrated electrostatic shield for output stability
- Factory-trimmed for accuracy
- Extremely stable output offset voltage
- Zero magnetic hysteresis
- Ratiometric output from supply voltage

Package: 8 Lead SOIC (suffix LC)

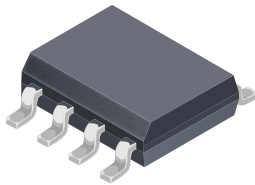

Approximate Scale 1:1



Description

The Allegro® ACS711 provides economical and precise solutions for AC or DC current sensing in <100 V audio, communications systems, white goods, and automotive applications. The device package allows for easy implementation by the customer. Typical applications include circuit protection, current monitoring, and motor and inverter control.

The device consists of a linear Hall sensor circuit with a copper conduction path located near the surface of the die. Applied current flowing through this copper conduction path generates a magnetic field which is sensed by the integrated Hall IC and converted into a proportional voltage. Device accuracy is optimized through the close proximity of the magnetic signal to the Hall transducer.

The output of the device has a positive slope proportional to the current flow from IP+ to IP- (pins 1 and 2, to pins 3 and 4). The internal resistance of this conductive path is 1.2 mΩ typical, providing a non-intrusive measurement interface that saves power in applications that require energy efficiency.

The ACS711 is optimized for low-side current sensing applications, although the terminals of the conductive path are electrically isolated from the sensor leads (pins 5 through 8), providing sufficient internal creepage and clearance dimensions for a low AC or DC working voltage applications. The thickness

Continued on the next page...

Typical Application

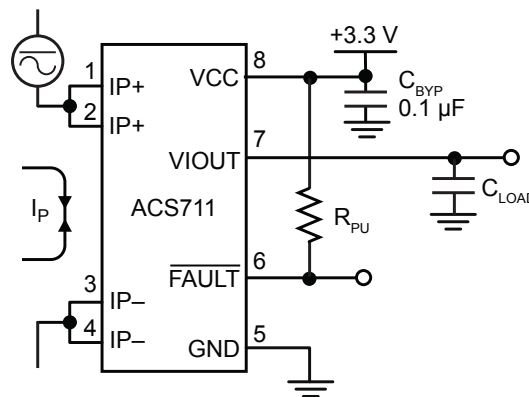

Application 1. The ACS711 outputs an analog signal, V_{IOUT} , that varies linearly with the bi-directional AC or DC primary current, I_P , within the range specified. The FAULT pin trips when I_P reaches ±100% of its full-scale current.

ACS711

Hall Effect Linear Current Sensor with Overcurrent Fault Output for < 100 V Isolation Applications

Description (continued)

of the copper conductor allows survival of the device at up to 5× overcurrent conditions.

The ACS711 is provided in a small, surface mount SOIC8 package. The leadframe is plated with 100% matte tin, which is compatible with standard lead (Pb) free printed circuit board assembly processes.

Internally, the device is Pb-free, except for flip-chip high-temperature Pb-based solder balls, currently exempt from RoHS. The device is fully calibrated prior to shipment from the factory.

Selection Guide

Part Number	Packing ¹	T _A (°C)	Optimized Accuracy Range, I _P (A)	Sensitivity, Sens (Typ) (mV/A)
ACS711ELCTR-12AB-T ²	Tape and reel, 3000 pieces/reel	-40 to 85	±12.5	110
ACS711ELCTR-25AB-T ²	Tape and reel, 3000 pieces/reel	-40 to 85	±25	55
ACS711KLCTR-12AB-T ²	Tape and reel, 3000 pieces/reel	-40 to 125	±12.5	110
ACS711KLCTR-25AB-T ²	Tape and reel, 3000 pieces/reel	-40 to 125	±25	55

¹Contact Allegro for additional packing options.

²Sensitivity measured with V_{CC} = 3.3 V.

Absolute Maximum Ratings

Characteristic	Symbol	Notes	Rating	Units
Supply Voltage	V _{CC}		7	V
Reverse Supply Voltage	V _{RCC}		-0.1	V
Output Voltage	V _{IOUT}		7	V
Reverse Output Voltage	V _{RIOUT}		-0.1	V
Working Voltage for Basic Isolation	V _{WORKING}	Voltage applied between pins 1-4 and 5-8	100	VAC peak or VDC
FAULT Pin Voltage	V _{FAULT}		7	V
Overcurrent Transient Tolerance	I _{POC}	1 pulse, 100 ms	100	A
Nominal Operating Ambient Temperature	T _A	Range E	-40 to 85	°C
		Range K	-40 to 125	°C
Maximum Junction Temperature	T _{J(max)}		165	°C
Storage Temperature	T _{stg}		-65 to 170	°C

Thermal Characteristics

Characteristic	Symbol	Test Conditions ¹	Value	Units
Package Thermal Resistance, Junction to Lead	R _{θJL}	Mounted on Allegro ASEK 711 evaluation board	5	°C/W
Package Thermal Resistance, Junction to Ambient ²	R _{θJA}	Mounted on Allegro 85-0404 evaluation board, includes the power consumed by the board	23	°C/W

¹Additional thermal information available on the Allegro website

²The Allegro evaluation board has 1500 mm² of 2 oz. copper on each side, connected to pins 1 and 2, and to pins 3 and 4, with thermal vias connecting the layers. Performance values include the power consumed by the PCB. Further details on the board are available from the Frequently Asked Questions document on our website.



Functional Block Diagram

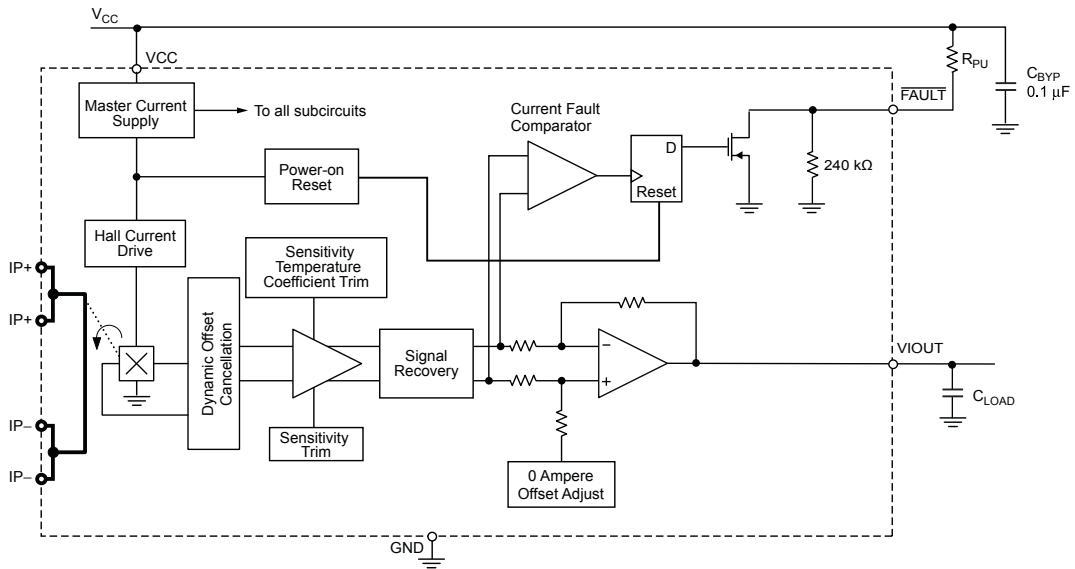

Pin-out Diagram

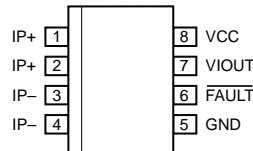

Terminal List Table

Number	Name	Description
1 and 2	IP+	Terminals for current being sensed; fused internally
3 and 4	IP-	Terminals for current being sensed; fused internally
5	GND	Signal ground terminal
6	$\overline{\text{FAULT}}$	Overcurrent fault; active low
7	VIOUT	Analog output signal
8	VCC	Device power supply terminal

COMMON OPERATING CHARACTERISTICS over full range of T_A and $V_{CC} = 3.3$ V, unless otherwise specified

Characteristic	Symbol	Test Conditions	Min.	Typ.	Max.	Units
ELECTRICAL CHARACTERISTICS						
Supply Voltage ¹	V_{CC}		3	3.3	5.5	V
Supply Current	I_{CC}	$V_{CC} = 3.3$ V, output open	–	4	5.5	mA
Output Capacitance Load	C_{LOAD}	VIOUT to GND	–	–	1	nF
Output Resistive Load	R_{LOAD}	VIOUT to GND	15	–	–	k Ω
Primary Conductor Resistance	R_{IP}	$T_A = 25^\circ\text{C}$	–	1.2	–	m Ω
VIOUT Rise Time	t_r	$I_P = I_{P\text{MAX}}$, $T_A = 25^\circ\text{C}$, $C_{OUT} = \text{open}$	–	3.5	–	μs
Propagation Delay Time	t_{PROP}	$I_P = I_P(\text{max})$, $T_A = 25^\circ\text{C}$, $C_{OUT} = \text{open}$	–	1.2	–	μs
Response Time	$t_{RESPONSE}$	$I_P = I_P(\text{max})$, $T_A = 25^\circ\text{C}$, $C_{OUT} = \text{open}$	–	4.6	–	μs
Internal Bandwidth ²	BW_I	–3 dB, $T_A = 25^\circ\text{C}$	–	100	–	kHz
Nonlinearity	E_{LIN}	Over full range of I_P	–	± 1	–	%
Symmetry	E_{SYM}	Apply full scale I_P	–	100	–	%
VIOUT Saturation Voltages	V_{IOH}		$V_{CC} - 0.3$	–	–	V
	V_{IOL}		–	–	0.3	V
Quiescent Output Voltage	$V_{IOUT(Q)}$	$I_P = 0$ A, $T_A = 25^\circ\text{C}$	–	$V_{CC} / 2$	–	V
Power-On Time	t_{PO}	Output reaches 90% of steady-state level, $T_A = 25^\circ\text{C}$, 20 A present on primary conductor	–	35	–	μs
FAULT Pin Characteristics						
$\overline{\text{FAULT}}$ Operating Point	I_{FAULT}		–	$\pm 1 \times I_P$	–	A
$\overline{\text{FAULT}}$ Output Pullup Resistor	R_{PU}		1	–	–	k Ω
$\overline{\text{FAULT}}$ Output Voltage	V_{OH}		–	$V_{CC} - 0.3$	–	V
	V_{OL}	$R_{PU} = 1$ k Ω	–	0.3	–	V
$\overline{\text{FAULT}}$ Response Time	t_{FAULT}	Measured from $ I_P > I_{FAULT} $ to $V_{FAULT} \leq V_{OL}$	–	1.3	–	μs
V_{CC} Off Voltage Level for Fault Reset ³	V_{CCFR}		–	–	200	mV
V_{CC} Off Duration for Fault Reset ³	t_{CCFR}		100	–	–	μs

¹Devices are programmed for maximum accuracy at 3.3 V V_{CC} levels. The device contains ratiometry circuits that accurately alter the 0 A Output Voltage and Sensitivity level of the device in proportion to the applied V_{CC} level. However, as a result of minor nonlinearities in the ratiometry circuit additional output error will result when V_{CC} varies from the 3.3 V V_{CC} level. Customers that plan to operate the device from a 5 V regulated supply should contact their local Allegro sales representative regarding expected device accuracy levels under these bias conditions.

²Calculated using the formula $BW_I = 0.35 / t_r$.

³After the $\overline{\text{FAULT}}$ pin is latched low, the only way to reset it is through a power-off and power-on cycle on the V_{CC} pin. To get a guaranteed fault reset, V_{CC} must stay below V_{CCFR} for a period greater than t_{CCFR} before settling to the normal operation voltage (3 to 5.5 V).

x12.5A PERFORMANCE CHARACTERISTICS for E TEMPERATURE RANGE $T_A = 25^\circ\text{C}$ and $V_{CC} = 3.3\text{ V}$, unless otherwise specified

Characteristic	Symbol	Test Conditions	Min.	Typ.	Max.	Units
Optimized Accuracy Range	I_P		-12.5	-	12.5	A
Sensitivity	Sens	Over full range of I_P	-	110	-	mV/A
		Full scale of I_P applied for 5 ms, $T_A = -40^\circ\text{C}$ to 25°C	-	110	-	mV/A
		Full scale of I_P applied for 5 ms, $T_A = 25^\circ\text{C}$ to 85°C	-	110	-	mV/A
Noise ²	V_{NOISE}	$T_A = 25^\circ\text{C}$, no external low pass filter on VIOUT	-	11	-	mV
Electrical Offset Voltage	$V_{\text{OE(TA)}}$	$I_P = 0\text{ A}$, $T_A = 25^\circ\text{C}$	-	± 5	-	mV
	$V_{\text{OE(TOP)HT}}$	$I_P = 0\text{ A}$, $T_A = 25^\circ\text{C}$ to 85°C	-	± 40	-	mV
	$V_{\text{OE(TOP)LT}}$	$I_P = 0\text{ A}$, $T_A = -40^\circ\text{C}$ to 25°C	-	± 50	-	mV
Total Output Error ³	E_{TOT}	$I_P = \pm 12.5\text{ A}$, $T_A = -40^\circ\text{C}$ to 85°C	-	± 5	-	%

¹See Characteristic Performance Data for parameter distributions over temperature.

² ± 3 sigma noise voltage.

³Percentage of I_P , with $I_P = \pm 12.5\text{ A}$.

x12.5A PERFORMANCE CHARACTERISTICS for K TEMPERATURE RANGE¹ $T_A = 25^\circ\text{C}$ and $V_{CC} = 3.3\text{ V}$, unless otherwise specified

Characteristic	Symbol	Test Conditions	Min.	Typ.	Max.	Units
Optimized Accuracy Range	I_P		-12.5	-	12.5	A
Sensitivity	Sens	Over full range of I_P	-	110	-	mV/A
		Full scale of I_P applied for 5 ms, $T_A = -40^\circ\text{C}$ to 25°C	-	110	-	mV/A
		Full scale of I_P applied for 5 ms, $T_A = 25^\circ\text{C}$ to 125°C	-	110	-	mV/A
Noise ²	V_{NOISE}	$T_A = 25^\circ\text{C}$, no external low pass filter on VIOUT	-	11	-	mV
Electrical Offset Voltage	$V_{\text{OE(TA)}}$	$I_P = 0\text{ A}$, $T_A = 25^\circ\text{C}$	-	± 5	-	mV
	$V_{\text{OE(TOP)HT}}$	$I_P = 0\text{ A}$, $T_A = 25^\circ\text{C}$ to 125°C	-	± 40	-	mV
	$V_{\text{OE(TOP)LT}}$	$I_P = 0\text{ A}$, $T_A = -40^\circ\text{C}$ to 25°C	-	± 50	-	mV
Total Output Error ³	E_{TOT}	$I_P = \pm 12.5\text{ A}$, $T_A = -40^\circ\text{C}$ to 125°C	-	± 5	-	%

¹See Characteristic Performance Data for parameter distributions over temperature.

² ± 3 sigma noise voltage.

³Percentage of I_P , with $I_P = \pm 12.5\text{ A}$.

x25A PERFORMANCE CHARACTERISTICS for E TEMPERATURE RANGE $T_A = 25^\circ\text{C}$ and $V_{CC} = 3.3\text{ V}$, unless otherwise specified

Characteristic	Symbol	Test Conditions	Min.	Typ.	Max.	Units
Optimized Accuracy Range	I_P		-25	-	25	A
Sensitivity	Sens	Over full range of I_P	-	55	-	mV/A
		Full scale of I_P applied for 5 ms, $T_A = -40^\circ\text{C}$ to 25°C	-	55	-	mV/A
		Full scale of I_P applied for 5 ms, $T_A = 25^\circ\text{C}$ to 85°C	-	55	-	mV/A
Noise ²	V_{NOISE}	$T_A = 25^\circ\text{C}$, no external low pass filter on VIOUT	-	8	-	mV
Electrical Offset Voltage	$V_{OE(TA)}$	$I_P = 0\text{ A}$, $T_A = 25^\circ\text{C}$	-	± 5	-	mV
	$V_{OE(TOP)HT}$	$I_P = 0\text{ A}$, $T_A = 25^\circ\text{C}$ to 85°C	-	± 30	-	mV
	$V_{OE(TOP)LT}$	$I_P = 0\text{ A}$, $T_A = -40^\circ\text{C}$ to 25°C	-	± 35	-	mV
Total Output Error ³	E_{TOT}	$I_P = \pm 25\text{ A}$, $T_A = -40^\circ\text{C}$ to 85°C	-	± 4	-	%

¹See Characteristic Performance Data for parameter distributions over temperature.

² ± 3 sigma noise voltage.

³Percentage of I_P , with $I_P = \pm 25\text{ A}$.

x25A PERFORMANCE CHARACTERISTICS for K TEMPERATURE RANGE¹ $T_A = 25^\circ\text{C}$ and $V_{CC} = 3.3\text{ V}$, unless otherwise specified

Characteristic	Symbol	Test Conditions	Min.	Typ.	Max.	Units
Optimized Accuracy Range	I_P		-25	-	25	A
Sensitivity	Sens	Over full range of I_P	-	55	-	mV/A
		Full scale of I_P applied for 5 ms, $T_A = -40^\circ\text{C}$ to 25°C	-	55	-	mV/A
		Full scale of I_P applied for 5 ms, $T_A = 25^\circ\text{C}$ to 125°C	-	55	-	mV/A
Noise ²	V_{NOISE}	$T_A = 25^\circ\text{C}$, no external low pass filter on VIOUT	-	8	-	mV
Electrical Offset Voltage	$V_{OE(TA)}$	$I_P = 0\text{ A}$, $T_A = 25^\circ\text{C}$	-	± 5	-	mV
	$V_{OE(TOP)HT}$	$I_P = 0\text{ A}$, $T_A = 25^\circ\text{C}$ to 125°C	-	± 30	-	mV
	$V_{OE(TOP)LT}$	$I_P = 0\text{ A}$, $T_A = -40^\circ\text{C}$ to 25°C	-	± 35	-	mV
Total Output Error ³	E_{TOT}	$I_P = \pm 25\text{ A}$, $T_A = -40^\circ\text{C}$ to 125°C	-	± 4	-	%

¹See Characteristic Performance Data for parameter distributions over temperature.

² ± 3 sigma noise voltage.

³Percentage of I_P , with $I_P = \pm 25\text{ A}$.

Characteristic Performance Data

Data taken using the ACS711KLC-12A, $V_{CC} = 3.3\text{ V}$

Accuracy Data

Electrical Offset Voltage versus Ambient Temperature

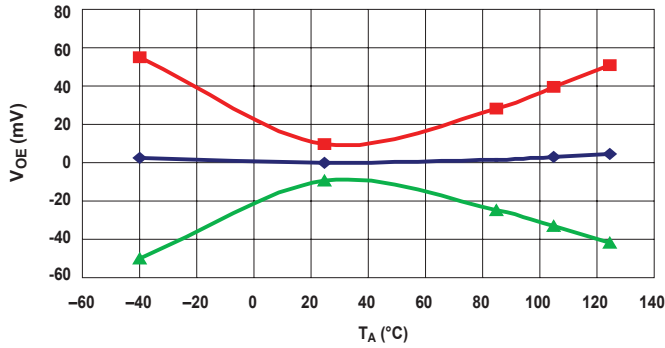

Sensitivity versus Ambient Temperature

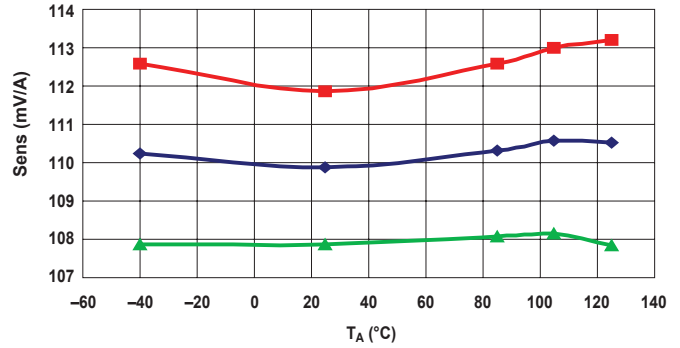

Nonlinearity versus Ambient Temperature

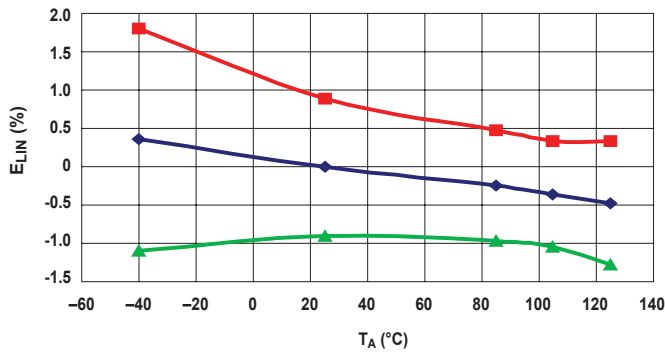

Symmetry versus Ambient Temperature

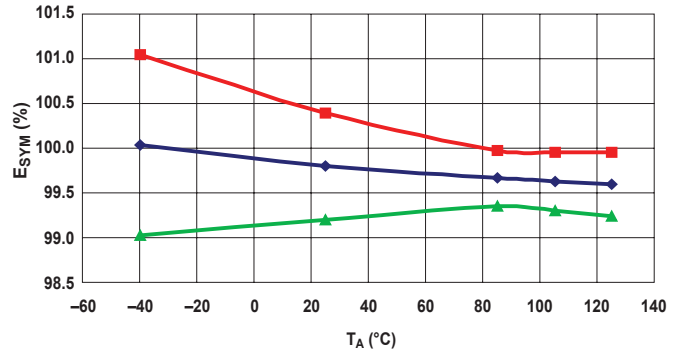

Total Output Error versus Ambient Temperature

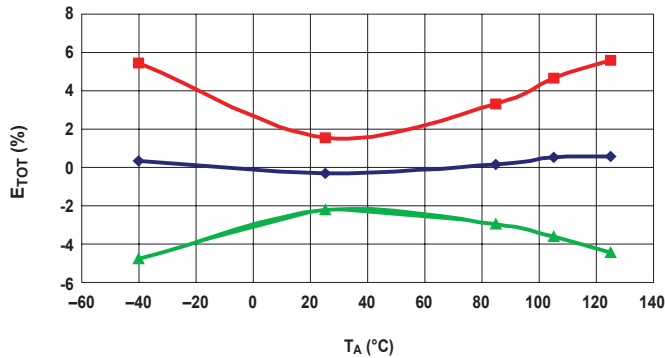

Fault Operating Point versus Ambient Temperature

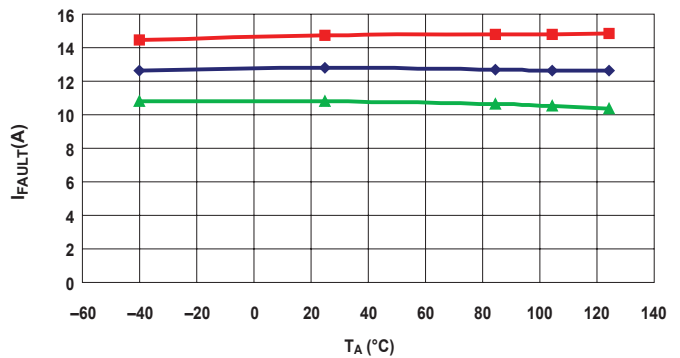

—■— Typical Maximum Limit —◆— Mean —▲— Typical Minimum Limit

Characteristic Performance Data Data taken using the ACS711KLC-25A, $V_{CC} = 3.3\text{ V}$

Accuracy Data

Electrical Offset Voltage versus Ambient Temperature

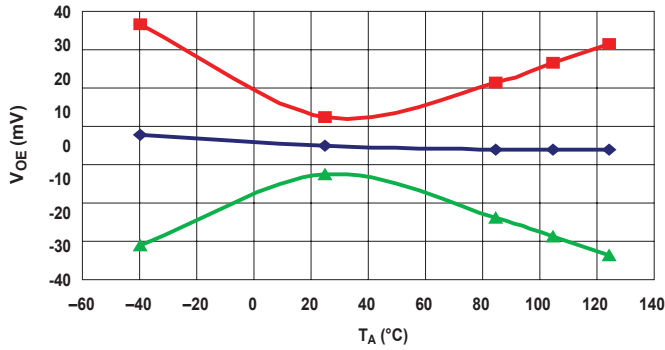

Sensitivity versus Ambient Temperature

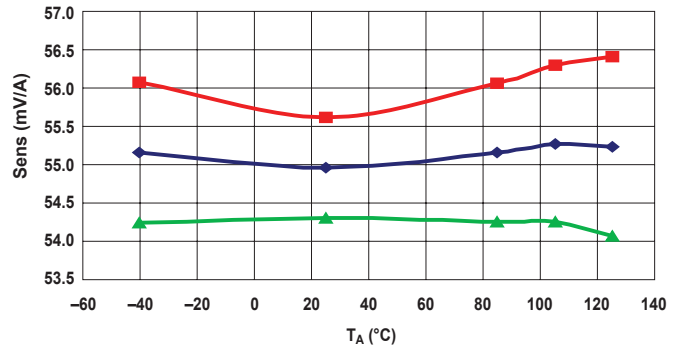

Nonlinearity versus Ambient Temperature

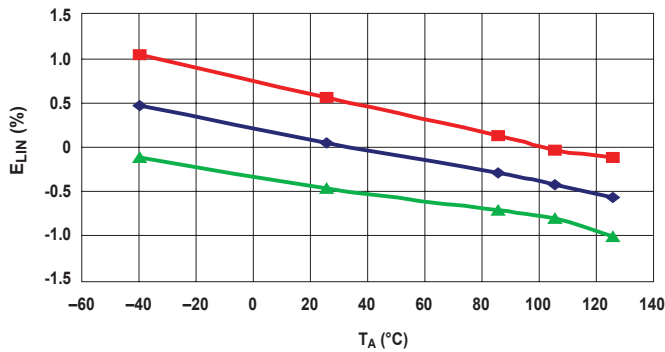

Symmetry versus Ambient Temperature

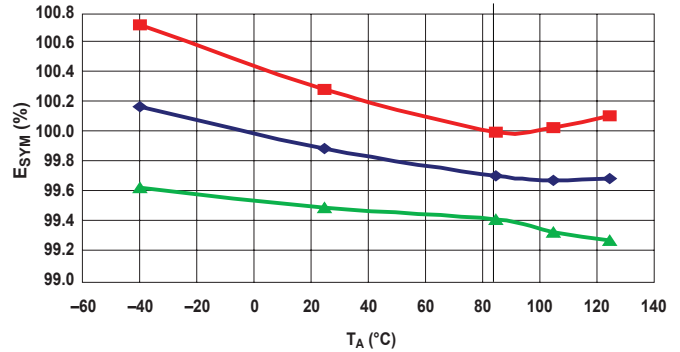

Total Output Error versus Ambient Temperature

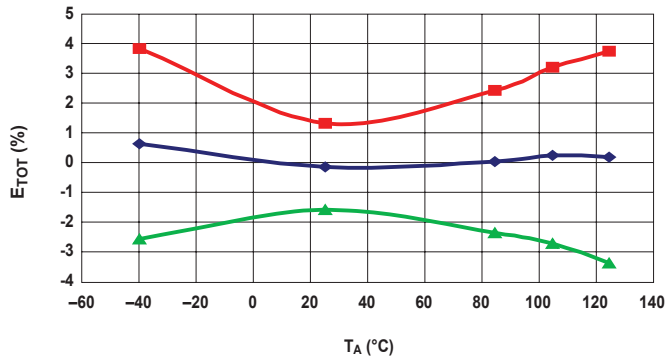

Fault Operating Point versus Ambient Temperature

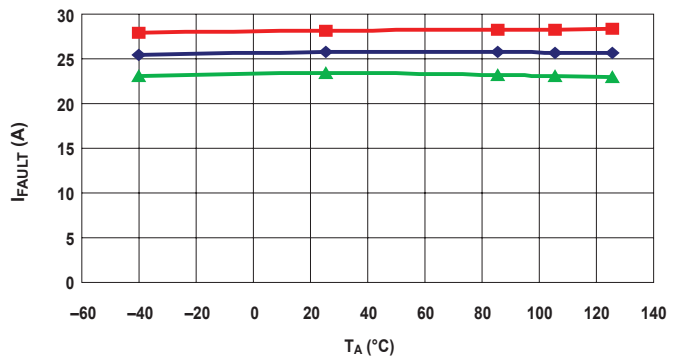

—■— Typical Maximum Limit —◆— Mean —▲— Typical Minimum Limit

Characteristic Performance Data

Data taken using the ACS711KLC-25A

Timing Data

Rise Time

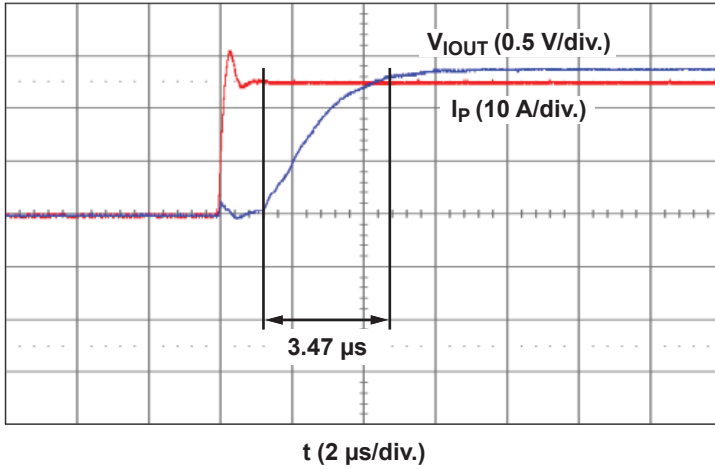

Propagation Delay Time

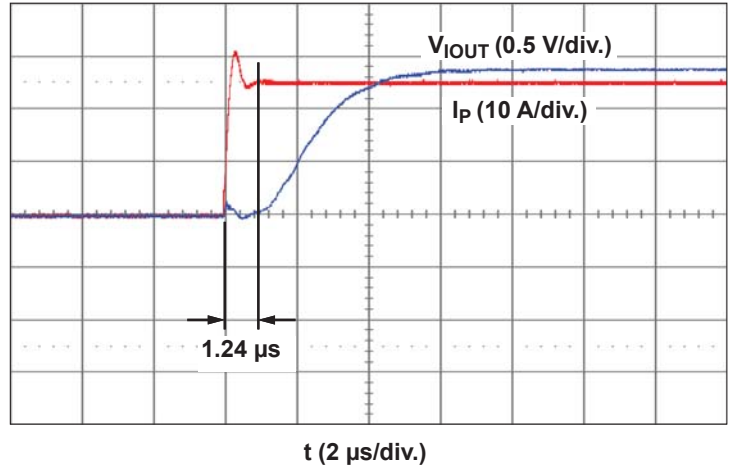

Response Time

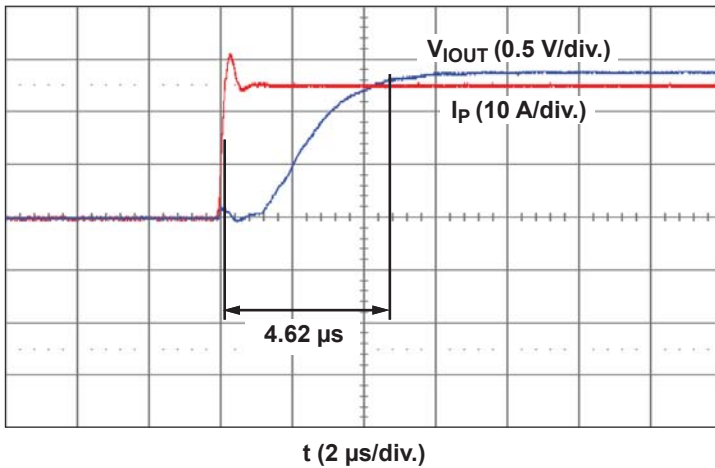

Fault Response

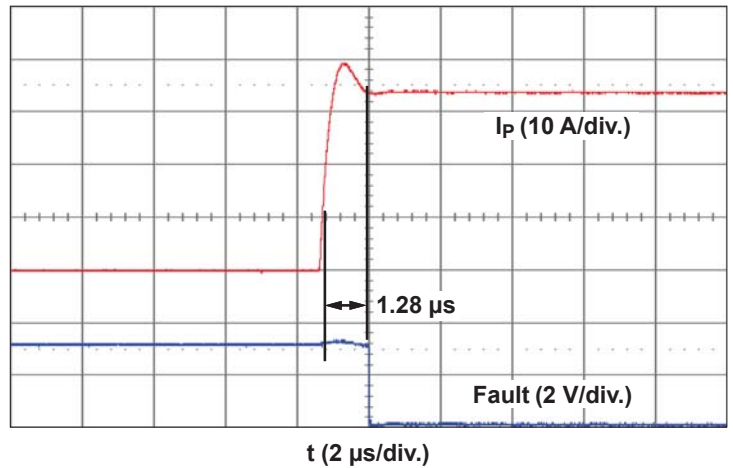

Definitions of Accuracy Characteristics

Sensitivity (Sens). The change in sensor output in response to a 1 A change through the primary conductor. The sensitivity is the product of the magnetic circuit sensitivity (G/A) and the linear IC amplifier gain (mV/G). The linear IC amplifier gain is programmed at the factory to optimize the sensitivity (mV/A) for the full-scale current of the device.

Noise (V_{NOISE}). The product of the linear IC amplifier gain (mV) and the noise floor for the Allegro Hall effect linear IC. The noise floor is derived from the thermal and shot noise observed in Hall elements. Dividing the noise (mV) by the sensitivity (mV/A) provides the smallest current that the device is able to resolve.

Linearity (E_{LIN}). The degree to which the voltage output from the sensor varies in direct proportion to the primary current through its full-scale amplitude. Nonlinearity in the output can be attributed to the saturation of the flux concentrator approaching the full-scale current. The following equation is used to derive the linearity:

where $V_{IOUT_full-scale\ amperes}$ = the output voltage (V) when the

$$100 \left\{ 1 - \left[\frac{\Delta\ gain \times \% \ sat (V_{IOUT_full-scale\ amperes} - V_{IOUT(Q)})}{2 (V_{IOUT_half-scale\ amperes} - V_{IOUT(Q)})} \right] \right\}$$

sensed current approximates full-scale $\pm I_p$.

Symmetry (E_{SYM}). The degree to which the absolute voltage output from the sensor varies in proportion to either a positive or negative full-scale primary current. The following formula is used to derive symmetry:

$$100 \left(\frac{V_{IOUT_+ \ full-scale\ amperes} - V_{IOUT(Q)}}{V_{IOUT(Q)} - V_{IOUT_ - \ full-scale\ amperes}} \right)$$

Quiescent output voltage (V_{IOUT(Q)}). The output of the sensor when the primary current is zero. For a unipolar supply voltage, it nominally remains at $V_{CC}/2$. Thus, $V_{CC} = 3.3\ V$ translates into $V_{IOUT(Q)} = 1.65\ V$. Variation in $V_{IOUT(Q)}$ can be attributed to the resolution of the Allegro linear IC quiescent voltage trim and thermal drift.

Electrical offset voltage (V_{OE}). The deviation of the device output from its ideal quiescent value of $V_{CC}/2$ due to nonmagnetic causes. To convert this voltage to amperes, divide by the device sensitivity, Sens.

Accuracy (E_{TOT}). The accuracy represents the maximum deviation of the actual output from its ideal value. This is also known as the total output error. The accuracy is illustrated graphically in the output voltage versus current chart below.

Ratiometry. The ratiometric feature means that its 0 A output, $V_{IOUT(Q)}$, (nominally equal to $V_{CC}/2$) and sensitivity, Sens, are proportional to its supply voltage, V_{CC} . The following formula is used to derive the ratiometric change in 0 A output voltage, $\Delta V_{IOUT(Q)RAT}$ (%).

$$100 \left(\frac{V_{IOUT(Q)VCC} / V_{IOUT(Q)3.3V}}{V_{CC} / 3.3\ V} \right)$$

The ratiometric change in sensitivity, $\Delta Sens_{RAT}$ (%), is defined as:

$$100 \left(\frac{Sens_{VCC} / Sens_{3.3V}}{V_{CC} / 3.3\ V} \right)$$

Output Voltage versus Sensed Current
Accuracy at 0 A and at Full-Scale Current

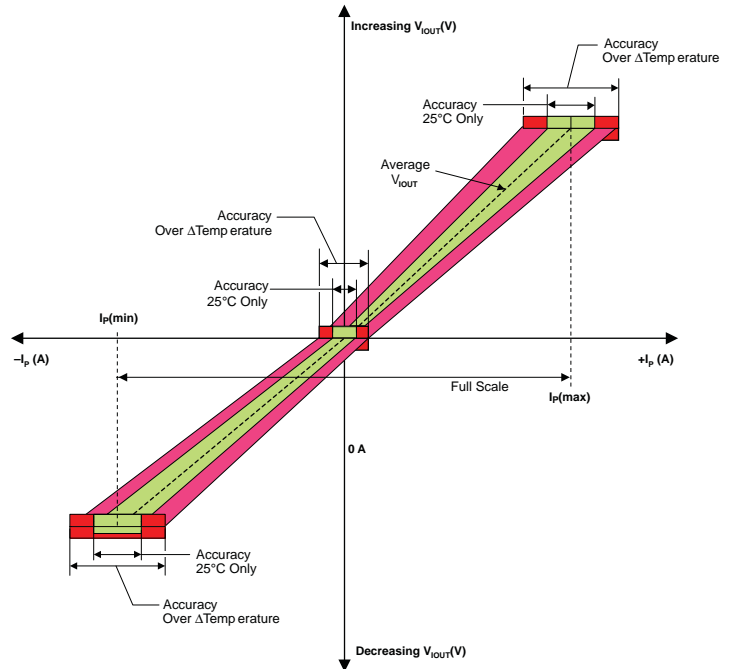

Definitions of Dynamic Response Characteristics

Power-On Time (t_{PO}). When the supply is ramped to its operating voltage, the device requires a finite time to power its internal components before responding to an input magnetic field. Power-On Time, t_{PO} , is defined as the time it takes for the output voltage to settle within $\pm 10\%$ of its steady state value under an applied magnetic field, after the power supply has reached its minimum specified operating voltage, $V_{CC(min)}$, as shown in the chart at right.

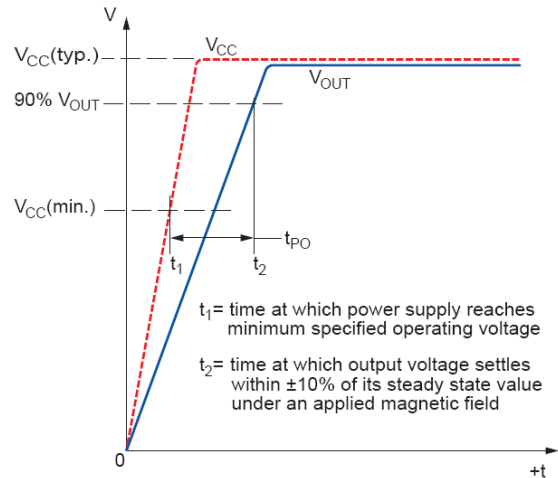

Rise time (t_r). The time interval between a) when the sensor reaches 10% of its full scale value, and b) when it reaches 90% of its full scale value. The rise time to a step response is used to derive the bandwidth of the current sensor, in which $f(-3 \text{ dB}) = 0.35/t_r$. Both t_r and $t_{RESPONSE}$ are detrimentally affected by eddy current losses observed in the conductive IC ground plane.

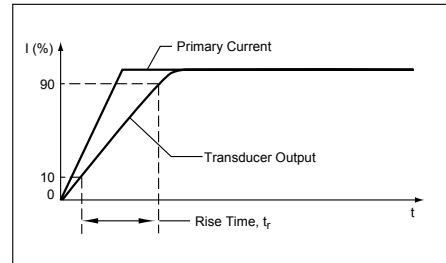

Package LC, 8-pin SOIC

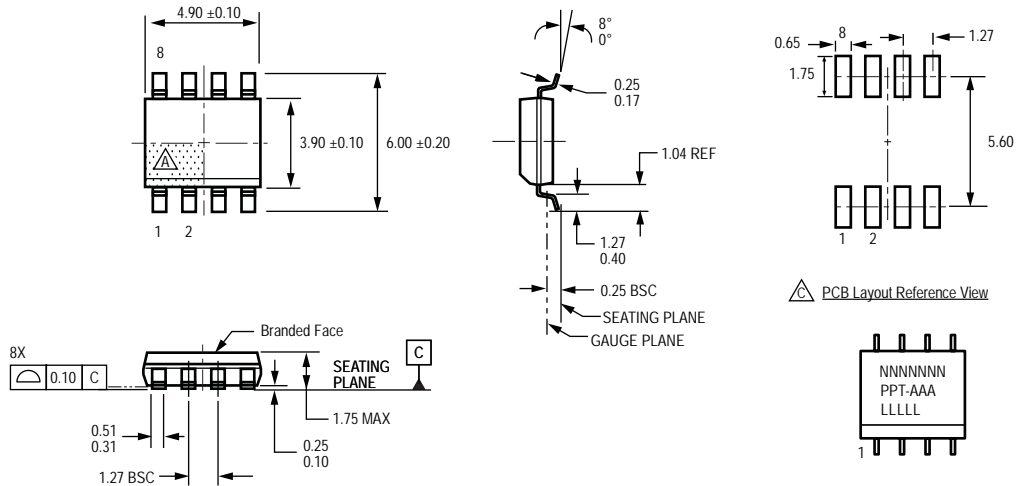

For Reference Only; not for tooling use (reference MS-012AA)
 Dimensions in millimeters
 Dimensions exclusive of mold flash, gate burrs, and dambar protrusions
 Exact case and lead configuration at supplier discretion within limits shown

- Terminal #1 mark area
- Branding scale and appearance at supplier discretion
- Reference land pattern layout (reference IPC7351)
- SOIC127P600X175-8M); all pads a minimum of 0.20 mm from all adjacent pads; adjust as necessary to meet application process requirements and PCB layout tolerances

PCB Layout Reference View

Standard Branding Reference View

N = Device part number
 P = Package Designator
 T = Device temperature range
 A = Amperage
 L = Lot number
 Belly Brand = Country of Origin

Revision History

Revision	Revision Date	Description of Revision
Rev. 1	March 25, 2011	Augment V _{CC} specification

Copyright ©2008-2011, Allegro MicroSystems, Inc.

Allegro MicroSystems, Inc. reserves the right to make, from time to time, such departures from the detail specifications as may be required to permit improvements in the performance, reliability, or manufacturability of its products. Before placing an order, the user is cautioned to verify that the information being relied upon is current.

Allegro's products are not to be used in life support devices or systems, if a failure of an Allegro product can reasonably be expected to cause the failure of that life support device or system, or to affect the safety or effectiveness of that device or system.

The information included herein is believed to be accurate and reliable. However, Allegro MicroSystems, Inc. assumes no responsibility for its use; nor for any infringement of patents or other rights of third parties which may result from its use.

For the latest version of this document, visit our website:

www.allegromicro.com

