

DS3231MPMB1 Peripheral Module

General Description

The DS3231MPMB1 peripheral module provides the necessary hardware to interface the DS3231M real-time clock (RTC) to any system that utilizes Pmod™-compatible expansion ports configurable for I²C communication. The IC is a low-cost and extremely accurate I²C RTC. The device incorporates a battery input and maintains accurate timekeeping when main power to the device is interrupted. The integration of the microelectromechanical systems (MEMS) resonator enhances the long-term accuracy of the device and reduces the piece-part count in a manufacturing line. The device is available in the same footprint as the popular DS3231 RTC.

Refer to the DS3231M IC data sheet for detailed information regarding operation of the IC.

Features

- ◆ High Accuracy Time-of-Day and Date (± 5 ppm) from -40°C to $+85^{\circ}\text{C}$
- ◆ 32.768kHz Square-Wave Output
- ◆ Digital Temp Sensor with $\pm 3^{\circ}\text{C}$ Accuracy
- ◆ 6-Pin Pmod-Compatible Connector (I²C)
- ◆ Example Software Written in C for Portability
- ◆ Secondary Header Allows Daisy-Chaining of Additional Modules on the I²C Bus
- ◆ RoHS Compliant
- ◆ Proven PCB Layout
- ◆ Fully Assembled and Tested

Ordering Information appears at end of data sheet.

DS3231MPMB1 Peripheral Module



Pmod is a trademark of Digilent Inc.

DS3231MPMB1 Peripheral Module

Component List

DESIGNATION	QTY	DESCRIPTION
BAT1	1	Battery holder Memory Protection Devices BH401
C1	1	1 μ F \pm 10%, 10V X7R ceramic capacitor (0603) TDK C1608X7R1A105K
C2	1	0.1 μ F \pm 10%, 10V X74 ceramic capacitor (0603) Murata GRM188R71C104KA01D

DESIGNATION	QTY	DESCRIPTION
J1	1	6-pin right-angle male header
J2	1	8-pin (2 x 4) straight male header
R1–R4	4	150 Ω \pm 5% resistors (0603)
R5–R8	4	4.7k Ω \pm 5% resistors (0603)
U1	1	\pm 5ppm, I ² C real-time clock (8 SO) Maxim MAX3231MZ+
—	1	PCB: EPCB3231PM1

Component Suppliers

SUPPLIER	PHONE	WEBSITE
Murata Electronics North America, Inc.	770-436-1300	www.murata-northamerica.com
TDK Corp.	847-803-6100	www.component.tdk.com

Note: Indicate that you are using the DS3231MPMB1 when contacting these component suppliers.

Detailed Description

I²C Interface

The DS3231MPMB1 peripheral module can interface to the host in one of two ways. It can plug directly into a Pmod-compatible port (configured for I²C) through connector J1, or in this case, other I²C boards can attach to the same I²C bus through connector J2.

I²C Interface (Daisy-Chaining Modules)

Alternatively, the peripheral module can connect to other I²C-based Pmod modules using a 4-conductor ribbon cable connecting to the J2 connector. In this situation, pins 1-4 and 5-8 of J2 provide two connections to the I²C bus, allowing the module to be inserted into an I²C bus daisy-chain.

Connector J1 provides connection of the module to the Pmod host. The pin functions and pin assignments adhere to the Pmod standard recommended by Digilent. See Table 1.

The J2 connector allows the module to be connected through a daisy-chain from another I²C module and/or provide I²C and power connections to other I²C modules on the same bus. See Table 2.

Battery Backup

The peripheral module contains a battery holder for a lithium coin cell battery. The battery allows the IC to retain settings and time in the event of main power loss.

Note: A battery **MUST** be present for the DS3231MPMB1 to operate properly.

Table 1. Connector J1 (I²C Communication)

PIN	SIGNAL	DESCRIPTION
1	$\overline{\text{RST}}$	Active-low reset. This pin is an open-drain input/output. It is pulled low if VCC falls below threshold. This output is combined with a debounced pushbutton input function that can be activated to cause a reset request.
2	$\overline{\text{INT}}/\text{SQW}$	Active-low interrupt or 1Hz square-wave output. Interrupt function is activated when alarm occurs.
3	SCL	I ² C serial clock
4	SDA	I ² C serial data
5	GND	Ground
6	VCC	Power supply

Table 2. Connector J2 (I²C Expansion)

PIN	SIGNAL	DESCRIPTION
1	SCL	I ² C serial clock
2	SDA	I ² C serial data
3	GND	Ground
4	VCC	Power supply
5	SCL	2-wire serial clock (same as pin 1 above)
6	SDA	2-wire serial data (same as pin 2 above)
7	GND	Ground
8	VCC	Power supply

DS3231MPMB1 Peripheral Module

Software and FPGA Code

Example software and drivers are available that execute directly without modification on several FPGA development boards that support an integrated or synthesized microprocessor. These boards include the Digilent Nexys 3, Avnet LX9, and Avnet ZEDBoard, although other platforms can be added over time. Maxim provides complete Xilinx ISE projects containing HDL, Platform Studio, and SDK projects. In addition, a synthesized bit stream, ready for FPGA download, is provided for the demonstration application.

The software project (for the SDK) contains several source files intended to accelerate customer evalu-

ation and design. These include a base application (maximModules.c) that demonstrates module functionality and uses an API interface (maximDeviceSpecificUtilities.c) to set and access Maxim device functions within a specific module.

The source code is written in standard ANSI C format, and all API documentation including theory/operation, register description, and function prototypes are documented in the API interface file (maximDeviceSpecificUtilities.h & .c).

The complete software kit is available for download at www.maxim-ic.com. Quick start instructions are also available as a separate document.

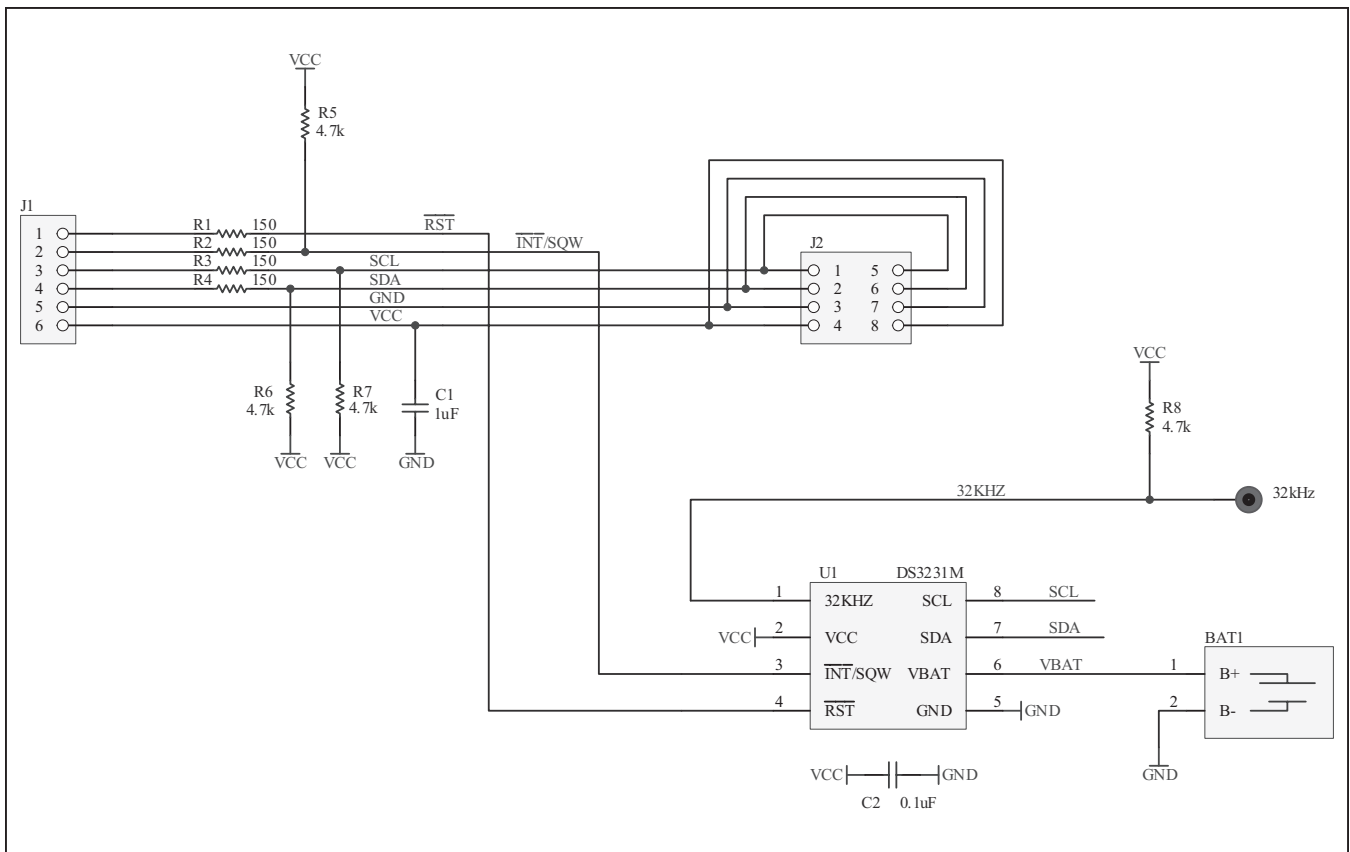

Figure 1. DS3231MPMB1 Peripheral Module Schematic

DS3231MPMB1 Peripheral Module

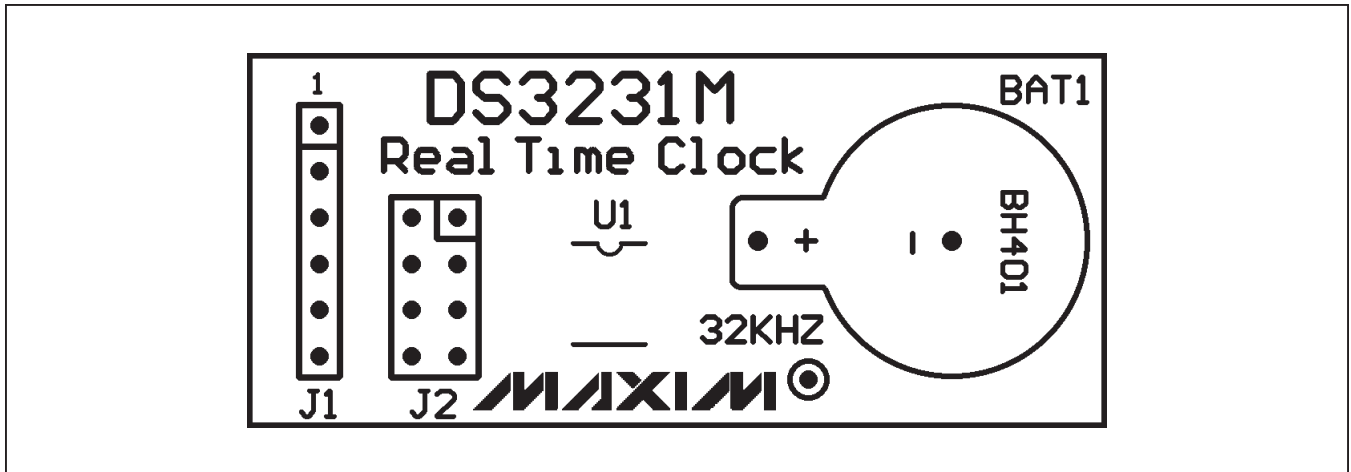

Figure 2. DS3231MPMB1 Peripheral Module Component Placement Guide—Component Side

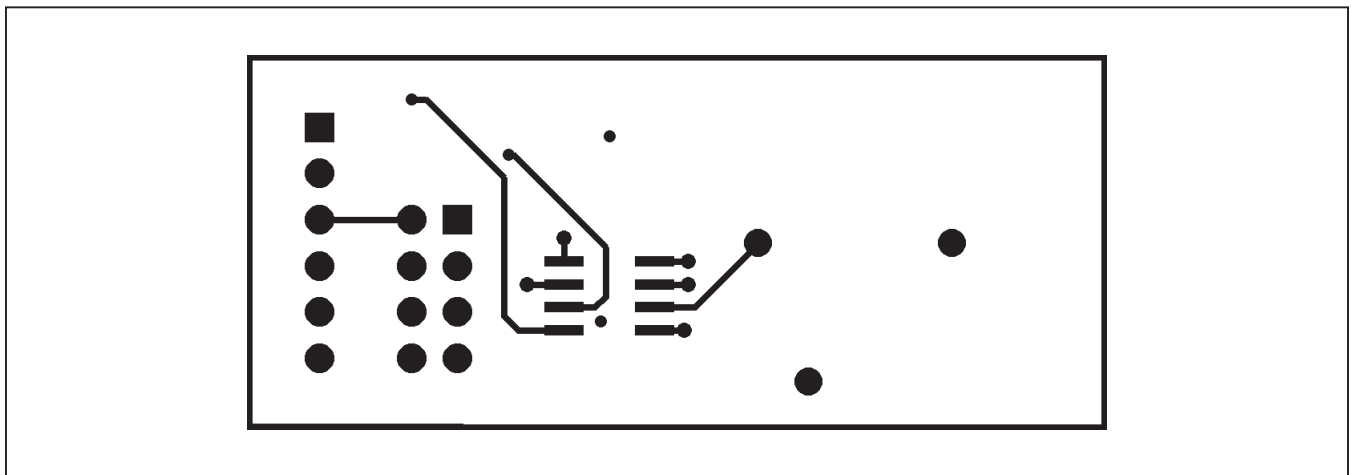

Figure 3. DS3231MPMB1 Peripheral Module PCB Layout—Component Side

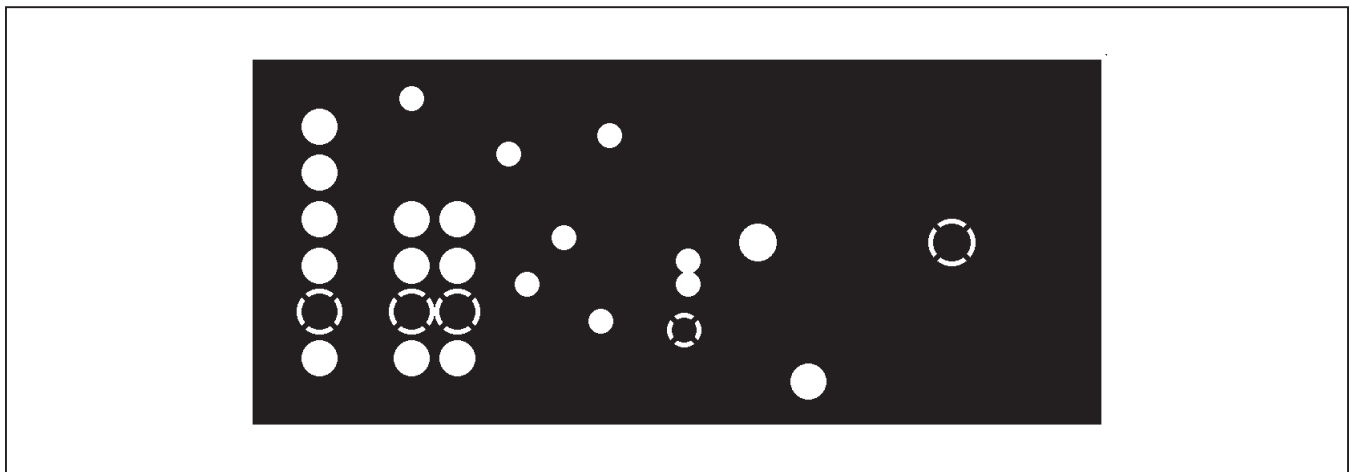

Figure 4. DS3231MPMB1 Peripheral Module PCB Layout—Inner Layer 1 (Power)

DS3231MPMB1 Peripheral Module

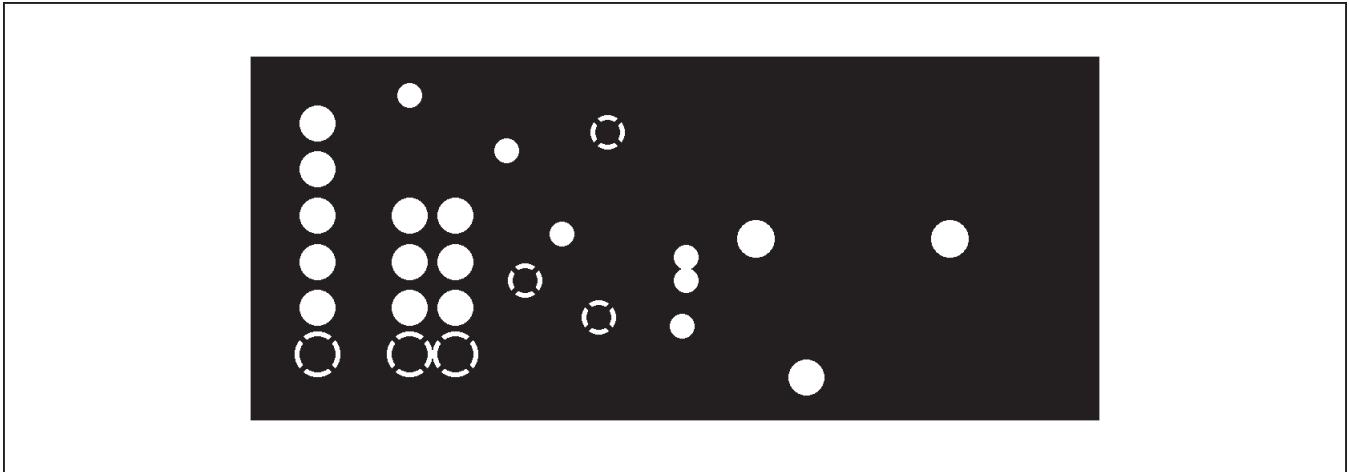

Figure 5. DS3231MPMB1 Peripheral Module PCB Layout—Inner Layer 2 (Ground)

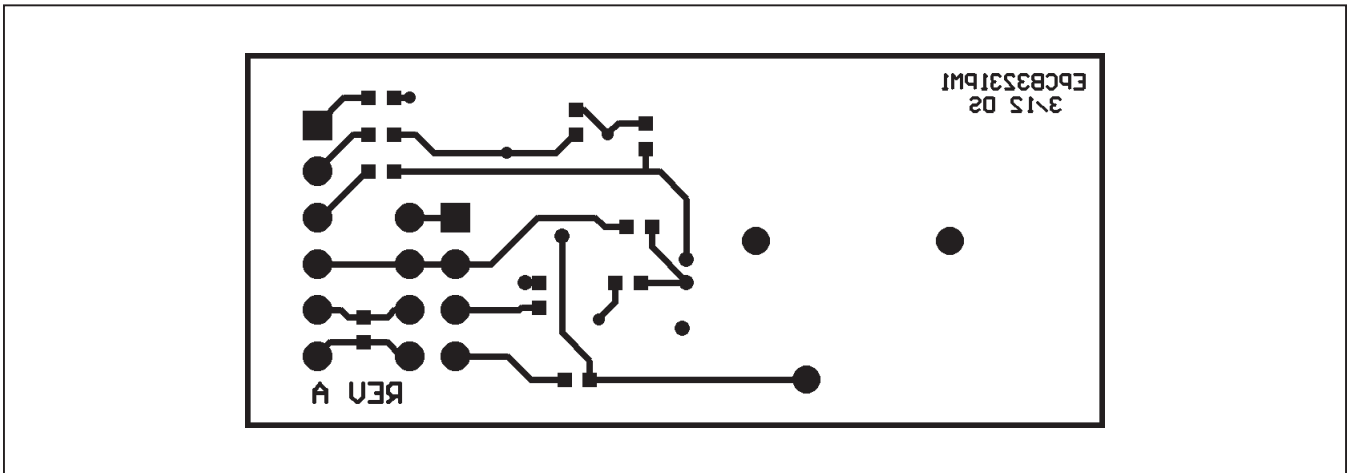

Figure 6. DS3231MPMB1 Peripheral Module PCB Layout—Solder Side

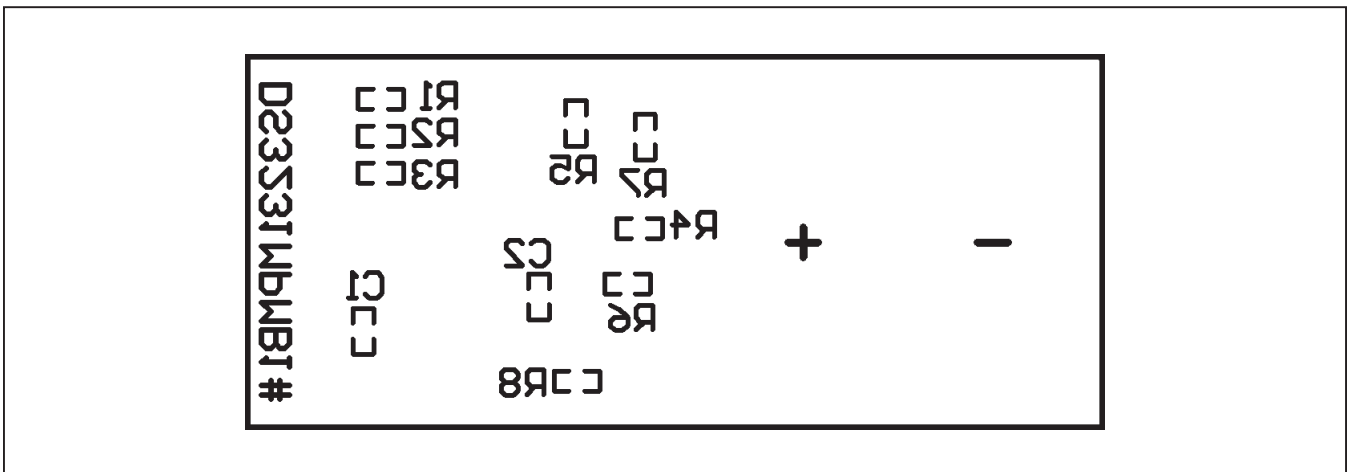

Figure 7. DS3231MPMB1 Peripheral Module Component Placement Guide—Solder Side

DS3231MPMB1 Peripheral Module

Ordering Information

PART	TYPE
DS3231MPMB1#	Peripheral Module

#Denotes RoHS compliant.

DS3231MPMB1 Peripheral Module

Revision History

REVISION NUMBER	REVISION DATE	DESCRIPTION	PAGES CHANGED
0	5/12	Initial release	—

Maxim cannot assume responsibility for use of any circuitry other than circuitry entirely embodied in a Maxim product. No circuit patent licenses are implied. Maxim reserves the right to change the circuitry and specifications without notice at any time.

Maxim Integrated Products, 120 San Gabriel Drive, Sunnyvale, CA 94086 408-737-7600 _____ 7