



# 8th-Order, Lowpass, Elliptic, Switched-Capacitor Filters

MAX7400/MAX7403/MAX7404/MAX7407

## General Description

The MAX7400/MAX7403/MAX7404/MAX7407 8th-order, lowpass, elliptic, switched-capacitor filters (SCFs) operate from a single +5V (MAX7400/MAX7403) or +3V (MAX7404/MAX7407) supply. These devices draw 2mA of supply current and allow corner frequencies from 1Hz to 10kHz, making them ideal for low-power anti-aliasing and post-DAC filtering applications. They feature a shutdown mode that reduces the supply current to 0.2µA.

Two clocking options are available: self-clocking (through the use of an external capacitor) or external clocking for tighter cutoff-frequency control. In addition, an offset adjustment pin (OS) allows for the adjustment of the DC output level.

The MAX7400/MAX7404 provide 82dB of stopband rejection and a sharp rolloff with a transition ratio of 1.5. The MAX7403/MAX7407 provide a sharper rolloff with a transition ratio of 1.2, while still delivering 60dB of stopband rejection. The fixed response of these devices simplifies the design task to corner-frequency selection by setting a clock frequency. The MAX7400/MAX7403/MAX7404/MAX7407 are available in 8-pin SO and DIP packages.

## Applications

- ADC Anti-Aliasing
- Speech Processing
- Post-DAC Filtering
- Air-Bag Electronics
- CT2 Base Stations

## Typical Operating Circuit

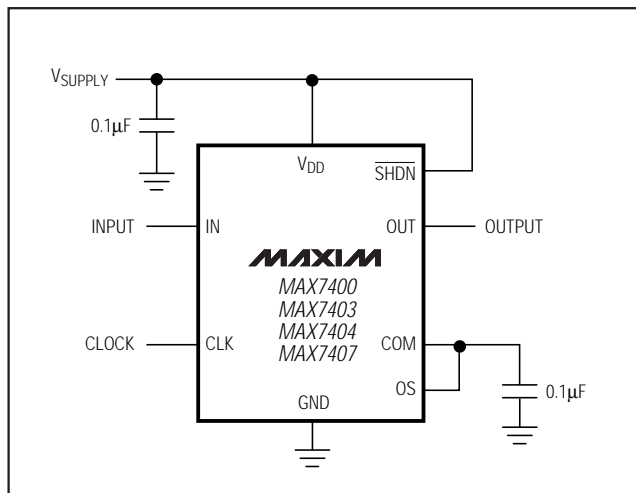

## Features

- ◆ 8th-Order Lowpass Elliptic Filter
- ◆ Low Noise and Distortion  
-82dB THD + Noise (MAX7400)
- ◆ Clock-Tunable Corner Frequency (1Hz to 10kHz)
- ◆ 100:1 Clock-to-Corner Ratio
- ◆ Single-Supply Operation  
+5V (MAX7400/MAX7403)  
+3V (MAX7404/MAX7407)
- ◆ Low Power  
2mA (Operating Mode)  
0.2µA (Shutdown Mode)
- ◆ Available in 8-Pin SO and DIP Packages
- ◆ Low Output Offset: ±5mV

## Ordering Information

PART	TEMP. RANGE	PIN-PACKAGE
MAX7400CSA	0°C to +70°C	8 SO
MAX7400CPA	0°C to +70°C	8 Plastic DIP
MAX7400ESA	-40°C to +85°C	8 SO
MAX7400EPA	-40°C to +85°C	8 Plastic DIP

Ordering Information continued at end of data sheet.

## Selector Guide

PART	FILTER RESPONSE	OPERATING VOLTAGE (V)
MAX7400	Elliptic (r = 1.5)	+5
MAX7403	Elliptic (r = 1.2)	+5
MAX7404	Elliptic (r = 1.5)	+3
MAX7407	Elliptic (r = 1.2)	+3

## Pin Configuration



# 8th-Order, Lowpass, Elliptic, Switched-Capacitor Filters

## ABSOLUTE MAXIMUM RATINGS

V <sub>DD</sub> to GND			Continuous Power Dissipation (T <sub>A</sub> = +70°C)
MAX7400/MAX7403	-0.3V to +6V		SO (derate 5.88mW/°C above +70°C).....471mW
MAX7404/MAX7407	-0.3V to +4V		DIP (derate 9.1mW/°C above +70°C).....727mW
IN, OUT, COM, OS, CLK	-0.3V to (V <sub>DD</sub> + 0.3V)		Operating Temperature Ranges
SHDN	-0.3V to +6V		MAX740_C_A .....0°C to +70°C
OUT Short-Circuit Duration	1sec		MAX740_E_A .....-40°C to +85°C
			Storage Temperature Range .....-65°C to +150°C
			Lead Temperature (soldering, 10sec) .....+300°C

Stresses beyond those listed under "Absolute Maximum Ratings" may cause permanent damage to the device. These are stress ratings only, and functional operation of the device at these or any other conditions beyond those indicated in the operational sections of the specifications is not implied. Exposure to absolute maximum rating conditions for extended periods may affect device reliability.

## ELECTRICAL CHARACTERISTICS—MAX7400/MAX7403

(V<sub>DD</sub> = +5V, filter output measured at OUT, 10k $\Omega$  || 50pF load to GND at OUT,  $\overline{\text{SHDN}}$  = V<sub>DD</sub>, OS = COM, 0.1 $\mu$ F from COM to GND, f<sub>CLK</sub> = 100kHz, T<sub>A</sub> = T<sub>MIN</sub> to T<sub>MAX</sub>, unless otherwise noted. Typical values are at +25°C.)

PARAMETER	SYMBOL	CONDITIONS	MIN	TYP	MAX	UNITS
<b>FILTER CHARACTERISTICS</b>						
Corner Frequency	f <sub>C</sub>	(Note 1)	0.001 to 10			kHz
Clock-to-Corner Ratio	f <sub>CLK</sub> /f <sub>C</sub>		100:1			
Clock-to-Corner Tempco			10			ppm/°C
Output Voltage Range			0.25	V <sub>DD</sub> - 0.25		V
Output Offset Voltage	V <sub>OFFSET</sub>	V <sub>IN</sub> = V <sub>COM</sub> = V <sub>DD</sub> / 2	±5		±25	mV
DC Insertion Gain with Output Offset Removed		V <sub>COM</sub> = V <sub>DD</sub> / 2 (Note 2)	-0.1	0.15	0.3	dB
Total Harmonic Distortion plus Noise	THD+N	f <sub>IN</sub> = 200Hz, V <sub>IN</sub> = 4Vp-p, measurement bandwidth = 22kHz				dB
OS Voltage Gain to OUT	A <sub>OS</sub>		1			V/V
Input Voltage Range at OS	V <sub>OS</sub>		V <sub>COM</sub> ±0.1			V
COM Voltage Range	V <sub>COM</sub>	Input, COM externally driven	V <sub>DD</sub> / 2 - 0.5	V <sub>DD</sub> / 2	V <sub>DD</sub> / 2 + 0.5	V
		Output, COM internally biased	V <sub>DD</sub> / 2 - 0.2	V <sub>DD</sub> / 2	V <sub>DD</sub> / 2 + 0.2	
Input Resistance at COM	R <sub>COM</sub>		75	125		k $\Omega$
Clock Feedthrough			10			mVp-p
Resistive Output Load Drive	R <sub>L</sub>		10	1		k $\Omega$
Maximum Capacitive Load at OUT	C <sub>L</sub>		50	500		pF
Input Leakage Current at COM		$\overline{\text{SHDN}}$ = GND, V <sub>COM</sub> = 0 to V <sub>DD</sub>	±0.1		±10	$\mu$ A
Input Leakage Current at OS		V <sub>OS</sub> = 0 to (V <sub>DD</sub> - 1V) (Note 3)	±0.1		±10	$\mu$ A
<b>CLOCK</b>						
Internal Oscillator Frequency	f <sub>OSC</sub>	C <sub>OSC</sub> = 1000pF (Note 4)	29	38	48	kHz
Clock Input Current	I <sub>CLK</sub>	V <sub>CLK</sub> = 0 or 5V	±15		±30	$\mu$ A
Clock Input High	V <sub>IH</sub>		V <sub>DD</sub> - 0.5			V
Clock Input Low	V <sub>IL</sub>				0.5	V

# 8th-Order, Lowpass, Elliptic, Switched-Capacitor Filters

MAX7400/MAX7403/MAX7404/MAX7407

## ELECTRICAL CHARACTERISTICS—MAX7400/MAX7403 (continued)

( $V_{DD} = +5V$ , filter output measured at OUT,  $10k\Omega \parallel 50pF$  load to GND at OUT,  $\overline{SHDN} = V_{DD}$ , OS = COM,  $0.1\mu F$  from COM to GND,  $f_{CLK} = 100kHz$ ,  $T_A = T_{MIN}$  to  $T_{MAX}$ , unless otherwise noted. Typical values are at  $T_A = +25^\circ C$ .)

PARAMETER	SYMBOL	CONDITIONS	MIN	TYP	MAX	UNITS
<b>POWER REQUIREMENTS</b>						
Supply Voltage	$V_{DD}$		4.5		5.5	V
Supply Current	$I_{DD}$	Operating mode, no load, IN = OS = COM		2	3.5	mA
Shutdown Current	$I_{\overline{SHDN}}$	$\overline{SHDN} = GND$ , CLK driven from 0 to $V_{DD}$		0.2	1	$\mu A$
Power-Supply Rejection Ratio	PSRR	Measured at DC		60		dB
<b>SHUTDOWN</b>						
$\overline{SHDN}$ Input High	$V_{SDH}$		$V_{DD} - 0.5$			V
$\overline{SHDN}$ Input Low	$V_{SDL}$				0.5	V
$\overline{SHDN}$ Input Leakage Current		$V_{\overline{SHDN}} = 0$ to $V_{DD}$		$\pm 0.1$	$\pm 10$	$\mu A$

## ELECTRICAL CHARACTERISTICS—MAX7404/MAX7407

( $V_{DD} = +3V$ , filter output measured at OUT,  $10k\Omega \parallel 50pF$  load to GND at OUT,  $\overline{SHDN} = V_{DD}$ , OS = COM,  $0.1\mu F$  from COM to GND,  $f_{CLK} = 100kHz$ ,  $T_A = T_{MIN}$  to  $T_{MAX}$ , unless otherwise noted. Typical values are at  $T_A = +25^\circ C$ .)

PARAMETER	SYMBOL	CONDITIONS	MIN	TYP	MAX	UNITS
<b>FILTER CHARACTERISTICS</b>						
Corner Frequency	$f_C$	(Note 1)		0.001 to 10		kHz
Clock-to-Corner Ratio	$f_{CLK}/f_C$			100:1		
Clock-to-Corner Tempco				10		ppm/ $^\circ C$
Output Voltage Range			0.25	$V_{DD} - 0.25$		V
Output Offset Voltage	$V_{OFFSET}$	$V_{IN} = V_{COM} = V_{DD} / 2$		$\pm 5$	$\pm 25$	mV
DC Insertion Gain with Output Offset Removed		$V_{COM} = V_{DD} / 2$ (Note 2)	-0.1	0.1	0.3	dB
Total Harmonic Distortion plus Noise	THD+N	$f_{IN} = 200Hz$ , $V_{IN} = 2.5V_{p-p}$ , measurement bandwidth = 22kHz				dB
OS Voltage Gain to OUT	$A_{OS}$			1		V/V
Input Voltage Range at OS	$V_{OS}$			$V_{COM} \pm 0.1$		V
COM Voltage Range	$V_{COM}$	COM internally biased or externally driven	$V_{DD} / 2 - 0.1$	$V_{DD} / 2$	$V_{DD} / 2 + 0.1$	V
Input Resistance at COM	$R_{COM}$		75	125		$k\Omega$
Clock Feedthrough				10		mVp-p
Resistive Output Load Drive	$R_L$		10	1		$k\Omega$
Maximum Capacitive Load at OUT	$C_L$		50	500		pF
Input Leakage Current at COM		$\overline{SHDN} = GND$ , $V_{COM} = 0$ to $V_{DD}$		$\pm 0.1$	$\pm 10$	$\mu A$
Input Leakage Current at OS		$V_{OS} = 0$ to $(V_{DD} - 1V)$ (Note 3)		$\pm 0.1$	$\pm 10$	$\mu A$

# 8th-Order, Lowpass, Elliptic, Switched-Capacitor Filters

## ELECTRICAL CHARACTERISTICS—MAX7404/MAX7407 (continued)

( $V_{DD} = +3V$ , filter output measured at OUT,  $10k\Omega \parallel 50pF$  load to GND at OUT,  $\overline{SHDN} = V_{DD}$ , OS = COM,  $0.1\mu F$  from COM to GND,  $f_{CLK} = 100kHz$ ,  $T_A = T_{MIN}$  to  $T_{MAX}$ , unless otherwise noted. Typical values are at  $T_A = +25^\circ C$ .)

PARAMETER	SYMBOL	CONDITIONS	MIN	TYP	MAX	UNITS
<b>CLOCK</b>						
Internal Oscillator Frequency	$f_{OSC}$	$C_{OSC} = 1000pF$ (Note 4)	26	34	43	kHz
Clock Input Current	$I_{CLK}$	$V_{CLK} = 0$ or $3V$		$\pm 15$	$\pm 30$	$\mu A$
Clock Input High	$V_{IH}$		$V_{DD} - 0.5$			V
Clock Input Low	$V_{IL}$				0.5	V
<b>POWER REQUIREMENTS</b>						
Supply Voltage	$V_{DD}$		2.7		3.6	V
Supply Current	$I_{DD}$	Operating mode, no load, IN = OS = COM		2	3.5	mA
Shutdown Current	$I_{\overline{SHDN}}$	$\overline{SHDN} = GND$ , CLK driven from 0 to $V_{DD}$		0.2	1	$\mu A$
Power-Supply Rejection Ratio	PSRR	Measured at DC		60		dB
<b>SHUTDOWN</b>						
$\overline{SHDN}$ Input High	$V_{SDH}$		$V_{DD} - 0.5$			V
$\overline{SHDN}$ Input Low	$V_{SDL}$				0.5	V
$\overline{SHDN}$ Input Leakage Current		$V_{\overline{SHDN}} = 0$ to $V_{DD}$		$\pm 0.1$	$\pm 10$	$\mu A$

## ELLIPTIC ( $r = 1.5$ ) FILTER CHARACTERISTICS—MAX7400/MAX7404

( $V_{DD} = +5V$  for MAX7400,  $V_{DD} = +3V$  for MAX7404; filter output measured at OUT;  $10k\Omega \parallel 50pF$  load to GND at OUT;  $\overline{SHDN} = V_{DD}$ ;  $V_{COM} = V_{OS} = V_{DD} / 2$ ;  $f_{CLK} = 100kHz$ ;  $T_A = T_{MIN}$  to  $T_{MAX}$ ; unless otherwise noted. Typical values are at  $T_A = +25^\circ C$ .)

PARAMETER	CONDITIONS	MIN	TYP	MAX	UNITS
Insertion Gain Relative to DC Gain (Note 5)	$f_{IN} = 0.371f_C$	-0.20	-0.10	0.20	dB
	$f_{IN} = 0.587f_C$	-0.20	0.02	0.20	
	$f_{IN} = 0.737f_C$	-0.20	-0.08	0.20	
	$f_{IN} = 0.868f_C$	-0.20	0.06	0.20	
	$f_{IN} = 0.940f_C$	-0.20	-0.03	0.20	
	$f_{IN} = 0.988f_C$	-0.20	0.09	0.25	
	$f_{IN} = 1.000f_C$	-0.20	0.02	0.25	
	$f_{IN} = 1.500f_C$		-82	-75	
	$f_{IN} = 1.601f_C$		-84	-78	
	$f_{IN} = 2.020f_C$		-83	-78	
	$f_{IN} = 4.020f_C$		-85	-78	

# 8th-Order, Lowpass, Elliptic, Switched-Capacitor Filters

MAX7400/MAX7403/MAX7404/MAX7407

## ELLIPTIC ( $r = 1.2$ ) FILTER CHARACTERISTICS—MAX7403/MAX7407

( $V_{DD} = +5V$  for MAX7403,  $V_{DD} = +3V$  for MAX7407; filter output measured at OUT;  $10k\Omega \parallel 50pF$  load to GND at OUT;  $\overline{SHDN} = V_{DD}$ ;  $V_{COM} = V_{OS} = V_{DD} / 2$ ;  $f_{CLK} = 100kHz$ ;  $T_A = T_{MIN}$  to  $T_{MAX}$ ; unless otherwise noted. Typical values are at  $T_A = +25^\circ C$ .)

PARAMETER	CONDITIONS	MIN	TYP	MAX	UNITS
Insertion Gain Relative to DC Gain (Note 5)	$f_{IN} = 0.408f_C$	-0.20	-0.11	0.20	dB
	$f_{IN} = 0.640f_C$	-0.20	0.02	0.20	
	$f_{IN} = 0.784f_C$	-0.20	-0.06	0.20	
	$f_{IN} = 0.902f_C$	-0.20	0.10	0.20	
	$f_{IN} = 0.956f_C$	-0.20	0.02	0.20	
	$f_{IN} = 0.992f_C$	-0.20	0.14	0.30	
	$f_{IN} = 1.000f_C$	-0.20	0.09	0.30	
	$f_{IN} = 1.200f_C$		-58	-50	
	$f_{IN} = 1.261f_C$		-59	-54	
	$f_{IN} = 1.533f_C$		-60	-54	
	$f_{IN} = 2.875f_C$		-60	-54	

**Note 1:** The maximum  $f_C$  is defined as the clock frequency,  $f_{CLK} = 100 \cdot f_C$ , at which the peak SINAD drops to 68dB with a sinusoidal input at  $0.2f_C$ .

**Note 2:** DC insertion gain is defined as  $\Delta V_{OUT} / \Delta V_{IN}$ .

**Note 3:** OS voltages above  $V_{DD} - 1V$  saturate the input and result in a  $75\mu A$  typical input leakage current.

**Note 4:** For MAX7400/MAX7403,  $f_{OSC} (kHz) \approx 38 \cdot 10^3 / C_{OSC} (pF)$ . For MAX7404/MAX7407,  $f_{OSC} (kHz) \approx 34 \cdot 10^3 / C_{OSC} (pF)$ .

**Note 5:** The input frequencies,  $f_{IN}$ , are selected at the peaks and troughs of the frequency responses.

## Typical Operating Characteristics

( $V_{DD} = +5V$  for MAX7400/MAX7403,  $V_{DD} = +3V$  for MAX7404/MAX7407;  $V_{COM} = V_{OS} = V_{DD} / 2$ ;  $\overline{SHDN} = V_{DD}$ ;  $f_{CLK} = 100kHz$ ;  $T_A = +25^\circ C$ ; unless otherwise noted.)

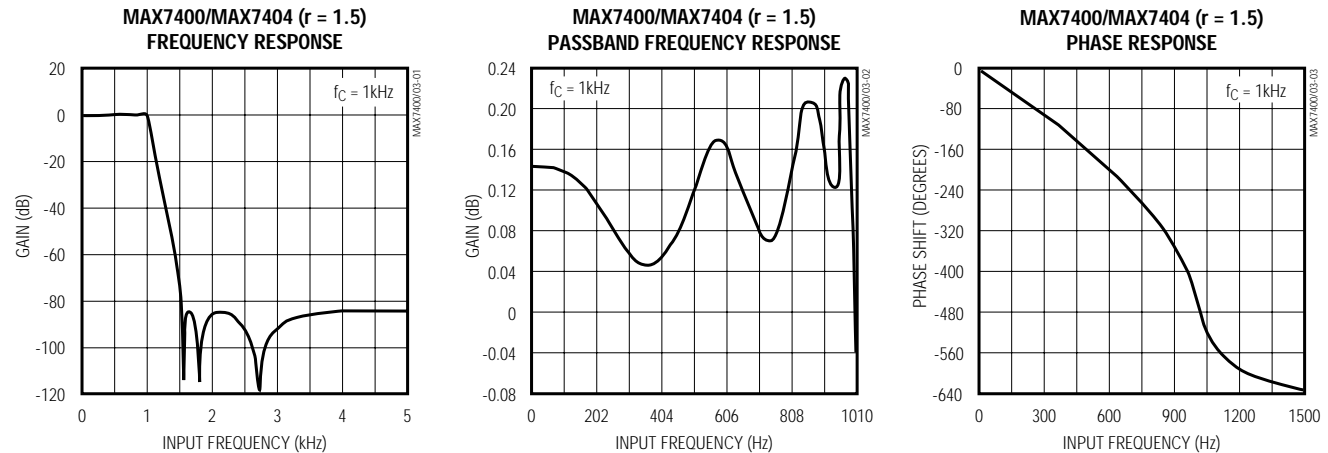

# 8th-Order, Lowpass, Elliptic, Switched-Capacitor Filters

## Typical Operating Characteristics (continued)

( $V_{DD} = +5V$  for MAX7400/MAX7403,  $V_{DD} = +3V$  for MAX7404/MAX7407;  $V_{COM} = V_{OS} = V_{DD} / 2$ ;  $\overline{SHDN} = V_{DD}$ ;  $f_{CLK} = 100kHz$ ;  $T_A = +25^\circ C$ ; unless otherwise noted.)

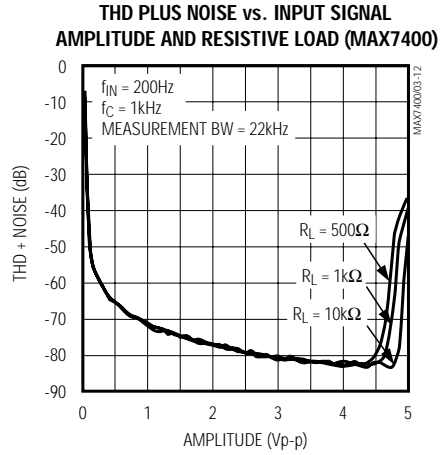
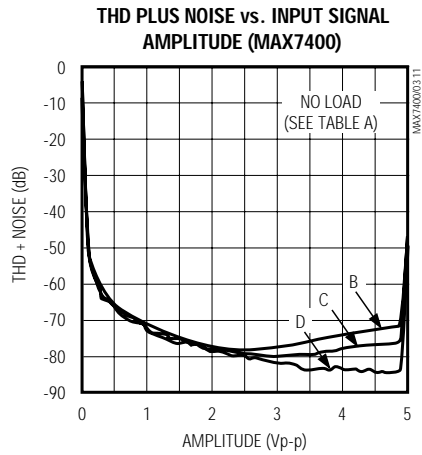
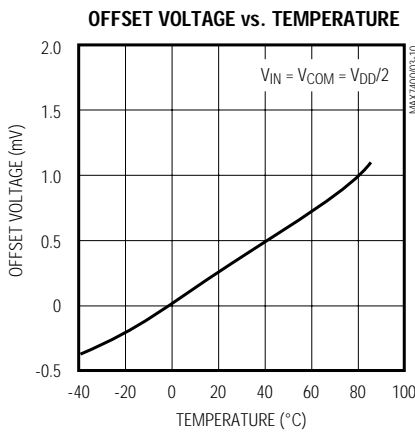
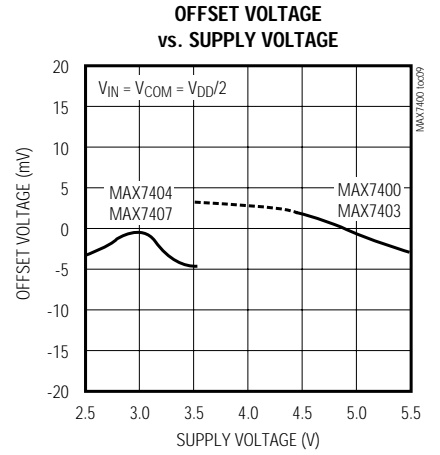
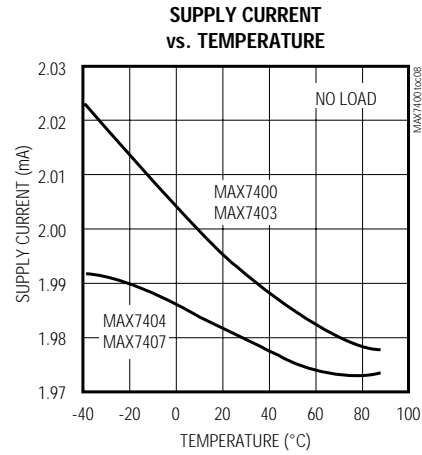
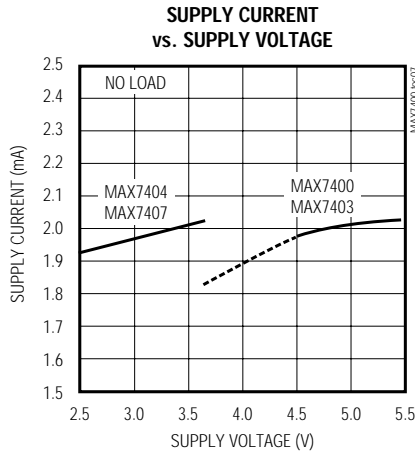
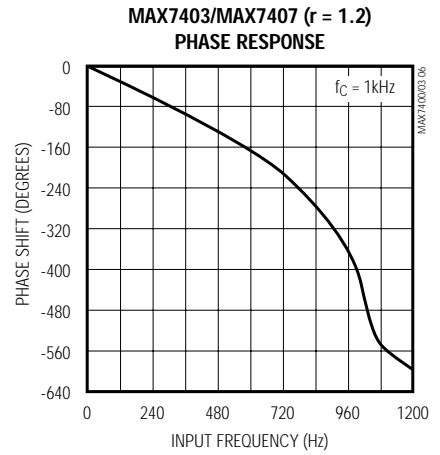
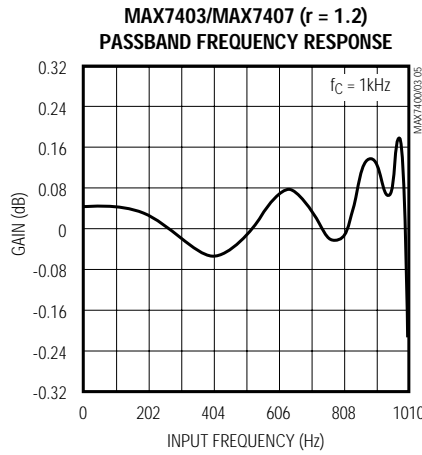
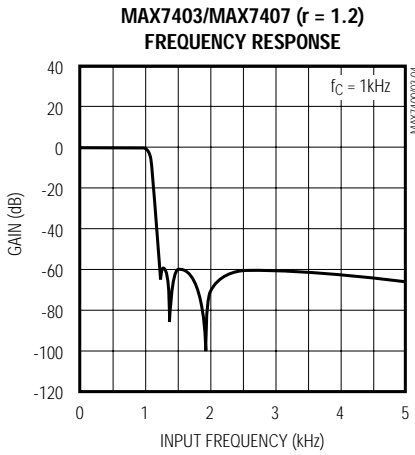

# 8th-Order, Lowpass, Elliptic, Switched-Capacitor Filters

## Typical Operating Characteristics (continued)

( $V_{DD} = +5V$  for MAX7400/MAX7403,  $V_{DD} = +3V$  for MAX7404/MAX7407;  $V_{COM} = V_{OS} = V_{DD} / 2$ ;  $\overline{SHDN} = V_{DD}$ ;  $f_{CLK} = 100kHz$ ;  $T_A = +25^\circ C$ ; unless otherwise noted.)

MAX7400/MAX7403/MAX7404/MAX7407

THD PLUS NOISE vs. INPUT SIGNAL AMPLITUDE (MAX7403)



THD PLUS NOISE vs. INPUT SIGNAL AMPLITUDE AND RESISTIVE LOAD (MAX7403)

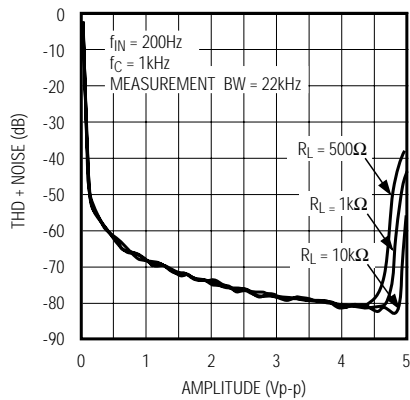
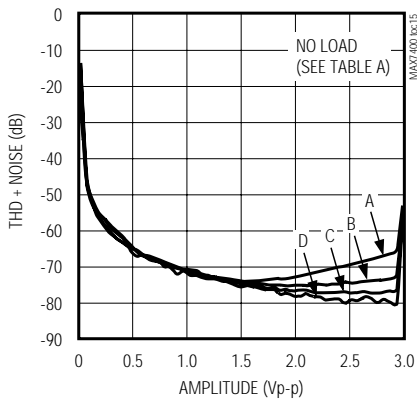

TABLE A. THD PLUS NOISE vs. INPUT SIGNAL AMPLITUDE TEST CONDITIONS

TRACE	$f_{IN}$ (Hz)	$f_C$ (kHz)	$f_{CLK}$ (kHz)	MEASUREMENT BANDWIDTH (kHz)
A	2800	14	1400	80
B	2000	10	1000	80
C	1000	5	500	80
D	200	1	100	22

THD PLUS NOISE vs. INPUT SIGNAL AMPLITUDE (MAX7404)



THD PLUS NOISE vs. INPUT SIGNAL AMPLITUDE AND RESISTIVE LOAD (MAX7404)

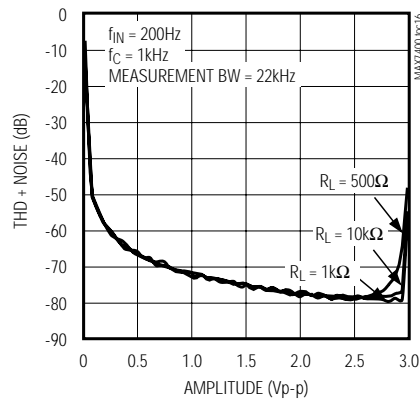

THD PLUS NOISE vs. INPUT SIGNAL AMPLITUDE (MAX7407)

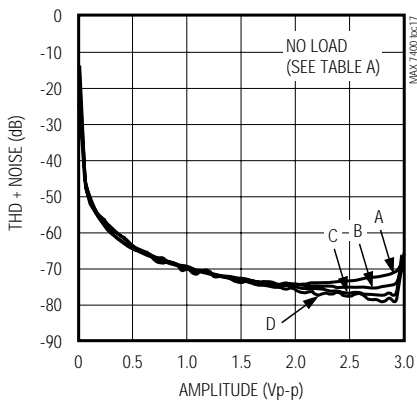

THD PLUS NOISE vs. INPUT SIGNAL AMPLITUDE AND RESISTIVE LOAD (MAX7407)

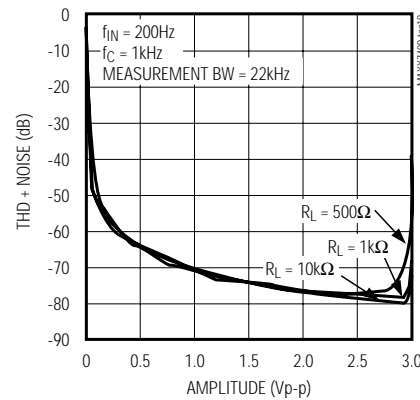

# 8th-Order, Lowpass, Elliptic, Switched-Capacitor Filters

## Typical Operating Characteristics (continued)

( $V_{DD} = +5V$  for MAX7400/MAX7403,  $V_{DD} = +3V$  for MAX7404/MAX7407;  $V_{COM} = V_{OS} = V_{DD} / 2$ ;  $\overline{SHDN} = V_{DD}$ ;  $f_{CLK} = 100kHz$ ;  $T_A = +25^\circ C$ ; unless otherwise noted.)

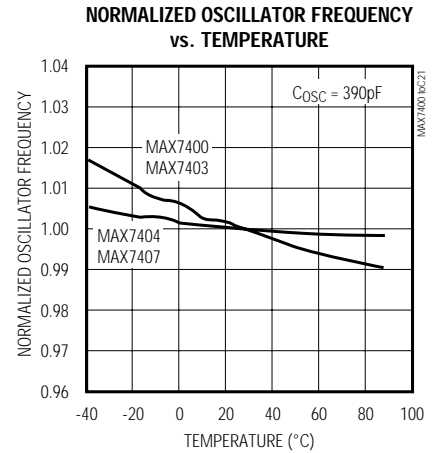

## Pin Description

PIN	NAME	FUNCTION
1	COM	Common Input. Biased internally at midsupply. Bypass externally to GND with a 0.1 $\mu$ F capacitor. To override internal biasing, drive with an external supply.
2	IN	Filter Input
3	GND	Ground
4	$V_{DD}$	Positive Supply Input: +5V for MAX7400/MAX7403, +3V for MAX7404/MAX7407
5	OUT	Filter Output
6	OS	Offset Adjust Input. To adjust output offset, bias OS externally. Connect OS to COM if no offset adjustment is needed. Refer to <i>Offset and Common-Mode Input Adjustment</i> section.
7	$\overline{SHDN}$	Shutdown Input. Drive low to enable shutdown mode; drive high or connect to $V_{DD}$ for normal operation.
8	CLK	Clock Input. To override the internal oscillator, connect to an external clock; otherwise, connect an external capacitor ( $C_{OSC}$ ) from CLK to GND to set the internal oscillator frequency.





# 8th-Order, Lowpass, Elliptic, Switched-Capacitor Filters

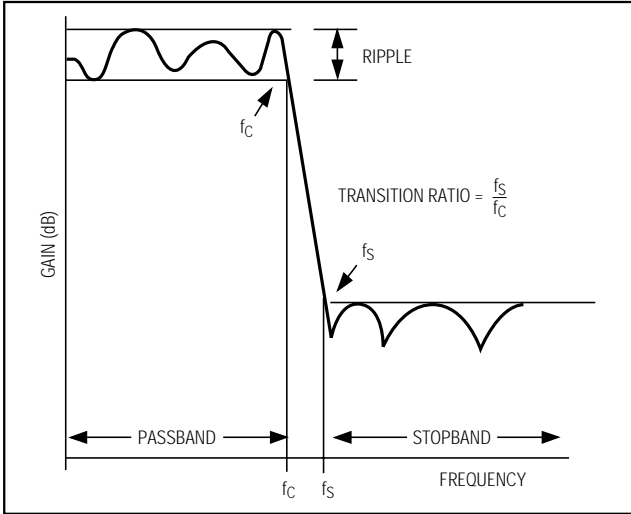

Figure 3. Elliptic Filter Response

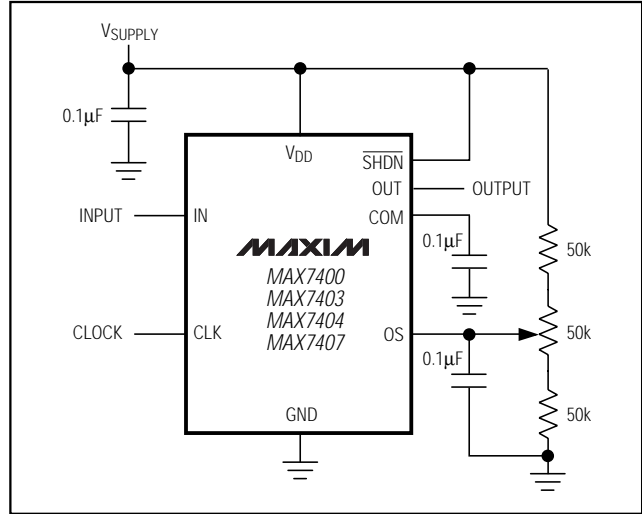

Figure 4. Offset Adjustment Circuit

### Clock Signal

#### External Clock

The MAX7400/MAX7403/MAX7404/MAX7407 SCFs were designed for use with external clocks that have a 40% to 60% duty cycle. When using an external clock, drive CLK with a CMOS gate powered from 0 to V<sub>DD</sub>. Varying the rate of the external clock adjusts the filter corner frequency:

$$f_c = f_{CLK} / 100$$

#### Internal Clock

When using the internal oscillator, the capacitance (C<sub>OSC</sub>) on the CLK pin determines the oscillator frequency:

$$f_{osc}(\text{kHz}) = \frac{K \cdot 10^3}{C_{osc}}; \text{ } C_{osc} \text{ in pF}$$

where K = 38 for the MAX7400/MAX7403, and K = 34 for the MAX7404/MAX7407. Since the capacitor value is in picofarads, minimize the stray capacitance at CLK so that it does not affect the internal oscillator frequency. Varying the rate of the internal oscillator adjusts the filter's corner frequency by a 100:1 clock-to-corner frequency ratio. For example, an internal oscillator frequency of 100kHz produces a nominal corner frequency of 1kHz.

#### Input Impedance vs. Clock Frequencies

The MAX7400/MAX7403/MAX7404/MAX7407's input impedance is effectively that of a switched-capacitor resistor and is inversely proportional to frequency. The

input impedance determined by the following equation represents the average input impedance, since the input current is not continuous. As a rule, use a driver with an output source impedance less than 10% of the filter's input impedance. Estimate the input impedance of the filter using the following formula:

$$Z_{IN}(\Omega) = \frac{1}{(f_{CLK} \cdot C_{IN})}$$

where f<sub>CLK</sub> = clock frequency and C<sub>IN</sub> = 0.85pF.

#### Low-Power Shutdown Mode

These devices feature a shutdown mode that is activated by driving SHDN low. Placing the filter in shutdown mode reduces the supply current to 0.2µA (typ) and places the output of the filter into a high-impedance state. For normal operation, drive SHDN high or connect to V<sub>DD</sub>.

## Applications Information

#### Offset and Common-Mode Input Adjustment

The voltage at COM sets the common-mode input voltage and is internally biased at midsupply by a resistor-divider. Bypass COM with a 0.1µF capacitor and connect OS to COM. For applications requiring offset adjustment or DC level shifting, apply an external bias voltage through a resistor-divider network to OS, as shown in Figure 4. (Note: Do not leave OS unconnected.) The output voltage is represented by the following equation:

$$V_{OUT} = (V_{IN} - V_{COM}) + V_{OS}$$

# 8th-Order, Lowpass, Elliptic, Switched-Capacitor Filters

with  $V_{COM} = V_{DD} / 2$  (typical), and where  $(V_{IN} - V_{COM})$  is lowpass filtered by the SCF, and  $V_{OS}$  is added at the output stage. See the *Electrical Characteristics* for COM and OS input voltage ranges. Changing the voltage on COM or OS significantly from midsupply reduces the filter's dynamic range.

### Power Supplies

The MAX7400/MAX7403 operate from a single +5V supply. The MAX7404/MAX7407 operate from a single +3V supply. Bypass  $V_{DD}$  to GND with a 0.1 $\mu$ F capacitor. If dual supplies are required, connect COM to the system ground and GND to the negative supply. Figure 5 shows an example of dual-supply operation. Single-supply and dual-supply performance are equivalent. For single-supply or dual-supply operation, drive CLK and SHDN from GND (V- in dual-supply operation) to  $V_{DD}$ . For a  $\pm 2.5V$  supply, use the MAX7400 or MAX7403; for a  $\pm 1.5V$  supply, use MAX7404 or MAX7407. For  $\pm 5V$  dual-supply applications, use the MAX291–MAX297.

### Input Signal Amplitude Range

The ideal input signal range is determined by observing the voltage level at which the total harmonic distortion plus noise (THD+N) is minimized for a given corner frequency. The *Typical Operating Characteristics* show THD+N response as the input signal's peak-to-peak amplitude is varied. These measurements are made with OS and COM biased at midsupply.

### Anti-Aliasing and Post-DAC Filtering

When using the MAX7400/MAX7403/MAX7404/MAX7407 for anti-aliasing or post-DAC filtering, synchronize the DAC and the filter clocks. If the clocks are not synchronized, beat frequencies may alias into the passband.

The high clock-to-corner frequency ratio (100:1) also eases the requirements of pre- and post-SCF filtering. At the input, a lowpass filter prevents the aliasing of frequencies around the clock frequency into the passband. At the output, a lowpass filter attenuates the clock feedthrough.

A high clock-to-corner frequency ratio allows a simple RC lowpass filter, with the cutoff frequency set above the SCF corner frequency, to provide input anti-aliasing and reasonable output clock attenuation.

### Harmonic Distortion

Harmonic distortion arises from nonlinearities within the filter. Such nonlinearities generate harmonics when a pure sine wave is applied to the filter input. Table 1 lists typical harmonic distortion values with a 10k $\Omega$  load and an input signal of 4Vp-p (MAX7400/MAX7403) or 2Vp-p (MAX7404/MAX7407), at  $T_A = +25^\circ C$ .

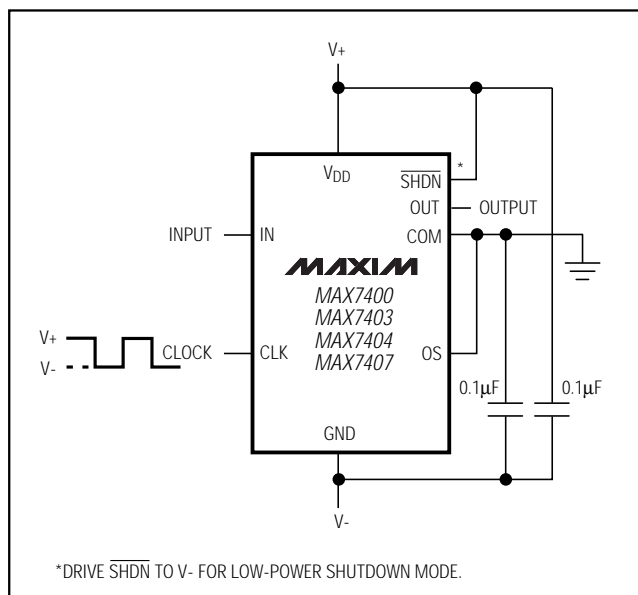

Figure 5. Dual-Supply Operation

Table 1. Typical Harmonic Distortion

FILTER	fCLK (kHz)	fc (kHz)	fIN (Hz)	VIN (Vp-p)	TYPICAL HARMONIC DISTORTION (dB)			
					2nd	3rd	4th	5th
MAX7400	100	1	200	4	-89	-82	-89	-86
	500	5	1000		-89	-77	-93	-88
MAX7403	100	1	200	4	-88	-81	-91	-87
	500	5	1000		-84	-80	-90	-91
MAX7404	100	1	200	2	-85	-82	-85	-86
	500	5	1000		-85	-81	-86	-84
MAX7407	100	1	200	2	-85	-82	-85	-86
	500	5	1000		-86	-84	-85	-86

# 8th-Order, Lowpass, Elliptic, Switched-Capacitor Filters

## Ordering Information (continued)

PART	TEMP. RANGE	PIN-PACKAGE
<b>MAX7403</b> CSA	0°C to +70°C	8 SO
MAX7403CPA	0°C to +70°C	8 Plastic DIP
MAX7403ESA	-40°C to +85°C	8 SO
MAX7403EPA	-40°C to +85°C	8 Plastic DIP
<b>MAX7404</b> CSA	0°C to +70°C	8 SO
MAX7404CPA	0°C to +70°C	8 Plastic DIP
MAX7404ESA	-40°C to +85°C	8 SO
MAX7404EPA	-40°C to +85°C	8 Plastic DIP
<b>MAX7407</b> CSA	0°C to +70°C	8 SO
MAX7407CPA	0°C to +70°C	8 Plastic DIP
MAX7407ESA	-40°C to +85°C	8 SO
MAX7407EPA	-40°C to +85°C	8 Plastic DIP

## Chip Information

TRANSISTOR COUNT: 1116

## Package Information

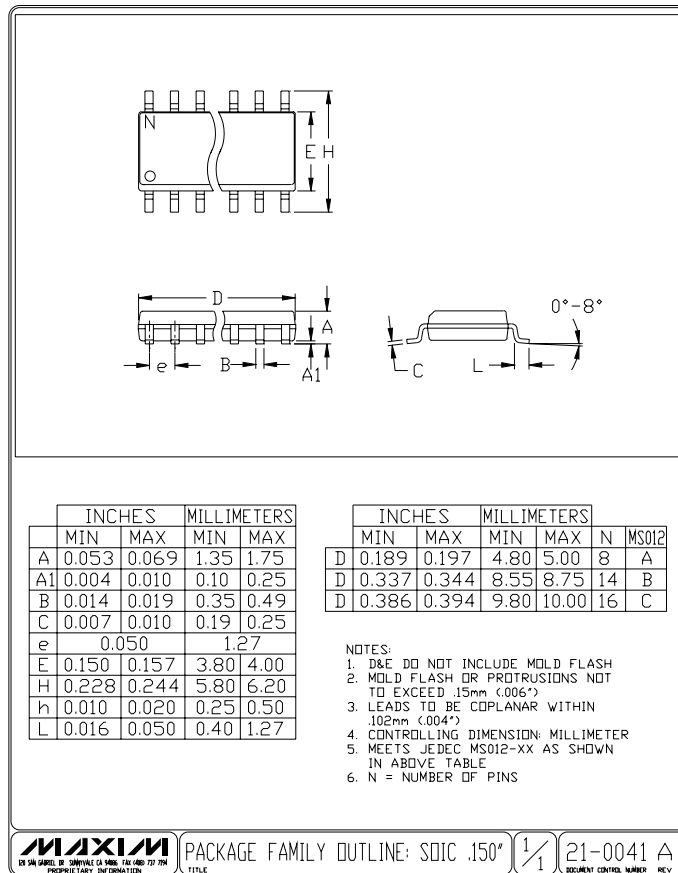

Maxim cannot assume responsibility for use of any circuitry other than circuitry entirely embodied in a Maxim product. No circuit patent licenses are implied. Maxim reserves the right to change the circuitry and specifications without notice at any time.

12 Maxim Integrated Products, 120 San Gabriel Drive, Sunnyvale, CA 94086 408-737-7600

This datasheet has been download from:

[www.datasheetcatalog.com](http://www.datasheetcatalog.com)

Datasheets for electronics components.