

Total solder points: 202

Difficulty level: *beginner* 1 2 3 4 5 *advanced*

DMX CONTROLLED POWER DIMMER

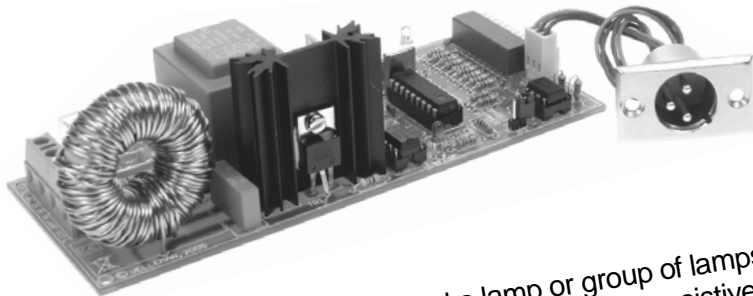

K8039

Control a lamp or group of lamps through a DMX signal. Suitable for resistive and mains voltage halogen lighting.

This kit allows you to control a lamp or group of lamps through a DMX signal. The DMX protocol was developed by USITT in 1986 with the purpose of controlling dimmers, scanners, moving heads and other lighting devices with simple wiring. It is mainly being used in theatres and discos, but you can use it in any place where a central or automated lighting is needed.

Use our “USB controlled DMX interface” **K8062** (kit version), **VM116** (assembled version) or any other control console compliant with the DMX-512 protocol as a controller

FEATURES:

- suitable for resistive loads like incandescent lamps and mains voltage halogen lighting
- system addressability: 512 unique addresses, selectable with DIP switch
- status LED for power and error detection
- toroidal filtering for low noise (according to EN55015)
- stand alone “test” mode
- control source: DMX-512, 3 pin XLR socket included

SPECIFICATIONS:

- load capacity: max. 1000 W @ 230V (5A) or 500W @ 115V
- power Input: 115/230 VAC
- size: 150 x 60 x 45mm / 5,9 x 2,36 x 1,77"

modifications reserved

1. Assembly (Skipping this can lead to troubles !)

Ok, so we have your attention. These hints will help you to make this project successful. Read them carefully.

1.1 Make sure you have the right tools:

- A good quality soldering iron (25-40W) with a small tip.
- Wipe it often on a wet sponge or cloth, to keep it clean; then apply solder to the tip, to give it a wet look. This is called 'thinning' and will protect the tip, and enables you to make good connections. When solder rolls off the tip, it needs cleaning.
- Thin raisin-core solder. Do not use any flux or grease.
- A diagonal cutter to trim excess wires. To avoid injury when cutting excess leads, hold the lead so they cannot fly towards the eyes.
- Needle nose pliers, for bending leads, or to hold components in place.
- Small blade and Phillips screwdrivers. A basic range is fine.

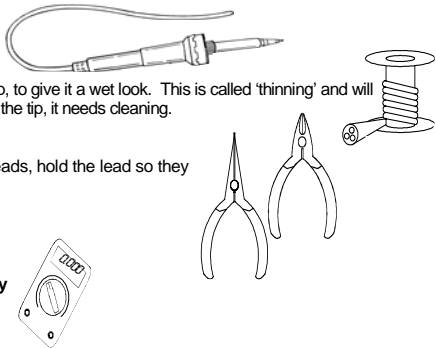

For some projects, a basic multi-meter is required, or might be handy

1.2 Assembly Hints :

- ⇒ Make sure the skill level matches your experience, to avoid disappointments.
- ⇒ Follow the instructions carefully. Read and understand the entire step before you perform each operation.
- ⇒ Perform the assembly in the correct order as stated in this manual
- ⇒ Position all parts on the PCB (Printed Circuit Board) as shown on the drawings.
- ⇒ Values on the circuit diagram are subject to changes.
- ⇒ Values in this assembly guide are correct*
- ⇒ Use the check-boxes to mark your progress.
- ⇒ Please read the included information on safety and customer service

* Typographical inaccuracies excluded. Always look for possible last minute manual updates, indicated as 'NOTE' on a separate leaflet.

1.3 Soldering Hints :

1- Mount the component against the PCB surface and carefully solder the leads

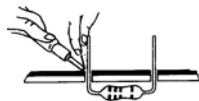

2- Make sure the solder joints are cone-shaped and shiny

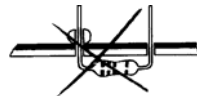

3- Trim excess leads as close as possible to the solder joint



REMOVE THEM FROM THE TAPE ONE AT A TIME !

AXIAL COMPONENTS ARE TAPED IN THE CORRECT MOUNTING SEQUENCE !

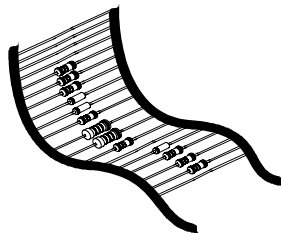

1. Jumper wires

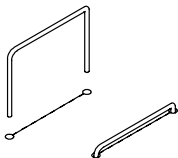

J : 6x

2. Diodes. Watch the polarity !

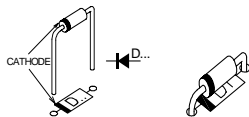

- D1 : 1N4007
- D2 : 1N4007
- D3 : 1N4007
- D4 : 1N4007
- D5 : 1N4007
- D6 : 1N4007

3. Resistors

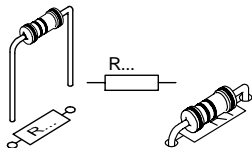

- R1 : 10K (1-0-3-B)
- R2 : 10K (1-0-3-B)
- R3 : 10K (1-0-3-B)
- R4 : 10K (1-0-3-B)
- R5 : 10K (1-0-3-B)
- R6 : 10K (1-0-3-B)
- R7 : 10K (1-0-3-B)
- R8 : 10K (1-0-3-B)
- R9 : 10K (1-0-3-B)
- R10 : 10K (1-0-3-B)
- R11 : 10K (1-0-3-B)
- R12 : 100K (1-0-4-B)
- R13 : 1K5 (1-5-2-B)
- R14 : 1K5 (1-5-2-B)
- R15 : 1K5 (1-5-2-B)
- R16 : 1K5 (1-5-2-B)
- R17 : 2K2 (2-2-2-B)
- R18 : 1M (1-0-5-B)
- R19 : 330 (3-3-1-B)

4. Metal film resistors

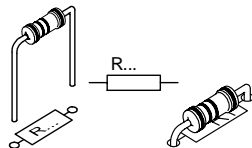

- R20 : 470 (4-7-1-B-9)
- R21 : 470 (4-7-1-B-9)
- R22 : 220 (2-2-1-B-9)
- R27 : 120 (1-2-1-B-9)

5. IC sockets, Watch the position of the notch!

- IC1 : 8p
- IC2 : 18p
- IC3 : 6p
- IC4 : 6p

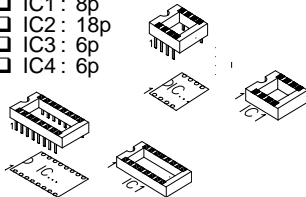

6. Capacitors.

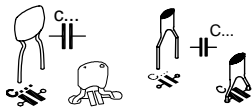

- C1 : 15pF (15)
- C2 : 15pF (15)
- C3 : 10nF (103)
- C4 : 10nF (103)
- C5 : 100nF (104)
- C6 : 100nF (104)
- C7 : 100nF (104)
- C8 : 100nF (104)
- C9 : 100nF (104)

7. LED's. Watch the polarity !

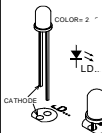

- LD1 : 3mm Green
- LD2 : 3mm Red

- LD1 ➔ Power
- LD2 ➔ Error

8. 1W Resistor.

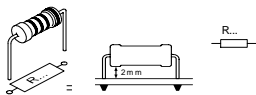

- R23 : 22K (2 - 2 - 3 - B)

Do not mount R24 yet !

9. Vertical resistors

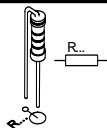

- R25 : 1M (1 - 0 - 5 - B)
- R26 : 1M (1 - 0 - 5 - B)

10. Pin header

- JP2 : 2p (mode selection)

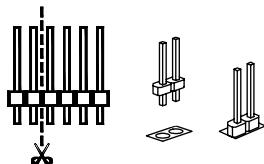

11. Piano DIP switch

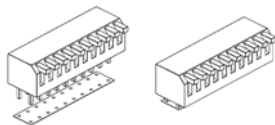

- SW1 : DMX address selection

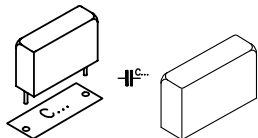
12. Capacitor.

- C12 : 100nF / 250Vac

13. Board to wire connector

- SK4 : 3p DMX input

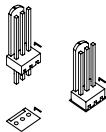
**14. Quartz crystal**

- X1 : 20MHz

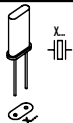
**15. Electrolytic capacitors**
Watch the polarity!

- C10 : 220 μ F/25V
- C11 : 220 μ F/25V

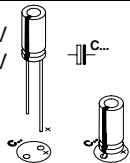
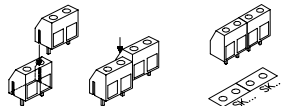
**16. Terminal blocks**

- SK1 : 2p AC input
- SK2 : 2p Lamp output

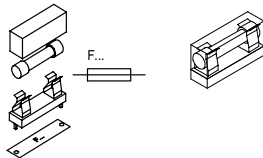
17. Fuses

- F1 : 5A (slow)
- F2 : 100mA (fast)

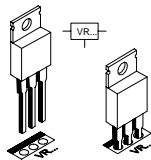
18. Voltage regulator

- VR1 : UA7805

19. Transformer

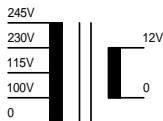
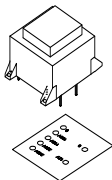

- Transfo
(2,5VA / 1x12V / 100V-115V-230V - 245V)

20. Triac

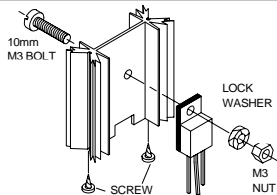

- TR1 : TIC246M

21. Toroidal coil

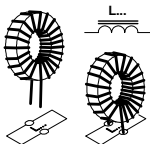

- L1 : 1mH / 1kHz - 5A

22. IC's. Watch the position of the notch

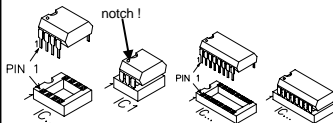

- IC1 : SN75176
- IC2 : VK8039
(programmed PIC16F627A)
- IC3 : 4N33
- IC4 : K3020P

23. Choose operation voltage

230V :

R24 : 22K (2 - 2 - 3 - B)

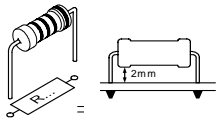

Mount a wire jumper for JP1 according to the figure

230V



230 / 115

115V :

Mount for R24 a wire jumper

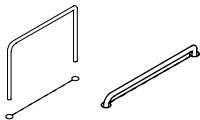

Mount a jumper wire for JP1 according to the figure

115V



230 / 115



CHECK THOROUGHLY ALL THE COMPONENTS FOR MISS MOUNTING, INCLUDING SOLDERING ERRORS.

24. Wiring the 3P XLR plug

Solder the 3-pole female print connector to the XLR connector using the figure below to check the accuracy of the connections (see figure 1.0)

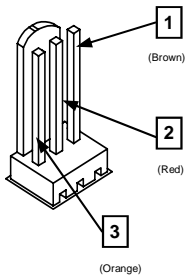

Legend :

- 1 Ground
- 2 Data -
- 3 Data +

Fig. 1.0

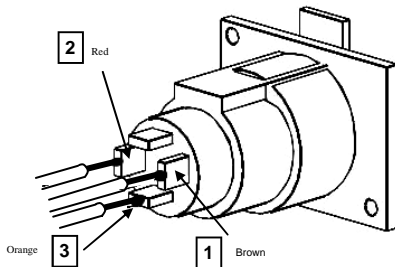

25. Check-up



CAUTION: MOST PARTS OF THE CIRCUIT CARRY DANGEROUS VOLTAGES (MAINS) !
OBSERVE ALL SAFETY REQUIREMENTS THAT MIGHT APPLY !

MOUNT THIS KIT PREFERABLY IN AN ISOLATING HOUSING.

- Check the optical isolation between the mains voltage terminals (SK1 and SK2) and the DMX connector terminals (SK4) by means of a multimeter (fig 2.0). Resistance should be infinite.

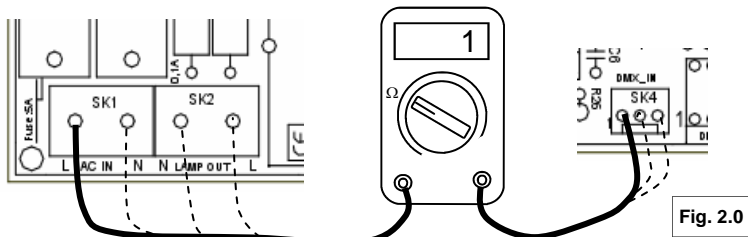

- Make sure you mount the appropriate fuses: F1 (5A) protects the outputs against overload but not against short circuits! A short circuit will damage the TR1 triac. F2 (100mA) protects the electronic parts on the circuit.

👉 **Never install higher value fuse !**

26. Stand-alone test

The K8039 consists of 2 internal parts: a low-voltage part taking care of the DMX decoding and a high-voltage part controlling the lamp. You can test the latter part with the self-testing function

 **Make sure the PCB is not live!**

- Close the “mode” jumper, JP2 by means of a shunt.
- Set the DMX address to 0, i.e. all switches to “OFF”.
- Connect a light bulb (min 60W) with the output (LAMP OUT).
- Switch on the K8039 (AC IN)
- The light bulb should slowly fade in and out.
- Remove the power and shunt JP2.

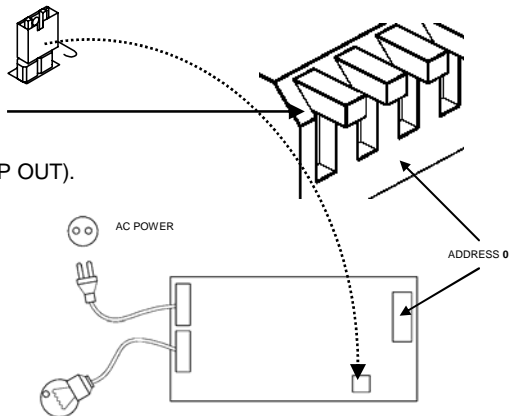

27. Connection & use

1. Connect a lamp or lamp group with the “LAMP OUT” (SK2) output. Watch the output power: it should be between 60 and 1000W and shouldn't be a capacitive (ex. electronic transformer) or an inductive charge (ex. halogen lighting with transformer).

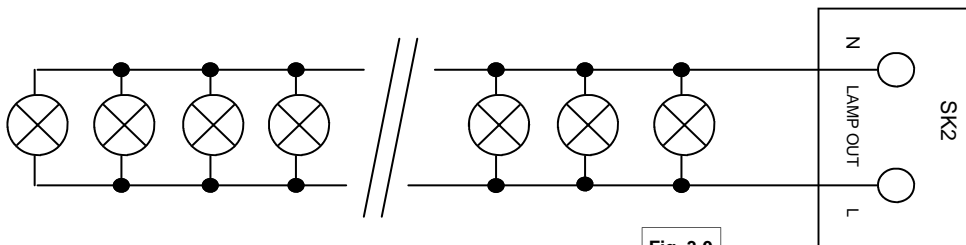

Fig. 3.0

2. Connect the DMX signal to the “DMX IN” input (SK4).

3. Set up the DMX channel to which the K8039 has to react:

Set up the DMX channel or “DMX address” by means of the DIPSWITCH, SW1. You can set up the DMX channel between 1 and 511, channel 0 is not used. The switches from 1 to 9 generate a binary digit representing the DMX channel. Switch 1 is the LSB, switch 9 is the MSB. Only modify the DMX channel when the K8039 is not live. Make sure to turn the kit live after every modification.

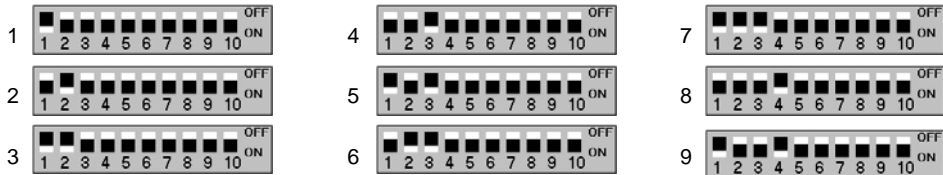

Fig. 4.0

Please go to our website (www.velleman.be) and consult the handy graphical help program showing the position of the switches. Setting up will become easy!



Fig. 5.0

4. Switch 10 of the SW1 to ON when using the K8039 as sole connected DMX device or when it is the last connected device in the series.

☞ Connect the last fixture in the series with a “terminator resistor” of 120 ohm. The PCB is already equipped with a terminating resistance. Activate it as follows: switch 10 of the DIP switch to “ON”. Do not engage the terminating resistance on all the other fixtures in the series. In other words, set switch 10 to “OFF” on all other K8039 kits.

5. Finally connect the mains voltage with the “AC IN” input and switch it on.

6. The “power” LED, LD1 has to light whenever the PCB is connected to the mains.

7. When increasing the DMX value for the set-up channel, the lamp's brightness has to increase and vice versa.

LD2 'error' LED will flashes once when switching on the mains. If an irregularity is found LD2 will indicate the possible fault (see table).

LD2 flashes continuously	<ul style="list-style-type: none"> • No connection between a DMX controller and the K8039 • DMX signal's polarity can be wrong • Signal is not compatible.
LD2 burn continuously	<ul style="list-style-type: none"> • DMX address is set to the 0-value and not in mode stand-alone with JP2. • An incorrect synchronisation • No recognition of the synchronisation employing power-line frequency. <p><i>☞ Check the assembly, especially: R10, R23(24) R18, C4, D5, D6 and IC3.</i></p>

28. DMX error correction mode (JP2 “mode”)

In normal mode (JP2 not mounted) the dimmer reacts every time, i.e. as fast as possible to the destined DMX value. In this mode it is possible to make fast yet fluid fading effects.

When the error correction mode is enabled (JP2 mounted) the set luminosity will be more stable. It may be necessary with some brands of DMX equipment.

Due to the high tolerance in the DMX protocol not all DMX controllers run stable together with the DMX fixtures.

In this mode, an identical value has to be read twice by a DMX channel until the dimmer modifies the luminosity. The drawback is that the dimmer's reaction time will slow down when changing the light intensity rapidly.

29. PCB

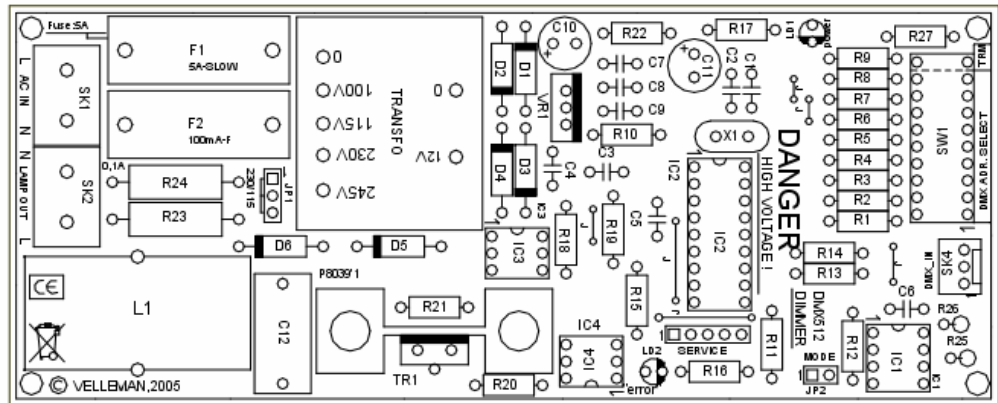

30. Schematic diagram

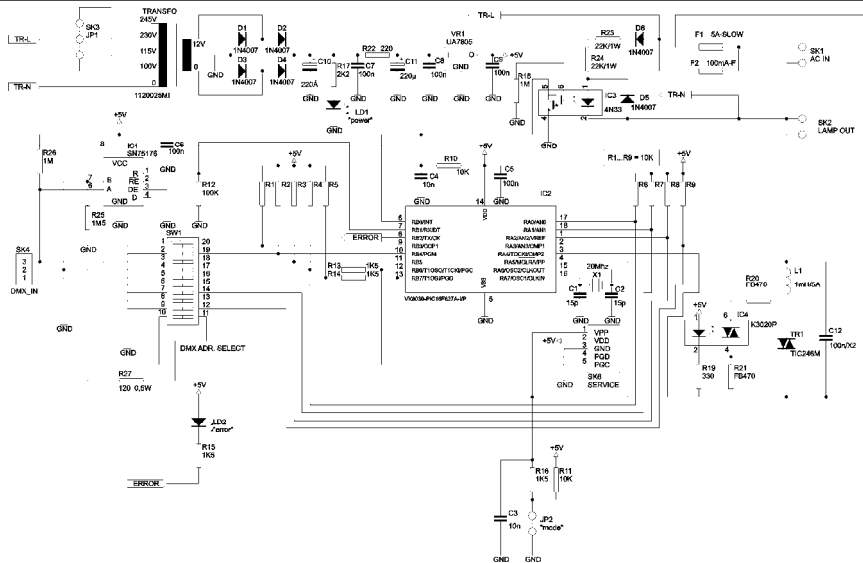



Modifications and typographical errors reserved

© Velleman Components nv.

H8039IP - 2005 - ED1_rev1

