

Total solder points: 123

Difficulty level: *beginner* 1 2 3 4 5 *advanced*

AUDIO ANALYZER

K8098

Give your audio gear a
high-tech look.

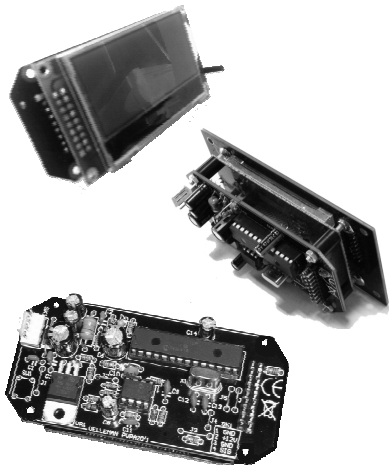

Features

- measure:
 - peak power (fig.1)
 - RMS power (fig.2)
 - mean dB (fig.3)
 - peak dB (fig.4)
 - linear audio spectrum (fig.5)
 - 1/3 octave audio spectrum (fig.6)
- auto or manual range selection
- peak-hold function
- speaker impedance selection
- language selection
- white backlit LCD
- easy panel mounting

Specifications

- power measurement into 2, 4 or 8 ohms + bridged amp option
- range: 300mW to 1200W @ 2 ohms
- sensitivity: -34dBu (15.5 mVrms)
- max. input level: 50Vrms @ 220k
- frequency range: 20Hz to 20kHz
- power supply: 12VDC / 75mA
- dimensions:
 - display: 128 x 64mm / 5 x 2.5" (46 x 24mm / 1.8 x 0.95")
 - front panel: 98 x 51mm / 3.8 x 2"
 - mounting depth: 35mm / 1.37"

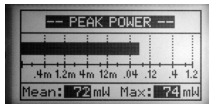

fig.1

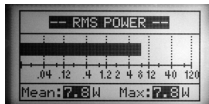

fig.2

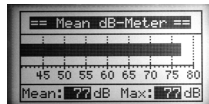

fig.3



fig.4

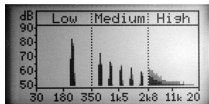

fig.5

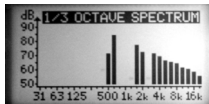
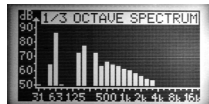

fig.6



ex. reversed

1. Assembly (Skipping this can lead to troubles !)

Ok, so we have your attention. These hints will help you to make this project successful. Read them carefully.

1.1 Make sure you have the right tools:

- A good quality soldering iron (25-40W) with a small tip.
- Wipe it often on a wet sponge or cloth, to keep it clean; then apply solder to the tip, to give it a wet look. This is called 'thinning' and will protect the tip, and enables you to make good connections. When solder rolls off the tip, it needs cleaning.
- Thin raisin-core solder. Do not use any flux or grease.
- A diagonal cutter to trim excess wires. To avoid injury when cutting excess leads, hold the lead so they cannot fly towards the eyes.
- Needle nose pliers, for bending leads, or to hold components in place.
- Small blade and Phillips screwdrivers. A basic range is fine.

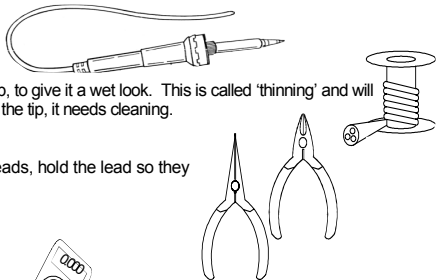

For some projects, a basic multi-meter is required, or might be handy

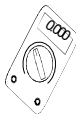

1.2 Assembly Hints :

- ⇒ Make sure the skill level matches your experience, to avoid disappointments.
 - ⇒ Follow the instructions carefully. Read and understand the entire step before you perform each operation.
 - ⇒ Perform the assembly in the correct order as stated in this manual
 - ⇒ Position all parts on the PCB (Printed Circuit Board) as shown on the drawings.
 - ⇒ Values on the circuit diagram are subject to changes.
 - ⇒ Values in this assembly guide are correct*
 - ⇒ Use the check-boxes to mark your progress.
 - ⇒ Please read the included information on safety and customer service
- * Typographical inaccuracies excluded. Always look for possible last minute manual updates, indicated as 'NOTE' on a separate leaflet.

1.3 Soldering Hints :

1- Mount the component against the PCB surface and carefully solder the leads

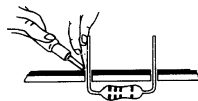

2- Make sure the solder joints are cone-shaped and shiny

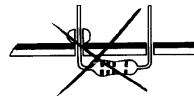
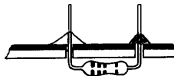

3- Trim excess leads as close as possible to the solder joint

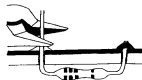

REMOVE THEM FROM THE TAPE ONE AT A TIME !

DO NOT BLINDLY FOLLOW THE ORDER OF THE COMPONENTS ONTO THE TAPE. ALWAYS CHECK THEIR VALUE ON THE PARTS LIST!

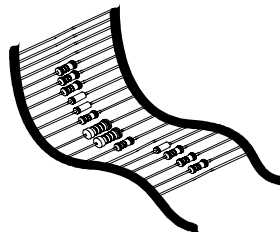

The audio analyzer consist of three parts: the basic module, the display module and the front panel.
 If required you can mount this kit into a housing, panel, ...
 In this case use the display gap as a marker reference.



First we assemble the basic module.

1. Jumper wire

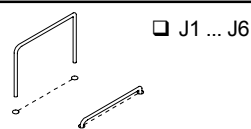

2. Horizontal resistors

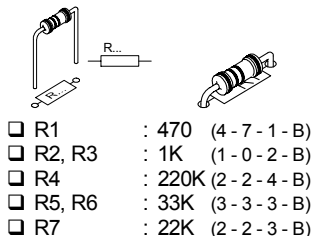

- R8 : 750 (7-5-1-B)
- R9 : 180K (1-8-4-B)
- R10 : 2K2 (2-2-2-B)
- R11, R12 : 6K8 (6-8-2-B)
- R13 : 680 (6-8-1-B)
- R14 : 3K3 (3-3-2-B)
- R15 : 750 (7-5-1-B)
- R16 : 5K6 (5-6-2-B)
- R17 : 220 (2-2-1-B)
- R18 : 22K (2-2-3-B)

3. Diode. Watch the polarity!



4. IC socket. Watch the position of the notch!

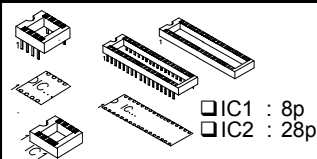

5. HF-Choke

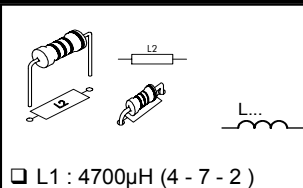

6. Voltage regulator

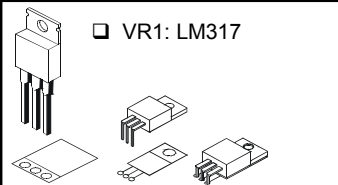

7. Capacitors.

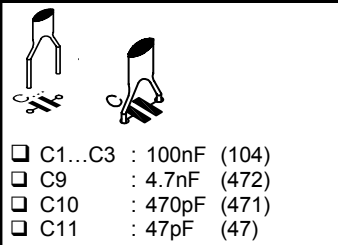

☞ C12, C13 & X1 are not mounted !

8. Pin header

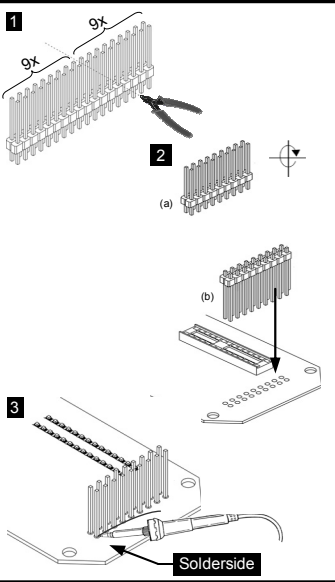

9. Electrolytic Capacitor. Watch the polarity !

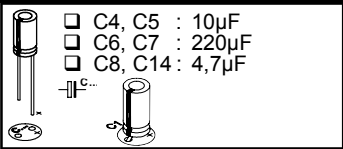

10. Board-to-wire connector



11. Push button

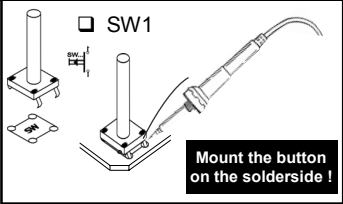

12. IC. Watch the position of the notch!

□ IC1 : MCP6002-E/P

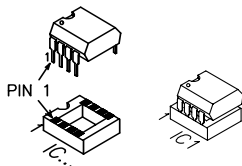

□ IC2 : VKVPA20 programmed
DSPIC33FJ32I/SP

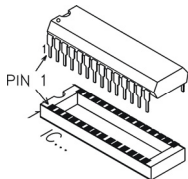

13. Pin header

A

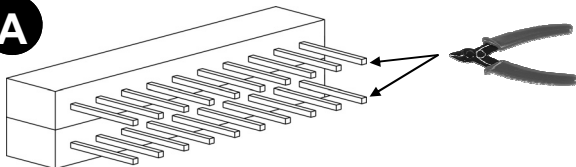

B

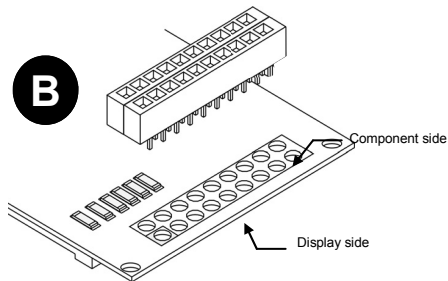

Mount the female connector on the component side, solder on the display side!

14. Assembly

1. Roughen the 4 bolts with a knife, a file or some abrasive paper so it will be easier to solder them to the front panel.
2. Assemble the unit but do not yet tighten the bolts (fig.1).

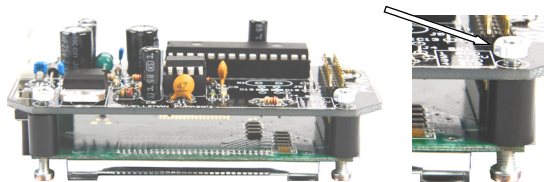

Fig.1

3. Position the unit onto the rear of the front panel with the display is centred in the cut-away. Temporarily fix the unit to the rear using non-permanent tape (fig. 2).

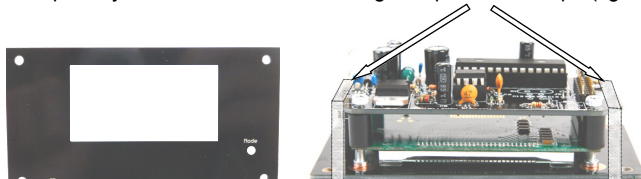

Fig.2

4. Solder 2 diagonal bolts to the front panel. Check if the display is still centred in the cut-away. Solder the remaining 2 bolts (fig. 3).

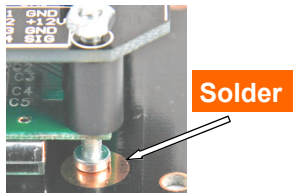
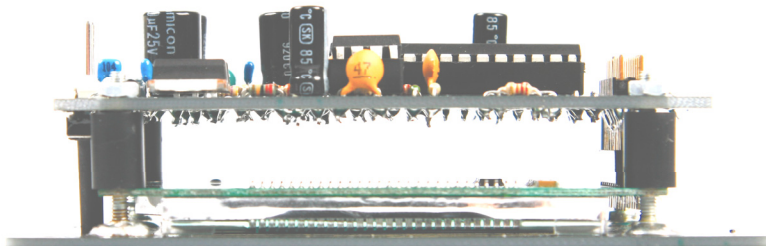

Fig.3

5. Now, fix the whole unit using the 4 nuts and remove the tape.



15. CONNECTION

Ex. "bridged" amplifier or high power radio

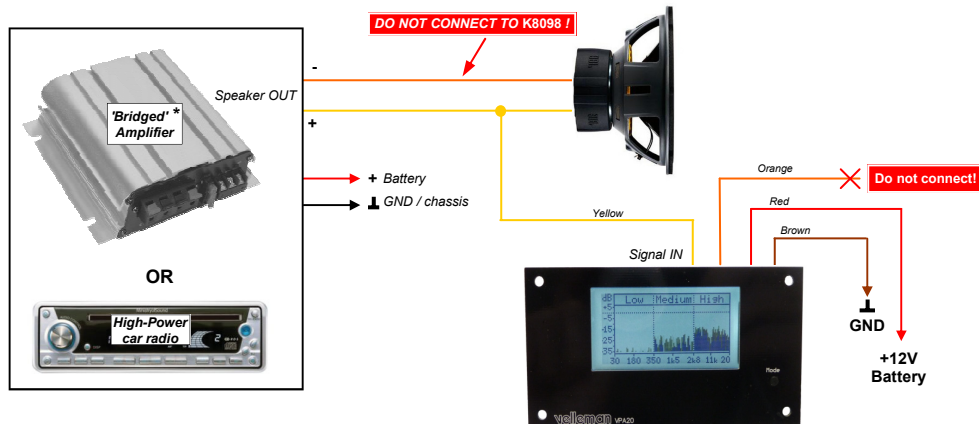

***Activate BRIDGED function in setup-menu !**

Ex. connected to speaker output

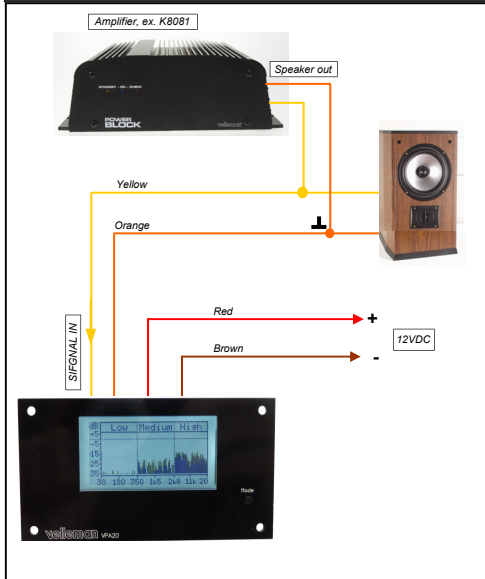

Ex. connected to LINE OUT

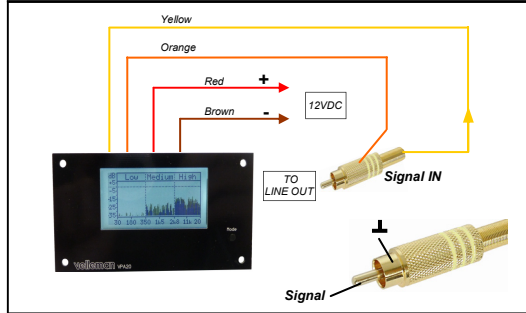

HINT for stereo connection

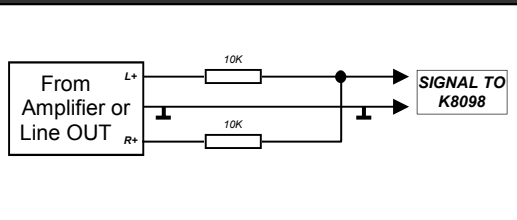

16. USE

Short press on the 'mode' button: selecting a meter-display.

Long press on the 'mode' button: opening the set-up menu.

Set-up menu

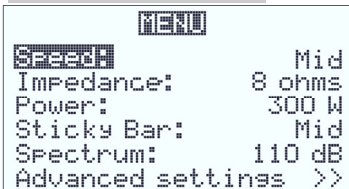

Access to the Set-up menu by a "long" push on the 'mode' button.

- **Short press:** changing settings
- **long press:** next function
- **Keep pressed:** save changes and exit

- **Speed:** refreshing the screen (Fast - Mid - Slow)
- **Impedance:** "2", "4" or "8" ohms for speaker output power calculation, in case the unit is connected to speaker output.
- **Power:** "AUTO" range or a maximum value that depends on the chosen impedance.
 - For impedance = 2: Possible choices are "1200 mW", "12W", "120W" or "1200W"
 - For impedance = 4: Possible choices are "600 mW", "6W", "60W" or "600W"
 - For impedance = 8: Possible choices are "300 mW", "3W", "30W" or "300W"
- **Sticky Bar:** "Yes" or "No"
When selected, small residual sticky bars appear also on the third octave spectrum screen.
- **Spectrum dB:** "dBU" or "110 dB". (110 dB stands for the "Power dB" display which can range from 80dB to 110dB max, depending on the selected Power range).
- **Advanced settings:** see pag. 10

Advanced settings

```
Language: English
Contrast: 6
Reverse Video: No
True mean: Yes
Bridge Amplifier: Yes
Demo: Fast
```

First open the set-up menu with a long press on the **'mode'** button and choose the mode "advanced settings".

- **Short press:** changing settings
- **long press:** next function
- **Keep pressed:** save changes and exit

- **Language:** UK / NL / FR / DE / ES
- **Contrast :** choose a contrast between 1 - 20
- **Reverse video:** normal or reverse display
- **True mean:** Yes or no.

If 'no' is selected then the display gives the integrated "peak values".

If a pure sine wave is used both values will be the same.

- **Bridge amplifier:** Turn on in case of in car use with high power radio or amplifier.
- **Demo:** showing the different screen layouts, you can choose (slow - fast - off)

17. Schematic diagram

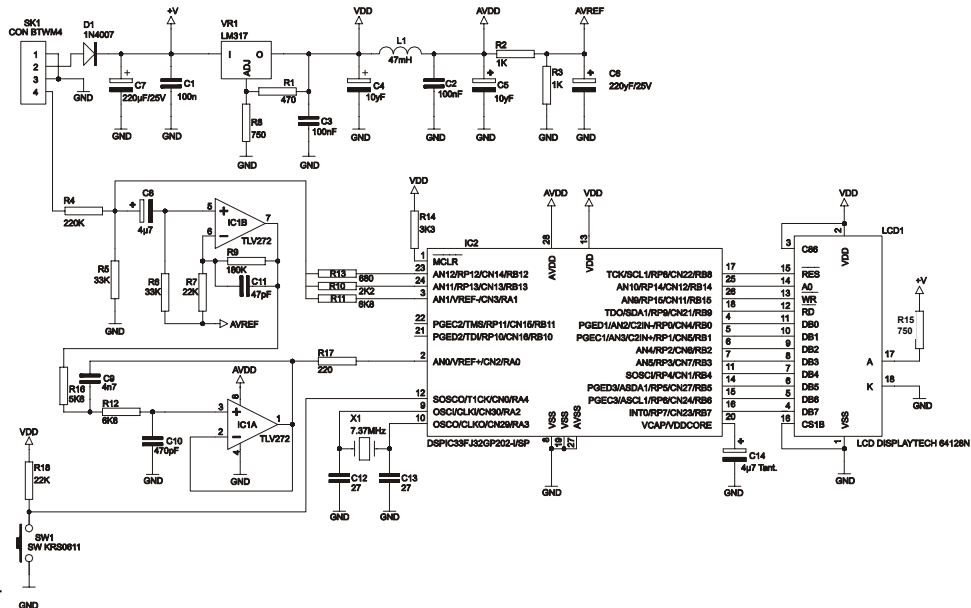

18. PCB

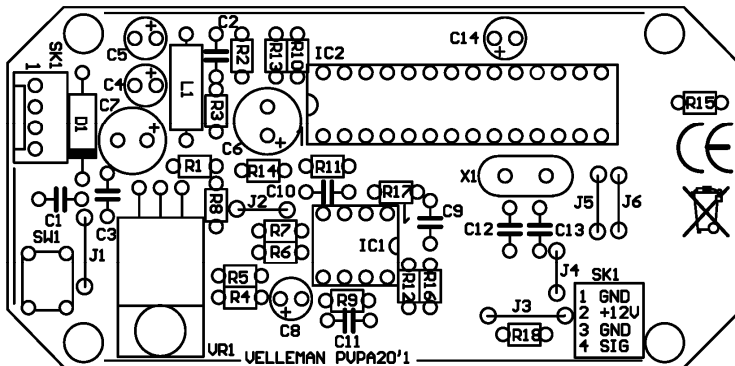

VELBUS
Velleman Home Automation System

VELBUS
Velleman Home Automation System

**All appliances get intelligent, how about your home?
see our website : www.velbus.be**

Modifications and typographical errors reserved
 © Velleman nv.
 H8098IP'1 - 2010

VELLEMAN NV
Legen Heirweg 33, 9890 Gavere
Belgium - Europe

