

1 Resistor - Weerstand - Résistance - Widerstand - Resistencia - Motstand - Vastus - Resistenze

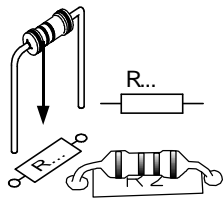

- ◊R1: 100K (Brown, Black, Yellow) -(Bruin, zwart, Geel) -(Brun, noir, Jaune) -(Braun, Schwarz, Gelb) -(Brun, Svart, Gul) -(Ruskea, Musta, Keltainen) -(Marron, Negro, Amarillo) -(Castanho, Preto, Amarelo) -(Marrone, Nero, Giallo)
- ◊R2: 100K (Orange, Orange, Orange) -(Oranje, Marron, Oranje) -(Oranssi, Oranssi, Oranssi) -(Naranjado, Naranjado, Naranjado) -(Laranja, Laranja, Laranja) -(Aranciato, Aranciato, Aranciato)
- ◊R3: 33K (Brown, Grey, Red) -(Bruin, Grijs, Rood) -(Brun, Gris, Rouge) -(Braun, Grau, Rot) -(Brun, Grau, Röd) -(Ruskea, Harmaa, Punainen) -(Marrón, Gris, Rojo) -(Castanho, Cinzento, Encarnado) -(Marrone, Grigio, Rosso)
- ◊R4: 1K8 (Orange, Orange, Red) -(Oranje, Oranje, Rood) -(Orange, Orange, Rouge) -(Orange, Orange, Rot) -(Orange, Orange, Röd) -(Punainen, Punainen, Punainen) -(Oranssi, Oranssi, Punainen) -(Naranjado, Naranjado, Rojo) -(Laranja, Laranja, Encarnado) -(Aranciato, Aranciato, Rosso)
- ◊R5: 1K8 (Orange, Orange, Red) -(Oranje, Oranje, Rood) -(Orange, Orange, Rouge) -(Orange, Orange, Rot) -(Orange, Orange, Röd) -(Punainen, Punainen, Punainen) -(Oranssi, Oranssi, Punainen) -(Naranjado, Naranjado, Rojo) -(Laranja, Laranja, Encarnado) -(Aranciato, Aranciato, Rosso)
- ◊R6: 3K3 (Red, Red, Red) -(Rood, Rood, Rood) -(Rouge, Rouge, Rouge) -(Rot, Rot, Rot) -(Röd, Röd, Röd) -(Punainen, Punainen, Punainen) -(Rojo, Rojo, Rojo) -(Encarnado, Encarnado, Encarnado) -(Rosso, Rosso, Rosso)

2 DIODE

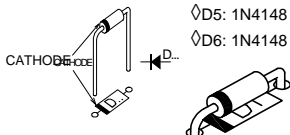

- ◊D1: 1N4148
- ◊D2: 1N4148
- ◊D3: 1N4148
- ◊D4: 1N4148
- ◊D5: 1N4148
- ◊D6: 1N4148

3 ZENER-DIODE

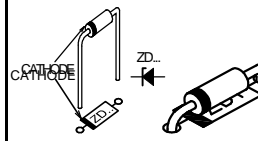

- ◊ ZD1: 2V7

4 LED



- ◊LD1: 3mm
 - ◊LD2: 3mm
 - ◊LD3: 3mm
 - ◊LD4: 3mm
 - ◊LD5: 3mm
 - ◊LD6: 3mm
 - ◊LD7: 3mm
- Watch the polarity!

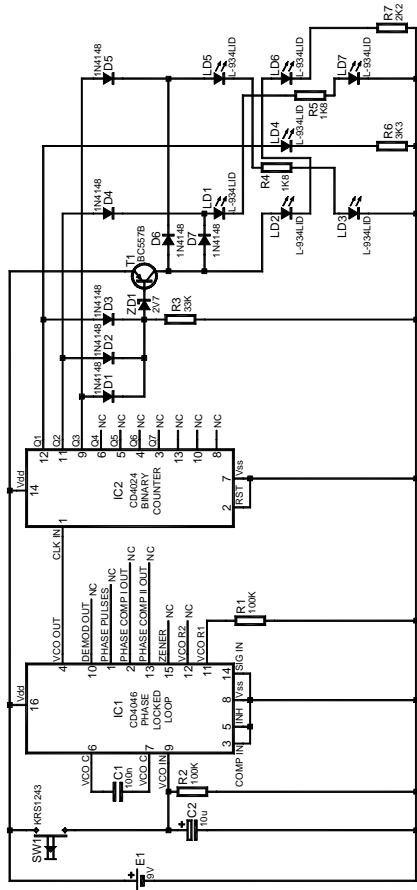

5 SW1

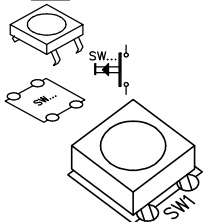

6 Capacitor

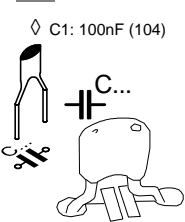

- ◊ C1: 100nF (104)

7 IC Socket - IC voet - Support de CI - IC Fuß - Soporito del CI - IC Sokkel - Mikropiirkanta - IC sokkel - Zoccolo IC

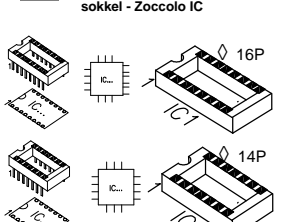

8 ELCO

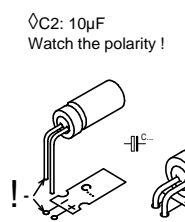

- ◊ C2: 10µF
- Watch the polarity!

9 Transistor

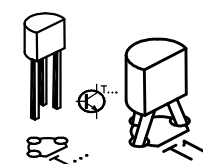

- ◊ T1: BC557

10 IC - CI

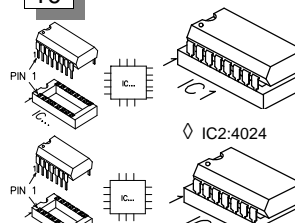

- ◊ IC1: 4046
- ◊ IC2: 4024

11

