

8 CHANNEL USB RELAY CARD

Use your computer USB port to connect to the outside world.

Total solder points: 363

Difficulty level: *beginner* 1 2 3 4 5 *advanced*

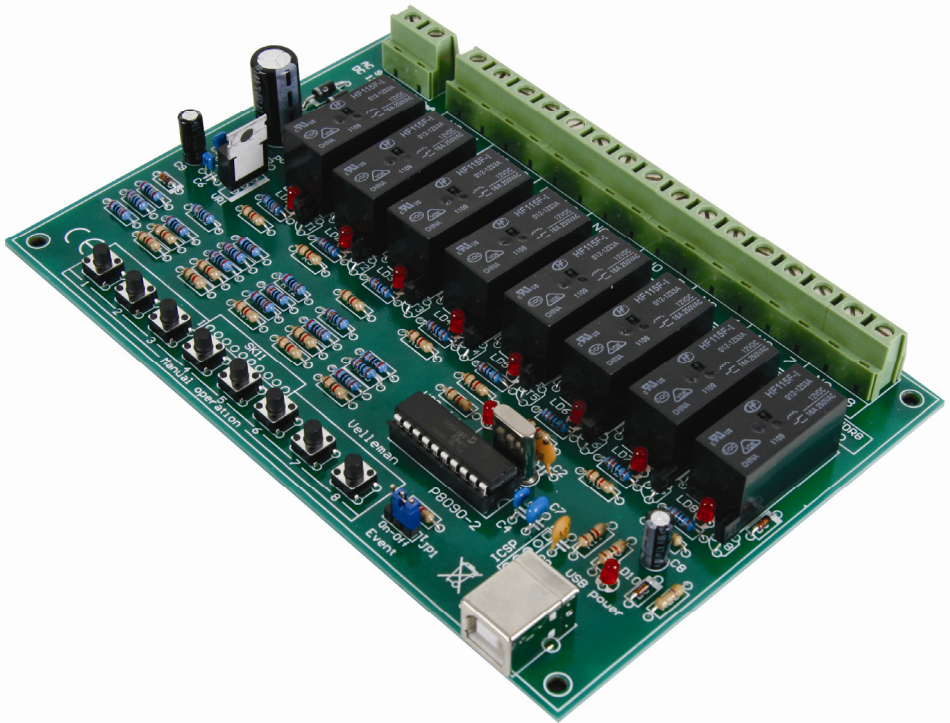

K8090

Eight relay channels controlled by your computer!

Use your computer USB port to connect to the outside world. Connect up to 16A to each of the high power relays. Board space for extra VDR noise suppressors is provided and on board push buttons can be used to test/operate all the relays.

Features

- ☑ USB-controlled relay card
- ☑ manual operation for toggle, momentary or timer operation (selectable through software)
- ☑ timer settings up to 18 hours (DLL function)
- ☑ optional open collector connectivity (push button simulation)
- ☑ event-driven and open protocol
- ☑ two way PC communication (USB Event return)
- ☑ LED indication for power and relay action

Optional VDR (type VDR300) transient suppression for use with inductive loads

minimum system requirements:

- ☑ PC running USB compatible Windows version
 - ☑ USB1.1 and USB2.0 full speed compatible
 - ☑ internet connection for software download
- ☞ optional DIN rail enclosure: [B8006](#) (Note: cut-out the USB connector)*

Specifications

- power supply for relays: 9-10Vac or 12 to 14Vdc (500mA)
- 8 high-power relays: 16A each (resistive load)
- dimensions: 160 x 107 x 30mm / 6.3 x 4.2 x 1.2



* If voltages > 30V are connected, then an enclosure must be used !

1. Assembly (Skipping this can lead to troubles !)

Ok, so we have your attention. These hints will help you to make this project successful. Read them carefully.

1.1 Make sure you have the right tools:

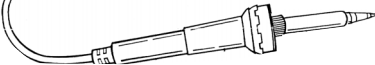
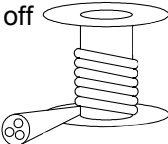
- A good quality soldering iron (25-40W) with a small tip. 
- Wipe it often on a wet sponge or cloth, to keep it clean; then apply solder to the tip, to give it a wet look. This is called 'thinning' and will protect the tip, and enables you to make good connections. When solder rolls off the tip, it needs cleaning.
- Thin raisin-core solder. Do not use any flux or grease. 
- A diagonal cutter to trim excess wires. To avoid injury when cutting excess leads, hold the lead so they cannot fly towards the eyes.
- Needle nose pliers, for bending leads, or to hold components in place.
- Small blade and Phillips screwdrivers. A basic range is fine.

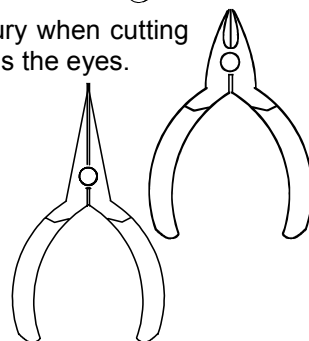

For some projects, a basic multi-meter is required, or might be handy

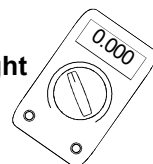

1.2 Assembly Hints :

- ⇒ Make sure the skill level matches your experience, to avoid disappointments.
- ⇒ Follow the instructions carefully. Read and understand the entire step before you perform each operation.
- ⇒ Perform the assembly in the correct order as stated in this manual
- ⇒ Position all parts on the PCB (Printed Circuit Board) as shown on the drawings.
- ⇒ Values on the circuit diagram are subject to changes.
- ⇒ Values in this assembly guide are correct*
- ⇒ Use the check-boxes to mark your progress.
- ⇒ Please read the included information on safety and customer service

* Typographical inaccuracies excluded. Always look for possible last minute manual updates, indicated as 'NOTE' on a separate leaflet.

1.3 Soldering Hints :

1- Mount the component against the PCB surface and carefully solder the leads

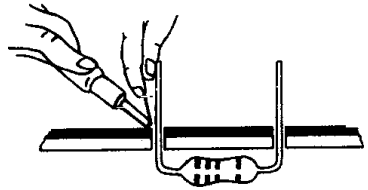

2- Make sure the solder joints are cone-shaped and shiny

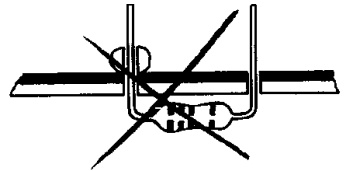
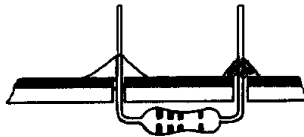

3- Trim excess leads as close as possible to the solder joint

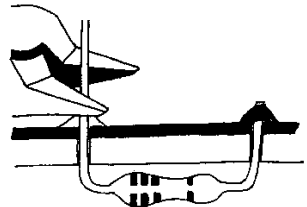

REMOVE THEM FROM THE TAPE ONE AT A TIME !

DO NOT BLINDLY FOLLOW THE ORDER OF THE COMPONENTS ONTO THE TAPE. ALWAYS CHECK THEIR VALUE ON THE PARTS LIST!

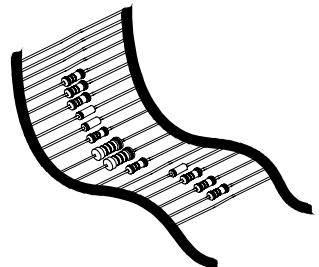

1. Diodes (check the polarity)

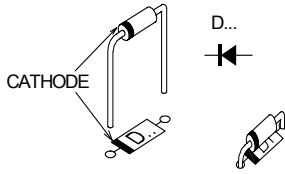

- D1 ... D10 : 1N4148
- D11 ... D14 : 1N4007

2. Resistors.

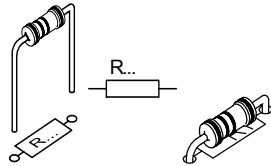

- R1 ... R21 : 1K (1-0-2-B)
- R22 : 4.7 (4-7-B-B)
- R23 ... R36 : 100K (1-0-0-3-1)
- R37 ... R46 : 200K (2-0-0-3-1)

3. IC socket. Watch the position of the notch!

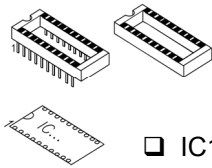

- IC1 : 20p

4. Capacitors

- C1, C2 : 22pF (22)
- C3 : 10nF (103)
- C4 ... C6 : 100nF (104)
- C7 : 470nF (474)

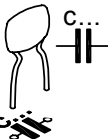

5. Push button

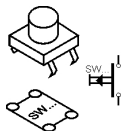

- SW1 ... SW8
(channel 1 to 8)

6. LEDs. Watch the polarity!

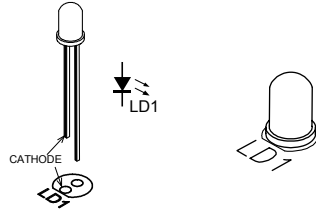

- LD1 ... LD11 : 3mm RED

- LD1 ... LD8 : Output indication
- LD9 : USB DATA
- LD10 : USB power indication
- LD11 : Relay power indication

7. Transistors

- T1
- T2
- T3
- T4
- T5
- T6
- T7
- T8

BC547B

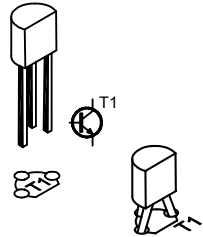

8. USB connector

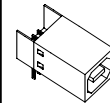

- SK10 : B - female



9. Pinheader



3pins:

- JP1 : event

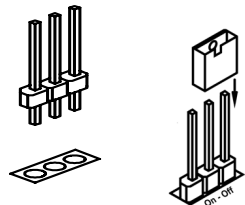

Set event jumper default to Off.

10. Terminal blocks

□ SK1 : 2p power supply

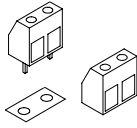

□ SK2 ... SK9 : 2p (channels 1 ... 8)

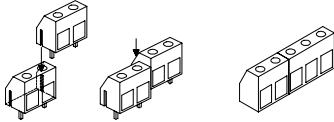

11. Electrolytic capacitors. Watch the polarity !

□ C8, C9: 4,7µF

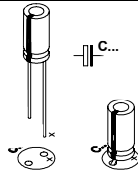

12. Quartz crystal

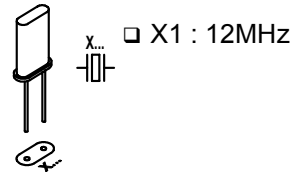

13. Voltage regulator

□ VR1 : UA7805

☞ Check the orientation !

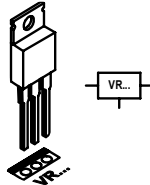

14. Electrolytic capacitor. Watch the polarity !

□ C10 : 1000µF

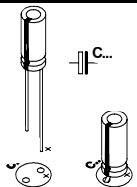

15. Relays

- RY1
- RY2
- RY3
- RY4
- RY5
- RY6
- RY7
- RY8

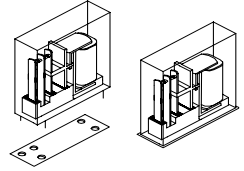

☞ Important : Put an extra layer of solder on all pre-thinned PCB tracks, to improve their current handling capabilities.

16. IC. Watch the position of the notch!

□ IC1 : VK8090

programmed PIC18F14K50-I/P or eq.

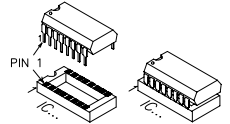

17. Rubber feet

Mount the rubber feet on the solder side of the PCB if you do not mount the kit into an DIN rail enclosure.

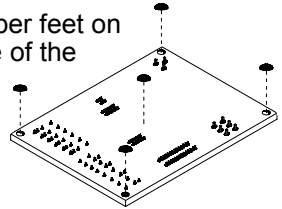

18. Open collector input (optional)

Connection diagram for use with an open-collector system.

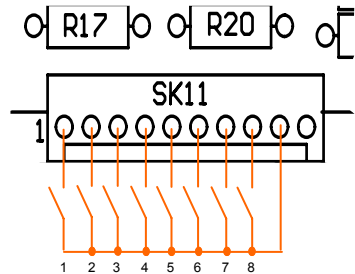

19. Test and connection

The card uses a separate supply for the relays and one for the board microcontroller.

Test 1:

- Connect a power supply of 9 to 10Vac or 12 to 14Vdc (minimum 500mA).
- The power LED should turn on.
- The USB power LED will also turn on (indicating that the microprocessor power is ON).
- Push the buttons and the relays should activate.

Test 2:

- Disconnect the power supply.
- Connect the USB port to the PC.
- The USB power LED should turn on.
- Pressing the buttons will make the output indicator LEDs turn on, but the relays will not activate.

Now the card can be used with all connections.

It is possible to power the card through USB only, but the relays will not activate.

The relay indicator LEDs will work fine.

This mode can be used for software testing.

Check our web site to download more program examples.

PCB

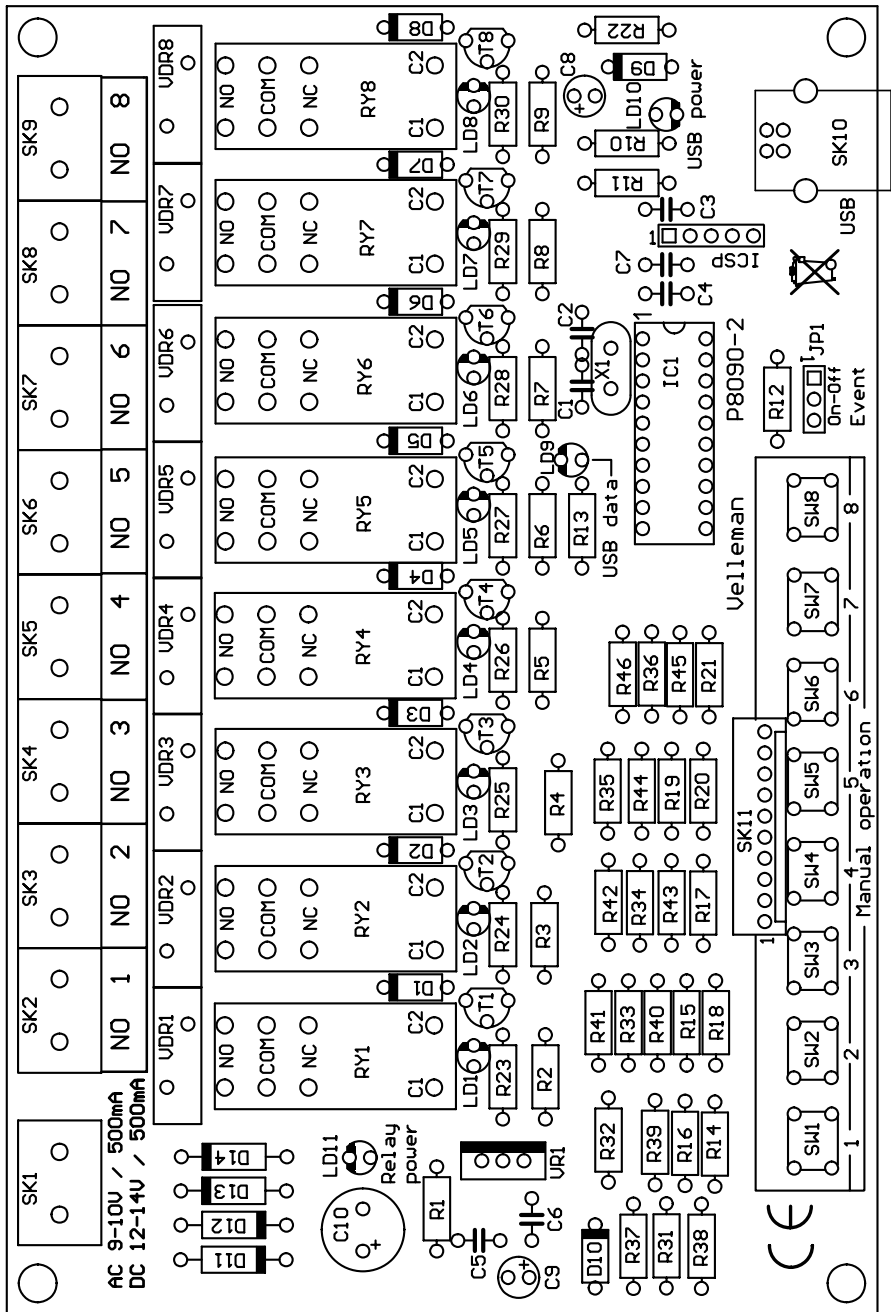

Schematic diagram

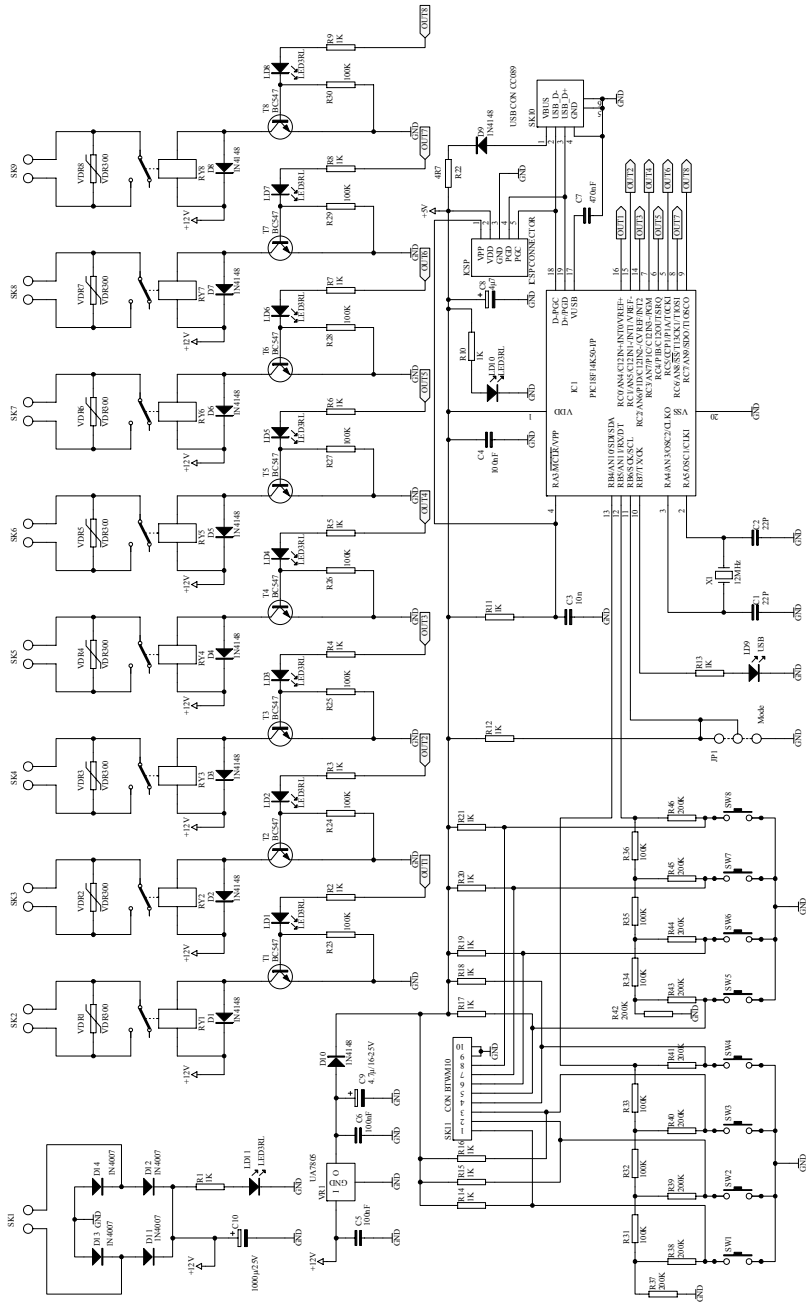

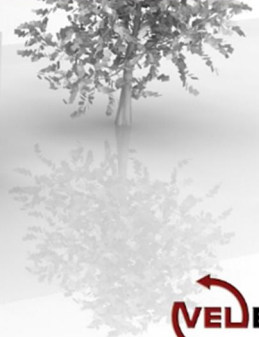

Velleman Home Automation System

**All appliances get intelligent, how about your home?
see our website : www.velbus.be**

**VELLEMAN NV
Legen Heirweg 33
9890 Gavere
Belgium Europe
Info ? : <http://www.velleman.be>**

Modifications and typographical errors reserved
© Velleman nv
H8090IP - 2010



5410329412050