

Total solder points: 293  
Difficulty level:  
beginner 1  2  3  4  5  advanced

HIGH-Q  
**velleman-kit** 

## 12V, Ten channel light effect generator

### Features:

# K8044

- Ten, 12V/400mA outputs.
- To control cold-cathode fluorescent lamps (using FLPS adapter), light bulbs, LED's and "solid state" relays, ...
- For use as advertisement lighting, party lights, discos, eye-catcher,...
- Ten pre-programmed light patterns selectable with a push button.
- The number of used channels is adjustable.
- Adjustable speed.
- Led indication for every output.
- 12V operation possible for use in cars.

### Specifications :

- Power supply : 12V DC
- Outputs : 12V DC/400mA per channel (Total : max 4A)
- Dimensions : 140 x 100 x 27mm / 5,5 x 3,9 x 1,1"

### Options (Velleman ordernumbers) :

- ✓ Power supply for cold-cathode fluorescent lamps : FLPS (300mm) or FLPS1 (100mm)
- ✓ Cold-cathode fluorescent lamps : FL(xx) – (100 or 300mm).

Modifications reserved.



---

velleman



**VELLEMAN Components NV**  
Legen Heirweg 33  
9890 Gavere  
Belgium Europe  
[www.velleman.be](http://www.velleman.be)  
[www.velleman-kit.com](http://www.velleman-kit.com)



**1. Assembly (Skipping this can lead to troubles !)**

Ok, so we have your attention. These hints will help you to make this project successful. Read them carefully.

**1.1 Make sure you have the right tools:**

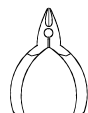
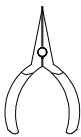
- A good quality soldering iron (25-40W) with a small tip. 
- Wipe it often on a wet sponge or cloth, to keep it clean; then apply solder to the tip, to give it a wet look. This is called 'thinning' and will protect the tip, and enables you to make good connections.  When solder rolls off the tip, it needs cleaning.
- Thin rosin-core solder. Do not use any flux or grease.  
- A diagonal cutter to trim excess wires. To avoid injury when cutting excess leads, hold the lead so they cannot fly towards the eyes.
- Needle nose pliers, for bending leads, or to hold components in place.
- Small blade and Phillips screwdrivers. A basic range is fine.



**For some projects, a basic multi-meter is required, or might be handy**

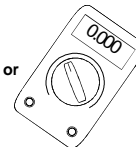

**1.2 Assembly Hints :**

- ⇒ Make sure the skill level matches your experience, to avoid disappointments.
- ⇒ Follow the instructions carefully. Read and understand the entire step before you perform each operation.
- ⇒ Perform the assembly in the correct order as stated in this manual
- ⇒ Position all parts on the PCB (Printed Circuit Board) as shown on the drawings.
- ⇒ Values on the circuit diagram are subject to changes.
- ⇒ Values in this assembly guide are correct\*
- ⇒ Use the check-boxes to mark your progress.
- ⇒ Please read the included information on safety and customer service

\* Typographical inaccuracies excluded. Always look for possible last minute manual updates, indicated as 'NOTE' on a separate leaflet.



**1.3 Soldering Hints :**

Mount the component against the PCB surface and carefully solder the leads

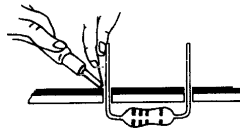

Make sure the solder joints are cone-shaped and shiny

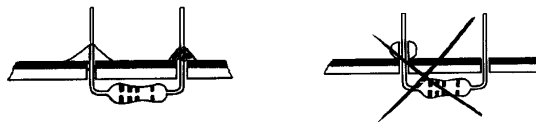

Trim excess leads as close as possible to the solder joint

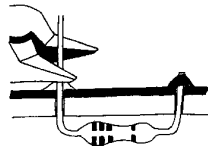

**AXIAL COMPONENTS ARE TAPED IN THE CORRECT MOUNTING SEQUENCE !**

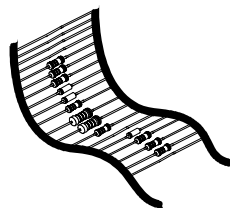

REMOVE THEM FROM THE TAPE  
ONE AT A TIME !



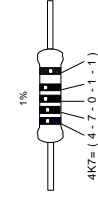
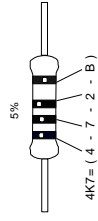

	I	P	E	SF	S	DK	N	D	GB	F	NL
C O D E	CODICE DE CORES	CODIGO DE CORES	VÄRI KOODI	FÄRG SCHEMA	FÄRVE- KODE	FARGE- KODE	FARB KODE	COLOUR CODE	CODIFI- CATION DES COU- LEURS	KLEUR KODE	COLORE KODE
0	Nero	Negro	Musta	Svart	Sort	Sort	Schwarz	Black	Noir	Zwart	0
1	Marrone	Castanho	Ruskea	Brun	Brun	Brun	Braun	Brown	Brun	Bruin	1
2	Rosso	Encarnado Rojo	Punainen	Röd	Röd	Röd	Rot	Red	Rouge	Rood	2
3	Aranciato	Laranja	Narancjato	Oranssi	Orange	Orange	Orange	Orange	Orange	Oranje	3
4	Giallo	Amarillo	Keltainen	Gul	Gul	Gul	Gelb	Yellow	Jaune	Geel	4
5	Verde	Verde	Vihreä	Grön	Grön	Grön	Grün	Green	Vert	Groen	5
6	Blu	Azul	Sininen	Blå	Blå	Blå	Blau	Blue	Bleu	Blauw	6
7	Violeta	Morado	Purppura	Lila	Violet	Violet	Violet	Purple	Violet	Paars	7
8	Grigio	Cinzeno	Gris	Harmaa	Grå	Grå	Grau	Grey	Gris	Grijs	8
9	Bianco	Bianco	Valkoinen	Vit	Hvidt	Hvidt	Weiss	White	Blanc	Wit	9
A	Argento	Prateado	Hopea	Silver	Sølv	Sølv	Silber	Silver	Argent	Zilver	A
B	Oro	Dourado	Oro	Kulta	Guld	Guld	Gold	Gold	Or	Goud	B

**1. Jumper**

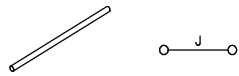

- CH... : depending on the number of channels
- RX '\*'

'\*' **ATTENTION** : In case you use light bulbs, Cold-Cathode fluorescent lamps & "solid-state" relays mount for RX a jumper wire. If using LED's as output indication then mount for RX a resistor appropriated to the value of the LED. See step 2.

**2. Resistors 'RX'**

- RX (for each output)

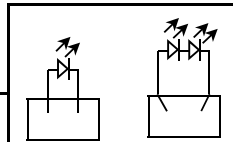
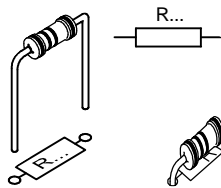

Type of LED	1K	820
Standard (Red) ○	○	○
White	<b>470</b>	<b>330</b>
Yellow / Green	<b>1K</b>	<b>820</b>
Blue	<b>470</b>	<b>390</b>



These resistors are not supplied whit this kit!

**3. Resistors**

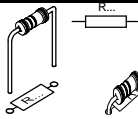

- R1 : 10K (1-0-3-B)
- R2 : 10K (1-0-3-B)
- R3 : 10K (1-0-3-B)
- R4 : 10K (1-0-3-B)
- R5 : 10K (1-0-3-B)
- R6 : 10K (1-0-3-B)
- R7 : 10K (1-0-3-B)
- R8 : 10K (1-0-3-B)
- R9 : 10K (1-0-3-B)
- R10: 10K (1-0-3-B)
- R11: 270 (2-7-1-B)
- R12: 270 (2-7-1-B)
- R13: 270 (2-7-1-B)
- R14: 270 (2-7-1-B)
- R15: 270 (2-7-1-B)
- R16: 270 (2-7-1-B)
- R17: 270 (2-7-1-B)
- R18: 270 (2-7-1-B)
- R19: 270 (2-7-1-B)
- R20: 270 (2-7-1-B)
- R21: 4K7 (4-7-2-B)
- R22: 4K7 (4-7-2-B)
- R23: 4K7 (4-7-2-B)
- R24: 4K7 (4-7-2-B)
- R25: 4K7 (4-7-2-B)
- R26: 4K7 (4-7-2-B)
- R27: 4K7 (4-7-2-B)
- R28: 4K7 (4-7-2-B)
- R29: 4K7 (4-7-2-B)

- R30: 4K7 (4-7-2-B)
- R31: 47 (4-7-0-B)
- R32: 3K3 (3-3-2-B)
- R33: 10K (1-0-3-B)
- R34: 10K (1-0-3-B)
- R35: 10K (1-0-3-B)
- R36: 330 (3-3-1-B)

**4. Diodes. Watch the polarity !**

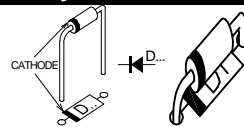

- D1 : 1N4007
- D2 : 1N4007
- D3 : 1N4007
- D4 : 1N4007
- D5 : 1N4007
- D6 : 1N4007
- D7 : 1N4007
- D8 : 1N4007
- D9 : 1N4007
- D10: 1N4007
- D11: 1N4007
- D12: 1N5404

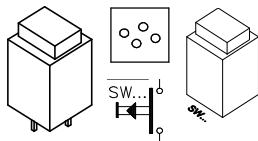
**5. Pushbuttons.**

- SW1 : S500
- SW2 : S500

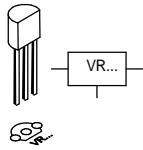
**6. Voltage Regulator.**

- VR1: UA78L05

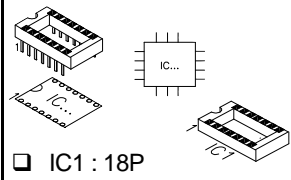
**7. IC socket, Watch the position of the notch!**

- IC1 : 18P

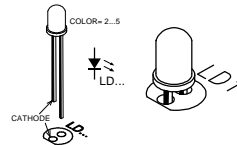
**8. LED. Watch the polarity !**

- LD1 : 5mm Red
- LD2 : 5mm Red
- LD3 : 5mm Red
- LD4 : 5mm Red
- LD5 : 5mm Red
- LD6 : 5mm Red
- LD7 : 5mm Red
- LD8 : 5mm Red
- LD9 : 5mm Red
- LD10 : 5mm Red
- LD11 : 5mm Red

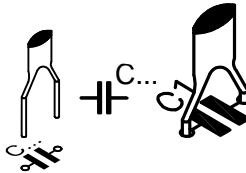
**9. Ceramic Capacitors**

- C2 : 100nF (104)
- C4 : 100nF (104)
- C6 : 100nF (104)
- C7 : 100pF (101)



**10. Transistors.**

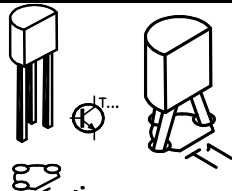

- T1 : BC640
- T2 : BC640
- T3 : BC640
- T4 : BC640
- T5 : BC640
- T6 : BC640
- T7 : BC640
- T8 : BC640
- T9 : BC640
- T10 : BC640
- T11 : BC547B
- T12 : BC547B
- T13 : BC547B
- T14 : BC547B
- T15 : BC547B
- T16 : BC547B
- T17 : BC547B
- T18 : BC547B
- T19 : BC547B
- T20 : BC547B

**11. Electrolytic capacitors.**  
Watch the polarity !

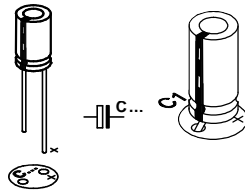

- C5 : 10 $\mu$ F
- C3 : 220 $\mu$ F
- C1 : 1000 $\mu$ F / 25V

**12. Trim potentiometer**

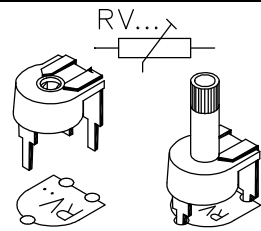

- RV1 : 100K

**13. Terminal block connectors**

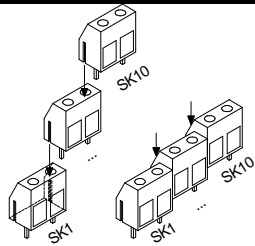

- SK1 : CH1 (2p)
- SK2 : CH2 (2p)
- SK3 : CH3 (2p)
- SK4 : CH4 (2p)
- SK5 : CH5 (2p)
- SK6 : CH6 (2p)
- SK7 : CH7 (2p)
- SK8 : CH8 (2p)
- SK9 : CH9 (2p)
- SK10 : CH10 (2p)

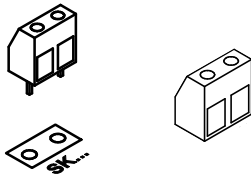

- SK11 : 2p

**14. Fuseholder + Fuse**

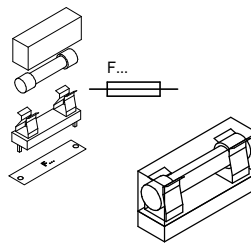

- F1 : 4A (slow)

**15. IC, Check the position of the notch !**

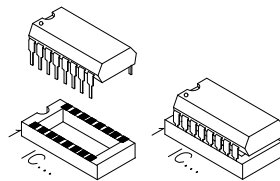

- IC1: VK8044  
Programmed PIC16C58B-20

16. Hook-up diagram

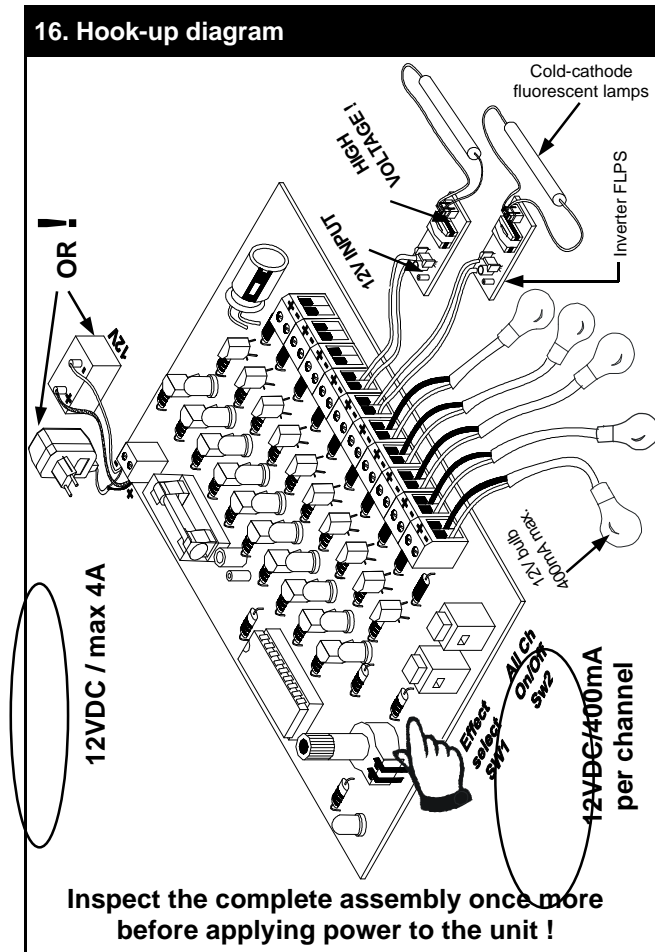

## 17. Use

Connect this kit according to the wiring diagram. LED LD1 will light if the operating voltage is correct. Take all necessary precautions to avoid electroshocks when connecting cold-cathode fluorescent lamps : the inverter 'FLPS1' uses a potentially life-threatening voltage.



This kit is available in various countries. Take care to use an appropriate connection or adapter.

### Selecting a light effect :

Push button SW1 'Effect select' allows you to choose one of ten available programmes. Hold SW1 to see which effect is currently selected : the LED of that effect will light. The light effect will start running when you release SW1. Press SW1 momentarily to select the next light effect. SW2 enables you to activate or deactivate all channels. Press SW1 to restart the selected light effect.

Adjust the speed of the running light with RV1



The connection cables should be equipped with an appropriate strain relief when mounted in a movable housing.



### Random light effect :

Hold SW2 pressed before connecting the power supply (the other light patterns shall not work!).



### Number of connected channels :



Mount a jumper wire on the spot that matches the amount of light channels you would like to use. This will make some light effects adjust to the number of channels used.

*Example* : Mount a jumper wire on 5 CH if you wish to use 5 light channels.

18. PCB layout.

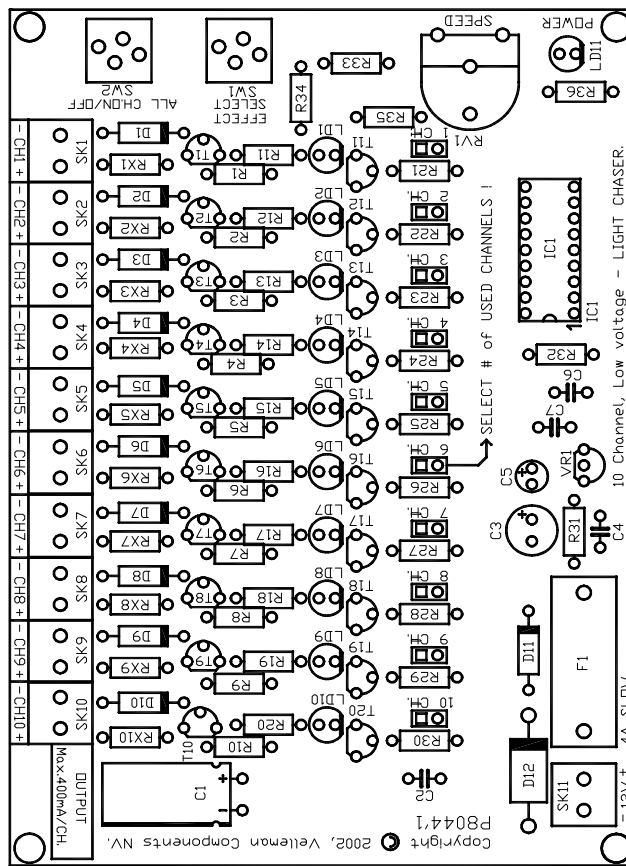

19. Schematic diagram.

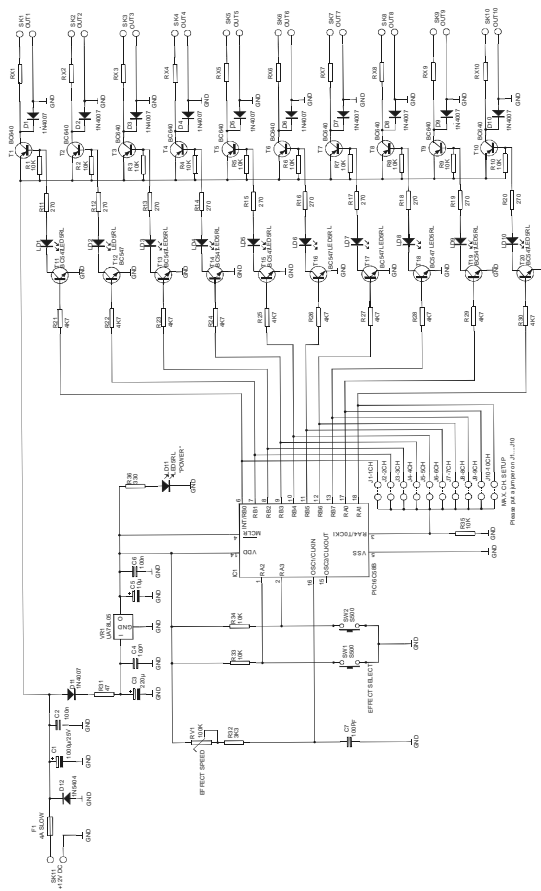





velleman

**VELLEMAN Components NV**  
**Legen Heirweg 33**  
**9890 Gavere**  
**Belgium Europe**  
**[www.velleman.be](http://www.velleman.be)**  
**[www.velleman-kit.com](http://www.velleman-kit.com)**

Modifications and typographical errors reserved  
© Velleman Components nv.  
H8044IP - 2002 - ED1

