

PROCESSOR

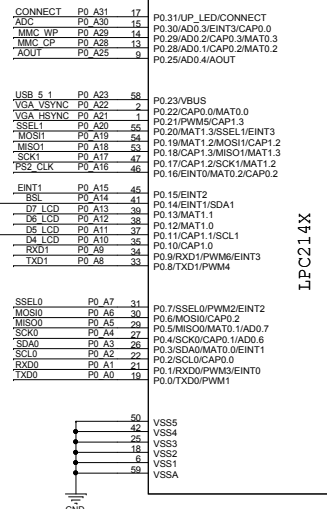

LPC214X

LPC214X

DECAPS FOR LPC2148

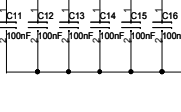

KEYBOARD CONNECTOR

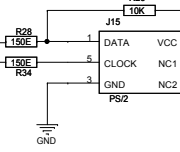

USER INTERFACE

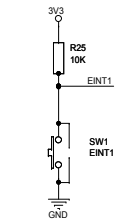

AUDIO INTERFACE

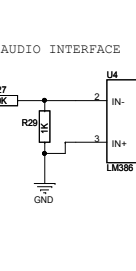

POWER CIRCUIT

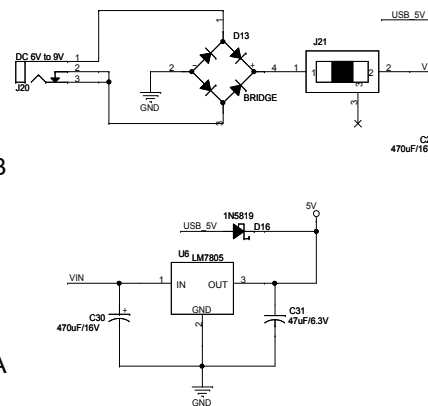

I2C SERIAL EEPROM

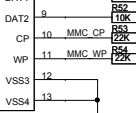

BUZZER

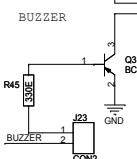

RESET AND ROOT LOADER SELECT CIRCUIT

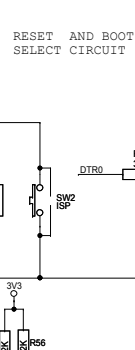

USB SECTION

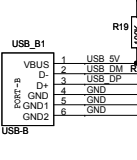

VGA INTERFACE

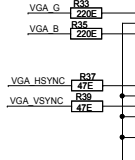

LCD

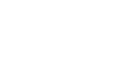

CONNECTIONS

