

- Digilent Inc.
- ROHS
- Chinese ROHS
- chipKIT
- Network Shield

chipKIT™

# Network Shield

Title	Network Shield		Rev	D.0
Circuit	CAN, Ethernet, USB		Copyright	2011
Doc#	500-211			
Engineer	NEA			
Author	GMA, CLG			
Date	5/18/2011			
Sheet#	01 out of 02			



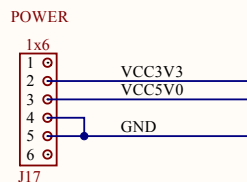
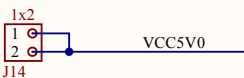
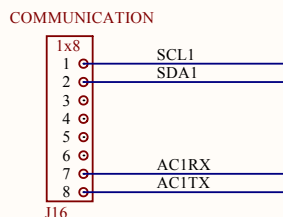
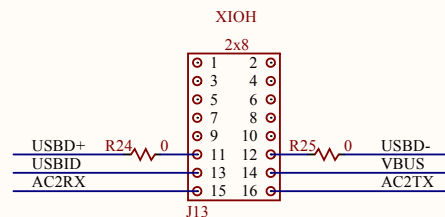
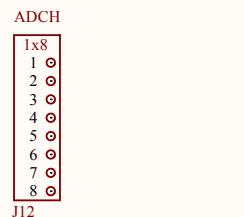
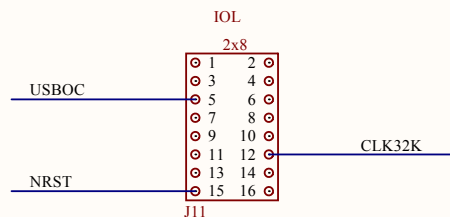
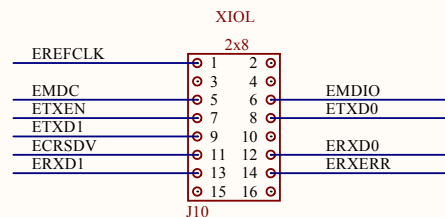
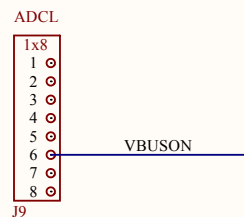
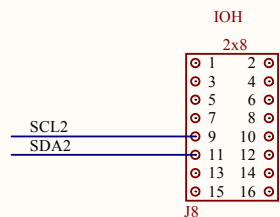
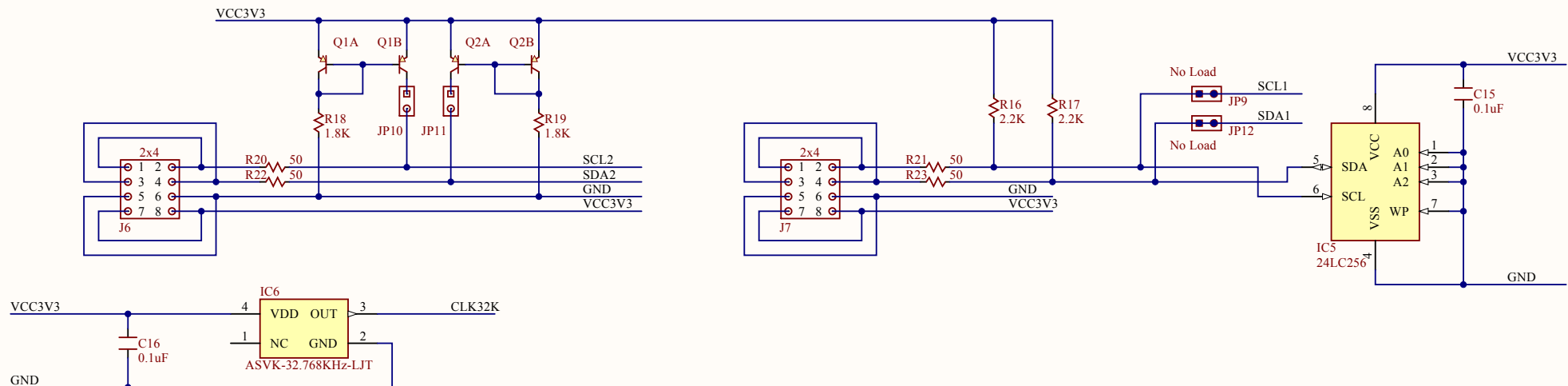

chipKIT™

Title  
**Network Shield**

Rev  
**D.0**  
Copyright 2011

Circuit  
I2C, Connectors

Doc#  
500-211

Engineer  
NEA

Author  
GMA, CLG

Date  
5/18/2011

Sheet# 02 out of 02

