

# Approval Sheet

## (產品承認書)

產品名稱 (Product):	BLE AT Command Module
	in <b>Peripheral / Slave</b> role
解決方案 (Solution):	Nordic nRF52805
產品型號 (Model No.):	<b>MDBT42TV</b> – AT (Chip Antenna)
	<b>MDBT42TV</b> – <b>PAT</b> (PCB Antenna)
韌體版本 (FW Revision):	1.0

### *Advantage of MDBT42TV & MDBT42TV-P series:*

- Long working distance under 1 Mbps:*  
**MDBT42TV:** over 80 meters in open space.  
**MDBT42TV-P:** up to 60 meters in open space.
- Declaration ID includes all Nordic applied profiles.*
- Granted main regional certification such as FCC (USA), CE(EU)  
TELEC (Japan), SRRC (China), IC (Canada), NCC (Taiwan), and KC (South Korea)*

# Index

<b>1. Overall Introduction</b>	<b>4</b>
<b>2. AT Command</b>	<b>4</b>
2.1. List of supported commands	4
2.2. AT Command Sets	5
2.3. Default Info	11
2.4. Pin Assignment	12
<b>3. How to Control via External MCU</b>	<b>13</b>
3.1. How to Send AT Commands	13
3.2. How to Transmit Data	14
3.3. How to Return to the Setting of Default Flash	14
<b>4. Test Report</b>	<b>15</b>
4.1. Current Test	15
4.2. Throughput Test	16
<b>5. Product Dimension</b>	<b>18</b>
5.1. PCB Dimensions & Pin Indication	18
5.2. Recommended Layout of Solder Pad	20
5.3. RF Layout Suggestion (aka Keep-Out Area)	22
5.4. Footprint & Design Guide	24
<b>6. Main Chip Solution</b>	<b>25</b>
<b>7. Shipment Packaging Information</b>	<b>25</b>
7.1. Marking on Metal Shield	26
7.2. Packaging Info	26
7.2.1. Tray Packaging	26
<b>8. Specification</b>	<b>27</b>
8.1. Absolute Maximum Ratings	27
8.2. Operation Conditions	27
8.3. Electrical Specifications	28
<b>9. Antenna</b>	<b>33</b>
9.1. MDBT42TV Series	33
9.2. MDBT42TV-P Series	34
<b>10. Reference Circuit</b>	<b>35</b>

<b>11. Certification .....</b>	<b>36</b>
11.1. Declaration ID .....	36
11.2. FCC Certificate (USA) .....	37
11.3. TELEC Certificate (Japan).....	38
11.4. NCC Certificate (Taiwan) .....	39
11.5. CE (EU) & RCM (Australia & New Zealand) Test Report.....	41
11.6. IC Certificate (Canada).....	43
11.7. SRRC Certificate (China).....	44
11.8. KC Certificate (South Korea) .....	45
11.9. RoHS & REACH Report .....	46
11.10. End-Product Label .....	46
<b>12. Notes and Cautions.....</b>	<b>48</b>
<b>13. Basic Facts for nRF52 Chip.....</b>	<b>49</b>
<b>14. Useful Links .....</b>	<b>50</b>
<b>History of Firmware Revision .....</b>	<b>51</b>
<b>Full List of Raytac's BLE Modules .....</b>	<b>52</b>
<b>Release Note.....</b>	<b>56</b>

# 1. Overall Introduction

Raytac's MDBT42TV-AT & MDBT42TV-PAT is a BT 5.1 stack (Bluetooth low energy or BLE) module designed based on **Nordic nRF52805 SoC solution**, which incorporates: **UART** interface in only peripheral/slave role for data bridge in compact size **(L) 8.3 x (W) 5.8 x (H) 1.3 mm**.

## 2. AT Command

### 2.1. List of supported commands

- Setting of device name
- Choose data rate of 1 Mbps or 2 Mbps on-air
- Set TX output power in 5 levels.
- Set advertising time
- Set connection interval under Mode 2
- Enable/disable advertising
- 7 sets of UART baud rates
- Enable/disable UART flow control
- Enable/disable interface of UART hardware
- Power-down mode for power saving and GPIO wake-up
- Support DC-to-DC and LDO power mode
- Use internal or external 32.768 KHz oscillator
- Recover-to-default setting with hardware and software method
- System reset of hardware and software
- Set serial number and retrieve
- Set or retrieve MAC Address
- Retrieve ADC value for battery detection, delivering the information through battery service.
- Support maximum MTU 247bytes / data payload up to maximum 244 bytes

## 2.2. AT Command Sets

### 2.2.1. "Write" Commands

No.	Command	Description
(1)	<b>AT+NAME</b>	Set device name,Max. length of 20 characters e.g. AT+NAME123 (device name 123, 3 characters)
(2)	<b>AT+RESET</b>	Set to reset system
(3)	<b>AT+ADVSTART</b>	Set to start advertising
(4)	<b>AT+ADVSTOP</b>	Set to stop advertising
(5)	<b>AT+SLEEP</b>	Set to get into deep sleep mode
(6)	<b>AT+BAUDRATE9600</b>	Set UART baud rate at 9600 bps,n,8,1
(7)	<b>AT+BAUDRATE19200</b>	Set UART baud rate at 19200 bps,n,8,1
(8)	<b>AT+BAUDRATE38400</b>	Set UART baud rate at 38400 bps,n,8,1
(9)	<b>AT+BAUDRATE57600</b>	Set UART baud rate at 57600 bps,n,8,1
(10)	<b>AT+BAUDRATE115200</b>	Set UART baud rate at 115200 bps,n,8,1
(11)	<b>AT+BAUDRATE230400</b>	Set UART baud rate at 230400 bps,n,8,1 <b>(recommended enabling flow control)</b>
(12)	<b>AT+BAUDRATE460800</b>	Set UART baud rate at 460800 bps,n,8,1 <b>(recommended enabling flow control)</b>
(13)	<b>AT+FLOWCONTROLDIS</b>	Disable UART flow control
(14)	<b>AT+FLOWCONTROLEN</b>	Enable UART flow control
(15)	<b>AT+TXPOWER4DBM</b>	Set RF TX power at + 4dBm
(16)	<b>AT+TXPOWER0DBM</b>	Set RF TX power at 0dBm
(17)	<b>AT+TXPOWER-4DBM</b>	Set RF TX power at - 4dBm
(18)	<b>AT+TXPOWER-8DBM</b>	Set RF TX power at - 8dBm
(19)	<b>AT+TXPOWER-20DBM</b>	Set RF TX power to - 20dBm
(20)	<b>AT+XTALINTERNAL</b>	Use internal RC 32.768KHZ low frequency oscillator
(21)	<b>AT+XTALEXTERNAL</b>	Use external crystal 32.768KHZ low frequency oscillator
(22)	<b>AT+CONNECTINDICATORLOW</b>	Set logic low output when connecting BT
(23)	<b>AT+CONNECTINDICATORHIGH</b>	Set logic high output when connecting BT
(24)	<b>AT+PHYMODE1MBPS</b>	Set PHY mode at 1Mbps

No.	Command	Description
(25)	AT+PHYMODE2MBPS	Set PHY mode at 2Mbps
(26)	AT+WAKEUPLOW	Set logic low at wake-up when in deep sleep
(27)	AT+WAKEUPHIGH	Set logic high at wake-up when in deep sleep
(28)	AT+ADVTIMEtttt	Set advertising time (Hex) e.g. 0x001E (min. 30secs), 0x0E10 (Max. 3,600secs) 0x0000 (forever)
(29)	AT+DCDCDIS	Disable DC to DC converter
(30)	AT+DCDCEN	Enable DC to DC converter
(31)	AT+CONNECTINTERVALMODE0	Set connection interval mode for iOS/Android APP usage (min. 20ms / Max. 40ms),
(32)	AT+CONNECTINTERVALMODE1	Set connection interval mode for nRF52832 Central usage (min. 8ms / Max. 8ms)
(33)	AT+CONNECTINTERVALMODE2	Set connection interval mode for iOS/Android APP usage (programmable: min. / Max. range is 8ms ~ 1,000ms)
(34)	AT+CONNECTINTERVALTIMEttttttt	Set connection interval time ( <b>Hex</b> ), available when activating "AT+CONNECTINTERVALMODE2" e.g. 0x0008 (8ms), 0x03E8 (1,000ms), conditions to be met: "min. connection interval ≤ Max. connection interval"

No.	Command	Description
(35)	AT+SERIALNOnnnnnnnn	Set serial number e.g. AB000001, fixed 8-character length
(36)	AT+RESPONSEDIS	Disable response when sending "write" command
(37)	AT+RESPONSEEN	Enable response when sending "write" command
(38)	AT+DISCONNECT	Terminate the connection
(39)	AT+DEFAULT	Back to default
(40)	AT+MACADDRnnnnnnnnnnnn	Set IC MAC address, where n is <b>Hex</b> . Written order is from MSB byte to LSB byte.

**\*\*\* Important \*\*\***

**Flow control function cannot be activated when using external 32.768 KHz crystal oscillator. A "fail" response will return.**

	Status of Flow Control	
	Disable	Enable
Internal RC oscillator	√	√
External crystal oscillator	√	fail

## 2.2.2. “Read” Commands

No.	Command	Description
(1)	<b>AT?NAME</b>	To retrieve device name
(2)	<b>AT?VERSION</b>	To retrieve firmware version
(3)	<b>AT?MACADDR</b>	To retrieve IC MAC address
(4)	<b>AT?BAUDRATE</b>	To retrieve current UART baud rate
(5)	<b>AT?FLOWCONTROL</b>	To retrieve UART status of flow control
(6)	<b>AT?TXPOWER</b>	To retrieve RF TX power
(7)	<b>AT?XTAL</b>	To retrieve status of oscillator
(8)	<b>AT?CONNECTINDICATOR</b>	To retrieve logic of pin for BT-connecting indicator
(9)	<b>AT?PHYMODE</b>	To retrieve status of PHY mode
(10)	<b>AT?WAKEUP</b>	To retrieve logic of wake-up pin
(11)	<b>AT?ADVTIME</b>	To retrieve advertising time (Hex)
(12)	<b>AT?DCDC</b>	To retrieve DC to DC converter status
(13)	<b>AT?CONNECTINTERVALMODE</b>	To retrieve status of connection interval mode
(14)	<b>AT?SERIALNO</b>	To retrieve serial number
(15)	<b>AT?ADCVALUE</b>	To retrieve 10bit ADC value
(16)	<b>AT?RESPONSE</b>	To retrieve status of response
(17)	<b>AT?ALLPARAMETERS</b>	To retrieve value of all parameters
(18)	<b>AT?CONNECTINTERVALTIME</b>	To retrieve value of connection interval time under Mode 2



## 2.2.3. Response (Default)

No.	Command	Response
(1)	AT?NAME	Raytac AT-UART (default)
(2)	AT?VERSION	e.g. version: 1.0
(3)	AT?MACADDR	e.g. D352BDE1E414
(4)	AT?BAUDRATE	0 baudrate9600 (default) (0 = 9600; 1 = 19200; 2 = 38400; 3 = 57600; 4 = 115200; 5 = 230400; 6 = 460800)
(5)	AT?FLOWCONTROL	0 flowcontrol disabled (default) (0 = disabled; 1 = enabled)
(6)	AT?TXPOWER	0 txpower 4dbm (default) (0 = 4dBm; 1 = 0dBm; 2 = -4dBm; 3 = -8dBm, 4 = -20dBm)
(7)	AT?XTAL	0 xtal internal (default) (0 = internal; 1 = external, and XTAL = 32.768KHz oscillator)
(8)	AT?CONNECTINDICATOR	0 connect indicator low (default) (0 = output low; 1 = output high)
(9)	AT?PHYMODE	0 PHY mode 1Mbps (default) (0 = 1Mbps; 1 = 2Mbps)
(10)	AT?WAKEUP	0 wakeup low (default) (0 = low active; 1 = high active)
(11)	AT?ADVTIME	0000 (default: Hex, forever advertising with no timeout, tttt: 0x0000)
(12)	AT?DCDC	0 dcdc dis (default) (0 = disabled; 1 = enabled)
(13)	AT?CONNECTINTERVALMODE	0 connect interval mode 0 (default) (0 = <b>fixed</b> connection interval for iOS/Android APP usage 1 = <b>fixed</b> connection interval, for nRF52832 Central usage 2 = programmable connection interval for iOS/Android APP usage)

No.	Command	Response
(14)	AT?SERIALNO	Display “ no data! ” string (default)
(15)	AT?ADCVALUE	Value varies from input voltage
(16)	AT?RESPONSE	1 response en (default) (0 = disable response; 1 = enable response)
(17)	AT?ALLPARAMETERS	Display value of all parameters, separated by "0x0d0x0a"
(18)	AT?CONNECTINTERVALTIME	006400C8 (default: <b>Hex</b> , 100ms min. connection interval / 200ms Max. connection interval, tttttt: 0x006400C8)

## 2.3. Default Info

No.	Description	Default
(1)	Device name	Raytac AT-UART
(2)	Base UUID	0x9E, 0xCA, 0xDC, 0x24, 0x0E, 0xE5, 0xA9, 0xE0 0x93, 0xF3, 0xA3, 0xB5, 0x00, 0x00, 0x40, 0x6E
(3)	Service UUID	0x0001 TX characteristic: 0x0003; RX characteristic: 0x0002
(4)	Baud rate	9600bps,n,8,1
(5)	Status of flow control	Disabled
(6)	RF TX power	+4dBm
(7)	32.768Khz oscillator	Using internal RC with 1000ms calibration time
(8)	Logic of BT connecting indicator	Output set as logic low when BT is connecting
(9)	PHY mode	1Mbps
(10)	Logic of wake-up pin	Set logic low to wake up in deep sleep
(11)	Advertising time	Forever advertising with no timeout
(12)	Status of DC-to-DC converter	Disabled
(13)	Connection interval mode	Set at min. 20ms and Max. 40ms for iOS/Android usage
(14)	Serial number	Display “ no data! ” string
(15)	ADC value	Value varies from input voltage between 0x0000 ~ 0x03FF (Hex).
(16)	State of response	Enabled

## 2.4. Pin Assignment

Pin No.	Name	Pin Function	Description
(1)	<b>GND</b>	Ground	The pad must be connected to a solid ground plane
(2)	<b>NC</b>	No function	Not connected
(3)	<b>NC</b>	No function	Not connected
(4)	<b>RESET</b>		Configurable as system RESET pin
(5)	<b>TX</b>	Output	UART transmitter
(6)	<b>UART PD</b>	Input	Active-high within internal pull-high to disable hardware UART interface. The default is disabled.
(7)	<b>GND</b>	Ground	The pad must be connected to a solid ground plane.
(8)	<b>Flash Default</b>	Input	Active-low with internal pull-high for $0.48\text{sec} \leq \text{logic low} \leq 1\text{sec}$ and return to logic high, then system will back to default.
(9)	<b>ADC</b>	Analog input	10bit resolution ADC is always on and update every 200ms
(10)	<b>RTS</b>	Output	RTS, request to send. when using internal RC (LFXO)
	<b>XL2</b>	Analog input	Connecting to 32.768KHz crystal when using external LFXO
(11)	<b>RX</b>	Input	UART receiver
	<b>CTS</b>	Input	CTS, clear to send. when using internal RC (LFXO)
(12)	<b>XL1</b>	Analog input	Connecting to 32.768KHz crystal when using external LFXO
(13)	<b>Wakeup</b>	Input / Logic	Input logic is selective about the action of wakeup from deep sleep
(14)	<b>VDD</b>	Power	Power-supply pin
(15)	<b>GND</b>	Ground	The pad must be connected to a solid ground plane
(16)	<b>DCC</b>	Power	DC/DC converter output pin
(17)	<b>DEC4</b>	Power	1V3 regulator supply decoupling. Input from DC/DC converter. Output from 1V3 LDO.
(18)	<b>Inductor</b>	Output / Logic	Output logic is selective about the action of BT connection
(19)	<b>GND</b>	Ground	The pad must be connected to a solid ground plane

## 3. How to Control via External MCU

### 3.1. How to Send AT Commands

- **When BT is NOT connected, for ALL commands**

1. Output low to [UART PD](#) pin to enable UART interface. Please keep it low during the whole time when sending AT commands.
2. Send any AT commands you want. *Please wait for at least 250 ms between sending each command.*

We recommend sending corresponding “Read” command ([section 2.2.2](#)) right after the delay to know whether the writing is successful before moving on to step 3 to save your settings.

*Please prolong the delay (over 250 ms) when writing or/and reading is not successful.*

3. Send command “ **AT+RESET** ” (**not HW reset**) to save all your settings.
4. Output high or NC to [UART PD](#) pin to turn off UART interface.

- **When BT is connected for following commands ONLY**

**Write: AT+DISCONNECT, AT+SLEEP**

**Read: AT?ADCVALUE**

1. Output low to [UART PD](#) pin to enable UART interface. Please keep it low during the whole time when sending AT commands.
2. Output low to [flash default](#) pin to enable receiving AT commands when BT is connected. Please keep it low during the whole time when sending AT commands.
3. Send “AT?ADCVALUE” or “AT+DISCONNECT” or “AT+SLEEP”
4. Output high or NC to [UART PD](#) pin to turn off UART interface.
5. Output high or NC to [flash default](#) pin to disable the module to receive AT commands when BT is connected.

## 3.2. How to Transmit Data

**\* Only when BT is connected \***

1. Output low to **UART PD** pin to enable UART interface. Please keep it low during the whole time when transmitting data.
2. Output high or NC to **UART PD** pin to turn off UART interface.

## 3.3. How to Return to the Setting of Default Flash

**\* Only when BT is NOT connected \***

**\* Note that default baud rate is “9600bps,n,8,1”. For other default, please check [“2.3 Default Info”](#)**

### ● Use Hardware Method

1. Read **indicator** pin first to check if BT is *NOT* in connection.
2. Output a low pulse to **flash default** pin, then system will return to default setting.

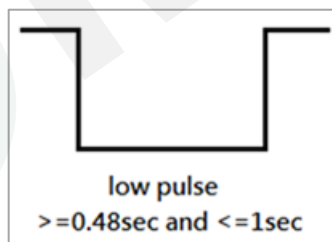

### ● Use Software method

1. Output low to **UART PD** pin to enable UART interface. Please keep it low during the whole time when sending AT commands.
2. Send command “AT+DEFAULT”, then system will return to default setting.

## 4. Test Report

All testing is done under **PHY mode at 1M bps.**

### 4.1. Current Test

DC/DC	Logic of UART PD pin	Advertising Current	Connected Current
Disable	High	0.85 mA	0.3 mA
	Low	1.56 mA	1 mA
Enable	High	0.45 mA	0.16 mA
	Low	0.95 mA	0.68 mA

## 4.2. Throughput Test

Here **D.L.** means “**Data Length**” and **D.I.** means “**Data Interval**” in the table.

### ● MCU → Peripheral (MDBT42TV-AT/MDBT42TV-PAT) → Central → Console

Central Connection Interval	Peripheral Connection Interval	Baud Rate	Flow Control	MCU D.L. (bytes)	MCU D.I. (ms)	Total D.L. (bytes)	Total Trans. Time (sec)	Data Rate (k-bytes/sec)
min = 20ms Max = 75ms	min = 20ms Max = 40ms	9600	X	64	60	262152	273	0.96
			V	244	250	999432	1,042	
min = 20ms Max = 75ms	min = 20ms Max = 40ms	115200	X	64	8	262152	33	7.9
			V	244	30	999432	124	8
min = 20ms Max = 75ms	min = 20ms Max = 40ms	460800	X	244	25	999432	103	9.7
			V					
min = Max = 8ms	min = Max = 8ms	9600	X	64	60	262152	273	0.96
			V	244	250	999432	1,042	
min = Max = 8ms	min = Max = 8ms	115200	X	64	8	262152	33	7.9
			V	244	30	999432	124	8
min = Max = 8ms	min = Max = 8ms	460800	X	244	15	999432	62	16.1
			V					



● MCU → Central → Peripheral (MDBT42TV-AT/MDBT42TV-PAT) → Console

Central Connection Interval	Peripheral Connection Interval	Baud Rate	Flow Control	MCU D.L. (bytes)	MCU D.I. (ms)	Total D.L. (bytes)	Total Trans. Time (sec)	Data Rate (k-bytes/sec)
min = 20ms Max = 75ms	min = 20ms Max = 40ms	9600	X	64	60	262152	273	0.96
			V	244	250	999432	1,042	
			V	244	250	999432	1,042	
min = 20ms Max = 75ms	min = 20ms Max = 40ms	115200	X	64	8	262152	33	7.9
			V	244	30	999432	124	8
			V	244	30	999432	124	8
min = 20ms Max = 75ms	min = 20ms Max = 40ms	460800	X	244	18	999432	74	13.5
			V	244	18	999432	74	
min = Max = 8ms	min = Max = 8ms	9600	X	64	60	262152	273	0.96
			V	244	250	999432	1,042	
			V	244	250	999432	1,042	
min = Max = 8ms	min = Max = 8ms	115200	X	64	8	262152	33	7.9
			V	244	30	999432	124	8
			V	244	30	999432	124	8
min = Max = 8ms	min = Max = 8ms	460800	X	244	15	999432	61	16.3
			V	244	15	999432	61	

# 5. Product Dimension

## 5.1. PCB Dimensions & Pin Indication

### • MDBT42TV

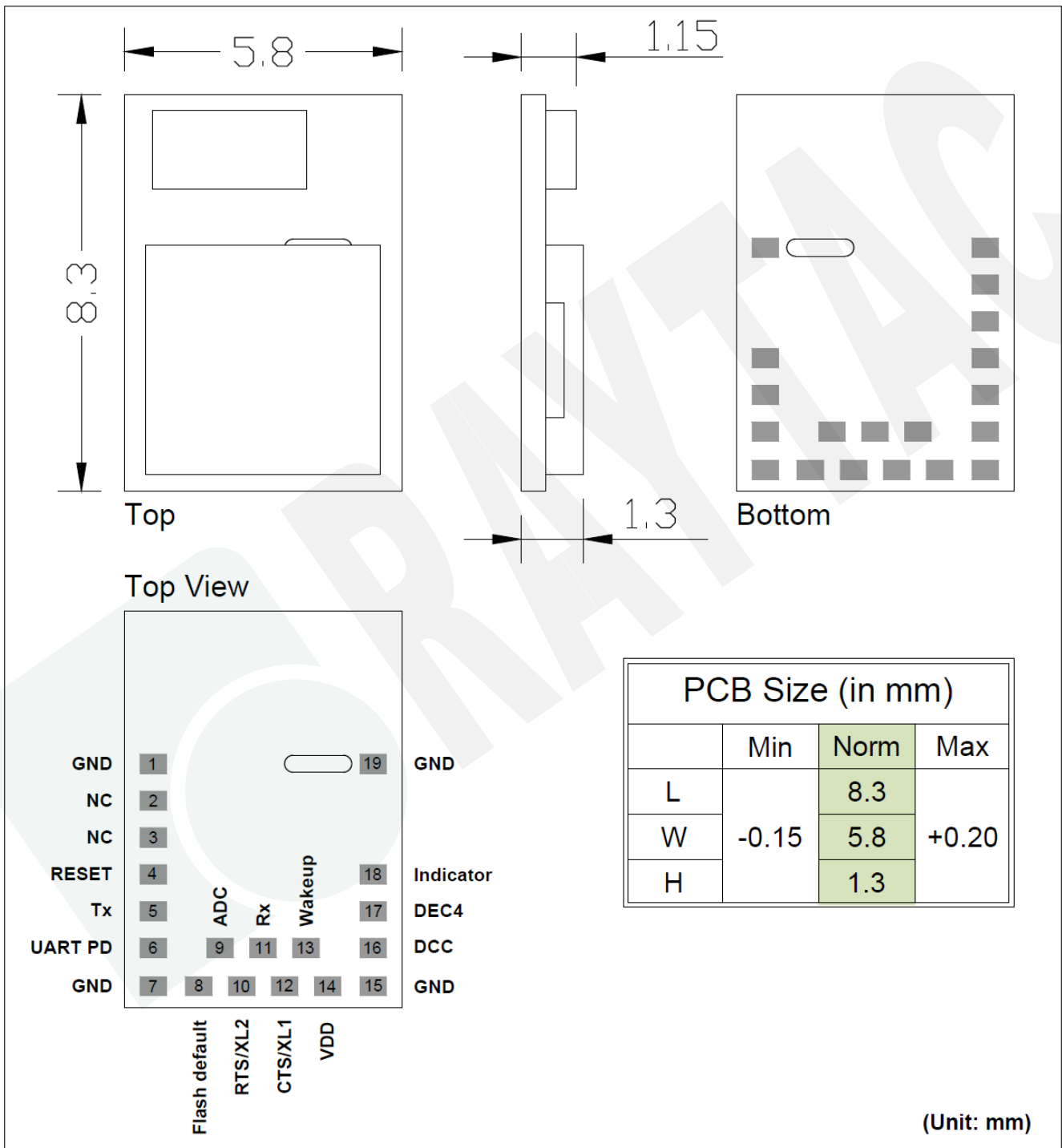

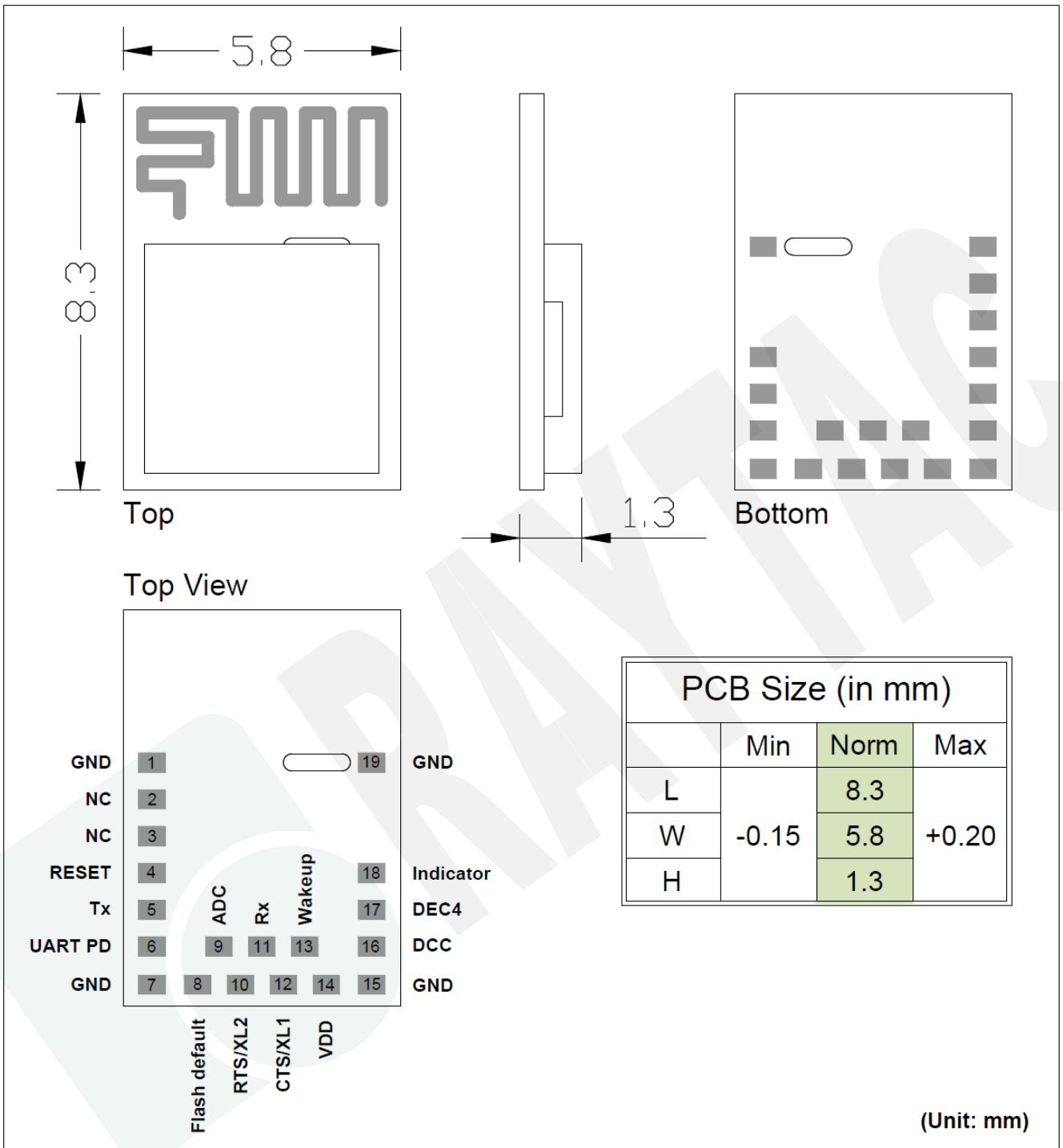

# • MDBT42TV-P



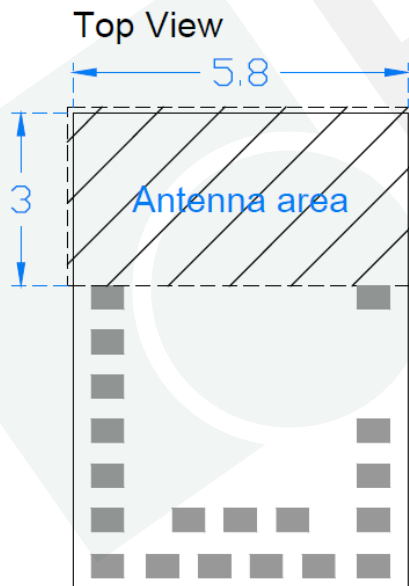
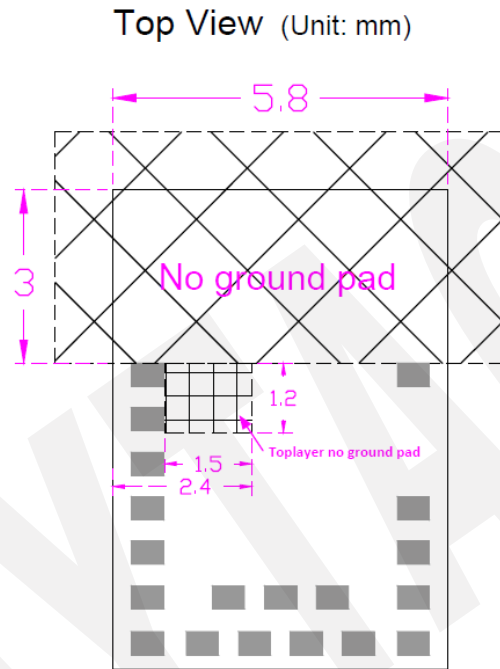
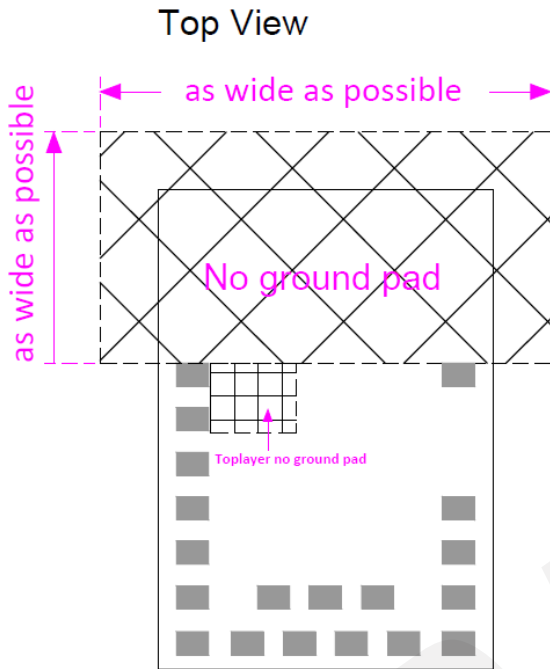

## 5.2. Recommended Layout of Solder Pad

*Graphs are all in Top View, Unit in mm*



 No ground pad  
(as wide as possible)

 Toplayer no ground pad

 Antenna area

Top View (Unit: mm)

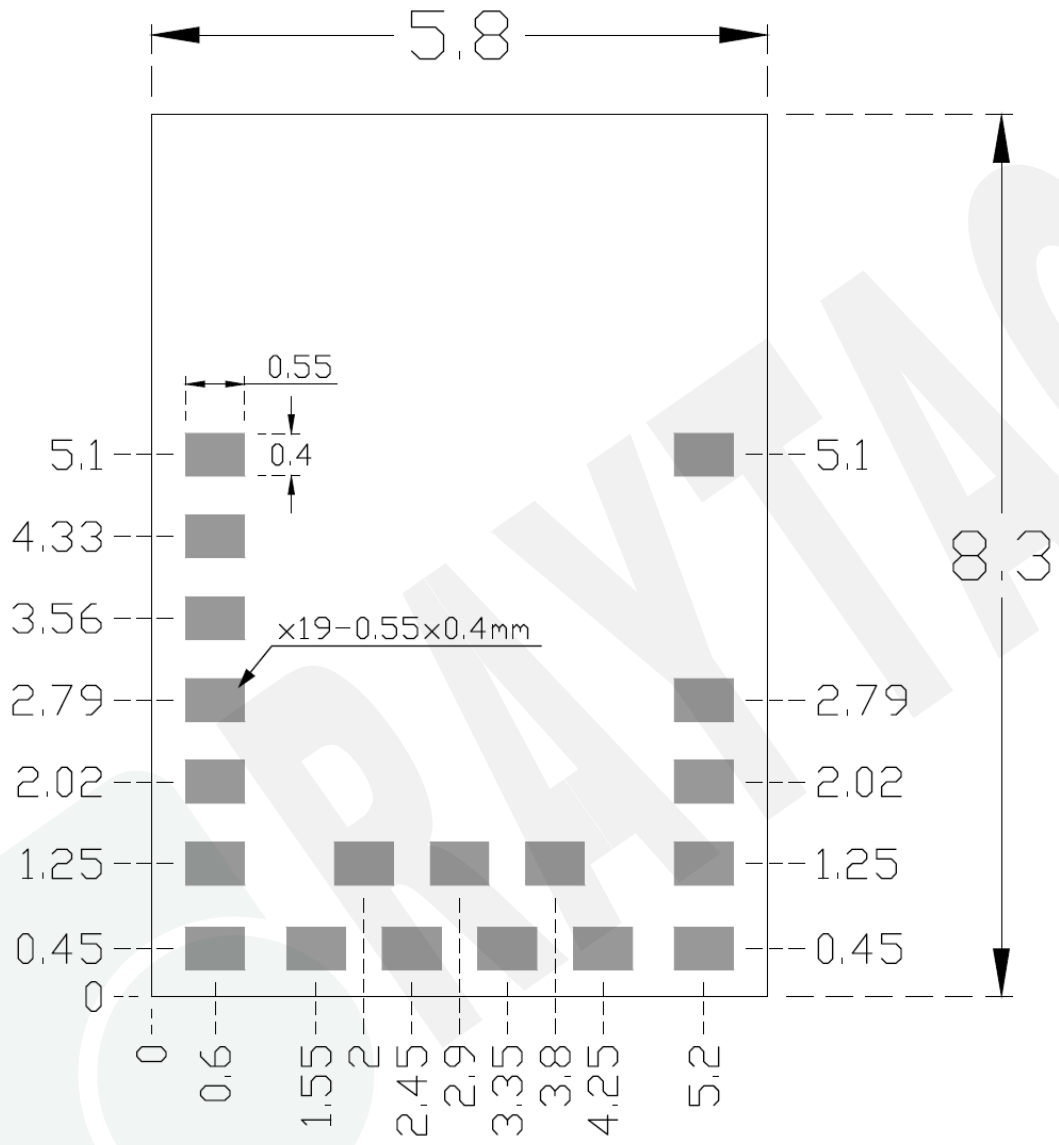

### 5.3. RF Layout Suggestion (aka Keep-Out Area)

Please follow below instruction to have better wireless performance. Make sure to keep the “No-Ground-Pad” as wider as possible when there is not enough space in your design.

No Ground Pad should be included in the corresponding position of the antenna in **EACH LAYER**.

Place the module towards the edge of PCB to have better performance than placing it on the center.

Welcome to send us your layout in PDF for review at [service@raytac.com](mailto:service@raytac.com) or your contact at Raytac with title “Layout reviewing – Raytac model no. – YOUR company’s name”.

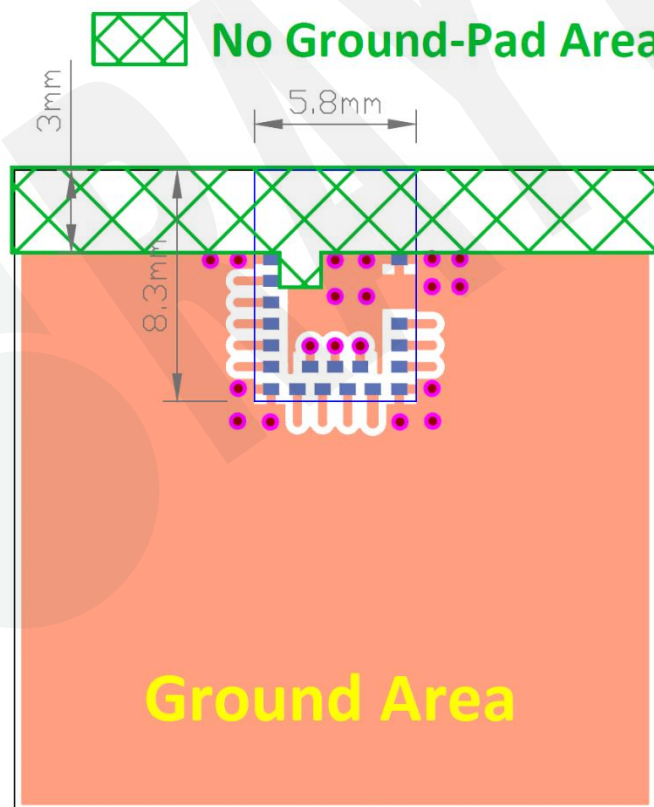

**Top View**

Please add via holes in GROUND area as many as possible, especially around the four corners.

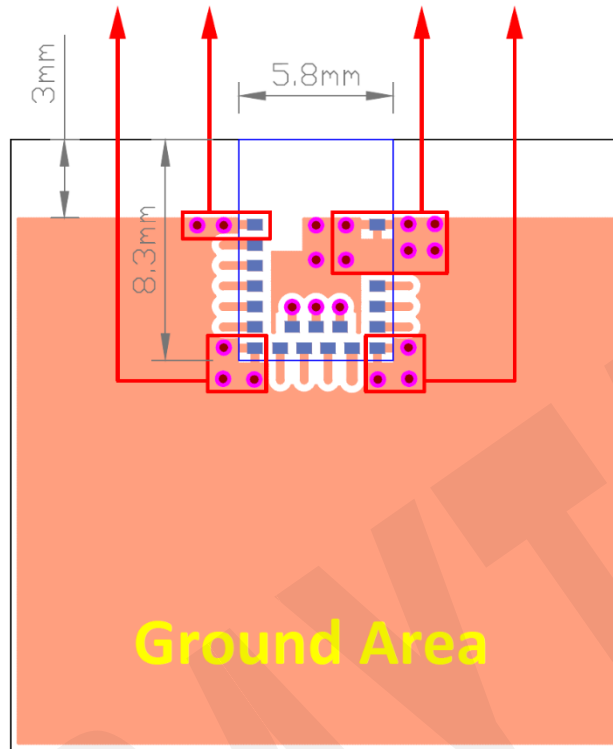

Top View

 No Ground-Pad Area

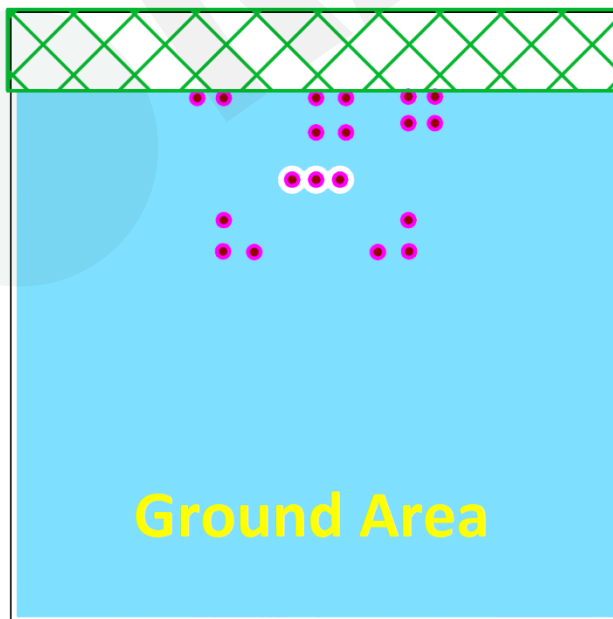

Perspective View

Examples of “**NOT RECOMMENDED**” layout

 where should be NO-GROUND area

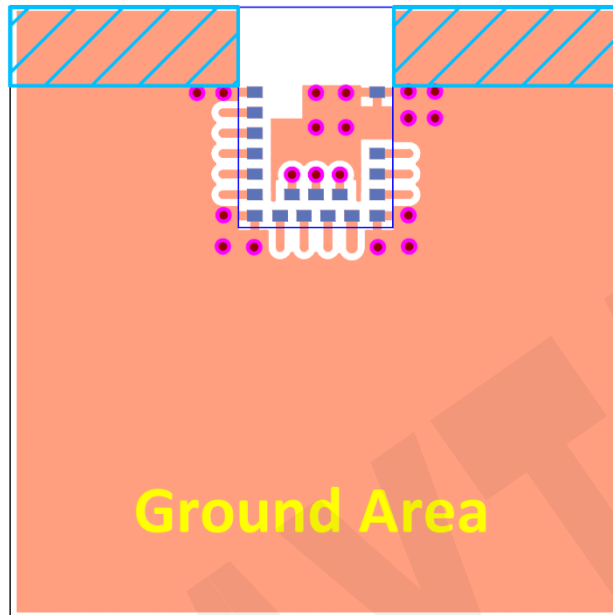

 where should be NO-GROUND area

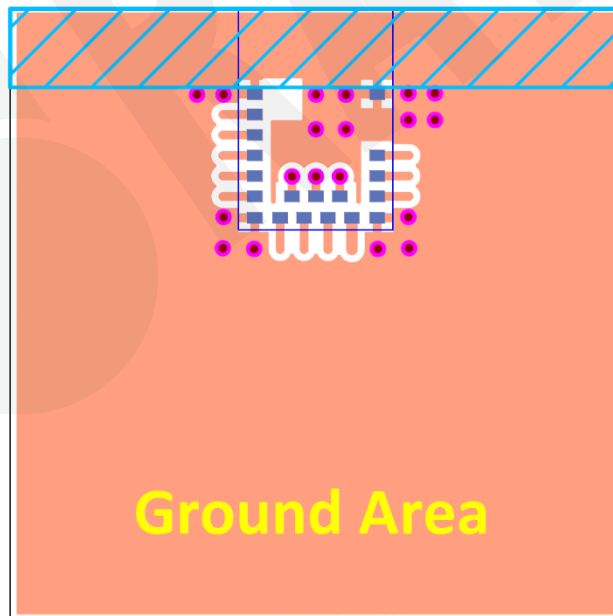

## 5.4. Footprint & Design Guide

Please visit “[Support](#)” page of our website to download. The package includes footprint, 2D/3D drawing, reflow graph and recommended spec for external 32.768khz.





## 6. Main Chip Solution

RF IC	Crystal Frequency
Nordic NRF52805	32MHZ

*32MHz crystal is already inside the module.*

## 7. Shipment Packaging Information

Model	Antenna	Photo
MDBT42TV-AT	Chip/Ceramic	
MDBT42TV-PAT	PCB/Printed	

- Unit Weight of Module:

MDBT42TV-192K: 0.14 g ( $\pm 0.01$  g) ; MDBT42TV-P192K: 0.13 g ( $\pm 0.01$  g)

- Packaging Type: Anti-Static tray only

- Minimum Package Quantity (MPQ): 160 pcs per Tray

- Carton Contents: 3,200 pcs per carton (20 Full Trays + 1 Empty Tray)

- Dimension of Carton: (L) 37 x (W) 21 x (H) 13 cm

- Gross Weight: approx. 2.20 kgs per full carton with 3,200 pcs

## 7.1. Marking on Metal Shield

Label context on metal shield is as below:



## 7.2. Packaging Info

Anti-static tray is specifically designed for mass production. It can be used directly on SMT automatic machine.

### 7.2.1. Tray Packaging

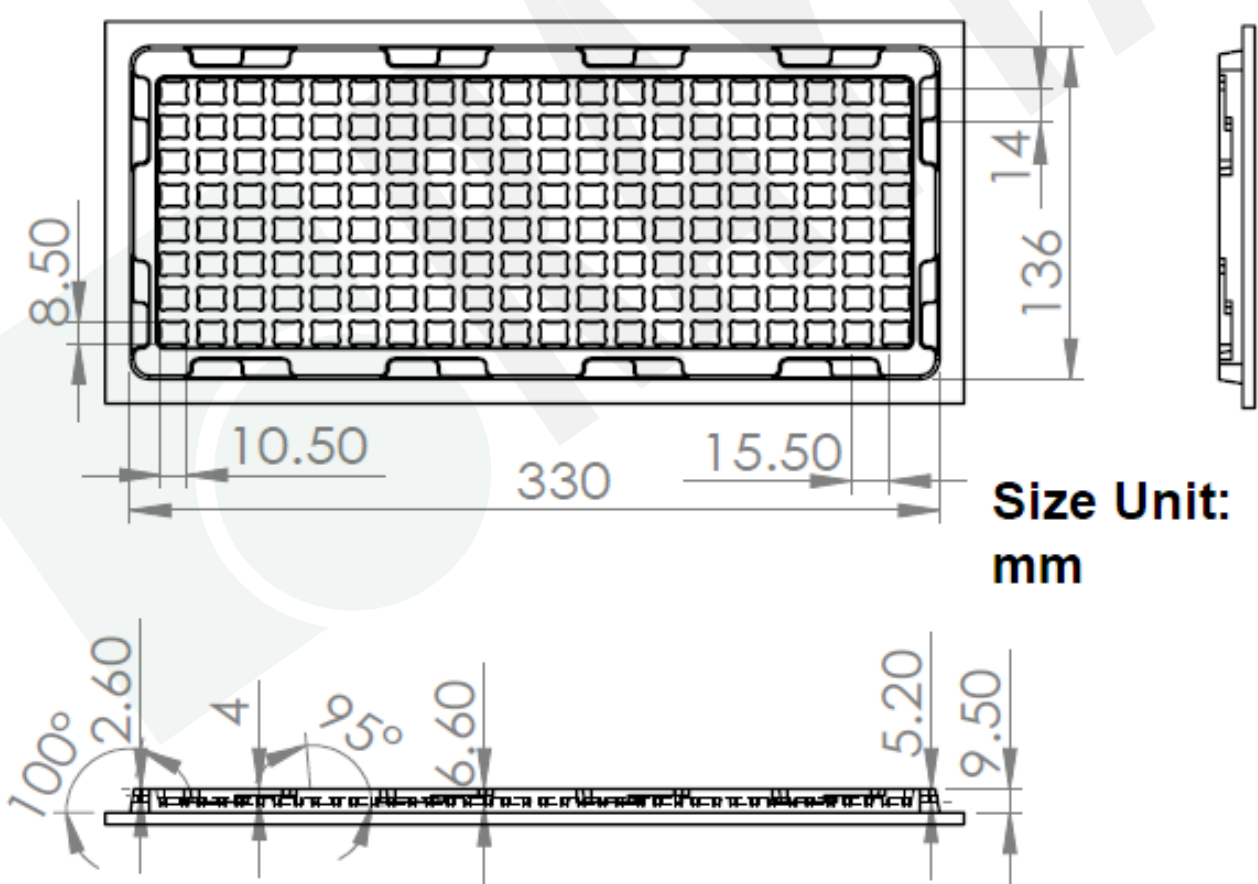

## 8. Specification

Any technical spec shall refer to Nordic's official documents as final reference. Contents below are from "[nRF52805 Product Specification v1.3](#)", please click to download full spec.

### 8.1. Absolute Maximum Ratings

	Note	Min.	Max.	Unit
<b>Supply voltages</b>				
VDD		-0.3	+3.9	V
VSS			0	V
<b>I/O pin voltage</b>				
$V_{I/O}$ , VDD $\leq$ 3.6 V		-0.3	VDD + 0.3	V
$V_{I/O}$ , VDD $>$ 3.6 V		-0.3	3.9	V
<b>Environmental WLCSP package</b>				
Storage temperature		-40	+125	°C
MSL	Moisture Sensitivity Level		1	
ESD HBM	Human Body Model		3	kV
ESD HBM Class	Human Body Model Class		2	
ESD CDM	Charged Device Model		1	kV
<b>Flash memory</b>				
Endurance		10 000		write/erase cycles
Retention at 85 °C		10		years

### 8.2. Operation Conditions

Symbol	Parameter	Min.	Nom.	Max.	Units
VDD	Supply voltage, independent of DCDC enable	1.7	3.0	3.6	V
$t_{R\_VDD}$	Supply rise time (0 V to 1.7 V)			60	ms
TA	Operating temperature	-40	25	85	°C

Important: The on-chip power-on reset circuitry may not function properly for rise times longer than the specified maximum.

## 8.3. Electrical Specifications

### 8.3.1. General Radio Characteristics

Symbol	Description	Min.	Typ.	Max.	Units
$f_{OP}$	Operating frequencies	2360		2500	MHz
$f_{PLL,CH,SP}$	PLL channel spacing		1		MHz
$f_{DELTA,1M}$	Frequency deviation @ 1 Mbps		$\pm 170$		kHz
$f_{DELTA,BLE,1M}$	Frequency deviation @ BLE 1 Mbps		$\pm 250$		kHz
$f_{DELTA,2M}$	Frequency deviation @ 2 Mbps		$\pm 320$		kHz
$f_{DELTA,BLE,2M}$	Frequency deviation @ BLE 2 Mbps		$\pm 500$		kHz
$f_{skBPS}$	On-the-air data rate	1000		2000	kbps

### 8.3.2. Radio Current Consumption (Transmitter)

Symbol	Description	Min.	Typ.	Max.	Units
$I_{TX,PLUS4dBm,DCDC}$	TX only run current (DCDC, 3V) $P_{RF} = +4$ dBm		7.0		mA
$I_{TX,PLUS4dBm}$	TX only run current $P_{RF} = +4$ dBm		15.4		mA
$I_{TX,0dBm,DCDC}$	TX only run current (DCDC, 3V) $P_{RF} = 0$ dBm		4.6		mA
$I_{TX,0dBm}$	TX only run current $P_{RF} = 0$ dBm		10.1		mA
$I_{TX,MINUS4dBm,DCDC}$	TX only run current DCDC, 3V $P_{RF} = -4$ dBm		3.6		mA
$I_{TX,MINUS4dBm}$	TX only run current $P_{RF} = -4$ dBm		7.8		mA
$I_{TX,MINUS8dBm,DCDC}$	TX only run current DCDC, 3V $P_{RF} = -8$ dBm		3.2		mA
$I_{TX,MINUS8dBm}$	TX only run current $P_{RF} = -8$ dBm		6.8		mA
$I_{TX,MINUS12dBm,DCDC}$	TX only run current DCDC, 3V $P_{RF} = -12$ dBm		2.9		mA
$I_{TX,MINUS12dBm}$	TX only run current $P_{RF} = -12$ dBm		6.2		mA
$I_{TX,MINUS16dBm,DCDC}$	TX only run current DCDC, 3V $P_{RF} = -16$ dBm		2.7		mA
$I_{TX,MINUS16dBm}$	TX only run current $P_{RF} = -16$ dBm		5.7		mA
$I_{TX,MINUS20dBm,DCDC}$	TX only run current DCDC, 3V $P_{RF} = -20$ dBm		2.5		mA
$I_{TX,MINUS20dBm}$	TX only run current $P_{RF} = -20$ dBm		5.4		mA
$I_{TX,MINUS40dBm,DCDC}$	TX only run current DCDC, 3V $P_{RF} = -40$ dBm		2.1		mA
$I_{TX,MINUS40dBm}$	TX only run current $P_{RF} = -40$ dBm		4.3		mA

### 8.3.3. Radio Current Consumption (Receiver)

Symbol	Description	Min.	Typ.	Max.	Units
$I_{RX,1M,DCDC}$	RX only run current (DCDC, 3V) 1 Mbps / 1 Mbps BLE		4.6		mA
$I_{RX,1M}$	RX only run current 1 Mbps / 1 Mbps BLE		10.0		mA
$I_{RX,2M,DCDC}$	RX only run current (DCDC, 3V) 2 Mbps / 2 Mbps BLE		5.2		mA
$I_{RX,2M}$	RX only run current 2 Mbps / 2 Mbps BLE		11.2		mA
$I_{START,RX,1M,DCDC}$	RX start-up current (DCDC, 3 V) 1 Mbps / 1 Mbps BLE		3.5		mA
$I_{START,RX,1M}$	RX start-up current 1 Mbps / 1 Mbps BLE		6.7		mA

### 8.3.4. Transmitter Specification

Symbol	Description	Min.	Typ.	Max.	Units
$P_{RF}$	Maximum output power		4		dBm
$P_{RFC}$	RF power control range		24		dB
$P_{RFCR}$	RF power accuracy			$\pm 4$	dB
$P_{RF1,1}$	1st Adjacent Channel Transmit Power 1 MHz (1 Mbps)		-25		dBc
$P_{RF2,1}$	2nd Adjacent Channel Transmit Power 2 MHz (1 Mbps)		-50		dBc
$P_{RF1,2}$	1st Adjacent Channel Transmit Power 2 MHz (2 Mbps)		-25		dBc
$P_{RF2,2}$	2nd Adjacent Channel Transmit Power 4 MHz (2 Mbps)		-50		dBc

### 8.3.5. Receiver Operation

Symbol	Description	Min.	Typ.	Max.	Units
$P_{RX,MAX}$	Maximum received signal strength at < 0.1% PER		0		dBm
$P_{SENS,IT,1M}$	Sensitivity, 1 Mbps nRF mode ideal transmitter <sup>1</sup>		-94		dBm
$P_{SENS,IT,2M}$	Sensitivity, 2 Mbps nRF mode ideal transmitter <sup>1</sup>		-91		dBm
$P_{SENS,IT,SP,1M,BLE}$	Sensitivity, 1 Mbps BLE ideal transmitter, packet length $\leq 37$ bytes BER= $1E-3^2$		-97		dBm
$P_{SENS,IT,LP,1M,BLE}$	Sensitivity, 1 Mbps BLE ideal transmitter, packet length $\geq 128$ bytes BER= $1E-4^3$		-96		dBm
$P_{SENS,IT,SP,2M,BLE}$	Sensitivity, 2 Mbps BLE ideal transmitter, packet length $\leq 37$ bytes		-94		dBm

1. Typical sensitivity applies when ADDR0 is used for receiver address correlation. When ADDR [1...7] are used for receiver address correlation, the typical sensitivity for this mode is degraded by 3dB.
2. As defined in the Bluetooth Core Specification v4.0 Volume 6: Core System Package (Low Energy Controller Volume).
3. Equivalent BER limit < 10E-04.

## 8.3.6. RX Selectivity

Symbol	Description	Min.	Typ.	Max.	Units
C/I <sub>1M,co-channel</sub>	1Mbps mode, co-channel interference		9		dB
C/I <sub>1M,-1MHz</sub>	1 Mbps mode, Adjacent (-1 MHz) interference		-2		dB
C/I <sub>1M,+1MHz</sub>	1 Mbps mode, Adjacent (+1 MHz) interference		-10		dB
C/I <sub>1M,-2MHz</sub>	1 Mbps mode, Adjacent (-2 MHz) interference		-19		dB
C/I <sub>1M,+2MHz</sub>	1 Mbps mode, Adjacent (+2 MHz) interference		-42		dB
C/I <sub>1M,-3MHz</sub>	1 Mbps mode, Adjacent (-3 MHz) interference		-38		dB
C/I <sub>1M,+3MHz</sub>	1 Mbps mode, Adjacent (+3 MHz) interference		-48		dB
C/I <sub>1M,±6MHz</sub>	1 Mbps mode, Adjacent (≥6 MHz) interference		-50		dB
C/I <sub>1MBLE,co-channel</sub>	1 Mbps BLE mode, co-channel interference		6		dB
C/I <sub>1MBLE,-1MHz</sub>	1 Mbps BLE mode, Adjacent (-1 MHz) interference		-2		dB
C/I <sub>1MBLE,+1MHz</sub>	1 Mbps BLE mode, Adjacent (+1 MHz) interference		-9		dB
C/I <sub>1MBLE,-2MHz</sub>	1 Mbps BLE mode, Adjacent (-2 MHz) interference		-22		dB
C/I <sub>1MBLE,+2MHz</sub>	1 Mbps BLE mode, Adjacent (+2 MHz) interference		-46		dB
C/I <sub>1MBLE,&gt;3MHz</sub>	1 Mbps BLE mode, Adjacent (≥3 MHz) interference		-50		dB
C/I <sub>1MBLE,image</sub>	Image frequency interference		-22		dB
C/I <sub>1MBLE,image,1MHz</sub>	Adjacent (1 MHz) interference to in-band image frequency		-35		dB
C/I <sub>2M,co-channel</sub>	2 Mbps mode, co-channel interference		10		dB
C/I <sub>2M,-2MHz</sub>	2 Mbps mode, Adjacent (-2 MHz) interference		6		dB
C/I <sub>2M,+2MHz</sub>	2 Mbps mode, Adjacent (+2 MHz) interference		-14		dB
C/I <sub>2M,-4MHz</sub>	2 Mbps mode, Adjacent (-4 MHz) interference		-20		dB
C/I <sub>2M,+4MHz</sub>	2 Mbps mode, Adjacent (+4 MHz) interference		-44		dB
C/I <sub>2M,-6MHz</sub>	2 Mbps mode, Adjacent (-6 MHz) interference		-42		dB
C/I <sub>2M,+6MHz</sub>	2 Mbps mode, Adjacent (+6 MHz) interference		-47		dB
C/I <sub>2M,≥12MHz</sub>	2 Mbps mode, Adjacent (≥12 MHz) interference		-52		dB
C/I <sub>2MBLE,co-channel</sub>	2 Mbps BLE mode, co-channel interference		6		dB
C/I <sub>2MBLE,-2MHz</sub>	2 Mbps BLE mode, Adjacent (-2 MHz) interference		-2		dB
C/I <sub>2MBLE,+2MHz</sub>	2 Mbps BLE mode, Adjacent (+2 MHz) interference		-12		dB
C/I <sub>2MBLE,-4MHz</sub>	2 Mbps BLE mode, Adjacent (-4 MHz) interference		-22		dB
C/I <sub>2MBLE,+4MHz</sub>	2 Mbps BLE mode, Adjacent (+4 MHz) interference		-46		dB
C/I <sub>2MBLE,≥6MHz</sub>	2 Mbps BLE mode, Adjacent (≥6 MHz) interference		-50		dB
C/I <sub>2MBLE,image</sub>	Image frequency interference		-29		dB
C/I <sub>2MBLE,image, 2MHz</sub>	Adjacent (2 MHz) interference to in-band image frequency		-44		dB

Remark: Wanted signal level at PIN = -67 dBm. One interferer is used, having equal modulation as the wanted signal. The input power of the interferer where the sensitivity equals BER = 0.1% is presented.

## 8.3.7. RX Intermodulation

Symbol	Description	Min.	Typ.	Max.	Units
P <sub>IMD,5TH,1M</sub>	IMD performance, 1 Msps, 5th offset channel, Packet length <= 37 bytes		-33		dBm
P <sub>IMD,5TH,1M,BLE</sub>	IMD performance, BLE 1 Msps, 5th offset channel, Packet length <= 37 bytes		-30		dBm
P <sub>IMD,5TH,2M</sub>	IMD performance, 2 Msps, 5th offset channel, Packet length <= 37 bytes		-33		dBm
P <sub>IMD,5TH,2M,BLE</sub>	IMD performance, BLE 2 Msps, 5th offset channel, Packet length <= 37 bytes		-31		dBm

Remark: Wanted signal level at PIN = -64dBm. Two interferers with equal input power are used. The interferer closest in frequency is not modulated, the other interferer is modulated equal with the wanted signal. The input power of the interferers where the sensitivity equals BER = 0.1% is presented.

## 8.3.8. Radio Timing Parameters

Symbol	Description	Min.	Typ.	Max.	Units
t <sub>TXEN,BLE,1M</sub>	Time between TXEN task and READY event after channel FREQUENCY configured (1 Mbps BLE and 150 μs TIFS)		140		μs
t <sub>TXEN,FAST,BLE,1M</sub>	Time between TXEN task and READY event after channel FREQUENCY configured (1 Mbps BLE with fast ramp-up and 150 μs TIFS)		40		μs
t <sub>TXDIS,BLE,1M</sub>	When in TX, delay between DISABLE task and DISABLED event for MODE = Nrf_1Mbit and MODE = Ble_1Mbit		6		μs
t <sub>RXEN,BLE,1M</sub>	Time between the RXEN task and READY event after channel FREQUENCY configured (1 Mbps BLE)		140		μs
t <sub>RXEN,FAST,BLE,1M</sub>	Time between the RXEN task and READY event after channel FREQUENCY configured (1 Mbps BLE with fast ramp-up)		40		μs
t <sub>RXDIS,BLE,1M</sub>	When in RX, delay between DISABLE task and DISABLED event for MODE = Nrf_1Mbit and MODE = Ble_1Mbit		0		μs
t <sub>TXDIS,BLE,2M</sub>	When in TX, delay between DISABLE task and DISABLED event for MODE = Nrf_2Mbit and MODE = Ble_2Mbit		4		μs
t <sub>RXDIS,BLE,2M</sub>	When in RX, delay between DISABLE task and DISABLED event for MODE = Nrf_2Mbit and MODE = Ble_2Mbit		0		μs



### 8.3.9. RSSI Specifications

Symbol	Description	Min.	Typ.	Max.	Units
RSSI <sub>ACC</sub>	RSSI accuracy <sup>18</sup>		±2		dB
RSSI <sub>RESOLUTION</sub>	RSSI resolution		1		dB
RSSI <sub>PERIOD</sub>	RSSI sampling time from RSSI_START task		0.25		µs
RSSI <sub>SETTLE</sub>	RSSI settling time after signal level change		15		µs

### 8.3.10. CPU

Symbol	Description	Min.	Typ.	Max.	Units
W <sub>FLASH</sub>	CPU wait states, running from flash	0		2	
W <sub>RAM</sub>	CPU wait states, running from RAM			0	
CM <sub>FLASH</sub>	CoreMark <sup>1</sup> , running from flash		144		CoreMark
CM <sub>FLASH/MHz</sub>	CoreMark per MHz, running from flash		2.25		CoreMark/MHz
CM <sub>FLASH/mA</sub>	CoreMark per mA, running from flash, DCDC 3V		65		CoreMark/mA

### 8.3.11. Power Management

Symbol	Description	Min.	Typ.	Max.	Units
I <sub>ON_RAMOFF_EVENT</sub>	System ON, no RAM retention, wake on any event		0.6		µA
I <sub>ON_RAMON_EVENT</sub>	System ON, full 24 kB RAM retention, wake on any event		0.8		µA
I <sub>ON_RAMON_POF</sub>	System ON, full 24 kB RAM retention, wake on any event, power-fail comparator enabled		0.8		µA
I <sub>ON_RAMON_GPIOTE</sub>	System ON, full 24 kB RAM retention, wake on GPIOTE input (event mode)		3.3		µA
I <sub>ON_RAMON_GPIOTEPORT</sub>	System ON, full 24 kB RAM retention, wake on GPIOTE PORT event		0.8		µA
I <sub>ON_RAMOFF_RTC</sub>	System ON, no RAM retention, wake on RTC (running from LFRC clock)		1.4		µA
I <sub>ON_RAMON_RTC</sub>	System ON, full 24 kB RAM retention, wake on RTC (running from LFRC clock)		1.5		µA
I <sub>OFF_RAMOFF_RESET</sub>	System OFF, no RAM retention, wake on reset		0.3		µA
I <sub>OFF_RAMON_RESET</sub>	System OFF, full 24 kB RAM retention, wake on reset		0.5		µA
I <sub>ON_RAMON_RTC_LFXO</sub>	System ON, full 24 kB RAM retention, wake on RTC (running from LFXO clock)		1.1		µA
I <sub>ON_RAMOFF_RTC_LFXO</sub>	System ON, no RAM retention, wake on RTC (running from LFXO clock)		1.0		µA



# 9. Antenna

## 9.1. MDBT42TV Series

Frequency (MHz)	2400	2410	2420	2430	2440	2450	2460	2470	2480	2490	2500
Gain (dBi)	-6.33	-6.05	-5.81	-5.94	-6.07	-6.16	-6.33	-6.32	-6.34	-6.47	-6.76
Directivity (dBi)	5.15	5.14	5.17	5.12	5.01	4.95	4.79	4.74	4.70	4.67	4.57
Efficiency (dB)	-11.49	-11.20	-10.97	-11.06	-11.09	-11.11	-11.13	-11.06	-11.04	-11.15	-11.33

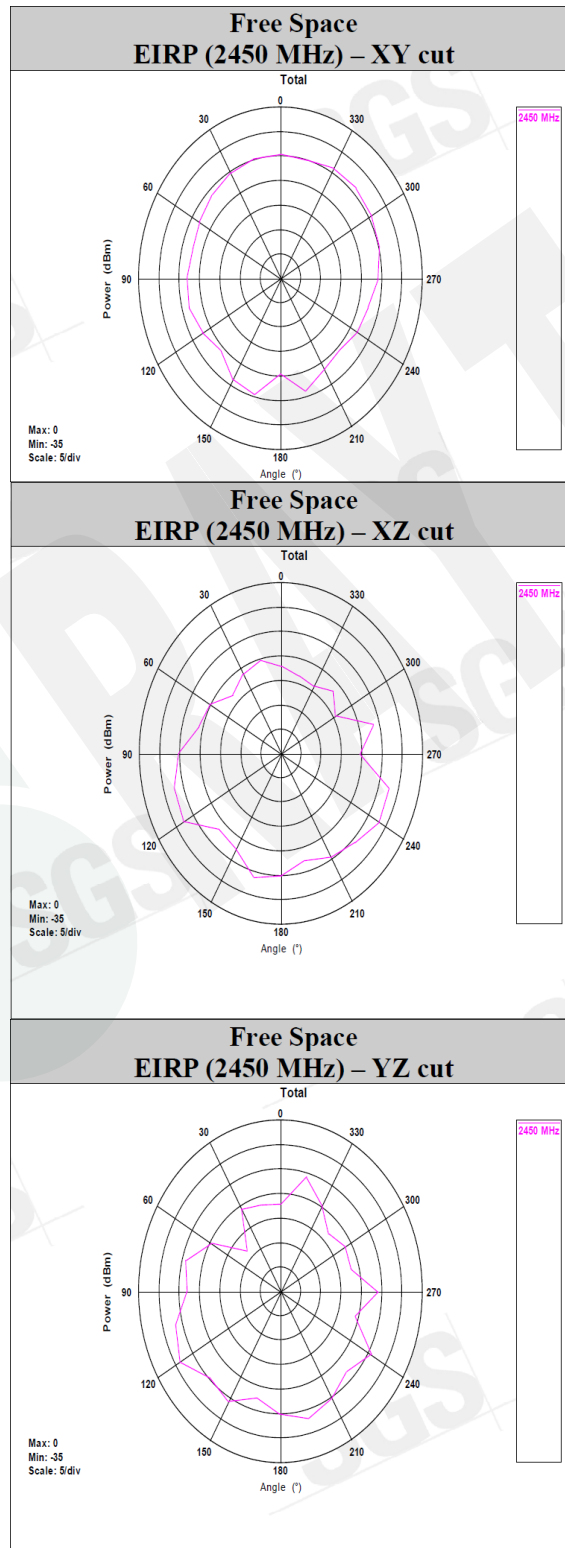

## 9.2. MDBT42TV-P Series

Frequency (MHz)	2400	2410	2420	2430	2440	2450	2460	2470	2480	2490	2500
Gain (dBi)	-6.82	-6.65	-6.50	-6.59	-6.69	-6.84	-6.96	-7.07	-6.96	-7.07	-7.15
Directivity (dBi)	5.37	5.31	5.29	5.28	5.20	5.06	4.97	4.81	4.85	4.77	4.71
Efficiency (dB)	-12.19	-11.96	-11.79	-11.87	-11.89	-11.90	-11.93	-11.88	-11.82	-11.83	-11.86

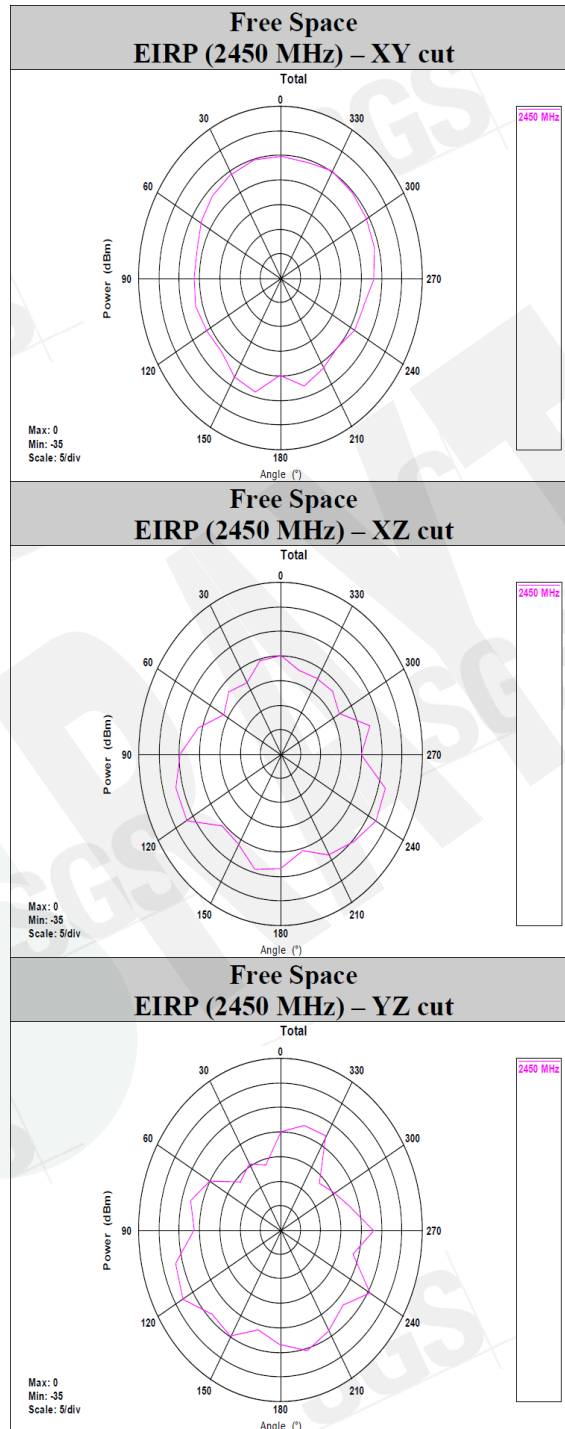

# 10. Reference Circuit

Module is pre-programmed with Raytac's AT command firmware. Default is NOT using "DC-DC mode" and is using internal 32.768kHz RC oscillator.

### REMARK:

\*\* When using DC-DC mode, please add L2 / L3 / C14. \*\*

\*\* When NOT using internal 32.768kHz RC oscillator, please add X2 / C12 / C13.

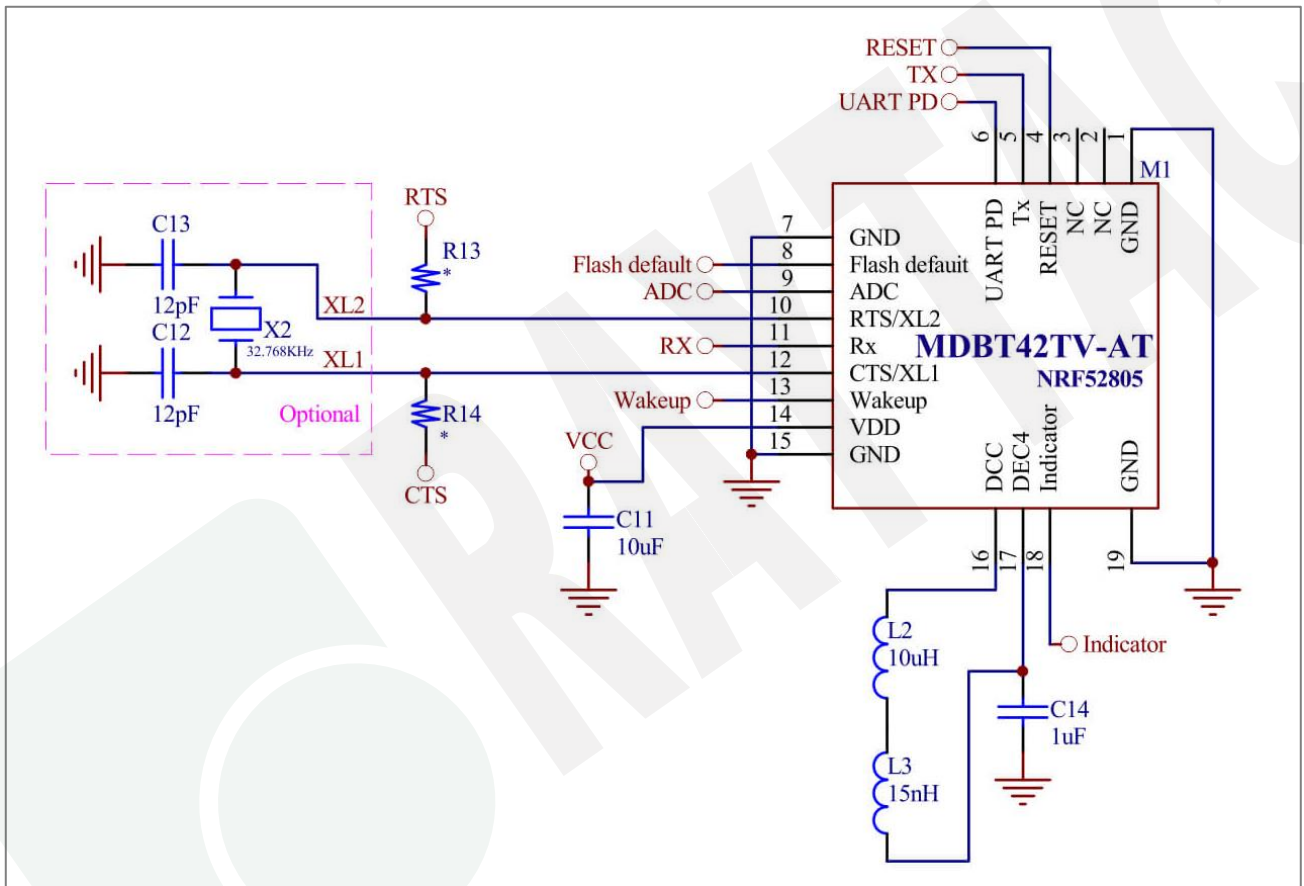

# 11. Certification

## 11.1. Declaration ID

Declaration ID	QDID(s)	Company	Specification Name
D053149	159932 - End Product	Raytac Corporation	5.2

Profile Description	Service Description
Alert Notification Profile	Alert Notification Service
Blood Pressure Profile	Blood Pressure Service
	Device Information Service
Cycling Speed & Cadence Profile	Cycling Speed & Cadence Service
	Device Information Service
Glucose Profile	Glucose Service
	Device Information Service
Health Thermometer Profile	Health Thermometer Service
	Device Information Service
Heart Rate Profile	Heart Rate Service
	Device Information Service
HID over GATT Profile	HID Service
	Battery Service
Proximity Profile	Link Loss Service
	Immediate Alert Service
	TX Power Service
Running Speed & Cadence Profile	Running Speed & Cadence Service
	Device Information Service
Time Profile	Time Profile Service
Glucose Profile (Central)	
Mesh Profile	Mesh Provisioning Service
	Mesh Proxy Service

# 11.2. FCC Certificate (USA)

## BLE 1 Mbps & 2 Mbps

<b>TCB</b>	<b>GRANT OF EQUIPMENT AUTHORIZATION</b>  Certification Issued Under the Authority of the Federal Communications Commission By:	<b>TCB</b>			
	SGS North America, Inc. 620 Old Peachtree Road NW Suite 100 Suwanee, GA 30024	Date of Grant: 11/17/2020 Application Dated: 11/17/2020			
Raytac Corp. 5F., No.3, Jiankang Rd., Zhonghe Dist., New Taipei City., 23586 Taiwan					
Attention: Venson Liao , R&D Manager					
<b>NOT TRANSFERABLE</b>					
EQUIPMENT AUTHORIZATION is hereby issued to the named GRANTEE, and is VALID ONLY for the equipment identified hereon for use under the Commission's Rules and Regulations listed below.					
<b>FCC IDENTIFIER:</b> SH6MDBT42TV					
<b>Name of Grantee:</b> Raytac Corp.					
<b>Equipment Class:</b> Digital Transmission System					
<b>Notes:</b> BLE Module					
<b>Modular Type:</b> Single Modular					
<u>Grant Notes</u>	<u>FCC Rule Parts</u>	<u>Frequency Range (MHZ)</u>	<u>Output Watts</u>	<u>Frequency Tolerance</u>	<u>Emission Designator</u>
	15C	2402.0 - 2480.0	0.0034		
Single Modular Approval. Output power listed is conducted. Compliance of this device in all final host configurations is the responsibility of the Grantee. OEM integrators and end-users must be provided with specific operating instructions for satisfying RF exposure compliance. OEM integrators are instructed to ensure that the end user has no manual instructions to remove or install the device. This transmitter must not be co-located or operating in conjunction with any other antenna or transmitter except in accordance with FCC multi-transmitter procedures.					

## 11.3. TELEC Certificate (Japan)

### **BLE 1 Mbps & 2 Mbps**

<p>telefication bv The Netherlands Chamber of Commerce 51565336 www.telefication.com</p>		
<h3>Certificate</h3> <p>of Radio Equipment in JAPAN</p>		
<p>No: 201-200783 / 00</p>		
<p>Telefication, operating as Conformity Assessment Body (CAB ID Number: 201) with respect to Japan, declares that the listed product complies with the Technical Regulations Conformity Certification of Specified Radio equipment (ordinance of MPT N° 37,1981)</p>		
<p>Product description: BLE Module Trademark: Raytac Corporation Type designation: MDBT42TV Serial No: N/A Hardware / Software version: 1.0 / 1.0 Variants: See Annex 3</p> <p>Manufacturer: Raytac Corp. Address: 5F., No.3, Jiankang Road, Zhonghe District, City: 23586 New Taipei City Country: Taiwan</p>		
<p>This certificate is granted to:</p>		
<p>Name: Raytac Corp. Address: 5F., No.3, Jiankang Road, Zhonghe District, City: 23586 New Taipei City Country: Taiwan</p>		
<p>This certificate has THREE Annexes.</p>		
<p>Zevenaar, 21 October 2020</p>		
<p><b>CAB</b></p>		
	<p>David Chen Product Assessor</p>	
		
		

## 11.4. NCC Certificate (Taiwan)

**BLE 1 Mbps & 2 Mbps**

**MDBT42TV**

**SGS**

台灣檢驗科技股份有限公司  
電信管制射頻器材型式認證證明

證照字號：型式字第 AM 號

- 一、申請者：勁達國際電子有限公司
- 二、地址：臺北市大安區和平東路1段145號5樓之1
- 三、製造廠商：勁達國際電子有限公司
- 四、器材名稱：藍牙模組
- 五、廠牌：Raytac Corporation
- 六、型號：MDBT42TV
- 七、發射功率(電場強度)：詳細射頻規格如備註欄
- 八、工作頻率：詳細射頻規格如備註欄
- 九、審驗日期：109年11月12日

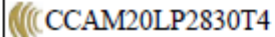
- 十、審驗合格標籤式樣：

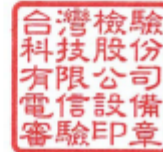

- 十一、警語或標示要求：(器材本體、使用手冊、外包裝盒等應遵守下列標示要求)
1. 應於本體明顯處標示審驗合格標籤或符合性聲明標籤及其型號，並於包裝盒標示主管機關印章。最終產品應於本體明顯處標示非隨插即用射頻模組(組件)之審驗合格標籤及最終產品型號，並於包裝盒標示主管機關印章，始得販賣。
  2. 依主管機關或相關技術規範規定於指定位置標示正體中文警語。
  3. 經授權使用射頻模組(組件)之審驗合格標籤者，應於最終產品說明書及包裝盒提供充分與正確之資訊。
  4. 於網際網路販賣電信管制射頻器材者，應於該網際網路網頁標示其型號及審驗合格標籤或符合性聲明標籤資訊。但最終產品得僅標示其型號及其組裝之非隨插即用射頻模組(組件)之審驗合格標籤資訊。
  5. 使用手冊應標示下列資訊：
    - (1) 取得審驗證明之低功率射頻器材，非經核准，公司、商號或使用者均不得擅自變更頻率、加大功率或變更原設計之特性及功能。低功率射頻器材之使用不得影響飛航安全及干擾合法通信；經發現有干擾現象時，應立即停用，並改善至無干擾時方得繼續使用。前述合法通信，指依電信管理法規定作業之無線電通信。低功率射頻器材須忍受合法通信或工業、科學及醫療用電波輻射性電機設備之干擾。



# BLE 1 Mbps & 2 Mbps

## MDBT42TV-P

台灣檢驗科技股份有限公司  
電信管制射頻器材型式認證證明

證照字號：型式字第 AM 號

- 一、申請者：勁達國際電子有限公司
- 二、地址：臺北市大安區和平東路1段145號5樓之1
- 三、製造廠商：勁達國際電子有限公司
- 四、器材名稱：藍牙模組
- 五、廠牌：Raytac Corporation
- 六、型號：MDBT42TV-P
- 七、發射功率(電場強度)：詳細射頻規格如備註欄
- 八、工作頻率：詳細射頻規格如備註欄
- 九、審驗日期：109年11月12日

十、審驗合格標籤式樣：

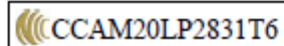
 CCAM20LP2831T6

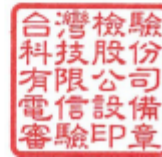

- 十一、警語或標示要求：(器材本體、使用手冊、外包裝盒等應遵守下列標示要求)
1. 應於本體明顯處標示審驗合格標籤或符合性聲明標籤及其型號，並於包裝盒標示主管機關標章。最終產品應於本體明顯處標示非隨插即用射頻模組(組件)之審驗合格標籤及最終產品型號，並於包裝盒標示主管機關標章，始得販賣。
  2. 依主管機關或相關技術規範規定於指定位置標示正體中文警語。
  3. 經授權使用射頻模組(組件)之審驗合格標籤者，應於最終產品說明書及包裝盒提供充分與正確之資訊。
  4. 於網際網路販賣電信管制射頻器材者，應於該網際網路網頁標示其型號及審驗合格標籤或符合性聲明標籤資訊。但最終產品得僅標示其型號及其組裝之非隨插即用射頻模組(組件)之審驗合格標籤資訊。
  5. 使用手冊應標示下列資訊：
    - (1) 取得審驗證明之低功率射頻器材，非經核准，公司、商號或使用者均不得擅自變更頻率、加大功率或變更原設計之特性及功能。低功率射頻器材之使用不得影響飛航安全及干擾合法通信；經發現有干擾現象時，應立即停用，並改善至無干擾時方得繼續使用。前述合法通信，指依電信管理法規定作業之無線電通信。低功率射頻器材須忍受合法通信或工業、科學及醫療用電波輻射性電機設備之干擾。



# 11.5. CE (EU) & RCM (Australia & New Zealand) Test Report

## BLE 1 Mbps & 2 Mbps



Page: 4 / 59  
Rev.: 00

Report No.: T200824W11-RT

### 1. TEST RESULT CERTIFICATION

**Applicant:** Raytac Corp.  
5F.,No.3, Jiankang Road, Zhonghe District, New Taipei City  
23586, Taiwan

**Manufacturer:** Raytac Corp.  
5F.,No.3, Jiankang Road, Zhonghe District, New Taipei City  
23586, Taiwan

**Equipment Under Test:** BLE Module

**Trade Name:** Raytac Corporation

**Model Number:** MDBT42TV, MDBT42TV-P

**Date of Test:** August 26 ~ September 2, 2020

APPLICABLE STANDARDS	
STANDARD	TEST RESULT
ETSI EN 300 328 V2.2.2: 2019 & AS/NZS 4268:2017	No non-compliance noted
Statements of Conformity	
Determination of compliance is based on the results of the compliance measurement, not taking into account measurement instrumentation uncertainty.	

The above equipment was tested by Compliance Certification Services Inc. for compliance with the requirements set forth in ETSI EN 300 328. The results of testing in this report apply only to the product/system, which was tested. Other similar equipment will not necessarily produce the same results due to production tolerance and measurement uncertainties.

Approved by:

Kevin Tsai  
Deputy Manager

## VERIFICATION OF COMPLIANCE

<b>Issue Date:</b>	Sep. 11, 2020
<b>Applicant:</b>	Raytac Corporation
<b>Address:</b>	5F., No.3, Jiankang Road, Zhonghe District, New Taipei City, Taiwan
<b>Manufacturer:</b>	Raytac Corporation
<b>Address:</b>	5F., No.3, Jiankang Road, Zhonghe District, New Taipei City 23586, Taiwan
<b>Contact Information:</b>	Web: <a href="http://www.raytac.com">www.raytac.com</a> TEL#: +886-2-3234-0208 E-mail#: <a href="mailto:service@raytac.com">service@raytac.com</a>
<b>Product:</b>	BLE Module
<b>Brand Name/Trade Mark:</b>	Raytac Corporation
<b>Model/Type:</b>	MDBT42TV
<b>Added Model(s):</b>	MDBT42TV-P
<b>Applicable Standards:</b>	EN 301 489 –1 v2.2.3 : 2019-11 EN 301 489 –17 v3 2.2 : 2019-12 (Draft) EN 55032 : 2015+AC:2016-07 EN 61000-4-2 : 2009 EN 61000-4-3 : 2006+A1:2008+A2:2010
<b>Test Laboratory:</b>	SGS Taiwan Ltd. Electromagnetic Compatibility Laboratory No.2, Keji 1st Rd., Guishan District, Taoyuan City, Taiwan
<b>Test Report No.:</b>	MH/2020/80039, dated on Sep. 11, 2020

**Conclusion:** Based upon a review of the Test Report(s), the tested sample of the product mentioned above is deemed to comply with the requirements of the above standards.

**Note:** This verification is only valid for the product and configuration described and in conjunction with the test report as detailed above.

**Authorised Signatory:**



---

SGS Taiwan Ltd.  
Eddy Cheng  
Assistant Supervisor

# 11.6. IC Certificate (Canada)

## BLE 1 Mbps & 2 Mbps

SGS

<b>Certificate</b>	US0186.2020.000407
SGS Reference	CCS-CERT201000039-02
<b>Certified Product</b>	MDBT42TV, MDBT42TV-P
ISED ID Number	8017A-MDBT42TV
Type of Equipment	Bluetooth device
<b>Certificate Holder</b>	Raytac Corp.
Address	5F, No.3, Jiankang Road, New Taipei City 23586 Taiwan

*Certification of equipment means only that the equipment has met the requirements of the above-noted specification. Licence applications, where applicable to use certified equipment, are acted on accordingly by the Industry Canada issuing office and will depend on the existing radio environment, service and location of operation. This certificate is issued on condition that the holder complies and will continue to comply with the requirements and procedures issued by Industry Canada. The equipment for which this certificate is issued shall not be manufactured, imported, distributed, leased, offered for sale or sold unless the equipment complies with the applicable technical specifications and procedures issued by Industry Canada.*

*La certification du matériel signifie seulement que le matériel a satisfait aux exigences de la norme indiquée ci-dessus. Les demandes de licences nécessaires pour l'utilisation du matériel certifié sont traitées en conséquence par le bureau de délivrance d'Industrie Canada et dépendent des conditions radio ambiantes, du service et de l'emplacement d'exploitation. Le présent certificat est délivré à la condition que le titulaire satisfasse et continue de satisfaire aux exigences et aux procédures d'Industrie Canada. Le matériel à l'égard duquel le présent certificat est délivré ne doit pas être fabriqué, importé, distribué, loué, mis en vente ou vendu à moins d'être conforme aux procédures et aux spécifications techniques applicables publiées par Industrie Canada.*

*I hereby attest that the subject equipment was tested and found in compliance with the above-noted specification.*

*J'atteste par la présente que le matériel a fait l'objet d'essai et jugé conforme à la spécification ci-dessus.*

Authorized By	Date Issued
Sen. Ly Certifier	11/12/2020

US0186

This Certificate is valid only with a concurrent listing with Industry Canada Radio Listing (REL).

SGS North America, Inc.  
620 Old Peachtree Road, Ste. 100, Suwanee, GA 30024, USA  
t +1 770 570 1800 f +1 770 277 1240 www.sgs.com  
Page 1 of 2

<b>EQUIPMENT DETAIL</b>				
Frequency Range (MHz)	RF Power (Watts)	Antenna Type	Necessary Bandwidth(kHz)	Emission Classification
2402.0-2480.0	0.0034	Note 1	2027.4	F1D

Notes 1) Chip antenna: -5.81dBi, PCB Antenna: -6.50dBi

<b>SPECIFICATION</b>		
Standard/Specification	Issue	Issue Date
RSS-247	Issue 2	February 2017



## 11.7. SRRC Certificate (China)

**BLE 1 Mbps & 2 Mbps**



## 11.8. KC Certificate (South Korea)

### BLE 1 Mbps & 2 Mbps

BD03-3779-71C5-6834

방송통신기자재등의 적합인증서 Certificate of Broadcasting and Communication Equipments	
상호 또는 성명 Trade Name or Applicant	Raytac Corporation
기자재명칭(명칭) Equipment Name	특정소출력 무선기기(무선데이터통신시스템용 무선기기)
기본모델명 Basic Model Number	MDBT42TV
파생모델명 Series Model Number	MDBT42TV-P
인증번호 Certification No.	R-C-ryt-MDBT42TV
제조사/제조국가 Manufacturer/ Country of Origin	Raytac Corporation / 대만
인증연월일 Date of Certification	2020-09-14
기타 Others	
위 기자재는 「전파법」 제58조의2 제2항에 따라 인증되었음을 증명합니다. It is verified that foregoing equipment has been certificated under the Clause 2, Article 58-2 of Radio Waves Act.	
2020년(Year) 09월(Month) 14일(Day)	
국립전파연구원장 	
Director General of National Radio Research Agency	
※ 인증받은 방송통신기자재는 반드시 "적합성평가표시" 를 부착하여 유통하여야 합니다. 위반시 과태료 처분 및 인증이 취소될 수 있습니다.	

## 11.9. RoHS & REACH Report

Please visit "[Support](#)" page of our website to download.

## 11.10. End-Product Label

It is suggested using following content adding to package or user manual or label to obey the regulation. Any rules of end-product label shall refer to each certification for final reference.

### 11.10.1. FCC (USA)

The FCC statement should be included in the user manual when there is no enough space on label. Otherwise, it should be included on the label.

"This device complies with part 15 of the FCC rules. Operation is subject to the following two conditions. (1) This device may not cause harmful interference. (2) This device must accept any interference received, including interference that may cause undesired operation."

The final end product must be labeled in a visible area with the following: "Contain FCC ID: SH6MDBT42TV".

### 11.10.2. TELEC (Japan)

When manufacturer is placing the product on the Japanese market, the product must be affixed with the following Specified Radio Equipment marking:



**R** 201-200783

### 11.10.3. NCC (Taiwan)

請依下列標籤式樣自製標籤，標貼或印鑄於器材本體明顯處，始得販賣或公開陳列。

#### MDBT42TV Series

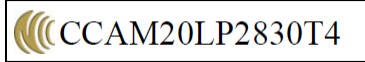

#### MDBT42TV-P Series

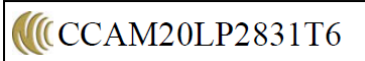

平台廠商必須於平台上標示字樣「本產品內含射頻模組：ID 編號 CCAM20LP2830T4」或「本產品內含射頻模組：ID 編號 CCAM20LP2831T6」。

「平台」定義如下：若器材組裝本案模組，消費者仍能正常使用該器材主要功能，該器材得視為平台。若器材不組裝本案模組，消費者不能正常使用該器材主要功能，該器材不能視為平台。該類不同廠牌型號器材組裝本案審驗模組後，須分別申請型式認證。

### 11.10.4. IC (Canada)

The IC statement should be included in the user manual when there is no enough space on label. Otherwise, it should be included on the label.

“This device complies with Industry Canada license-exempt RSS Standard(s). Operation is subject to the following two conditions. (1) This device may not cause harmful interference. (2) This device must accept any interference received, including interference that may cause undesired operation.

Le présent appareil est conforme aux CNR d'Industrie Canada applicables aux appareils radio exempts de licence. L'exploitation est autorisée aux deux conditions suivantes: (1) l'appareil ne doit pas produire de brouillage, et (2) l'utilisateur de l'appareil doit accepter tout brouillage radioélectrique subi, même si le brouillage est susceptible d'en compromettre le fonctionnement.”

The final end product must be labeled in a visible area with the following: “Contain IC ID: 8017A-MDBT42TV”.

## 12. Notes and Cautions

Module is not designed to last for a lifetime. Like general products, it is expected to be worn out after continuous usage through the years. To assure that product will perform better and last longer, please make sure you:

- Follow the guidelines of this document while designing circuit/end-product. Any discrepancy of core Bluetooth technology and technical specification of IC should refer to definition of Bluetooth Organization and Nordic Semiconductor as final reference.
- Do not supply voltage that is not within range of specification.
- Eliminate static electricity at any cost when working with the module as it may cause damage. It is highly recommended adding anti-ESD components to circuit design to prevent damage from real-life ESD events. Anti-ESD methods can be also applied in mechanical design.
- Do not expose modules under direct sunlight for long duration. Modules should be kept away from humid and salty air conditions, and any corrosive gasses or substances. Store it within  $-40^{\circ}\text{C}$  to  $+125^{\circ}\text{C}$  before and after installation.
- Avoid any physical shock, intense stress to the module or its surface.
- Do not wash the module. No-Clean Paste is used in production. Washing it will oxidize the metal shield and have chemistry reaction with No-Clean Paste. Functions of the module are not guaranteed if it has been washed.

The module is not suitable for life support device or system and not allowed to be used in destructive device or systems in any direct or indirect ways. The customer agrees to indemnify Raytac for any losses when applying modules in applications such as the ones described above.



# 13. Basic Facts for nRF52 Chip

Below chart shows basic spec for Nordic nRF52 family, which is helpful to understand the differences between each SoC. Any discrepancy shall refer to Nordic’s technical document as final reference.

See [Full List of Raytac’s BLE Modules](#) for complete model no. of each item.

Nordic Solution	nRF52840	nRF52833	nRF52820	nRF52832	nRF52810	nRF52811	nRF52805
RAYTAC Model No. (MDBTXX)	50Q series	50Q series 50 series	50 series	42Q series 42 series 42V series	42Q series	42Q Series	42T series 42TV series
Bluetooth Direction Finding		V	V			V	
Bluetooth 5 Long Range (125kbps)	V	V	V			V	
Bluetooth 5 High Speed	V	V	V	V	V	V	V
Bluetooth 5 Ad. Extention (x8)	V	V	V	V	V	V	V
Flash (kBytes)	1024	512	256	512	192	192	192
RAM (kBytes)	256	128	32	64	24	24	24
ANT Plus	V	V	V	V	V	V	
IEEE 802.15.4	V	V	V			V	
ARM® TrustZone® Cryptocell	V						
USB	V	V	V				
QSPI	V						
NFC	V	V		V			
I2S	V	V		V			
SPI, TWI, UART, PWM	V	V	V	V	V	V	without PWM
PDM	V	V		V	V	V	
ADC, Comparators	V	V	without ADC	V	V	V	without comparators
Supply Range (V)	1.7 to 5.5	1.7 to 5.5	1.7 to 5.5	1.7 to 3.6	1.7 to 3.6	1.7 to 3.6	1.7 to 3.6

## 14. Useful Links

- Nordic Infocenter: <https://infocenter.nordicsemi.com/index.jsp>  
All the necessary technical files and software development kits of Nordic's chip are on this website.
- Nordic Developer Zone: <https://devzone.nordicsemi.com/questions/>  
A highly recommended website for firmware developer. Interact with other developers and Nordic's employees will help with your questions. The site also includes tutorials in detail to help you get started.
- Official Page of nRF52805 : <https://www.nordicsemi.com/Products/Low-power-short-range-wireless/nRF52805>  
A brief introduction to nRF52805 and download links for Nordic's developing software and SoftDevices.

# History of Firmware Revision

<b>FW Ver.</b>	<b>Compatible HW Build</b>	<b>Release Date</b>	<b>Description of Revision</b>	<b>Note</b>
1.0		2020/12/09	1 <sup>st</sup> release.	99-52805-03A

# Full List of Raytac's BLE Modules

## ● MDBT40 Series

Series	Nordic Solution	Raytac No.	IC Ver.	Antenna	RAM	Flash Memory
MDBT40	nRF51822	MDBT40-256V3	3	Chip Antenna	16 kb	256 K
		MDBT40-256RV3			32 kb	256 K
MDBT40-P	nRF51822	MDBT40-P256V3	3	PCB Antenna	16 kb	256 K
		MDBT40-P256RV3			32 kb	256 K

## ● MDBT42Q Series (QFN Package IC)

Series	Nordic Solution	Raytac No.	IC Ver.	Antenna	RAM	Flash Memory
MDBT42Q	nRF52832	MDBT42Q-512KV2	2	Chip Antenna	64 kb	512 K
	nRF52810	MDBT42Q-192KV2	2		24 kb	192 K
	nRF52811	MDBT42Q-192KL	1			
MDBT42Q-P	nRF52832	MDBT42Q-P512KV2	2	PCB Antenna	64 kb	512 K
	nRF52810	MDBT42Q-P192KV2	2		24 kb	192 K
	nRF52811	MDBT42Q-P192KL	1			
MDBT42Q-U	nRF52832	MDBT42Q-U512KV2	2	u.FL Connector	64 kb	512 K

## ● MDBT42 Series (WLCSP Package IC)

Series	Nordic Solution	Raytac No.	IC Ver.	Antenna	RAM	Flash Memory
MDBT42	nRF52832	MDBT42-512KV2	2	Chip Antenna	64 kb	512 K
MDBT42-P		MDBT42-P512KV2		PCB Antenna		

## ● MDBT42V Series (WLCSP Package IC)

Series	Nordic Solution	Raytac No.	IC Ver.	Antenna	RAM	Flash Memory
MDBT42V	nRF52832	MDBT42V-512KV2	2	Chip Antenna	64 kb	512 K
MDBT42V-P		MDBT42V-P512KV2		PCB Antenna		

## ● MDBT42T Series (WLCSP Package IC)

Series	Nordic Solution	Raytac No.	IC Ver.	Antenna	RAM	Flash Memory
MDBT42T	nRF52805	MDBT42T-192K	1	Chip Antenna	24 kb	192 K
MDBT42T-P		MDBT42T-P192K		PCB Antenna		

## ● MDBT42TV Series (WLCSP Package IC)

Series	Nordic Solution	Raytac No.	IC Ver.	Antenna	RAM	Flash Memory
MDBT42TV	nRF52805	MDBT42TV-192K	1	Chip Antenna	24 kb	192 K
MDBT42TV-P		MDBT42TV-P192K		PCB Antenna		

## ● MDBT50Q Series (aQFN Package IC)

Series	Nordic Solution	Raytac No.	IC Ver.	Antenna	RAM	Flash Memory
MDBT50Q	nRF52840	MDBT50Q-1MV2	2	Chip Antenna	256 kb	1 MB
	nRF52833	MDBT50Q-512K	1		128 kb	512 kb
MDBT50Q-P	nRF52840	MDBT50Q-P1MV2	2	PCB Antenna	256 kb	1 MB
	nRF52833	MDBT50Q-P512K	1		128 kb	512 kb
MDBT50Q-U	nRF52840	MDBT50Q-U1MV2	2	u.FL Connector	256 kb	1 MB
	nRF52833	MDBT50Q-U512K	1		128 kb	512 kb
Dongle	nRF52840	MDBT50Q-RX	1, 2	PCB Antenna	256 kb	1 MB

## ● MDBT50 Series (QFN Package IC)

Series	Nordic Solution	Raytac No.	IC Ver.	Antenna	RAM	Flash Memory
MDBT50	nRF52820	MDBT50-256R	1	Chip Antenna	32 kb	256 kb
	nRF52833	MDBT50-512K	1		128 kb	512 kb
MDBT50-P	nRF52820	MDBT50-P256R	1	PCB Antenna	32 kb	256 kb
	nRF52833	MDBT50-P512K	1		128 kb	512 kb

## ● MDBT53 Series (WLCSP Package IC)

Series	Nordic Solution	Raytac No.	IC Ver.	Antenna	RAM	Flash Memory
MDBT53	nRF5340	MDBT53-1M	1	Chip Antenna	512 kb	1 MB
MDBT53-P	nRF5340	MDBT53-P1M	1	PCB Antenna	512 kb	1 MB
MDBT53-U	nRF5340	MDBT53-U1M	1	u.FL Connector	512 kb	1 MB

## ● MDBT53V Series (WLCSP Package IC)

Series	Nordic Solution	Raytac No.	IC Ver.	Antenna	RAM	Flash Memory
MDBT53V	nRF5340	MDBT53V-1M	1	Chip Antenna	512 kb	1 MB
MDBT53V-P	nRF5340	MDBT53V-P1M	1	PCB Antenna	512 kb	1 MB

# Release Note

- 2020/12/09 Version A: 1<sup>st</sup> release
- 2023/08/01 Version B
  - (1) Updated drawing in Chapter 5 for a better understanding of PCB measurement & RF Layout Suggestion.
  - (2) Updated Full List of Raytac's BLE modules.
  - (3) Updated Chapter 8: Specification corresponding to Nordic's new nRF52805 Product Specification V1.3.

