







PARTS LIST			
ITEM	QTY	PART NAME	Link URL
1	1	ZP90.90.60 - Assemble	<a href="https://www.kradex.com.pl/products/1113/ZP90_90_60.pdf">https://www.kradex.com.pl/products/1113/ZP90_90_60.pdf</a>
2	1	Schneider XB5AS8442	<a href="https://www.se.com/pl/pl/product/XB5AS8442/harmony-xb5-przycisk-stop-awaryjny-%C3%B840-czerwony-plastikowy/">https://www.se.com/pl/pl/product/XB5AS8442/harmony-xb5-przycisk-stop-awaryjny-%C3%B840-czerwony-plastikowy/</a>
3	1	Gasket	<a href="https://www.kradex.com.pl/product/akcesoria/uszczelka?lang=pl">https://www.kradex.com.pl/product/akcesoria/uszczelka?lang=pl</a>
4	1	Gland M16	<a href="https://www.kradex.com.pl/products/1102/D%C5%82awnica.pdf">https://www.kradex.com.pl/products/1102/D%C5%82awnica.pdf</a>

TITLE		ZEB90.90.60-1 ES		PART	Assemble	MATERIAL	
Design by:	Kruhlianytsia O.	Sig.		Desing Date:	2023-03-27		
Approved by:	Drzazgowski M.	Sig.		Approved Data	2023-06-14		
		All rights reserved, Copyright Kradex 2023			FORMAT	A3	
		SCALE	1 : 1	UNIT	mm	PROJECTION	 SHEET 1/3

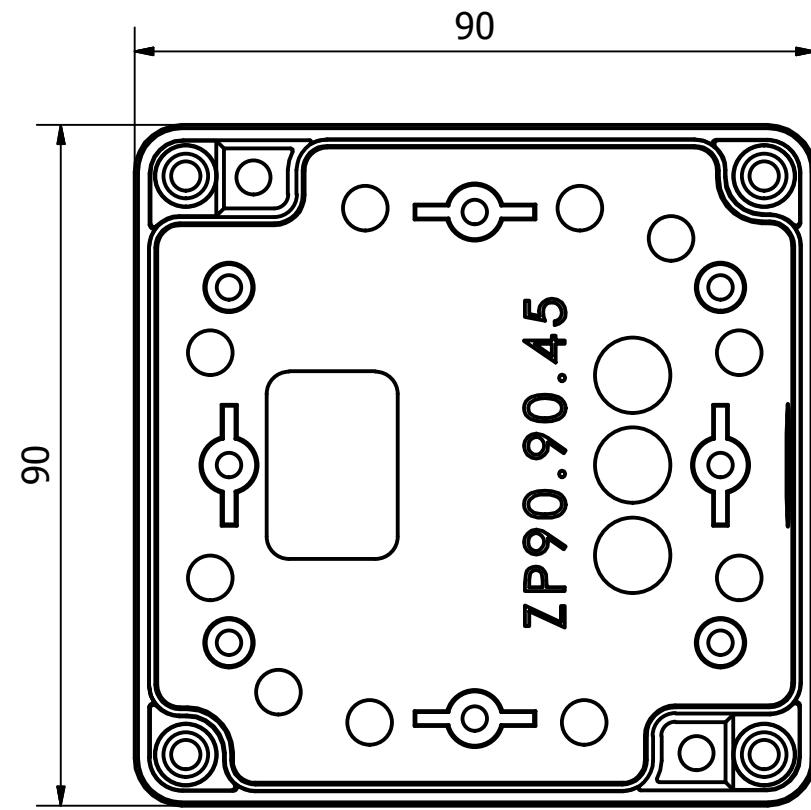
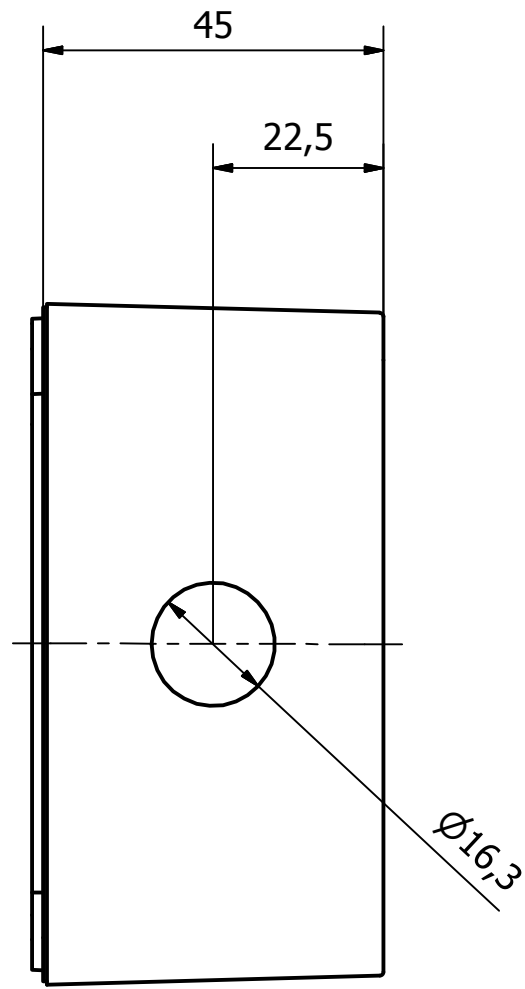

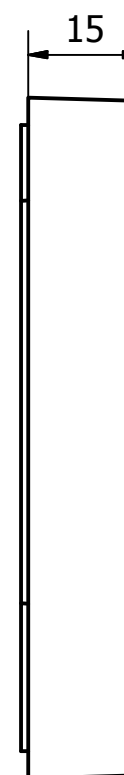
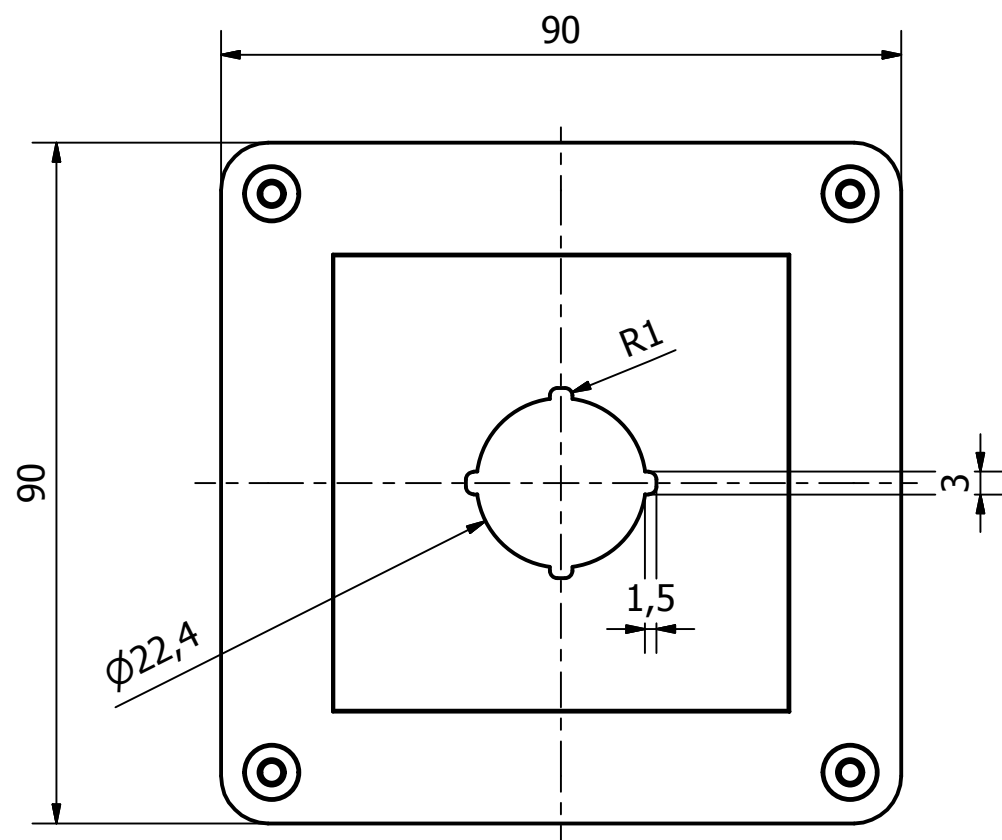
TITLE		ZEB90.90.60-1 ES		PART	Base	MATERIAL	ABS	
Design by:	Kruhlianytsia O.	Sig.		Desing Date:	2023-03-27			
Approved by:	Drzazgowski M.	Sig.		Approved Date:	2023-06-14			
		All rights reserved, Copyright Kradex 2023				FORMAT		A3
		SCALE	1 : 1	UNIT	mm	PROJECTION	 SHEET 2/3	



TITLE		ZEB90.90.60-1 ES	PART	Cover	MATERIAL	ABS
Design by:	Kruhlianytsia O.	Sig.	Desing Date:		2023-03-27	
Approved by:	Drzazgowski M.	Sig.	Approved Date:		2023-06-14	
		All rights reserved, Copyright Kradex 2023			FORMAT	
		SCALE	UNIT	PROJECTION	SHEET	
		1 : 1	mm		3/3	