

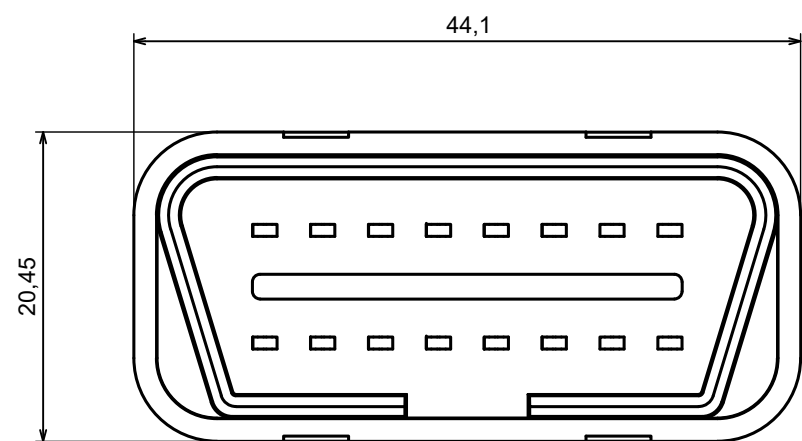

A |

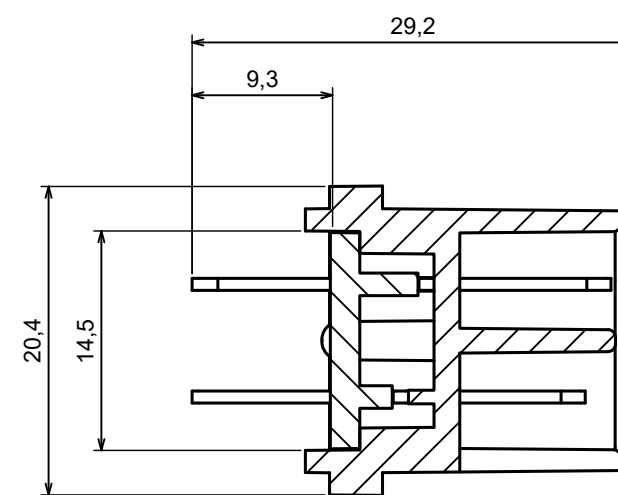

A |

A-A



All rights reserved, Copyright Kradox 2023		
Product model	ZOB CAP PLUG - Assembly	
Format: A3	Material: ABS	
Scale 2:1	Tolerance: +/- 0.5	



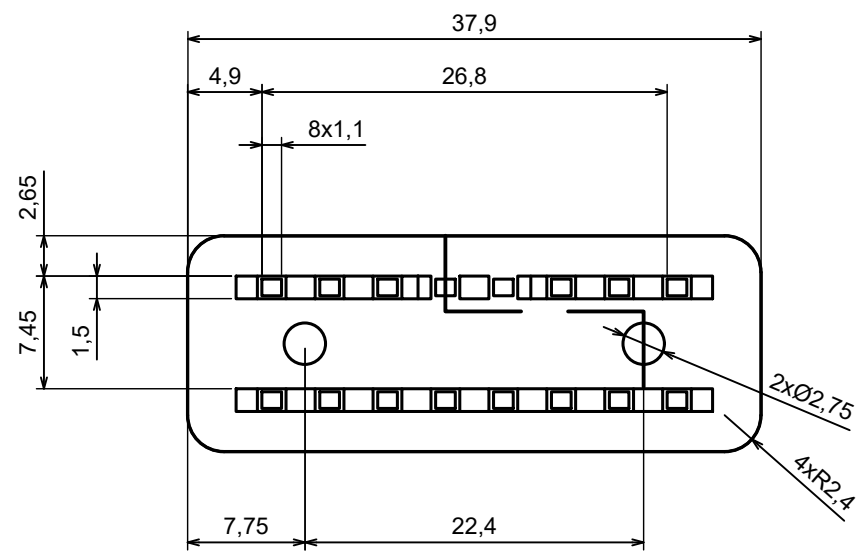

A |



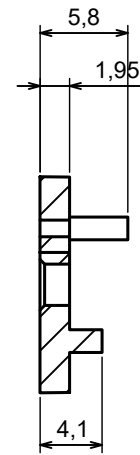

A |

A-A

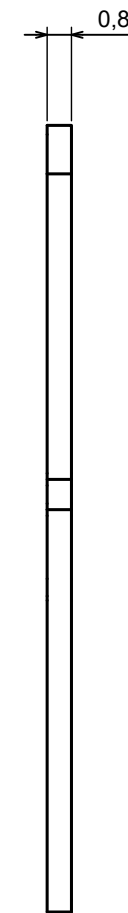
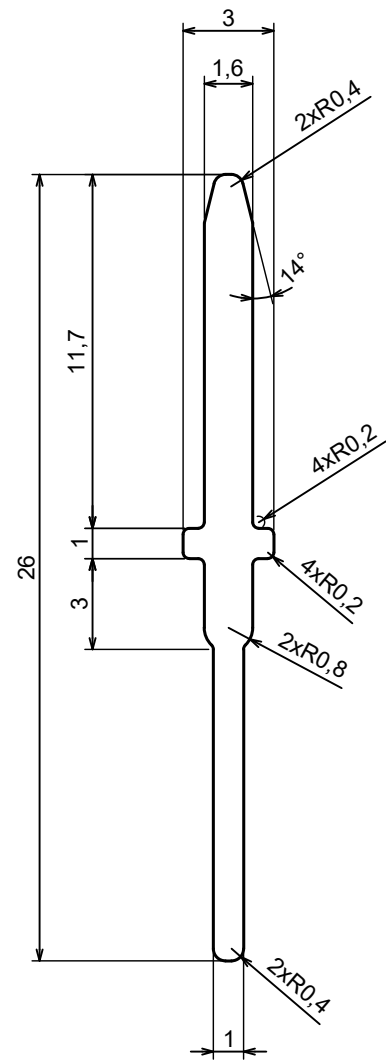

All rights reserved, Copyright Kradox 2023		
Product model	ZOB D CAP PLUG CAP	
Format: A3	Material: ABS	
Scale 2:1	Tolerance: +/- 0.5	



All rights reserved, Copyright Kradox 2023		
Product model	ZOBD CAP PLUG PIN	
Format: A3	Material: b6z6	
Scale 4:1	Tolerance: +/- 0.5	