

ESP32-S3

Technical Reference Manual



Version 1.2
Espressif Systems
Copyright © 2023

About This Document

The **ESP32-S3** is targeted at developers working on low level software projects that use the ESP32-S3 SoC. It describes the hardware modules listed below for the ESP32-S3 SoC and other products in ESP32-S3 series. The modules detailed in this document provide an overview, list of features, hardware architecture details, any necessary programming procedures, as well as register descriptions.

Navigation in This Document

Here are some tips on navigation through this extensive document:

- [Release Status at a Glance](#) on the very next page is a minimal list of all chapters from where you can directly jump to a specific chapter.
- Use the **Bookmarks** on the side bar to jump to any specific chapters or sections from anywhere in the document. Note this PDF document is configured to automatically display **Bookmarks** when open, which is necessary for an extensive document like this one. However, some PDF viewers or browsers ignore this setting, so if you don't see the **Bookmarks** by default, try one or more of the following methods:
 - Install a PDF Reader Extension for your browser;
 - Download this document, and view it with your local PDF viewer;
 - Set your PDF viewer to always automatically display the **Bookmarks** on the left side bar when open.
- Use the native **Navigation** function of your PDF viewer to navigate through the documents. Most PDF viewers support to go **Up**, **Down**, **Previous**, **Next**, **Back**, **Forward** and **Page** with buttons, menu or hot keys.
- You can also use the built-in **GoBack** button on the upper right corner on each and every page to go back to the previous place before you click a link within the document. Note this feature may only work with some Acrobat-specific PDF viewers (for example, Acrobat Reader and Adobe DC) and browsers with built-in Acrobat-specific PDF viewers or extensions (for example, Firefox).

Release Status at a Glance

No.	ESP32-S3 Chapters	Progress	No.	ESP32-S3 Chapters	Progress
1	Processor Instruction Extensions (PIE)	Published	21	SHA Accelerator (SHA)	Published
2	ULP Coprocessor (ULP-FSM, ULP-RISC-V)	Published	22	Digital Signature (DS)	Published
3	GDMA Controller (GDMA)	Published	23	External Memory Encryption and Decryption (XTS_AES)	Published
4	System and Memory	Published	24	Random Number Generator (RNG)	Published
5	eFuse Controller	Published	25	Clock Glitch Detection	Published
6	IO MUX and GPIO Matrix (GPIO, IO MUX)	Published	26	UART Controller (UART)	Published
7	Reset and Clock	Published	27	SPI Controller (SPI)	Published
8	Chip Boot Control	Published	28	I2C Controller (I2C)	Published
9	Interrupt Matrix (INTERRUPT)	Published	29	I2S Controller (I2S)	Published
10	Low-power Management (RTC_CNTL)	Published	30	Pulse Count Controller (PCNT)	Published
11	System Timer (SYSTIMER)	Published	31	USB On-The-Go (USB)	Published
12	Timer Group (TIMG)	Published	32	USB Serial/JTAG Controller (USB_SERIAL_JTAG)	Published
13	Watchdog Timers (WDT)	Published	33	Two-wire Automotive Interface (TWAI®)	Published
14	XTAL32K Watchdog Timers (XTWDT)	Published	34	SD/MMC Host Controller (SDHOST)	Published
15	Permission Control (PMS)	Published	35	LED PWM Controller (LEDC)	Published
16	World Controller (WCL)	Published	36	Motor Control PWM (MCPWM)	Published
17	System Registers (SYSTEM)	Published	37	Remote Control Peripheral (RMT)	Published
18	AES Accelerator (AES)	Published	38	LCD and Camera Controller (LCD_CAM)	Published
19	HMAC Accelerator (HMAC)	Published	39	On-Chip Sensors and Analog Signal Processing	Published
20	RSA Accelerator (RSA)	Published			

Note:

Check the link or the QR code to make sure that you use the latest version of this document:
https://www.espressif.com/documentation/esp32-s3_technical_reference_manual_en.pdf



Contents

1	Processor Instruction Extensions (PIE)	36
1.1	Overview	36
1.2	Features	36
1.3	Structure Overview	36
1.3.1	Bank of Vector Registers	37
1.3.2	ALU	38
1.3.3	QACC Accumulator Register	38
1.3.4	ACCX Accumulator Register	38
1.3.5	Address Unit	38
1.4	Syntax Description	38
1.4.1	Bit/Byte Order	39
1.4.2	Instruction Field Definition	40
1.5	Components of Extended Instruction Set	42
1.5.1	Registers	42
1.5.1.1	General-Purpose Registers	43
1.5.1.2	Special Registers	43
1.5.2	Fast GPIO Interface	45
1.5.2.1	GPIO_OUT	45
1.5.2.2	GPIO_IN	45
1.5.3	Data Format and Alignment	45
1.5.4	Data Overflow and Saturation Handling	46
1.6	Extended Instruction List	47
1.6.1	Read Instructions	49
1.6.2	Write Instructions	50
1.6.3	Data Exchange Instructions	51
1.6.4	Arithmetic Instructions	52
1.6.5	Comparison Instructions	56
1.6.6	Bitwise Logical Instructions	57
1.6.7	Shift Instructions	57
1.6.8	FFT Dedicated Instructions	58
1.6.9	GPIO Control Instructions	59
1.6.10	Processor Control Instructions	59
1.7	Instruction Performance	61
1.7.1	Data Hazard	61
1.7.2	Hardware Resource Hazard	70
1.7.3	Control Hazard	70
1.8	Extended Instruction Functional Description	72
2	ULP Coprocessor (ULP-FSM, ULP-RISC-V)	296
2.1	Overview	296
2.2	Features	296
2.3	Programming Workflow	297

2.4	ULP Coprocessor Sleep and Wakeup Workflow	298
2.5	ULP-FSM	300
2.5.1	Features	300
2.5.2	Instruction Set	300
2.5.2.1	ALU - Perform Arithmetic and Logic Operations	301
2.5.2.2	ST – Store Data in Memory	303
2.5.2.3	LD – Load Data from Memory	306
2.5.2.4	JUMP – Jump to an Absolute Address	307
2.5.2.5	JUMPR – Jump to a Relative Address (Conditional upon R0)	307
2.5.2.6	JUMPS – Jump to a Relative Address (Conditional upon Stage Count Register)	308
2.5.2.7	HALT – End the Program	309
2.5.2.8	WAKE – Wake up the Chip	309
2.5.2.9	WAIT – Wait for a Number of Cycles	309
2.5.2.10	TSENS – Take Measurement with Temperature Sensor	310
2.5.2.11	ADC – Take Measurement with ADC	310
2.5.2.12	REG_RD – Read from Peripheral Register	311
2.5.2.13	REG_WR – Write to Peripheral Register	311
2.6	ULP-RISC-V	312
2.6.1	Features	312
2.6.2	Multiplier and Divider	312
2.6.3	ULP-RISC-V Interrupts	313
2.6.3.1	Introduction	313
2.6.3.2	Interrupt Controller	313
2.6.3.3	Interrupt Instructions	314
2.6.3.4	RTC Peripheral Interrupts	315
2.7	RTC I2C Controller	316
2.7.1	Connecting RTC I2C Signals	316
2.7.2	Configuring RTC I2C	317
2.7.3	Using RTC I2C	317
2.7.3.1	Instruction Format	317
2.7.3.2	I2C_RD - I2C Read Workflow	318
2.7.3.3	I2C_WR - I2C Write Workflow	318
2.7.3.4	Detecting Error Conditions	319
2.7.4	RTC I2C Interrupts	319
2.8	Address Mapping	320
2.9	Register Summary	320
2.9.1	ULP (ALWAYS_ON) Register Summary	320
2.9.2	ULP (RTC_PERI) Register Summary	321
2.9.3	RTC I2C (RTC_PERI) Register Summary	321
2.9.4	RTC I2C (I2C) Register Summary	321
2.10	Registers	322
2.10.1	ULP (ALWAYS_ON) Registers	322
2.10.2	ULP (RTC_PERI) Registers	325
2.10.3	RTC I2C (RTC_PERI) Registers	329
2.10.4	RTC I2C (I2C) Registers	331

3	GDMA Controller (GDMA)	345
3.1	Overview	345
3.2	Features	345
3.3	Architecture	346
3.4	Functional Description	347
3.4.1	Linked List	347
3.4.2	Peripheral-to-Memory and Memory-to-Peripheral Data Transfer	348
3.4.3	Memory-to-Memory Data Transfer	348
3.4.4	Channel Buffer	349
3.4.5	Enabling GDMA	349
3.4.6	Linked List Reading Process	350
3.4.7	EOF	350
3.4.8	Accessing Internal RAM	351
3.4.9	Accessing External RAM	351
3.4.10	External RAM Access Permissions	352
3.4.11	Seamless Access to Internal and External RAM	353
3.4.12	Arbitration	353
3.5	GDMA Interrupts	353
3.6	Programming Procedures	354
3.6.1	Programming Procedures for GDMA's Transmit Channel	354
3.6.2	Programming Procedures for GDMA's Receive Channel	354
3.6.3	Programming Procedures for Memory-to-Memory Transfer	354
3.7	Register Summary	356
3.8	Registers	362
4	System and Memory	385
4.1	Overview	385
4.2	Features	385
4.3	Functional Description	386
4.3.1	Address Mapping	386
4.3.2	Internal Memory	387
4.3.3	External Memory	390
4.3.3.1	External Memory Address Mapping	390
4.3.3.2	Cache	390
4.3.3.3	Cache Operations	391
4.3.4	GDMA Address Space	392
4.3.5	Modules/Peripherals	393
4.3.5.1	Module/Peripheral Address Mapping	393
5	eFuse Controller	396
5.1	Overview	396
5.2	Features	396
5.3	Functional Description	396
5.3.1	Structure	396
5.3.1.1	EFUSE_WR_DIS	403
5.3.1.2	EFUSE_RD_DIS	403

5.3.1.3	Data Storage	403
5.3.2	Programming of Parameters	404
5.3.3	User Read of Parameters	406
5.3.4	eFuse VDDQ Timing	408
5.3.5	The Use of Parameters by Hardware Modules	408
5.3.6	Interrupts	408
5.4	Register Summary	409
5.5	Registers	413
6	IO MUX and GPIO Matrix (GPIO, IO MUX)	457
6.1	Overview	457
6.2	Features	457
6.3	Architectural Overview	457
6.4	Peripheral Input via GPIO Matrix	459
6.4.1	Overview	459
6.4.2	Signal Synchronization	459
6.4.3	Functional Description	460
6.4.4	Simple GPIO Input	461
6.5	Peripheral Output via GPIO Matrix	461
6.5.1	Overview	461
6.5.2	Functional Description	462
6.5.3	Simple GPIO Output	463
6.5.4	Sigma Delta Modulated Output	463
6.5.4.1	Functional Description	463
6.5.4.2	SDM Configuration	464
6.6	Direct Input and Output via IO MUX	464
6.6.1	Overview	464
6.6.2	Functional Description	464
6.7	RTC IO MUX for Low Power and Analog Input/Output	464
6.7.1	Overview	464
6.7.2	Low Power Capabilities	465
6.7.3	Analog Functions	465
6.8	Pin Functions in Light-sleep	465
6.9	Pin Hold Feature	466
6.10	Power Supply and Management of GPIO Pins	466
6.10.1	Power Supply of GPIO Pins	466
6.10.2	Power Supply Management	466
6.11	Peripheral Signals via GPIO Matrix	466
6.12	IO MUX Function List	478
6.13	RTC IO MUX Pin List	479
6.14	Register Summary	481
6.14.1	GPIO Matrix Register Summary	481
6.14.2	IO MUX Register Summary	482
6.14.3	SDM Output Register Summary	484
6.14.4	RTC IO MUX Register Summary	484
6.15	Registers	486

6.15.1	GPIO Matrix Registers	486
6.15.2	IO MUX Registers	497
6.15.3	SDM Output Registers	499
6.15.4	RTC IO MUX Registers	501
7	Reset and Clock	510
7.1	Reset	510
7.1.1	Overview	510
7.1.2	Architectural Overview	510
7.1.3	Features	510
7.1.4	Functional Description	511
7.2	Clock	512
7.2.1	Overview	512
7.2.2	Architectural Overview	512
7.2.3	Features	512
7.2.4	Functional Description	513
	7.2.4.1 CPU Clock	513
	7.2.4.2 Peripheral Clocks	513
	7.2.4.3 Wi-Fi and Bluetooth LE Clock	515
	7.2.4.4 RTC Clock	515
8	Chip Boot Control	516
8.1	Overview	516
8.2	Boot Mode Control	517
8.3	ROM Messages Printing Control	517
8.4	VDD_SPI Voltage Control	518
8.5	JTAG Signal Source Control	519
9	Interrupt Matrix (INTERRUPT)	520
9.1	Overview	520
9.2	Features	520
9.3	Functional Description	521
9.3.1	Peripheral Interrupt Sources	521
9.3.2	CPU Interrupts	525
9.3.3	Allocate Peripheral Interrupt Source to CPU _x Interrupt	526
	9.3.3.1 Allocate one peripheral interrupt source (Source _Y) to CPU _x	526
	9.3.3.2 Allocate multiple peripheral interrupt sources (Source _{Yn}) to CPU _x	527
	9.3.3.3 Disable CPU _x peripheral interrupt source (Source _Y)	527
9.3.4	Disable CPU _x NMI Interrupt	527
9.3.5	Query Current Interrupt Status of Peripheral Interrupt Source	527
9.4	Register Summary	527
9.4.1	CPU0 Interrupt Register Summary	528
9.4.2	CPU1 Interrupt Register Summary	531
9.5	Registers	536
9.5.1	CPU0 Interrupt Registers	536
9.5.2	CPU1 Interrupt Registers	540

10 Low-power Management (RTC_CNTL)	546
10.1 Introduction	546
10.2 Features	546
10.3 Functional Description	546
10.3.1 Power Management Unit	548
10.3.2 Low-Power Clocks	549
10.3.3 Timers	551
10.3.4 Voltage Regulators	552
10.3.4.1 Digital Voltage Regulator	552
10.3.4.2 Low-power Voltage Regulator	553
10.3.4.3 Flash Voltage Regulator	553
10.3.4.4 Brownout Detector	554
10.4 Power Modes Management	555
10.4.1 Power Domain	555
10.4.2 RTC States	557
10.4.3 Pre-defined Power Modes	558
10.4.4 Wakeup Source	559
10.4.5 Reject Sleep	560
10.5 Retention DMA	561
10.6 RTC Boot	562
10.7 Register Summary	564
10.8 Registers	566
11 System Timer (SYSTIMER)	613
11.1 Overview	613
11.2 Features	613
11.3 Clock Source Selection	614
11.4 Functional Description	614
11.4.1 Counter	614
11.4.2 Comparator and Alarm	615
11.4.3 Synchronization Operation	616
11.4.4 Interrupt	617
11.5 Programming Procedure	617
11.5.1 Read Current Count Value	617
11.5.2 Configure One-Time Alarm in Target Mode	617
11.5.3 Configure Periodic Alarms in Period Mode	617
11.5.4 Update After Deep-sleep and Light-sleep	618
11.6 Register Summary	618
11.7 Registers	620
12 Timer Group (TIMG)	633
12.1 Overview	633
12.2 Functional Description	634
12.2.1 16-bit Prescaler and Clock Selection	634
12.2.2 54-bit Time-base Counter	634
12.2.3 Alarm Generation	634

12.2.4	Timer Reload	635
12.2.5	RTC_SLOW_CLK Frequency Calculation	636
12.2.6	Interrupts	636
12.3	Configuration and Usage	637
12.3.1	Timer as a Simple Clock	637
12.3.2	Timer as One-shot Alarm	637
12.3.3	Timer as Periodic Alarm	637
12.3.4	RTC_SLOW_CLK Frequency Calculation	638
12.4	Register Summary	639
12.5	Registers	641
13	Watchdog Timers (WDT)	651
13.1	Overview	651
13.2	Digital Watchdog Timers	652
13.2.1	Features	652
13.2.2	Functional Description	653
13.2.2.1	Clock Source and 32-Bit Counter	653
13.2.2.2	Stages and Timeout Actions	654
13.2.2.3	Write Protection	654
13.2.2.4	Flash Boot Protection	655
13.3	Super Watchdog	655
13.3.1	Features	655
13.3.2	Super Watchdog Controller	655
13.3.2.1	Structure	656
13.3.2.2	Workflow	656
13.4	Interrupts	656
13.5	Registers	657
14	XTAL32K Watchdog Timers (XTWDT)	658
14.1	Overview	658
14.2	Features	658
14.2.1	Interrupt and Wake-Up	658
14.2.2	BACKUP32K_CLK	658
14.3	Functional Description	658
14.3.1	Workflow	659
14.3.2	BACKUP32K_CLK Working Principle	659
14.3.3	Configuring the Divisor Component of BACKUP32K_CLK	659
15	Permission Control (PMS)	661
15.1	Overview	661
15.2	Features	661
15.3	Internal Memory	661
15.3.1	ROM	662
15.3.1.1	Address	662
15.3.1.2	Access Configuration	662
15.3.2	SRAM	663

15.3.2.1	Address	663
15.3.2.2	Internal SRAM0 Access Configuration	663
15.3.2.3	Internal SRAM1 Access Configuration	664
15.3.2.4	Internal SRAM2 Access Configuration	668
15.3.3	RTC FAST Memory	669
15.3.3.1	Address	669
15.3.3.2	Access Configuration	669
15.3.4	RTC SLOW Memory	670
15.3.4.1	Address	670
15.3.4.2	Access Configuration	670
15.4	Peripherals	671
15.4.1	Access Configuration	671
15.4.2	Split Peripheral Regions into Split Regions	673
15.5	External Memory	673
15.5.1	Address	674
15.5.2	Access Configuration	674
15.5.3	GDMA	675
15.6	Unauthorized Access and Interrupts	676
15.6.1	Interrupt upon Unauthorized IBUS Access	676
15.6.2	Interrupt upon Unauthorized DBUS Access	677
15.6.3	Interrupt upon Unauthorized Access to External Memory	677
15.6.4	Interrupt upon Unauthorized Access to Internal Memory via GDMA	678
15.6.5	Interrupt upon Unauthorized peripheral bus (PIF) Access	678
15.6.6	Interrupt upon Unauthorized PIF Access Alignment	679
15.7	Protection of CPU VECBASE Registers	680
15.8	Register Locks	681
15.9	Register Summary	684
15.10	Registers	689
16	World Controller (WCL)	779
16.1	Introduction	779
16.2	Features	779
16.3	Functional Description	779
16.4	CPU's World Switch	781
16.4.1	From Secure World to Non-secure World	781
16.4.2	From Non-secure World to Secure World	782
16.4.3	Clearing the write_buffer	783
16.5	World Switch Log	784
16.5.1	Structure of World Switch Log Register	784
16.5.2	How World Switch Log Registers are Updated	784
16.5.3	How to Read World Switch Log Registers	786
16.5.4	Nested Interrupts	787
16.5.4.1	How to Handle Nested Interrupts	787
16.5.4.2	Programming Procedure	787
16.6	NMI Interrupt Masking	788
16.7	Register Summary	790

16.8	Registers	791
17	System Registers (SYSTEM)	799
17.1	Overview	799
17.2	Features	799
17.3	Function Description	799
17.3.1	System and Memory Registers	799
17.3.1.1	Internal Memory	799
17.3.1.2	External Memory	800
17.3.1.3	RSA Memory	800
17.3.2	Clock Registers	801
17.3.3	Interrupt Signal Registers	801
17.3.4	Low-power Management Registers	801
17.3.5	Peripheral Clock Gating and Reset Registers	801
17.3.6	CPU Control Registers	803
17.4	Register Summary	804
17.5	Registers	805
18	SHA Accelerator (SHA)	819
18.1	Introduction	819
18.2	Features	819
18.3	Working Modes	819
18.4	Function Description	820
18.4.1	Preprocessing	820
18.4.1.1	Padding the Message	820
18.4.1.2	Parsing the Message	821
18.4.1.3	Initial Hash Value	821
18.4.2	Hash task Process	822
18.4.2.1	Typical SHA Mode Process	822
18.4.2.2	DMA-SHA Mode Process	824
18.4.3	Message Digest	826
18.4.4	Interrupt	827
18.5	Register Summary	827
18.6	Registers	828
19	AES Accelerator (AES)	833
19.1	Introduction	833
19.2	Features	833
19.3	AES Working Modes	833
19.4	Typical AES Working Mode	834
19.4.1	Key, Plaintext, and Ciphertext	834
19.4.2	Endianness	835
19.4.3	Operation Process	837
19.5	DMA-AES Working Mode	837
19.5.1	Key, Plaintext, and Ciphertext	838
19.5.2	Endianness	838

19.5.3	Standard Incrementing Function	839
19.5.4	Block Number	839
19.5.5	Initialization Vector	839
19.5.6	Block Operation Process	840
19.6	Memory Summary	840
19.7	Register Summary	841
19.8	Registers	842
20	RSA Accelerator (RSA)	846
20.1	Introduction	846
20.2	Features	846
20.3	Functional Description	846
20.3.1	Large Number Modular Exponentiation	846
20.3.2	Large Number Modular Multiplication	848
20.3.3	Large Number Multiplication	848
20.3.4	Options for Acceleration	849
20.4	Memory Summary	850
20.5	Register Summary	851
20.6	Registers	851
21	HMAC Accelerator (HMAC)	855
21.1	Main Features	855
21.2	Functional Description	855
21.2.1	Upstream Mode	855
21.2.2	Downstream JTAG Enable Mode	856
21.2.3	Downstream Digital Signature Mode	856
21.2.4	HMAC eFuse Configuration	856
21.2.5	HMAC Initialization	857
21.2.6	HMAC Process (Detailed)	857
21.3	HMAC Algorithm Details	859
21.3.1	Padding Bits	859
21.3.2	HMAC Algorithm Structure	860
21.4	Register Summary	862
21.5	Registers	864
22	Digital Signature (DS)	870
22.1	Overview	870
22.2	Features	870
22.3	Functional Description	870
22.3.1	Overview	870
22.3.2	Private Key Operands	871
22.3.3	Software Prerequisites	871
22.3.4	DS Operation at the Hardware Level	872
22.3.5	DS Operation at the Software Level	873
22.4	Memory Summary	875
22.5	Register Summary	876

22.6	Registers	877
23	External Memory Encryption and Decryption (XTS_AES)	879
23.1	Overview	879
23.2	Features	879
23.3	Module Structure	879
23.4	Functional Description	880
23.4.1	XTS Algorithm	880
23.4.2	Key	880
23.4.3	Target Memory Space	881
23.4.4	Data Padding	881
23.4.5	Manual Encryption Block	882
23.4.6	Auto Encryption Block	883
23.4.7	Auto Decryption Block	883
23.5	Software Process	884
23.6	Register Summary	885
23.7	Registers	886
24	Clock Glitch Detection	889
24.1	Overview	889
24.2	Functional Description	889
24.2.1	Clock Glitch Detection	889
24.2.2	Reset	889
25	Random Number Generator (RNG)	890
25.1	Introduction	890
25.2	Features	890
25.3	Functional Description	890
25.4	Programming Procedure	891
25.5	Register Summary	891
25.6	Register	891
26	UART Controller (UART)	892
26.1	Overview	892
26.2	Features	892
26.3	UART Structure	893
26.4	Functional Description	894
26.4.1	Clock and Reset	894
26.4.2	UART RAM	895
26.4.3	Baud Rate Generation and Detection	896
26.4.3.1	Baud Rate Generation	896
26.4.3.2	Baud Rate Detection	897
26.4.4	UART Data Frame	898
26.4.5	AT_CMD Character Structure	898
26.4.6	RS485	899
26.4.6.1	Driver Control	899

26.4.6.2	Turnaround Delay	899
26.4.6.3	Bus Snooping	900
26.4.7	IrDA	900
26.4.8	Wake-up	901
26.4.9	Loopback Test	901
26.4.10	Flow Control	901
26.4.10.1	Hardware Flow Control	902
26.4.10.2	Software Flow Control	903
26.4.11	GDMA Mode	903
26.4.12	UART Interrupts	904
26.4.13	UHCI Interrupts	905
26.5	Programming Procedures	905
26.5.1	Register Type	906
26.5.1.1	Synchronous Registers	906
26.5.1.2	Static Registers	907
26.5.1.3	Immediate Registers	908
26.5.2	Detailed Steps	908
26.5.2.1	Initializing UART n	908
26.5.2.2	Configuring UART n Communication	909
26.5.2.3	Enabling UART n	909
26.6	Register Summary	911
26.6.1	UART Register Summary	911
26.6.2	UHCI Register Summary	912
26.7	Registers	914
26.7.1	UART Registers	914
26.7.2	UHCI Registers	934
27	I2C Controller (I2C)	953
27.1	Overview	953
27.2	Features	953
27.3	I2C Architecture	954
27.4	Functional Description	956
27.4.1	Clock Configuration	956
27.4.2	SCL and SDA Noise Filtering	956
27.4.3	SCL Clock Stretching	957
27.4.4	Generating SCL Pulses in Idle State	957
27.4.5	Synchronization	957
27.4.6	Open-Drain Output	958
27.4.7	Timing Parameter Configuration	959
27.4.8	Timeout Control	960
27.4.9	Command Configuration	961
27.4.10	TX/RX RAM Data Storage	962
27.4.11	Data Conversion	963
27.4.12	Addressing Mode	963
27.4.13	R/\overline{W} Bit Check in 10-bit Addressing Mode	963
27.4.14	To Start the I2C Controller	964

27.5	Programming Example	964
27.5.1	I2C _{master} Writes to I2C _{slave} with a 7-bit Address in One Command Sequence	964
27.5.1.1	Introduction	964
27.5.1.2	Configuration Example	965
27.5.2	I2C _{master} Writes to I2C _{slave} with a 10-bit Address in One Command Sequence	966
27.5.2.1	Introduction	966
27.5.2.2	Configuration Example	966
27.5.3	I2C _{master} Writes to I2C _{slave} with Two 7-bit Addresses in One Command Sequence	967
27.5.3.1	Introduction	968
27.5.3.2	Configuration Example	968
27.5.4	I2C _{master} Writes to I2C _{slave} with a 7-bit Address in Multiple Command Sequences	969
27.5.4.1	Introduction	970
27.5.4.2	Configuration Example	971
27.5.5	I2C _{master} Reads I2C _{slave} with a 7-bit Address in One Command Sequence	972
27.5.5.1	Introduction	972
27.5.5.2	Configuration Example	973
27.5.6	I2C _{master} Reads I2C _{slave} with a 10-bit Address in One Command Sequence	974
27.5.6.1	Introduction	974
27.5.6.2	Configuration Example	975
27.5.7	I2C _{master} Reads I2C _{slave} with Two 7-bit Addresses in One Command Sequence	976
27.5.7.1	Introduction	976
27.5.7.2	Configuration Example	977
27.5.8	I2C _{master} Reads I2C _{slave} with a 7-bit Address in Multiple Command Sequences	978
27.5.8.1	Introduction	979
27.5.8.2	Configuration Example	980
27.6	Interrupts	981
27.7	Register Summary	983
27.8	Registers	985
28	I2S Controller (I2S)	1005
28.1	Overview	1005
28.2	Terminology	1005
28.3	Features	1006
28.4	System Architecture	1007
28.5	Supported Audio Standards	1008
28.5.1	TDM Philips Standard	1009
28.5.2	TDM MSB Alignment Standard	1009
28.5.3	TDM PCM Standard	1010
28.5.4	PDM Standard	1010
28.6	TX/RX Clock	1011
28.7	I2S _n Reset	1013
28.8	I2S _n Master/Slave Mode	1013
28.8.1	Master/Slave TX Mode	1013
28.8.2	Master/Slave RX Mode	1014
28.9	Transmitting Data	1014
28.9.1	Data Format Control	1014

28.9.1.1	Bit Width Control of Channel Valid Data	1014
28.9.1.2	Endian Control of Channel Valid Data	1015
28.9.1.3	A-law/ μ -law Compression and Decompression	1015
28.9.1.4	Bit Width Control of Channel TX Data	1015
28.9.1.5	Bit Order Control of Channel Data	1016
28.9.2	Channel Mode Control	1016
28.9.2.1	I2S n Channel Control in TDM Mode	1017
28.9.2.2	I2S n Channel Control in PDM Mode	1017
28.10	Receiving Data	1020
28.10.1	Channel Mode Control	1020
28.10.1.1	I2S n Channel Control in TDM Mode	1020
28.10.1.2	I2S n Channel Control in PDM Mode	1021
28.10.2	Data Format Control	1021
28.10.2.1	Bit Order Control of Channel Data	1022
28.10.2.2	Bit Width Control of Channel Storage (Valid) Data	1022
28.10.2.3	Bit Width Control of Channel RX Data	1022
28.10.2.4	Endian Control of Channel Storage Data	1022
28.10.2.5	A-law/ μ -law Compression and Decompression	1023
28.11	Software Configuration Process	1023
28.11.1	Configure I2S n as TX Mode	1023
28.11.2	Configure I2S n as RX Mode	1024
28.12	I2S n Interrupts	1024
28.13	Register Summary	1025
28.14	Registers	1026
29	LCD and Camera Controller (LCD_CAM)	1043
29.1	Overview	1043
29.2	Features	1043
29.3	Functional Description	1043
29.3.1	Block Diagram	1043
29.3.2	Signal Description	1044
29.3.3	LCD_CAM Module Clocks	1045
29.3.3.1	LCD Clock	1045
29.3.3.2	Camera Clock	1046
29.3.4	LCD_CAM Reset	1047
29.3.5	LCD_CAM Data Format Control	1047
29.3.5.1	LCD Data Format Control	1047
29.3.5.2	Camera Data Format Control	1048
29.3.6	YUV-RGB Data Format Conversion	1049
29.3.6.1	YUV Timing	1050
29.3.6.2	Data Conversion Configuration	1050
29.4	Software Configuration Process	1051
29.4.1	Configure LCD (RGB Format) as TX Mode	1052
29.4.2	Configure LCD (I8080/MOTO6800 Format) as TX Mode	1053
29.4.3	Configure Camera as RX Mode	1055
29.5	LCD_CAM Interrupts	1056

29.6	Register Summary	1057
29.7	Registers	1058
30	SPI Controller (SPI)	1071
30.1	Overview	1071
30.2	Glossary	1071
30.3	Features	1072
30.4	Architectural Overview	1074
30.5	Functional Description	1074
30.5.1	Data Modes	1074
30.5.2	Introduction to FSPI bus and SPI3 Bus Signals	1075
30.5.3	Bit Read/Write Order Control	1078
30.5.4	Transfer Modes	1080
30.5.5	CPU-Controlled Data Transfer	1080
30.5.5.1	CPU-Controlled Master Mode	1080
30.5.5.2	CPU-Controlled Slave Mode	1081
30.5.6	DMA-Controlled Data Transfer	1082
30.5.6.1	GDMA Configuration	1082
30.5.6.2	GDMA TX/RX Buffer Length Control	1083
30.5.7	Data Flow Control in GP-SPI Master and Slave Modes	1083
30.5.7.1	GP-SPI Functional Blocks	1084
30.5.7.2	Data Flow Control in Master Mode	1085
30.5.7.3	Data Flow Control in Slave Mode	1085
30.5.8	GP-SPI Works as a Master	1086
30.5.8.1	State Machine	1087
30.5.8.2	Register Configuration for State and Bit Mode Control	1089
30.5.8.3	Full-Duplex Communication (1-bit Mode Only)	1093
30.5.8.4	Half-Duplex Communication (1/2/4/8-bit Mode)	1094
30.5.8.5	DMA-Controlled Configurable Segmented Transfer	1096
30.5.9	GP-SPI Works as a Slave	1100
30.5.9.1	Communication Formats	1100
30.5.9.2	Supported CMD Values in Half-Duplex Communication	1101
30.5.9.3	Slave Single Transfer and Slave Segmented Transfer	1104
30.5.9.4	Configuration of Slave Single Transfer	1104
30.5.9.5	Configuration of Slave Segmented Transfer in Half-Duplex	1105
30.5.9.6	Configuration of Slave Segmented Transfer in Full-Duplex	1105
30.6	CS Setup Time and Hold Time Control	1106
30.7	GP-SPI Clock Control	1107
30.7.1	Clock Phase and Polarity	1108
30.7.2	Clock Control in Master Mode	1109
30.7.3	Clock Control in Slave Mode	1109
30.8	GP-SPI Timing Compensation	1110
30.9	Differences Between GP-SPI2 and GP-SPI3	1112
30.10	Interrupts	1113
30.11	Register Summary	1115
30.12	Registers	1116

31	Two-wire Automotive Interface (TWAI®)	1149
31.1	Overview	1149
31.2	Features	1149
31.3	Functional Protocol	1149
31.3.1	TWAI Properties	1149
31.3.2	TWAI Messages	1150
31.3.2.1	Data Frames and Remote Frames	1151
31.3.2.2	Error and Overload Frames	1153
31.3.2.3	Interframe Space	1154
31.3.3	TWAI Errors	1155
31.3.3.1	Error Types	1155
31.3.3.2	Error States	1155
31.3.3.3	Error Counters	1156
31.3.4	TWAI Bit Timing	1157
31.3.4.1	Nominal Bit	1157
31.3.4.2	Hard Synchronization and Resynchronization	1158
31.4	Architectural Overview	1158
31.4.1	Registers Block	1159
31.4.2	Bit Stream Processor	1160
31.4.3	Error Management Logic	1160
31.4.4	Bit Timing Logic	1160
31.4.5	Acceptance Filter	1160
31.4.6	Receive FIFO	1160
31.5	Functional Description	1161
31.5.1	Modes	1161
31.5.1.1	Reset Mode	1161
31.5.1.2	Operation Mode	1161
31.5.2	Bit Timing	1161
31.5.3	Interrupt Management	1162
31.5.3.1	Receive Interrupt (RXI)	1163
31.5.3.2	Transmit Interrupt (TXI)	1163
31.5.3.3	Error Warning Interrupt (EWI)	1163
31.5.3.4	Data Overrun Interrupt (DOI)	1163
31.5.3.5	Error Passive Interrupt (TXI)	1164
31.5.3.6	Arbitration Lost Interrupt (ALI)	1164
31.5.3.7	Bus Error Interrupt (BEI)	1164
31.5.3.8	Bus Status Interrupt (BSI)	1164
31.5.4	Transmit and Receive Buffers	1164
31.5.4.1	Overview of Buffers	1164
31.5.4.2	Frame Information	1165
31.5.4.3	Frame Identifier	1166
31.5.4.4	Frame Data	1167
31.5.5	Receive FIFO and Data Overruns	1167
31.5.5.1	Single Filter Mode	1168
31.5.5.2	Dual Filter Mode	1168
31.5.6	Error Management	1169

31.5.6.1	Error Warning Limit	1169
31.5.6.2	Error Passive	1171
31.5.6.3	Bus-Off and Bus-Off Recovery	1171
31.5.7	Error Code Capture	1171
31.5.8	Arbitration Lost Capture	1172
31.6	Register Summary	1174
31.7	Registers	1175
32	USB On-The-Go (USB)	1188
32.1	Overview	1188
32.2	Features	1188
32.2.1	General Features	1188
32.2.2	Device Mode Features	1188
32.2.3	Host Mode Features	1188
32.3	Functional Description	1189
32.3.1	Controller Core and Interfaces	1189
32.3.2	Memory Layout	1190
32.3.2.1	Control & Status Registers	1191
32.3.2.2	FIFO Access	1191
32.3.3	FIFO and Queue Organization	1191
32.3.3.1	Host Mode FIFOs and Queues	1192
32.3.3.2	Device Mode FIFOs	1193
32.3.4	Interrupt Hierarchy	1193
32.3.5	DMA Modes and Slave Mode	1195
32.3.5.1	Slave Mode	1195
32.3.5.2	Buffer DMA Mode	1195
32.3.5.3	Scatter/Gather DMA Mode	1195
32.3.6	Transaction and Transfer Level Operation	1196
32.3.6.1	Transaction and Transfer Level in DMA Mode	1196
32.3.6.2	Transaction and Transfer Level in Slave Mode	1196
32.4	OTG	1198
32.4.1	OTG Interface	1198
32.4.2	ID Pin Detection	1199
32.4.3	Session Request Protocol (SRP)	1199
32.4.3.1	A-Device SRP	1199
32.4.3.2	B-Device SRP	1200
32.4.4	Host Negotiation Protocol (HNP)	1201
32.4.4.1	A-Device HNP	1201
32.4.4.2	B-Device HNP	1202
33	USB Serial/JTAG Controller (USB_SERIAL_JTAG)	1204
33.1	Overview	1204
33.2	Features	1204
33.3	Functional Description	1206
33.3.1	USB Serial/JTAG host connection	1206
33.3.2	CDC-ACM USB Interface Functional Description	1208

33.3.3	CDC-ACM Firmware Interface Functional Description	1209
33.3.4	USB-to-JTAG Interface	1210
33.3.5	JTAG Command Processor	1210
33.3.6	USB-to-JTAG Interface: CMD_REP usage example	1211
33.3.7	USB-to-JTAG Interface: Response Capture Unit	1211
33.3.8	USB-to-JTAG Interface: Control Transfer Requests	1212
33.4	Recommended Operation	1213
33.4.1	Internal/external PHY selection	1213
33.4.2	Runtime operation	1214
33.5	Register Summary	1216
33.6	Registers	1217
34	SD/MMC Host Controller (SDHOST)	1230
34.1	Overview	1230
34.2	Features	1230
34.3	SD/MMC External Interface Signals	1230
34.4	Functional Description	1231
34.4.1	SD/MMC Host Controller Architecture	1231
34.4.1.1	Bus Interface Unit (BIU)	1232
34.4.1.2	Card Interface Unit (CIU)	1232
34.4.2	Command Path	1232
34.4.3	Data Path	1233
34.4.3.1	Data Transmit Operation	1233
34.4.3.2	Data Receive Operation	1234
34.5	Software Restrictions for Proper CIU Operation	1234
34.6	RAM for Receiving and Sending Data	1236
34.6.1	TX RAM Module	1236
34.6.2	RX RAM Module	1236
34.7	DMA Descriptor Chain	1236
34.8	The Structure of DMA descriptor chain	1236
34.9	Initialization	1239
34.9.1	DMA Initialization	1239
34.9.2	DMA Transmission Initialization	1239
34.9.3	DMA Reception Initialization	1240
34.10	Clock Phase Selection	1240
34.11	Interrupt	1241
34.12	Register Summary	1243
34.13	Registers	1245
35	LED PWM Controller (LEDC)	1271
35.1	Overview	1271
35.2	Features	1271
35.3	Functional Description	1271
35.3.1	Architecture	1271
35.3.2	Timers	1272
35.3.2.1	Clock Source	1272

35.3.2.2	Clock Divider Configuration	1273
35.3.2.3	14-bit Counter	1274
35.3.3	PWM Generators	1275
35.3.4	Duty Cycle Fading	1276
35.3.5	Interrupts	1276
35.4	Register Summary	1277
35.5	Registers	1279
36	Motor Control PWM (MCPWM)	1286
36.1	Overview	1286
36.2	Features	1286
36.3	Submodules	1288
36.3.1	Overview	1288
36.3.1.1	Prescaler Submodule	1288
36.3.1.2	Timer Submodule	1288
36.3.1.3	Operator Submodule	1289
36.3.1.4	Fault Detection Submodule	1291
36.3.1.5	Capture Submodule	1291
36.3.2	PWM Timer Submodule	1291
36.3.2.1	Configurations of the PWM Timer Submodule	1291
36.3.2.2	PWM Timer's Working Modes and Timing Event Generation	1292
36.3.2.3	PWM Timer Shadow Register	1296
36.3.2.4	PWM Timer Synchronization and Phase Locking	1296
36.3.3	PWM Operator Submodule	1296
36.3.3.1	PWM Generator Submodule	1297
36.3.3.2	Dead Time Generator Submodule	1307
36.3.3.3	PWM Carrier Submodule	1311
36.3.3.4	Fault Handler Submodule	1313
36.3.4	Capture Submodule	1314
36.3.4.1	Introduction	1314
36.3.4.2	Capture Timer	1315
36.3.4.3	Capture Channel	1315
36.4	Register Summary	1316
36.5	Registers	1319
37	Remote Control Peripheral (RMT)	1370
37.1	Overview	1370
37.2	Features	1370
37.3	Functional Description	1370
37.3.1	Architecture	1371
37.3.2	RAM	1371
37.3.2.1	RAM Architecture	1371
37.3.2.2	Use of RAM	1372
37.3.2.3	RAM Access	1373
37.3.3	Clock	1374
37.3.4	Transmitter	1374

37.3.4.1	Normal TX Mode	1374
37.3.4.2	Wrap TX Mode	1375
37.3.4.3	TX Modulation	1375
37.3.4.4	Continuous TX Mode	1375
37.3.4.5	Simultaneous TX Mode	1376
37.3.5	Receiver	1376
37.3.5.1	Normal RX Mode	1376
37.3.5.2	Wrap RX Mode	1376
37.3.5.3	RX Filtering	1377
37.3.5.4	RX Demodulation	1377
37.3.6	Configuration Update	1377
37.4	Interrupts	1378
37.5	Register Summary	1378
37.6	Registers	1381
38	Pulse Count Controller (PCNT)	1395
38.1	Features	1395
38.2	Functional Description	1396
38.3	Applications	1398
38.3.1	Channel 0 Incrementing Independently	1398
38.3.2	Channel 0 Decrementing Independently	1399
38.3.3	Channel 0 and Channel 1 Incrementing Together	1399
38.4	Register Summary	1401
38.5	Registers	1402
39	On-Chip Sensors and Analog Signal Processing	1408
39.1	Overview	1408
39.2	Capacitive Touch Sensors	1408
39.2.1	Terminology	1408
39.2.2	Overview	1408
39.2.3	Features	1409
39.2.4	Capacitive Touch Pins	1410
39.2.5	Touch Sensors Operating Principle and Signals	1411
39.2.6	Touch FSM	1412
39.2.6.1	Measurement Process	1413
39.2.6.2	Measurement Trigger Source	1413
39.2.6.3	Scan Mode	1414
39.2.7	Touch Detection	1415
39.2.7.1	Sampled Values	1415
39.2.7.2	Hardware Touch Detection	1415
39.2.8	Noise Detection	1416
39.2.9	Proximity Mode	1417
39.2.10	Moisture Tolerance and Water Rejection	1417
39.2.10.1	Moisture Tolerance	1418
39.2.10.2	Water Rejection	1418
39.3	SAR ADCs	1418

39.3.1	Overview	1418
39.3.2	Features	1419
39.3.3	SAR ADC Architecture	1420
39.3.4	Input Signals	1422
39.3.5	ADC Conversion and Attenuation	1422
39.3.6	RTC ADC Controller	1422
39.3.7	DIG ADC Controller	1423
39.3.7.1	DIG ADC Clock	1424
39.3.7.2	DMA Support	1424
39.3.7.3	DIG ADC FSM	1424
39.3.7.4	Pattern Table	1424
39.3.7.5	Configuration Example for Multi-Channel Scanning	1426
39.3.7.6	DMA Data Format	1426
39.3.7.7	ADC Filters	1427
39.3.7.8	Threshold Monitoring	1427
39.3.8	SAR ADC2 Arbiter	1427
39.4	Temperature Sensor	1428
39.4.1	Overview	1428
39.4.2	Features	1428
39.4.3	Functional Description	1429
39.5	Interrupts	1430
39.6	Register Summary	1430
39.6.1	SENSOR (ALWAYS_ON) Register Summary	1430
39.6.2	SENSOR (RTC_PERI) Register Summary	1431
39.6.3	SENSOR (DIG_PERI) Register Summary	1432
39.7	Registers	1433
39.7.1	SENSOR (ALWAYS_ON) Registers	1433
39.7.2	SENSOR (RTC_PERI) Registers	1440
39.7.3	SENSOR (DIG_PERI) Registers	1458

40 Related Documentation and Resources 1469

Glossary 1470

Abbreviations for Peripherals 1470

Abbreviations Related to Registers 1470

Access Types for Registers 1472

Revision History 1474

List of Tables

1-1	Instruction Field Names and Descriptions	41
1-2	Register List of ESP32-S3 Extended Instruction Set	42
1-3	Data Format and Alignment	45
1-4	Extended Instruction List	48
1-5	Read Instructions	50
1-6	Write Instructions	51
1-7	Data Exchange Instructions	51
1-8	Vector Addition Instructions	52
1-9	Vector Multiplication Instructions	53
1-10	Vector Complex Multiplication Instructions	53
1-11	Vector Multiplication Accumulation Instructions	54
1-12	Vector and Scalar Multiplication Accumulation Instructions	56
1-13	Other Instructions	56
1-14	Comparison Instructions	56
1-15	Bitwise Logical Instructions	57
1-16	Shift Instructions	57
1-17	Butterfly Computation Instructions	58
1-18	Bit Reverse Instruction	58
1-19	Real Number FFT Instructions	59
1-20	GPIO Control Instructions	59
1-21	Five-Stage Pipeline of Xtensa Processor	61
1-22	Extended Instruction Pipeline Stages	62
2-1	Comparison of the Two Coprocessors	297
2-2	ALU Operations Among Registers	302
2-3	ALU Operations with Immediate Value	303
2-4	ALU Operations with Stage Count Register	303
2-5	Data Storage Type - Automatic Storage Mode	305
2-6	Data Storage - Manual Storage Mode	306
2-7	Input Signals Measured Using the ADC Instruction	310
2-8	Instruction Efficiency	312
2-9	ULP-RISC-V Interrupt Sources	313
2-10	ULP-RISC-V Interrupt Registers	314
2-11	ULP-RISC-V Interrupt List	316
2-12	Address Mapping	320
2-13	Description of Registers for Peripherals Accessible by ULP Coprocessors	320
3-1	Selecting Peripherals via Register Configuration	348
3-2	Descriptor Field Alignment Requirements for Accessing Internal RAM	351
3-3	Descriptor Field Alignment Requirements for Accessing External RAM	351
3-4	Relationship Between Configuration Register, Block Size and Alignment	352
4-1	Internal Memory Address Mapping	388
4-2	External Memory Address Mapping	390
4-3	Module/Peripheral Address Mapping	393
5-1	Parameters in eFuse BLOCK0	397

5-2	Secure Key Purpose Values	400
5-3	Parameters in BLOCK1 to BLOCK10	401
5-4	Registers Information	406
5-5	Configuration of Default VDDQ Timing Parameters	408
6-1	Bits Used to Control IO MUX Functions in Light-sleep Mode	465
6-2	Peripheral Signals via GPIO Matrix	468
6-3	IO MUX Pin Functions	478
6-4	RTC Functions of RTC IO MUX Pins	479
6-5	Analog Functions of RTC IO MUX Pins	480
7-1	Reset Sources	511
7-2	CPU Clock Source	513
7-3	CPU Clock Frequency	513
7-4	Peripheral Clocks	514
7-5	APB_CLK Fequency	515
7-6	CRYPTO_PWM_CLK Frequency	515
8-1	Default Configuration of Strapping Pins	516
8-2	Boot Mode Control	517
8-3	Control of ROM Messages Printing to UART0	518
8-4	Control of ROM Messages Printing to USB Serail/JTAG controller	518
8-5	JTAG Signal Source Control	519
9-1	CPU Peripheral Interrupt Configuration/Status Registers and Peripheral Interrupt Sources	522
9-2	CPU Interrupts	525
10-1	Low-Power Clocks	551
10-2	The Triggering Conditions for the RTC Timer	551
10-3	RTC Statues Transition	558
10-4	Predefined Power Modes	559
10-5	Wakeup Source	560
11-1	UNIT n Configuration Bits	615
11-2	Trigger Point	616
11-3	Synchronization Operation	616
12-1	Alarm Generation When Up-Down Counter Increments	635
12-2	Alarm Generation When Up-Down Counter Decrements	635
15-1	ROM Address	662
15-2	Access Configuration to ROM	662
15-3	SRAM Address	663
15-4	Internal SRAM0 Usage Configuration	664
15-5	Access Configuration to Internal SRAM0	664
15-6	Internal SRAM1 Split Regions	665
15-7	Access Configuration to the Instruction Region of Internal SRAM1	667
15-8	Access Configuration to the Data Region of Internal SRAM1	667
15-9	Internal SRAM2 Usage Configuration	669
15-10	Access Configuration to Internal SRAM2	669
15-11	RTC FAST Memory Address	669
15-12	Split RTC FAST Memory into the Higher Region and the Lower Region	670
15-13	Access Configuration to the RTC FAST Memory	670
15-14	RTC SLOW Memory Address	670

15-15 Split RTCSlow_0 and RTCSlow_1 into Split Regions	671
15-16 Access Configuration to the RTC SLOW Memory	671
15-17 Access Configuration of the Peripherals	672
15-18 Access Configuration of Peri Regions	673
15-19 Split the External Memory into Split Regions	674
15-20 Access Configuration of External Memory Regions	675
15-21 Split the External SRAM into Four Split Regions for GDMA	675
15-22 Access Configuration of External SRAM via GDMA	676
15-23 Interrupt Registers for Unauthorized IBUS Access	677
15-24 Interrupt Registers for Unauthorized DBUS Access	677
15-25 Interrupt Registers for Unauthorized Access to External Memory	678
15-26 Interrupt Registers for Unauthorized Access to Internal Memory via GDMA	678
15-27 Interrupt Registers for Unauthorized PIF Access	679
15-28 All Possible Access Alignment and their Results	679
15-29 Interrupt Registers for Unauthorized Access Alignment	680
15-30 Lock Registers and Related Permission Control Registers	681
17-1 Internal Memory Controlling Bit	800
17-2 Peripheral Clock Gating and Reset Bits	802
18-1 SHA Accelerator Working Mode	820
18-2 SHA Hash Algorithm Selection	820
18-6 The Storage and Length of Message digest from Different Algorithms	826
19-1 AES Accelerator Working Mode	834
19-2 Key Length and Encryption / Decryption	834
19-3 Working Status under Typical AES Working Mode	834
19-4 Text Endianness Type for Typical AES	835
19-5 Key Endianness Type for AES-128 Encryption and Decryption	835
19-6 Key Endianness Type for AES-256 Encryption and Decryption	836
19-7 Block Cipher Mode	837
19-8 Working Status under DMA-AES Working mode	838
19-9 TEXT-PADDING	838
19-10 Text Endianness for DMA-AES	839
20-1 Acceleration Performance	850
20-2 RSA Accelerator Memory Blocks	850
21-1 HMAC Purposes and Configuration Values	857
23-1 Key generated based on Key_A , Key_B and Key_C	881
23-2 Mapping Between Offsets and Registers	882
26-1 UART n Synchronous Registers	906
26-2 UART n Static Registers	907
27-1 I2C Synchronous Registers	958
28-2 I2S n Signal Description	1008
28-3 Bit Width of Channel Valid Data	1014
28-4 Endian of Channel Valid Data	1015
28-5 Data-Fetching Control in PDM Mode	1018
28-6 I2S n Channel Control in PDM Mode	1018
28-7 PCM-to-PDM Output Mode	1019
28-8 PDM-to-PCM Input Mode	1021

28-9	Channel Storage Data Width	1022
28-10	Channel Storage Data Endian	1023
29-1	Signal Description	1044
29-2	LCD Data Format Control	1048
29-3	CAM Data Format Control	1049
29-4	Conversion Mode Control	1051
30-2	Data Modes Supported by GP-SPI2 and GP-SPI3	1074
30-3	Functional Description of FSPI/SPI3 Bus Signals	1075
30-4	FSPI bus Signals Used in Various SPI Modes	1076
30-5	SPI3 bus Signals Used in Various SPI Modes	1077
30-6	Bit Order Control in GP-SPI Master and Slave Modes	1079
30-7	Supported Transfers in Master and Slave Modes	1080
30-8	Interrupt Trigger Condition on GP-SPI Data Transfer in Slave Mode	1083
30-9	Registers Used for State Control in 1/2/4/8-bit Modes	1090
30-10	Sending Sequence of Command Value	1092
30-11	Sending Sequence of Address Value	1093
30-12	BM Table for CONF State	1098
30-13	An Example of CONF buffer i in Segment i	1099
30-14	BM Bit Value v.s. Register to Be Updated in This Example	1099
30-15	Supported CMD Values in SPI Mode	1102
30-15	Supported CMD Values in SPI Mode	1103
30-16	Supported CMD Values in QPI Mode	1103
30-17	Clock Phase and Polarity Configuration in Master Mode	1109
30-18	Clock Phase and Polarity Configuration in Slave Mode	1109
30-19	Invalid Registers and Fields for GP-SPI3	1112
30-20	GP-SPI Master Mode Interrupts	1114
30-21	GP-SPI Slave Mode Interrupts	1114
31-1	Data Frames and Remote Frames in SFF and EFF	1152
31-2	Error Frame	1153
31-3	Overload Frame	1154
31-4	Interframe Space	1154
31-5	Segments of a Nominal Bit Time	1157
31-6	Bit Information of TWAI_BUS_TIMING_0_REG (0x18)	1162
31-7	Bit Information of TWAI_BUS_TIMING_1_REG (0x1c)	1162
31-8	Buffer Layout for Standard Frame Format and Extended Frame Format	1164
31-9	TX/RX Frame Information (SFF/EFF) TWAI Address 0x40	1165
31-10	TX/RX Identifier 1 (SFF); TWAI Address 0x44	1166
31-11	TX/RX Identifier 2 (SFF); TWAI Address 0x48	1166
31-12	TX/RX Identifier 1 (EFF); TWAI Address 0x44	1166
31-13	TX/RX Identifier 2 (EFF); TWAI Address 0x48	1166
31-14	TX/RX Identifier 3 (EFF); TWAI Address 0x4c	1166
31-15	TX/RX Identifier 4 (EFF); TWAI Address 0x50	1166
31-16	Bit Information of TWAI_ERR_CODE_CAP_REG (0x30)	1171
31-17	Bit Information of Bits SEG.4 - SEG.0	1172
31-18	Bit Information of TWAI_ARB_LOST_CAP_REG (0x2c)	1173
32-1	IN and OUT Transactions in Slave Mode	1197

32-2	UTMI OTG Interface	1198
33-1	Standard CDC-ACM Control Requests	1208
33-2	CDC-ACM Settings with RTS and DTR	1209
33-3	Commands of a Nibble	1210
33-4	USB-to-JTAG Control Requests	1212
33-5	JTAG Capabilities Descriptor	1212
33-6	Use cases and eFuse settings	1213
33-7	IO Pad Status After Chip Initialization in the USB-OTG Download Mode	1213
33-8	Reset SoC into Download Mode	1214
33-9	Reset SoC into Booting	1215
34-1	SD/MMC Signal Description	1231
34-2	Word DES0 of SD/MMC GDMA Linked List	1237
34-3	Word DES1 of SD/MMC GDMA Linked List	1238
34-4	Word DES2 of SD/MMC GDMA Linked List	1238
34-5	Word DES3 of SD/MMC GDMA Linked List	1238
34-6	SDHOST Clk Phase Selection	1241
35-1	Commonly-used Frequencies and Resolutions	1274
36-1	Configuration Parameters of the Operator Submodule	1290
36-2	Timing Events Used in PWM Generator	1298
36-3	Timing Events Priority When PWM Timer Increments	1299
36-4	Timing Events Priority when PWM Timer Decrements	1299
36-5	Dead Time Generator Switches Control Fields	1308
36-6	Typical Dead Time Generator Operating Modes	1308
37-1	Configuration Update	1377
38-1	Counter Mode. Positive Edge of Input Pulse Signal. Control Signal in Low State	1397
38-2	Counter Mode. Positive Edge of Input Pulse Signal. Control Signal in High State	1397
38-3	Counter Mode. Negative Edge of Input Pulse Signal. Control Signal in Low State	1397
38-4	Counter Mode. Negative Edge of Input Pulse Signal. Control Signal in High State	1397
39-1	ESP32-S3 Capacitive Touch Pins	1410
39-2	Smooth Algorithm	1415
39-3	Benchmark Algorithm	1415
39-4	Noise Algorithm	1416
39-5	Hysteresis Algorithm	1416
39-6	SAR ADC Input Signals	1422
39-7	Temperature Offset	1430

List of Figures

1-1	PIE Internal Structure (MAC)	37
1-2	EE.ZERO.QACC in Little-Endian Bit Order	39
1-3	EE.ZERO.QACC in Big-Endian Bit Order	39
1-4	EE.ZERO.QACC in Little-Endian Byte Order	39
1-5	EE.ZERO.QACC in Big-Endian Byte Order	40
1-6	Interlock Caused by Instruction Operand Dependency	62
1-7	Hardware Resource Hazard	70
1-8	Control Hazard	71
2-1	ULP Coprocessor Overview	296
2-2	ULP Coprocessor Diagram	297
2-3	Programming Workflow	298
2-4	ULP Sleep and Wakeup Sequence	299
2-5	Control of ULP Program Execution	300
2-6	ULP-FSM Instruction Format	301
2-7	Instruction Type — ALU for Operations Among Registers	301
2-8	Instruction Type — ALU for Operations with Immediate Value	302
2-9	Instruction Type — ALU for Operations with Stage Count Register	303
2-10	Instruction Type - ST	303
2-11	Instruction Type - Offset in Automatic Storage Mode (ST-OFFSET)	304
2-12	Instruction Type - Data Storage in Automatic Storage Mode (ST-AUTO-DATA)	304
2-13	Data Structure of RTC_SLOW_MEM[Rdst + Offset]	305
2-14	Instruction Type - Data Storage in Manual Storage Mode	305
2-15	Instruction Type - LD	306
2-16	Instruction Type - JUMP	307
2-17	Instruction Type - JUMPR	307
2-18	Instruction Type - JUMPS	308
2-19	Instruction Type - HALT	309
2-20	Instruction Type - WAKE	309
2-21	Instruction Type - WAIT	309
2-22	Instruction Type - TSENS	310
2-23	Instruction Type - ADC	310
2-24	Instruction Type - REG_RD	311
2-25	Instruction Type - REG_WR	312
2-26	Standard R-type Instruction Format	314
2-27	Interrupt Instruction - getq rd, qs	314
2-28	Interrupt Instruction - setq qd,rs	315
2-29	Interrupt Instruction - retirq	315
2-30	Interrupt Instruction — Maskirq rd rs	315
2-31	I2C Read Operation	318
2-32	I2C Write Operation	319
3-1	Modules with GDMA Feature and GDMA Channels	345
3-2	GDMA Engine Architecture	346
3-3	Structure of a Linked List	347

3-4	Channel Buffer	349
3-5	Relationship among Linked Lists	350
3-6	Dividing External RAM into Areas	352
4-1	System Structure and Address Mapping	386
4-2	Cache Structure	391
4-3	Peripherals/modules that can work with GDMA	393
5-1	Shift Register Circuit (output of first 32 bytes)	404
5-2	Shift Register Circuit (output of last 12 bytes)	404
6-1	Architecture of IO MUX, RTC IO MUX, and GPIO Matrix	458
6-2	Internal Structure of a Pad	459
6-3	GPIO Input Synchronized on APB Clock Rising Edge or on Falling Edge	460
6-4	Filter Timing of GPIO Input Signals	460
7-1	Reset Levels	510
7-2	Clock Structure	512
9-1	Interrupt Matrix Structure	520
10-1	Low-power Management Schematics	547
10-2	Power Management Unit Workflow	549
10-3	RTC Clocks	550
10-4	Wireless Clocks	550
10-5	Digital Voltage Regulator	552
10-6	Low-power Voltage Regulator	553
10-7	Flash Voltage Regulator	553
10-8	Brown-out detector	554
10-9	Brown-out detector	555
10-10	RTC States	557
10-11	ESP32-S3 Boot Flow	563
11-1	System Timer Structure	613
11-2	System Timer Alarms	614
12-1	Timer Units within Groups	633
12-2	Timer Group Architecture	634
13-1	Watchdog Timers Overview	651
13-2	Watchdog Timers in ESP32-S3	653
13-3	Super Watchdog Controller Structure	656
14-1	XTAL32K Watchdog Timer	658
15-1	Split Lines for Internal SRAM1	665
15-2	An illustration of Configuring the Category fields	666
15-3	Three Ways to Access External Memory	674
16-1	Switching From Secure World to Non-secure World	781
16-2	Switching From Non-secure World to Secure World	782
16-3	World Switch Log Register	784
16-4	Nested Interrupts Handling - Entry 9	785
16-5	Nested Interrupts Handling - Entry 1	785
16-6	Nested Interrupts Handling - Entry 4	786
21-1	HMAC SHA-256 Padding Diagram	860
21-2	HMAC Structure Schematic Diagram	860
22-1	Software Preparations and Hardware Working Process	871

23-1	External Memory Encryption and Decryption Operation Settings	879
24-1	XTAL_CLK Pulse Width	889
25-1	Noise Source	890
26-1	UART Structure	893
26-2	UART Controllers Sharing RAM	895
26-3	UART Controllers Division	896
26-4	The Timing Diagram of Weak UART Signals Along Falling Edges	897
26-5	Structure of UART Data Frame	898
26-6	AT_CMD Character Structure	898
26-7	Driver Control Diagram in RS485 Mode	899
26-8	The Timing Diagram of Encoding and Decoding in SIR mode	900
26-9	IrDA Encoding and Decoding Diagram	901
26-10	Hardware Flow Control Diagram	902
26-11	Connection between Hardware Flow Control Signals	902
26-12	Data Transfer in GDMA Mode	904
26-13	UART Programming Procedures	908
27-1	I2C Master Architecture	954
27-2	I2C Slave Architecture	954
27-3	I2C Protocol Timing (Cited from Fig.31 in The I2C-bus specification Version 2.1)	955
27-4	I2C Timing Parameters (Cited from Table 5 in The I2C-bus specification Version 2.1)	956
27-5	I2C Timing Diagram	959
27-6	Structure of I2C Command Registers	961
27-7	I2C _{master} Writing to I2C _{slave} with a 7-bit Address	964
27-8	I2C _{master} Writing to a Slave with a 10-bit Address	966
27-9	I2C _{master} Writing to I2C _{slave} with Two 7-bit Addresses	968
27-10	I2C _{master} Writing to I2C _{slave} with a 7-bit Address in Multiple Sequences	970
27-11	I2C _{master} Reading I2C _{slave} with a 7-bit Address	972
27-12	I2C _{master} Reading I2C _{slave} with a 10-bit Address	974
27-13	I2C _{master} Reading N Bytes of Data from addrM of I2C _{slave} with a 7-bit Address	976
27-14	I2C _{master} Reading I2C _{slave} with a 7-bit Address in Segments	979
28-1	ESP32-S3 I2S System Diagram	1007
28-2	TDM Philips Standard Timing Diagram	1009
28-3	TDM MSB Alignment Standard Timing Diagram	1010
28-4	TDM PCM Standard Timing Diagram	1010
28-5	PDM Standard Timing Diagram	1011
28-6	I2S _n Clock	1011
28-7	TX Data Format Control	1016
28-8	TDM Channel Control	1017
28-9	PDM Channel Control	1020
29-1	LCD_CAM Block Diagram	1044
29-2	LCD Clock	1045
29-3	Camera Clock	1046
29-4	LCD Frame Structure	1052
29-5	LCD Timing (RGB Format)	1053
29-6	LCD Timing (I8080 Format)	1054
30-1	SPI Module Overview	1074

30-2	Data Buffer Used in CPU-Controlled Transfer	1080
30-3	GP-SPI Block Diagram	1084
30-4	Data Flow Control in GP-SPI Master Mode	1085
30-5	Data Flow Control in GP-SPI Slave Mode	1085
30-6	GP-SPI State Machine in Master Mode	1088
30-7	Full-Duplex Communication Between GP-SPI2 Master and a Slave	1093
30-8	Connection of GP-SPI2 to Flash and External RAM in 4-bit Mode	1096
30-9	SPI Quad I/O Read Command Sequence Sent by GP-SPI2 to Flash	1096
30-10	Configurable Segmented Transfer in DMA-Controlled Master Mode	1097
30-11	Recommended CS Timing and Settings When Accessing External RAM	1106
30-12	Recommended CS Timing and Settings When Accessing Flash	1107
30-13	SPI Clock Mode 0 or 2	1108
30-14	SPI Clock Mode 1 or 3	1108
30-15	Timing Compensation Control Diagram in GP-SPI2 Master Mode	1110
30-16	Timing Compensation Example in GP-SPI2 Master Mode	1111
31-1	Bit Fields in Data Frames and Remote Frames	1151
31-2	Fields of an Error Frame	1153
31-3	Fields of an Overload Frame	1154
31-4	The Fields within an Interframe Space	1156
31-5	Layout of a Bit	1157
31-6	TWAI Overview Diagram	1159
31-7	Acceptance Filter	1168
31-8	Single Filter Mode	1169
31-9	Dual Filter Mode	1170
31-10	Error State Transition	1170
31-11	Positions of Arbitration Lost Bits	1173
32-1	OTG_FS System Architecture	1189
32-2	OTG_FS Register Layout	1190
32-3	Host Mode FIFOs	1192
32-4	Device Mode FIFOs	1193
32-5	OTG_FS Interrupt Hierarchy	1194
32-6	Scatter/Gather DMA Descriptor List	1195
32-7	A-Device SRP	1200
32-8	B-Device SRP	1200
32-9	A-Device HNP	1201
32-10	B-Device HNP	1202
33-1	USB Serial/JTAG High Level Diagram	1205
33-2	USB Serial/JTAG Block Diagram	1206
33-3	USB Serial/JTAG and USB-OTG Internal/External PHY Routing Diagram	1207
33-4	JTAG Routing Diagram	1208
34-1	SD/MMC Controller Topology	1230
34-2	SD/MMC Controller External Interface Signals	1231
34-3	SDIO Host Block Diagram	1232
34-4	Command Path State Machine	1233
34-5	Data Transmit State Machine	1234
34-6	Data Receive State Machine	1234

34-7	Descriptor Chain	1236
34-8	The Structure of a Linked List	1237
34-9	Clock Phase Selection	1241
35-1	LED PWM Architecture	1271
35-2	LED PWM Generator Diagram	1272
35-3	Frequency Division When LEDC_CLK_DIV is a Non-Integer Value	1273
35-4	LED_PWM Output Signal Diagram	1275
35-5	Output Signal Diagram of Fading Duty Cycle	1276
36-1	MCPWM Module Overview	1286
36-2	Prescaler Submodule	1288
36-3	Timer Submodule	1288
36-4	Operator Submodule	1289
36-5	Fault Detection Submodule	1291
36-6	Capture Submodule	1291
36-7	Count-Up Mode Waveform	1292
36-8	Count-Down Mode Waveforms	1293
36-9	Count-Up-Down Mode Waveforms, Count-Down at Synchronization Event	1293
36-10	Count-Up-Down Mode Waveforms, Count-Up at Synchronization Event	1293
36-11	UTEF and UTEZ Generation in Count-Up Mode	1294
36-12	DTEF and DTEZ Generation in Count-Down Mode	1295
36-13	DTEF and UTEZ Generation in Count-Up-Down Mode	1295
36-14	Submodules Inside the PWM Operator	1297
36-15	Symmetrical Waveform in Count-Up-Down Mode	1300
36-16	Count-Up, Single Edge Asymmetric Waveform, with Independent Modulation on PWMxA and PWMxB — Active High	1301
36-17	Count-Up, Pulse Placement Asymmetric Waveform with Independent Modulation on PWMxA	1302
36-18	Count-Up-Down, Dual Edge Symmetric Waveform, with Independent Modulation on PWMxA and PWMxB — Active High	1303
36-19	Count-Up-Down, Dual Edge Symmetric Waveform, with Independent Modulation on PWMxA and PWMxB — Complementary	1304
36-20	Example of an NCI Software-Force Event on PWMxA	1305
36-21	Example of a CNTU Software-Force Event on PWMxB	1306
36-22	Options for Setting up the Dead Time Generator Submodule	1308
36-23	Active High Complementary (AHC) Dead Time Waveforms	1309
36-24	Active Low Complementary (ALC) Dead Time Waveforms	1309
36-25	Active High (AH) Dead Time Waveforms	1310
36-26	Active Low (AL) Dead Time Waveforms	1310
36-27	Example of Waveforms Showing PWM Carrier Action	1311
36-28	Example of the First Pulse and the Subsequent Sustaining Pulses of the PWM Carrier Submodule	1312
36-29	Possible Duty Cycle Settings for Sustaining Pulses in the PWM Carrier Submodule	1313
37-1	RMT Architecture	1371
37-2	Format of Pulse Code in RAM	1372
38-1	PCNT Block Diagram	1395
38-2	PCNT Unit Architecture	1396
38-3	Channel 0 Up Counting Diagram	1398
38-4	Channel 0 Down Counting Diagram	1399

38-5	Two Channels Up Counting Diagram	1399
39-1	Touch Sensor	1409
39-2	Touch Sensor Operating Principle	1411
39-3	Touch Sensor Structure	1411
39-4	Touch FSM Structure	1412
39-5	Timing Diagram of Touch Scan	1414
39-6	Sensing Area	1417
39-7	SAR ADC Overview	1419
39-8	SAR ADC Architecture	1420
39-9	RTC ADC Controller Overview	1423
39-10	APB_SARADC_SAR1_PATT_TAB1_REG and Pattern Table Entry 0 - Entry 3	1425
39-11	APB_SARADC_SAR1_PATT_TAB2_REG and Pattern Table Entry 4 - Entry 7	1425
39-12	APB_SARADC_SAR1_PATT_TAB3_REG and Pattern Table Entry 8 - Entry 11	1425
39-13	APB_SARADC_SAR1_PATT_TAB4_REG and Pattern Table Entry 12 - Entry 15	1425
39-14	Pattern Table Entry	1425
39-15	SAR ADC1 cmd0 Configuration	1426
39-16	SAR ADC1 cmd1 Configuration	1426
39-17	DMA Data Format	1426
39-18	Temperature Sensor Overview	1429

1 Processor Instruction Extensions (PIE)

1.1 Overview

The ESP32-S3 adds a series of extended instruction set in order to improve the operation efficiency of specific AI and DSP (Digital Signal Processing) algorithms. This instruction set is designed from the TIE (Tensilica Instruction Extension) language, and adds general-purpose registers with large bit width, various special registers and processor ports. Based on the SIMD (Single Instruction Multiple Data) concept, this instruction set supports 8-bit, 16-bit, and 32-bit vector operations, which greatly increases data operation efficiency. In addition, the arithmetic instructions, such as multiplication, shifting, and accumulation, can perform data operations and transfer data at the same time, thus further increasing execution efficiency of a single instruction.

1.2 Features

The PIE (Processor Instruction Extensions) has the following features:

- 128-bit general-purpose registers
- 128-bit vector operations, e.g., multiplication, addition, subtraction, accumulation, shifting, comparison, etc.
- Integration of data transfer into arithmetic instructions
- Support for non-aligned 128-bit vector data
- Support for saturation operation

1.3 Structure Overview

A structure overview should help to understand list of available instructions, instructions possibilities, and limits. It is not intended to describe hardware details.

The internal structure of PIE for multiplication-accumulation (MAC) instructions overview could be described as shown below:

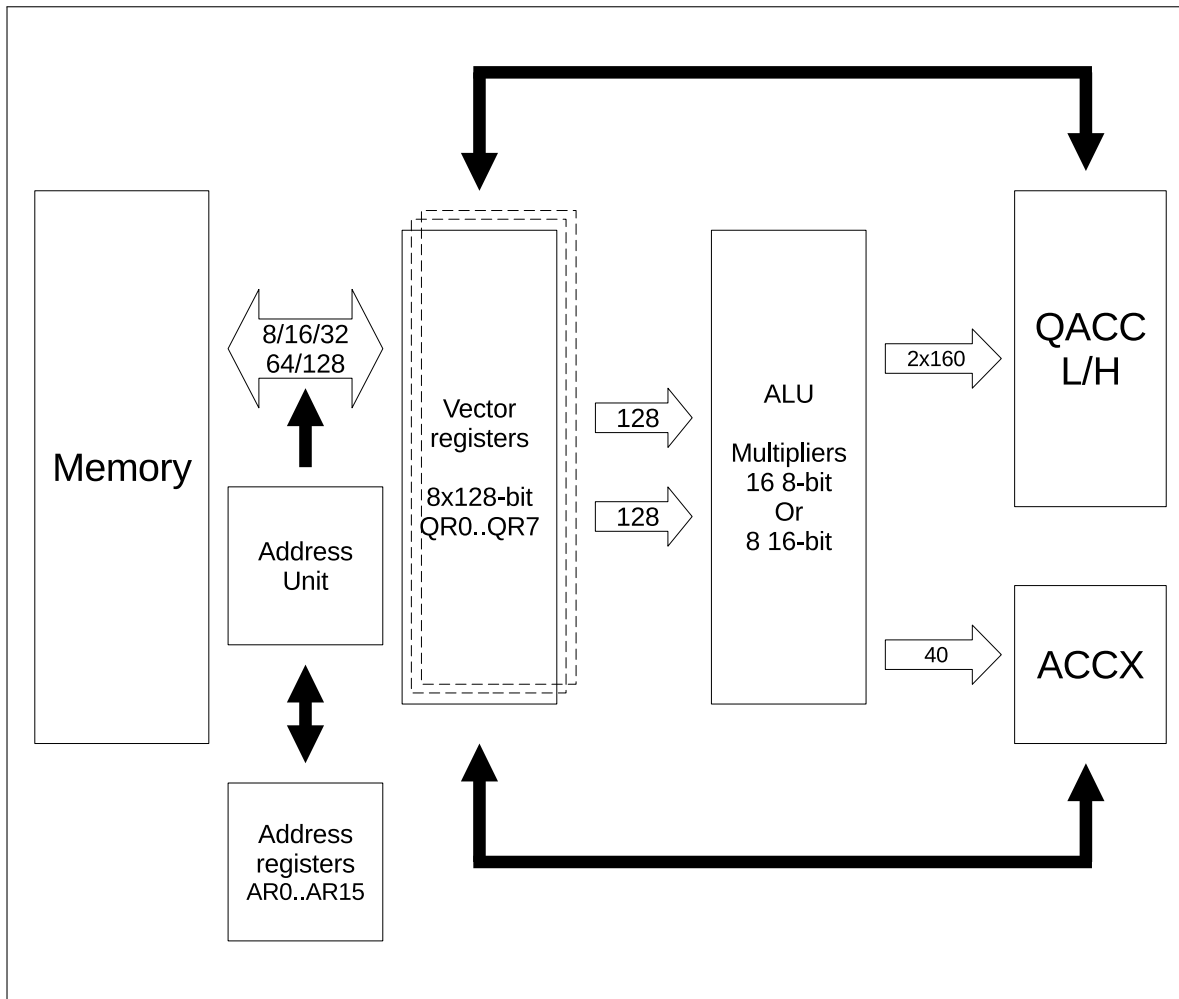

Figure 1-1. PIE Internal Structure (MAC)

The diagram above shows the data flow paths and PIE components.

The PIE unit contains:

- Address unit that reads 8/16/32/64/128-bit aligned data
- Bank of eight 128-bit vector QR registers
- Arithmetic logic unit (ALU) with
 - sixteen 8-bit multipliers
 - eight 16-bit multipliers
- QACC_H/QACC_L - 2 160-bit accumulators
- ACCX - 40-bit accumulator

1.3.1 Bank of Vector Registers

Bank of vector registers contains 8 vector registers (QR). Each register could be represented as an array of 16 x 8-bit data words, array of 8 x 16-bit data words, or array of 4 x 32-bit data words. Depending on the used instructions, 8, 16 or 32-bit data format will be chosen.

1.3.2 ALU

Arithmetic logic unit (ALU) could work for 8-bit input data, as 8-bit ALU, for 16-bit input data, as 16-bit ALU, or for 32-bit input data, as 32-bit ALU. 8-bit multiplication ALU contains 16 multipliers and is able to make up to 16 multiplications and accumulation in one instruction. With multiplication almost any other combinations of arithmetic operation are possible. For example, FFT instructions include multiplication, addition, and subtraction operations in one instruction. Also, ALU includes logic operations like AND, OR, shift, and so on. The input for ALU operation comes from QR registers. The result of operations could be saved to the QR registers or special accumulator registers (ACCX, QACC).

1.3.3 QACC Accumulator Register

The QACC accumulator register is used for multiplication-accumulation operations on 8-bit or 16-bit data. In the case of 8-bit data, QACC consists of 16 accumulator registers with 20-bit width. In the case of 16-bit data, QACC consists of 8 accumulator registers with 40-bit width. The following description reflects the case of 8-bit arithmetic. For 16-bit arithmetic, the logic is similar.

After multiplication and accumulation on two vector QR registers, the result of 16 operations will be written to 16 20-bit accumulator registers.

QACC is divided into two parts: 160-bit QACC_H and 160-bit QACC_L. The former stores the higher 160-bit data of QACC, and the latter stores the lower 160-bit data. To store the accumulator result in QR registers, it is possible to convert 20-bit result numbers to 8 bits by right-shifting it. For 16-bit multiplication-accumulation operation, convert the 40-bit result to 16-bit by right-shifting it.

It is possible to load data from memory to QACC or reset the initial value to 0.

1.3.4 ACCX Accumulator Register

Some operations require accumulating the result of all multipliers to one value. In this case, the ACCX accumulator should be used.

ACCX is a 40-bit accumulator register. The result of the accumulators could be shifted and stored in the memory as an 8-bit or 16-bit value.

It is possible to load data from memory to ACCX or reset the initial value to 0.

1.3.5 Address Unit

Most of the instructions in PIE allow loading or storing data from/to 128-bit Q registers in parallel in one cycle. In most cases, the data should be 128-bit aligned, and the lower 4 bits of address will be ignored. The Address unit provides functionality to manipulate address registers in parallel, which saves the time to update address registers.

It is possible to make address register operations like $AR + \text{signed constant}$, $AR_x + AR_y$, and $AR + 16$.

The Address unit makes post-processing operations. It means that all operations with address registers are done after instructions are finished.

1.4 Syntax Description

This section provides introduction to the encoding order of instructions and the meaning of characters that appear in the instruction descriptions.

1.4.1 Bit/Byte Order

The encoding order of instructions is divided into two types based on the granularity, i.e., bit order and byte order. According to the located side of the least bit or byte, there are big-endian order and little-endian order. That is to say, the most common encoding types for instructions are: little-endian bit order, big-endian bit order, little-endian byte order and big-endian byte order.

- Little-endian bit order: the instruction is encoded in bit order, with the least significant bit on the right.
- Big-endian bit order: the instruction is encoded in bit order, with the least significant bit on the left.
- Little-endian byte order: the instruction is encoded in byte order, with the least significant byte on the right.
- Big-endian byte order: the instruction is encoded in byte order, with the least significant byte on the left.

Among them, the instruction encoding bit sequences obtained using little-endian byte order and little-endian bit order are identical. Taking the 24-bit instruction `EE.ZERO.QACC` as an example, Figure 1-2, Figure 1-3, Figure 1-4 and Figure 1-5 show the code of this instruction in little-endian bit order, big-endian bit order, little-endian byte order and big-endian byte order, respectively.

Please note that all instructions and register descriptions appear in this chapter use little-endian bit order, which means the least significant bit is stored in the lowest addresses.

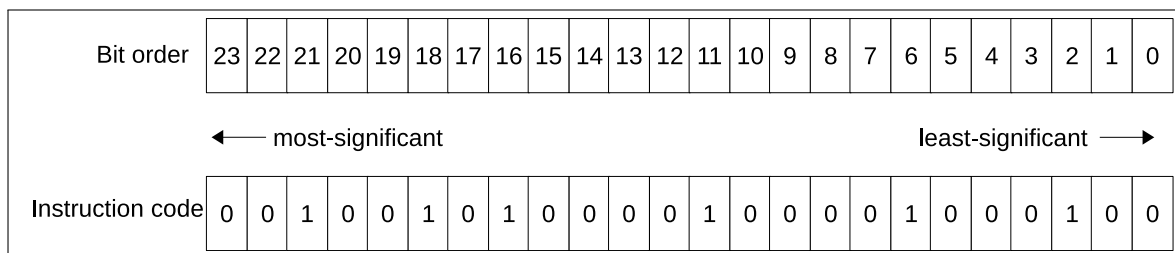

Figure 1-2. `EE.ZERO.QACC` in Little-Endian Bit Order

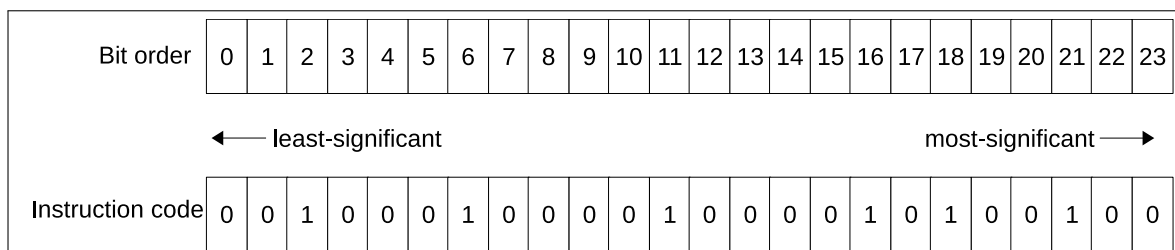

Figure 1-3. `EE.ZERO.QACC` in Big-Endian Bit Order

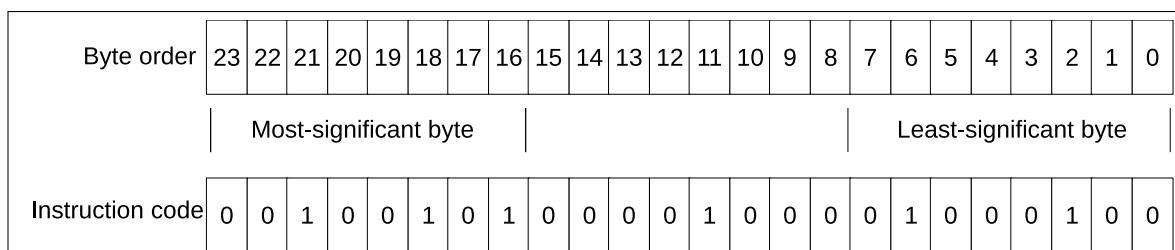

Figure 1-4. `EE.ZERO.QACC` in Little-Endian Byte Order

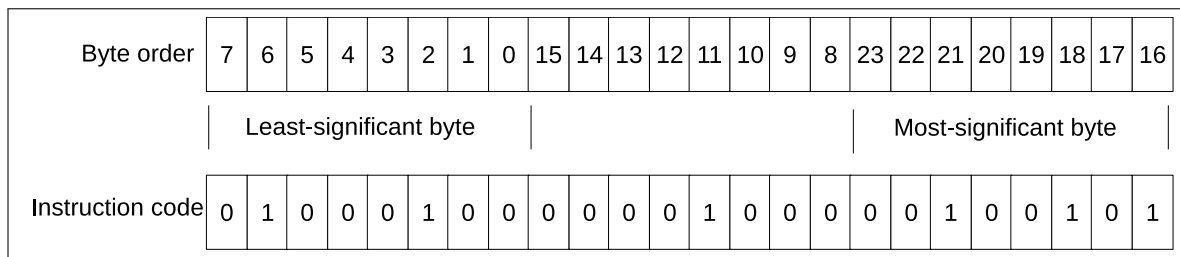

Figure 1-5. **EE.ZERO.QACC** in Big-Endian Byte Order

1.4.2 Instruction Field Definition

Table 1-1 provides the meaning of the characters covered in instruction descriptions. You can find such characters and corresponding descriptions in Section 1.8.

Table 1-1. Instruction Field Names and Descriptions

Name		Description	
a*	32-bit general-purpose registers	as	In-out type (used as input/output operand). Stores address information for read/write operations, which is updated after such operations are completed.
		at	In-out type. Temporarily stores operation results to the EE.FFT.AMS.S16.ST.INCP instruction, which will be part of the data to be written to memory.
		ad	In type (used as input operand). Stores data used to update address information.
		av	In type. Stores data to be written to memory.
		ax,ay	In type. Stores data involved in arithmetic operations, e.g., shifting amounts, multipliers and etc.
		au	Out type (used as output operand). Stores results of instruction operations.
q*	128-bit general-purpose registers	qs	In type. Stores 128-bit data used for concatenation operations.
		qa,qx,qy,qm	In type. Stores data used for vector operations.
		qz	Out type. Stores results of vector operations.
		qu	Out type. Stores data read from memory.
		qv	In type. Stores data to be written to memory.
fu	32-bit general-purpose floating-point register. Stores floating-point data read from memory.		
fv	32-bit general-purpose floating-point register. Stores floating-point data to be written to memory.		
sel2	1-bit immediate value ranging from 0 to 1. Used to select signals.		
sel4,upd4	2-bit immediate value ranging from 0 to 3. Used to select signals.		
sel8	3-bit immediate value ranging from 0 to 7. Used to select signals.		
sel16	4-bit immediate value ranging from 0 to 15. Used to select signals.		
sar2	1-bit immediate value ranging from 0 to 1. Represents shifting numbers.		
sar4	2-bit immediate value ranging from 0 to 3. Represents shifting numbers.		
sar16	4-bit immediate value ranging from 0 to 15. Represents shifting numbers.		
imm1	7-bit unsigned immediate value ranging from 0 to 127 with an interval of 1. This is used to show the size of the updated read/write operation address value.		

Cont'd on next page

Table 1-1 – cont'd from previous page

Name	Description
imm2	7-bit unsigned immediate value ranging from 0 to 254 with an interval of 2. This is used to show the size of the updated read/write operation address value.
imm4	8-bit signed immediate value ranging from -256 to 252 with an interval of 8. This is used to show the size of the updated read/write operation address value.
imm16	8-bit signed immediate value ranging from -2048 to 2032 with an interval of 16. This is used to show the size of the updated read/write operation address value.
imm16f	4-bit signed immediate value ranging from -128 to 112 with an interval of 16. This is used to show the size of the updated read/write operation address value.

Some instructions have multiple operands with the same function. Those operands are distinguished by adding numbers after field names. For example, the [EE.LDF.128.IP](#) instruction has four fu registers, fu0 ~ 3. They are used to store 128-bit data read from memory.

1.5 Components of Extended Instruction Set

1.5.1 Registers

This section introduces all kinds of registers related to ESP32-S3's extended instruction set, including the original registers defined by Xtensa as well as customized registers. For register information, please refer to [Table 1-2](#).

Table 1-2. Register List of ESP32-S3 Extended Instruction Set

Register Mnemonics	Quantity	Bit Width	Access	Type
AR	16 ¹	32	R/W	General-purpose registers
FR	16	32	R/W	General-purpose registers to FPU
QR	8	128	R/W	Customized general-purpose registers
SAR	1	6	R/W	Special register
SAR_BYTE	1	4	R/W	Customized special register
ACCX	1	40	R/W	Customized special register
QACC_H	1	160	R/W	Customized special register
QACC_L	1	160	R/W	Customized special register
FFT_BIT_WIDTH	1	4	R/W	Customized special register
UA_STATE	1	128	R/W	Customized special register

¹ The Xtensa processor has 64 internal AR registers. It is designed with the register windowing technique, so that the software can only access 16 of the 64 AR registers at any given time. The programming performance can be effectively improved by rotating windows, replacing function calls, and saving registers when exceptions are triggered.

1.5.1.1 General-Purpose Registers

When using general-purpose register as operands in instructions, you need to explicitly declare the number of the assigned register. For example:

EE.VADDS.S8 q2, q0, q1

This instruction uses No.0 and No.1 QR registers as input vectors and stores the vector addition result in the No.2 QR register.

AR

Each AR register operand in the instruction will occupy a 4-bit code length. You can select any of the 16 AR registers as operands, and the 4-bit code value indicates the number to declare. The row "a*" in table 1-1 lists various purposes of AR registers in the extended instruction set, including address storage and data storage.

FR

Each FR register operand in the instruction will occupy a 4-bit code length. You can select any of the 16 FR registers as operands, and the 4-bit code value indicates the number to declare. In ESP32-S3 extended instruction set, there are only read and write instructions for floating-point data. They are 4 times more efficient than the 32-bit floating-point data R/W instructions that are native to the Xtensa processor, thanks to the 128-bit access bandwidth.

QR

In order to improve the execution efficiency of the program, operands are usually stored in general-purpose registers to save time spent in reading from memory. The AR registers native to Xtensa only have 32-bit width, while ESP32-S3 can access 128-bit data at a time, so they can only use 1/4 bandwidth capacity of the existing data bus. For this reason, ESP32-S3 has added eight 128-bit customized general-purpose registers, i.e., QR registers. QR registers are mainly used to store the data acquired/used by the 128-bit data bus to read or write memory, as well as to temporarily store the operation results generated from 128-bit data operations.

As the processor executes instructions, an individual QR register is treated as 16 8-bit or 8 16-bit or 4 32-bit operands depending on the vector operation bit width defined by the instruction, thus enabling a single instruction to perform operations on multiple operands.

1.5.1.2 Special Registers

Different from general-purpose registers, special registers are implicitly called in specific instructions. You do not need to and cannot specify a certain special register when executing instructions. For example:

EE.VMUL.S16 q2, q0, q1

This vector multiplication instruction uses q0 and q1 general-purpose registers as inputs. During the internal operation, the intermediate 32-bit multiplication result is shifted to the right, and then the lower 16-bit of the result is retained to form a 128-bit output to q2. The shift amount in the process is determined by the value in the Shift Amount Register (SAR) and this SAR register will not appear in the instruction operand list.

SAR

The Shift Amount Register (SAR) stores the shift value in bits. There are two types of instructions in ESP32-S3's extended instruction set that use SAR. One is the type of instructions to shift vector data, including [EE.VSR.32](#) and [EE.VSL.32](#). The former uses the lower 5 bits of SAR as the right-shift value, and the latter uses the lower 5 bits of SAR as the left-shift value. The other type is multiplication instructions, including [EE.VMUL.*](#), [EE.CMUL.*](#), [EE.FFT.AMS.*](#) and [EE.FFT.CMUL.*](#). This type of instructions uses the value in SAR as the value for the right shift of the intermediate multiplication result, which determines the accuracy of the final result.

SAR_BYTE

The SAR_BYTE stores the shift value in bytes. This special register is designed to handle the non-aligned 128-bit data (see Section 1.5.3). For vector arithmetic instructions, the data read or stored by extended instructions are forced to be 16-byte aligned, but in practice, there is no guarantee that the data addresses used are always 16-byte aligned.

[EE.LD.128.USAR.IP](#) and [EE.LD.128.USAR.XP](#) instructions write the lower 4-bit values of the memory access register that represent non-aligned data to SAR_BYTE while reading 128-bit data from memory.

There are two types of instruction in ESP32-S3's extended instruction set that use SAR_BYTE. One is dedicated to handling non-aligned data in QR registers, including [EE.SRCQ.*](#) and [EE.SRC.Q*](#). This type of instruction will read two 16-byte data from two aligned addresses, before and after the non-aligned address, put them together, and then shift it by the byte size of SAR_BYTE to get a 128-bit data from the non-aligned address. The other type of instruction handles non-aligned data while executing arithmetic operations, which usually has a suffix of ".QUP".

ACCX

Multiplier-accumulator. Instructions such as [EE.VMULAS.*.ACCX*](#) and [EE.SRS.ACCX](#) use this register during operations. The former uses ACCX to accumulate all vector multiplication results of two QR registers, and the latter right shifts the ACCX register.

QACC_H,QACC_L

Successive accumulators partitioned by segments. Instructions such as [EE.VMULAS.*.QACC*](#) and [EE.SRCMB.*.QACC](#) use this type of registers during operations. These registers are mainly used to accumulate vector multiplication results of two QR registers into the corresponding segments of QACC_H and QACC_L respectively. The 16-bit vector multiplication results are accumulated into the corresponding 16 20-bit segments respectively and the 32-bit results are accumulated into the corresponding 8 40-bit segment respectively.

FFT_BIT_WIDTH

This special register is dedicated to the [EE.BITREV](#) instruction. The value inside this register is used to indicate the operating mode of [EE.BITREV](#). Its range is 0 ~ 7, indicating 3-bit ~ 10-bit operating mode respectively. For more details, please refer to instruction [EE.BITREV](#).

UA_STATE

This special register is dedicated to the [EE.FFT.AMS.S16.LD.INCP.UAUP](#) instruction. This register is used to store the non-aligned 128-bit data read from memory. Next time when this instruction is called, the data in this

register is concatenated to the newly read non-aligned data and then the result is shifted to obtain the 128-bit aligned data.

1.5.2 Fast GPIO Interface

ESP32-S3's Xtensa processor adds two signal ports, i.e., GPIO_OUT and GPIO_IN. You can route signals from the two ports to specified GPIO pins via the GPIO Matrix.

1.5.2.1 GPIO_OUT

An 8-bit processor output interface. Firstly, configure the 8-bit port signals to specified pins via GPIO Matrix. For core0, their names are pro_alonegpio_out0~7. For core1, their names are core1_gpio_out0~7. Then you can set certain bits of GPIO_OUT to 1 via instructions [EE.WR_MASK_GPIO_OUT](#) and [EE.SET_BIT_GPIO_OUT](#), or set certain bits to 0 via instruction [EE.CLR_BIT_GPIO_OUT](#), so as to pull certain pins to high level or low level. Using this method, you can get faster response than pulling pins through register configurations.

1.5.2.2 GPIO_IN

An 8-bit processor input interface. Firstly, configure the 8-bit port signals to specified pins via GPIO Matrix. For core0, their names are pro_alonegpio_in0~7. For core1, their names are core1_gpio_in0~7. Then you can read the eight GPIO pin levels and store them to the AR register through instruction [EE.GET_GPIO_IN](#). Using this method, you can get and handle the level changes on GPIO pins faster than reading registers to get pin level status.

1.5.3 Data Format and Alignment

The current extended instruction set supports 1-byte, 2-byte, 4-byte, 8-byte and 16-byte data formats. Besides, there is also a 20-byte format: QACC_H and QACC_L. However, there is no direct way to switch the data between the two special registers and memory. You can read and write data of QACC_H and QACC_L via five 4-byte (AR) registers or two 16-byte (QR) registers.

The table 1-3 lists bit length and alignment information for common data format ('x' indicates that the bit is either 0 and 1). The Xtensa processor uses byte as the smallest unit for addresses stored in memory in all data formats. And little-endian byte order is used, with byte 0 stored in the lowest bit (the right side), as shown in Figure 1-4.

Table 1-3. Data Format and Alignment

Data Format	Length	Aligned Addresses in Memory
1-byte	8 bits	xxxx
2-byte	16 bits	xxx0
4-byte	32 bits	xx00
8-byte	64 bits	x000
16-byte	128 bit	0000

However, if data is stored in memory at a non-aligned address, direct access to this address may cause it being split into two accesses, which in turn affects the performance of the code. For example, if you expect to read a 16-byte data from memory, as shown in Table 1-3, the data is stored in memory at 0000 when the data is

aligned. But actually the data is not aligned, so the low nibble of its address may be any one between 0000 ~ 1111 (binary). Assuming the lowest bit of its address is 0_0100, the processor will split the one-time access to this data into two accesses, i.e., to 0_0000 and 1_0000 respectively. The processor then put together the obtained two 16-byte data to get the required 16-byte data.

To avoid performance degradation caused by the above non-aligned access operations, all access addresses in the extended instruction set are forced to be aligned, i.e., the lowest bits will be replaced by 0. For example, if a read operation is initiated for 128-bit data at 0x3fc8_0024, the lowest 4-bit of this access address will be forced to be set to 0. Eventually, the 128-bit data stored at 0x3fc8_0020 will be read. Similarly, the lowest 3-bit of the access address for 64-bit data will be set to 0; the lowest 2-bit of the access address for 32-bit data will be set to 0; the lowest 1-bit of the access address for 16-bit data will be set to 0.

The above design requires aligned addresses of the access operations initiated. Otherwise, the data read will not be what you expected. In application code, you need to explicitly declare the alignment of the variable or array in memory. 16-byte alignment can meet the needs of most application scenarios.

The *aligned*(16) parameter declares that the variable is stored in a 16-byte aligned memory address. You can also request a data space with its starting address 16-byte aligned via `heap_caps_aligned_alloc`.

Since the memory address of the data involved in some operations is uncertain in specific application scenarios, this extended instruction set provides a special register `SAR_BYTE` and related instructions such as `EE.LD.128.USAR.*` and `EE.SRC.*`, to handle non-aligned data.

Assume that the 128-bit non-aligned data address is stored in the general-purpose register `a8`. This 128-bit data can be read into the specified QR register (`q2` in the following example) by the following code:

```
EE.LD.128.USAR.IP    q0, a8, 16
EE.VLD.128.IP      q1, a8, 16
EE.SRC.Q          q2, q0, q1
```

1.5.4 Data Overflow and Saturation Handling

Data overflow means that the size of the operation result exceeds the maximum value that can be stored in the result register. Take the `EE.VMUL.S8` instruction as an example, the result of two 8-bit multipliers is 16-bit, and it should still be 16-bit after right-shifting. However, the final result will be stored in the 8-bit register, which may cause the risk of data overflow.

In the design of the ESP32-S3's instruction extensions, there are two ways to handle data overflow, namely taking saturation and truncating the least significant bit. The former controls the calculation result according the range of values that can be stored in the result register. If the result exceeds the maximum value of the result register, take the maximum value; if the result is smaller than the minimum value of the result register, take the minimum value. This approach will be explicitly indicated in the instruction descriptions. For example, the `EE.VADDS.*` instructions perform saturation to the results of addition operations. Regarding the data overflow handling for more instructions of their internal calculation results, the wraparound approach is used, i.e., only the lower bit of the result that is consistent with the bit width of the result register will be retained and stored in the result register.

Please note that for instructions that do not mention saturation handling method, the wraparound approach will be used.

1.6 Extended Instruction List

Table 1-4 lists instruction types and corresponding instruction information included in the extended instruction set. This section gives brief introduction to all types of instructions.

Table 1-4. Extended Instruction List

Instruction Type	Instruction ¹	Reference Section
Read instructions	EE.VLD.128.[XP/IP]	1.6.1
	EE.VLD.[H/L].64.[XP/IP]	
	EE.VLDBC.[8/16/32].[-/XP/IP]	
	EE.VLDHBC.16.INCP	
	EE.LDF.[64/128].[XP/IP]	
	EE.LD.128.USAR.[XP/IP]	
	EE.LDQA.[U/S][8/16].128.[XP/IP]	
	EE.LD.QACC_[H/L].[H.32/L.128].IP	
	EE.LD.ACCX.IP	
	EE.LD.UA_STATE.IP	
	EE.LDXQ.32	
Write instructions	EE.VST.128.[XP/IP]	1.6.2
	EE.VST.[H/L].64.[XP/IP]	
	EE.STF.[64/128].[XP/IP]	
	EE.ST.QACC_[H/L].[H.32/L.128].IP	
	EE.ST.ACCX.IP	
	EE.ST.UA_STATE.IP	
	EE.STXQ.32	
Arithmetic instructions	EE.VADDS.S[8/16/32].[-/LD.INCP/ST.INCP]	1.6.4
	EE.VSUBS.S[8/16/32].[-/LD.INCP/ST.INCP]	
	EE.VMUL.[U/S][8/16].[-/LD.INCP/ST.INCP]	
	EE.CMUL.S16.[-/LD.INCP/ST.INCP]	
	EE.VMULAS.[U/S][8/16].ACCX.[-/LD.IP/LD.XP]	
	EE.VMULAS.[U/S][8/16].QACC.[-/LD.IP/LD.XP/LDBC.INCP]	
	EE.VMULAS.[U/S][8/16].ACCX.[LD.IP/LD.XP].QUP	
	EE.VMULAS.[U/S][8/16].QACC.[LD.IP/LD.XP/LDBC.INCP].QUP	
	EE.VSMULAS.S[8/16].QACC.[-/LD.INCP]	
	EE.SRCMB.S[8/16].QACC	
	EE.SRS.ACCX	
	EE.VRELU.S[8/16]	
	EE.VPRELU.S[8/16]	
Comparison instructions	EE.VMAX.S[8/16/32].[-/LD.INCP/ST.INCP]	1.6.5
	EE.VMIN.S[8/16/32].[-/LD.INCP/ST.INCP]	
	EE.VCMP.[EQ/LT/GT].S[8/16/32]	
Bitwise logic instructions	EE.ORQ	1.6.6
	EE.XORQ	
	EE.ANDQ	
	EE.NOTQ	

Con't on next page

Table1-4 – con't from previous page

Instruction Type	Instruction ¹	Reference Section
Shift instructions	EE.SRC.Q	1.6.7
	EE.SRC.Q.QUP	
	EE.SRC.Q.LD.[XP/IP]	
	EE.SLCI.2Q	
	EE.SLCXP.2Q	
	EE.SRCI.2Q	
	EE.SRCXP.2Q	
	EE.SRCQ.128.ST.INCP	
	EE.VSR.32	
	EE.VSL.32	
FFT dedicated instructions	EE.FFT.R2BF.S16.[-/ST.INCP]	1.6.8
	EE.FFT.CMUL.S16.[LD.XP/ST.XP]	
	EE.BITREV	
	EE.FFT.AMS.S16.[LD.INCP.UAUP/LD.INCP/LD.R32.DECP/ST.INCP]	
	EE.FFT.VST.R32.DECP	
GPIO control instructions	EE.WR_MASK_GPIO_OUT	1.6.9
	EE.SET_BIT_GPIO_OUT	
	EE.CLR_BIT_GPIO_OUT	
	EE.GET_GPIO_IN	
Processor control instructions	RSR.*	1.6.10
	WSR.*	
	XSR.*	
	RUR.*	
	WUR.*	

¹ For detailed information of these instructions, please refer to Section 1.8.

1.6.1 Read Instructions

Read instructions tell the processor to issue a virtual address to access memory based on the AR register that stores access address information. Most read instructions read memory first, and then update the access address. [EE.LDXQ.32](#) is a special case where the instruction first selects a piece of 16-bit data in the QR register via an immediate value, adds it to the access address, and then issues the access operation.

Since access to non-aligned addresses will cause slower response, all virtual addresses issued by read instructions in the extended instruction set are forced to be aligned according to data formats. Depending on the size of the access data format, corresponding length of data will be returned by memory as 1-byte, 2-byte, 4-byte, 8-byte or 16-byte. When the data read after forced alignment is not as expected, the desired data can be extracted from multiple QR registers using instructions such as [EE.SRC.Q](#).

The table below briefly describes the access operations performed by read instructions. For detailed information about read instructions, please see Section 1.8.

Table 1-5. Read Instructions

Instructions	Description
EE.VLD.128.XP	Read the 16-byte data, then add the value stored in the AR register to the access address.
EE.VLD.128.IP	Read the 16-byte data, then add the immediate value to the access address.
EE.VLD.[H/L].64.XP	Read the 8-byte data, then add the value stored in the AR register to the access address.
EE.VLD.[H/L].64.IP	Read the 8-byte data, then add the immediate value to the access address.
EE.VLDBC.[8/16/32]	Read the 1-byte/2-byte/4-byte data.
EE.VLDBC.[8/16/32].XP	Read the 1-byte/2-byte/4-byte data, then add the value stored in the AR register to the access address.
EE.VLDBC.[8/16/32].IP	Read the 1-byte/2-byte/4-byte data, then add the immediate value to the access address.
EE.VLDHBC.16.INCP	Read the 16-byte data, then add 16 to the access address.
EE.LDF.[64/128].XP	Read the 8-byte/16-byte data, then add the value stored in the AR register to the access address.
EE.LDF.[64/128].IP	Read the 8-byte/16-byte data, then add the immediate value to the access address.
EE.LD.128.USAR.XP	Read the 16-byte data, then add the value stored in the AR register to the access address.
EE.LD.128.USAR.IP	Read the 16-byte data, then add the immediate value to the access address.
EE.LDQA.U8.128.[XP/IP]	Read the 16-byte data and slice it by 1-byte, and zero-extend it to 20-bit data, which then will be written to register QACC_H and QACC_L, and finally add the value stored in the AR register or the immediate value to the access address.
EE.LDQA.U16.128.XP	Read the 16-byte data and slice it by 2-byte, and zero-extend it to 40-bit data, which then will be written to register QACC_H and QACC_L, and finally add the value stored in the AR register or the immediate value to the access address.
EE.LDQA.S8.128.XP	Read the 16-byte data and slice it by 1-byte, then sign-extend it to 20-bit data, which then will be written to register QACC_H and QACC_L, and finally add the value stored in the AR register or the immediate value to the access address.
EE.LDQA.S16.128.XP	Read the 16-byte data and slice it by 1-byte, then sign-extend it to 40-bit data, which then will be written to register QACC_H and QACC_L, and finally add the value stored in the AR register or the immediate value to the access address.
EE.LD.QACC_[H/L].H.32.IP	Read the 4-byte data, then add the immediate value to the access address.
EE.LD.QACC_[H/L].L.128.IP	Read the 16-byte data, then add the immediate value to the access address.
EE.LD.ACCX.IP	Read the 8-byte data, then add the immediate value to the access address.
EE.LD.UA_STATE.IP	Read the 16-byte data, then add the immediate value to the access address.
EE.LDXQ.32	Update access address first, then read the 4-byte data.

1.6.2 Write Instructions

The write instructions tells the processor to issue a virtual address to access memory based on the AR register that stores the information about access addresses. Most write instructions write memory first then update the access addresses, except for the [EE.STXQ.32](#) instruction, which selects a piece of 16-bit data first from the QR register via an immediate value, adds it to the access address, and then issues the access operation.

Since access to non-aligned addresses will cause slower response, all virtual addresses issued by write instructions in the extended instruction set are forced to be aligned according to data format. Depending on the size of the access data format, corresponding length of data will be written to memory as 1-byte, 2-byte, 4-byte, 8-byte or 16-byte. When the data length to be written to memory is less than the access bit length, it is necessary to perform zero extension or sign extension on this data.

The table below briefly describes the access operations performed by write instructions. For detailed information, please refer to Section 1.8.

Table 1-6. Write Instructions

Instructions	Description
EE.VST.128.XP	Write the 16-byte data to memory, then add the value stored in the AR register to the access address.
EE.VST.128.IP	Write the 16-byte data to memory, then add the immediate value to the access address.
EE.VST.[H/L].64.XP	Write the 8-byte data to memory, then add the value stored in the AR register to the access address.
EE.VST.[H/L].64.IP	Write the 8-byte data to memory, then add the immediate value to the access address.
EE.STF.[64/128].XP	Write the 8-byte/16-byte data to memory, then add the value stored in the AR register to the access address.
EE.STF.[64/128].IP	Write the 8-byte/16-byte data to memory, then add the immediate value to the access address.
EE.ST.QACC_[H/L].H.32.IP	Write the 4-byte data to memory, then add the immediate value to the access address.
EE.ST.QACC_[H/L].L.128.IP	Write the 16-byte data to memory, then add the immediate value to the access address.
EE.ST.ACCX.IP	Zero-extend the value in the ACCX register to 8-byte data and write it to memory, then add the immediate value to the access address.
EE.ST.UA_STATE.IP	Write the 16-byte data to memory, then add the immediate value to the access address.
EE.STXQ.32	Update the access address first, then write the 4-byte data to memory.

1.6.3 Data Exchange Instructions

Data exchange instructions are mainly used to exchange data information between different registers. Considering the bit width of the exchange registers are different, the immediate value are added as the selection signal, and zero extension and sign extension instructions are provided also. A variety of data exchange instructions can meet the data exchange requirements for users under various scenarios.

For detailed information about data exchange instructions, please refer to Section 1.8.

Table 1-7. Data Exchange Instructions

Instructions	Description
EE.MOVI.32.A	Assign a piece of 32-bit data from the QR register to the AR register.

Instructions	Description
EE.MOVI.32.Q	Assign the data stored in the AR register to a piece of 32-bit data space in the QR register.
EE.VZIP.[8/16/32]	Encoding the two QR registers in 1-byte/2-byte/4-byte unit.
EE.VUNZIP.[8/16/32]	Decoding the two QR registers in 1-byte/2-byte/4-byte unit.
EE.ZERO.Q	Clear a specified QR register.
EE.ZERO.QACC	Clear QACC_H and QACC_L registers.
EE.ZERO.ACCX	Clear a specified ACCX register.
EE.MOV.S8.QACC	Slice the QR register by 1-byte, and sign-extend it to 20-bit data, then assign this value to QACC_H and QACC_L registers.
EE.MOV.S16.QACC	Slice the QR register by 2-byte, and sign-extend it to 40-bit data, then assign this value to QACC_H and QACC_L registers.
EE.MOV.U8.QACC	Slice the QR register by 1-byte, and zero-extend it to 20-bit, then assign this value to QACC_H and QACC_L registers.
EE.MOV.U16.QACC	Slice the QR register by 2-byte, and zero-extend it to 40-bit data, then assign this value to QACC_H and QACC_L registers.

1.6.4 Arithmetic Instructions

Arithmetic instructions mainly use the SIMD (Single Instruction Multiple Data) principle for vector data operations, including vector addition, vector multiplication, vector complex multiplication, vector multiplication accumulation, vector and scalar multiplication accumulation, etc.

Vector Addition Instructions

ESP32-S3 provides vector addition and subtraction instructions for data in 1-byte, 2-byte and 4-byte units.

Considering that the input and output operands required for vector operations are stored in memory, in order to reduce extra operations as reading memory and to improve the speed of code execution, vector addition instructions are designed to perform the addition and the 16-byte access at the same time, and the value in the address register is increased by 16 after the access, thus directly pointing to the next continuous 16-byte memory address. You can select the appropriate instruction according to the actual algorithm needs.

In addition, vector addition instructions also saturate the result of addition and subtraction to ensure the accuracy of arithmetic operations.

Table 1-8. Vector Addition Instructions

Instructions	Description
EE.VADDS.S[8/16/32]	Perform vector addition operation on 1-byte/2-byte/4-byte data.
EE.VADDS.S[8/16/32].LD.INCP	Perform vector addition operation on 1-byte/2-byte/4-byte data, and read 16-byte data from memory at the same time.
EE.VADDS.S[8/16/32].ST.INCP	Perform vector addition operation on 1-byte/2-byte/4-byte data, and write 16-byte data to memory at the same time.
EE.VSUBS.S[8/16/32]	Perform vector subtraction operation on 1-byte/2-byte/4-byte data.
EE.VSUBS.S[8/16/32].LD.INCP	Perform vector subtraction operation on 1-byte/2-byte/4-byte data, and read 16-byte data from memory at the same time.

Instructions	Description
EE.VSUBS.S[8/16/32].ST.INCP	Perform vector subtraction operation on 1-byte/2-byte/4-byte data, and write 16-byte data to memory at the same time.

Vector Multiplication Instructions

ESP32-S3 provides vector multiplication instructions for data in 1-byte and 2-byte units, and supports unsigned and signed vector multiplication.

Considering that the input and output operands required for vector operations are stored in memory, in order to reduce extra operations as reading memory and improve the speed of code execution, vector multiplication instructions are designed to perform the multiplication and access 16 bytes at the same time, and the access address is increased by 16 after the access, thus directly pointing to the next 16-byte memory address. You can select the appropriate instruction according to the actual algorithm needs.

Table 1-9. Vector Multiplication Instructions

Instructions	Description
EE.VMUL.U[8/16]	Perform vector multiplication operation on unsigned 1-byte/2-byte data.
EE.VMUL.S[8/16]	Perform vector multiplication operation on signed 1-byte/2-byte data.
EE.VMUL.U[8/16].LD.INCP	Perform vector multiplication operation on unsigned 1-byte/2-byte data, and read 16-byte data from memory at the same time.
EE.VMUL.S[8/16].LD.INCP	Perform vector multiplication operation on signed 1-byte/2-byte data, and read 16-byte data from memory at the same time.
EE.VMUL.U[8/16].ST.INCP	Perform vector multiplication operation on unsigned 1-byte/2-byte data, and write 16-byte data to memory at the same time.
EE.VMUL.S[8/16].ST.INCP	Perform vector multiplication operation on signed 1-byte/2-byte data, and write 16-byte data to memory at the same time.

Vector Complex Multiplication Instructions

ESP32-S3 provides vector complex multiplication instructions for data in 2-byte unit. The instruction operands are executed as signed data.

Considering that the input and output operands required for vector operations are stored in memory, in order to reduce extra operations as reading memory and improve the speed of code execution, vector complex multiplication instructions are designed to perform the multiplication and access 16 bytes at the same time, and the access address is increased by 16 after the access, thus directly pointing to the next 16-byte memory address. You can select the appropriate instruction according to the actual algorithm needs.

Table 1-10. Vector Complex Multiplication Instructions

Instructions	Description
EE.CMUL.S16	Perform vector complex multiplication operation to 2-byte data.
EE.CMUL.S16.LD.INCP	Perform vector complex multiplication operation to 2-byte data, and read 16-byte data from memory at the same time.
EE.CMUL.S16.ST.INCP	Perform vector complex multiplication operation to 2-byte data, and write 16-byte data to memory at the same time.

Vector Multiplication Accumulation Instructions

ESP32-S3 provides two types of vector multiplication accumulation instructions: one is based on the ACCX register, accumulating multiple vector multiplication results to a 40-bit ACCX register; and the other is based on QACC_H and QACC_L registers, accumulating vector multiplication results to the corresponding bit segments of QACC_H and QACC_L registers respectively. Both types of above-mentioned instructions support multiplication accumulation on 1-byte and 2-byte segments.

In order to reduce extra operations as reading memory and improve the speed of code execution, vector multiplication accumulation instructions are designed to perform the multiplication accumulation and access 16 bytes at the same time, and the access address is increased by the value in the AR register or by the immediate value after the access.

In addition, instructions with the "QUP" suffix in the vector multiplication accumulation instructions also support extracting 16-byte aligned data from the unaligned address.

Table 1-11. Vector Multiplication Accumulation Instructions

Instructions	Description
EE.VMULAS.[U/S][8/16].ACCX	Perform vector multiplication accumulation to signed/unsigned data in 1-byte/2-byte segment, and store the result to the ACCX register temporarily.
EE.VMULAS.[U/S][8/16].ACCX.LD.IP	Perform vector multiplication accumulation to signed/unsigned data in 1-byte/2-byte segment, and store the result to the ACCX register temporarily, then read 16-byte data from memory. Add immediate to address register.
EE.VMULAS.[U/S][8/16].ACCX.LD.XP	Perform vector multiplication accumulation to signed/unsigned data in 1-byte/2-byte segment, and store the result to the ACCX register temporarily, then read 16-byte data from memory. Add the value of AR register to address register.
EE.VMULAS.[U/S][8/16].ACCX.LD.IP.QUP	Perform vector multiplication accumulation to signed/unsigned data in 1-byte/2-byte segment, and store the result to the ACCX register temporarily. Then read 16-byte data from memory and output a 16-byte aligned data. Add immediate to address register.
EE.VMULAS.[U/S][8/16].ACCX.LD.XP.QUP	Perform vector multiplication accumulation to signed/unsigned data in 1-byte/2-byte segment, and store the result to the ACCX register temporarily. Then read 16-byte data from memory and output a 16-byte aligned data. Add the value of AR register to address register.
EE.VMULAS.[U/S][8/16].QACC	Perform vector multiplication operation on signed/unsigned data in 1-byte/2-byte segment, and accumulate the results to corresponding bit segments in QACC_H and QACC_L registers.

Instructions	Description
EE.VMULAS.[U/S][8/16].QACC.LD.IP	Perform vector multiplication operation on signed/unsigned data in 1-byte/2-byte segment, and accumulate the results to corresponding bit segments in QACC_H and QACC_L registers, then read 16-byte data from memory. Add immediate to address register.
EE.VMULAS.[U/S][8/16].QACC.LD.XP	Perform vector multiplication operation on signed/unsigned data in 1-byte/2-byte segment, and accumulate the results to corresponding bit segments in QACC_H and QACC_L registers, then read 16-byte data from memory. Add the value of AR register to address register.
EE.VMULAS.[U/S][8/16].QACC.LDBC.INCP	Perform vector multiplication operation on signed/unsigned data in 1-byte/2-byte segment, and accumulate the results to corresponding bit segments in QACC_H and QACC_L registers. Then read 1-byte/2-byte data from memory and broadcast it to the 128-bit QR register. Add 16 to address register.
EE.VMULAS.[U/S][8/16].QACC.LD.IP.QUP	Perform vector multiplication operation on signed/unsigned data in 1-byte/2-byte segment, and accumulate the results to the corresponding bit segments in QACC_H and QACC_L registers. At the same time, read 16-byte data from memory and output a 16-byte aligned data. Add immediate to address register.
EE.VMULAS.[U/S][8/16].QACC.LD.XP.QUP	Perform vector multiplication operation on signed/unsigned data in 1-byte/2-byte segment, and accumulate the results to the corresponding bit segments in QACC_H and QACC_L registers. At the same time, read 16-byte data from memory and output a 16-byte aligned data. Add the value of AR register to address register.
EE.VMULAS.[U/S][8/16].QACC.LDBC.INCP.QUP	Perform vector multiplication operation on signed/unsigned data in 1-byte/2-byte segment, and accumulate the results to the corresponding bit segments in QACC_H and QACC_L registers. At the same time, read 1-byte/2-byte data from memory and broadcast it to the 128-bit QR register, then output a 16-byte aligned data. Add 16 to address register.

Vector and Scalar Multiplication Accumulation Instructions

The function of this type of instructions is similar to that of the vector multiplication accumulation instructions based on QACC_H and QACC_L registers, except that one of the binocular operands is a vector and the other is a scalar. It also contains instructions that can execute access operation while vector operations are performed.

Table 1-12. Vector and Scalar Multiplication Accumulation Instructions

Instructions	Description
EE.VSMULAS.S[8/16].QACC	Perform vector and scalar multiplication accumulation on signed data in 1-byte/2-byte segment.
EE.VSMULAS.S[8/16].QACC.LD.INCP	Perform vector and scalar multiplication accumulation on signed data in 1-byte/2-byte segment, and read 16-byte data from memory at the same time. Add 16 to address register.

Other Instructions

This section contains instructions that perform arithmetic right-shifting on multiplication accumulation results in QACC_H, QACC_L and ACCX. You can set the shifting value to obtain the multiplication accumulation results within the expected accuracy range.

In addition, it also contains vector multiplication instructions with enabling conditions.

Table 1-13. Other Instructions

Instructions	Description
EE.SRCMB.S[8/16].QACC	Perform signed right-shifting on data in QACC_H and QACC_L registers in segment unit.
EE.SRS.ACCX	Perform signed right-shifting on data in the ACCX register.
EE.VRELU.S[8/16]	Perform vector and scalar multiplication based on enabling conditions.
EE.VPRELU.S[8/16]	Perform vector-to-vector multiplication based on enabling conditions.

1.6.5 Comparison Instructions

Vector comparison instructions compare data in the unit of 1 byte, 2 bytes, or 4 bytes, including the instructions that take the larger/smaller one between the compared two values, that set all bits to 1 when the two values are equal and set them to 0 when they are not equal, that set all bits to 1 when the former value is larger than the latter and otherwise set them to 0, and that set all bits to 1 when the former value is smaller than the latter and otherwise set them to 0.

Considering that the input and output operands required for vector operations are stored in memory, in order to reduce extra operations as reading memory and improve the speed of code execution, access instructions to 16-byte addresses are performed at the same time as vector operations, and the access address is increased by 16 after the access, thus directly pointing to the next 16-byte memory address. You can select the appropriate instruction according to the actual algorithm needs.

Table 1-14. Comparison Instructions

Instructions	Description
EE.VMAX.S[8/16/32]	Take the larger value between the two 1-byte/2-byte/4-byte values.
EE.VMAX.S[8/16/32].LD.INCP	Take the larger value between the two 1-byte/2-byte/4-byte values, and read 16-byte data from memory at the same time.
EE.VMAX.S[8/16/32].ST.INCP	Take the larger value between the two 1-byte/2-byte/4-byte values, and write 16-byte data to memory at the same time.

Instructions	Description
EE.VMIN.S[8/16/32]	Take the smaller value between the two 1-byte/2-byte/4-byte values.
EE.VMIN.S[8/16/32].LD.INCP	Take the smaller value between the two 1-byte/2-byte/4-byte values, and read 16-byte data from memory at the same time.
EE.VMIN.S[8/16/32].ST.INCP	Take the smaller value between the two 1-byte/2-byte/4-byte values, and write 16-byte data to memory at the same time.
EE.VCMP.EQ.S[8/16/32]	Compare two 1-byte/2-byte/4-byte values, set all bits to 1 when the two values are equal, or set all bits to 0 when they are not equal.
EE.VCMP.LT.S[8/16/32]	Compare two 1-byte/2-byte/4-byte values, set all bits to 1 when the former value is smaller than the latter one, or set them to 0 otherwise.
EE.VCMP.GT.S[8/16/32]	Compare two 1-byte/2-byte/4-byte values, set all bits to 1 when the former value is larger than the latter one, or set them to 0 otherwise.

1.6.6 Bitwise Logical Instructions

Bitwise logical instructions include bitwise logical OR, bitwise logical AND, bitwise logical XOR and bitwise NOT instructions.

Table 1-15. Bitwise Logical Instructions

Instructions	Description
EE.ORQ	Bitwise logical OR $qa = qx qy$
EE.XORQ	Bitwise logical XOR $qa = qx \wedge qy$
EE.ANDQ	Bitwise logical AND $qa = qx&qy$
EE.NOTQ	Bitwise NOT $qa = \sim qx$

1.6.7 Shift Instructions

Shift instructions include vector left-shift and vector right-shift instructions in 4-byte processing units as well as left-shift and right-shift instructions for spliced 16-byte data. The shift value of the former type is determined by the SAR register; while the shift value of the latter type can be determined by the SAR_BYTE register, the immediate value, or the lower bits in the AR register. You can select appropriate instructions based on your application needs.

All the shift instructions mentioned above are performed based on signed bits.

Table 1-16. Shift Instructions

Instructions	Description
EE.SRC.Q	Perform logical right-shift on the spliced 16-byte data, and the shift value is determined by the SAR_BYTE register.
EE.SRC.Q.QUP	Perform logical right-shift on the spliced 16-byte data, and the shift value is determined by the SAR_BYTE register. Meanwhile, the higher 8-byte data is saved.
EE.SRC.Q.LD.XP	Perform logical right-shift on the spliced 16-byte data, and the shift value is determined by the SAR_BYTE register. At the same time, read 16-byte data from memory and add a register value to the read address.

Instructions	Description
EE.SRC.Q.LD.IP	Perform logical right-shift on the spliced 16-byte data, and the shift value is determined by the SAR_BYTE register. At the same time, read 16-byte data from memory and add an immediate number to the read address.
EE.SLCI.2Q	Perform logical left-shift on the spliced 16-byte data, and the shift value is determined by the immediate value.
EE.SLCXXP.2Q	Perform logical left-shift on the spliced 16-byte data, and the shift value is determined by the value in the AR register.
EE.SRCI.2Q	Perform logical right-shift on the spliced 16-byte data, and the shift value is determined by the immediate value.
EE.SRCXXP.2Q	Perform logical right-shift on the spliced 16-byte data, and the shift value is determined by the value in the AR register.
EE.SRCQ.128.ST.INCP	Perform logical right-shift on the spliced 16-byte data, which will be written to memory after the shift.
EE.VSR.32	Perform vector arithmetic right-shift on the 4-byte data.
EE.VSL.32	Perform vector arithmetic left-shift on the 4-byte data.

1.6.8 FFT Dedicated Instructions

FFT (Fast Fourier Transform) dedicated instructions include butterfly computation instructions, bit reverse instruction, and real number FFT instructions.

Butterfly Computation Instructions

Butterfly computation instructions support radix-2 butterfly computation.

Table 1-17. Butterfly Computation Instructions

Instructions	Description
EE.FFT.R2BF.S16.	Perform radix-2 butterfly computation.
EE.FFT.R2BF.S16.ST.INCP	Perform radix-2 butterfly computation, and write the 16-byte result to memory at the same time.
EE.FFT.CMUL.S16.LD.XP	Perform radix-2 complex butterfly computation, and read 16-byte data from memory at the same time.
EE.FFT.CMUL.S16.ST.XP	Perform radix-2 complex butterfly computation, and write the 16-byte data (consists of the result and partial data segments in QR register) to memory at the same time.

Bit Reverse Instruction

The reverse bit width of this instruction is determined by the value in the FFT_BIT_WIDTH register.

Table 1-18. Bit Reverse Instruction

Instruction	Description
EE.BITREV	Bit reverse instruction.

Real Number FFT Instructions

A single real number FFT instruction can perform a series of complex calculations including addition, multiplication, shifting, etc.

Table 1-19. Real Number FFT Instructions

Instructions	Description
EE.FFT.AMS.S16.LD.INCP.UAUP	Perform complex calculations and read 16-byte data from memory at the same time, then output 16-byte aligned data.
EE.FFT.AMS.S16.LD.INCP	Perform complex calculations and read 16-byte data from memory at the same time. Add 16 to address register.
EE.FFT.AMS.S16.LD.R32.DECP	Perform complex calculations and read 16-byte data from memory at the same time. Reverse the word order of read data. Add 16 to address register.
EE.FFT.AMS.S16.ST.INCP	Perform complex calculation and write 16-byte data (consists of the data in AR and partial data segments in QR) to memory at the same time.
EE.FFT.VST.R32.DECP	Splice the QR register in 2-byte unit, shift the result and write this 16-byte data to memory.

1.6.9 GPIO Control Instructions

GPIO control instructions include instructions to drive GPIO_OUT and get the status of GPIO_IN.

Table 1-20. GPIO Control Instructions

Instruction	Description
EE.WR_MASK_GPIO_OUT	Set GPIO_OUT by mask.
EE.SET_BIT_GPIO_OUT	Set GPIO_OUT.
EE.CLR_BIT_GPIO_OUT	Clear GPIO_OUT.
EE.GET_GPIO_IN	Get the status of GPIO_IN.

1.6.10 Processor Control Instructions

As illustrated in Section 1.5.1.2, there are various special registers inside the ESP32-S3 processor. In order to facilitate the read and write of the values in such special registers, the following types of processor control instructions are provided to realize the data transfer between the special registers and the AR registers.

RSR.* Read Special register

Can read the value from special registers that come with the processor to the AR register. “*” stands for special registers, which only include the SAR register.

WSR.* Write Special register

Can modify the value in special registers that come with the processor via the AR register. “*” stands for special registers, which only include the SAR register.

XSR.* Exchange Special register

Can exchange the values inside the AR register and special registers. “*” stands for special registers, which only

include the SAR register.

RUR.* Read User-defined register

Can read the value from user-defined special registers in the processor to the AR register. “*” stands for special registers, which include SAR_BYTE, ACCX, QACC_H, QACC_L, FFT_BIT_WIDTH and UA_STATE registers.

WSR.* Write User-defined register

Can modify the value in user-defined special registers via the AR register. “*” stands for special registers, which include SAR_BYTE, ACCX, QACC_H, QACC_L, FFT_BIT_WIDTH and UA_STATE registers.

For special registers that exceed 32-bit width, the “_n” suffix is used to distinguish the instructions that read or write different 32-bit segments from the same special register. Taking reading data from the ACCX register as an example, there are two RUR.* instructions, namely RUR.ACCX_0 and RUR.ACCX_1. The former reads the lower 32-bit data from the ACCX register and write it to the AR register; the latter read the left higher 8-bit data from the ACCX register, perform zero extension and write the result to the AR register. Accordingly, QACC_H and QACC_L registers realize data transfer via the five AR registers.

1.7 Instruction Performance

For processors designed based on a pipeline, it is ideal that CPU issues one instruction onto the pipeline per processor cycle. The ESP32-S3 Xtensa processor adopts the 5-stage pipeline technology: I (instruction fetch), R (decode), E (execute), M (memory access), and W (write back). Table 1-21 shows what the processor does at each pipeline stage.

Table 1-21. Five-Stage Pipeline of Xtensa Processor

Pipeline Stage	Number	Operation
I	-	Align instructions (24-bit and 32-bit instructions supported)
R	0	Read the general-purpose registers AR and QR Decode instructions, detect interlocks, and forward operands
E	1	For arithmetic instructions, the ALU (addition, subtraction, multiplication, etc.) works For read memory instructions, generate virtual addresses for memory access For branch jump instructions, select jump addresses
M	2	Issue read and write memory accesses
W	3	Write back to registers the calculated results and the data read from memory

The processor cannot issue an instruction to the pipeline until all the operands and hardware resources required for the operation are ready. However, there are the following hazards in the actual program running process, which can cause stopped pipeline and delayed implementation of instructions.

1.7.1 Data Hazard

When instruction A writes the result to register X (including explicit general-purpose registers and implicit special registers), and instruction B needs to use the same register as an input operand, this case is referred to as that instruction B depends on instruction A. If instruction A prepares the result to be written to register X at the end of the SA pipeline stage, and instruction B reads the data in register X at the beginning of the SB pipeline stage, then instruction A must be issued $D = \max(SA - SB + 1, 0)$ cycles before instruction B.

If the processor fetches instruction B less than D cycles after instruction A, the processor delays issuing instruction B until D cycles have passed. The act of a processor delaying an instruction because of pipeline interactions is called an interlock.

Suppose the SA pipeline stage of instruction A is W and the SB pipeline stage of instruction B is E, instruction B is issued to the pipeline $D = \max(2 - 1 + 1, 0) = 2$ cycles later than instruction A as shown in Figure 1-6.

When the output operand of an instruction is designed to be available at the end of a pipeline stage, it means that the operation of the instruction is over. Usually, instructions that depend on this result data must wait until the output operand is written to the corresponding register before retrieving it from the corresponding register. The Xtensa processor supports the "bypass" operation. It detects when the input operand of an instruction is generated at which pipeline stage of the instruction and does not need to wait for the data to be written to the register. It can directly forward the data from the pipeline stage where it is generated to the stage where it is needed.

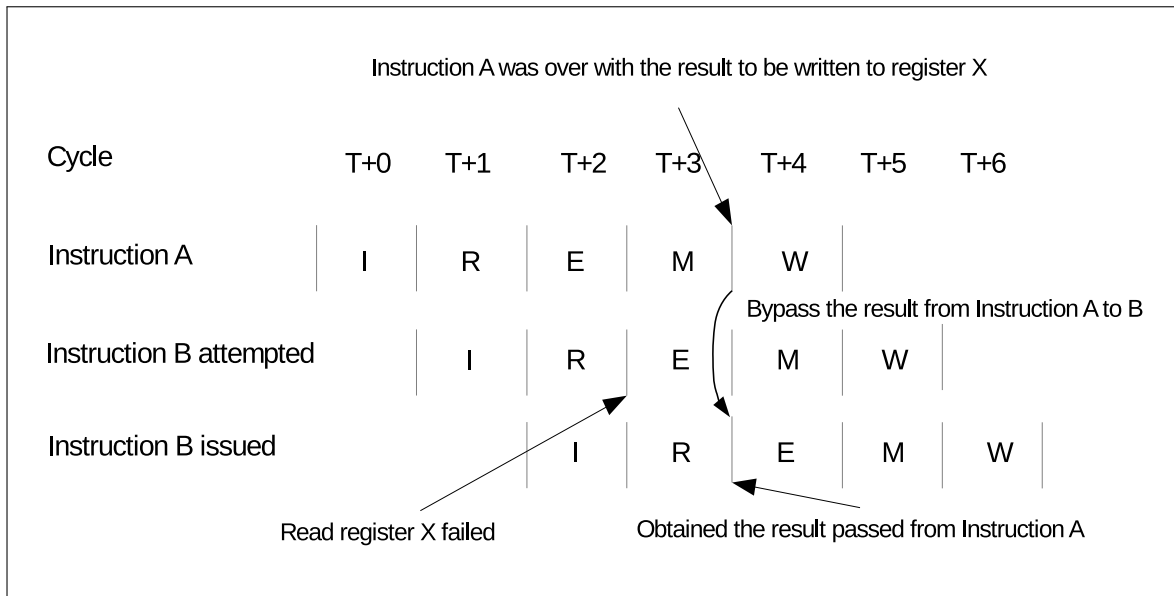

Figure 1-6. Interlock Caused by Instruction Operand Dependency

Data dependencies between instructions are determined by the dependencies between operands and the pipeline stage at which reads and writes happen. Table 1-22 lists all operands of the ESP32-S3 extended instructions, including implicit special register write (def) and read (use) pipeline stage information.

Table 1-22. Extended Instruction Pipeline Stages

Instruction	Operand Pipeline Stage		Special Register Pipeline Stage	
	Use	Def	Use	Def
EE.ANDQ	qx 1, qy 1	qa 1	—	—
EE.BITREV	ax 1	qa 1, ax 1	FFT_BIT_WIDTH 1	—
EE.CLR_BIT_GPIO_OUT	—	—	GPIO_OUT 1	GPIO_OUT 1
EE.CMUL.S16	qx 1, qy 1	qz 2	SAR 1	—
EE.CMUL.S16.LD.INCP	as 1, qx 1, qy 1	qu 2, as 1, qz 2	SAR 1	—
EE.CMUL.S16.ST.INCP	qv 2, as 1, qx 1, qy 1	as 1, qz 2	SAR 1	—
EE.FFT.AMS.S16.LD.INCP	as 1, qx 1, qy 1, qm 1	qu 2, as 1, qz 2, qz1 2	SAR 1	—
EE.FFT.AMS.S16.LD.INCP.UAUP	as 1, qx 1, qy 1, qm 1	qu 2, as 1, qz 2, qz1 2	SAR 1, SAR_BYTE 1, UA_STATE 1	UA_STATE 1
EE.FFT.AMS.S16.LD.R32.DECP	as 1, qx 1, qy 1, qm 1	qu 2, as 1, qz 2, qz1 2	SAR 1	—
EE.FFT.AMS.S16.ST.INCP	qv 2, as0 1, as 1, qx 1, qy 1, qm 1	qz1 2, as0 2, as 1	SAR 1	—
EE.FFT.CMUL.S16.LD.XP	as 1, ad 1, qx 1, qy 1	qu 2, as 1, qz 2	SAR 1	—
EE.FFT.CMUL.S16.ST.XP	qx 1, qy 1, qv 2, as 1, ad 1	as 1	SAR 1	—

EE.FFT.R2BF.S16	qx 1, qy 1	qa0 1, qa1 1	—	—
EE.FFT.R2BF.S16.ST.INCP	qx 1, qy 1, as 1	qa0 1, as 1	—	—
EE.FFT.VST.R32.DECP	qv 2, as 1	as 1	—	—
EE.GET_GPIO_IN	—	au 1	GPIO_IN 1	—
EE.LD.128.USAR.IP	as 1	qu 2, as 1	—	SAR_BYTE 1
EE.LD.128.USAR.XP	as 1, ad 1	qu 2, as 1	—	SAR_BYTE 1
EE.LD.ACCX.IP	as 1	as 1	—	ACCX 2
EE.LD.QACC_H.H.32.IP	as 1	as 1	QACC_H 1	QACC_H 2
EE.LD.QACC_H.L.128.IP	as 1	as 1	QACC_H 1	QACC_H 2
EE.LD.QACC_L.H.32.IP	as 1	as 1	QACC_L 1	QACC_L 2
EE.LD.QACC_L.L.128.IP	as 1	as 1	QACC_L 1	QACC_L 2
EE.LD.UA_STATE.IP	as 1	as 1	—	UA_STATE 2
EE.LDF.128.IP	as 1	fu3 2, fu2 2, fu1 2, fu0 2, as 1	—	—
EE.LDF.128.XP	as 1, ad 1	fu3 2, fu2 2, fu1 2, fu0 2, as 1	—	—
EE.LDF.64.IP	as 1	fu1 2, fu0 2, as 1	—	—
EE.LDF.64.XP	as 1, ad 1	fu1 2, fu0 2, as 1	—	—
EE.LDQA.S16.128.IP	as 1	as 1	—	QACC_L 2, QACC_H 2
EE.LDQA.S16.128.XP	as 1, ad 1	as 1	—	QACC_L 2, QACC_H 2
EE.LDQA.S8.128.IP	as 1	as 1	—	QACC_L 2, QACC_H 2
EE.LDQA.S8.128.XP	as 1, ad 1	as 1	—	QACC_L 2, QACC_H 2
EE.LDQA.U16.128.IP	as 1	as 1	—	QACC_L 2, QACC_H 2
EE.LDQA.U16.128.XP	as 1, ad 1	as 1	—	QACC_L 2, QACC_H 2
EE.LDQA.U8.128.IP	as 1	as 1	—	QACC_L 2, QACC_H 2
EE.LDQA.U8.128.XP	as 1, ad 1	as 1	—	QACC_L 2, QACC_H 2
EE.LDXQ.32	qs 1, as 1	qu 2	—	—
EE.MOV.S16.QACC	qs 1	—	—	QACC_L 1, QACC_H 1
EE.MOV.S8.QACC	qs 1	—	—	QACC_L 1, QACC_H 1
EE.MOV.U16.QACC	qs 1	—	—	QACC_L 1, QACC_H 1
EE.MOV.U8.QACC	qs 1	—	—	QACC_L 1, QACC_H 1
EE.MOVI.32.A	qs 1	au 1	—	—

EE.MOVI.32.Q	as 1	qu 1	—	—
EE.NOTQ	qx 1	qa 1	—	—
EE.ORQ	qx 1, qy 1	qa 1	—	—
EE.SET_BIT_GPIO_OUT	—	—	GPIO_OUT 1	GPIO_OUT 1
EE.SLCI.2Q	qs1 1, qs0 1	qs1 1, qs0 1	—	—
EE.SLCXP.2Q	qs1 1, qs0 1, as 1, ad 1	qs1 1, qs0 1, as 1	—	—
EE.SRC.Q	qs0 1, qs1 1	qa 1	SAR_BYTE 1	—
EE.SRC.Q.LD.IP	as 1, qs0 1, qs1 1	qu 2, as 1, qs0 1	SAR_BYTE 1	—
EE.SRC.Q.LD.XP	as 1, ad 1, qs0 1, qs1 1	qu 2, as 1, qs0 1	SAR_BYTE 1	—
EE.SRC.Q.QUP	qs0 1, qs1 1	qa 1, qs0 1	SAR_BYTE 1	—
EE.SRCI.2Q	qs1 1, qs0 1	qs1 1, qs0 1	—	—
EE.SRCMB.S16.QACC	as 1	qu 1	QACC_H 1, QACC_L 1	QACC_H 1, QACC_L 1
EE.SRCMB.S8.QACC	as 1	qu 1	QACC_H 1, QACC_L 1	QACC_H 1, QACC_L 1
EE.SRCQ.128.ST.INCP	qs0 1, qs1 1, as 1	as 1	SAR_BYTE 1	—
EE.SRCXP.2Q	qs1 1, qs0 1, as 1, ad 1	qs1 1, qs0 1, as 1	—	—
EE.SRS.ACCX	as 1	au 1	ACCX 1	ACCX 1
EE.ST.ACCX.IP	as 1	as 1	ACCX 1	—
EE.ST.QACC_H.H.32.IP	as 1	as 1	QACC_H 1	—
EE.ST.QACC_H.L.128.IP	as 1	as 1	QACC_H 1	—
EE.ST.QACC_L.H.32.IP	as 1	as 1	QACC_L 1	—
EE.ST.QACC_L.L.128.IP	as 1	as 1	QACC_L 1	—
EE.ST.UA_STATE.IP	as 1	as 1	UA_STATE 1	—
EE.STF.128.IP	fv3 1, fv2 1, fv1 1, fv0 1, as 1	as 1	—	—
EE.STF.128.XP	fv3 1, fv2 1, fv1 1, fv0 1, as 1, ad 1	as 1	—	—
EE.STF.64.IP	fv1 1, fv0 1, as 1	as 1	—	—
EE.STF.64.XP	fv1 1, fv0 1, as 1, ad 1	as 1	—	—
EE.STXQ.32	qv 1, qs 1, as 1	—	—	—
EE.VADDS.S16	qx 1, qy 1	qa 1	—	—
EE.VADDS.S16.LD.INCP	as 1, qx 1, qy 1	qu 2, as 1, qa 1	—	—
EE.VADDS.S16.ST.INCP	qv 1, as 1, qx 1, qy 1	as 1, qa 1	—	—
EE.VADDS.S32	qx 1, qy 1	qa 1	—	—
EE.VADDS.S32.LD.INCP	as 1, qx 1, qy 1	qu 2, as 1, qa 1	—	—

EE.VADDS.S32.ST.INCP	qv 1, as 1, qx 1, qy 1	as 1, qa 1	—	—
EE.VADDS.S8	qx 1, qy 1	qa 1	—	—
EE.VADDS.S8.LD.INCP	as 1, qx 1, qy 1	qu 2, as 1, qa 1	—	—
EE.VADDS.S8.ST.INCP	qv 1, as 1, qx 1, qy 1	as 1, qa 1	—	—
EE.VCMP.EQ.S16	qx 1, qy 1	qa 1	—	—
EE.VCMP.EQ.S32	qx 1, qy 1	qa 1	—	—
EE.VCMP.EQ.S8	qx 1, qy 1	qa 1	—	—
EE.VCMP.GT.S16	qx 1, qy 1	qa 1	—	—
EE.VCMP.GT.S32	qx 1, qy 1	qa 1	—	—
EE.VCMP.GT.S8	qx 1, qy 1	qa 1	—	—
EE.VCMP.LT.S16	qx 1, qy 1	qa 1	—	—
EE.VCMP.LT.S32	qx 1, qy 1	qa 1	—	—
EE.VCMP.LT.S8	qx 1, qy 1	qa 1	—	—
EE.VLD.128.IP	as 1	qu 2, as 1	—	—
EE.VLD.128.XP	as 1, ad 1	qu 2, as 1	—	—
EE.VLD.H.64.IP	as 1	qu 2, as 1	—	—
EE.VLD.H.64.XP	as 1, ad 1	qu 2, as 1	—	—
EE.VLD.L.64.IP	as 1	qu 2, as 1	—	—
EE.VLD.L.64.XP	as 1, ad 1	qu 2, as 1	—	—
EE.VLDBC.16	as 1	qu 2	—	—
EE.VLDBC.16.IP	as 1	qu 2, as 1	—	—
EE.VLDBC.16.XP	as 1, ad 1	qu 2, as 1	—	—
EE.VLDBC.32	as 1	qu 2	—	—
EE.VLDBC.32.IP	as 1	qu 2, as 1	—	—
EE.VLDBC.32.XP	as 1, ad 1	qu 2, as 1	—	—
EE.VLDBC.8	as 1	qu 2	—	—
EE.VLDBC.8.IP	as 1	qu 2, as 1	—	—
EE.VLDBC.8.XP	as 1, ad 1	qu 2, as 1	—	—
EE.VLDHBC.16.INCP	as 1	qu 2, qu1 2, as 1	—	—
EE.VMAX.S16	qx 1, qy 1	qa 1	—	—
EE.VMAX.S16.LD.INCP	as 1, qx 1, qy 1	qu 2, as 1, qa 1	—	—
EE.VMAX.S16.ST.INCP	qv 1, as 1, qx 1, qy 1	as 1, qa 1	—	—
EE.VMAX.S32	qx 1, qy 1	qa 1	—	—
EE.VMAX.S32.LD.INCP	as 1, qx 1, qy 1	qu 2, as 1, qa 1	—	—
EE.VMAX.S32.ST.INCP	qv 1, as 1, qx 1, qy 1	as 1, qa 1	—	—
EE.VMAX.S8	qx 1, qy 1	qa 1	—	—
EE.VMAX.S8.LD.INCP	as 1, qx 1, qy 1	qu 2, as 1, qa 1	—	—
EE.VMAX.S8.ST.INCP	qv 1, as 1, qx 1, qy 1	as 1, qa 1	—	—
EE.VMIN.S16	qx 1, qy 1	qa 1	—	—

EE.VMIN.S16.LD.INCP	as 1, qx 1, qy 1	qu 2, as 1, qa 1	—	—
EE.VMIN.S16.ST.INCP	qv 1, as 1, qx 1, qy 1	as 1, qa 1	—	—
EE.VMIN.S32	qx 1, qy 1	qa 1	—	—
EE.VMIN.S32.LD.INCP	as 1, qx 1, qy 1	qu 2, as 1, qa 1	—	—
EE.VMIN.S32.ST.INCP	qv 1, as 1, qx 1, qy 1	as 1, qa 1	—	—
EE.VMIN.S8	qx 1, qy 1	qa 1	—	—
EE.VMIN.S8.LD.INCP	as 1, qx 1, qy 1	qu 2, as 1, qa 1	—	—
EE.VMIN.S8.ST.INCP	qv 1, as 1, qx 1, qy 1	as 1, qa 1	—	—
EE.VMUL.S16	qx 1, qy 1	qz 2	SAR 1	—
EE.VMUL.S16.LD.INCP	as 1, qx 1, qy 1	qu 2, as 1, qz 2	SAR 1	—
EE.VMUL.S16.ST.INCP	qv 1, as 1, qx 1, qy 1	as 1, qz 2	SAR 1	—
EE.VMUL.S8	qx 1, qy 1	qz 2	SAR 1	—
EE.VMUL.S8.LD.INCP	as 1, qx 1, qy 1	qu 2, as 1, qz 2	SAR 1	—
EE.VMUL.S8.ST.INCP	qv 1, as 1, qx 1, qy 1	as 1, qz 2	SAR 1	—
EE.VMUL.U16	qx 1, qy 1	qz 2	SAR 1	—
EE.VMUL.U16.LD.INCP	as 1, qx 1, qy 1	qu 2, as 1, qz 2	SAR 1	—
EE.VMUL.U16.ST.INCP	qv 1, as 1, qx 1, qy 1	as 1, qz 2	SAR 1	—
EE.VMUL.U8	qx 1, qy 1	qz 2	SAR 1	—
EE.VMUL.U8.LD.INCP	as 1, qx 1, qy 1	qu 2, as 1, qz 2	SAR 1	—
EE.VMUL.U8.ST.INCP	qv 1, as 1, qx 1, qy 1	as 1, qz 2	SAR 1	—
EE.VMULAS.S16.ACCX	qx 1, qy 1	—	ACCX 2	ACCX 2
EE.VMULAS.S16.ACCX.LD.IP	as 1, qx 1, qy 1	qu 2, as 1	ACCX 2	ACCX 2
EE.VMULAS.S16.ACCX.LD.IP.QUP	as 1, qx 1, qy 1, qs0 1, qs1 1	qu 2, as 1, qs0 1	SAR_BYTE 1, ACCX 2	ACCX 2
EE.VMULAS.S16.ACCX.LD.XP	as 1, ad 1, qx 1, qy 1	qu 2, as 1	ACCX 2	ACCX 2
EE.VMULAS.S16.ACCX.LD.XP.QUP	as 1, ad 1, qx 1, qy 1, qs0 1, qs1 1	qu 2, as 1, qs0 1	SAR_BYTE 1, ACCX 2	ACCX 2
EE.VMULAS.S16.QACC	qx 1, qy 1	—	QACC_H 2, QACC_L 2	QACC_H 2, QACC_L 2
EE.VMULAS.S16.QACC.LD.IP	as 1, qx 1, qy 1	qu 2, as 1	QACC_H 2, QACC_L 2	QACC_H 2, QACC_L 2
EE.VMULAS.S16.QACC.LD.IP.QUP	as 1, qx 1, qy 1, qs0 1, qs1 1	qu 2, as 1, qs0 1	SAR_BYTE 1, QACC_H 2, QACC_L 2	QACC_H 2, QACC_L 2

EE.VMULAS.S16.QACC.LD.XP	as 1, ad 1, qx 1, qy 1	qu 2, as 1	QACC_H 2, QACC_L 2	QACC_H 2, QACC_L 2
EE.VMULAS.S16.QACC.LD.XP.QUP	as 1, ad 1, qx 1, qy 1, qs0 1, qs1 1	qu 2, as 1, qs0 1	SAR_BYTE 1, QACC_H 2, QACC_L 2	QACC_H 2, QACC_L 2
EE.VMULAS.S16.QACC.LDBC.INCP	as 1, qx 1, qy 1	qu 2, as 1	QACC_H 2, QACC_L 2	QACC_H 2, QACC_L 2
EE.VMULAS.S16.QACC.LDBC.INCP.QUP	as 1, qx 1, qy 1, qs0 1, qs1 1	qu 2, as 1, qs0 1	SAR_BYTE 1, QACC_H 2, QACC_L 2	QACC_H 2, QACC_L 2
EE.VMULAS.S8.ACCX	qx 1, qy 1	—	ACCX 2	ACCX 2
EE.VMULAS.S8.ACCX.LD.IP	as 1, qx 1, qy 1	qu 2, as 1	ACCX 2	ACCX 2
EE.VMULAS.S8.ACCX.LD.IP.QUP	as 1, qx 1, qy 1, qs0 1, qs1 1	qu 2, as 1, qs0 1	SAR_BYTE 1, ACCX 2	ACCX 2
EE.VMULAS.S8.ACCX.LD.XP	as 1, ad 1, qx 1, qy 1	qu 2, as 1	ACCX 2	ACCX 2
EE.VMULAS.S8.ACCX.LD.XP.QUP	as 1, ad 1, qx 1, qy 1, qs0 1, qs1 1	qu 2, as 1, qs0 1	SAR_BYTE 1, ACCX 2	ACCX 2
EE.VMULAS.S8.QACC	qx 1, qy 1	—	QACC_L 2, QACC_H 2	QACC_L 2, QACC_H 2
EE.VMULAS.S8.QACC.LD.IP	as 1, qx 1, qy 1	qu 2, as 1	QACC_H 2, QACC_L 2	QACC_H 2, QACC_L 2
EE.VMULAS.S8.QACC.LD.IP.QUP	as 1, qx 1, qy 1, qs0 1, qs1 1	qu 2, as 1, qs0 1	SAR_BYTE 1, QACC_H 2, QACC_L 2	QACC_H 2, QACC_L 2
EE.VMULAS.S8.QACC.LD.XP	as 1, ad 1, qx 1, qy 1	qu 2, as 1	QACC_H 2, QACC_L 2	QACC_H 2, QACC_L 2
EE.VMULAS.S8.QACC.LD.XP.QUP	as 1, ad 1, qx 1, qy 1, qs0 1, qs1 1	qu 2, as 1, qs0 1	SAR_BYTE 1, QACC_H 2, QACC_L 2	QACC_H 2, QACC_L 2
EE.VMULAS.S8.QACC.LDBC.INCP	as 1, qx 1, qy 1	qu 2, as 1	QACC_H 2, QACC_L 2	QACC_H 2, QACC_L 2
EE.VMULAS.S8.QACC.LDBC.INCP.QUP	as 1, qx 1, qy 1, qs0 1, qs1 1	qu 2, as 1, qs0 1	SAR_BYTE 1, QACC_H 2, QACC_L 2	QACC_H 2, QACC_L 2
EE.VMULAS.U16.ACCX	qx 1, qy 1	—	ACCX 2	ACCX 2
EE.VMULAS.U16.ACCX.LD.IP	as 1, qx 1, qy 1	qu 2, as 1	ACCX 2	ACCX 2
EE.VMULAS.U16.ACCX.LD.IP.QUP	as 1, qx 1, qy 1, qs0 1, qs1 1	qu 2, as 1, qs0 1	SAR_BYTE 1, ACCX 2	ACCX 2
EE.VMULAS.U16.ACCX.LD.XP	as 1, ad 1, qx 1, qy 1	qu 2, as 1	ACCX 2	ACCX 2

EE.VMULAS.U16.ACCX.LD.XP.QUP	as 1, ad 1, qx 1, qy 1, qs0 1, qs1 1	qu 2, as 1, qs0 1	SAR_BYTE 1, ACCX 2	ACCX 2
EE.VMULAS.U16.QACC	qx 1, qy 1	—	QACC_L 2, QACC_H 2	QACC_L 2, QACC_H 2
EE.VMULAS.U16.QACC.LD.IP	as 1, qx 1, qy 1	qu 2, as 1	QACC_L 2, QACC_H 2	QACC_L 2, QACC_H 2
EE.VMULAS.U16.QACC.LD.IP.QUP	as 1, qx 1, qy 1, qs0 1, qs1 1	qu 2, as 1, qs0 1	SAR_BYTE 1, QACC_H 2, QACC_L 2	QACC_H 2, QACC_L 2
EE.VMULAS.U16.QACC.LD.XP	as 1, ad 1, qx 1, qy 1	qu 2, as 1	QACC_L 2, QACC_H 2	QACC_L 2, QACC_H 2
EE.VMULAS.U16.QACC.LD.XP.QUP	as 1, ad 1, qx 1, qy 1, qs0 1, qs1 1	qu 2, as 1, qs0 1	SAR_BYTE 1, QACC_H 2, QACC_L 2	QACC_H 2, QACC_L 2
EE.VMULAS.U16.QACC.LDBC.INCP	as 1, qx 1, qy 1	qu 2, as 1	QACC_L 2, QACC_H 2	QACC_L 2, QACC_H 2
EE.VMULAS.U16.QACC.LDBC.INCP.QUP	as 1, qx 1, qy 1, qs0 1, qs1 1	qu 2, as 1, qs0 1	SAR_BYTE 1, QACC_H 2, QACC_L 2	QACC_H 2, QACC_L 2
EE.VMULAS.U8.ACCX	qx 1, qy 1	—	ACCX 2	ACCX 2
EE.VMULAS.U8.ACCX.LD.IP	as 1, qx 1, qy 1	qu 2, as 1	ACCX 2	ACCX 2
EE.VMULAS.U8.ACCX.LD.IP.QUP	as 1, qx 1, qy 1, qs0 1, qs1 1	qu 2, as 1, qs0 1	SAR_BYTE 1, ACCX 2	ACCX 2
EE.VMULAS.U8.ACCX.LD.XP	as 1, ad 1, qx 1, qy 1	qu 2, as 1	ACCX 2	ACCX 2
EE.VMULAS.U8.ACCX.LD.XP.QUP	as 1, ad 1, qx 1, qy 1, qs0 1, qs1 1	qu 2, as 1, qs0 1	SAR_BYTE 1, ACCX 2	ACCX 2
EE.VMULAS.U8.QACC	qx 1, qy 1	—	QACC_L 2, QACC_H 2	QACC_L 2, QACC_H 2
EE.VMULAS.U8.QACC.LD.IP	as 1, qx 1, qy 1	qu 2, as 1	QACC_L 2, QACC_H 2	QACC_L 2, QACC_H 2
EE.VMULAS.U8.QACC.LD.IP.QUP	as 1, qx 1, qy 1, qs0 1, qs1 1	qu 2, as 1, qs0 1	SAR_BYTE 1, QACC_H 2, QACC_L 2	QACC_H 2, QACC_L 2
EE.VMULAS.U8.QACC.LD.XP	as 1, ad 1, qx 1, qy 1	qu 2, as 1	QACC_L 2, QACC_H 2	QACC_L 2, QACC_H 2
EE.VMULAS.U8.QACC.LD.XP.QUP	as 1, ad 1, qx 1, qy 1, qs0 1, qs1 1	qu 2, as 1, qs0 1	SAR_BYTE 1, QACC_H 2, QACC_L 2	QACC_H 2, QACC_L 2
EE.VMULAS.U8.QACC.LDBC.INCP	as 1, qx 1, qy 1	qu 2, as 1	QACC_L 2, QACC_H 2	QACC_L 2, QACC_H 2

EE.VMULAS.U8.QACC.LDBC.INCP.QUP	as 1, qx 1, qy 1, qs0 1, qs1 1	qu 2, as 1, qs0 1	SAR_BYTE 1, QACC_H 2, QACC_L 2	QACC_H 2, QACC_L 2
EE.VPRELU.S16	qx 1, qy 1, ay 1	qz 2	—	—
EE.VPRELU.S8	qx 1, qy 1, ay 1	qz 2	—	—
EE.VRELU.S16	qs 1, ax 1, ay 1	qs 2	—	—
EE.VRELU.S8	qs 1, ax 1, ay 1	qs 2	—	—
EE.VSL.32	qs 1	qa 1	SAR 1	—
EE.VSMULAS.S16.QACC	qx 1, qy 1	—	QACC_H 2, QACC_L 2	QACC_H 2, QACC_L 2
EE.VSMULAS.S16.QACC.LD.INCP	as 1, qx 1, qy 1	qu 2, as 1	QACC_H 2, QACC_L 2	QACC_H 2, QACC_L 2
EE.VSMULAS.S8.QACC	qx 1, qy 1	—	QACC_L 2, QACC_H 2	QACC_L 2, QACC_H 2
EE.VSMULAS.S8.QACC.LD.INCP	as 1, qx 1, qy 1	qu 2, as 1	QACC_H 2, QACC_L 2	QACC_H 2, QACC_L 2
EE.VSR.32	qs 1	qa 1	SAR 1	—
EE.VST.128.IP	qv 1, as 1	as 1	—	—
EE.VST.128.XP	qv 1, as 1, ad 1	as 1	—	—
EE.VST.H.64.IP	qv 1, as 1	as 1	—	—
EE.VST.H.64.XP	qv 1, as 1, ad 1	as 1	—	—
EE.VST.L.64.IP	qv 1, as 1	as 1	—	—
EE.VST.L.64.XP	qv 1, as 1, ad 1	as 1	—	—
EE.VSUBS.S16	qx 1, qy 1	qa 1	—	—
EE.VSUBS.S16.LD.INCP	as 1, qx 1, qy 1	qu 2, as 1, qa 1	—	—
EE.VSUBS.S16.ST.INCP	qv 1, as 1, qx 1, qy 1	as 1, qa 1	—	—
EE.VSUBS.S32	qx 1, qy 1	qa 1	—	—
EE.VSUBS.S32.LD.INCP	as 1, qx 1, qy 1	qu 2, as 1, qa 1	—	—
EE.VSUBS.S32.ST.INCP	qv 1, as 1, qx 1, qy 1	as 1, qa 1	—	—
EE.VSUBS.S8	qx 1, qy 1	qa 1	—	—
EE.VSUBS.S8.LD.INCP	as 1, qx 1, qy 1	qu 2, as 1, qa 1	—	—
EE.VSUBS.S8.ST.INCP	qv 1, as 1, qx 1, qy 1	as 1, qa 1	—	—
EE.VUNZIP.16	qs0 1, qs1 1	qs0 1, qs1 1	—	—
EE.VUNZIP.32	qs0 1, qs1 1	qs0 1, qs1 1	—	—
EE.VUNZIP.8	qs0 1, qs1 1	qs0 1, qs1 1	—	—
EE.VZIP.16	qs0 1, qs1 1	qs0 1, qs1 1	—	—
EE.VZIP.32	qs0 1, qs1 1	qs0 1, qs1 1	—	—
EE.VZIP.8	qs0 1, qs1 1	qs0 1, qs1 1	—	—
EE.WR_MASK_GPIO_OUT	as 1, ax 1	—	GPIO_OUT 1	GPIO_OUT 1
EE.XORQ	qx 1, qy 1	qa 1	—	—
EE.ZERO.ACCX	—	—	—	ACCX 1

EE.ZERO.Q	—	qa 1	—	—
EE.ZERO.QACC	—	—	—	QACC_L 1, QACC_H 1

1.7.2 Hardware Resource Hazard

When multiple instructions call the same hardware resource at the same time, the processor allows only one of the instructions to occupy the hardware resource, and the rest of them will be delayed. For example, there are only eight 16-bit multipliers in the processor; instruction C requires eight of them in pipeline stage M, and instruction D requires four of them in pipeline stage E. As shown in Figure 1-7, instruction C is issued in cycle T+0, and instruction D is issued in cycle T+1, so four multipliers are applied to be occupied simultaneously in cycle T+3; at this time, the processor will delay the issue of instruction D into the pipeline by one cycle to avoid conflict with instruction C.

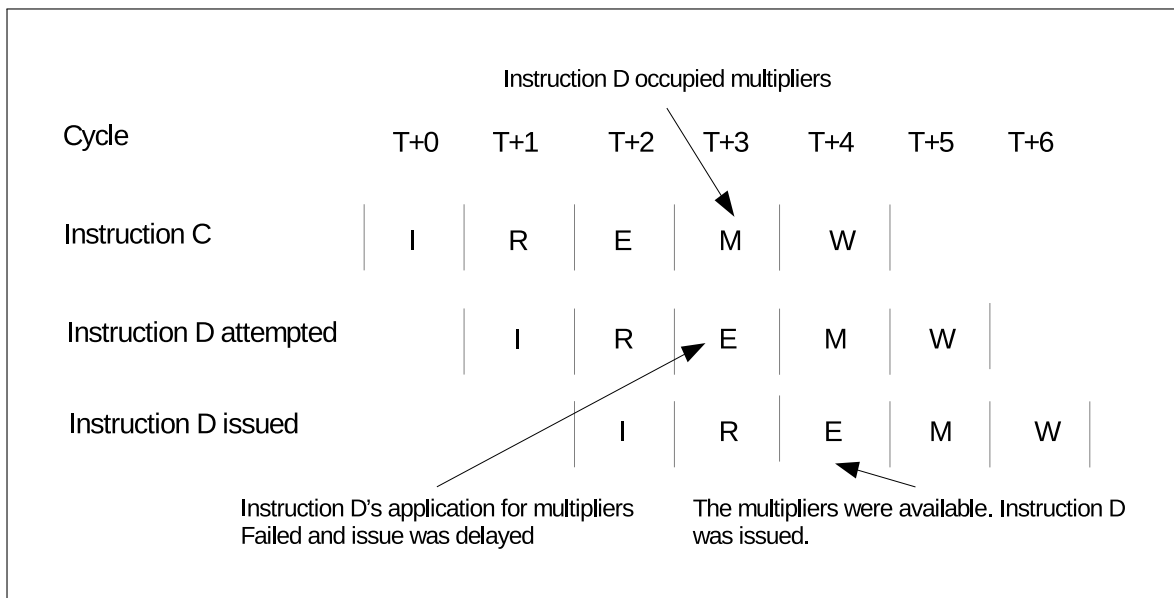

Figure 1-7. Hardware Resource Hazard

1.7.3 Control Hazard

Data and hardware resource hazards can be optimized by adjusting the code order, but the control hazard is difficult to optimize. Program code usually has many conditional select statements that execute different code depending on whether the condition is met or not. The compiler will process the above conditional statements into branch and jump instructions: if the condition is satisfied, it will jump to the target address to execute the corresponding code; if not, the subsequent instructions will be processed in order. When the conditions are met, as shown in Figure 1-8, the processor will re-fetch the instruction from the new target address. At this time, the instructions at the R and E stages on the pipeline will be removed, which means the pipeline remains stagnant for 2 cycles.

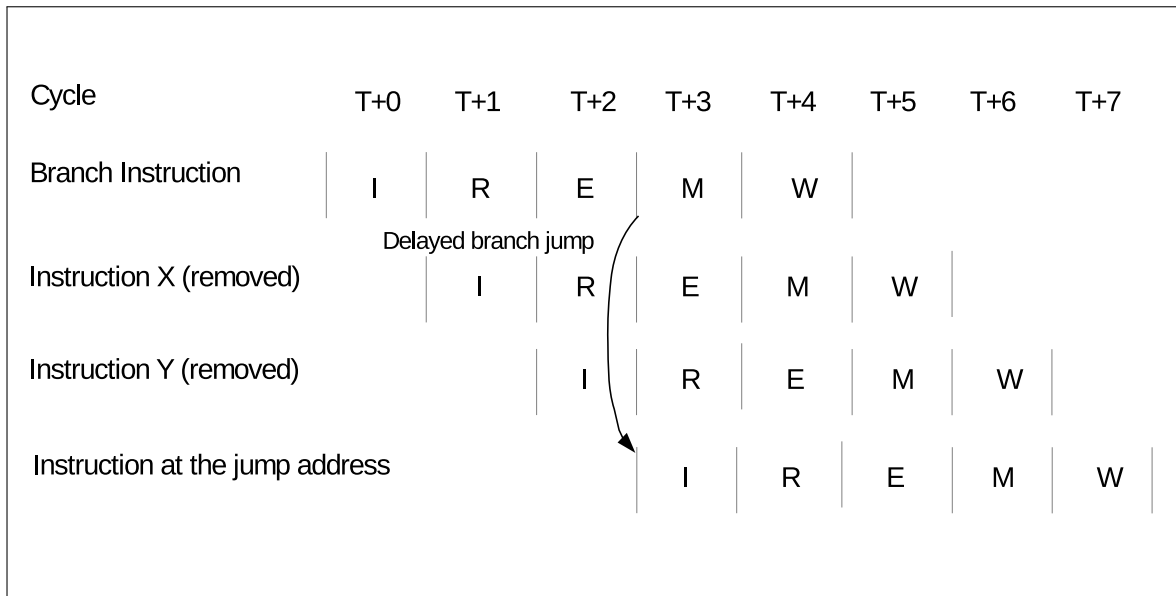

Figure 1-8. Control Hazard

1.8 Extended Instruction Functional Description

Before reading this section, you are recommended to read the table 1-1, which introduces instruction field names and their meanings in instruction encoding.

[N:M] is used to represent the field. It means the width of the field is (N-M+1), namely, both bits N and M are included. For example, qa[2:0] has a total of 3 bits, which are bit0, bit1 and bit2, and qa[1] represents the value of bit1.

This chapter describes all the instructions mentioned in Section 1.6 in alphabetical order by the instruction name. Each instruction is encoded in little-endian bit order as shown in Figure 1-2.

1.8.1 EE.ANDQ

Instruction Word

11	qa[2:1]	1101	qa[0]	011	qy[2:1]	00	qx[2:1]	qy[0]	qx[0]	0100
----	---------	------	-------	-----	---------	----	---------	-------	-------	------

Assembler Syntax

EE.ANDQ qa, qx, qy

Description

This instruction performs a bitwise AND operation on registers qx and qy and writes the result of the logical operation to register qa.

Operation

```
1  qa = qx & qy
```

1.8.2 EE.BITREV

Instruction Word

11	qa[2:1]	1101	qa[0]	1111011	as[3:0]	0100
----	---------	------	-------	---------	---------	------

Assembler Syntax

EE.BITREV qa, as

Description

This instruction swaps the bit order of data of different bit widths according to the value of special register FFT_BIT_WIDTH. Then, it compares the data before and after the swap, takes the larger value, pads the higher bits with 0 until it has 16 bits, and writes the result into the corresponding data segment of register qa. In the following, Switchx is a function that represents the bit inversion of the x-bit. Switch5(0b10100) = 0b00101. Here 0b10100 means 5-bit binary data.

Operation

```

1  temp0[15:0] = as[15:0]
2  temp1[15:0] = as[15:0] + 1
3  temp2[15:0] = as[15:0] + 2
4  temp3[15:0] = as[15:0] + 3
5  temp4[15:0] = as[15:0] + 4
6  temp5[15:0] = as[15:0] + 5
7  temp6[15:0] = as[15:0] + 6
8  temp7[15:0] = as[15:0] + 7
9  if FFT_BIT_WIDTH==3:
10     Switch3(X[2:0]) = X[0:2]
11     qa[ 15: 0] = {13'h0, max(tmp0[2:0], Switch3(tmp0[2:0]))}
12     qa[ 31: 16] = {13'h0, max(tmp1[2:0], Switch3(tmp1[2:0]))}
13     qa[ 47: 32] = {13'h0, max(tmp2[2:0], Switch3(tmp2[2:0]))}
14     qa[ 63: 48] = {13'h0, max(tmp3[2:0], Switch3(tmp3[2:0]))}
15     qa[ 79: 64] = {13'h0, max(tmp4[2:0], Switch3(tmp4[2:0]))}
16     qa[ 95: 80] = {13'h0, max(tmp5[2:0], Switch3(tmp5[2:0]))}
17     qa[127: 96] = 0
18  if FFT_BIT_WIDTH==4:
19     Switch4(X[3:0]) = X[0:3]
20     qa[ 15: 0] = {12'h0, max(tmp0[3:0], Switch4(tmp0[3:0]))}
21     qa[ 31: 16] = {12'h0, max(tmp1[3:0], Switch4(tmp1[3:0]))}
22     qa[ 47: 32] = {12'h0, max(tmp2[3:0], Switch4(tmp2[3:0]))}
23     qa[ 63: 48] = {12'h0, max(tmp3[3:0], Switch4(tmp3[3:0]))}
24     qa[ 79: 64] = {12'h0, max(tmp4[3:0], Switch4(tmp4[3:0]))}
25     qa[ 95: 80] = {12'h0, max(tmp5[3:0], Switch4(tmp5[3:0]))}
26     qa[111: 96] = {12'h0, max(tmp6[3:0], Switch4(tmp6[3:0]))}
27     qa[127:112] = {12'h0, max(tmp7[3:0], Switch4(tmp7[3:0]))}
28     ...
29  if FFT_BIT_WIDTH==10:
30     Switch10(X[9:0]) = X[0:9]
31     qa[ 15: 0] = {6'h0, max(tmp0[9:0], Switch10(tmp0[9:0]))}
32     qa[ 31: 16] = {6'h0, max(tmp1[9:0], Switch10(tmp1[9:0]))}
33     qa[ 47: 32] = {6'h0, max(tmp2[9:0], Switch10(tmp2[9:0]))}
34     qa[ 63: 48] = {6'h0, max(tmp3[9:0], Switch10(tmp3[9:0]))}
35     qa[ 79: 64] = {6'h0, max(tmp4[9:0], Switch10(tmp4[9:0]))}
36     qa[ 95: 80] = {6'h0, max(tmp5[9:0], Switch10(tmp5[9:0]))}

```

```
37 qa[111:96] = {6'h0, max(tmp6[9:0], Switch10(tmp6[9:0]))}  
38 qa[127:112] = {6'h0, max(tmp7[9:0], Switch10(tmp7[9:0]))}  
39  
40 as[31:0] = as[31:0] + 8
```

1.8.3 EE.CLR_BIT_GPIO_OUT

Instruction Word

011101100100	imm256[7:0]	0100
--------------	-------------	------

Assembler Syntax

EE.CLR_BIT_GPIO_OUT 0..255

Description

It is a dedicated CPU GPIO instruction to clear certain GPIO_OUT bits. The content to clear depends on the 8-bit immediate number `imm256`.

Operation

```
1 GPIO_OUT[7:0] = (GPIO_OUT[7:0] & ~imm256[7:0])
```

1.8.4 EE.CMUL.S16

Instruction Word

10	qz[2:1]	1110	qz[0]	qy[2]	0	qy[1:0]	qx[2:0]	00	sel4[1:0]	0100
----	---------	------	-------	-------	---	---------	---------	----	-----------	------

Assembler Syntax

EE.CMUL.S16 qz, qx, qy, 0..3

Description

This instruction performs a 16-bit signed complex multiplication. The range of the immediate number `sel4` is 0 ~ 3, which specifies the 32 bits in the two QR registers `qx` and `qy` for complex multiplication. The real and imaginary parts of complex numbers are stored in the upper 16 bits and lower 16 bits of the 32 bits respectively. The calculated real part and imaginary part results are stored in the corresponding 32 bits of register `qz`.

Operation

```

1  if sel4 == 0:
2      qz[ 15: 0] = (qx[ 15: 0] * qy[ 15: 0] - qx[ 31: 16] * qy[ 31: 16]) >> SAR[5:0]
3      qz[ 31: 16] = (qx[ 15: 0] * qy[ 31: 16] + qx[ 31: 16] * qy[ 15: 0]) >> SAR[5:0]
4      qz[ 47: 32] = (qx[ 47: 32] * qy[ 47: 32] - qx[ 63: 48] * qy[ 63: 48]) >> SAR[5:0]
5      qz[ 63: 48] = (qx[ 47: 32] * qy[ 63: 48] + qx[ 63: 48] * qy[ 47: 32]) >> SAR[5:0]
6  if sel4 == 1:
7      qz[ 79: 64] = (qx[ 79: 64] * qy[ 79: 64] - qx[ 95: 80] * qy[ 95: 80]) >> SAR[5:0]
8      qz[ 95: 80] = (qx[ 79: 64] * qy[ 95: 80] + qx[ 95: 80] * qy[ 79: 64]) >> SAR[5:0]
9      qz[111: 96] = (qx[111: 96] * qy[111: 96] - qx[127:112] * qy[127:112]) >> SAR[5:0]
10     qz[127:112] = (qx[111: 96] * qy[127:112] + qx[127:112] * qy[111: 96]) >> SAR[5:0]
11  if sel4 == 2:
12     qz[ 15: 0] = (qx[ 15: 0] * qy[ 15: 0] + qx[ 31: 16] * qy[ 31: 16]) >> SAR[5:0]
13     qz[ 31: 16] = (qx[ 15: 0] * qy[ 31: 16] - qx[ 31: 16] * qy[ 15: 0]) >> SAR[5:0]
14     qz[ 47: 32] = (qx[ 47: 32] * qy[ 47: 32] + qx[ 63: 48] * qy[ 63: 48]) >> SAR[5:0]
15     qz[ 63: 48] = (qx[ 47: 32] * qy[ 63: 48] - qx[ 63: 48] * qy[ 47: 32]) >> SAR[5:0]
16  if sel4 == 3:
17     qz[ 79: 64] = (qx[ 79: 64] * qy[ 79: 64] + qx[ 95: 80] * qy[ 95: 80]) >> SAR[5:0]
18     qz[ 95: 80] = (qx[ 79: 64] * qy[ 95: 80] - qx[ 95: 80] * qy[ 79: 64]) >> SAR[5:0]
19     qz[111: 96] = (qx[111: 96] * qy[111: 96] + qx[127:112] * qy[127:112]) >> SAR[5:0]
20     qz[127:112] = (qx[111: 96] * qy[127:112] - qx[127:112] * qy[111: 96]) >> SAR[5:0]

```

1.8.5 EE.CMUL.S16.LD.INCP

Instruction Word

111000	qu[2:1]	qy[0]	000	qu[0]	qz[2:0]	qx[1:0]	qy[2:1]	11	sel4[1:0]	as[3:0]	111	qx[2]
--------	---------	-------	-----	-------	---------	---------	---------	----	-----------	---------	-----	-------

Assembler Syntax

EE.CMUL.S16.LD.INCP qu, as, qz, qx, qy, 0..3

Description

This instruction performs a 16-bit signed complex multiplication. The range of the immediate number sel4 is 0 ~ 7, which specifies the 32 bits in the two QR registers qx and qy for complex multiplication. The real and imaginary parts of complex numbers are stored in the upper 16 bits and lower 16 bits of the 32 bits respectively. The calculated real part and imaginary part results are stored in the corresponding 32 bits of register qz.

During the operation, the lower 4 bits of the access address in register as are forced to be 0, and then the 16-byte data is loaded from the memory to register qu. After the access, the value in register as is incremented by 16.

Operation

```

1  if sel4 == 0:
2      qz[ 15: 0] = (qx[ 15: 0] * qy[ 15: 0] - qx[ 31: 16] * qy[ 31: 16]) >> SAR[5:0]
3      qz[ 31: 16] = (qx[ 15: 0] * qy[ 31: 16] + qx[ 31: 16] * qy[ 15: 0]) >> SAR[5:0]
4      qz[ 47: 32] = (qx[ 47: 32] * qy[ 47: 32] - qx[ 63: 48] * qy[ 63: 48]) >> SAR[5:0]
5      qz[ 63: 48] = (qx[ 47: 32] * qy[ 63: 48] + qx[ 63: 48] * qy[ 47: 32]) >> SAR[5:0]
6  if sel4 == 1:
7      qz[ 79: 64] = (qx[ 79: 64] * qy[ 79: 64] - qx[ 95: 80] * qy[ 95: 80]) >> SAR[5:0]
8      qz[ 95: 80] = (qx[ 79: 64] * qy[ 95: 80] + qx[ 95: 80] * qy[ 79: 64]) >> SAR[5:0]
9      qz[111: 96] = (qx[111: 96] * qy[111: 96] - qx[127:112] * qy[127:112]) >> SAR[5:0]
10     qz[127:112] = (qx[111: 96] * qy[127:112] + qx[127:112] * qy[111: 96]) >> SAR[5:0]
11  if sel4 == 2:
12     qz[ 15: 0] = (qx[ 15: 0] * qy[ 15: 0] + qx[ 31: 16] * qy[ 31: 16]) >> SAR[5:0]
13     qz[ 31: 16] = (qx[ 15: 0] * qy[ 31: 16] - qx[ 31: 16] * qy[ 15: 0]) >> SAR[5:0]
14     qz[ 47: 32] = (qx[ 47: 32] * qy[ 47: 32] + qx[ 63: 48] * qy[ 63: 48]) >> SAR[5:0]
15     qz[ 63: 48] = (qx[ 47: 32] * qy[ 63: 48] - qx[ 63: 48] * qy[ 47: 32]) >> SAR[5:0]
16  if sel4 == 3:
17     qz[ 79: 64] = (qx[ 79: 64] * qy[ 79: 64] + qx[ 95: 80] * qy[ 95: 80]) >> SAR[5:0]
18     qz[ 95: 80] = (qx[ 79: 64] * qy[ 95: 80] - qx[ 95: 80] * qy[ 79: 64]) >> SAR[5:0]
19     qz[111: 96] = (qx[111: 96] * qy[111: 96] + qx[127:112] * qy[127:112]) >> SAR[5:0]
20     qz[127:112] = (qx[111: 96] * qy[127:112] - qx[127:112] * qy[111: 96]) >> SAR[5:0]
21
22     qu[127:0] = load128({as[31:4],4{0}})
23     as[31:0] = as[31:0] + 16

```

1.8.6 EE.CMUL.S16.ST.INCP

Instruction Word

11100100	qy[0]	qv[2:0]	0	qz[2:0]	qx[1:0]	qy[2:1]	00	sel4[1:0]	as[3:0]	111	qx[2]
----------	-------	---------	---	---------	---------	---------	----	-----------	---------	-----	-------

Assembler Syntax

EE.CMUL.S16.ST.INCP qv, as, qz, qx, qy, sel4

Description

This instruction performs a 16-bit signed complex multiplication. The range of the immediate number `sel4` is 0 ~ 7, which specifies the 32 bits in the two QR registers `qx` and `qy` for complex multiplication. The real and imaginary parts of complex numbers are stored in the upper 16 bits and lower 16 bits of the 32 bits respectively. The calculated real part and imaginary part results are stored in the corresponding 32 bits of register `qz`.

During the operation, the lower 4 bits of the access address in register `as` are forced to be 0, and then stores the 16-byte data of `qv` to memory. After the access, the value in register `as` is incremented by 16.

Operation

```

1  if sel4 == 0:
2      qz[ 15: 0] = (qx[ 15: 0] * qy[ 15: 0] - qx[ 31: 16] * qy[ 31: 16]) >> SAR[5:0]
3      qz[ 31: 16] = (qx[ 15: 0] * qy[ 31: 16] + qx[ 31: 16] * qy[ 15: 0]) >> SAR[5:0]
4      qz[ 47: 32] = (qx[ 47: 32] * qy[ 47: 32] - qx[ 63: 48] * qy[ 63: 48]) >> SAR[5:0]
5      qz[ 63: 48] = (qx[ 47: 32] * qy[ 63: 48] + qx[ 63: 48] * qy[ 47: 32]) >> SAR[5:0]
6  if sel4 == 1:
7      qz[ 79: 64] = (qx[ 79: 64] * qy[ 79: 64] - qx[ 95: 80] * qy[ 95: 80]) >> SAR[5:0]
8      qz[ 95: 80] = (qx[ 79: 64] * qy[ 95: 80] + qx[ 95: 80] * qy[ 79: 64]) >> SAR[5:0]
9      qz[111: 96] = (qx[111: 96] * qy[111: 96] - qx[127:112] * qy[127:112]) >> SAR[5:0]
10     qz[127:112] = (qx[111: 96] * qy[127:112] + qx[127:112] * qy[111: 96]) >> SAR[5:0]
11  if sel4 == 2:
12     qz[ 15: 0] = (qx[ 15: 0] * qy[ 15: 0] + qx[ 31: 16] * qy[ 31: 16]) >> SAR[5:0]
13     qz[ 31: 16] = (qx[ 15: 0] * qy[ 31: 16] - qx[ 31: 16] * qy[ 15: 0]) >> SAR[5:0]
14     qz[ 47: 32] = (qx[ 47: 32] * qy[ 47: 32] + qx[ 63: 48] * qy[ 63: 48]) >> SAR[5:0]
15     qz[ 63: 48] = (qx[ 47: 32] * qy[ 63: 48] - qx[ 63: 48] * qy[ 47: 32]) >> SAR[5:0]
16  if sel4 == 3:
17     qz[ 79: 64] = (qx[ 79: 64] * qy[ 79: 64] + qx[ 95: 80] * qy[ 95: 80]) >> SAR[5:0]
18     qz[ 95: 80] = (qx[ 79: 64] * qy[ 95: 80] - qx[ 95: 80] * qy[ 79: 64]) >> SAR[5:0]
19     qz[111: 96] = (qx[111: 96] * qy[111: 96] + qx[127:112] * qy[127:112]) >> SAR[5:0]
20     qz[127:112] = (qx[111: 96] * qy[127:112] - qx[127:112] * qy[111: 96]) >> SAR[5:0]
21
22     qv[127:0] => store128({as[31:4],4{0}})
23     as[31:0] = as[31:0] + 16

```

1.8.7 EE.FFT.AMS.S16.LD.INCP

Instruction Word

110100	sel2[0]	qz1[2]	qz[0]	qy[2:0]	qz1[1]	qm[2:0]	qx[1:0]	qz[2:1]	qz1[0]	qu[2:0]	as[3:0]	111	qx[2]
--------	---------	--------	-------	---------	--------	---------	---------	---------	--------	---------	---------	-----	-------

Assembler Syntax

EE.FFT.AMS.S16.LD.INCP qu, as, qz, qz1, qx, qy, qm, sel2

Description

It is a dedicated FFT instruction to perform addition, subtraction, multiplication, addition and subtraction, and shift operations on 16-bit data segments.

During the operation, the lower 4 bits of the access address in register `as` are forced to be 0, and then the 16-byte data is loaded from the memory to register `qu`. After the access, the value in register `as` is incremented by 16.

Operation

```

1  temp0[15:0] = qx[ 47: 32] + qy[ 47: 32]
2  temp1[15:0] = qx[ 63: 48] - qy[ 63: 48]
3
4  if sel2==0:
5  temp2[15:0] = ((qx[ 47: 32] - qy[ 47: 32]) * qm[ 47: 32] - (qx[ 63: 48] + qy[ 63: 48]) *
   temp[ 63: 48]) >> SAR
6  temp3[15:0] = ((qx[ 47: 32] - qy[ 47: 32]) * qm[ 63: 48] + (qx[ 63: 48] + qy[ 63: 48]) *
   qm[ 47: 32]) >> SAR
7  if sel2==1:
8  temp2[15:0] = ((qx[ 63: 48] + qy[ 63: 48]) * qm[ 63: 48] + (qx[ 47: 32] - qy[ 47: 32]) *
   qm[ 47: 32]) >> SAR
9  temp3[15:0] = ((qx[ 63: 48] + qy[ 63: 48]) * qm[ 47: 32] - (qx[ 47: 32] - qy[ 47: 32]) *
   qm[ 63: 48]) >> SAR
10
11  qz[47: 32] = temp0[15:0] + temp2[15:0]
12  qz[63: 48] = temp1[15:0] + temp3[15:0]
13  qz1[47: 32] = temp0[15:0] - temp2[15:0]
14  qz1[63: 48] = temp3[15:0] - temp1[15:0]
15  qu = load128({as[31:4],4{0}})
16  as[31:0] = as[31:0] + 16

```

1.8.8 EE.FFT.AMS.S16.LD.INCP.UAUP

Instruction Word

110101	sel2[0]	qz1[2]	qz[0]	qy[2:0]	qz1[1]	qm[2:0]	qx[1:0]	qz[2:1]	qz1[0]	qu[2:0]	as[3:0]	111	qx[2]
--------	---------	--------	-------	---------	--------	---------	---------	---------	--------	---------	---------	-----	-------

Assembler Syntax

EE.FFT.AMS.S16.LD.INCP.UAUP qu, as, qz, qz1, qx, qy, qm, sel2

Description

It is a dedicated FFT instruction to perform addition, subtraction, multiplication, addition and subtraction, and shift operations on 16-bit data segments.

During the operation, the lower 4 bits of the access address in the register `as` are forced to be 0, and then the 16-byte data is loaded from the memory. The instruction joins the loaded data and the data in special register `UA_STATE` into 32-byte data, right-shifts the 32-byte data by the result of the `SAR_BYTE` value multiplied by 8, and assigns the lower 128 bits of the shifted result to register `qu`. Meanwhile, register `UA_STATE` is updated with the loaded 16-byte data. After the access, the value in register `as` is incremented by 16.

Operation

```

1  temp0[15:0] = qx[ 15: 0] + qy[ 15: 0]
2  temp1[15:0] = qx[ 31: 16] - qy[ 31: 16]
3
4  if sel2==0:
5  temp2[15:0] = ((qx[ 15: 0] - qy[ 15: 0]) * qm[ 15: 0] - (qx[ 31: 16] + qy[ 31: 16]) *
   temp2[ 31: 16]) >> SAR
6  temp3[15:0] = ((qx[ 15: 0] - qy[ 15: 0]) * qm[ 31: 16] + (qx[ 31: 16] + qy[ 31: 16]) *
   temp3[ 15: 0]) >> SAR
7  if sel2==1:
8  temp2[15:0] = ((qx[ 31: 16] + qy[ 31: 16]) * qm[ 31: 16] + (qx[ 15: 0] - qy[ 15: 0]) *
   temp2[ 15: 0]) >> SAR
9  temp3[15:0] = ((qx[ 31: 16] + qy[ 31: 16]) * qm[ 15: 0] - (qx[ 15: 0] - qy[ 15: 0]) *
   temp3[ 31: 16]) >> SAR
10
11 dataIn[127:0] = load128({as[31:4],4{0}})
12 qz[15: 0] = temp0[15:0] + temp2[15:0]
13 qz[31: 16] = temp1[15:0] + temp3[15:0]
14 qz1[15: 0] = temp0[15:0] - temp2[15:0]
15 qz1[31:16] = temp3[15:0] - temp1[15:0]
16 qu[127: 0] = {dataIn[127:0], UA_STATE[127:0]} >> {SAR_BYTE[3:0] << 3}
17 UA_STATE[127:0] = dataIn[127:0]
18 as[31:0] = as[31:0] + 16

```

1.8.9 EE.FFT.AMS.S16.LD.R32.DECP

Instruction Word

110110	sel2[0]	qz1[2]	qz[0]	qy[2:0]	qz1[1]	qm[2:0]	qx[1:0]	qz[2:1]	qz1[0]	qu[2:0]	as[3:0]	111	qx[2]
--------	---------	--------	-------	---------	--------	---------	---------	---------	--------	---------	---------	-----	-------

Assembler Syntax

EE.FFT.AMS.S16.LD.R32.DECP qu, as, qz, qz1, qx, qy, qm, sel2

Description

It is a dedicated FFT instruction to perform addition, subtraction, multiplication, addition and subtraction, and shift operations on 16-bit data segments.

During the operation, the instruction forces the lower 4 bits of the access address in register as to 0 and loads the 16-byte data from the memory to register qu in the big-endian word order, namely, loads the segment [127:96] of the data to [31:0] of qu. After the access is completed, the value in register as is decreased by 16.

Operation

```

1   temp0[15:0] = qx[ 79: 64] + qy[ 79: 64]
2   temp1[15:0] = qx[ 95: 80] - qy[ 95: 80]
3
4   if sel2==0:
5       temp2[15:0] = ((qx[ 79: 64] - qy[ 79: 64]) * qm[ 79: 64] - (qx[ 95: 80] + qy[ 95: 80]) *
6           qm[ 95: 80]) >> SAR
7       temp3[15:0] = ((qx[ 79: 64] - qy[ 79: 64]) * qm[ 95: 80] + (qx[ 95: 80] + qy[ 95: 80]) *
8           qm[ 79: 64]) >> SAR
9   if sel2==1:
10      temp2[15:0] = ((qx[ 95: 80] + qy[ 95: 80]) * qm[ 95: 80] + (qx[ 79: 64] - qy[ 79: 64]) *
11          qm[ 79: 64]) >> SAR
12      temp3[15:0] = ((qx[ 95: 80] + qy[ 95: 80]) * qm[ 79: 64] - (qx[ 79: 64] - qy[ 79: 64]) *
13          qm[ 95: 80]) >> SAR
14
15      qz[79: 64] = temp0[15:0] + temp2[15:0]
16      qz[95: 80] = temp1[15:0] + temp3[15:0]
17      qz1[79:64] = temp0[15:0] - temp2[15:0]
18      qz1[95:80] = temp3[15:0] - temp1[15:0]
19      {qu[31: 0], qu[63: 32], qu[95: 64], qu[127: 96]} = load128({as[31:4],4{0}})
20      as[31:0] = as[31:0] - 16

```

1.8.10 EE.FFT.AMS.S16.ST.INCP

Instruction Word

10100	sel2[0]	qz1[2:1]	qm[0]	qv[2:0]	qz1[0]	qx[2:0]	qy[1:0]	qm[2:1]	as[3:0]	at[3:0]	111	qy[2]
-------	---------	----------	-------	---------	--------	---------	---------	---------	---------	---------	-----	-------

Assembler Syntax

EE.FFT.AMS.S16.ST.INCP qv, qz1, at, as, qx, qy, qm, sel2

Description

It is a dedicated FFT instruction to perform addition, subtraction, multiplication, addition and subtraction, and shift operations on 16-bit data segments.

During the operation, the instruction forces the lower 4 bits of the access address in register as to 0, splices the values in registers qv and at into 16-byte data, and stores the spliced result to memory. After the access is completed, the value in register as is incremented by 16. Besides, the operation result is updated to register at.

Operation

```

1  temp0[15:0] = qx[111: 96] + qy[111: 96]
2  temp1[15:0] = qx[127:112] - qy[127:112]
3
4  if sel2==0:
5      temp2[15:0] = ((qx[111: 96] - qy[111: 96]) * qm[111: 96] - (qx[127:112] + qy[127:112]) *
6          qm[127:112]) >> SAR[5:0]
7      temp3[15:0] = ((qx[111: 96] - qy[111: 96]) * qm[127:112] + (qx[127:112] + qy[127:112]) *
8          qm[111: 96]) >> SAR[5:0]
9      {qv[ 95: 80] >> 1, qv[ 79: 64] >> 1, qv[ 63: 48] >> 1, qv[ 47: 32] >> 1, qv[ 31: 16] >>
10         1, qv[ 15:  0] >> 1, at[31: 16] >> 1, at[15:0] >> 1} => store128({as[31:4],4{0}})
11
12  if sel2==1:
13      temp2[15:0] = ((qx[127:112] + qy[127:112]) * qm[127:112] + (qx[111: 96] - qy[111: 96]) *
14          qm[111: 96]) >> SAR[5:0]
15      temp3[15:0] = ((qx[127:112] + qy[127:112]) * qm[111: 96] - (qx[111: 96] - qy[111: 96]) *
16          qm[127:112]) >> SAR[5:0]
17      {qv[ 95: 64], qv[ 63: 32], qv[ 31:  0], at[31:0]} => store128({as[31:4],4{0}})
18
19  temp4[16:0] = temp1[15:0] + temp3[15:0]
20  temp5[16:0] = temp0[15:0] + temp2[15:0]
21  qz1[111: 96] = temp0[15:0] - temp2[15:0]
22  qz1[127:112] = temp3[15:0] - temp1[15:0]
23  at = {temp4[15:0], temp5[15:0]}
24  as[31:0] = as[31:0] +16

```

1.8.11 EE.FFT.CMUL.S16.LD.XP

Instruction Word

110111	sel8[2:1]	qu[0]	qy[2:0]	sel8[0]	qz[2:0]	qx[1:0]	qu[2:1]	ad[3:0]	as[3:0]	111	qx[2]
--------	-----------	-------	---------	---------	---------	---------	---------	---------	---------	-----	-------

Assembler Syntax

EE.FFT.CMUL.S16.LD.XP qu, as, ad, qz, qx, qy, sel8

Description

This instruction performs a 16-bit signed complex multiplication. It is similar to [EE.CMUL.S16](#) except that the order of registers qx and qy is reversed.

During the operation, the lower 4 bits of the access address in register as are forced to be 0, and then the 16-byte data is loaded from the memory to register qu. After the access is completed, the value in register as is incremented by the value in register ad.

Operation

```

1  if sel8 == 0:
2      qz[ 15: 0] = (qx[ 15: 0] * qy[ 15: 0] + qx[ 31: 16] * qy[ 31: 16]) >> SAR[5:0]
3      qz[ 31: 16] = (qx[ 31: 16] * qy[ 15: 0] - qx[ 15: 0] * qy[ 31: 16]) >> SAR[5:0]
4  if sel8 == 1:
5      qz[ 15: 0] = (qx[ 15: 0] * qy[ 15: 0] - qx[ 31: 16] * qy[ 31: 16]) >> SAR[5:0]
6      qz[ 31: 16] = (qx[ 31: 16] * qy[ 15: 0] + qx[ 15: 0] * qy[ 31: 16]) >> SAR[5:0]
7  if sel8 == 2:
8      qz[ 47: 32] = (qx[ 47: 32] * qy[ 47: 32] + qx[ 63: 48] * qy[ 63: 48]) >> SAR[5:0]
9      qz[ 63: 48] = (qx[ 63: 48] * qy[ 47: 32] - qx[ 47: 32] * qy[ 63: 48]) >> SAR[5:0]
10 if sel8 == 3:
11     qz[ 47: 32] = (qx[ 47: 32] * qy[ 47: 32] - qx[ 63: 48] * qy[ 63: 48]) >> SAR[5:0]
12     qz[ 63: 48] = (qx[ 63: 48] * qy[ 47: 32] + qx[ 47: 32] * qy[ 63: 48]) >> SAR[5:0]
13 if sel8 == 4:
14     qz[ 79: 64] = (qx[ 79: 64] * qy[ 79: 64] + qx[ 95: 80] * qy[ 95: 80]) >> SAR[5:0]
15     qz[ 95: 80] = (qx[ 95: 80] * qy[ 79: 64] - qx[ 79: 64] * qy[ 95: 80]) >> SAR[5:0]
16 if sel8 == 5:
17     qz[ 79: 64] = (qx[ 79: 64] * qy[ 79: 64] - qx[ 95: 80] * qy[ 95: 80]) >> SAR[5:0]
18     qz[ 95: 80] = (qx[ 95: 80] * qy[ 79: 64] + qx[ 79: 64] * qy[ 95: 80]) >> SAR[5:0]
19
20 qu[127:0] = load128({as[31:4],4{0}})
21 as[31:0] = as[31:0] + ad[31:0]

```

1.8.12 EE.FFT.CMUL.S16.ST.XP

Instruction Word

10101	sar4[1:0]	upd4[1]	sel8[0]	qy[2:0]	upd4[0]	qv[2:0]	qx[1:0]	sel8[2:1]	ad[3:0]	as[3:0]	111	qx[2]
-------	-----------	---------	---------	---------	---------	---------	---------	-----------	---------	---------	-----	-------

Assembler Syntax

EE.FFT.CMUL.S16.ST.XP qx, qy, qv, as, ad, sel8, upd4, sar4

Description

This instruction performs a 16-bit signed complex multiplication. It is similar to [EE.CMUL.S16](#) except that the order of registers qx and qy is reversed.

The result of the operation and the data segments in registers qx and qv specified by the immediate data upd4 are concatenated into 128 bits, which then are written into memory. After the access is completed, the value in register as is incremented by the value in register ad. **Operation**

```

1  if sel8 == 6:
2      temp[15:0] = (qx[111: 96] * qy[111: 96] + qx[127:112] * qy[127:112]) >> SAR[5:0]
3      temp[31:16] = (qx[127:112] * qy[111: 96] - qx[111: 96] * qy[127:112]) >> SAR[5:0]
4  if sel8 == 7:
5      temp[15:0] = (qx[111: 96] * qy[111: 96] - qx[127:112] * qy[127:112]) >> SAR[5:0]
6      temp[31:16] = (qx[127:112] * qy[111: 96] + qx[111: 96] * qy[127:112]) >> SAR[5:0]
7
8  if upd4 == 0: // normal radix 2
9      {temp[31:0], qv[ 95: 0]} => store128({as[31:4],4{0}})
10 if upd4 == 1: // radix2 last second stage
11     {
12         temp[31:0],
13         qv[ 95: 64],
14         qx[ 63: 48] >> sar4,
15         qx[ 47: 32] >> sar4,
16         qx[ 31: 16] >> sar4,
17         qx[ 15:  0] >> sar4
18     } => store128({as[31:4],4{0}})
19 if upd4 == 2: // radix2 last stage
20     {
21         temp[31:0],
22         qx[ 63: 48] >> sar4,
23         qx[ 47: 32] >> sar4,
24         qv[ 95: 64],
25         qx[ 31: 16] >> sar4,
26         qx[ 15:  0] >> sar4
27     } => store128({as[31:4],4{0}})
28
29     as[31:0] = as[31:0] + ad[31:0]

```

1.8.13 EE.FFT.R2BF.S16

Instruction Word

11	qa0[2:1]	1100	qa0[0]	qa1[2:0]	qy[2:1]	0	sel2[0]	qx[2:1]	qy[0]	qx[0]	0100
----	----------	------	--------	----------	---------	---	---------	---------	-------	-------	------

Assembler Syntax

EE.FFT.R2BF.S16 qa0, qa1, qx, qy, sel2

Description

This instruction performs the radix-2 butterfly operation on the 16-byte values in registers `qx` and `qy`, and the data bit width is 16 bits. Some of the calculation results are written to register `qa0`, and others are written to register `qa1`.

Operation

```

1  if sel2==0:
2      op_a[127: 0] = {qy[ 63:  0], qx[ 63:  0]}
3      op_b[127: 0] = {qy[127: 64], qx[127: 64]}
4  if sel2==1:
5      op_a[127: 0] = {qy[ 95: 64], qy[ 31:  0], qx[ 95: 64], qx[ 31:  0]}
6      op_b[127: 0] = {qy[127: 96], qy[ 63: 32], qx[127: 96], qx[ 63: 32]}
7
8      qa0[ 15:  0] = op_a[ 15:  0] + op_b[ 15:  0]
9      qa0[ 31: 16] = op_a[ 31: 16] + op_b[ 31: 16]
10     qa0[ 47: 32] = op_a[ 47: 32] + op_b[ 47: 32]
11     qa0[ 63: 48] = op_a[ 63: 48] + op_b[ 63: 48]
12     qa0[ 79: 64] = op_a[ 15:  0] - op_b[ 15:  0]
13     qa0[ 95: 80] = op_a[ 31: 16] - op_b[ 31: 16]
14     qa0[111: 96] = op_a[ 47: 32] - op_b[ 47: 32]
15     qa0[127:112] = op_a[ 63: 48] - op_b[ 63: 48]
16
17     qa1[ 15:  0] = op_a[ 79: 64] + op_b[ 79: 64]
18     qa1[ 31: 16] = op_a[ 95: 80] + op_b[ 95: 80]
19     qa1[ 47: 32] = op_a[111: 96] + op_b[111: 96]
20     qa1[ 63: 48] = op_a[127:112] + op_b[127:112]
21     qa1[ 79: 64] = op_a[ 79: 64] - op_b[ 79: 64]
22     qa1[ 95: 80] = op_a[ 95: 80] - op_b[ 95: 80]
23     qa1[111: 96] = op_a[111: 96] - op_b[111: 96]
24     qa1[127:112] = op_a[127:112] - op_b[127:112]

```

1.8.14 EE.FFT.R2BF.S16.ST.INCP

Instruction Word

11101000	sar4[0]	qy[2:0]	1	qa0[2:0]	qx[1:0]	0	sar4[1]	0100	as[3:0]	111	qx[2]
----------	---------	---------	---	----------	---------	---	---------	------	---------	-----	-------

Assembler Syntax

EE.FFT.R2BF.S16.ST.INCP qa0, qx, qy, as, 0..3

Description

This instruction performs the radix-2 butterfly operation on the 16-byte values in registers `qx` and `qy`, and the data bit width is 16 bits. Some of the calculation results are written to register `qa0`, and others implement an arithmetic shift and are written into the memory address indicated by `as`. After the access is completed, the value in register `as` is incremented by 16.

Operation

```

1  qa0[ 15: 0] = qx[ 15: 0] - qy[ 15: 0]
2  qa0[ 31: 16] = qx[ 31: 16] - qy[ 31: 16]
3  qa0[ 47: 32] = qx[ 47: 32] - qy[ 47: 32]
4  qa0[ 63: 48] = qx[ 63: 48] - qy[ 63: 48]
5  qa0[ 79: 64] = qx[ 79: 64] - qy[ 79: 64]
6  qa0[ 95: 80] = qx[ 95: 80] - qy[ 95: 80]
7  qa0[111: 96] = qx[111: 96] - qy[111: 96]
8  qa0[127:112] = qx[127:112] - qy[127:112]
9
10 {
11   (qx[127:112] + qy[127:112]) >> sar4,
12   (qx[111: 96] + qy[111: 96]) >> sar4,
13   (qx[ 95: 80] + qy[ 95: 80]) >> sar4,
14   (qx[ 79: 64] + qy[ 79: 64]) >> sar4,
15   (qx[ 63: 48] + qy[ 63: 48]) >> sar4,
16   (qx[ 47: 32] + qy[ 47: 32]) >> sar4,
17   (qx[ 31: 16] + qy[ 31: 16]) >> sar4,
18   (qx[ 15: 0] + qy[ 15: 0]) >> sar4
19 } => store128({as[31:4],4{0}})
20 as[31:0] = as[31:0] + 16

```

1.8.15 EE.FFT.VST.R32.DECP

Instruction Word

11	qv[2:1]	1101	qv[0]	0110	sar2[0]	11	as[3:0]	0100
----	---------	------	-------	------	---------	----	---------	------

Assembler Syntax

EE.FFT.VST.R32.DECP qv, as, sar2

Description

It is a dedicated FFT instruction. This instruction divides data in register qv into 8 segments of 16-bit data and performs an arithmetic right shift on them by 0 or 1 depending on the immediate number sar2, and finally writes the result to the memory address indicated by register as in word big-endian order. After the access is completed, the value in register as is decreased by 16.

Operation

```

1  {
2    qv[ 31: 16] >> sar2,
3    qv[ 15:  0] >> sar2,
4    qv[ 63: 48] >> sar2,
5    qv[ 47: 32] >> sar2,
6    qv[ 95: 80] >> sar2,
7    qv[ 79: 64] >> sar2,
8    qv[127:112] >> sar2,
9    qv[111: 96] >> sar2
10 } => store128({as[31:4],4{0}})
11 as[31:0] = as[31:0] - 16

```

1.8.16 EE.GET_GPIO_IN

Instruction Word

0110010100001000	au[3:0]	0100
------------------	---------	------

Assembler Syntax

EE.GET_GPIO_IN au

Description

It is a dedicated CPU GPIO instruction to assign the content of GPIO_IN to the lower 8 bits of register au.

Operation

```
1 au = {24'h0, GPIO_IN[7:0]}
```

1.8.17 EE.LD.128.USAR.IP

Instruction Word

1	imm16[7]	qu[2:1]	0001	qu[0]	imm16[6:0]	as[3:0]	0100
---	----------	---------	------	-------	------------	---------	------

Assembler Syntax

EE.LD.128.USAR.IP qu, as, -2048..2032

Description

This instruction forces the lower 4 bits of the access address in register as to 0 and loads 16-byte data from memory to register qu. Meanwhile, it saves the value of the lower 4 bits in as to the special register SAR_BYTE. After the access is completed, the value in register as is incremented by 8-bit sign-extended constant in the instruction code segment left-shifted by 4.

Operation

```

1  qu[127:0] = load128({as[31:4], 4{0}})
2  SAR_BYTE = as[3:0]
3  as[31:0] = as[31:0] + {20{imm16[7]}, imm16[7:0], 4{0}}
```

1.8.18 EE.LD.128.USAR.XP

Instruction Word

10	qu[2:1]	1101	qu[0]	000	ad[3:0]	as[3:0]	0100
----	---------	------	-------	-----	---------	---------	------

Assembler Syntax

EE.LD.128.USAR.XP qu, as, ad

Description

This instruction forces the lower 4 bits of the access address in register as to 0 and loads 16-byte data from memory to register qu. Meanwhile, it saves the value of the lower 4 bits in as to the special register SAR_BYTE. After the access is completed, the value in register as is incremented by the value in register ad.

Operation

```

1  qu[127:0] = load128({as[31:4],4{0}})
2  SAR_BYTE = as[3:0]
3  as[31:0] = as[31:0] + ad[31:0]

```

1.8.19 EE.LD.ACCX.IP

Instruction Word

0	imm8[7]	0011100	imm8[6:0]	as[3:0]	0100
---	---------	---------	-----------	---------	------

Assembler Syntax

EE.LD.ACCX.IP as, -1024..1016

Description

This instruction forces the lower 3 bits of the access address in register as to 0, loads 64-bit data from memory, and save its lower 40 bits to the special register ACCX. After the access is completed, the value in register as is incremented by 8-bit sign-extended constant in the instruction code segment left-shifted by 3.

Operation

- 1 ACCX[39:0] = load64({as[31:3], 3{0}})
- 2 as[31:0] = as[31:0] + {21{imm8[7]}, imm8[7:0], 3{0}}

1.8.20 EE.LD.QACC_H.H.32.IP

Instruction Word

0	imm4[7]	0111100	imm4[6:0]	as[3:0]	0100
---	---------	---------	-----------	---------	------

Assembler Syntax

EE.LD.QACC_H.H.32.IP as, -512..508

Description

This instruction forces the lower 2 bits of the access address in register as to 0 and loads 32-bit data from memory to the special register QACC_H[159:128]. After the access is completed, the value in register as is incremented by 8-bit sign-extended constant in the instruction code segment left-shifted by 2.

Operation

- 1 QACC_H[159:128] = load32({as[31:2], 2{0}})
- 2 as[31:0] = as[31:0] + {22{imm4[7]}, imm4[7:0], 2{0}}

1.8.21 EE.LD.QACC_H.L.128.IP

Instruction Word

0	imm16[7]	0001100	imm16[6:0]	as[3:0]	0100
---	----------	---------	------------	---------	------

Assembler Syntax

EE.LD.QACC_H.L.128.IP as, -2048..2032

Description

This instruction forces the lower 4 bits of the access address in register `as` to 0 and loads 16-byte data from memory to the special register `QACC_H[127:0]`. After the access is completed, the value in register `as` is incremented by 8-bit sign-extended constant in the instruction code segment left-shifted by 4.

Operation

- 1 `QACC_H[127: 0] = load128({as[31:4],4{0}})`
- 2 `as[31:0] = as[31:0] + {20{imm16[7]},imm16[7:0],4{0}}`

1.8.22 EE.LD.QACC_L.H.32.IP

Instruction Word

0	imm4[7]	0101100	imm4[6:0]	as[3:0]	0100
---	---------	---------	-----------	---------	------

Assembler Syntax

EE.LD.QACC_L.H.32.IP as, -512..508

Description

This instruction forces the lower 2 bits of the access address in register as to 0 and loads 32-bit data from memory to the special register QACC_L[159:128]. After the access is completed, the value in register as is incremented by 8-bit sign-extended constant in the instruction code segment left-shifted by 2.

Operation

- 1 QACC_L[159:128] = load32({as[31:2], 2{0}})
- 2 as[31:0] = as[31:0] + {22{imm4[7]}, imm4[7:0], 2{0}}

1.8.23 EE.LD.QACC_L.L.128.IP

Instruction Word

0	imm16[7]	0000000	imm16[6:0]	as[3:0]	0100
---	----------	---------	------------	---------	------

Assembler Syntax

EE.LD.QACC_L.L.128.IP as, -2048..2032

Description

This instruction forces the lower 4 bits of the access address in register `as` to 0 and loads 16-byte data from memory to the special register `QACC_L[127:0]`. After the access is completed, the value in register `as` is incremented by 8-bit sign-extended constant in the instruction code segment left-shifted by 4.

Operation

- 1 `QACC_L[127:0] = load128({as[31:4], 4{0}})`
- 2 `as[31:0] = as[31:0] + {20{imm16[7]}, imm16[7:0], 4{0}}`

1.8.24 EE.LD.UA_STATE.IP

Instruction Word

0	imm16[7]	0100000	imm16[6:0]	as[3:0]	0100
---	----------	---------	------------	---------	------

Assembler Syntax

EE.LD.UA_STATE.IP as, -2048..2032

Description

This instruction forces the lower 4 bits of the access address in register as to 0 and loads 16-byte data from memory to the special register UA_STATE. After the access is completed, the value in register as is incremented by 8-bit sign-extended constant in the instruction code segment left-shifted by 4.

Operation

```

1  UA_STATE[127:0] = load128({as[31:4],4{0}})
2  as[31:0] = as[31:0] + {20{imm16[7]},imm16[7:0],4{0}}
```

1.8.25 EE.LDF.128.IP

Instruction Word

10000	fu3[3:1]	fu0[3:0]	fu3[0]	fu2[3:1]	fu1[3:0]	imm16f[3:0]	as[3:0]	111	fu2[0]
-------	----------	----------	--------	----------	----------	-------------	---------	-----	--------

Assembler Syntax

EE.LDF.128.IP fu3, fu2, fu1, fu0, as, -128..112

Description

This instruction forces the lower 4 bits of the access address in register `as` to 0, loads 16-byte data from memory, and stores it in order from low bit to high bit to floating-point registers `fu0`, `fu1`, `fu2`, and `fu3`. After the access is completed, the value in register `as` is incremented by 4-bit sign-extended constant in the instruction code segment left-shifted by 4.

Operation

```

1  dataIn[127:0] = load128({as[31:4],4{0}})
2  fu3 = dataIn[127: 96]
3  fu2 = dataIn[ 95: 64]
4  fu1 = dataIn[ 63: 32]
5  fu0 = dataIn[ 31:  0]
6  as[31:0] = as[31:0] + {24{imm16f[3]},imm16f[3:0],4{0}}
```

1.8.26 EE.LDF.128.XP

Instruction Word

10001	fu3[3:1]	fu0[3:0]	fu3[0]	fu2[3:1]	fu1[3:0]	ad[3:0]	as[3:0]	111	fu2[0]
-------	----------	----------	--------	----------	----------	---------	---------	-----	--------

Assembler Syntax

EE.LDF.128.XP fu3, fu2, fu1, fu0, as, ad

Description

This instruction forces the lower 4 bits of the access address in register `as` to 0, loads 16-byte data from memory, and stores it in order from low bit to high bit to floating-point registers `fu0`, `fu1`, `fu2`, and `fu3`. After the access is completed, the value in register `as` is incremented by the value in register `ad`.

Operation

```

1  dataIn[127:0] = load128({as[31:4], 4{0}})
2  fu3 = dataIn[127: 96]
3  fu2 = dataIn[ 95: 64]
4  fu1 = dataIn[ 63: 32]
5  fu0 = dataIn[ 31:  0]
6  as[31:0] = as[31:0] + ad[31:0]
```

1.8.27 EE.LDF.64.IP

Instruction Word

111000	imm8[7:6]	fu0[3:0]	imm8[5:2]	fu1[3:0]	010	imm8[0]	as[3:0]	111	imm8[1]
--------	-----------	----------	-----------	----------	-----	---------	---------	-----	---------

Assembler Syntax

EE.LDF.64.IP fu1, fu0, as, -1024..1016

Description

This instruction forces the lower 3 bits of the access address in register `as` to 0, loads 64-bit data from memory, and stores it in order from low bit to high bit to floating-point registers `fu0` and `fu1`. After the access is completed, the value in register `as` is incremented by 8-bit sign-extended constant in the instruction code segment left-shifted by 3.

Operation

```

1  dataIn[63:0] = load64({as[31:3], 3{0}})
2  fu1 = dataIn[63:32]
3  fu0 = dataIn[31: 0]
4  as[31:0] = as[31:0] + {21{imm8[7]}, imm8[7:0], 3{0}}
```

1.8.28 EE.LDF.64.XP

Instruction Word

fu0[3:0]	0110	fu1[3:0]	ad[3:0]	as[3:0]	0000
----------	------	----------	---------	---------	------

Assembler Syntax

EE.LDF.64.XP fu1, fu0, as, ad

Description

This instruction forces the lower 3 bits of the access address in register `as` to 0, loads 64-bit data from memory, and stores it in order from low bit to high bit to floating-point registers `fu0` and `fu1`. After the access is completed, the value in register `as` is incremented by the value in register `ad`.

Operation

```

1  dataIn[63:0] = load64({as[31:3], 3{0}})
2  fu1 = dataIn[63:32]
3  fu0 = dataIn[31: 0]
4  as[31:0] = as[31:0] + ad[31:0]
```

1.8.29 EE.LDQA.S16.128.IP

Instruction Word

0	imm16[7]	0000010	imm16[6:0]	as[3:0]	0100
---	----------	---------	------------	---------	------

Assembler Syntax

EE.LDQA.S16.128.IP as, -2048..2032

Description

This instruction forces the lower 4 bits of the access address in register `as` to 0, loads 16-byte data from memory, divides it into 8 segments of 16 bits, sign-extends each segment to 40 bits, and then store the results to the 160-bit special registers `QACC_L` and `QACC_H` respectively. After the access is completed, the value in register `as` is incremented by 8-bit sign-extended constant in the instruction code segment left-shifted by 4.

Operation

```

1  dataIn[127:0] = load128({as[31:4],4{0}})
2  QACC_L[ 39: 0] = {24{dataIn[15]}, dataIn[ 15: 0]}
3  QACC_L[ 79: 40] = {24{dataIn[31]}, dataIn[ 31: 16]}
4  ...
5  QACC_H[ 39: 0] = {24{dataIn[79]}, dataIn[ 79: 64]}
6  QACC_H[ 79: 40] = {24{dataIn[95]}, dataIn[ 95: 80]}
7
8  as[31:0] = as[31:0] + {20{imm16[7]},imm16[7:0],4{0}}
```

1.8.30 EE.LDQA.S16.128.XP

Instruction Word

011111100100	ad[3:0]	as[3:0]	0100
--------------	---------	---------	------

Assembler Syntax

EE.LDQA.S16.128.XP as, ad

Description

This instruction forces the lower 4 bits of the access address in register `as` to 0, loads 16-byte data from memory, divides it into 8 segments of 16 bits, sign-extends each segment to 40 bits, and then store the results to the 160-bit special registers `QACC_L` and `QACC_H` respectively. After the access is completed, the value in register `as` is incremented by the value in register `ad`.

Operation

```

1  dataIn[127:0] = load128({as[31:4],4{0}})
2  QACC_L[ 39: 0] = {24{dataIn[15]}, dataIn[ 15: 0]}
3  QACC_L[ 79: 40] = {24{dataIn[31]}, dataIn[ 31: 16]}
4  ...
5  QACC_H[ 39: 0] = {24{dataIn[79]}, dataIn[ 79: 64]}
6  QACC_H[ 79: 40] = {24{dataIn[95]}, dataIn[ 95: 80]}
7  as[31:0] = as[31:0] + ad[31:0]
```

1.8.31 EE.LDQA.S8.128.IP

Instruction Word

0	imm16[7]	0100010	imm16[6:0]	as[3:0]	0100
---	----------	---------	------------	---------	------

Assembler Syntax

EE.LDQA.S8.128.IP as, -2048..2032

Description

This instruction forces the lower 4 bits of the access address in register `as` to 0, loads 16-byte data from memory, divides it into 16 segments of 8 bits, sign-extends each segment to 20 bits, and then store the results to the 160-bit special registers `QACC_L` and `QACC_H` respectively. After the access is completed, the value in register `as` is incremented by 8-bit sign-extended constant in the instruction code segment left-shifted by 4.

Operation

```

1  dataIn[127:0] = load128({as[31:4],4{0}})
2  QACC_L[19:0] = {12{dataIn[7]}, dataIn[7:0]}
3  QACC_L[39:20] = {12{dataIn[15]}, dataIn[15:8]}
4  ...
5  QACC_H[159:140] = {12{dataIn[127]}, dataIn[127:120]}
6  as[31:0] = as[31:0] + {20{imm16[7]},imm16[7:0],4{0}}
```

1.8.32 EE.LDQA.S8.128.XP

Instruction Word

011100010100	ad[3:0]	as[3:0]	0100
--------------	---------	---------	------

Assembler Syntax

EE.LDQA.S8.128.XP as, ad

Description

This instruction forces the lower 4 bits of the access address in register `as` to 0, loads 16-byte data from memory, divides it into 16 segments of 8 bits, sign-extends each segment to 20 bits, and then store the results to the 160-bit special registers `QACC_L` and `QACC_H` respectively. After the access is completed, the value in register `as` is incremented by the value in register `ad`.

Operation

```

1  dataIn[127:0] = load128({as[31:4],4{0}})
2  QACC_L[19:0] = {12{dataIn[7]}, dataIn[7:0]}
3  QACC_L[39:20] = {12{dataIn[15]}, dataIn[15:8]}
4  ...
5  QACC_H[159:140] = {12{dataIn[127]}, dataIn[127:120]}
6  as[31:0] = as[31:0] + ad[31:0]
```

1.8.33 EE.LDQA.U16.128.IP

Instruction Word

0	imm16[7]	0001010	imm16[6:0]	as[3:0]	0100
---	----------	---------	------------	---------	------

Assembler Syntax

EE.LDQA.U16.128.IP as, -2048..2032

Description

This instruction forces the lower 4 bits of the access address in register `as` to 0, loads 16-byte data from memory, divides it into 8 segments of 16 bits, zero-extends each segment to 40 bits, and then store the results to the 160-bit special registers `QACC_L` and `QACC_H` respectively. After the access is completed, the value in register `as` is incremented by 8-bit sign-extended constant in the instruction code segment left-shifted by 4.

Operation

```

1  dataIn[127:0] = load128({as[31:4],4{0}})
2  QACC_L[ 39: 0] = {24{0}, dataIn[ 15: 0]}
3  QACC_L[ 79: 40] = {24{0}, dataIn[ 31: 16]}
4  QACC_L[119: 80] = {24{0}, dataIn[ 47: 32]}
5  QACC_L[159:120] = {24{0}, dataIn[ 63: 48]}
6  QACC_H[ 39: 0] = {24{0}, dataIn[ 79: 64]}
7  QACC_H[ 79: 40] = {24{0}, dataIn[ 95: 80]}
8  QACC_H[119: 80] = {24{0}, dataIn[111: 96]}
9  QACC_H[159:120] = {24{0}, dataIn[127:112]}
10 as[31:0] = as[31:0] + {20{imm16[7]},imm16[7:0],4{0}}
```

1.8.34 EE.LDQA.U16.128.XP

Instruction Word

011110100100	ad[3:0]	as[3:0]	0100
--------------	---------	---------	------

Assembler Syntax

EE.LDQA.U16.128.XP as, ad

Description

This instruction forces the lower 4 bits of the access address in register `as` to 0, loads 16-byte data from memory, divides it into 8 segments of 16 bits, zero-extends each segment to 40 bits, and then store the results to the 160-bit special registers `QACC_L` and `QACC_H` respectively. After the access is completed, the value in register `as` is incremented by the value in register `ad`.

Operation

```

1  dataIn[127:0] = load128({as[31:4],4{0}})
2  QACC_L[ 39: 0] = {24{0}, dataIn[ 15: 0]}
3  ...
4  QACC_H[159:120] = {24{0}, dataIn[127:112]}
5  as[31:0] = as[31:0] + ad[31:0]
```

1.8.35 EE.LDQA.U8.128.IP

Instruction Word

0	imm16[7]	0101010	imm16[6:0]	as[3:0]	0100
---	----------	---------	------------	---------	------

Assembler Syntax

EE.LDQA.U8.128.IP as, -2048..2032

Description

This instruction forces the lower 4 bits of the access address in register `as` to 0, loads 16-byte data from memory, divides it into 16 segments of 8 bits, zero-extends each segment to 20 bits, and then store the results to the 160-bit special registers `QACC_L` and `QACC_H` respectively. After the access is completed, the value in register `as` is incremented by 8-bit sign-extended constant in the instruction code segment left-shifted by 4.

Operation

```

1  dataIn[127:0] = load128({as[31:4],4{0}})
2  QACC_L[ 19: 0] = {12{0}, dataIn[ 7: 0]}
3  QACC_L[ 39: 20] = {12{0}, dataIn[ 15: 8]}
4  QACC_L[ 59: 40] = {12{0}, dataIn[ 23: 16]}
5  ...
6  QACC_L[159:140] = {12{0}, dataIn[ 63: 56]}
7  QACC_H[ 19: 0] = {12{0}, dataIn[ 71: 64]}
8  QACC_H[ 39: 20] = {12{0}, dataIn[ 79: 72]}
9  QACC_H[ 59: 40] = {12{0}, dataIn[ 87: 80]}
10 ...
11 QACC_H[159:140] = {12{0}, dataIn[127:120]}
12 as[31:0] = as[31:0] + {20{imm16[7]},imm16[7:0],4{0}}
```

1.8.36 EE.LDQA.U8.128.XP

Instruction Word

011100000100	ad[3:0]	as[3:0]	0100
--------------	---------	---------	------

Assembler Syntax

EE.LDQA.U8.128.XP as, ad

Description

This instruction forces the lower 4 bits of the access address in register `as` to 0, loads 16-byte data from memory, divides it into 16 segments of 8 bits, zero-extends each segment to 20 bits, and then store the results to the 160-bit special registers `QACC_L` and `QACC_H` respectively. After the access is completed, the value in register `as` is incremented by the value in register `ad`.

Operation

```

1  dataIn[127:0] = load128({as[31:4],4{0}})
2  QACC_L[ 19: 0] = {12{0}, dataIn[ 7: 0]}
3  ...
4  QACC_L[159:140] = {12{0}, dataIn[ 63: 56]}
5  QACC_H[ 19: 0] = {12{0}, dataIn[ 71: 64]}
6  ...
7  QACC_H[159:140] = {12{0}, dataIn[127:120]}
8  as[31:0] = as[31:0] + ad[31:0]
```

1.8.37 EE.LDXQ.32

Instruction Word

1110000	sel4[1]	sel8[0]	111	sel4[0]	qu[2:0]	qs[1:0]	sel8[2:1]	1101	as[3:0]	111	qs[2]
---------	---------	---------	-----	---------	---------	---------	-----------	------	---------	-----	-------

Assembler Syntax

EE.LDXQ.32 qu, qs, as, 0..3, 0..7

Description

This instruction selects one of the 8 segments of 16-bit data in `qs` as the addend according to the immediate number `sel8`. It adds the addend left-shifted by 2 bits to the value of the address register `as`, uses the result as the access address, aligns it to 32 bits (its lower 2 bits are set to 0), and stores loaded data to a 32-bit data segment in register `qu` according to the value of the immediate number `sel4`.

Operation

```

1  vaddr0[31:0] = as[31:0] + qs[ 15: 0] * 4
2  vaddr1[31:0] = as[31:0] + qs[ 31: 16] * 4
3  vaddr2[31:0] = as[31:0] + qs[ 47: 32] * 4
4  vaddr3[31:0] = as[31:0] + qs[ 63: 47] * 4
5  vaddr4[31:0] = as[31:0] + qs[ 79: 64] * 4
6  vaddr5[31:0] = as[31:0] + qs[ 95: 80] * 4
7  vaddr6[31:0] = as[31:0] + qs[111: 96] * 4
8  vaddr7[31:0] = as[31:0] + qs[127:112] * 4
9
10 if sel8 == 0:
11   dataIn[31:0] = load32({vaddr0[31:2], 2{0}})
12 if sel8 == 1:
13   dataIn[31:0] = load32({vaddr1[31:2], 2{0}})
14 if sel8 == 2:
15   dataIn[31:0] = load32({vaddr2[31:2], 2{0}})
16 if sel8 == 3:
17   dataIn[31:0] = load32({vaddr3[31:2], 2{0}})
18 if sel8 == 4:
19   dataIn[31:0] = load32({vaddr4[31:2], 2{0}})
20 if sel8 == 5:
21   dataIn[31:0] = load32({vaddr5[31:2], 2{0}})
22 if sel8 == 6:
23   dataIn[31:0] = load32({vaddr6[31:2], 2{0}})
24 if sel8 == 7:
25   dataIn[31:0] = load32({vaddr7[31:2], 2{0}})
26
27 qu[32*sel4+31:32*sel4] = dataIn[31:0]

```

1.8.38 EE.MOV.S16.QACC

Instruction Word

11	qs[2:1]	1101	qs[0]	111111100100100
----	---------	------	-------	-----------------

Assembler Syntax

EE.MOV.S16.QACC qs

Description

This instruction sign-extends the 8 segments of 16-bit data in register qs to 40 bits and writes the result to the special registers QACC_H and QACC_L.

Operation

```

1  QACC_L[ 39: 0] = {24{qs[15]}, qs[ 15: 0]}
2  QACC_L[ 79: 40] = {24{qs[31]}, qs[ 31: 16]}
3  QACC_L[119: 80] = {24{qs[47]}, qs[ 47: 32]}
4  QACC_L[159:120] = {24{qs[63]}, qs[ 63: 48]}
5  QACC_H[ 39: 0] = {24{qs[79]}, qs[ 79: 64]}
6  QACC_H[ 79: 40] = {24{qs[95]}, qs[ 95: 80]}
7  QACC_H[119: 80] = {24{qs[79]}, qs[111: 96]}
8  QACC_H[159:120] = {24{qs[95]}, qs[127:112]}

```

1.8.39 EE.MOV.S8.QACC

Instruction Word

11	qs[2:1]	1101	qs[0]	111111100110100
----	---------	------	-------	-----------------

Assembler Syntax

EE.MOV.S8.QACC qs

Description

This instruction sign-extends the 16 segments of 8-bit data in the register qs to 20 bits and writes the result to special registers QACC_H and QACC_L.

Operation

```

1  QACC_L[ 19: 0] = {12{qs[7]}, qs[ 7: 0]}
2  QACC_L[ 39: 20] = {12{qs[15]}, qs[ 15: 8]}
3  ...
4  QACC_H[159:140] = {12{qs[127]}, qs[127:120]}

```

1.8.40 EE.MOV.U16.QACC

Instruction Word

11	qs[2:1]	1101	qs[0]	111111101100100
----	---------	------	-------	-----------------

Assembler Syntax

EE.MOV.U16.QACC qs

Description

This instruction zero-extends the 8 segments of 16-bit data in register qs to 40 bits and writes the result to special registers QACC_H and QACC_L.

Operation

```

1  QACC_L[ 39: 0] = {24{0}, qs[ 15: 0]}
2  QACC_L[ 79: 40] = {24{0}, qs[ 31: 16]}
3  QACC_L[119: 80] = {24{0}, qs[ 47: 32]}
4  QACC_L[159:120] = {24{0}, qs[ 63: 48]}
5  QACC_H[ 39: 0] = {24{0}, qs[ 79: 64]}
6  QACC_H[ 79: 40] = {24{0}, qs[ 95: 80]}
7  QACC_H[119: 80] = {24{0}, qs[111: 96]}
8  QACC_H[159:120] = {24{0}, qs[127:112]}

```

1.8.41 EE.MOV.U8.QACC

Instruction Word

11	qs[2:1]	1101	qs[0]	111111101110100
----	---------	------	-------	-----------------

Assembler Syntax

EE.MOV.U8.QACC qs

Description

This instruction zero-extends the 16 segments of 8-bit data in register qs to 20 bits and writes the result to special registers QACC_H and QACC_L.

Operation

```

1  QACC_L[ 19: 0] = {12{0}, qs[ 7: 0]}
2  QACC_L[ 39: 20] = {12{0}, qs[ 15: 8]}
3  QACC_L[ 59: 40] = {12{0}, qs[ 23: 16]}
4  ...
5  QACC_L[159:140] = {12{0}, qs[ 63: 56]}
6  QACC_H[ 19: 0] = {12{0}, qs[ 71: 64]}
7  QACC_H[ 39: 20] = {12{0}, qs[ 79: 72]}
8  QACC_H[ 59: 40] = {12{0}, qs[ 87: 80]}
9  ...
10 QACC_H[159:140] = {12{0}, qs[127:120]}

```

1.8.42 EE.MOVI.32.A

Instruction Word

11	qs[2:1]	1101	qs[0]	111	sel4[1:0]	01	au[3:0]	0100
----	---------	------	-------	-----	-----------	----	---------	------

Assembler Syntax

EE.MOVI.32.A qs, au, 0..3

Description

This instruction selects one data segment of 32 bits from register `qs` according to immediate number `sel4` and assigns it to register `au`.

Operation

```
1 if sel4 == 0:
2   au = qs[ 31: 0]
3 if sel4 == 1:
4   au = qs[ 63: 32]
5 if sel4 == 2:
6   au = qs[ 95: 64]
7 if sel4 == 3:
8   au = qs[127: 96]
```

1.8.43 EE.MOVI.32.Q

Instruction Word

11	qu[2:1]	1101	qu[0]	011	sel4[1:0]	10	as[3:0]	0100
----	---------	------	-------	-----	-----------	----	---------	------

Assembler Syntax

EE.MOVI.32.Q qu, as, 0..3

Description

This instruction assigns the value in register as to one data segment of 32 bits in register qu according to immediate number sel4.

Operation

```

1  if sel4 == 0:
2     qu[ 31: 0] = as
3  if sel4 == 1:
4     qu[ 63: 32] = as
5  if sel4 == 2:
6     qu[ 95: 64] = as
7  if sel4 == 3:
8     qu[127: 96] = as

```

1.8.44 EE.NOTQ

Instruction Word

11	qa[2:1]	1101	qa[0]	11111111	qx[2:1]	0	qx[0]	0100
----	---------	------	-------	----------	---------	---	-------	------

Assembler Syntax

EE.NOTQ qa, qx

Description

This instruction performs a bitwise NOT operation on register qx and writes the result to register qa.

Operation

1 $qa = \sim qx$

1.8.45 EE.ORQ

Instruction Word

11	qa[2:1]	1101	qa[0]	111	qy[2:1]	00	qx[2:1]	qy[0]	qx[0]	0100
----	---------	------	-------	-----	---------	----	---------	-------	-------	------

Assembler Syntax

EE.ORQ qa, qx, qy

Description

This instruction performs a bitwise NOT operation on registers qx and qy and writes the result of the logical operation to register qa.

Operation

```
1  qa = qx | qy
```

1.8.46 EE.SET_BIT_GPIO_OUT

Instruction Word

011101010100	imm256[7:0]	0100
--------------	-------------	------

Assembler Syntax

EE.SET_BIT_GPIO_OUT 0..255

Description

It is a dedicated CPU GPIO instruction to set certain bits of GPIO_OUT. The assignment content depends on the 8-bit immediate number `imm256`.

Operation

```
1 GPIO_OUT[7:0] = (GPIO_OUT[7:0] | imm256[7:0])
```

1.8.47 EE.SLCI.2Q

Instruction Word

11	qs1[2:1]	1100	qs1[0]	qs0[2:0]	0110	sar16[3:0]	0100
----	----------	------	--------	----------	------	------------	------

Assembler Syntax

EE.SLCI.2Q qs1, qs0, 0..15

Description

This instruction performs a left shift on the 32-byte concatenation of registers `qs0` and `qs1` and pads the lower bits with 0. The upper 128 bits of the shift result is written to register `qs1` and the lower 128 bits is written to `qs0`. The left shift amount is 8 times the sum of `sar16` and 1.

Operation

$$\{qs1[127: 0], qs0[127: 0]\} = \{qs1[127: 0], qs0[127: 0]\} \ll ((sar16[3:0]+1)*8)$$

1.8.48 EE.SLCXXP.2Q

Instruction Word

10	qs1[2:1]	0110	qs1[0]	qs0[2:0]	ad[3:0]	as[3:0]	0100
----	----------	------	--------	----------	---------	---------	------

Assembler Syntax

EE.SLCXXP.2Q qs1, qs0, as, ad

Description

This instruction performs a left shift on the 32-byte concatenation of registers `qs0` and `qs1` and pads the lower bits with 0. The upper 128 bits of the shift result is written to register `qs1` and the lower 128 bits is written to `qs0`. The left shift amount is 8 multiplied by the sum of 1 plus the lower 4-bit value of register `as`. After the above operations, the value in `as` is incremented by the value in `ad`.

Operation

- 1 $\{qs1[127:0], qs0[127:0]\} = \{qs1[127:0], qs0[127:0]\} \ll ((as[3:0]+1)*8)$
- 2 $as[31:0] = as[31:0] + ad[31:0]$

1.8.49 EE.SRC.Q

Instruction Word

11	qs1[2:1]	1100	qs1[0]	qs0[2:0]	00110	qa[2:0]	0100
----	----------	------	--------	----------	-------	---------	------

Assembler Syntax

EE.SRC.Q qa, qs0, qs1

Description

This instruction performs an arithmetic right shift on the 32-byte concatenation of registers `qs0` and `qs1` that hold the loaded data of two consecutive aligned addresses. By this way, you can obtain unaligned 16-byte data, which will be written to register `qa`. The right shift amount is `SAR_BYTE` multiplied by 8.

Operation

```
1  qa[127: 0] = {qs1[127: 0], qs0[127: 0]} >> {SAR_BYTE[3:0] << 3}
```

1.8.50 EE.SRC.Q.LD.IP

Instruction Word

111000	imm16[7:6]	imm16[2]	qs1[2:0]	imm16[5]	qu[2:0]	qs0[1:0]	imm16[4:3]	00	imm16[1:0]	as[3:0]	111	qs0[2]
--------	------------	----------	----------	----------	---------	----------	------------	----	------------	---------	-----	--------

Assembler Syntax

EE.SRC.Q.LD.IP qu, as, -2048..2032, qs0, qs1

Description

This instruction performs an arithmetic right shift on the 32-byte concatenation of registers `qs0` and `qs1` that hold the loaded data of two consecutive aligned addresses. By this way, you can obtain unaligned 16-byte data, which will be written to register `qs0`. The right shift amount is `SAR_BYTE` multiplied by 8.

At the same time, the lower 4 bits of the access address in register `as` are forced to be 0, and then the 16-byte data is loaded from the memory to register `qu`. After the access is completed, the value in register `as` is incremented by 8-bit sign-extended constant in the instruction code segment left-shifted by 4.

Operation

```

1  qs0[127:0] = {qs1[127:0], qs0[127:0]} >> {SAR_BYTE[3:0] << 3}
2  qu[127:0] = load128({as[31:4], 4{0}})
3  as[31:0] = as[31:0] + {20{imm16[7]}, imm16[7:0], 4{0}}
```

1.8.51 EE.SRC.Q.LD.XP

Instruction Word

111010000	qs1[2:0]	0	qu[2:0]	qs0[1:0]	00	ad[3:0]	as[3:0]	111	qs0[2]
-----------	----------	---	---------	----------	----	---------	---------	-----	--------

Assembler Syntax

EE.SRC.Q.LD.XP qu, as, ad, qs0, qs1

Description

This instruction performs an arithmetic right shift on the 32-byte concatenation of registers `qs0` and `qs1` that hold the loaded data of two consecutive aligned addresses. By this way, you can obtain unaligned 16-byte data, which will be written to register `qs0`. The right shift amount is `SAR_BYTE` multiplied by 8.

At the same time, the lower 4 bits of the access address in register `as` are forced to be 0, and then the 16-byte data is loaded from the memory to register `qu`. After the access is completed, the value in register `as` is incremented by the value in register `ad`.

Operation

```

1  qs0[127:0] = {qs1[127:0], qs0[127:0]} >> {SAR_BYTE[3:0] << 3}
2  qu[127:0] = load128({as[31:4], 4{0}})
3  as[31:0] = as[31:0] + ad[31:0]

```

1.8.52 EE.SRC.Q.QUP

Instruction Word

11	qs1[2:1]	1100	qs1[0]	qs0[2:0]	01110	qa[2:0]	0100
----	----------	------	--------	----------	-------	---------	------

Assembler Syntax

EE.SRC.Q.QUP qa, qs0, qs1

Description

This instruction performs an arithmetic right shift on the 32-byte concatenation of registers `qs0` and `qs1` that hold the loaded data of two consecutive aligned addresses. In this way, you can obtain unaligned 16-byte data, which will be written to register `qa`. The right shift amount is `SAR_BYTE` multiplied by 8. At the same time, the value of register `qs1` is updated to `qs0`.

Operation

```

1  qa[127: 0] = {qs1[127: 0], qs0[127: 0]} >> {SAR_BYTE[3:0] << 3}
2  qs0 = qs1

```

1.8.53 EE.SRCI.2Q

Instruction Word

11	qs1[2:1]	1100	qs1[0]	qs0[2:0]	1010	sar16[3:0]	0100
----	----------	------	--------	----------	------	------------	------

Assembler Syntax

EE.SRCI.2Q qs1, qs0, sar16

Description

This instruction performs a logical right shift on the 32-byte concatenation of registers `qs0` and `qs1` and pads the higher bits with 0. The upper 128 bits of the shift result is written to register `qs1` and the lower 128 bits is written to `qs0`. The right shift amount is 8 times the sum of `sar16` and 1.

Operation

```

1  {qs1[127: 0], qs0[127: 0]} = {qs1[127: 0], qs0[127: 0]} >> ((sar16+1)*8)
2  qs1[127:127-8*sar16] = 0

```

1.8.54 EE.SRCMB.S16.QACC

Instruction Word

11	qu[2:1]	1101	qu[0]	1110	010	as[3:0]	0100
----	---------	------	-------	------	-----	---------	------

Assembler Syntax

EE.SRCMB.S16.QACC qu, as, 0

Description

This instruction extracts 8 data segments of 40 bits from special registers QACC_H and QACC_L and perform arithmetic right shift operations respectively. While writing the shift result back to QACC_H and QACC_L, the instruction saturates the result to 16-bit signed numbers and writes the 8 16-bit data obtained after saturation into register qu.

Operation

```

1  temp0[39:0] = QACC_L[ 39: 0]
2  ...
3  temp3[39:0] = QACC_L[159:120]
4  temp4[39:0] = QACC_H[ 39: 0]
5  ...
6  temp7[39:0] = QACC_H[159:120]
7
8  temp_shf0[39:0] = temp0[39:0] >> as[5:0]
9  temp_shf1[39:0] = temp1[39:0] >> as[5:0]
10 ...
11 temp_shf7[39:0] = temp7[39:0] >> as[5:0]
12
13 QACC_L[ 39: 0] = temp_shf0[39:0]
14 ...
15 QACC_L[159:120] = temp_shf3[39:0]
16 QACC_H[ 39: 0] = temp_shf4[39:0]
17 ...
18 QACC_H[159:120] = temp_shf7[39:0]
19
20 qu[ 15: 0] = min(max(temp_shf0[39:0], -2^{15}), 2^{15}-1)
21 ...
22 qu[ 63: 48] = min(max(temp_shf3[39:0], -2^{15}), 2^{15}-1)
23 qu[ 79: 64] = min(max(temp_shf4[39:0], -2^{15}), 2^{15}-1)
24 ...
25 qu[127:112] = min(max(temp_shf7[39:0], -2^{15}), 2^{15}-1)

```

1.8.55 EE.SRCMB.S8.QACC

Instruction Word

11	qu[2:1]	1101	qu[0]	1111	010	as[3:0]	0100
----	---------	------	-------	------	-----	---------	------

Assembler Syntax

EE.SRCMB.S8.QACC qu, as, 0

Description

This instruction extracts 16 data segments of 20 bits from special registers QACC_H and QACC_L and perform arithmetic right shift operations respectively. While writing the shift result back to QACC_H and QACC_L, the instruction saturates the result to 8-bit signed numbers and writes the 16 8-bit data obtained after saturation into register qu.

Operation

```

1  temp0[19:0] = QACC_L[ 19: 0]
2  temp1[19:0] = QACC_L[ 39: 20]
3  ...
4  temp7[19:0] = QACC_L[159:140]
5  temp8[19:0] = QACC_H[ 19: 0]
6  temp9[19:0] = QACC_H[ 39: 20]
7  ...
8  temp15[19:0] = QACC_H[159:140]
9
10 temp_shf0[19:0] = temp0[19:0] >> as[4:0]
11 temp_shf1[19:0] = temp1[19:0] >> as[4:0]
12 ...
13 temp_shf15[19:0] = temp15[19:0] >> as[4:0]
14
15 QACC_L[ 19: 0] = temp_shf0[19:0]
16 ...
17 QACC_L[159:140] = temp_shf7[19:0]
18 QACC_H[ 19: 0] = temp_shf8[19:0]
19 ...
20 QACC_H[159:140] = temp_shf15[19:0]
21
22 qu[ 7: 0] = min(max(temp_shf0[19:0], -2^{7}), 2^{7}-1)
23 qu[ 15: 8] = min(max(temp_shf1[19:0], -2^{7}), 2^{7}-1)
24 ...
25 qu[ 63: 56] = min(max(temp_shf7[19:0], -2^{7}), 2^{7}-1)
26 qu[ 71: 64] = min(max(temp_shf8[19:0], -2^{7}), 2^{7}-1)
27 qu[ 79: 72] = min(max(temp_shf9[19:0], -2^{7}), 2^{7}-1)
28 ...
29 qu[127:120] = min(max(temp_shf15[19:0], -2^{7}), 2^{7}-1)

```

1.8.56 EE.SRCQ.128.ST.INCP

Instruction Word

11	qs1[2:1]	1100	qs1[0]	qs0[2:0]	1110	as[3:0]	0100
----	----------	------	--------	----------	------	---------	------

Assembler Syntax

EE.SRCQ.128.ST.INCP qs0, qs1, as

Description

This instruction performs an arithmetic right shift on the 32-byte concatenation of registers `qs0` and `qs1`. Then, it writes the lower 128 bits of the shift result to memory. After the access, the value in register `as` is incremented by 16.

Operation

```

1  {qs1[127: 0], qs0[127: 0]} >> {SAR_BYTE[3:0] << 3} => store128({as[31:4],4{0}})
2  as[31:0] = as[31:0] + 16

```

1.8.57 EE.SRCXXP.2Q

Instruction Word

11	qs1[2:1]	0110	qs1[0]	qs0[2:0]	ad[3:0]	as[3:0]	0100
----	----------	------	--------	----------	---------	---------	------

Assembler Syntax

EE.SRCXXP.2Q qs1, qs0, as, ad

Description

This instruction performs a logical right shift on the 32-byte concatenation of registers `qs0` and `qs1` and pads the higher bits with 0. The upper 128 bits of the shift result is written to register `qs1` and the lower 128 bits is written to `qs0`. The right shift amount is 8 multiplied by the sum of 1 plus the lower 4-bit value of register `as`. After the above operations, the value in `as` is incremented by the value in `ad`.

Operation

- 1 $\{qs1[127:0], qs0[127:0]\} = \{qs1[127:0], qs0[127:0]\} \gg ((as[3:0]+1)*8)$
- 2 $qs1[127:127-8*as[3:0]] = 0$
- 3 $as[31:0] = as[31:0] + ad[31:0]$

1.8.58 EE.SRS.ACCX

Instruction Word

011111100	001	au[3:0]	as[3:0]	0100
-----------	-----	---------	---------	------

Assembler Syntax

EE.SRS.ACCX au, as, 0

Description

This instruction performs an arithmetic right shift on special register ACCX. While writing the shift result back to ACCX, the instruction saturates shift result to a 32-bit signed number and writes the saturated result into register au.

Operation

```
1 temp_shf[39:0] = ACCX[39:0] >> as[5:0]
2 ACCX = temp_shf[39:0]
3 au = min(max(temp_shf[39:0], -2{31}), 2{31}-1)
```

1.8.59 EE.ST.ACCX.IP

Instruction Word

0	imm8[7]	0000100	imm8[6:0]	as[3:0]	0100
---	---------	---------	-----------	---------	------

Assembler Syntax

EE.ST.ACCX.IP as, -512..508

Description

This instruction forces the lower 3 bits of the access address in register `as` to 0, zero-extends special register ACCX to 64 bits, and stores the result to memory. After the access is completed, the value in register `as` is incremented by 8-bit sign-extended constant in the instruction code segment left-shifted by 3.

Operation

```
1 {24{0},ACCX[39:0]} => store64({as[31:3],3{0}})
2 as += imm8
```

1.8.60 EE.ST.QACC_H.H.32.IP

Instruction Word

0	imm4[7]	0100100	imm4[6:0]	as[3:0]	0100
---	---------	---------	-----------	---------	------

Assembler Syntax

EE.ST.QACC_H.H.32.IP as, -512..508

Description

This instruction forces the lower 2 bits of the access address in register `as` to 0 and stores the upper 32 bits in special register `QACC_H` to memory. After the access is completed, the value in register `as` is incremented by 8-bit sign-extended constant in the instruction code segment left-shifted by 2.

Operation

```

1  QACC_H[159:128] => store32({as[31:2],2{0}})
2  as[31:0] = as[31:0] + {23{imm4[7]},imm4[7:0],2{0}}
```

1.8.61 EE.ST.QACC_H.L.128.IP

Instruction Word

0	imm16[7]	0011010	imm16[6:0]	as[3:0]	0100
---	----------	---------	------------	---------	------

Assembler Syntax

EE.ST.QACC_H.L.128.IP as, -2048..2032

Description

This instruction forces the lower 4 bits of the access address in register `as` to 0 and stores the lower 128 bits in special register `QACC_H` to memory. After the access is completed, the value in register `as` is incremented by 8-bit sign-extended constant in the instruction code segment left-shifted by 4.

Operation

- 1 `QACC_H[127: 0] => store128({as[31:4],4{0}})`
- 2 `as[31:0] = as[31:0] + {23{imm4[7]},imm4[7:0],2{0}}`

1.8.62 EE.ST.QACC_L.H.32.IP

Instruction Word

0	imm4[7]	0111010	imm4[6:0]	as[3:0]	0100
---	---------	---------	-----------	---------	------

Assembler Syntax

EE.ST.QACC_L.H.32.IP as, -512..508

Description

This instruction forces the lower 2 bits of the access address in register `as` to 0 and stores the upper 32 bits in special register `QACC_L` to memory. After the access is completed, the value in register `as` is incremented by 8-bit sign-extended constant in the instruction code segment left-shifted by 2.

Operation

```

1  QACC_L[159:128] => store32({as[31:2],2{0}})
2  as[31:0] = as[31:0] + {23{imm4[7]},imm4[7:0],2{0}}
```

1.8.63 EE.ST.QACC_L.L.128.IP

Instruction Word

0	imm16[7]	0011000	imm16[6:0]	as[3:0]	0100
---	----------	---------	------------	---------	------

Assembler Syntax

EE.ST.QACC_L.L.128.IP as, -2048..2032

Description

This instruction forces the lower 4 bits of the access address in register `as` to 0 and stores the lower 128 bits in special register `QACC_L` to memory. After the access is completed, the value in register `as` is incremented by 8-bit sign-extended constant in the instruction code segment left-shifted by 4.

Operation

```

1  QACC_L[127:0] => store128({as[31:4],4{0}})
2  as[31:0] = as[31:0] + {23{imm4[7]},imm4[7:0],2{0}}
```

1.8.64 EE.ST.UA_STATE.IP

Instruction Word

0	imm16[7]	0111000	imm16[6:0]	as[3:0]	0100
---	----------	---------	------------	---------	------

Assembler Syntax

EE.ST.UA_STATE.IP as, -2048..2032

Description

This instruction forces the lower 4 bits of the access address in register as to 0 and stores the 128 bits data in special register UA_STATE to memory. After the access is completed, the value in register as is incremented by 8-bit sign-extended constant in the instruction code segment left-shifted by 4.

Operation

```

1  UA_STATE[127:0] => store128({as[31:4],4{0}})
2  as[31:0] = as[31:0] + {20{imm16[7]},imm16[7:0],4{0}}
```

1.8.65 EE.STF.128.IP

Instruction Word

10010	fv3[3:1]	fv0[3:0]	fv3[0]	fv2[3:1]	fv1[3:0]	imm16f[3:0]	as[3:0]	111	fv2[0]
-------	----------	----------	--------	----------	----------	-------------	---------	-----	--------

Assembler Syntax

EE.STF.128.IP fv3, fv2, fv1, fv0, as, -128..112

Description

This instruction forces the lower 4 bits of the access address in register `as` to 0 and stores the 16-byte data concatenated from four floating-point registers `fv0`, `fv1`, `fv2`, and `fv3` in order from low bit to high bit to memory. After the access is completed, the value in register `as` is incremented by 4-bit sign-extended constant in the instruction code segment left-shifted by 4.

Operation

- 1 `{fv3, fv2, fv1, fv0} => store128({as[31:4], 4{0}})`
- 2 `as[31:0] = as[31:0] + {24{imm16f[3]}, imm16f[3:0], 4{0}}`

1.8.66 EE.STF.128.XP

Instruction Word

10011	fv3[3:1]	fv0[3:0]	fv3[0]	fv2[3:1]	fv1[3:0]	ad[3:0]	as[3:0]	111	fv2[0]
-------	----------	----------	--------	----------	----------	---------	---------	-----	--------

Assembler Syntax

EE.STF.128.XP fv3, fv2, fv1, fv0, as, ad

Description

This instruction forces the lower 4 bits of the access address in register `as` to 0 and stores the 16-byte data concatenated from four floating-point registers `fu0`, `fu1`, `fu2`, and `fu3` in order from low bit to high bit to memory. After the access is completed, the value in register `as` is incremented by the value in register `ad`.

Operation

```

1  {fv3, fv2, fv1, fv0} => store128({as[31:4], 4{0}})
2  as[31:0] = as[31:0] + ad[31:0]

```

1.8.67 EE.STF.64.IP

Instruction Word

111000	imm8[7:6]	fv0[3:0]	imm8[5:2]	fv1[3:0]	011	imm8[0]	as[3:0]	111	imm8[1]
--------	-----------	----------	-----------	----------	-----	---------	---------	-----	---------

Assembler Syntax

EE.STF.64.IP fv1, fv0, as, imm8

Description

This instruction forces the lower 3 bits of the access address in register `as` to 0 and stores the 64-bit data concatenated from two floating-point registers `fv0` and `fv1` in order from low bit to high bit to memory. After the access is completed, the value in register `as` is incremented by 8-bit sign-extended constant in the instruction code segment left-shifted by 3.

Operation

- 1 `{fv1, fv0} => store64({as[31:3], 3{0}})`
- 2 `as[31:0] = as[31:0] + {21{imm8[7]}, imm8[7:0], 3{0}}`

1.8.68 EE.STF.64.XP

Instruction Word

fv0[3:0]	0111	fv1[3:0]	ad[3:0]	as[3:0]	0000
----------	------	----------	---------	---------	------

Assembler Syntax

EE.STF.64.XP fv1, fv0, as, ad

Description

This instruction forces the lower 3 bits of the access address in register `as` to 0 and stores the 64-bit data concatenated from two floating-point registers `fv0` and `fv1` in order from low bit to high bit to memory. After the access is completed, the value in register `as` is incremented by the value in register `ad`.

Operation

- 1 `{fv1, fv0} => store64({as[31:3], 3{0}})`
- 2 `as[31:0] = as[31:0] + ad[31:0]`

1.8.69 EE.STXQ.32

Instruction Word

1110011	sel4[1]	sel8[0]	qv[2:0]	sel4[0]	000	qs[1:0]	sel8[2:1]	0000	as[3:0]	111	qs[2]
---------	---------	---------	---------	---------	-----	---------	-----------	------	---------	-----	-------

Assembler Syntax

EE.STXQ.32 qv, qs, as, sel4, sel8

Description

This instruction selects one of the four data segments of 32 bits in register `qv` according to immediate number `sel4`. Then, it selects an addend from the 8 data segments of 16 bits in register `qs` according to immediate number `sel8`, adds the addend left-shifted by 2 bits to the value of the address register `as`, aligns the sum to 32 bits (its lower 2 bits are set to 0), and uses the result as the written address.

Operation

```

1  vaddr0[31:0] = as[31:0] + qs[ 15: 0] * 4
2  vaddr1[31:0] = as[31:0] + qs[ 31: 16] * 4
3  vaddr2[31:0] = as[31:0] + qs[ 47: 32] * 4
4  vaddr3[31:0] = as[31:0] + qs[ 63: 47] * 4
5  vaddr4[31:0] = as[31:0] + qs[ 79: 64] * 4
6  vaddr5[31:0] = as[31:0] + qs[ 95: 80] * 4
7  vaddr6[31:0] = as[31:0] + qs[111: 96] * 4
8  vaddr7[31:0] = as[31:0] + qs[127:112] * 4
9
10 if sel8 == 0:
11   qv[32*sel4+31:32*sel4] =>store32({vaddr0[31:2],2{0}})
12 if sel8 == 1:
13   qv[32*sel4+31:32*sel4] =>store32({vaddr1[31:2],2{0}})
14 if sel8 == 2:
15   qv[32*sel4+31:32*sel4] =>store32({vaddr2[31:2],2{0}})
16 if sel8 == 3:
17   qv[32*sel4+31:32*sel4] =>store32({vaddr3[31:2],2{0}})
18 if sel8 == 4:
19   qv[32*sel4+31:32*sel4] =>store32({vaddr4[31:2],2{0}})
20 if sel8 == 5:
21   qv[32*sel4+31:32*sel4] =>store32({vaddr5[31:2],2{0}})
22 if sel8 == 6:
23   qv[32*sel4+31:32*sel4] =>store32({vaddr6[31:2],2{0}})
24 if sel8 == 7:
25   qv[32*sel4+31:32*sel4] =>store32({vaddr7[31:2],2{0}})

```

1.8.70 EE.VADDS.S16

Instruction Word

10	qa[2:1]	1110	qa[0]	qy[2]	0	qy[1:0]	qx[2:0]	01100100
----	---------	------	-------	-------	---	---------	---------	----------

Assembler Syntax

EE.VADDS.S16 qa, qx, qy

Description

This instruction performs a vector addition on 16-bit data in the two registers qx and qy. Then, the 8 results obtained from the calculation are saturated, and the saturated results are written to register qa.

Operation

```

1  qa[ 15: 0] = min(max(qx[ 15: 0] + qy[ 15: 0], -2{15}), 2{15}-1)
2  qa[ 31: 16] = min(max(qx[ 31: 16] + qy[ 31: 16], -2{15}), 2{15}-1)
3  ...

```

1.8.71 EE.VADDS.S16.LD.INCP

Instruction Word

111000	qu[2:1]	qy[0]	010	qu[0]	qa[2:0]	qx[1:0]	qy[2:1]	1101	as[3:0]	111	qx[2]
--------	---------	-------	-----	-------	---------	---------	---------	------	---------	-----	-------

Assembler Syntax

EE.VADDS.S16.LD.INCP qu, as, qa, qx, qy

Description

This instruction performs a vector addition on 16-bit data in the two registers qx and qy. Then, the 8 results obtained from the calculation are saturated, and the saturated results are written to register qa.

During the operation, the lower 4 bits of the access address in register as are forced to be 0, and then the 16-byte data is loaded from the memory to register qu. After the access, the value in register as is incremented by 16.

Operation

```

1  qa[ 15: 0] = min(max(qx[ 15: 0] + qy[ 15: 0], -2{15}), 2{15}-1)
2  qa[ 31: 16] = min(max(qx[ 31: 16] + qy[ 31: 16], -2{15}), 2{15}-1)
3  ...
4
5  qu[127:0] = load128({as[31:4],4{0}})
6  as[31:0] = as[31:0] + 16

```

1.8.72 EE.VADDS.S16.ST.INCP

Instruction Word

11100100	qy[0]	qv[2:0]	1	qa[2:0]	qx[1:0]	qy[2:1]	0000	as[3:0]	111	qx[2]
----------	-------	---------	---	---------	---------	---------	------	---------	-----	-------

Assembler Syntax

EE.VADDS.S16.ST.INCP qv, as, qa, qx, qy

Description

This instruction performs a vector addition on 16-bit data in the two registers qx and qy. Then, the 8 results obtained from the calculation are saturated, and the saturated results are written to register qa.

During the operation, the instruction forces the lower 4 bits of the access address in register as to 0 and stores the value in register qv to memory. After the access, the value in register as is incremented by 16.

Operation

```

1  qa[ 15: 0] = min(max(qx[ 15: 0] + qy[ 15: 0], -2^{15}), 2^{15}-1)
2  qa[ 31: 16] = min(max(qx[ 31: 16] + qy[ 31: 16], -2^{15}), 2^{15}-1)
3  ...
4
5  qv[127:0] => store128({as[31:4],4{0}})
6  as[31:0] = as[31:0] + 16

```

1.8.73 EE.VADDS.S32

Instruction Word

10	qa[2:1]	1110	qa[0]	qy[2]	0	qy[1:0]	qx[2:0]	01110100
----	---------	------	-------	-------	---	---------	---------	----------

Assembler Syntax

EE.VADDS.S32 qa, qx, qy

Description

This instruction performs a vector addition on 32-bit data in the two registers qx and qy. Then, the 4 results obtained from the calculation are saturated, and the saturated results are written to register qa.

Operation

```

1  qa[ 31: 0] = min(max(qx[ 31: 0] + qy[ 31: 0], -2^{31}), 2^{31}-1)
2  qa[ 63: 32] = min(max(qx[ 63: 32] + qy[ 63: 32], -2^{31}), 2^{31}-1)
3  ...

```

1.8.74 EE.VADDS.S32.LD.INCP

Instruction Word

111000	qu[2:1]	qy[0]	011	qu[0]	qa[2:0]	qx[1:0]	qy[2:1]	1101	as[3:0]	111	qx[2]
--------	---------	-------	-----	-------	---------	---------	---------	------	---------	-----	-------

Assembler Syntax

EE.VADDS.S32.LD.INCP qu, as, qa, qx, qy

Description

This instruction performs a vector addition on 32-bit data in the two registers qx and qy. Then, the 4 results obtained from the calculation are saturated, and the saturated results are written to register qa.

During the operation, the lower 4 bits of the access address in register as are forced to be 0, and then the 16-byte data is loaded from the memory to register qu. After the access, the value in register as is incremented by 16.

Operation

```

1  qa[ 31: 0] = min(max(qx[ 31: 0] + qy[ 31: 0], -2^{31}), 2^{31}-1)
2  qa[ 63: 32] = min(max(qx[ 63: 32] + qy[ 63: 32], -2^{31}), 2^{31}-1)
3  ...
4
5  qu[127:0] = load128({as[31:4],4{0}})
6  as[31:0] = as[31:0] + 16

```

1.8.75 EE.VADDS.S32.ST.INCP

Instruction Word

11100100	qy[0]	qv[2:0]	1	qa[2:0]	qx[1:0]	qy[2:1]	0001	as[3:0]	111	qx[2]
----------	-------	---------	---	---------	---------	---------	------	---------	-----	-------

Assembler Syntax

EE.VADDS.S32.ST.INCP qv, as, qa, qx, qy

Description

This instruction performs a vector addition on 32-bit data in the two registers qx and qy. Then, the 4 results obtained from the calculation are saturated, and the saturated results are written to register qa.

During the operation, the instruction forces the lower 4 bits of the access address in register as to 0 and stores the value in register qv to memory. After the access, the value in register as is incremented by 16.

Operation

```

1  qa[ 31: 0] = min(max(qx[ 31: 0] + qy[ 31: 0], -2^{31}), 2^{31}-1)
2  qa[ 63: 32] = min(max(qx[ 63: 32] + qy[ 63: 32], -2^{31}), 2^{31}-1)
3  ...
4
5  qv[127:0] => store128({as[31:4],4{0}})
6  as[31:0] = as[31:0] + 16

```

1.8.76 EE.VADDS.S8

Instruction Word

10	qa[2:1]	1110	qa[0]	qy[2]	0	qy[1:0]	qx[2:0]	10000100
----	---------	------	-------	-------	---	---------	---------	----------

Assembler Syntax

EE.VADDS.S8 qa, qx, qy

Description

This instruction performs a vector addition on 8-bit data in the two registers qx and qy. Then, the 16 results obtained from the calculation are saturated, and the saturated results are written to register qa.

Operation

```

1  qa[ 7: 0] = min(max(qx[ 7: 0] + qy[ 7: 0], -2{7}), 2{7}-1)
2  qa[15: 8] = min(max(qx[15: 8] + qy[15: 8], -2{7}), 2{7}-1)
3  ...
4  qa[127:120] = min(max(qx[127:120] + qy[127:120], -2{7}), 2{7}-1)

```

1.8.77 EE.VADDS.S8.LD.INCP

Instruction Word

111000	qu[2:1]	qy[0]	001	qu[0]	qa[2:0]	qx[1:0]	qy[2:1]	1100	as[3:0]	111	qx[2]
--------	---------	-------	-----	-------	---------	---------	---------	------	---------	-----	-------

Assembler Syntax

EE.VADDS.S8.LD.INCP qu, as, qa, qx, qy

Description

This instruction performs a vector addition on 8-bit data in the two registers qx and qy. Then, the 16 results obtained from the calculation are saturated, and the saturated results are written to register qa.

During the operation, the lower 4 bits of the access address in register as are forced to be 0, and then the 16-byte data is loaded from the memory to register qu. After the access, the value in register as is incremented by 16.

Operation

```

1  qa[ 7: 0] = min(max(qx[ 7: 0] + qy[ 7: 0], -2^{7}), 2^{7}-1)
2  qa[15: 8] = min(max(qx[15: 8] + qy[15: 8], -2^{7}), 2^{7}-1)
3  ...
4
5  qu[127:0] = load128({as[31:4],4{0}})
6  as[31:0] = as[31:0] + 16

```

1.8.78 EE.VADDS.S8.ST.INCP

Instruction Word

11100100	qy[0]	qv[2:0]	1	qa[2:0]	qx[1:0]	qy[2:1]	0010	as[3:0]	111	qx[2]
----------	-------	---------	---	---------	---------	---------	------	---------	-----	-------

Assembler Syntax

EE.VADDS.S8.ST.INCP qv, as, qa, qx, qy

Description

This instruction performs a vector addition on 8-bit data in the two registers qx and qy. Then, the 16 results obtained from the calculation are saturated, and the saturated results are written to register qa.

During the operation, the instruction forces the lower 4 bits of the access address in register as to 0 and stores the value in register qv to memory. After the access, the value in register as is incremented by 16.

Operation

```

1  qa[ 7: 0] = min(max(qx[ 7: 0] + qy[ 7: 0], -2{7}), 2{7}-1)
2  qa[15: 8] = min(max(qx[15: 8] + qy[15: 8], -2{7}), 2{7}-1)
3  ...
4
5  qv[127:0] => store128({as[31:4],4{0}})
6  as[31:0] = as[31:0] + 16

```

1.8.79 EE.VCMP.EQ.S16

Instruction Word

10	qa[2:1]	1110	qa[0]	qy[2]	0	qy[1:0]	qx[2:0]	10010100
----	---------	------	-------	-------	---	---------	---------	----------

Assembler Syntax

EE.VCMP.EQ.S16 qa, qx, qy

Description

This instruction compares 16-bit vector data. It compares the numerical values of the eight 16-bit data segments in registers qx and qy. If the values are equal, it writes 0xFFFF into the corresponding 16-bit data segment in register qa. Otherwise, it writes 0 to the segment.

Operation

```

1  qa[ 15: 0] = (qx[ 15: 0]==qy[ 15: 0]) ? 0xFFFF : 0
2  qa[ 31: 16] = (qx[ 31: 16]==qy[ 31: 16]) ? 0xFFFF : 0
3  ...
4  qa[127:112] = (qx[127:112]==qy[127:112]) ? 0xFFFF : 0

```

1.8.80 EE.VCMP.EQ.S32

Instruction Word

10	qa[2:1]	1110	qa[0]	qy[2]	0	qy[1:0]	qx[2:0]	10100100
----	---------	------	-------	-------	---	---------	---------	----------

Assembler Syntax

EE.VCMP.EQ.S32 qa, qx, qy

Description

This instruction compares 32-bit vector data. It compares the numerical values of the four 32-bit data segments in registers qx and qy. If the values are equal, it writes 0xFFFFFFFF into the corresponding 32-bit data segment in register qa. Otherwise, it writes 0 to the segment.

Operation

```

1  qa[ 31: 0] = (qx[ 31: 0]==qy[ 31: 0]) ? 0xFFFFFFFF : 0
2  qa[ 63: 32] = (qx[ 63: 32]==qy[ 63: 32]) ? 0xFFFFFFFF : 0
3  ...
4  qa[127: 96] = (qx[127: 96]==qy[127: 96]) ? 0xFFFFFFFF : 0

```

1.8.81 EE.VCMP.EQ.S8

Instruction Word

10	qa[2:1]	1110	qa[0]	qy[2]	0	qy[1:0]	qx[2:0]	10110100
----	---------	------	-------	-------	---	---------	---------	----------

Assembler Syntax

EE.VCMP.EQ.S8 qa, qx, qy

Description

This instruction compares 8-bit vector data. It compares the numerical values of the 16 8-bit data segments in registers qx and qy. If the values are equal, it writes 0xFF into the corresponding 8-bit data segment in register qa. Otherwise, it writes 0 to the segment.

Operation

```

1  qa[ 7: 0] = (qx[ 7: 0]==qy[ 7: 0]) ? 0xFF : 0
2  qa[15: 8] = (qx[15: 8]==qy[15: 8]) ? 0xFF : 0
3  ...
4  qa[127:120] = (qx[127:120]==qy[127:120]) ? 0xFF : 0

```

1.8.82 EE.VCMP.GT.S16

Instruction Word

10	qa[2:1]	1110	qa[0]	qy[2]	0	qy[1:0]	qx[2:0]	11000100
----	---------	------	-------	-------	---	---------	---------	----------

Assembler Syntax

EE.VCMP.GT.S16 qa, qx, qy

Description

This instruction compares 16-bit vector data. It compares the numerical values of the eight 16-bit data segments in registers qx and qy. If the former is larger than the latter, it writes 0xFFFF into the corresponding 16-bit data segment in register qa. Otherwise, it writes 0 to the segment.

Operation

```

1  qa[ 15: 0] = (qx[ 15: 0]>qy[ 15: 0]) ? 0xFFFF : 0
2  qa[ 31: 16] = (qx[ 31: 16]>qy[ 31: 16]) ? 0xFFFF : 0
3  ...
4  qa[127:112] = (qx[127:112]>qy[127:112]) ? 0xFFFF : 0

```

1.8.83 EE.VCMP.GT.S32

Instruction Word

10	qa[2:1]	1110	qa[0]	qy[2]	0	qy[1:0]	qx[2:0]	11010100
----	---------	------	-------	-------	---	---------	---------	----------

Assembler Syntax

EE.VCMP.GT.S32 qa, qx, qy

Description

This instruction compares 32-bit vector data. It compares the numerical values of the four 32-bit data segments in registers qx and qy. If the former is larger than the latter, it writes 0xFFFFFFFF into the corresponding 32-bit data segment in register qa. Otherwise, it writes 0 to the segment.

Operation

```

1  qa[ 31: 0] = (qx[ 31: 0]>qy[ 31: 0]) ? 0xFFFFFFFF : 0
2  qa[ 63: 32] = (qx[ 63: 32]>qy[ 63: 32]) ? 0xFFFFFFFF : 0
3  ...
4  qa[127: 96] = (qx[127: 96]>qy[127: 96]) ? 0xFFFFFFFF : 0

```

1.8.84 EE.VCMP.GT.S8

Instruction Word

10	qa[2:1]	1110	qa[0]	qy[2]	0	qy[1:0]	qx[2:0]	11100100
----	---------	------	-------	-------	---	---------	---------	----------

Assembler Syntax

EE.VCMP.GT.S8 qa, qx, qy

Description

This instruction compares 8-bit vector data. It compares the numerical values of the 16 8-bit data segments in registers qx and qy. If the former is larger than the latter, it writes 0xFF into the corresponding 8-bit data segment in register qa. Otherwise, it writes 0 to the segment.

Operation

```

1  qa[ 7: 0] = (qx[ 7: 0]>qy[ 7: 0]) ? 0xFF : 0
2  qa[15: 8] = (qx[15: 8]>qy[15: 8]) ? 0xFF : 0
3  ...
4  qa[127:120] = (qx[127:120]>qy[127:120]) ? 0xFF : 0

```

1.8.85 EE.VCMP.LT.S16

Instruction Word

10	qa[2:1]	1110	qa[0]	qy[2]	0	qy[1:0]	qx[2:0]	11110100
----	---------	------	-------	-------	---	---------	---------	----------

Assembler Syntax

EE.VCMP.LT.S16 qa, qx, qy

Description

This instruction compares 16-bit vector data. It compares the numerical values of the eight 16-bit data segments in registers qx and qy. If the former is smaller than the latter, it writes 0xFFFF into the corresponding 16-bit data segment in register qa. Otherwise, it writes 0 to the segment.

Operation

```

1  qa[ 15: 0] = (qx[ 15: 0]<qy[ 15: 0]) ? 0xFFFF : 0
2  qa[ 31: 16] = (qx[ 31: 16]<qy[ 31: 16]) ? 0xFFFF : 0
3  ...
4  qa[127:112] = (qx[127:112]<qy[127:112]) ? 0xFFFF : 0

```

1.8.86 EE.VCMP.LT.S32

Instruction Word

10	qa[2:1]	1110	qa[0]	qy[2]	1	qy[1:0]	qx[2:0]	00000100
----	---------	------	-------	-------	---	---------	---------	----------

Assembler Syntax

EE.VCMP.LT.S32 qa, qx, qy

Description

This instruction compares 32-bit vector data. It compares the numerical values of the four 32-bit data segments in registers qx and qy. If the former is smaller than the latter, it writes 0xFFFFFFFF into the corresponding 32-bit data segment in register qa. Otherwise, it writes 0 to the segment.

Operation

```

1  qa[ 31: 0] = (qx[ 31: 0]<qy[ 31: 0]) ? 0xFFFFFFFF : 0
2  qa[ 63: 32] = (qx[ 63: 32]<qy[ 63: 32]) ? 0xFFFFFFFF : 0
3  ...
4  qa[127: 96] = (qx[127: 96]<qy[127: 96]) ? 0xFFFFFFFF : 0

```

1.8.87 EE.VCMP.LT.S8

Instruction Word

10	qa[2:1]	1110	qa[0]	qy[2]	1	qy[1:0]	qx[2:0]	00010100
----	---------	------	-------	-------	---	---------	---------	----------

Assembler Syntax

EE.VCMP.LT.S8 qa, qx, qy

Description

This instruction compares 8-bit vector data. It compares the numerical values of the 16 8-bit data segments in registers qx and qy. If the former is smaller than the latter, it writes 0xFF into the corresponding 8-bit data segment in register qa. Otherwise, it writes 0 to the segment.

Operation

```

1  qa[ 7: 0] = (qx[ 7: 0]<qy[ 7: 0]) ? 0xFF : 0
2  qa[15: 8] = (qx[15: 8]<qy[15: 8]) ? 0xFF : 0
3  ...
4  qa[127:120] = (qx[127:120]<qy[127:120]) ? 0xFF : 0

```

1.8.88 EE.VLD.128.IP

Instruction Word

1	imm16[7]	qu[2:1]	0011	qu[0]	imm16[6:0]	as[3:0]	0100
---	----------	---------	------	-------	------------	---------	------

Assembler Syntax

EE.VLD.128.IP qu, as, -2048..2032

Description

This instruction forces the lower 4 bits of the access address in register as to 0 and loads 16-byte data from memory to register qu. After the access is completed, the value in register as is incremented by 8-bit sign-extended constant in the instruction code segment left-shifted by 4.

Operation

- 1 `qu[127:0] = load128({as[31:4],4{0}})`
- 2 `as[31:0] = as[31:0] + {20{imm16[7]},imm16[7:0],4{0}}`

1.8.89 EE.VLD.128.XP

Instruction Word

10	qu[2:1]	1101	qu[0]	010	ad[3:0]	as[3:0]	0100
----	---------	------	-------	-----	---------	---------	------

Assembler Syntax

EE.VLD.128.XP qu, as, ad

Description

This instruction forces the lower 4 bits of the access address in register as to 0 and loads 16-byte data from memory to register qu. After the access is completed, the value in register as is incremented by the value in register ad.

Operation

- 1 `qu[127:0] = load128({as[31:4],4{0}})`
- 2 `as[31:0] = as[31:0] + ad[31:0]`

1.8.90 EE.VLD.H.64.IP

Instruction Word

1	imm8[7]	qu[2:1]	1000	qu[0]	imm8[6:0]	as[3:0]	0100
---	---------	---------	------	-------	-----------	---------	------

Assembler Syntax

EE.VLD.H.64.IP qu, as, -1024..1016

Description

This instruction forces the lower 3 bits of the access address in register `as` to 0 and loads 64-bit data from memory to the upper 64-bit segment in register `qu`. After the access is completed, the value in register `as` is incremented by 8-bit sign-extended constant in the instruction code segment left-shifted by 3.

Operation

- 1 `qu[127: 64] = load64({as[31: 3], 3{0}})`
- 2 `as[31:0] = as[31:0] + {21{imm8[7]}, imm8[7:0], 3{0}}`

1.8.91 EE.VLD.H.64.XP

Instruction Word

10	qu[2:1]	1101	qu[0]	110	ad[3:0]	as[3:0]	0100
----	---------	------	-------	-----	---------	---------	------

Assembler Syntax

EE.VLD.H.64.XP qu, as, ad

Description

This instruction forces the lower 3 bits of the access address in register `as` to 0 and loads 64-bit data from memory to the upper 64-bit segment in register `qu`. After the access is completed, the value in register `as` is incremented by the value in register `ad`.

Operation

- 1 `qu[127: 64] = load64({as[31: 3], 3{0}})`
- 2 `as[31:0] = as[31:0] + ad[31:0]`

1.8.92 EE.VLD.L.64.IP

Instruction Word

1	imm8[7]	qu[2:1]	1001	qu[0]	imm8[6:0]	as[3:0]	0100
---	---------	---------	------	-------	-----------	---------	------

Assembler Syntax

EE.VLD.L.64.IP qu, as, -1024..1016

Description

This instruction forces the lower 3 bits of the access address in register `as` to 0 and loads 64-bit data from memory to the lower 64-bit segment in register `qu`. After the access is completed, the value in register `as` is incremented by 8-bit sign-extended constant in the instruction code segment left-shifted by 3.

Operation

- 1 `qu[63:0] = load64({as[31:3],3{0}})`
- 2 `as[31:0] = as[31:0] + {21{imm8[7]},imm8[7:0],3{0}}`

1.8.93 EE.VLD.L.64.XP

Instruction Word

10	qu[2:1]	1101	qu[0]	011	ad[3:0]	as[3:0]	0100
----	---------	------	-------	-----	---------	---------	------

Assembler Syntax

EE.VLD.L.64.XP qu, as, ad

Description

This instruction forces the lower 3 bits of the access address in register `as` to 0 and loads 64-bit data from memory to the lower 64-bit segment in register `qu`. After the access is completed, the value in register `as` is incremented by the value in register `ad`.

Operation

- 1 `qu[63:0] = load64({as[31:3],3{0}})`
- 2 `as[31:0] = as[31:0] + ad[31:0]`

1.8.94 EE.VLDBC.16

Instruction Word

11	qu[2:1]	1101	qu[0]	1110011	as[3:0]	0100
----	---------	------	-------	---------	---------	------

Assembler Syntax

EE.VLDBC.16 qu, as

Description

This instruction forces the lower 1 bit of the access address in register as to 0, loads 16-bit data from memory, and broadcasts it to the eight 16-bit data segments in register qu.

Operation

```
1  qu[127:0] = {8{load16({as[31:1], 1{0}})}}
```

1.8.95 EE.VLDBC.16.IP

Instruction Word

10	qu[2:1]	0101	qu[0]	imm2[6:0]	as[3:0]	0100
----	---------	------	-------	-----------	---------	------

Assembler Syntax

EE.VLDBC.16.IP qu, as, 0..254

Description

This instruction forces the lower 1 bit of the access address in register `as` to 0, loads 16-bit data from memory, and broadcasts it to the eight 16-bit data segments in register `qu`. After the access is completed, the value in register `as` is incremented by 7-bit unsign-extended constant in the instruction code segment left-shifted by 1.

Operation

- 1 $qu[127:0] = \{8\{load16(\{as[31:1], 1\{0}\})\}\}$
- 2 $as[31:0] = as[31:0] + \{24\{0\}, imm2[6:0], 0\}$

1.8.96 EE.VLDBC.16.XP

Instruction Word

10	qu[2:1]	1101	qu[0]	100	ad[3:0]	as[3:0]	0100
----	---------	------	-------	-----	---------	---------	------

Assembler Syntax

EE.VLDBC.16.XP qu, as, ad

Description

This instruction forces the lower 1 bit of the access address in register `as` to 0, loads 16-bit data from memory, and broadcasts it to the eight 16-bit data segments in register `qu`. After the access is completed, the value in register `as` is incremented by the value in register `ad`.

Operation

```

1  qu[127:0] = {8{load16({as[31:1],1{0}})}}
2  as = as + ad[31:0]

```

1.8.97 EE.VLDBC.32

Instruction Word

11	qu[2:1]	1101	qu[0]	1110111	as[3:0]	0100
----	---------	------	-------	---------	---------	------

Assembler Syntax

EE.VLDBC.32 qu, as

Description

This instruction forces the lower 2 bits of the access address in register as to 0 and loads 32-bit data from memory and broadcasts it to the four 32-bit data segments in register qu.

Operation

```
1  qu[127:0] = {4{load32({as[31:2], 2{0}})}}
```

1.8.98 EE.VLDBC.32.IP

Instruction Word

1	imm4[7]	qu[2:1]	0010	qu[0]	imm4[6:0]	as[3:0]	0100
---	---------	---------	------	-------	-----------	---------	------

Assembler Syntax

EE.VLDBC.32.IP qu, as, -256..252

Description

This instruction forces the lower 2 bits of the access address in register as to 0 and loads 32-bit data from memory and broadcasts it to the four 32-bit data segments in register qu. After the access is completed, the value in register as is incremented by 8-bit sign-extended constant in the instruction code segment left-shifted by 2.

Operation

- 1 $qu[127:0] = \{4\{load32(\{as[31:2], 2\{0\}})\}\}$
- 2 $as[31:0] = as[31:0] + \{22\{imm4[7]\}, imm4[7:0], 2\{0\}\}$

1.8.99 EE.VLDBC.32.XP

Instruction Word

10	qu[2:1]	1101	qu[0]	001	ad[3:0]	as[3:0]	0100
----	---------	------	-------	-----	---------	---------	------

Assembler Syntax

EE.VLDBC.32.XP qu, as, ad

Description

This instruction forces the lower 2 bits of the access address in register as to 0, loads 32-bit data from memory and broadcasts it to the four 32-bit data segments in register qu. After the access is completed, the value in register as is incremented by the value in register ad.

Operation

```

1  qu[127:0] = {4{load32({as[31:2], 2{0}})}}
2  as = as + ad[31:0]

```

1.8.100 EE.VLDBC.8

Instruction Word

11	qu[2:1]	1101	qu[0]	0111011	as[3:0]	0100
----	---------	------	-------	---------	---------	------

Assembler Syntax

EE.VLDBC.8 qu, as

Description

This instruction loads 8-bit data from memory at the address given by the access register as and broadcasts it to the 16 8-bit data segments in register qu.

Operation

```
1 qu[127:0] = {16{load8(as[31:0])}}
```

1.8.101 EE.VLDBC.8.IP

Instruction Word

11	qu[2:1]	0101	qu[0]	imm1[6:0]	as[3:0]	0100
----	---------	------	-------	-----------	---------	------

Assembler Syntax

EE.VLDBC.8.IP qu, as, 0..127

Description

This instruction loads 8-bit data from memory at the address given by the access register as and broadcasts it to the 16 8-bit data segments in register qu. After the access is completed, the value in register as is incremented by 7-bit unsign-extended constant in the instruction code segment.

Operation

- 1 $qu[127:0] = \{16\{\text{load8}(as[31:0])\}\}$
- 2 $as[31:0] = as[31:0] + \{25\{0\}, imm1[6:0]\}$

1.8.102 EE.VLDBC.8.XP

Instruction Word

10	qu[2:1]	1101	qu[0]	101	ad[3:0]	as[3:0]	0100
----	---------	------	-------	-----	---------	---------	------

Assembler Syntax

EE.VLDBC.8.XP qu, as, ad

Description

This instruction loads 8-bit data from memory at the address given by the access register as and broadcasts it to the 16 8-bit data segments in register qu. After the access is completed, the value in register as is incremented by the value in register ad.

Operation

```

1  qu[127:0] = {16{load8(as[31:0])}}
2  as = as + ad[31:0]

```

1.8.103 EE.VLDHBC.16.INCP

Instruction Word

11	qu[2:1]	1100	qu[0]	qu1[2:0]	0010	as[3:0]	0100
----	---------	------	-------	----------	------	---------	------

Assembler Syntax

EE.VLDHBC.16.INCP qu, qu1, as

Description

This instruction forces the lower 4 bits of the access address in register `as` to 0, loads 16-byte data from memory, extends it to 256 bits according to the following way, and assigns the result to registers `qu` and `qu1`. After the access, the value in register `as` is incremented by 16.

Operation

```

1  dataIn[127:0] = load128({as[31:4],4{0}})
2  qu  = {2{dataIn[ 63: 48]}, 2{dataIn[ 47: 32]}, 2{dataIn[ 31: 16]}, 2{dataIn[ 15:  0]} }
3  qu1 = {2{dataIn[127:112]}, 2{dataIn[111: 96]}, 2{dataIn[ 95: 80]}, 2{dataIn[ 79: 64]} }
4  as[31:0] = as[31:0] + 16

```

1.8.104 EE.VMAX.S16

Instruction Word

10	qa[2:1]	1110	qa[0]	qy[2]	1	qy[1:0]	qx[2:0]	00100100
----	---------	------	-------	-------	---	---------	---------	----------

Assembler Syntax

EE.VMAX.S16 qa, qx, qy

Description

This instruction compares numerical values of the eight 16-bit vector data segments in registers qx and qy. The data segment with the larger value is written into the corresponding 16-bit data segment in register qa.

Operation

```

1  qa[ 15: 0] = (qx[ 15: 0]>=qy[ 15: 0]) ? qx[ 15: 0] : qy[ 15: 0]
2  qa[ 31: 16] = (qx[ 31: 16]>=qy[ 31: 16]) ? qx[ 31: 16] : qy[ 31: 16]
3  ...
4  qa[127:112] = (qx[127:112]>=qy[127:112]) ? qx[127:112] : qy[127:112]
```

1.8.105 EE.VMAX.S16.LD.INCP

Instruction Word

111000	qu[2:1]	qy[0]	001	qu[0]	qa[2:0]	qx[1:0]	qy[2:1]	1101	as[3:0]	111	qx[2]
--------	---------	-------	-----	-------	---------	---------	---------	------	---------	-----	-------

Assembler Syntax

EE.VMAX.S16.LD.INCP qu, as, qa, qx, qy

Description

This instruction compares numerical values of the eight 16-bit vector data segments in registers `qx` and `qy`. The data segment with the larger value is written into the corresponding 16-bit data segment in register `qa`.

During the operation, the lower 4 bits of the access address in register `as` are forced to be 0, and then the 16-byte data is loaded from the memory to register `qu`. After the access, the value in register `as` is incremented by 16.

Operation

```

1  qa[ 15: 0] = (qx[ 15: 0]>=qy[ 15: 0]) ? qx[ 15: 0] : qy[ 15: 0]
2  qa[ 31: 16] = (qx[ 31: 16]>=qy[ 31: 16]) ? qx[ 31: 16] : qy[ 31: 16]
3  ...
4  qa[127:112] = (qx[127:112]>=qy[127:112]) ? qx[127:112] : qy[127:112]
5
6  qu[127:0] = load128({as[31:4],4{0}})
7  as[31:0] = as[31:0] + 16

```

1.8.106 EE.VMAX.S16.ST.INCP

Instruction Word

11100100	qy[0]	qv[2:0]	1	qa[2:0]	qx[1:0]	qy[2:1]	0011	as[3:0]	111	qx[2]
----------	-------	---------	---	---------	---------	---------	------	---------	-----	-------

Assembler Syntax

EE.VMAX.S16.ST.INCP qv, as, qa, qx, qy

Description

This instruction compares numerical values of the eight 16-bit vector data segments in registers `qx` and `qy`. The data segment with the larger value is written into the corresponding 16-bit data segment in register `qa`.

During the operation, the instruction forces the lower 4 bits of the access address in register `as` to 0 and stores the value in register `qv` to memory. After the access, the value in register `as` is incremented by 16.

Operation

```

1  qa[ 15: 0] = (qx[ 15: 0]>=qy[ 15: 0]) ? qx[ 15: 0] : qy[ 15: 0]
2  qa[ 31: 16] = (qx[ 31: 16]>=qy[ 31: 16]) ? qx[ 31: 16] : qy[ 31: 16]
3  ...
4  qa[127:112] = (qx[127:112]>=qy[127:112]) ? qx[127:112] : qy[127:112]
5
6  qv[127:0] => store128({as[31:4],4{0}})
7  as[31:0] = as[31:0] + 16

```

1.8.107 EE.VMAX.S32

Instruction Word

10	qa[2:1]	1110	qa[0]	qy[2]	1	qy[1:0]	qx[2:0]	00110100
----	---------	------	-------	-------	---	---------	---------	----------

Assembler Syntax

EE.VMAX.S32 qa, qx, qy

Description

This instruction compares numerical values of the four 32-bit vector data segments in registers qx and qy. The data segment with the larger value is written into the corresponding 32-bit data segment in register qa.

Operation

```

1  qa[ 31: 0] = (qx[ 31: 0]>=qy[ 31: 0]) ? qx[ 31: 0] : qy[ 31: 0]
2  qa[ 63: 32] = (qx[ 63: 32]>=qy[ 63: 32]) ? qx[ 63: 32] : qy[ 63: 32]
3  ...
4  qa[127: 96] = (qx[127: 96]>=qy[127: 96]) ? qx[127: 96] : qy[127: 96]

```

1.8.108 EE.VMAX.S32.LD.INCP

Instruction Word

111000	qu[2:1]	qy[0]	001	qu[0]	qa[2:0]	qx[1:0]	qy[2:1]	1110	as[3:0]	111	qx[2]
--------	---------	-------	-----	-------	---------	---------	---------	------	---------	-----	-------

Assembler Syntax

EE.VMAX.S32.LD.INCP qu, as, qa, qx, qy

Description

This instruction compares numerical values of the four 32-bit vector data segments in registers qx and qy. The data segment with the larger value is written into the corresponding 32-bit data segment in register qa.

During the operation, the lower 4 bits of the access address in register as are forced to be 0, and then the 16-byte data is loaded from the memory to register qu. After the access, the value in register as is incremented by 16.

Operation

```

1  qa[ 31: 0] = (qx[ 31: 0]>=qy[ 31: 0]) ? qx[ 31: 0] : qy[ 31: 0]
2  qa[ 63: 32] = (qx[ 63: 32]>=qy[ 63: 32]) ? qx[ 63: 32] : qy[ 63: 32]
3  ...
4  qa[127: 96] = (qx[127: 96]>=qy[127: 96]) ? qx[127: 96] : qy[127: 96]
5
6  qu[127:0] = load128({as[31:4],4{0}})
7  as[31:0] = as[31:0] + 16

```

1.8.109 EE.VMAX.S32.ST.INCP

Instruction Word

11100101	qy[0]	qv[2:0]	0	qa[2:0]	qx[1:0]	qy[2:1]	0000	as[3:0]	111	qx[2]
----------	-------	---------	---	---------	---------	---------	------	---------	-----	-------

Assembler Syntax

EE.VMAX.S32.ST.INCP qv, as, qa, qx, qy

Description

This instruction compares numerical values of the four 32-bit vector data segments in registers qx and qy. The data segment with the larger value is written into the corresponding 32-bit data segment in register qa.

During the operation, the instruction forces the lower 4 bits of the access address in register as to 0 and stores the value in register qv to memory. After the access, the value in register as is incremented by 16.

Operation

```

1  qa[ 31: 0] = (qx[ 31: 0]>=qy[ 31: 0]) ? qx[ 31: 0] : qy[ 31: 0]
2  qa[ 63: 32] = (qx[ 63: 32]>=qy[ 63: 32]) ? qx[ 63: 32] : qy[ 63: 32]
3  ...
4  qa[127: 96] = (qx[127: 96]>=qy[127: 96]) ? qx[127: 96] : qy[127: 96]
5
6  qv[127:0] => store128({as[31:4],4{0}})
7  as[31:0] = as[31:0] + 16

```

1.8.110 EE.VMAX.S8

Instruction Word

10	qa[2:1]	1110	qa[0]	qy[2]	1	qy[1:0]	qx[2:0]	01000100
----	---------	------	-------	-------	---	---------	---------	----------

Assembler Syntax

EE.VMAX.S8 qa, qx, qy

Description

This instruction compares numerical values of the 16 8-bit vector data segments in registers qx and qy. The data segment with the larger value is written into the corresponding 8-bit data segment in register qa.

Operation

```

1  qa[ 7: 0] = (qx[ 7: 0]>=qy[ 7: 0]) ? qx[ 7: 0] : qy[ 7: 0]
2  qa[15: 8] = (qx[15: 8]>=qy[15: 8]) ? qx[15: 8] : qy[15: 8]
3  ...
4  qa[127:120] = (qx[127:120]>=qy[127:120]) ? qx[127:120] : qy[127:120]
```

1.8.111 EE.VMAX.S8.LD.INCP

Instruction Word

111000	qu[2:1]	qy[0]	001	qu[0]	qa[2:0]	qx[1:0]	qy[2:1]	1111	as[3:0]	111	qx[2]
--------	---------	-------	-----	-------	---------	---------	---------	------	---------	-----	-------

Assembler Syntax

EE.VMAX.S8.LD.INCP qu, as, qa, qx, qy

Description

This instruction compares numerical values of the 16 8-bit vector data segments in registers qx and qy. The data segment with the larger value is written into the corresponding 8-bit data segment in register qa.

During the operation, the lower 4 bits of the access address in register as are forced to be 0, and then the 16-byte data is loaded from the memory to register qu. After the access, the value in register as is incremented by 16.

Operation

```

1  qa[ 7: 0] = (qx[ 7: 0]>=qy[ 7: 0]) ? qx[ 7: 0] : qy[ 7: 0]
2  qa[15: 8] = (qx[15: 8]>=qy[15: 8]) ? qx[15: 8] : qy[15: 8]
3  ...
4  qa[127:120] = (qx[127:120]>=qy[127:120]) ? qx[127:120] : qy[127:120]
5
6  qu[127:0] = load128({as[31:4],4{0}})
7  as[31:0] = as[31:0] + 16

```

1.8.112 EE.VMAX.S8.ST.INCP

Instruction Word

11100101	qy[0]	qv[2:0]	1	qa[2:0]	qx[1:0]	qy[2:1]	0000	as[3:0]	111	qx[2]
----------	-------	---------	---	---------	---------	---------	------	---------	-----	-------

Assembler Syntax

EE.VMAX.S8.ST.INCP qv, as, qa, qx, qy

Description

This instruction compares numerical values of the 16 8-bit vector data segments in registers qx and qy. The data segment with the larger value is written into the corresponding 8-bit data segment in register qa.

During the operation, the instruction forces the lower 4 bits of the access address in register as to 0 and stores the value in register qv to memory. After the access, the value in register as is incremented by 16.

Operation

```

1  qa[ 7: 0] = (qx[ 7: 0]>=qy[ 7: 0]) ? qx[ 7: 0] : qy[ 7: 0]
2  qa[15: 8] = (qx[15: 8]>=qy[15: 8]) ? qx[15: 8] : qy[15: 8]
3  ...
4  qa[127:120] = (qx[127:120]>=qy[127:120]) ? qx[127:120] : qy[127:120]
5
6  qv[127:0] => store128({as[31:4],4{0}})
7  as[31:0] = as[31:0] + 16

```

1.8.113 EE.VMIN.S16

Instruction Word

10	qa[2:1]	1110	qa[0]	qy[2]	1	qy[1:0]	qx[2:0]	01010100
----	---------	------	-------	-------	---	---------	---------	----------

Assembler Syntax

EE.VMIN.S16 qa, qx, qy

Description

This instruction compares numerical values of the eight 16-bit vector data segments in registers qx and qy. The data segment with the smaller value is written into the corresponding 16-bit data segment in register qa.

Operation

```

1  qa[ 15: 0] = (qx[ 15: 0]<=qy[ 15: 0]) ? qx[ 15: 0] : qy[ 15: 0]
2  qa[ 31: 16] = (qx[ 31: 16]<=qy[ 31: 16]) ? qx[ 31: 16] : qy[ 31: 16]
3  ...
4  qa[127:112] = (qx[127:112]<=qy[127:112]) ? qx[127:112] : qy[127:112]
```

1.8.114 EE.VMIN.S16.LD.INCP

Instruction Word

111000	qu[2:1]	qy[0]	010	qu[0]	qa[2:0]	qx[1:0]	qy[2:1]	1110	as[3:0]	111	qx[2]
--------	---------	-------	-----	-------	---------	---------	---------	------	---------	-----	-------

Assembler Syntax

EE.VMIN.S16.LD.INCP qu, as, qa, qx, qy

Description

This instruction compares numerical values of the eight 16-bit vector data segments in registers qx and qy. The data segment with the smaller value is written into the corresponding 16-bit data segment in register qa.

During the operation, the lower 4 bits of the access address in register as are forced to be 0, and then the 16-byte data is loaded from the memory to register qu. After the access, the value in register as is incremented by 16.

Operation

```

1  qa[ 15: 0] = (qx[ 15: 0]<=qy[ 15: 0]) ? qx[ 15: 0] : qy[ 15: 0]
2  qa[ 31: 16] = (qx[ 31: 16]<=qy[ 31: 16]) ? qx[ 31: 16] : qy[ 31: 16]
3  ...
4  qa[127:112] = (qx[127:112]<=qy[127:112]) ? qx[127:112] : qy[127:112]
5
6  qu[127:0] = load128({as[31:4],4{0}})
7  as[31:0] = as[31:0] + 16

```

1.8.115 EE.VMIN.S16.ST.INCP

Instruction Word

11100101	qy[0]	qv[2:0]	0	qa[2:0]	qx[1:0]	qy[2:1]	0001	as[3:0]	111	qx[2]
----------	-------	---------	---	---------	---------	---------	------	---------	-----	-------

Assembler Syntax

EE.VMIN.S16.ST.INCP qv, as, qa, qx, qy

Description

This instruction compares numerical values of the eight 16-bit vector data segments in registers qx and qy. The data segment with the smaller value is written into the corresponding 16-bit data segment in register qa.

During the operation, the instruction forces the lower 4 bits of the access address in register as to 0 and stores the value in register qv to memory. After the access, the value in register as is incremented by 16.

Operation

```

1  qa[ 15: 0] = (qx[ 15: 0]<=qy[ 15: 0]) ? qx[ 15: 0] : qy[ 15: 0]
2  qa[ 31: 16] = (qx[ 31: 16]<=qy[ 31: 16]) ? qx[ 31: 16] : qy[ 31: 16]
3  ...
4  qa[127:112] = (qx[127:112]<=qy[127:112]) ? qx[127:112] : qy[127:112]
5
6  qv[127:0] => store128({as[31:4],4{0}})
7  as[31:0] = as[31:0] + 16

```

1.8.116 EE.VMIN.S32

Instruction Word

10	qa[2:1]	1110	qa[0]	qy[2]	1	qy[1:0]	qx[2:0]	01100100
----	---------	------	-------	-------	---	---------	---------	----------

Assembler Syntax

EE.VMIN.S32 qa, qx, qy

Description

This instruction compares numerical values of the four 32-bit vector data segments in registers qx and qy. The data segment with the smaller value is written into the corresponding 32-bit data segment in register qa.

Operation

```

1  qa[ 31: 0] = (qx[ 31: 0] <= qy[ 31: 0]) ? qx[ 31: 0] : qy[ 31: 0]
2  qa[ 63: 32] = (qx[ 63: 32] <= qy[ 63: 32]) ? qx[ 63: 32] : qy[ 63: 32]
3  ...
4  qa[127: 96] = (qx[127: 96] <= qy[127: 96]) ? qx[127: 96] : qy[127: 96]

```

1.8.117 EE.VMIN.S32.LD.INCP

Instruction Word

111000	qu[2:1]	qy[0]	011	qu[0]	qa[2:0]	qx[1:0]	qy[2:1]	1110	as[3:0]	111	qx[2]
--------	---------	-------	-----	-------	---------	---------	---------	------	---------	-----	-------

Assembler Syntax

EE.VMIN.S32.LD.INCP qu, as, qa, qx, qy

Description

This instruction compares numerical values of the four 32-bit vector data segments in registers qx and qy. The data segment with the smaller value is written into the corresponding 32-bit data segment in register qa.

During the operation, the lower 4 bits of the access address in register as are forced to be 0, and then the 16-byte data is loaded from the memory to register qu. After the access, the value in register as is incremented by 16.

Operation

```

1  qa[ 31: 0] = (qx[ 31: 0]<=qy[ 31: 0]) ? qx[ 31: 0] : qy[ 31: 0]
2  qa[ 63: 32] = (qx[ 63: 32]<=qy[ 63: 32]) ? qx[ 63: 32] : qy[ 63: 32]
3  ...
4  qa[127: 96] = (qx[127: 96]<=qy[127: 96]) ? qx[127: 96] : qy[127: 96]
5
6  qu[127:0] = load128({as[31:4],4{0}})
7  as[31:0] = as[31:0] + 16

```

1.8.118 EE.VMIN.S32.ST.INCP**Instruction Word**

11100101	qy[0]	qv[2:0]	1	qa[2:0]	qx[1:0]	qy[2:1]	0001	as[3:0]	111	qx[2]
----------	-------	---------	---	---------	---------	---------	------	---------	-----	-------

Assembler Syntax

EE.VMIN.S32.ST.INCP qv, as, qa, qx, qy

Description

This instruction compares numerical values of the four 32-bit vector data segments in registers `qx` and `qy`. The data segment with the smaller value is written into the corresponding 32-bit data segment in register `qa`.

During the operation, the instruction forces the lower 4 bits of the access address in register `as` to 0 and stores the value in register `qv` to memory. After the access, the value in register `as` is incremented by 16.

Operation

```

1  qa[ 31: 0] = (qx[ 31: 0]<=qy[ 31: 0]) ? qx[ 31: 0] : qy[ 31: 0]
2  qa[ 63: 32] = (qx[ 63: 32]<=qy[ 63: 32]) ? qx[ 63: 32] : qy[ 63: 32]
3  ...
4  qa[127: 96] = (qx[127: 96]<=qy[127: 96]) ? qx[127: 96] : qy[127: 96]
5
6  qv[127:0] => store128({as[31:4],4{0}})
7  as[31:0] = as[31:0] + 16

```

1.8.119 EE.VMIN.S8

Instruction Word

10	qa[2:1]	1110	qa[0]	qy[2]	1	qy[1:0]	qx[2:0]	01110100
----	---------	------	-------	-------	---	---------	---------	----------

Assembler Syntax

EE.VMIN.S8 qa, qx, qy

Description

This instruction compares numerical values of the 16 8-bit vector data segments in registers qx and qy. The data segment with the smaller value is written into the corresponding 8-bit data segment in register qa.

Operation

```

1  qa[ 7: 0] = (qx[ 7: 0]<=qy[ 7: 0]) ? qx[ 7: 0] : qy[ 7: 0]
2  qa[15: 8] = (qx[15: 8]<=qy[15: 8]) ? qx[15: 8] : qy[15: 8]
3  ...
4  qa[127:120] = (qx[127:120]<=qy[127:120]) ? qx[127:120] : qy[127:120]
```

1.8.120 EE.VMIN.S8.LD.INCP

Instruction Word

111000	qu[2:1]	qy[0]	010	qu[0]	qa[2:0]	qx[1:0]	qy[2:1]	1111	as[3:0]	111	qx[2]
--------	---------	-------	-----	-------	---------	---------	---------	------	---------	-----	-------

Assembler Syntax

EE.VMIN.S8.LD.INCP qu, as, qa, qx, qy

Description

This instruction compares numerical values of the 16 8-bit vector data segments in registers `qx` and `qy`. The data segment with the smaller value is written into the corresponding 8-bit data segment in register `qa`.

During the operation, the lower 4 bits of the access address in register `as` are forced to be 0, and then the 16-byte data is loaded from the memory to register `qu`. After the access, the value in register `as` is incremented by 16.

Operation

```

1  qa[ 7: 0] = (qx[ 7: 0]<=qy[ 7: 0]) ? qx[ 7: 0] : qy[ 7: 0]
2  qa[15: 8] = (qx[15: 8]<=qy[15: 8]) ? qx[15: 8] : qy[15: 8]
3  ...
4  qa[127:120] = (qx[127:120]<=qy[127:120]) ? qx[127:120] : qy[127:120]
5
6  qu[127:0] = load128({as[31:4],4{0}})
7  as[31:0] = as[31:0] + 16

```

1.8.121 EE.VMIN.S8.ST.INCP

Instruction Word

11100101	qy[0]	qv[2:0]	0	qa[2:0]	qx[1:0]	qy[2:1]	0010	as[3:0]	111	qx[2]
----------	-------	---------	---	---------	---------	---------	------	---------	-----	-------

Assembler Syntax

EE.VMIN.S8.ST.INCP qv, as, qa, qx, qy

Description

This instruction compares numerical values of the 16 8-bit vector data segments in registers qx and qy. The data segment with the smaller value is written into the corresponding 8-bit data segment in register qa.

During the operation, the instruction forces the lower 4 bits of the access address in register as to 0 and stores the value in register qv to memory. After the access, the value in register as is incremented by 16.

Operation

```

1  qa[ 7: 0] = (qx[ 7: 0]<=qy[ 7: 0]) ? qx[ 7: 0] : qy[ 7: 0]
2  qa[15: 8] = (qx[15: 8]<=qy[15: 8]) ? qx[15: 8] : qy[15: 8]
3  ...
4  qa[127:120] = (qx[127:120]<=qy[127:120]) ? qx[127:120] : qy[127:120]
5
6  qv[127:0] => store128({as[31:4],4{0}})
7  as[31:0] = as[31:0] + 16

```

1.8.122 EE.VMUL.S16

Instruction Word

10	qz[2:1]	1110	qz[0]	qy[2]	1	qy[1:0]	qx[2:0]	10000100
----	---------	------	-------	-------	---	---------	---------	----------

Assembler Syntax

EE.VMUL.S16 qz, qx, qy

Description

This instruction performs a signed vector multiplication on 16-bit data. Registers `qx` and `qy` are the multiplier and the multiplicand respectively. The eight 32-bit data results obtained from the calculation is arithmetically right-shifted by the value in special register `SAR`. Then, the lower 16-bit data of the shift result is written into corresponding segment of register `qz`.

Operation

```

1  qz[ 15: 0] = (qx[ 15: 0] * qy[ 15: 0]) >> SAR[5:0]
2  qz[ 31: 16] = (qx[ 31: 16] * qy[ 31: 16]) >> SAR[5:0]
3  qz[ 47: 32] = (qx[ 47: 32] * qy[ 47: 32]) >> SAR[5:0]
4  qz[ 63: 48] = (qx[ 63: 48] * qy[ 63: 48]) >> SAR[5:0]
5  qz[ 79: 64] = (qx[ 79: 64] * qy[ 79: 64]) >> SAR[5:0]
6  qz[ 95: 80] = (qx[ 95: 80] * qy[ 95: 80]) >> SAR[5:0]
7  qz[111: 96] = (qx[111: 96] * qy[111: 96]) >> SAR[5:0]
8  qz[127:112] = (qx[127:112] * qy[127:112]) >> SAR[5:0]

```

1.8.123 EE.VMUL.S16.LD.INCP

Instruction Word

111000	qu[2:1]	qy[0]	011	qu[0]	qz[2:0]	qx[1:0]	qy[2:1]	1111	as[3:0]	111	qx[2]
--------	---------	-------	-----	-------	---------	---------	---------	------	---------	-----	-------

Assembler Syntax

EE.VMUL.S16.LD.INCP qu, as, qz, qx, qy

Description

This instruction performs a signed vector multiplication on 16-bit data. Registers qx and qy are the multiplier and the multiplicand respectively. The eight 32-bit data results obtained from the calculation is arithmetically right-shifted by the value in special register SAR. Then, the lower 16-bit data of the shift result is written into corresponding segment of register qz.

During the operation, the lower 4 bits of the access address in register as are forced to be 0, and then the 16-byte data is loaded from the memory to register qu. After the access, the value in register as is incremented by 16.

Operation

```

1  qz[ 15: 0] = (qx[ 15: 0] * qy[ 15: 0]) >> SAR[5:0]
2  qz[ 31: 16] = (qx[ 31: 16] * qy[ 31: 16]) >> SAR[5:0]
3  qz[ 47: 32] = (qx[ 47: 32] * qy[ 47: 32]) >> SAR[5:0]
4  qz[ 63: 48] = (qx[ 63: 48] * qy[ 63: 48]) >> SAR[5:0]
5  qz[ 79: 64] = (qx[ 79: 64] * qy[ 79: 64]) >> SAR[5:0]
6  qz[ 95: 80] = (qx[ 95: 80] * qy[ 95: 80]) >> SAR[5:0]
7  qz[111: 96] = (qx[111: 96] * qy[111: 96]) >> SAR[5:0]
8  qz[127:112] = (qx[127:112] * qy[127:112]) >> SAR[5:0]
9
10 qu[127:0] = load128({as[31:4],4{0}})
11 as[31:0] = as[31:0] + 16

```

1.8.124 EE.VMUL.S16.ST.INCP

Instruction Word

11100101	qy[0]	qv[2:0]	1	qz[2:0]	qx[1:0]	qy[2:1]	0010	as[3:0]	111	qx[2]
----------	-------	---------	---	---------	---------	---------	------	---------	-----	-------

Assembler Syntax

EE.VMUL.S16.ST.INCP qv, as, qz, qx, qy

Description

This instruction performs a signed vector multiplication on 16-bit data. Registers qx and qy are the multiplier and the multiplicand respectively. The eight 32-bit data results obtained from the calculation is arithmetically right-shifted by the value in special register SAR. Then, the lower 16-bit data of the shift result is written into corresponding segment of register qz.

During the operation, the instruction forces the lower 4 bits of the access address in register as to 0 and stores the value in register qv to memory. After the access, the value in register as is incremented by 16.

Operation

```

1  qz[ 15: 0] = (qx[ 15: 0] * qy[ 15: 0]) >> SAR[5:0]
2  qz[ 31: 16] = (qx[ 31: 16] * qy[ 31: 16]) >> SAR[5:0]
3  qz[ 47: 32] = (qx[ 47: 32] * qy[ 47: 32]) >> SAR[5:0]
4  qz[ 63: 48] = (qx[ 63: 48] * qy[ 63: 48]) >> SAR[5:0]
5  qz[ 79: 64] = (qx[ 79: 64] * qy[ 79: 64]) >> SAR[5:0]
6  qz[ 95: 80] = (qx[ 95: 80] * qy[ 95: 80]) >> SAR[5:0]
7  qz[111: 96] = (qx[111: 96] * qy[111: 96]) >> SAR[5:0]
8  qz[127:112] = (qx[127:112] * qy[127:112]) >> SAR[5:0]
9
10 qv[127:0] => store128({as[31:4],4{0}})
11 as[31:0] = as[31:0] + 16

```

1.8.125 EE.VMUL.S8

Instruction Word

10	qz[2:1]	1110	qz[0]	qy[2]	1	qy[1:0]	qx[2:0]	10010100
----	---------	------	-------	-------	---	---------	---------	----------

Assembler Syntax

EE.VMUL.S8 qz, qx, qy

Description

This instruction performs a signed vector multiplication on 8-bit data. Registers `qx` and `qy` are the multiplier and the multiplicand respectively. The 16 16-bit data results obtained from the calculation is arithmetically right-shifted by the value in special register `SAR`. Then, the lower 8-bit data of the shift result is written into corresponding segment of register `qz`.

Operation

```

1  qz[ 7: 0] = (qx[ 7: 0] * qy[ 7: 0]) >> SAR[5:0]
2  qz[15: 8] = (qx[15: 8] * qy[15: 8]) >> SAR[5:0]
3  qz[23:16] = (qx[23:16] * qy[23:16]) >> SAR[5:0]
4  qz[31:24] = (qx[31:24] * qy[31:24]) >> SAR[5:0]
5  qz[39:32] = (qx[39:32] * qy[39:32]) >> SAR[5:0]
6  qz[47:40] = (qx[47:40] * qy[47:40]) >> SAR[5:0]
7  qz[55:48] = (qx[55:48] * qy[55:48]) >> SAR[5:0]
8  qz[63:56] = (qx[63:56] * qy[63:56]) >> SAR[5:0]
9  qz[71:64] = (qx[71:64] * qy[71:64]) >> SAR[5:0]
10 qz[79:72] = (qx[79:72] * qy[79:72]) >> SAR[5:0]
11 qz[87:80] = (qx[87:80] * qy[87:80]) >> SAR[5:0]
12 qz[95:88] = (qx[95:88] * qy[95:88]) >> SAR[5:0]
13 qz[103:96] = (qx[103:96] * qy[103:96]) >> SAR[5:0]
14 qz[111:104] = (qx[111:104] * qy[111:104]) >> SAR[5:0]
15 qz[119:112] = (qx[119:112] * qy[119:112]) >> SAR[5:0]
16 qz[127:120] = (qx[127:120] * qy[127:120]) >> SAR[5:0]

```

1.8.126 EE.VMUL.S8.LD.INCP

Instruction Word

111000	qu[2:1]	qy[0]	100	qu[0]	qz[2:0]	qx[1:0]	qy[2:1]	1100	as[3:0]	111	qx[2]
--------	---------	-------	-----	-------	---------	---------	---------	------	---------	-----	-------

Assembler Syntax

EE.VMUL.S8.LD.INCP qu, as, qz, qx, qy

Description

This instruction performs a signed vector multiplication on 8-bit data. Registers qx and qy are the multiplier and the multiplicand respectively. The 16 16-bit data results obtained from the calculation is arithmetically right-shifted by the value in special register SAR. Then, the lower 8-bit data of the shift result is written into corresponding segment of register qz.

During the operation, the lower 4 bits of the access address in register as are forced to be 0, and then the 16-byte data is loaded from the memory to register qu. After the access, the value in register as is incremented by 16.

Operation

```

1  qz[ 7: 0] = (qx[ 7: 0] * qy[ 7: 0]) >> SAR[5:0]
2  qz[15: 8] = (qx[15: 8] * qy[15: 8]) >> SAR[5:0]
3  qz[23:16] = (qx[23:16] * qy[23:16]) >> SAR[5:0]
4  qz[31:24] = (qx[31:24] * qy[31:24]) >> SAR[5:0]
5  qz[39:32] = (qx[39:32] * qy[39:32]) >> SAR[5:0]
6  qz[47:40] = (qx[47:40] * qy[47:40]) >> SAR[5:0]
7  qz[55:48] = (qx[55:48] * qy[55:48]) >> SAR[5:0]
8  qz[63:56] = (qx[63:56] * qy[63:56]) >> SAR[5:0]
9  qz[71:64] = (qx[71:64] * qy[71:64]) >> SAR[5:0]
10 qz[79:72] = (qx[79:72] * qy[79:72]) >> SAR[5:0]
11 qz[87:80] = (qx[87:80] * qy[87:80]) >> SAR[5:0]
12 qz[95:88] = (qx[95:88] * qy[95:88]) >> SAR[5:0]
13 qz[103:96] = (qx[103:96] * qy[103:96]) >> SAR[5:0]
14 qz[111:104] = (qx[111:104] * qy[111:104]) >> SAR[5:0]
15 qz[119:112] = (qx[119:112] * qy[119:112]) >> SAR[5:0]
16 qz[127:120] = (qx[127:120] * qy[127:120]) >> SAR[5:0]
17
18 qu[127:0] = load128({as[31:4],4{0}})
19 as[31:0] = as[31:0] + 16

```

1.8.127 EE.VMUL.S8.ST.INCP

Instruction Word

11100101	qy[0]	qv[2:0]	0	qz[2:0]	qx[1:0]	qy[2:1]	0011	as[3:0]	111	qx[2]
----------	-------	---------	---	---------	---------	---------	------	---------	-----	-------

Assembler Syntax

EE.VMUL.S8.ST.INCP qv, as, qz, qx, qy

Description

This instruction performs a signed vector multiplication on 8-bit data. Registers qx and qy are the multiplier and the multiplicand respectively. The 16 16-bit data results obtained from the calculation is arithmetically right-shifted by the value in special register SAR. Then, the lower 8-bit data of the shift result is written into corresponding segment of register qz.

During the operation, the instruction forces the lower 4 bits of the access address in register as to 0 and stores the value in register qv to memory. After the access, the value in register as is incremented by 16.

Operation

```

1  qz[ 7: 0] = (qx[ 7: 0] * qy[ 7: 0]) >> SAR[5:0]
2  qz[15: 8] = (qx[15: 8] * qy[15: 8]) >> SAR[5:0]
3  qz[23:16] = (qx[23:16] * qy[23:16]) >> SAR[5:0]
4  qz[31:24] = (qx[31:24] * qy[31:24]) >> SAR[5:0]
5  qz[39:32] = (qx[39:32] * qy[39:32]) >> SAR[5:0]
6  qz[47:40] = (qx[47:40] * qy[47:40]) >> SAR[5:0]
7  qz[55:48] = (qx[55:48] * qy[55:48]) >> SAR[5:0]
8  qz[63:56] = (qx[63:56] * qy[63:56]) >> SAR[5:0]
9  qz[71:64] = (qx[71:64] * qy[71:64]) >> SAR[5:0]
10 qz[79:72] = (qx[79:72] * qy[79:72]) >> SAR[5:0]
11 qz[87:80] = (qx[87:80] * qy[87:80]) >> SAR[5:0]
12 qz[95:88] = (qx[95:88] * qy[95:88]) >> SAR[5:0]
13 qz[103:96] = (qx[103:96] * qy[103:96]) >> SAR[5:0]
14 qz[111:104] = (qx[111:104] * qy[111:104]) >> SAR[5:0]
15 qz[119:112] = (qx[119:112] * qy[119:112]) >> SAR[5:0]
16 qz[127:120] = (qx[127:120] * qy[127:120]) >> SAR[5:0]
17
18 qv[127:0] => store128({as[31:4],4{0}})
19 as[31:0] = as[31:0] + 16

```

1.8.128 EE.VMUL.U16

Instruction Word

10	qz[2:1]	1110	qz[0]	qy[2]	1	qy[1:0]	qx[2:0]	10100100
----	---------	------	-------	-------	---	---------	---------	----------

Assembler Syntax

EE.VMUL.U16 qz, qx, qy

Description

This instruction performs an unsigned vector multiplication on 16-bit data. Registers `qx` and `qy` are the multiplier and the multiplicand respectively. The eight 32-bit data results obtained from the calculation is logically right-shifted by the value in special register `SAR`. Then, the lower 16-bit data of the shift result is written into corresponding segment of register `qz`.

Operation

```

1  qz[ 15: 0] = (qx[ 15: 0] * qy[ 15: 0]) >> SAR[5:0]
2  qz[ 31: 16] = (qx[ 31: 16] * qy[ 31: 16]) >> SAR[5:0]
3  qz[ 47: 32] = (qx[ 47: 32] * qy[ 47: 32]) >> SAR[5:0]
4  qz[ 63: 48] = (qx[ 63: 48] * qy[ 63: 48]) >> SAR[5:0]
5  qz[ 79: 64] = (qx[ 79: 64] * qy[ 79: 64]) >> SAR[5:0]
6  qz[ 95: 80] = (qx[ 95: 80] * qy[ 95: 80]) >> SAR[5:0]
7  qz[111: 96] = (qx[111: 96] * qy[111: 96]) >> SAR[5:0]
8  qz[127:112] = (qx[127:112] * qy[127:112]) >> SAR[5:0]

```

1.8.129 EE.VMUL.U16.LD.INCP

Instruction Word

111000	qu[2:1]	qy[0]	101	qu[0]	qz[2:0]	qx[1:0]	qy[2:1]	1100	as[3:0]	111	qx[2]
--------	---------	-------	-----	-------	---------	---------	---------	------	---------	-----	-------

Assembler Syntax

EE.VMUL.U16.LD.INCP qu, as, qz, qx, qy

Description

This instruction performs an unsigned vector multiplication on 16-bit data. Registers `qx` and `qy` are the multiplier and the multiplicand respectively. The eight 32-bit data results obtained from the calculation is logically right-shifted by the value in special register `SAR`. Then, the lower 16-bit data of the shift result is written into corresponding segment of register `qz`.

During the operation, the lower 4 bits of the access address in register `as` are forced to be 0, and then the 16-byte data is loaded from the memory to register `qu`. After the access, the value in register `as` is incremented by 16.

Operation

```

1  qz[ 15: 0] = (qx[ 15: 0] * qy[ 15: 0]) >> SAR[5:0]
2  qz[ 31: 16] = (qx[ 31: 16] * qy[ 31: 16]) >> SAR[5:0]
3  qz[ 47: 32] = (qx[ 47: 32] * qy[ 47: 32]) >> SAR[5:0]
4  qz[ 63: 48] = (qx[ 63: 48] * qy[ 63: 48]) >> SAR[5:0]
5  qz[ 79: 64] = (qx[ 79: 64] * qy[ 79: 64]) >> SAR[5:0]
6  qz[ 95: 80] = (qx[ 95: 80] * qy[ 95: 80]) >> SAR[5:0]
7  qz[111: 96] = (qx[111: 96] * qy[111: 96]) >> SAR[5:0]
8  qz[127:112] = (qx[127:112] * qy[127:112]) >> SAR[5:0]
9
10 qu[127:0] = load128({as[31:4],4{0}})
11 as[31:0] = as[31:0] + 16

```

1.8.130 EE.VMUL.U16.ST.INCP

Instruction Word

11100101	qy[0]	qv[2:0]	1	qz[2:0]	qx[1:0]	qy[2:1]	0011	as[3:0]	111	qx[2]
----------	-------	---------	---	---------	---------	---------	------	---------	-----	-------

Assembler Syntax

EE.VMUL.U16.ST.INCP qv, as, qz, qx, qy

Description

This instruction performs an unsigned vector multiplication on 16-bit data. Registers `qx` and `qy` are the multiplier and the multiplicand respectively. The eight 32-bit data results obtained from the calculation is logically right-shifted by the value in special register `SAR`. Then, the lower 16-bit data of the shift result is written into corresponding segment of register `qz`.

During the operation, the instruction forces the lower 4 bits of the access address in register `as` to 0 and stores the value in register `qv` to memory. After the access, the value in register `as` is incremented by 16.

Operation

```

1  qz[ 15: 0] = (qx[ 15: 0] * qy[ 15: 0]) >> SAR[5:0]
2  qz[ 31: 16] = (qx[ 31: 16] * qy[ 31: 16]) >> SAR[5:0]
3  qz[ 47: 32] = (qx[ 47: 32] * qy[ 47: 32]) >> SAR[5:0]
4  qz[ 63: 48] = (qx[ 63: 48] * qy[ 63: 48]) >> SAR[5:0]
5  qz[ 79: 64] = (qx[ 79: 64] * qy[ 79: 64]) >> SAR[5:0]
6  qz[ 95: 80] = (qx[ 95: 80] * qy[ 95: 80]) >> SAR[5:0]
7  qz[111: 96] = (qx[111: 96] * qy[111: 96]) >> SAR[5:0]
8  qz[127:112] = (qx[127:112] * qy[127:112]) >> SAR[5:0]
9
10 qv[127:0] => store128({as[31:4],4{0}})
11 as[31:0] = as[31:0] + 16

```

1.8.131 EE.VMUL.U8

Instruction Word

10	qz[2:1]	1110	qz[0]	qy[2]	1	qy[1:0]	qx[2:0]	10110100
----	---------	------	-------	-------	---	---------	---------	----------

Assembler Syntax

EE.VMUL.U8 qz, qx, qy

Description

This instruction performs an unsigned vector multiplication on 8-bit data. Registers `qx` and `qy` are the multiplier and the multiplicand respectively. The 16 16-bit data results obtained from the calculation is logically right-shifted by the value in special register `SAR`. Then, the lower 8-bit data of the shift result is written into corresponding segment of register `qz`.

Operation

```

1  qz[ 7: 0] = (qx[ 7: 0] * qy[ 7: 0]) >> SAR[5:0]
2  qz[15: 8] = (qx[15: 8] * qy[15: 8]) >> SAR[5:0]
3  qz[23:16] = (qx[23:16] * qy[23:16]) >> SAR[5:0]
4  qz[31:24] = (qx[31:24] * qy[31:24]) >> SAR[5:0]
5  qz[39:32] = (qx[39:32] * qy[39:32]) >> SAR[5:0]
6  qz[47:40] = (qx[47:40] * qy[47:40]) >> SAR[5:0]
7  qz[55:48] = (qx[55:48] * qy[55:48]) >> SAR[5:0]
8  qz[63:56] = (qx[63:56] * qy[63:56]) >> SAR[5:0]
9  qz[71:64] = (qx[71:64] * qy[71:64]) >> SAR[5:0]
10 qz[79:72] = (qx[79:72] * qy[79:72]) >> SAR[5:0]
11 qz[87:80] = (qx[87:80] * qy[87:80]) >> SAR[5:0]
12 qz[95:88] = (qx[95:88] * qy[95:88]) >> SAR[5:0]
13 qz[103:96] = (qx[103:96] * qy[103:96]) >> SAR[5:0]
14 qz[111:104] = (qx[111:104] * qy[111:104]) >> SAR[5:0]
15 qz[119:112] = (qx[119:112] * qy[119:112]) >> SAR[5:0]
16 qz[127:120] = (qx[127:120] * qy[127:120]) >> SAR[5:0]

```

1.8.132 EE.VMUL.U8.LD.INCP

Instruction Word

111000	qu[2:1]	qy[0]	110	qu[0]	qz[2:0]	qx[1:0]	qy[2:1]	1100	as[3:0]	111	qx[2]
--------	---------	-------	-----	-------	---------	---------	---------	------	---------	-----	-------

Assembler Syntax

EE.VMUL.U8.LD.INCP qu, as, qz, qx, qy

Description

This instruction performs an unsigned vector multiplication on 8-bit data. Registers `qx` and `qy` are the multiplier and the multiplicand respectively. The 16 32-bit data results obtained from the calculation is logically right-shifted by the value in special register `SAR`. Then, the lower 8-bit data of the shift result is written into corresponding segment of register `qz`.

During the operation, the lower 4 bits of the access address in register `as` are forced to be 0, and then the 16-byte data is loaded from the memory to register `qu`. After the access, the value in register `as` is incremented by 16.

Operation

```

1  qz[ 7: 0] = (qx[ 7: 0] * qy[ 7: 0]) >> SAR[5:0]
2  qz[15: 8] = (qx[15: 8] * qy[15: 8]) >> SAR[5:0]
3  qz[23:16] = (qx[23:16] * qy[23:16]) >> SAR[5:0]
4  qz[31:24] = (qx[31:24] * qy[31:24]) >> SAR[5:0]
5  qz[39:32] = (qx[39:32] * qy[39:32]) >> SAR[5:0]
6  qz[47:40] = (qx[47:40] * qy[47:40]) >> SAR[5:0]
7  qz[55:48] = (qx[55:48] * qy[55:48]) >> SAR[5:0]
8  qz[63:56] = (qx[63:56] * qy[63:56]) >> SAR[5:0]
9  qz[71:64] = (qx[71:64] * qy[71:64]) >> SAR[5:0]
10 qz[79:72] = (qx[79:72] * qy[79:72]) >> SAR[5:0]
11 qz[87:80] = (qx[87:80] * qy[87:80]) >> SAR[5:0]
12 qz[95:88] = (qx[95:88] * qy[95:88]) >> SAR[5:0]
13 qz[103:96] = (qx[103:96] * qy[103:96]) >> SAR[5:0]
14 qz[111:104] = (qx[111:104] * qy[111:104]) >> SAR[5:0]
15 qz[119:112] = (qx[119:112] * qy[119:112]) >> SAR[5:0]
16 qz[127:120] = (qx[127:120] * qy[127:120]) >> SAR[5:0]
17
18 qu[127:0] = load128({as[31:4],4{0}})
19 as[31:0] = as[31:0] + 16

```

1.8.133 EE.VMUL.U8.ST.INCP

Instruction Word

11101000	qy[0]	qv[2:0]	1	qz[2:0]	qx[1:0]	qy[2:1]	0000	as[3:0]	111	qx[2]
----------	-------	---------	---	---------	---------	---------	------	---------	-----	-------

Assembler Syntax

EE.VMUL.U8.ST.INCP qv, as, qz, qx, qy

Description

This instruction performs an unsigned vector multiplication on 8-bit data. Registers `qx` and `qy` are the multiplier and the multiplicand respectively. The 16 16-bit data results obtained from the calculation is logically right-shifted by the value in special register `SAR`. Then, the lower 8-bit data of the shift result is written into corresponding segment of register `qz`.

During the operation, the instruction forces the lower 4 bits of the access address in register `as` to 0 and stores the value in register `qv` to memory. After the access, the value in register `as` is incremented by 16.

Operation

```

1  qz[ 7: 0] = (qx[ 7: 0] * qy[ 7: 0]) >> SAR[5:0]
2  qz[15: 8] = (qx[15: 8] * qy[15: 8]) >> SAR[5:0]
3  qz[23:16] = (qx[23:16] * qy[23:16]) >> SAR[5:0]
4  qz[31:24] = (qx[31:24] * qy[31:24]) >> SAR[5:0]
5  qz[39:32] = (qx[39:32] * qy[39:32]) >> SAR[5:0]
6  qz[47:40] = (qx[47:40] * qy[47:40]) >> SAR[5:0]
7  qz[55:48] = (qx[55:48] * qy[55:48]) >> SAR[5:0]
8  qz[63:56] = (qx[63:56] * qy[63:56]) >> SAR[5:0]
9  qz[71:64] = (qx[71:64] * qy[71:64]) >> SAR[5:0]
10 qz[79:72] = (qx[79:72] * qy[79:72]) >> SAR[5:0]
11 qz[87:80] = (qx[87:80] * qy[87:80]) >> SAR[5:0]
12 qz[95:88] = (qx[95:88] * qy[95:88]) >> SAR[5:0]
13 qz[103:96] = (qx[103:96] * qy[103:96]) >> SAR[5:0]
14 qz[111:104] = (qx[111:104] * qy[111:104]) >> SAR[5:0]
15 qz[119:112] = (qx[119:112] * qy[119:112]) >> SAR[5:0]
16 qz[127:120] = (qx[127:120] * qy[127:120]) >> SAR[5:0]
17
18 qv[127:0] => store128({as[31:4],4{0}})
19 as[31:0] = as[31:0] + 16

```

1.8.134 EE.VMULAS.S16.ACCX

Instruction Word

000110100	qy[2]	0	qy[1:0]	qx[2:0]	10000100
-----------	-------	---	---------	---------	----------

Assembler Syntax

EE.VMULAS.S16.ACCX qx, qy

Description

This instruction divides registers qx and qy into 8 data segments by 16 bits. Then, it performs a signed multiply-accumulate operation on the 8 sets of segments respectively. The accumulated result is added to the value in special register ACCX. Then, the sum obtained is saturated and then stored in ACCX.

Operation

```

1  add0[31:0] = qx[ 15: 0] * qy[ 15: 0]
2  add1[31:0] = qx[ 31: 16] * qy[ 31: 16]
3  ...
4  add7[31:0] = qx[127:112] * qy[127:112]
5  sum[40:0] = ACCX[39:0] + ad[31:0]d0[31:0] + ad[31:0]d1[31:0] + ... + ad[31:0]d7[31:0]
6
7  ACCX[39:0] = min(max(sum[40:0], -2^{39}), 2^{39}-1)

```

1.8.135 EE.VMULAS.S16.ACCX.LD.IP

Instruction Word

1111	imm16[5:4]	qu[2:1]	qy[0]	000	qu[0]	000	qx[1:0]	qy[2:1]	imm16[3:0]	as[3:0]	111	qx[2]
------	------------	---------	-------	-----	-------	-----	---------	---------	------------	---------	-----	-------

Assembler Syntax

EE.VMULAS.S16.ACCX.LD.IP qu, as, -512..496, qx, qy

Description

This instruction divides registers qx and qy into 8 data segments by 16 bits. Then, it performs a signed multiply-accumulate operation on the 8 sets of segments respectively. The accumulated result is added to the value in special register ACCX. Then, the sum obtained is saturated and then stored in ACCX.

During the operation, the lower 4 bits of the access address in register as are forced to be 0, and then the 16-byte data is loaded from the memory to register qu. After the access is completed, the value in register as is incremented by 6-bit sign-extended constant in the instruction code segment left-shifted by 4.

Operation

```

1  add0[31:0] = qx[ 15: 0] * qy[ 15: 0]
2  add1[31:0] = qx[ 31: 16] * qy[ 31: 16]
3  ...
4  add7[31:0] = qx[127:112] * qy[127:112]
5  sum[40:0] = ACCX[39:0] + ad[31:0]d0[31:0] + ad[31:0]d1[31:0] + ... + ad[31:0]d7[31:0]
6  ACCX[39:0] = min(max(sum[40:0], -2^{39}), 2^{39}-1)
7
8  qu[127:0] = load128({as[31:4],4{0}})
9  as[31:0] = as[31:0] + {20{imm16[7]},imm16[7:0],4{0}}
```

1.8.136 EE.VMULAS.S16.ACCX.LD.IP.QUP

Instruction Word

0000	imm16[5:4]	qu[2:1]	qy[0]	qs0[2:0]	qu[0]	qs1[2:0]	qx[1:0]	qy[2:1]	imm16[3:0]	as[3:0]	111	qx[2]
------	------------	---------	-------	----------	-------	----------	---------	---------	------------	---------	-----	-------

Assembler Syntax

EE.VMULAS.S16.ACCX.LD.IP.QUP qu, as, imm16, qx, qy, qs0, qs1

Description

This instruction divides registers qx and qy into 8 data segments by 16 bits. Then, it performs a signed multiply-accumulate operation on the 8 sets of segments respectively. The accumulated result is added to the value in special register ACCX. Then, the sum obtained is saturated and then stored in ACCX.

During the operation, the lower 4 bits of the access address in register as are forced to be 0, and then the 16-byte data is loaded from the memory to register qu. After the access is completed, the value in register as is incremented by 6-bit sign-extended constant in the instruction code segment left-shifted by 4.

At the same time, this instruction also obtains 16-byte unaligned data by concatenating and shifting consecutive aligned data stored in the two registers qs0 and qs1 and stores it to qs0. The shift byte is stored in special register SAR_BYTE.

Operation

```

1  add0[31:0] = qx[ 15: 0] * qy[ 15: 0]
2  add1[31:0] = qx[ 31: 16] * qy[ 31: 16]
3  ...
4  add7[31:0] = qx[127:112] * qy[127:112]
5  sum[40:0] = ACCX[39:0] + ad[31:0]d0[31:0] + ad[31:0]d1[31:0] + ... + ad[31:0]d7[31:0]
6  ACCX[39:0] = min(max(sum[40:0], -2^{39}), 2^{39}-1)
7
8  qu[127:0] = load128({as[31:4], 4{0}})
9  as[31:0] = as[31:0] + {20{imm16[7]}, imm16[7:0], 4{0}}
10 qs0[127:0] = {qs1[127:0], qs0[127:0]} >> {SAR_BYTE[3:0] << 3}

```

1.8.137 EE.VMULAS.S16.ACCX.LD.XP

Instruction Word

111100	qu[2:1]	qy[0]	001	qu[0]	000	qx[1:0]	qy[2:1]	ad[3:0]	as[3:0]	111	qx[2]
--------	---------	-------	-----	-------	-----	---------	---------	---------	---------	-----	-------

Assembler Syntax

EE.VMULAS.S16.ACCX.LD.XP qu, as, ad, qx, qy

Description

This instruction divides registers qx and qy into 8 data segments by 16 bits. Then, it performs a signed multiply-accumulate operation on the 8 sets of segments respectively. The accumulated result is added to the value in special register ACCX. Then, the sum obtained is saturated and then stored in ACCX.

During the operation, the lower 4 bits of the access address in register as are forced to be 0, and then the 16-byte data is loaded from the memory to register qu. After the access is completed, the value in register as is incremented by the value in register ad.

Operation

```

1  add0[31:0] = qx[ 15: 0] * qy[ 15: 0]
2  add1[31:0] = qx[ 31: 16] * qy[ 31: 16]
3  ...
4  add7[31:0] = qx[127:112] * qy[127:112]
5  sum[40:0] = ACCX[39:0] + ad[31:0]d0[31:0] + ad[31:0]d1[31:0] + ... + ad[31:0]d7[31:0]
6  ACCX[39:0] = min(max(sum[40:0], -2^{39}), 2^{39}-1)
7
8  qu[127:0] = load128({as[31:4], 4{0}})
9  as[31:0] = as[31:0] + ad[31:0]
```

1.8.138 EE.VMULAS.S16.ACCX.LD.XP.QUP

Instruction Word

101100	qu[2:1]	qy[0]	qs0[2:0]	qu[0]	qs1[2:0]	qx[1:0]	qy[2:1]	ad[3:0]	as[3:0]	111	qx[2]
--------	---------	-------	----------	-------	----------	---------	---------	---------	---------	-----	-------

Assembler Syntax

EE.VMULAS.S16.ACCX.LD.XP.QUP qu, as, ad, qx, qy, qs0, qs1

Description

This instruction divides registers qx and qy into 8 data segments by 16 bits. Then, it performs a signed multiply-accumulate operation on the 8 sets of segments respectively. The accumulated result is added to the value in special register ACCX. Then, the sum obtained is saturated and then stored in ACCX.

During the operation, the lower 4 bits of the access address in register as are forced to be 0, and then the 16-byte data is loaded from the memory to register qu. After the access is completed, the value in register as is incremented by the value in register ad.

At the same time, this instruction also obtains 16-byte unaligned data by concatenating and shifting consecutive aligned data stored in the two registers qs0 and qs1 and stores it to qs0. The shift byte is stored in special register SAR_BYTE.

Operation

```

1  add0[31:0] = qx[ 15: 0] * qy[ 15: 0]
2  add1[31:0] = qx[ 31: 16] * qy[ 31: 16]
3  ...
4  add7[31:0] = qx[127:112] * qy[127:112]
5  sum[40:0] = ACCX[39:0] + ad[31:0]d0[31:0] + ad[31:0]d1[31:0] + ... + ad[31:0]d7[31:0]
6  ACCX[39:0] = min(max(sum[40:0], -2^{39}), 2^{39}-1)
7
8  qu[127:0] = load128({as[31:4], 4{0}})
9  as[31:0] = as[31:0] + ad[31:0]
10 qs0[127:0] = {qs1[127: 0], qs0[127: 0]} >> {SAR_BYTE[3:0] << 3}

```

1.8.139 EE.VMULAS.S16.QACC

Instruction Word

000110100	qy[2]	1	qy[1:0]	qx[2:0]	10000100
-----------	-------	---	---------	---------	----------

Assembler Syntax

EE.VMULAS.S16.QACC qx, qy

Description

This instruction divides registers `qx` and `qy` into 8 data segments by 16 bits. Then, the signed multiplication result of 8 sets of segments is added to the corresponding 40-bit data segment in special registers `QACC_H` and `QACC_L` respectively. The calculated result is saturated to a 40-bit signed number and then stored to the corresponding 40-bit data segment in `QACC_H` and `QACC_L`.

Operation

```

1  QACC_L[ 39: 0] = min(max(QACC_L[ 39: 0] + qx[ 15: 0] * qy[ 15: 0], -2^{39}),
    2^{39}-1)
2  QACC_L[ 79: 40] = min(max(QACC_L[ 79: 40] + qx[ 31: 16] * qy[ 31: 16], -2^{39}),
    2^{39}-1)
3  QACC_L[119: 80] = min(max(QACC_L[119: 80] + qx[ 47: 32] * qy[ 47: 32], -2^{39}),
    2^{39}-1)
4  QACC_L[159:120] = min(max(QACC_L[159:120] + qx[ 63: 48] * qy[ 63: 48], -2^{39}),
    2^{39}-1)
5  QACC_H[ 39: 0] = min(max(QACC_H[ 39: 0] + qx[ 79: 64] * qy[ 79: 64], -2^{39}),
    2^{39}-1)
6  QACC_H[ 79: 40] = min(max(QACC_H[ 79: 40] + qx[ 95: 80] * qy[ 95: 80], -2^{39}),
    2^{39}-1)
7  QACC_H[119: 80] = min(max(QACC_H[119: 80] + qx[111: 96] * qy[111: 96], -2^{39}),
    2^{39}-1)
8  QACC_H[159:120] = min(max(QACC_H[159:120] + qx[127:112] * qy[127:112], -2^{39}),
    2^{39}-1)

```

1.8.140 EE.VMULAS.S16.QACC.LD.IP

Instruction Word

1111	imm16[5:4]	qu[2:1]	qy[0]	000	qu[0]	001	qx[1:0]	qy[2:1]	imm16[3:0]	as[3:0]	111	qx[2]
------	------------	---------	-------	-----	-------	-----	---------	---------	------------	---------	-----	-------

Assembler Syntax

EE.VMULAS.S16.QACC.LD.IP qu, as, imm16, qx, qy

Description

This instruction divides registers qx and qy into 8 data segments by 16 bits. Then, the signed multiplication result of 8 sets of segments is added to the corresponding 40-bit data segment in special registers QACC_H and QACC_L respectively. The calculated result is saturated to a 40-bit signed number and then stored to the corresponding 40-bit data segment in QACC_H and QACC_L.

During the operation, the lower 4 bits of the access address in register as are forced to be 0, and then the 16-byte data is loaded from the memory to register qu. After the access is completed, the value in register as is incremented by 6-bit sign-extended constant in the instruction code segment left-shifted by 4.

Operation

```

1  QACC_L[ 39: 0] = min(max(QACC_L[ 39: 0] + qx[ 15: 0] * qy[ 15: 0], -2^{39}),
2  2^{39}-1)
3  QACC_L[ 79: 40] = min(max(QACC_L[ 79: 40] + qx[ 31: 16] * qy[ 31: 16], -2^{39}),
4  2^{39}-1)
5  QACC_L[119: 80] = min(max(QACC_L[119: 80] + qx[ 47: 32] * qy[ 47: 32], -2^{39}),
6  2^{39}-1)
7  QACC_L[159:120] = min(max(QACC_L[159:120] + qx[ 63: 48] * qy[ 63: 48], -2^{39}),
8  2^{39}-1)
9  QACC_H[ 39: 0] = min(max(QACC_H[ 39: 0] + qx[ 79: 64] * qy[ 79: 64], -2^{39}),
10 2^{39}-1)
11 QACC_H[ 79: 40] = min(max(QACC_H[ 79: 40] + qx[ 95: 80] * qy[ 95: 80], -2^{39}),
12 2^{39}-1)
13 QACC_H[119: 80] = min(max(QACC_H[119: 80] + qx[111: 96] * qy[111: 96], -2^{39}),
14 2^{39}-1)
15 QACC_H[159:120] = min(max(QACC_H[159:120] + qx[127:112] * qy[127:112], -2^{39}),
16 2^{39}-1)
17
18 qu[127:0] = load128({as[31:4],4{0}})
19 as[31:0] = as[31:0] + {22{imm16[5]},imm16[5:0],4{0}}

```

1.8.141 EE.VMULAS.S16.QACC.LD.IP.QUP

Instruction Word

0001	imm16[5:4]	qu[2:1]	qy[0]	qs0[2:0]	qu[0]	qs1[2:0]	qx[1:0]	qy[2:1]	imm16[3:0]	as[3:0]	111	qx[2]
------	------------	---------	-------	----------	-------	----------	---------	---------	------------	---------	-----	-------

Assembler Syntax

EE.VMULAS.S16.QACC.LD.IP.QUP qu, as, imm16, qx, qy, qs0, qs1

Description

This instruction divides registers qx and qy into 8 data segments by 16 bits. Then, the signed multiplication result of 8 sets of segments is added to the corresponding 40-bit data segment in special registers QACC_H and QACC_L respectively. The calculated result is saturated to a 40-bit signed number and then stored to the corresponding 40-bit data segment in QACC_H and QACC_L.

During the operation, the lower 4 bits of the access address in register as are forced to be 0, and then the 16-byte data is loaded from the memory to register qu. After the access is completed, the value in register as is incremented by 6-bit sign-extended constant in the instruction code segment left-shifted by 4.

At the same time, this instruction also obtains 16-byte unaligned data by concatenating and shifting consecutive aligned data stored in the two registers qs0 and qs1 and stores it to qs0. The shift byte is stored in special register SAR_BYTE.

Operation

```

1  QACC_L[ 39: 0] = min(max(QACC_L[ 39: 0] + qx[ 15: 0] * qy[ 15: 0], -2^{39}),
2     2^{39}-1)
3  QACC_L[ 79: 40] = min(max(QACC_L[ 79: 40] + qx[ 31: 16] * qy[ 31: 16], -2^{39}),
4     2^{39}-1)
5  QACC_L[119: 80] = min(max(QACC_L[119: 80] + qx[ 47: 32] * qy[ 47: 32], -2^{39}),
6     2^{39}-1)
7  QACC_L[159:120] = min(max(QACC_L[159:120] + qx[ 63: 48] * qy[ 63: 48], -2^{39}),
8     2^{39}-1)
9  QACC_H[ 39: 0] = min(max(QACC_H[ 39: 0] + qx[ 79: 64] * qy[ 79: 64], -2^{39}),
10     2^{39}-1)
11 QACC_H[ 79: 40] = min(max(QACC_H[ 79: 40] + qx[ 95: 80] * qy[ 95: 80], -2^{39}),
12     2^{39}-1)
13 QACC_H[119: 80] = min(max(QACC_H[119: 80] + qx[111: 96] * qy[111: 96], -2^{39}),
14     2^{39}-1)
15 QACC_H[159:120] = min(max(QACC_H[159:120] + qx[127:112] * qy[127:112], -2^{39}),
16     2^{39}-1)
17
18 qu[127:0] = load128({as[31:4],4{0}})
19 as[31:0] = as[31:0] + {22{imm16[5]},imm16[5:0],4{0}}
20 qs0[127:0] = {qs1[127:0], qs0[127:0]} >> {SAR_BYTE[3:0] << 3}

```

1.8.142 EE.VMULAS.S16.QACC.LD.XP

Instruction Word

111100	qu[2:1]	qy[0]	001	qu[0]	001	qx[1:0]	qy[2:1]	ad[3:0]	as[3:0]	111	qx[2]
--------	---------	-------	-----	-------	-----	---------	---------	---------	---------	-----	-------

Assembler Syntax

EE.VMULAS.S16.QACC.LD.XP qu, as, ad, qx, qy

Description

This instruction divides registers qx and qy into 8 data segments by 16 bits. Then, the signed multiplication result of 8 sets of segments is added to the corresponding 40-bit data segment in special registers QACC_H and QACC_L respectively. The calculated result is saturated to a 40-bit signed number and then stored to the corresponding 40-bit data segment in QACC_H and QACC_L.

During the operation, the lower 4 bits of the access address in register as are forced to be 0, and then the 16-byte data is loaded from the memory to register qu. After the access is completed, the value in register as is incremented by the value in register ad.

Operation

```

1  QACC_L[ 39: 0] = min(max(QACC_L[ 39: 0] + qx[ 15: 0] * qy[ 15: 0], -2^{39}),
2  2^{39}-1)
3  QACC_L[ 79: 40] = min(max(QACC_L[ 79: 40] + qx[ 31: 16] * qy[ 31: 16], -2^{39}),
4  2^{39}-1)
5  QACC_L[119: 80] = min(max(QACC_L[119: 80] + qx[ 47: 32] * qy[ 47: 32], -2^{39}),
6  2^{39}-1)
7  QACC_L[159:120] = min(max(QACC_L[159:120] + qx[ 63: 48] * qy[ 63: 48], -2^{39}),
8  2^{39}-1)
9  QACC_H[ 39: 0] = min(max(QACC_H[ 39: 0] + qx[ 79: 64] * qy[ 79: 64], -2^{39}),
10 2^{39}-1)
11 QACC_H[ 79: 40] = min(max(QACC_H[ 79: 40] + qx[ 95: 80] * qy[ 95: 80], -2^{39}),
12 2^{39}-1)
13 QACC_H[119: 80] = min(max(QACC_H[119: 80] + qx[111: 96] * qy[111: 96], -2^{39}),
14 2^{39}-1)
15 QACC_H[159:120] = min(max(QACC_H[159:120] + qx[127:112] * qy[127:112], -2^{39}),
16 2^{39}-1)
17
18 qu[127:0] = load128({as[31:4],4{0}})
19 as[31:0] = as[31:0] + ad[31:0]

```

1.8.143 EE.VMULAS.S16.QACC.LD.XP.QUP

Instruction Word

101101	qu[2:1]	qy[0]	qs0[2:0]	qu[0]	qs1[2:0]	qx[1:0]	qy[2:1]	ad[3:0]	as[3:0]	111	qx[2]
--------	---------	-------	----------	-------	----------	---------	---------	---------	---------	-----	-------

Assembler Syntax

EE.VMULAS.S16.QACC.LD.XP.QUP qu, as, ad, qx, qy, qs0, qs1

Description

This instruction divides registers qx and qy into 8 data segments by 16 bits. Then, the signed multiplication result of 8 sets of segments is added to the corresponding 40-bit data segment in special registers QACC_H and QACC_L respectively. The calculated result is saturated to a 40-bit signed number and then stored to the corresponding 40-bit data segment in QACC_H and QACC_L.

During the operation, the lower 4 bits of the access address in register as are forced to be 0, and then the 16-byte data is loaded from the memory to register qu. After the access is completed, the value in register as is incremented by the value in register ad.

At the same time, this instruction also obtains 16-byte unaligned data by concatenating and shifting consecutive aligned data stored in the two registers qs0 and qs1 and stores it to qs0. The shift byte is stored in special register SAR_BYTE.

Operation

```

1  QACC_L[ 39: 0] = min(max(QACC_L[ 39: 0] + qx[ 15: 0] * qy[ 15: 0], -2^{39}),
2     2^{39}-1)
3  QACC_L[ 79: 40] = min(max(QACC_L[ 79: 40] + qx[ 31: 16] * qy[ 31: 16], -2^{39}),
4     2^{39}-1)
5  QACC_L[119: 80] = min(max(QACC_L[119: 80] + qx[ 47: 32] * qy[ 47: 32], -2^{39}),
6     2^{39}-1)
7  QACC_L[159:120] = min(max(QACC_L[159:120] + qx[ 63: 48] * qy[ 63: 48], -2^{39}),
8     2^{39}-1)
9  QACC_H[ 39: 0] = min(max(QACC_H[ 39: 0] + qx[ 79: 64] * qy[ 79: 64], -2^{39}),
10     2^{39}-1)
11 QACC_H[ 79: 40] = min(max(QACC_H[ 79: 40] + qx[ 95: 80] * qy[ 95: 80], -2^{39}),
12     2^{39}-1)
13 QACC_H[119: 80] = min(max(QACC_H[119: 80] + qx[111: 96] * qy[111: 96], -2^{39}),
14     2^{39}-1)
15 QACC_H[159:120] = min(max(QACC_H[159:120] + qx[127:112] * qy[127:112], -2^{39}),
16     2^{39}-1)
17
18 qu[127:0] = load128({as[31:4],4{0}})
19 as[31:0] = as[31:0] + ad[31:0]
20 qs0[127:0] = {qs1[127:0], qs0[127:0]} >> {SAR_BYTE[3:0] << 3}

```

1.8.144 EE.VMULAS.S16.QACC.LDBC.INCP

Instruction Word

100	qu[2]	0111	qu[1]	qy[2]	qu[0]	qy[1:0]	qx[2:0]	as[3:0]	0100
-----	-------	------	-------	-------	-------	---------	---------	---------	------

Assembler Syntax

EE.VMULAS.S16.QACC.LDBC.INCP qu, as, qx, qy

Description

This instruction divides registers qx and qy into 8 data segments by 16 bits. Then, the signed multiplication result of 8 sets of segments is added to the corresponding 40-bit data segment in special registers QACC_H and QACC_L respectively. The calculated result is saturated to a 40-bit signed number and then stored to the corresponding 40-bit data segment in QACC_H and QACC_L.

At the same time, this instruction forces the lower 1 bit of the access address in register as to 0, loads 16-bit data from memory, and broadcasts it to the eight 16-bit data segments in register qu. After the access, the value in register as is incremented by 2.

Operation

```

1  QACC_L[ 39: 0] = min(max(QACC_L[ 39: 0] + qx[ 15: 0] * qy[ 15: 0], -2^{39}),
2  2^{39}-1)
3  QACC_L[ 79: 40] = min(max(QACC_L[ 79: 40] + qx[ 31: 16] * qy[ 31: 16], -2^{39}),
4  2^{39}-1)
5  QACC_L[119: 80] = min(max(QACC_L[119: 80] + qx[ 47: 32] * qy[ 47: 32], -2^{39}),
6  2^{39}-1)
7  QACC_L[159:120] = min(max(QACC_L[159:120] + qx[ 63: 48] * qy[ 63: 48], -2^{39}),
8  2^{39}-1)
9  QACC_H[ 39: 0] = min(max(QACC_H[ 39: 0] + qx[ 79: 64] * qy[ 79: 64], -2^{39}),
10 2^{39}-1)
11 QACC_H[ 79: 40] = min(max(QACC_H[ 79: 40] + qx[ 95: 80] * qy[ 95: 80], -2^{39}),
12 2^{39}-1)
13 QACC_H[119: 80] = min(max(QACC_H[119: 80] + qx[111: 96] * qy[111: 96], -2^{39}),
14 2^{39}-1)
15 QACC_H[159:120] = min(max(QACC_H[159:120] + qx[127:112] * qy[127:112], -2^{39}),
16 2^{39}-1)
17
18 qu[127:0] = {8{load16({as[31:1],1{0}})}}
19 as[31:0] = as[31:0] + 2

```

1.8.145 EE.VMULAS.S16.QACC.LDBC.INCP.QUP

Instruction Word

111000	qu[2:1]	qy[0]	qs0[2:0]	qu[0]	qs1[2:0]	qx[1:0]	qy[2:1]	1000	as[3:0]	111	qx[2]
--------	---------	-------	----------	-------	----------	---------	---------	------	---------	-----	-------

Assembler Syntax

EE.VMULAS.S16.QACC.LDBC.INCP.QUP qu, as, qx, qy, qs0, qs1

Description

This instruction divides registers qx and qy into 8 data segments by 16 bits. Then, the signed multiplication result of 8 sets of segments is added to the corresponding 40-bit data segment in special registers QACC_H and QACC_L respectively. The calculated result is saturated to a 40-bit signed number and then stored to the corresponding 40-bit data segment in QACC_H and QACC_L.

At the same time, this instruction forces the lower 1 bit of the access address in register as to 0, loads 16-bit data from memory, and broadcasts it to the eight 16-bit data segments in register qu. After the access, the value in register as is incremented by 2.

At the same time, this instruction also obtains 16-byte unaligned data by concatenating and shifting consecutive aligned data stored in the two registers qs0 and qs1 and stores it to qs0. The shift byte is stored in special register SAR_BYTE.

Operation

```

1  QACC_L[ 39: 0] = min(max(QACC_L[ 39: 0] + qx[ 15: 0] * qy[ 15: 0], -2^{39}),
2  2^{39}-1)
3  QACC_L[ 79: 40] = min(max(QACC_L[ 79: 40] + qx[ 31: 16] * qy[ 31: 16], -2^{39}),
4  2^{39}-1)
5  QACC_L[119: 80] = min(max(QACC_L[119: 80] + qx[ 47: 32] * qy[ 47: 32], -2^{39}),
6  2^{39}-1)
7  QACC_L[159:120] = min(max(QACC_L[159:120] + qx[ 63: 48] * qy[ 63: 48], -2^{39}),
8  2^{39}-1)
9  QACC_H[ 39: 0] = min(max(QACC_H[ 39: 0] + qx[ 79: 64] * qy[ 79: 64], -2^{39}),
10 2^{39}-1)
11 QACC_H[ 79: 40] = min(max(QACC_H[ 79: 40] + qx[ 95: 80] * qy[ 95: 80], -2^{39}),
12 2^{39}-1)
13 QACC_H[119: 80] = min(max(QACC_H[119: 80] + qx[111: 96] * qy[111: 96], -2^{39}),
14 2^{39}-1)
15 QACC_H[159:120] = min(max(QACC_H[159:120] + qx[127:112] * qy[127:112], -2^{39}),
16 2^{39}-1)
17
18 qu[127:0] = {8{load16({as[31:1], 1{0}})}}
19 as[31:0] = as[31:0] + 2
20 qs0[127:0] = {qs1[127:0], qs0[127:0]} >> {SAR_BYTE[3:0] << 3}

```

1.8.146 EE.VMULAS.S8.ACCX

Instruction Word

000110100	qy[2]	0	qy[1:0]	qx[2:0]	11000100
-----------	-------	---	---------	---------	----------

Assembler Syntax

EE.VMULAS.S8.ACCX qx, qy

Description

This instruction divides registers qx and qy into 16 data segments by 8 bits. Then, it performs a signed multiply-accumulate operation on the 16 sets of segments respectively. The accumulated result is added to the value in special register ACCX. Then, the sum obtained is saturated and then stored in ACCX.

Operation

```

1  add0[15:0] = qx[ 7: 0] * qy[ 7: 0]
2  add1[15:0] = qx[15: 8] * qy[15: 8]
3  ...
4  add15[15:0] = qx[127:120] * qy[127:120]
5  sum[40:0] = ACCX[39:0] + ad[31:0]d0[15:0] + ad[31:0]d1[15:0] + ... + ad[31:0]d15[15:0]
6
7  ACCX[39:0] = min(max(sum[40:0], -2^{39}), 2^{39}-1)

```

1.8.147 EE.VMULAS.S8.ACCX.LD.IP

Instruction Word

1111	imm16[5:4]	qu[2:1]	qy[0]	000	qu[0]	010	qx[1:0]	qy[2:1]	imm16[3:0]	as[3:0]	111	qx[2]
------	------------	---------	-------	-----	-------	-----	---------	---------	------------	---------	-----	-------

Assembler Syntax

EE.VMULAS.S8.ACCX.LD.IP qu, as, -512..496, qx, qy

Description

This instruction divides registers qx and qy into 16 data segments by 8 bits. Then, it performs a signed multiply-accumulate operation on the 16 sets of segments respectively. The accumulated result is added to the value in special register ACCX. Then, the sum obtained is saturated and then stored in ACCX.

During the operation, the lower 4 bits of the access address in register as are forced to be 0, and then the 16-byte data is loaded from the memory to register qu. After the access is completed, the value in register as is incremented by 6-bit sign-extended constant in the instruction code segment left-shifted by 4.

Operation

```

1  add0[15:0] = qx[ 7: 0] * qy[ 7: 0]
2  add1[15:0] = qx[15: 8] * qy[15: 8]
3  ...
4  add15[15:0] = qx[127:120] * qy[127:120]
5  sum[40:0] = ACCX[39:0] + ad[31:0]d0[15:0] + ad[31:0]d1[15:0] + ... + ad[31:0]d15[15:0]
6
7  qu[127:0] = load128({as[31:4],4{0}})
8  as[31:0] = as[31:0] + {20{imm16[7]},imm16[7:0],4{0}}
```

1.8.148 EE.VMULAS.S8.ACCX.LD.IP.QUP

Instruction Word

0010	imm16[5:4]	qu[2:1]	qy[0]	qs0[2:0]	qu[0]	qs1[2:0]	qx[1:0]	qy[2:1]	imm16[3:0]	as[3:0]	111	qx[2]
------	------------	---------	-------	----------	-------	----------	---------	---------	------------	---------	-----	-------

Assembler Syntax

EE.VMULAS.S8.ACCX.LD.IP.QUP qu, as, imm16, qx, qy, qs0, qs1

Description

This instruction divides registers qx and qy into 16 data segments by 8 bits. Then, it performs a signed multiply-accumulate operation on the 16 sets of segments respectively. The accumulated result is added to the value in special register ACCX. Then, the sum obtained is saturated and then stored in ACCX.

During the operation, the lower 4 bits of the access address in register as are forced to be 0, and then the 16-byte data is loaded from the memory to register qu. After the access is completed, the value in register as is incremented by 6-bit sign-extended constant in the instruction code segment left-shifted by 4.

At the same time, this instruction also obtains 16-byte unaligned data by concatenating and shifting consecutive aligned data stored in the two registers qs0 and qs1 and stores it to qs0. The shift byte is stored in special register SAR_BYTE.

Operation

```

1  add0[15:0] = qx[ 7: 0] * qy[ 7: 0]
2  add1[15:0] = qx[15: 8] * qy[15: 8]
3  ...
4  add15[15:0] = qx[127:120] * qy[127:120]
5  sum[40:0] = ACCX[39:0] + ad[31:0]d0[15:0] + ad[31:0]d1[15:0] + ... + ad[31:0]d15[15:0]
6
7  qu[127:0] = load128({as[31:4],4{0}})
8  as[31:0] = as[31:0] + {20{imm16[7]},imm16[7:0],4{0}}
9  qs0[127:0] = {qs1[127:0], qs0[127:0]} >> {SAR_BYTE[3:0] << 3}

```

1.8.149 EE.VMULAS.S8.ACCX.LD.XP

Instruction Word

111100	qu[2:1]	qy[0]	001	qu[0]	010	qx[1:0]	qy[2:1]	ad[3:0]	as[3:0]	111	qx[2]
--------	---------	-------	-----	-------	-----	---------	---------	---------	---------	-----	-------

Assembler Syntax

EE.VMULAS.S8.ACCX.LD.XP qu, as, ad, qx, qy

Description

This instruction divides registers qx and qy into 16 data segments by 8 bits. Then, it performs a signed multiply-accumulate operation on the 16 sets of segments respectively. The accumulated result is added to the value in special register ACCX. Then, the sum obtained is saturated and then stored in ACCX.

During the operation, the lower 4 bits of the access address in register as are forced to be 0, and then the 16-byte data is loaded from the memory to register qu. After the access is completed, the value in register as is incremented by the value in register ad.

Operation

```

1  add0[15:0] = qx[ 7: 0] * qy[ 7: 0]
2  add1[15:0] = qx[15: 8] * qy[15: 8]
3  ...
4  add15[15:0] = qx[127:120] * qy[127:120]
5  sum[40:0] = ACCX[39:0] + ad[31:0]d0[15:0] + ad[31:0]d1[15:0] + ... + ad[31:0]d15[15:0]
6  ACCX[39:0] = min(max(sum[40:0], -2^{39}), 2^{39}-1)
7
8  qu[127:0] = load128({as[31:4],4{0}})
9  as[31:0] = as[31:0] + ad[31:0]

```

1.8.150 EE.VMULAS.S8.ACCX.LD.XP.QUP

Instruction Word

101110	qu[2:1]	qy[0]	qs0[2:0]	qu[0]	qs1[2:0]	qx[1:0]	qy[2:1]	ad[3:0]	as[3:0]	111	qx[2]
--------	---------	-------	----------	-------	----------	---------	---------	---------	---------	-----	-------

Assembler Syntax

EE.VMULAS.S8.ACCX.LD.XP.QUP qu, as, ad, qx, qy, qs0, qs1

Description

This instruction divides registers qx and qy into 16 data segments by 8 bits. Then, it performs a signed multiply-accumulate operation on the 16 sets of segments respectively. The accumulated result is added to the value in special register ACCX. Then, the sum obtained is saturated and then stored in ACCX.

During the operation, the lower 4 bits of the access address in register as are forced to be 0, and then the 16-byte data is loaded from the memory to register qu. After the access is completed, the value in register as is incremented by the value in register ad.

At the same time, this instruction also obtains 16-byte unaligned data by concatenating and shifting consecutive aligned data stored in the two registers qs0 and qs1 and stores it to qs0. The shift byte is stored in special register SAR_BYTE.

Operation

```

1  add0[15:0] = qx[ 7: 0] * qy[ 7: 0]
2  add1[15:0] = qx[15: 8] * qy[15: 8]
3  ...
4  add15[15:0] = qx[127:120] * qy[127:120]
5  sum[40:0] = ACCX[39:0] + ad[31:0]d0[15:0] + ad[31:0]d1[15:0] + ... + ad[31:0]d15[15:0]
6  ACCX[39:0] = min(max(sum[40:0], -2^{39}), 2^{39}-1)
7
8  qu[127:0] = load128({as[31:4],4{0}})
9  as[31:0] = as[31:0] + ad[31:0]
10 qs0[127:0] = {qs1[127: 0], qs0[127: 0]} >> {SAR_BYTE[3:0] << 3}

```

1.8.151 EE.VMULAS.S8.QACC

Instruction Word

000110100	qy[2]	1	qy[1:0]	qx[2:0]	11000100
-----------	-------	---	---------	---------	----------

Assembler Syntax

EE.VMULAS.S8.QACC qx, qy

Description

This instruction divides registers qx and qy into 16 data segments by 8 bits. Then, the signed multiplication result of the 16 sets of segments is added to the corresponding 20-bit data segment in special registers QACC_H and QACC_L respectively. The calculated result is saturated to a 20-bit signed number and then stored to the corresponding 20-bit data segment in QACC_H and QACC_L.

Operation

```

1  QACC_L[ 19: 0] = min(max(QACC_L[ 19: 0] + qx[ 7: 0] * qy[ 7: 0], -2^{19}),
   2^{19}-1)
2  QACC_L[ 39: 20] = min(max(QACC_L[ 39: 20] + qx[ 15: 8] * qy[ 15: 8], -2^{19}),
   2^{19}-1)
3  QACC_L[ 59: 40] = min(max(QACC_L[ 59: 40] + qx[ 23: 16] * qy[ 23: 16], -2^{19}),
   2^{19}-1)
4  QACC_L[ 79: 60] = min(max(QACC_L[ 79: 60] + qx[ 31: 24] * qy[ 31: 24], -2^{19}),
   2^{19}-1)
5  QACC_L[ 99: 80] = min(max(QACC_L[ 99: 80] + qx[ 39: 32] * qy[ 39: 32], -2^{19}),
   2^{19}-1)
6  QACC_L[119:100] = min(max(QACC_L[119:100] + qx[ 47: 40] * qy[ 47: 40], -2^{19}),
   2^{19}-1)
7  QACC_L[139:120] = min(max(QACC_L[139:120] + qx[ 55: 48] * qy[ 55: 48], -2^{19}),
   2^{19}-1)
8  QACC_L[159:140] = min(max(QACC_L[159:140] + qx[ 63: 56] * qy[ 63: 56], -2^{19}),
   2^{19}-1)
9  QACC_H[ 19: 0] = min(max(QACC_H[ 19: 0] + qx[ 71: 64] * qy[ 71: 64], -2^{19}),
   2^{19}-1)
10 QACC_H[ 39: 20] = min(max(QACC_H[ 39: 20] + qx[ 79: 72] * qy[ 79: 72], -2^{19}),
   2^{19}-1)
11 QACC_H[ 59: 40] = min(max(QACC_H[ 59: 40] + qx[ 87: 80] * qy[ 87: 80], -2^{19}),
   2^{19}-1)
12 QACC_H[ 79: 60] = min(max(QACC_H[ 79: 60] + qx[ 95: 88] * qy[ 95: 88], -2^{19}),
   2^{19}-1)
13 QACC_H[ 99: 80] = min(max(QACC_H[ 99: 80] + qx[103: 96] * qy[103: 96], -2^{19}),
   2^{19}-1)
14 QACC_H[119:100] = min(max(QACC_H[119:100] + qx[111:104] * qy[111:104], -2^{19}),
   2^{19}-1)
15 QACC_H[139:120] = min(max(QACC_H[139:120] + qx[119:112] * qy[119:112], -2^{19}),
   2^{19}-1)
16 QACC_H[159:140] = min(max(QACC_H[159:140] + qx[127:120] * qy[127:120], -2^{19}),
   2^{19}-1)

```

1.8.152 EE.VMULAS.S8.QACC.LD.IP

Instruction Word

1111	imm16[5:4]	qu[2:1]	qy[0]	000	qu[0]	011	qx[1:0]	qy[2:1]	imm16[3:0]	as[3:0]	111	qx[2]
------	------------	---------	-------	-----	-------	-----	---------	---------	------------	---------	-----	-------

This instruction divides registers `qx` and `qy` into 16 data segments by 8 bits. Then, the signed multiplication result of the 16 sets of segments is added to the corresponding 20-bit data segment in special registers `QACC_H` and `QACC_L` respectively. The calculated result is saturated to a 20-bit signed number and then stored to the corresponding 20-bit data segment in `QACC_H` and `QACC_L`.

During the operation, the lower 4 bits of the access address in register `as` are forced to be 0, and then the 16-byte data is loaded from the memory to register `qu`. After the access is completed, the value in register `as` is incremented by 6-bit sign-extended constant in the instruction code segment left-shifted by 4.

Assembler Syntax

EE.VMULAS.S8.QACC.LD.IP `qu, as, imm16, qx, qy`

Description

Operation

```

1  QACC_L[ 19: 0] = min(max(QACC_L[ 19: 0] + qx[ 7: 0] * qy[ 7: 0], -2^{19}),
   2^{19}-1)
2  QACC_L[ 39: 20] = min(max(QACC_L[ 39: 20] + qx[ 15: 8] * qy[ 15: 8], -2^{19}),
   2^{19}-1)
3  QACC_L[ 59: 40] = min(max(QACC_L[ 59: 40] + qx[ 23: 16] * qy[ 23: 16], -2^{19}),
   2^{19}-1)
4  QACC_L[ 79: 60] = min(max(QACC_L[ 79: 60] + qx[ 31: 24] * qy[ 31: 24], -2^{19}),
   2^{19}-1)
5  QACC_L[ 99: 80] = min(max(QACC_L[ 99: 80] + qx[ 39: 32] * qy[ 39: 32], -2^{19}),
   2^{19}-1)
6  QACC_L[119:100] = min(max(QACC_L[119:100] + qx[ 47: 40] * qy[ 47: 40], -2^{19}),
   2^{19}-1)
7  QACC_L[139:120] = min(max(QACC_L[139:120] + qx[ 55: 48] * qy[ 55: 48], -2^{19}),
   2^{19}-1)
8  QACC_L[159:140] = min(max(QACC_L[159:140] + qx[ 63: 56] * qy[ 63: 56], -2^{19}),
   2^{19}-1)
9  QACC_H[ 19: 0] = min(max(QACC_H[ 19: 0] + qx[ 71: 64] * qy[ 71: 64], -2^{19}),
   2^{19}-1)
10 QACC_H[ 39: 20] = min(max(QACC_H[ 39: 20] + qx[ 79: 72] * qy[ 79: 72], -2^{19}),
   2^{19}-1)
11 QACC_H[ 59: 40] = min(max(QACC_H[ 59: 40] + qx[ 87: 80] * qy[ 87: 80], -2^{19}),
   2^{19}-1)
12 QACC_H[ 79: 60] = min(max(QACC_H[ 79: 60] + qx[ 95: 88] * qy[ 95: 88], -2^{19}),
   2^{19}-1)
13 QACC_H[ 99: 80] = min(max(QACC_H[ 99: 80] + qx[103: 96] * qy[103: 96], -2^{19}),
   2^{19}-1)
14 QACC_H[119:100] = min(max(QACC_H[119:100] + qx[111:104] * qy[111:104], -2^{19}),
   2^{19}-1)
15 QACC_H[139:120] = min(max(QACC_H[139:120] + qx[119:112] * qy[119:112], -2^{19}),
   2^{19}-1)
16 QACC_H[159:140] = min(max(QACC_H[159:140] + qx[127:120] * qy[127:120], -2^{19}),
   2^{19}-1)
17
18 qu[127:0] = load128({as[31:4],4{0}})

```

¹⁹ $as[31:0] = as[31:0] + \{22\{imm16[5]\}, imm16[5:0], 4\{0\}\}$

1.8.153 EE.VMULAS.S8.QACC.LD.IP.QUP

Instruction Word

0011	imm16[5:4]	qu[2:1]	qy[0]	qs0[2:0]	qu[0]	qs1[2:0]	qx[1:0]	qy[2:1]	imm16[3:0]	as[3:0]	111	qx[2]
------	------------	---------	-------	----------	-------	----------	---------	---------	------------	---------	-----	-------

Assembler Syntax

EE.VMULAS.S8.QACC.LD.IP.QUP qu, as, imm16, qx, qy, qs0, qs1

Description

This instruction divides registers qx and qy into 16 data segments by 8 bits. Then, the signed multiplication result of the 16 sets of segments is added to the corresponding 20-bit data segment in special registers QACC_H and QACC_L respectively. The calculated result is saturated to a 20-bit signed number and then stored to the corresponding 20-bit data segment in QACC_H and QACC_L.

During the operation, the lower 4 bits of the access address in register as are forced to be 0, and then the 16-byte data is loaded from the memory to register qu. After the access is completed, the value in register as is incremented by 6-bit sign-extended constant in the instruction code segment left-shifted by 4.

At the same time, this instruction also obtains 16-byte unaligned data by concatenating and shifting the two registers qs0 and qs1 that store consecutive aligned data and stores it to qs0. The shift byte is stored in special register SAR_BYTE.

Operation

```

1  QACC_L[ 19: 0] = min(max(QACC_L[ 19: 0] + qx[ 7: 0] * qy[ 7: 0], -2^{19}),
2  2^{19}-1)
3  QACC_L[ 39: 20] = min(max(QACC_L[ 39: 20] + qx[ 15: 8] * qy[ 15: 8], -2^{19}),
4  2^{19}-1)
5  QACC_L[ 59: 40] = min(max(QACC_L[ 59: 40] + qx[ 23: 16] * qy[ 23: 16], -2^{19}),
6  2^{19}-1)
7  QACC_L[ 79: 60] = min(max(QACC_L[ 79: 60] + qx[ 31: 24] * qy[ 31: 24], -2^{19}),
8  2^{19}-1)
9  QACC_L[ 99: 80] = min(max(QACC_L[ 99: 80] + qx[ 39: 32] * qy[ 39: 32], -2^{19}),
10 2^{19}-1)
11 QACC_L[119:100] = min(max(QACC_L[119:100] + qx[ 47: 40] * qy[ 47: 40], -2^{19}),
12 2^{19}-1)
13 QACC_L[139:120] = min(max(QACC_L[139:120] + qx[ 55: 48] * qy[ 55: 48], -2^{19}),
14 2^{19}-1)
15 QACC_L[159:140] = min(max(QACC_L[159:140] + qx[ 63: 56] * qy[ 63: 56], -2^{19}),
16 2^{19}-1)
17 QACC_H[ 19: 0] = min(max(QACC_H[ 19: 0] + qx[ 71: 64] * qy[ 71: 64], -2^{19}),
18 2^{19}-1)
19 QACC_H[ 39: 20] = min(max(QACC_H[ 39: 20] + qx[ 79: 72] * qy[ 79: 72], -2^{19}),
20 2^{19}-1)
21 QACC_H[ 59: 40] = min(max(QACC_H[ 59: 40] + qx[ 87: 80] * qy[ 87: 80], -2^{19}),
22 2^{19}-1)
23 QACC_H[ 79: 60] = min(max(QACC_H[ 79: 60] + qx[ 95: 88] * qy[ 95: 88], -2^{19}),
24 2^{19}-1)
25 QACC_H[ 99: 80] = min(max(QACC_H[ 99: 80] + qx[103: 96] * qy[103: 96], -2^{19}),
26 2^{19}-1)
27 QACC_H[119:100] = min(max(QACC_H[119:100] + qx[111:104] * qy[111:104], -2^{19}),
28 2^{19}-1)
29 QACC_H[139:120] = min(max(QACC_H[139:120] + qx[119:112] * qy[119:112], -2^{19}),
30 2^{19}-1)

```

```
16 QACC_H[159:140] = min(max(QACC_H[159:140] + qx[127:120] * qy[127:120], -2{19}),  
17 2{19}-1)  
18 qu[127:0] = load128({as[31:4],4{0}})  
19 as[31:0] = as[31:0] + {22{imm16[5]},imm16[5:0],4{0}}  
20 qs0[127:0] = {qs1[127:0], qs0[127:0]} >> {SAR_BYTE[3:0] << 3}
```

1.8.154 EE.VMULAS.S8.QACC.LD.XP

Instruction Word

111100	qu[2:1]	qy[0]	001	qu[0]	011	qx[1:0]	qy[2:1]	ad[3:0]	as[3:0]	111	qx[2]
--------	---------	-------	-----	-------	-----	---------	---------	---------	---------	-----	-------

Assembler Syntax

EE.VMULAS.S8.QACC.LD.XP qu, as, ad, qx, qy

Description

This instruction divides registers qx and qy into 16 data segments by 8 bits. Then, the signed multiplication result of the 16 sets of segments is added to the corresponding 20-bit data segment in special registers QACC_H and QACC_L respectively. The calculated result is saturated to a 20-bit signed number and then stored to the corresponding 20-bit data segment in QACC_H and QACC_L.

During the operation, the lower 4 bits of the access address in register as are forced to be 0, and then the 16-byte data is loaded from the memory to register qu. After the access is completed, the value in register as is incremented by the value in register ad.

Operation

```

1  QACC_L[ 19: 0] = min(max(QACC_L[ 19: 0] + qx[ 7: 0] * qy[ 7: 0], -2^{19}),
2  2^{19}-1)
3  QACC_L[ 39: 20] = min(max(QACC_L[ 39: 20] + qx[ 15: 8] * qy[ 15: 8], -2^{19}),
4  2^{19}-1)
5  QACC_L[ 59: 40] = min(max(QACC_L[ 59: 40] + qx[ 23: 16] * qy[ 23: 16], -2^{19}),
6  2^{19}-1)
7  QACC_L[ 79: 60] = min(max(QACC_L[ 79: 60] + qx[ 31: 24] * qy[ 31: 24], -2^{19}),
8  2^{19}-1)
9  QACC_L[ 99: 80] = min(max(QACC_L[ 99: 80] + qx[ 39: 32] * qy[ 39: 32], -2^{19}),
10 2^{19}-1)
11 QACC_L[119:100] = min(max(QACC_L[119:100] + qx[ 47: 40] * qy[ 47: 40], -2^{19}),
12 2^{19}-1)
13 QACC_L[139:120] = min(max(QACC_L[139:120] + qx[ 55: 48] * qy[ 55: 48], -2^{19}),
14 2^{19}-1)
15 QACC_L[159:140] = min(max(QACC_L[159:140] + qx[ 63: 56] * qy[ 63: 56], -2^{19}),
16 2^{19}-1)
17 QACC_H[ 19: 0] = min(max(QACC_H[ 19: 0] + qx[ 71: 64] * qy[ 71: 64], -2^{19}),
18 2^{19}-1)
19 QACC_H[ 39: 20] = min(max(QACC_H[ 39: 20] + qx[ 79: 72] * qy[ 79: 72], -2^{19}),
20 2^{19}-1)
21 QACC_H[ 59: 40] = min(max(QACC_H[ 59: 40] + qx[ 87: 80] * qy[ 87: 80], -2^{19}),
22 2^{19}-1)
23 QACC_H[ 79: 60] = min(max(QACC_H[ 79: 60] + qx[ 95: 88] * qy[ 95: 88], -2^{19}),
24 2^{19}-1)
25 QACC_H[ 99: 80] = min(max(QACC_H[ 99: 80] + qx[103: 96] * qy[103: 96], -2^{19}),
26 2^{19}-1)
27 QACC_H[119:100] = min(max(QACC_H[119:100] + qx[111:104] * qy[111:104], -2^{19}),
28 2^{19}-1)
29 QACC_H[139:120] = min(max(QACC_H[139:120] + qx[119:112] * qy[119:112], -2^{19}),
30 2^{19}-1)
31 QACC_H[159:140] = min(max(QACC_H[159:140] + qx[127:120] * qy[127:120], -2^{19}),
32 2^{19}-1)

```

```
18  qu[127:0] = load128({as[31:4],4{0}})
19  as[31:0] = as[31:0] + ad[31:0]
```

1.8.155 EE.VMULAS.S8.QACC.LD.XP.QUP

Instruction Word

101111	qu[2:1]	qy[0]	qs0[2:0]	qu[0]	qs1[2:0]	qx[1:0]	qy[2:1]	ad[3:0]	as[3:0]	111	qx[2]
--------	---------	-------	----------	-------	----------	---------	---------	---------	---------	-----	-------

Assembler Syntax

EE.VMULAS.S8.QACC.LD.XP.QUP qu, as, ad, qx, qy, qs0, qs1

Description

This instruction divides registers qx and qy into 16 data segments by 8 bits. Then, the signed multiplication result of the 16 sets of segments is added to the corresponding 20-bit data segment in special registers QACC_H and QACC_L respectively. The calculated result is saturated to a 20-bit signed number and then stored to the corresponding 20-bit data segment in QACC_H and QACC_L.

During the operation, the lower 4 bits of the access address in register as are forced to be 0, and then the 16-byte data is loaded from the memory to register qu. After the access is completed, the value in register as is incremented by the value in register ad.

At the same time, this instruction also obtains 16-byte unaligned data by concatenating and shifting consecutive aligned data stored in the two registers qs0 and qs1 and stores it to qs0. The shift byte is stored in special register SAR_BYTE.

Operation

```

1  QACC_L[ 19: 0] = min(max(QACC_L[ 19: 0] + qx[ 7: 0] * qy[ 7: 0], -2^{19}),
2  2^{19}-1)
3  QACC_L[ 39: 20] = min(max(QACC_L[ 39: 20] + qx[ 15: 8] * qy[ 15: 8], -2^{19}),
4  2^{19}-1)
5  QACC_L[ 59: 40] = min(max(QACC_L[ 59: 40] + qx[ 23: 16] * qy[ 23: 16], -2^{19}),
6  2^{19}-1)
7  QACC_L[ 79: 60] = min(max(QACC_L[ 79: 60] + qx[ 31: 24] * qy[ 31: 24], -2^{19}),
8  2^{19}-1)
9  QACC_L[ 99: 80] = min(max(QACC_L[ 99: 80] + qx[ 39: 32] * qy[ 39: 32], -2^{19}),
10 2^{19}-1)
11 QACC_L[119:100] = min(max(QACC_L[119:100] + qx[ 47: 40] * qy[ 47: 40], -2^{19}),
12 2^{19}-1)
13 QACC_L[139:120] = min(max(QACC_L[139:120] + qx[ 55: 48] * qy[ 55: 48], -2^{19}),
14 2^{19}-1)
15 QACC_L[159:140] = min(max(QACC_L[159:140] + qx[ 63: 56] * qy[ 63: 56], -2^{19}),
16 2^{19}-1)
17 QACC_H[ 19: 0] = min(max(QACC_H[ 19: 0] + qx[ 71: 64] * qy[ 71: 64], -2^{19}),
18 2^{19}-1)
19 QACC_H[ 39: 20] = min(max(QACC_H[ 39: 20] + qx[ 79: 72] * qy[ 79: 72], -2^{19}),
20 2^{19}-1)
21 QACC_H[ 59: 40] = min(max(QACC_H[ 59: 40] + qx[ 87: 80] * qy[ 87: 80], -2^{19}),
22 2^{19}-1)
23 QACC_H[ 79: 60] = min(max(QACC_H[ 79: 60] + qx[ 95: 88] * qy[ 95: 88], -2^{19}),
24 2^{19}-1)
25 QACC_H[ 99: 80] = min(max(QACC_H[ 99: 80] + qx[103: 96] * qy[103: 96], -2^{19}),
26 2^{19}-1)
27 QACC_H[119:100] = min(max(QACC_H[119:100] + qx[111:104] * qy[111:104], -2^{19}),
28 2^{19}-1)
29 QACC_H[139:120] = min(max(QACC_H[139:120] + qx[119:112] * qy[119:112], -2^{19}),
30 2^{19}-1)

```

```
16 QACC_H[159:140] = min(max(QACC_H[159:140] + qx[127:120] * qy[127:120], -2{19}),  
17 2{19}-1)  
18 qu[127:0] = load128({as[31:4],4{0}})  
19 as[31:0] = as[31:0] + ad[31:0]  
20 qs0[127:0] = {qs1[127:0], qs0[127:0]} >> {SAR_BYTE[3:0] << 3}
```

1.8.156 EE.VMULAS.S8.QACC.LDBC.INCP

Instruction Word

101	qu[2]	0111	qu[1]	qy[2]	qu[0]	qy[1:0]	qx[2:0]	as[3:0]	0100
-----	-------	------	-------	-------	-------	---------	---------	---------	------

Assembler Syntax

EE.VMULAS.S8.QACC.LDBC.INCP qu, as, qx, qy

Description

This instruction divides registers qx and qy into 16 data segments by 8 bits. Then, the signed multiplication result of the 16 sets of segments is added to the corresponding 20-bit data segment in special registers QACC_H and QACC_L respectively. The calculated result is saturated to a 20-bit signed number and then stored to the corresponding 20-bit data segment in QACC_H and QACC_L.

At the same time, this instruction loads 8-bit data from memory at the address given by the access register as and broadcasts it to the 16 8-bit data segments in register qu. After the access, the value in register as is incremented by 1.

Operation

```

1  QACC_L[ 19: 0] = min(max(QACC_L[ 19: 0] + qx[ 7: 0] * qy[ 7: 0], -2^{19}),
   2^{19}-1)
2  QACC_L[ 39: 20] = min(max(QACC_L[ 39: 20] + qx[ 15: 8] * qy[ 15: 8], -2^{19}),
   2^{19}-1)
3  QACC_L[ 59: 40] = min(max(QACC_L[ 59: 40] + qx[ 23: 16] * qy[ 23: 16], -2^{19}),
   2^{19}-1)
4  QACC_L[ 79: 60] = min(max(QACC_L[ 79: 60] + qx[ 31: 24] * qy[ 31: 24], -2^{19}),
   2^{19}-1)
5  QACC_L[ 99: 80] = min(max(QACC_L[ 99: 80] + qx[ 39: 32] * qy[ 39: 32], -2^{19}),
   2^{19}-1)
6  QACC_L[119:100] = min(max(QACC_L[119:100] + qx[ 47: 40] * qy[ 47: 40], -2^{19}),
   2^{19}-1)
7  QACC_L[139:120] = min(max(QACC_L[139:120] + qx[ 55: 48] * qy[ 55: 48], -2^{19}),
   2^{19}-1)
8  QACC_L[159:140] = min(max(QACC_L[159:140] + qx[ 63: 56] * qy[ 63: 56], -2^{19}),
   2^{19}-1)
9  QACC_H[ 19: 0] = min(max(QACC_H[ 19: 0] + qx[ 71: 64] * qy[ 71: 64], -2^{19}),
   2^{19}-1)
10 QACC_H[ 39: 20] = min(max(QACC_H[ 39: 20] + qx[ 79: 72] * qy[ 79: 72], -2^{19}),
   2^{19}-1)
11 QACC_H[ 59: 40] = min(max(QACC_H[ 59: 40] + qx[ 87: 80] * qy[ 87: 80], -2^{19}),
   2^{19}-1)
12 QACC_H[ 79: 60] = min(max(QACC_H[ 79: 60] + qx[ 95: 88] * qy[ 95: 88], -2^{19}),
   2^{19}-1)
13 QACC_H[ 99: 80] = min(max(QACC_H[ 99: 80] + qx[103: 96] * qy[103: 96], -2^{19}),
   2^{19}-1)
14 QACC_H[119:100] = min(max(QACC_H[119:100] + qx[111:104] * qy[111:104], -2^{19}),
   2^{19}-1)
15 QACC_H[139:120] = min(max(QACC_H[139:120] + qx[119:112] * qy[119:112], -2^{19}),
   2^{19}-1)
16 QACC_H[159:140] = min(max(QACC_H[159:140] + qx[127:120] * qy[127:120], -2^{19}),
   2^{19}-1)
17

```



```
18 qu[127:0] = {16{load8(as[31:0])}}
19 as[31:0] = as[31:0] + 1
```

1.8.157 EE.VMULAS.S8.QACC.LDBC.INCP.QUP

Instruction Word

111000	qu[2:1]	qy[0]	qs0[2:0]	qu[0]	qs1[2:0]	qx[1:0]	qy[2:1]	1001	as[3:0]	111	qx[2]
--------	---------	-------	----------	-------	----------	---------	---------	------	---------	-----	-------

Assembler Syntax

EE.VMULAS.S8.QACC.LDBC.INCP.QUP qu, as, qx, qy, qs0, qs1

Description

This instruction divides registers qx and qy into 16 data segments by 8 bits. Then, the signed multiplication result of the 16 sets of segments is added to the corresponding 20-bit data segment in special registers QACC_H and QACC_L respectively. The calculated result is saturated to a 20-bit signed number and then stored to the corresponding 20-bit data segment in QACC_H and QACC_L.

At the same time, this instruction loads 8-bit data from memory at the address given by the access register as and broadcasts it to the 16 8-bit data segments in register qu. After the access, the value in register as is incremented by 1.

At the same time, this instruction also obtains 16-byte unaligned data by concatenating and shifting consecutive aligned data stored in the two registers qs0 and qs1 and stores it to qs0. The shift byte is stored in special register SAR_BYTE.

Operation

```

1  QACC_L[ 19: 0] = min(max(QACC_L[ 19: 0] + qx[ 7: 0] * qy[ 7: 0], -2^{19}),
2  2^{19}-1)
3  QACC_L[ 39: 20] = min(max(QACC_L[ 39: 20] + qx[ 15: 8] * qy[ 15: 8], -2^{19}),
4  2^{19}-1)
5  QACC_L[ 59: 40] = min(max(QACC_L[ 59: 40] + qx[ 23: 16] * qy[ 23: 16], -2^{19}),
6  2^{19}-1)
7  QACC_L[ 79: 60] = min(max(QACC_L[ 79: 60] + qx[ 31: 24] * qy[ 31: 24], -2^{19}),
8  2^{19}-1)
9  QACC_L[ 99: 80] = min(max(QACC_L[ 99: 80] + qx[ 39: 32] * qy[ 39: 32], -2^{19}),
10 2^{19}-1)
11 QACC_L[119:100] = min(max(QACC_L[119:100] + qx[ 47: 40] * qy[ 47: 40], -2^{19}),
12 2^{19}-1)
13 QACC_L[139:120] = min(max(QACC_L[139:120] + qx[ 55: 48] * qy[ 55: 48], -2^{19}),
14 2^{19}-1)
15 QACC_L[159:140] = min(max(QACC_L[159:140] + qx[ 63: 56] * qy[ 63: 56], -2^{19}),
16 2^{19}-1)
17 QACC_H[ 19: 0] = min(max(QACC_H[ 19: 0] + qx[ 71: 64] * qy[ 71: 64], -2^{19}),
18 2^{19}-1)
19 QACC_H[ 39: 20] = min(max(QACC_H[ 39: 20] + qx[ 79: 72] * qy[ 79: 72], -2^{19}),
20 2^{19}-1)
21 QACC_H[ 59: 40] = min(max(QACC_H[ 59: 40] + qx[ 87: 80] * qy[ 87: 80], -2^{19}),
22 2^{19}-1)
23 QACC_H[ 79: 60] = min(max(QACC_H[ 79: 60] + qx[ 95: 88] * qy[ 95: 88], -2^{19}),
24 2^{19}-1)
25 QACC_H[ 99: 80] = min(max(QACC_H[ 99: 80] + qx[103: 96] * qy[103: 96], -2^{19}),
26 2^{19}-1)
27 QACC_H[119:100] = min(max(QACC_H[119:100] + qx[111:104] * qy[111:104], -2^{19}),
28 2^{19}-1)
29 QACC_H[139:120] = min(max(QACC_H[139:120] + qx[119:112] * qy[119:112], -2^{19}),
30 2^{19}-1)

```

```
16 QACC_H[159:140] = min(max(QACC_H[159:140] + qx[127:120] * qy[127:120], -2{19}),  
17 2{19}-1)  
18 qu[127:0] = {16{load8(as[31:0])}}  
19 as[31:0] = as[31:0] + 1  
20 qs0[127:0] = {qs1[127:0], qs0[127:0]} >> {SAR_BYTE[3:0] << 3}
```

1.8.158 EE.VMULAS.U16.ACCX

Instruction Word

000010100	qy[2]	0	qy[1:0]	qx[2:0]	10000100
-----------	-------	---	---------	---------	----------

Assembler Syntax

EE.VMULAS.U16.ACCX qx, qy

Description

This instruction divides registers qx and qy into 8 data segments by 16 bits. Then, it performs an unsigned multiply-accumulate operation on the 8 sets of segments respectively. The accumulated result is added to the value in special register ACCX. Then, the sum obtained is saturated and then stored in ACCX.

Operation

```

1  add0[31:0] = qx[ 15: 0] * qy[ 15: 0]
2  add1[31:0] = qx[ 31: 16] * qy[ 31: 16]
3  ...
4  add7[31:0] = qx[127:112] * qy[127:112]
5  sum[40:0] = ACCX[39:0] + ad[31:0]d0[31:0] + ad[31:0]d1[31:0] + ... + ad[31:0]d7[31:0]
6
7  ACCX[39:0] = min(max(sum[40:0], 0), 2^{40}-1)

```

1.8.159 EE.VMULAS.U16.ACCX.LD.IP

Instruction Word

1111	imm16[5:4]	qu[2:1]	qy[0]	000	qu[0]	100	qx[1:0]	qy[2:1]	imm16[3:0]	as[3:0]	111	qx[2]
------	------------	---------	-------	-----	-------	-----	---------	---------	------------	---------	-----	-------

Assembler Syntax

EE.VMULAS.U16.ACCX.LD.IP qu, as, -512..496, qx, qy

Description

This instruction divides registers qx and qy into 8 data segments by 16 bits. Then, it performs an unsigned multiply-accumulate operation on the 8 sets of segments respectively. The accumulated result is added to the value in special register ACCX. Then, the sum obtained is saturated and then stored in ACCX.

During the operation, the lower 4 bits of the access address in register as are forced to be 0, and then the 16-byte data is loaded from the memory to register qu. After the access is completed, the value in register as is incremented by 6-bit sign-extended constant in the instruction code segment left-shifted by 4.

Operation

```

1  add0[31:0] = qx[ 15: 0] * qy[ 15: 0]
2  add1[31:0] = qx[ 31: 16] * qy[ 31: 16]
3  ...
4  add7[31:0] = qx[127:112] * qy[127:112]
5  sum[40:0] = ACCX[39:0] + ad[31:0]d0[31:0] + ad[31:0]d1[31:0] + ... + ad[31:0]d7[31:0]
6  ACCX[40:0] = min(max(sum[40:0], 0), 2^{40}-1)
7
8  qu[127:0] = load128({as[31:4],4{0}})
9  as[31:0] = as[31:0] + {20{imm16[7]},imm16[7:0],4{0}}
```

1.8.160 EE.VMULAS.U16.ACCX.LD.IP.QUP

Instruction Word

0100	imm16[5:4]	qu[2:1]	qy[0]	qs0[2:0]	qu[0]	qs1[2:0]	qx[1:0]	qy[2:1]	imm16[3:0]	as[3:0]	111	qx[2]
------	------------	---------	-------	----------	-------	----------	---------	---------	------------	---------	-----	-------

Assembler Syntax

EE.VMULAS.U16.ACCX.LD.IP.QUP qu, as, imm16, qx, qy, qs0, qs1

Description

This instruction divides registers qx and qy into 8 data segments by 16 bits. Then, it performs a signed multiply-accumulate operation on the 8 sets of segments respectively. The accumulated result is added to the value in special register ACCX. Then, the sum obtained is saturated and then stored in ACCX.

During the operation, the lower 4 bits of the access address in register as are forced to be 0, and then the 16-byte data is loaded from the memory to register qu. After the access is completed, the value in register as is incremented by 6-bit sign-extended constant in the instruction code segment left-shifted by 4.

At the same time, this instruction also obtains 16-byte unaligned data by concatenating and shifting consecutive aligned data stored in the two registers qs0 and qs1 and stores it to qs0. The shift byte is stored in special register SAR_BYTE.

Operation

```

1  add0[31:0] = qx[ 15: 0] * qy[ 15: 0]
2  add1[31:0] = qx[ 31: 16] * qy[ 31: 16]
3  ...
4  add7[31:0] = qx[127:112] * qy[127:112]
5  sum[40:0] = ACCX[39:0] + ad[31:0]d0[31:0] + ad[31:0]d1[31:0] + ... + ad[31:0]d7[31:0]
6  ACCX[40:0] = min(max(sum[40:0], 0), 2^{40}-1)
7
8  qu[127:0] = load128({as[31:4], 4{0}})
9  as[31:0] = as[31:0] + {20{imm16[7]}, imm16[7:0], 4{0}}
10 qs0[127:0] = {qs1[127:0], qs0[127:0]} >> {SAR_BYTE[3:0] << 3}

```

1.8.161 EE.VMULAS.U16.ACCX.LD.XP

Instruction Word

111100	qu[2:1]	qy[0]	001	qu[0]	100	qx[1:0]	qy[2:1]	ad[3:0]	as[3:0]	111	qx[2]
--------	---------	-------	-----	-------	-----	---------	---------	---------	---------	-----	-------

Assembler Syntax

EE.VMULAS.U16.ACCX.LD.XP qu, as, ad, qx, qy

Description

This instruction divides registers qx and qy into 8 data segments by 16 bits. Then, it performs an unsigned multiply-accumulate operation on the 8 sets of segments respectively. The accumulated result is added to the value in special register ACCX. Then, the sum obtained is saturated and then stored in ACCX.

During the operation, the lower 4 bits of the access address in register as are forced to be 0, and then the 16-byte data is loaded from the memory to register qu. After the access is completed, the value in register as is incremented by the value in register ad.

Operation

```

1  add0[31:0] = qx[ 15: 0] * qy[ 15: 0]
2  add1[31:0] = qx[ 31: 16] * qy[ 31: 16]
3  ...
4  add7[31:0] = qx[127:112] * qy[127:112]
5  sum[40:0] = ACCX[39:0] + ad[31:0]d0[31:0] + ad[31:0]d1[31:0] + ... + ad[31:0]d7[31:0]
6  ACCX[40:0] = min(max(sum[40:0], 0), 2^{40}-1)
7
8  qu[127:0] = load128({as[31:4],4{0}})
9  as[31:0] = as[31:0] + ad[31:0]

```

1.8.162 EE.VMULAS.U16.ACCX.LD.XP.QUP

Instruction Word

110000	qu[2:1]	qy[0]	qs0[2:0]	qu[0]	qs1[2:0]	qx[1:0]	qy[2:1]	ad[3:0]	as[3:0]	111	qx[2]
--------	---------	-------	----------	-------	----------	---------	---------	---------	---------	-----	-------

Assembler Syntax

EE.VMULAS.U16.ACCX.LD.XP.QUP qu, as, ad, qx, qy, qs0, qs1

Description

This instruction divides registers qx and qy into 8 data segments by 16 bits. Then, it performs an unsigned multiply-accumulate operation on the 8 sets of segments respectively. The accumulated result is added to the value in special register ACCX. Then, the sum obtained is saturated and then stored in ACCX.

During the operation, the lower 4 bits of the access address in register as are forced to be 0, and then the 16-byte data is loaded from the memory to register qu. After the access is completed, the value in register as is incremented by the value in register ad.

At the same time, this instruction also obtains 16-byte unaligned data by concatenating and shifting consecutive aligned data stored in the two registers qs0 and qs1 and stores it to qs0. The shift byte is stored in special register SAR_BYTE.

Operation

```

1  add0[31:0] = qx[ 15: 0] * qy[ 15: 0]
2  add1[31:0] = qx[ 31: 16] * qy[ 31: 16]
3  ...
4  add7[31:0] = qx[127:112] * qy[127:112]
5  sum[40:0] = ACCX[39:0] + ad[31:0]d0[31:0] + ad[31:0]d1[31:0] + ... + ad[31:0]d7[31:0]
6  ACCX[40:0] = min(max(sum[40:0], 0), 2^{40}-1)
7
8  qu[127:0] = load128({as[31:4],4{0}})
9  as[31:0] = as[31:0] + ad[31:0]
10 qs0[127:0] = {qs1[127:0], qs0[127:0]} >> {SAR_BYTE[3:0] << 3}

```

1.8.163 EE.VMULAS.U16.QACC

Instruction Word

000010100	qy[2]	1	qy[1:0]	qx[2:0]	10000100
-----------	-------	---	---------	---------	----------

Assembler Syntax

EE.VMULAS.U16.QACC qx, qy

Description

This instruction divides registers `qx` and `qy` into 8 data segments by 16 bits. Then, the unsigned multiplication result of the 8 sets of segments is added to the corresponding 40-bit data segment in special registers `QACC_H` and `QACC_L` respectively. The calculated result is saturated to a 40-bit unsigned number and then stored to the corresponding 40-bit data segment in `QACC_H` and `QACC_L`.

Operation

```

1  QACC_L[ 39: 0] = min(QACC_L[ 39: 0] + qx[ 15: 0] * qy[ 15: 0], 2^{40}-1)
2  QACC_L[ 79: 40] = min(QACC_L[ 79: 40] + qx[ 31: 16] * qy[ 31: 16], 2^{40}-1)
3  ...
4  QACC_L[159:120] = min(QACC_L[159:120] + qx[ 63: 48] * qy[ 63: 48], 2^{40}-1)
5  QACC_H[ 39: 0] = min(QACC_H[ 39: 0] + qx[ 79: 64] * qy[ 79: 64], 2^{40}-1)
6  QACC_H[ 79: 40] = min(QACC_H[ 79: 40] + qx[ 95: 80] * qy[ 95: 80], 2^{40}-1)
7  ...
8  QACC_H[159:120] = min(QACC_H[159:120] + qx[127:112] * qy[127:112], 2^{40}-1)

```

1.8.164 EE.VMULAS.U16.QACC.LD.IP

Instruction Word

1111	imm16[5:4]	qu[2:1]	qy[0]	000	qu[0]	101	qx[1:0]	qy[2:1]	imm16[3:0]	as[3:0]	111	qx[2]
------	------------	---------	-------	-----	-------	-----	---------	---------	------------	---------	-----	-------

Assembler Syntax

EE.VMULAS.U16.QACC.LD.IP qu, as, imm16, qx, qy

Description

This instruction divides registers qx and qy into 8 data segments by 16 bits. Then, the unsigned multiplication result of the 8 sets of segments is added to the corresponding 40-bit data segment in special registers QACC_H and QACC_L respectively. The calculated result is saturated to a 40-bit unsigned number and then stored to the corresponding 40-bit data segment in QACC_H and QACC_L.

During the operation, the lower 4 bits of the access address in register as are forced to be 0, and then the 16-byte data is loaded from the memory to register qu. After the access is completed, the value in register as is incremented by 6-bit sign-extended constant in the instruction code segment left-shifted by 4.

Operation

```

1  QACC_L[ 39: 0] = min(QACC_L[ 39: 0] + qx[ 15: 0] * qy[ 15: 0], 2^{40}-1)
2  QACC_L[ 79: 40] = min(QACC_L[ 79: 40] + qx[ 31: 16] * qy[ 31: 16], 2^{40}-1)
3  ...
4  QACC_L[159:120] = min(QACC_L[159:120] + qx[ 63: 48] * qy[ 63: 48], 2^{40}-1)
5  QACC_H[ 39: 0] = min(QACC_H[ 39: 0] + qx[ 79: 64] * qy[ 79: 64], 2^{40}-1)
6  QACC_H[ 79: 40] = min(QACC_H[ 79: 40] + qx[ 95: 80] * qy[ 95: 80], 2^{40}-1)
7  ...
8  QACC_H[159:120] = min(QACC_H[159:120] + qx[127:112] * qy[127:112], 2^{40}-1)
9
10 qu[127:0] = load128({as[31:4],4{0}})
11 as[31:0] = as[31:0] + {22{imm16[5]},imm16[5:0],4{0}}
```

1.8.165 EE.VMULAS.U16.QACC.LD.IP.QUP

Instruction Word

0101	imm16[5:4]	qu[2:1]	qy[0]	qs0[2:0]	qu[0]	qs1[2:0]	qx[1:0]	qy[2:1]	imm16[3:0]	as[3:0]	111	qx[2]
------	------------	---------	-------	----------	-------	----------	---------	---------	------------	---------	-----	-------

Assembler Syntax

EE.VMULAS.U16.QACC.LD.IP.QUP qu, as, imm16, qx, qy, qs0, qs1

Description

This instruction divides registers qx and qy into 8 data segments by 16 bits. Then, the unsigned multiplication result of the 8 sets of segments is added to the corresponding 40-bit data segment in special registers QACC_H and QACC_L respectively. The calculated result is saturated to a 40-bit unsigned number and then stored to the corresponding 40-bit data segment in QACC_H and QACC_L.

During the operation, the lower 4 bits of the access address in register as are forced to be 0, and then the 16-byte data is loaded from the memory to register qu. After the access is completed, the value in register as is incremented by 6-bit sign-extended constant in the instruction code segment left-shifted by 4.

At the same time, this instruction also obtains 16-byte unaligned data by concatenating and shifting consecutive aligned data stored in the two registers qs0 and qs1 and stores it to qs0. The shift byte is stored in special register SAR_BYTE.

Operation

```

1  QACC_L[ 39: 0] = min(QACC_L[ 39: 0] + qx[ 15: 0] * qy[ 15: 0], 2^{40}-1)
2  QACC_L[ 79: 40] = min(QACC_L[ 79: 40] + qx[ 31: 16] * qy[ 31: 16], 2^{40}-1)
3  ...
4  QACC_L[159:120] = min(QACC_L[159:120] + qx[ 63: 48] * qy[ 63: 48], 2^{40}-1)
5  QACC_H[ 39: 0] = min(QACC_H[ 39: 0] + qx[ 79: 64] * qy[ 79: 64], 2^{40}-1)
6  QACC_H[ 79: 40] = min(QACC_H[ 79: 40] + qx[ 95: 80] * qy[ 95: 80], 2^{40}-1)
7  ...
8  QACC_H[159:120] = min(QACC_H[159:120] + qx[127:112] * qy[127:112], 2^{40}-1)
9
10 qu[127:0] = load128({as[31:4],4{0}})
11 as[31:0] = as[31:0] + {22{imm16[5]},imm16[5:0],4{0}}
12 qs0[127:0] = {qs1[127:0], qs0[127:0]} >> {SAR_BYTE[3:0] << 3}

```

1.8.166 EE.VMULAS.U16.QACC.LD.XP

Instruction Word

111100	qu[2:1]	qy[0]	001	qu[0]	101	qx[1:0]	qy[2:1]	ad[3:0]	as[3:0]	111	qx[2]
--------	---------	-------	-----	-------	-----	---------	---------	---------	---------	-----	-------

Assembler Syntax

EE.VMULAS.U16.QACC.LD.XP qu, as, ad, qx, qy

Description

This instruction divides registers `qx` and `qy` into 8 data segments by 16 bits. Then, the unsigned multiplication result of the 8 sets of segments is added to the corresponding 40-bit data segment in special registers `QACC_H` and `QACC_L` respectively. The calculated result is saturated to a 40-bit unsigned number and then stored to the corresponding 40-bit data segment in `QACC_H` and `QACC_L`.

During the operation, the lower 4 bits of the access address in register `as` are forced to be 0, and then the 16-byte data is loaded from the memory to register `qu`. After the access is completed, the value in register `as` is incremented by the value in register `ad`.

Operation

```

1  QACC_L[ 39: 0] = min(QACC_L[ 39: 0] + qx[ 15: 0] * qy[ 15: 0], 2^{40}-1)
2  QACC_L[ 79: 40] = min(QACC_L[ 79: 40] + qx[ 31: 16] * qy[ 31: 16], 2^{40}-1)
3  ...
4  QACC_L[159:120] = min(QACC_L[159:120] + qx[ 63: 48] * qy[ 63: 48], 2^{40}-1)
5  QACC_H[ 39: 0] = min(QACC_H[ 39: 0] + qx[ 79: 64] * qy[ 79: 64], 2^{40}-1)
6  QACC_H[ 79: 40] = min(QACC_H[ 79: 40] + qx[ 95: 80] * qy[ 95: 80], 2^{40}-1)
7  ...
8  QACC_H[159:120] = min(QACC_H[159:120] + qx[127:112] * qy[127:112], 2^{40}-1)
9
10 qu[127:0] = load128({as[31:4],4{0}})
11 as[31:0] = as[31:0] + ad[31:0]

```

1.8.167 EE.VMULAS.U16.QACC.LD.XP.QUP

Instruction Word

110001	qu[2:1]	qy[0]	qs0[2:0]	qu[0]	qs1[2:0]	qx[1:0]	qy[2:1]	ad[3:0]	as[3:0]	111	qx[2]
--------	---------	-------	----------	-------	----------	---------	---------	---------	---------	-----	-------

Assembler Syntax

EE.VMULAS.U16.QACC.LD.XP.QUP qu, as, ad, qx, qy, qs0, qs1

Description

This instruction divides registers qx and qy into 8 data segments by 16 bits. Then, the unsigned multiplication result of the 8 sets of segments is added to the corresponding 40-bit data segment in special registers QACC_H and QACC_L respectively. The calculated result is saturated to a 40-bit unsigned number and then stored to the corresponding 40-bit data segment in QACC_H and QACC_L.

During the operation, the lower 4 bits of the access address in register as are forced to be 0, and then the 16-byte data is loaded from the memory to register qu. After the access is completed, the value in register as is incremented by the value in register ad.

At the same time, this instruction also obtains 16-byte unaligned data by concatenating and shifting consecutive aligned data stored in the two registers qs0 and qs1 and stores it to qs0. The shift byte is stored in special register SAR_BYTE.

Operation

```

1  QACC_L[ 39: 0] = min(QACC_L[ 39: 0] + qx[ 15: 0] * qy[ 15: 0], 2^{40}-1)
2  QACC_L[ 79: 40] = min(QACC_L[ 79: 40] + qx[ 31: 16] * qy[ 31: 16], 2^{40}-1)
3  ...
4  QACC_L[159:120] = min(QACC_L[159:120] + qx[ 63: 48] * qy[ 63: 48], 2^{40}-1)
5  QACC_H[ 39: 0] = min(QACC_H[ 39: 0] + qx[ 79: 64] * qy[ 79: 64], 2^{40}-1)
6  QACC_H[ 79: 40] = min(QACC_H[ 79: 40] + qx[ 95: 80] * qy[ 95: 80], 2^{40}-1)
7  ...
8  QACC_H[159:120] = min(QACC_H[159:120] + qx[127:112] * qy[127:112], 2^{40}-1)
9
10 qu[127:0] = load128({as[31:4],4{0}})
11 as[31:0] = as[31:0] + ad[31:0]
12 qs0[127:0] = {qs1[127:0], qs0[127:0]} >> {SAR_BYTE[3:0] << 3}

```

1.8.168 EE.VMULAS.U16.QACC.LDBC.INCP

Instruction Word

110	qu[2]	0111	qu[1]	qy[2]	qu[0]	qy[1:0]	qx[2:0]	as[3:0]	0100
-----	-------	------	-------	-------	-------	---------	---------	---------	------

Assembler Syntax

EE.VMULAS.U16.QACC.LDBC.INCP qu, as, qx, qy

Description

This instruction divides registers `qx` and `qy` into 8 data segments by 16 bits. Then, the unsigned multiplication result of the 8 sets of segments is added to the corresponding 40-bit data segment in special registers `QACC_H` and `QACC_L` respectively. The calculated result is saturated to a 40-bit unsigned number and then stored to the corresponding 40-bit data segment in `QACC_H` and `QACC_L`.

At the same time, this instruction forces the lower 1 bit of the access address in register `as` to 0, loads 16-bit data from memory, and broadcasts it to the eight 16-bit data segments in register `qu`. After the access, the value in register `as` is incremented by 2.

Operation

```

1  QACC_L[ 39: 0] = min(QACC_L[ 39: 0] + qx[ 15: 0] * qy[ 15: 0], 2^{40}-1)
2  QACC_L[ 79: 40] = min(QACC_L[ 79: 40] + qx[ 31: 16] * qy[ 31: 16], 2^{40}-1)
3  ...
4  QACC_L[159:120] = min(QACC_L[159:120] + qx[ 63: 48] * qy[ 63: 48], 2^{40}-1)
5  QACC_H[ 39: 0] = min(QACC_H[ 39: 0] + qx[ 79: 64] * qy[ 79: 64], 2^{40}-1)
6  QACC_H[ 79: 40] = min(QACC_H[ 79: 40] + qx[ 95: 80] * qy[ 95: 80], 2^{40}-1)
7  ...
8  QACC_H[159:120] = min(QACC_H[159:120] + qx[127:112] * qy[127:112], 2^{40}-1)
9
10 qu[127:0] = {8{load16({as[31:1],1{0}})}}
11 as[31:0] = as[31:0] + 2

```

1.8.169 EE.VMULAS.U16.QACC.LDBC.INCP.QUP

Instruction Word

111000	qu[2:1]	qy[0]	qs0[2:0]	qu[0]	qs1[2:0]	qx[1:0]	qy[2:1]	1010	as[3:0]	111	qx[2]
--------	---------	-------	----------	-------	----------	---------	---------	------	---------	-----	-------

Assembler Syntax

EE.VMULAS.U16.QACC.LDBC.INCP.QUP qu, as, qx, qy, qs0, qs1

Description

This instruction divides registers qx and qy into 8 data segments by 16 bits. Then, the unsigned multiplication result of the 8 sets of segments is added to the corresponding 40-bit data segment in special registers QACC_H and QACC_L respectively. The calculated result is saturated to a 40-bit unsigned number and then stored to the corresponding 40-bit data segment in QACC_H and QACC_L.

At the same time, this instruction forces the lower 1 bit of the access address in register as to 0, loads 16-bit data from memory, and broadcasts it to the eight 16-bit data segments in register qu. After the access, the value in register as is incremented by 2.

At the same time, this instruction also obtains 16-byte unaligned data by concatenating and shifting consecutive aligned data stored in the two registers qs0 and qs1 and stores it to qs0. The shift byte is stored in special register SAR_BYTE.

Operation

```

1  QACC_L[ 39: 0] = min(QACC_L[ 39: 0] + qx[ 15: 0] * qy[ 15: 0], 2^{40}-1)
2  QACC_L[ 79: 40] = min(QACC_L[ 79: 40] + qx[ 31: 16] * qy[ 31: 16], 2^{40}-1)
3  ...
4  QACC_L[159:120] = min(QACC_L[159:120] + qx[ 63: 48] * qy[ 63: 48], 2^{40}-1)
5  QACC_H[ 39: 0] = min(QACC_H[ 39: 0] + qx[ 79: 64] * qy[ 79: 64], 2^{40}-1)
6  QACC_H[ 79: 40] = min(QACC_H[ 79: 40] + qx[ 95: 80] * qy[ 95: 80], 2^{40}-1)
7  ...
8  QACC_H[159:120] = min(QACC_H[159:120] + qx[127:112] * qy[127:112], 2^{40}-1)
9
10 qu[127:0] = {8{load16({as[31:1], 1{0}})}}
11 as[31:0] = as[31:0] + 2
12 qs0[127:0] = {qs1[127:0], qs0[127:0]} >> {SAR_BYTE[3:0] << 3}

```

1.8.170 EE.VMULAS.U8.ACCX

Instruction Word

000010100	qy[2]	0	qy[1:0]	qx[2:0]	11000100
-----------	-------	---	---------	---------	----------

Assembler Syntax

EE.VMULAS.U8.ACCX qx, qy

Description

This instruction divides registers qx and qy into 16 data segments by 8 bits. Then, it performs an unsigned multiply-accumulate operation on the 16 sets of segments respectively. The accumulated result is added to the value in special register ACCX. Then, the sum obtained is saturated and then stored in ACCX.

Operation

```

1  add0[15:0] = qx[ 7: 0] * qy[ 7: 0]
2  add1[15:0] = qx[15: 8] * qy[15: 8]
3  ...
4  add15[15:0] = qx[127:120] * qy[127:120]
5  sum[40:0] = ACCX[39:0] + ad[31:0]d0[15:0] + ad[31:0]d1[15:0] + ... + ad[31:0]d15[15:0]
6
7  ACCX[40:0] = min(max(sum[40:0], 0), 2^{40}-1)

```

1.8.171 EE.VMULAS.U8.ACCX.LD.IP

Instruction Word

1111	imm16[5:4]	qu[2:1]	qy[0]	000	qu[0]	110	qx[1:0]	qy[2:1]	imm16[3:0]	as[3:0]	111	qx[2]
------	------------	---------	-------	-----	-------	-----	---------	---------	------------	---------	-----	-------

Assembler Syntax

EE.VMULAS.U8.ACCX.LD.IP qu, as, -512..496, qx, qy

Description

This instruction divides registers qx and qy into 16 data segments by 8 bits. Then, it performs an unsigned multiply-accumulate operation on the 16 sets of segments respectively. The accumulated result is added to the value in special register ACCX. Then, the sum obtained is saturated and then stored in ACCX.

During the operation, the lower 4 bits of the access address in register as are forced to be 0, and then the 16-byte data is loaded from the memory to register qu. After the access is completed, the value in register as is incremented by 6-bit sign-extended constant in the instruction code segment left-shifted by 4.

Operation

```

1  add0[15:0] = qx[ 7: 0] * qy[ 7: 0]
2  add1[15:0] = qx[15: 8] * qy[15: 8]
3  ...
4  add15[15:0] = qx[127:120] * qy[127:120]
5  sum[40:0] = ACCX[39:0] + ad[31:0]d0[15:0] + ad[31:0]d1[15:0] + ... + ad[31:0]d15[15:0]
6  ACCX[40:0] = min(max(sum[40:0], 0), 2^{40}-1)
7
8  qu[127:0] = load128({as[31:4],4{0}})
9  as[31:0] = as[31:0] + {20{imm16[7]},imm16[7:0],4{0}}
```

1.8.172 EE.VMULAS.U8.ACCX.LD.IP.QUP

Instruction Word

0110	imm16[5:4]	qu[2:1]	qy[0]	qs0[2:0]	qu[0]	qs1[2:0]	qx[1:0]	qy[2:1]	imm16[3:0]	as[3:0]	111	qx[2]
------	------------	---------	-------	----------	-------	----------	---------	---------	------------	---------	-----	-------

Assembler Syntax

EE.VMULAS.U8.ACCX.LD.IP.QUP qu, as, imm16, qx, qy, qs0, qs1

Description

This instruction divides registers qx and qy into 16 data segments by 8 bits. Then, it performs an unsigned multiply-accumulate operation on the 16 sets of segments respectively. The accumulated result is added to the value in special register ACCX. Then, the sum obtained is saturated and then stored in ACCX.

During the operation, the lower 4 bits of the access address in register as are forced to be 0, and then the 16-byte data is loaded from the memory to register qu. After the access is completed, the value in register as is incremented by 6-bit sign-extended constant in the instruction code segment left-shifted by 4.

At the same time, this instruction also obtains 16-byte unaligned data by concatenating and shifting consecutive aligned data stored in the two registers qs0 and qs1 and stores it to qs0. The shift byte is stored in special register SAR_BYTE.

Operation

```

1  add0[15:0] = qx[ 7: 0] * qy[ 7: 0]
2  add1[15:0] = qx[15: 8] * qy[15: 8]
3  ...
4  add15[15:0] = qx[127:120] * qy[127:120]
5  sum[40:0] = ACCX[39:0] + ad[31:0]d0[15:0] + ad[31:0]d1[15:0] + ... + ad[31:0]d15[15:0]
6  ACCX[40:0] = min(max(sum[40:0], 0), 2^{40}-1)
7
8  qu[127:0] = load128({as[31:4], 4{0}})
9  as[31:0] = as[31:0] + {20{imm16[7]}, imm16[7:0], 4{0}}
10 qs0[127:0] = {qs1[127:0], qs0[127:0]} >> {SAR_BYTE[3:0] << 3}

```

1.8.173 EE.VMULAS.U8.ACCX.LD.XP

Instruction Word

111100	qu[2:1]	qy[0]	001	qu[0]	110	qx[1:0]	qy[2:1]	ad[3:0]	as[3:0]	111	qx[2]
--------	---------	-------	-----	-------	-----	---------	---------	---------	---------	-----	-------

Assembler Syntax

EE.VMULAS.U8.ACCX.LD.XP qu, as, ad, qx, qy

Description

This instruction divides registers qx and qy into 16 data segments by 8 bits. Then, it performs an unsigned multiply-accumulate operation on the 16 sets of segments respectively. The accumulated result is added to the value in special register ACCX. Then, the sum obtained is saturated and then stored in ACCX.

During the operation, the lower 4 bits of the access address in register as are forced to be 0, and then the 16-byte data is loaded from the memory to register qu. After the access is completed, the value in register as is incremented by the value in register ad.

Operation

```

1  add0[15:0] = qx[ 7: 0] * qy[ 7: 0]
2  add1[15:0] = qx[15: 8] * qy[15: 8]
3  ...
4  add15[15:0] = qx[127:120] * qy[127:120]
5  sum[40:0] = ACCX[39:0] + ad[31:0]d0[15:0] + ad[31:0]d1[15:0] + ... + ad[31:0]d15[15:0]
6  ACCX[40:0] = min(max(sum[40:0], 0), 2^{40}-1)
7
8  qu[127:0] = load128({as[31:4],4{0}})
9  as[31:0] = as[31:0] + ad[31:0]

```

1.8.174 EE.VMULAS.U8.ACCX.LD.XP.QUP

Instruction Word

110010	qu[2:1]	qy[0]	qs0[2:0]	qu[0]	qs1[2:0]	qx[1:0]	qy[2:1]	ad[3:0]	as[3:0]	111	qx[2]
--------	---------	-------	----------	-------	----------	---------	---------	---------	---------	-----	-------

Assembler Syntax

EE.VMULAS.U8.ACCX.LD.XP.QUP qu, as, ad, qx, qy, qs0, qs1

Description

This instruction divides registers qx and qy into 16 data segments by 8 bits. Then, it performs an unsigned multiply-accumulate operation on the 16 sets of segments respectively. The accumulated result is added to the value in special register ACCX. Then, the sum obtained is saturated and then stored in ACCX.

During the operation, the lower 4 bits of the access address in register as are forced to be 0, and then the 16-byte data is loaded from the memory to register qu. After the access is completed, the value in register as is incremented by the value in register ad.

At the same time, this instruction also obtains 16-byte unaligned data by concatenating and shifting consecutive aligned data stored in the two registers qs0 and qs1 and stores it to qs0. The shift byte is stored in special register SAR_BYTE.

Operation

```

1  add0[15:0] = qx[ 7: 0] * qy[ 7: 0]
2  add1[15:0] = qx[15: 8] * qy[15: 8]
3  ...
4  add15[15:0] = qx[127:120] * qy[127:120]
5  sum[40:0] = ACCX[39:0] + ad[31:0]d0[15:0] + ad[31:0]d1[15:0] + ... + ad[31:0]d15[15:0]
6  ACCX[40:0] = min(max(sum[40:0], 0), 2^{40}-1)
7
8  qu[127:0] = load128({as[31:4],4{0}})
9  as[31:0] = as[31:0] + ad[31:0]
10 qs0[127:0] = {qs1[127: 0], qs0[127: 0]} >> {SAR_BYTE[3:0] << 3}

```

1.8.175 EE.VMULAS.U8.QACC

Instruction Word

000010100	qy[2]	1	qy[1:0]	qx[2:0]	11000100
-----------	-------	---	---------	---------	----------

Assembler Syntax

EE.VMULAS.U8.QACC qx, qy

Description

This instruction divides registers qx and qy into 16 data segments by 8 bits. Then, the unsigned multiplication result of the 16 sets of segments is added to the corresponding 20-bit data segment in special registers QACC_H and QACC_L respectively. The calculated result is saturated to a 20-bit unsigned number and then stored to the corresponding 20-bit data segment in QACC_H and QACC_L.

Operation

```

1  QACC_L[ 19: 0] = min(QACC_L[ 19: 0] + qx[ 7: 0] * qy[ 7: 0], 2^{20}-1)
2  QACC_L[ 39: 20] = min(QACC_L[ 39: 20] + qx[ 15: 8] * qy[ 15: 8], 2^{20}-1)
3  ...
4  QACC_L[159:140] = min(QACC_L[159:140] + qx[ 63: 56] * qy[ 63: 56], 2^{20}-1)
5  QACC_H[ 19: 0] = min(QACC_H[ 19: 0] + qx[ 71: 64] * qy[ 71: 64], 2^{20}-1)
6  QACC_H[ 39: 20] = min(QACC_H[ 39: 20] + qx[ 79: 72] * qy[ 79: 72], 2^{20}-1)
7  ...
8  QACC_H[159:140] = min(QACC_H[159:140] + qx[127:120] * qy[127:120], 2^{20}-1)

```

1.8.176 EE.VMULAS.U8.QACC.LD.IP

Instruction Word

1111	imm16[5:4]	qu[2:1]	qy[0]	000	qu[0]	111	qx[1:0]	qy[2:1]	imm16[3:0]	as[3:0]	111	qx[2]
------	------------	---------	-------	-----	-------	-----	---------	---------	------------	---------	-----	-------

Assembler Syntax

EE.VMULAS.U8.QACC.LD.IP qu, as, imm16, qx, qy

Description

This instruction divides registers qx and qy into 16 data segments by 8 bits. Then, the unsigned multiplication result of the 16 sets of segments is added to the corresponding 20-bit data segment in special registers QACC_H and QACC_L respectively. The calculated result is saturated to a 20-bit unsigned number and then stored to the corresponding 20-bit data segment in QACC_H and QACC_L.

During the operation, the lower 4 bits of the access address in register as are forced to be 0, and then the 16-byte data is loaded from the memory to register qu. After the access is completed, the value in register as is incremented by 6-bit sign-extended constant in the instruction code segment left-shifted by 4.

Operation

```

1  QACC_L[ 19: 0] = min(QACC_L[ 19: 0] + qx[ 7: 0] * qy[ 7: 0], 2^{20}-1)
2  QACC_L[ 39: 20] = min(QACC_L[ 39: 20] + qx[ 15: 8] * qy[ 15: 8], 2^{w0}-1)
3  ...
4  QACC_L[159:140] = min(QACC_L[159:140] + qx[ 63: 56] * qy[ 63: 56], 2^{20}-1)
5  QACC_H[ 19: 0] = min(QACC_H[ 19: 0] + qx[ 71: 64] * qy[ 71: 64], 2^{20}-1)
6  QACC_H[ 39: 20] = min(QACC_H[ 39: 20] + qx[ 79: 72] * qy[ 79: 72], 2^{20}-1)
7  ...
8  QACC_H[159:140] = min(QACC_H[159:140] + qx[127:120] * qy[127:120], 2^{20}-1)
9
10 qu[127:0] = load128({as[31:4],4{0}})
11 as[31:0] = as[31:0] + {22{imm16[5]},imm16[5:0],4{0}}
```

1.8.177 EE.VMULAS.U8.QACC.LD.IP.QUP

Instruction Word

0111	imm16[5:4]	qu[2:1]	qy[0]	qs0[2:0]	qu[0]	qs1[2:0]	qx[1:0]	qy[2:1]	imm16[3:0]	as[3:0]	111	qx[2]
------	------------	---------	-------	----------	-------	----------	---------	---------	------------	---------	-----	-------

Assembler Syntax

EE.VMULAS.U8.QACC.LD.IP.QUP qu, as, imm16, qx, qy, qs0, qs1

Description

This instruction divides registers qx and qy into 16 data segments by 8 bits. Then, the unsigned multiplication result of the 16 sets of segments is added to the corresponding 20-bit data segment in special registers QACC_H and QACC_L respectively. The calculated result is saturated to a 20-bit unsigned number and then stored to the corresponding 20-bit data segment in QACC_H and QACC_L.

During the operation, the lower 4 bits of the access address in register as are forced to be 0, and then the 16-byte data is loaded from the memory to register qu. After the access is completed, the value in register as is incremented by 6-bit sign-extended constant in the instruction code segment left-shifted by 4.

At the same time, this instruction also obtains 16-byte unaligned data by concatenating and shifting consecutive aligned data stored in the two registers qs0 and qs1 and stores it to qs0. The shift byte is stored in special register SAR_BYTE.

Operation

```

1  QACC_L[ 19: 0] = min(QACC_L[ 19: 0] + qx[ 7: 0] * qy[ 7: 0], 2^{20}-1)
2  QACC_L[ 39: 20] = min(QACC_L[ 39: 20] + qx[ 15: 8] * qy[ 15: 8], 2^{w0}-1)
3  ...
4  QACC_L[159:140] = min(QACC_L[159:140] + qx[ 63: 56] * qy[ 63: 56], 2^{20}-1)
5  QACC_H[ 19: 0] = min(QACC_H[ 19: 0] + qx[ 71: 64] * qy[ 71: 64], 2^{20}-1)
6  QACC_H[ 39: 20] = min(QACC_H[ 39: 20] + qx[ 79: 72] * qy[ 79: 72], 2^{20}-1)
7  ...
8  QACC_H[159:140] = min(QACC_H[159:140] + qx[127:120] * qy[127:120], 2^{20}-1)
9
10 qu[127:0] = load128({as[31:4], 4{0}})
11 as[31:0] = as[31:0] + {22{imm16[5]}, imm16[5:0], 4{0}}
12 qs0[127:0] = {qs1[127:0], qs0[127:0]} >> {SAR_BYTE[3:0] << 3}

```

1.8.178 EE.VMULAS.U8.QACC.LD.XP

Instruction Word

111100	qu[2:1]	qy[0]	001	qu[0]	111	qx[1:0]	qy[2:1]	ad[3:0]	as[3:0]	111	qx[2]
--------	---------	-------	-----	-------	-----	---------	---------	---------	---------	-----	-------

Assembler Syntax

EE.VMULAS.U8.QACC.LD.XP qu, as, ad, qx, qy

Description

This instruction divides registers `qx` and `qy` into 16 data segments by 8 bits. Then, the unsigned multiplication result of the 16 sets of segments is added to the corresponding 20-bit data segment in special registers `QACC_H` and `QACC_L` respectively. The calculated result is saturated to a 20-bit unsigned number and then stored to the corresponding 20-bit data segment in `QACC_H` and `QACC_L`.

During the operation, the lower 4 bits of the access address in register `as` are forced to be 0, and then the 16-byte data is loaded from the memory to register `qu`. After the access is completed, the value in register `as` is incremented by the value in register `ad`.

Operation

```

1  QACC_L[ 19: 0] = min(QACC_L[ 19: 0] + qx[ 7: 0] * qy[ 7: 0], 2^{20}-1)
2  QACC_L[ 39: 20] = min(QACC_L[ 39: 20] + qx[ 15: 8] * qy[ 15: 8], 2^{w0}-1)
3  ...
4  QACC_L[159:140] = min(QACC_L[159:140] + qx[ 63: 56] * qy[ 63: 56], 2^{20}-1)
5  QACC_H[ 19: 0] = min(QACC_H[ 19: 0] + qx[ 71: 64] * qy[ 71: 64], 2^{20}-1)
6  QACC_H[ 39: 20] = min(QACC_H[ 39: 20] + qx[ 79: 72] * qy[ 79: 72], 2^{20}-1)
7  ...
8  QACC_H[159:140] = min(QACC_H[159:140] + qx[127:120] * qy[127:120], 2^{20}-1)
9
10 qu[127:0] = load128({as[31:4],4{0}})
11 as[31:0] = as[31:0] + ad[31:0]

```

1.8.179 EE.VMULAS.U8.QACC.LD.XP.QUP

Instruction Word

110011	qu[2:1]	qy[0]	qs0[2:0]	qu[0]	qs1[2:0]	qx[1:0]	qy[2:1]	ad[3:0]	as[3:0]	111	qx[2]
--------	---------	-------	----------	-------	----------	---------	---------	---------	---------	-----	-------

Assembler Syntax

EE.VMULAS.U8.QACC.LD.XP.QUP qu, as, ad, qx, qy, qs0, qs1

Description

This instruction divides registers qx and qy into 16 data segments by 8 bits. Then, the unsigned multiplication result of the 16 sets of segments is added to the corresponding 20-bit data segment in special registers QACC_H and QACC_L respectively. The calculated result is saturated to a 20-bit unsigned number and then stored to the corresponding 20-bit data segment in QACC_H and QACC_L.

During the operation, the lower 4 bits of the access address in register as are forced to be 0, and then the 16-byte data is loaded from the memory to register qu. After the access is completed, the value in register as is incremented by the value in register ad.

At the same time, this instruction also obtains 16-byte unaligned data by concatenating and shifting consecutive aligned data stored in the two registers qs0 and qs1 and stores it to qs0. The shift byte is stored in special register SAR_BYTE.

Operation

```

1  QACC_L[ 19: 0] = min(QACC_L[ 19: 0] + qx[ 7: 0] * qy[ 7: 0], 2^{20}-1)
2  QACC_L[ 39: 20] = min(QACC_L[ 39: 20] + qx[ 15: 8] * qy[ 15: 8], 2^{w0}-1)
3  ...
4  QACC_L[159:140] = min(QACC_L[159:140] + qx[ 63: 56] * qy[ 63: 56], 2^{20}-1)
5  QACC_H[ 19: 0] = min(QACC_H[ 19: 0] + qx[ 71: 64] * qy[ 71: 64], 2^{20}-1)
6  QACC_H[ 39: 20] = min(QACC_H[ 39: 20] + qx[ 79: 72] * qy[ 79: 72], 2^{20}-1)
7  ...
8  QACC_H[159:140] = min(QACC_H[159:140] + qx[127:120] * qy[127:120], 2^{20}-1)
9
10 qu[127:0] = load128({as[31:4],4{0}})
11 as[31:0] = as[31:0] + ad[31:0]
12 qs0[127:0] = {qs1[127:0], qs0[127:0]} >> {SAR_BYTE[3:0] << 3}

```

1.8.180 EE.VMULAS.U8.QACC.LDBC.INCP

Instruction Word

111	qu[2]	0111	qu[1]	qy[2]	qu[0]	qy[1:0]	qx[2:0]	as[3:0]	0100
-----	-------	------	-------	-------	-------	---------	---------	---------	------

Assembler Syntax

EE.VMULAS.U8.QACC.LDBC.INCP qu, as, qx, qy

Description

This instruction divides registers qx and qy into 16 data segments by 8 bits. Then, the unsigned multiplication result of the 16 sets of segments is added to the corresponding 20-bit data segment in special registers QACC_H and QACC_L respectively. The calculated result is saturated to a 20-bit unsigned number and then stored to the corresponding 20-bit data segment in QACC_H and QACC_L.

At the same time, this instruction loads 8-bit data from memory at the address given by the access register as and broadcasts it to the 16 8-bit data segments in register qu. After the access, the value in register as is incremented by 1.

Operation

```

1  QACC_L[ 19: 0] = min(QACC_L[ 19: 0] + qx[ 7: 0] * qy[ 7: 0], 2^{20}-1)
2  QACC_L[ 39: 20] = min(QACC_L[ 39: 20] + qx[ 15: 8] * qy[ 15: 8], 2^{w0}-1)
3  ...
4  QACC_L[159:140] = min(QACC_L[159:140] + qx[ 63: 56] * qy[ 63: 56], 2^{20}-1)
5  QACC_H[ 19: 0] = min(QACC_H[ 19: 0] + qx[ 71: 64] * qy[ 71: 64], 2^{20}-1)
6  QACC_H[ 39: 20] = min(QACC_H[ 39: 20] + qx[ 79: 72] * qy[ 79: 72], 2^{20}-1)
7  ...
8  QACC_H[159:140] = min(QACC_H[159:140] + qx[127:120] * qy[127:120], 2^{20}-1)
9
10 qu[127:0] = {16{load8(as[31:0])}}
11 as[31:0] = as[31:0] + 1

```

1.8.181 EE.VMULAS.U8.QACC.LDBC.INCP.QUP

Instruction Word

111000	qu[2:1]	qy[0]	qs0[2:0]	qu[0]	qs1[2:0]	qx[1:0]	qy[2:1]	1011	as[3:0]	111	qx[2]
--------	---------	-------	----------	-------	----------	---------	---------	------	---------	-----	-------

Assembler Syntax

EE.VMULAS.U8.QACC.LDBC.INCP.QUP qu, as, qx, qy, qs0, qs1

Description

This instruction divides registers qx and qy into 16 data segments by 8 bits. Then, the unsigned multiplication result of the 16 sets of segments is added to the corresponding 20-bit data segment in special registers QACC_H and QACC_L respectively. The calculated result is saturated to a 20-bit unsigned number and then stored to the corresponding 20-bit data segment in QACC_H and QACC_L.

At the same time, this instruction loads 8-bit data from memory at the address given by the access register as and broadcasts it to the 16 8-bit data segments in register qu. After the access, the value in register as is incremented by 1.

At the same time, this instruction also obtains 16-byte unaligned data by concatenating and shifting consecutive aligned data stored in the two registers qs0 and qs1 and stores it to qs0. The shift byte is stored in special register SAR_BYTE.

Operation

```

1  QACC_L[ 19: 0] = min(QACC_L[ 19: 0] + qx[ 7: 0] * qy[ 7: 0], 2^{20}-1)
2  QACC_L[ 39: 20] = min(QACC_L[ 39: 20] + qx[ 15: 8] * qy[ 15: 8], 2^{w0}-1)
3  ...
4  QACC_L[159:140] = min(QACC_L[159:140] + qx[ 63: 56] * qy[ 63: 56], 2^{20}-1)
5  QACC_H[ 19: 0] = min(QACC_H[ 19: 0] + qx[ 71: 64] * qy[ 71: 64], 2^{20}-1)
6  QACC_H[ 39: 20] = min(QACC_H[ 39: 20] + qx[ 79: 72] * qy[ 79: 72], 2^{20}-1)
7  ...
8  QACC_H[159:140] = min(QACC_H[159:140] + qx[127:120] * qy[127:120], 2^{20}-1)
9
10 qu[127:0] = {16{load8(as[31:0])}}
11 as[31:0] = as[31:0] + 1
12 qs0[127:0] = {qs1[127:0], qs0[127:0]} >> {SAR_BYTE[3:0] << 3}

```

1.8.182 EE.VPRELU.S16

Instruction Word

10	qz[2:1]	1100	qz[0]	qy[2]	0	qy[1:0]	qx[2:0]	ay[3:0]	0100
----	---------	------	-------	-------	---	---------	---------	---------	------

Assembler Syntax

EE.VPRELU.S16 qz, qx, qy, ay

Description

This instruction divides register qx into 8 data segments by 16 bits. If the value of the segment is not greater than 0, it will be multiplied by the value of the corresponding 16-bit segment in register qy right-shifted by the lower 6-bit value in register ay, and then the result obtained will be assigned to the corresponding 16-bit data segment in register qz. Otherwise, the value of the segment in qx will be assigned to qz.

Operation

```

1  qz[ 15: 0] = (qx[ 15: 0]<=0) ? (qx[ 15: 0] * qy[ 15: 0]) >> ay[5:0] : qx[ 15: 0]
2  qz[ 31: 16] = (qx[ 31: 16]<=0) ? (qx[ 31: 16] * qy[ 31: 16]) >> ay[5:0] : qx[ 31: 16]
3  ...
4  qz[127:112] = (qx[127:112]<=0) ? (qx[127:112] * qy[127:112]) >> ay[5:0] : qx[127:112]

```

1.8.183 EE.VPRELU.S8

Instruction Word

10	qz[2:1]	1100	qz[0]	qy[2]	1	qy[1:0]	qx[2:0]	ay[3:0]	0100
----	---------	------	-------	-------	---	---------	---------	---------	------

Assembler Syntax

EE.VPRELU.S8 qz, qx, qy, ay

Description

This instruction divides register qx into 16 data segments by 8 bits. If the value of the segment is not greater than 0, it will be multiplied by the value of the corresponding 8-bit segment in register qy and right-shifted by the lower 5-bit value in register ay, and then the calculated result will be assigned to the corresponding 8-bit data segment in register qz. Otherwise, the value of the segment in qx will be assigned to qz.

Operation

```

1  qz[ 7: 0] = (qx[ 7: 0]<=0) ? (qx[ 7: 0] * qy[ 7: 0]) >> ay[4:0] : qx[ 7: 0]
2  qz[15: 8] = (qx[15: 8]<=0) ? (qx[15: 8] * qy[15: 8]) >> ay[4:0] : qx[15: 8]
3  ...
4  qz[127:120] = (qx[127:120]<=0) ? (qx[127:120] * qy[127:120]) >> ay[4:0] : qx[127:120]

```

1.8.184 EE.VRELU.S16

Instruction Word

11	qs[2:1]	1101	qs[0]	001	ax[3:0]	ay[3:0]	0100
----	---------	------	-------	-----	---------	---------	------

Assembler Syntax

EE.VRELU.S16 qs, ax, ay

Description

This instruction divides register `qs` into 8 data segments by 16 bits. If the value of the segment is not greater than 0, it will be multiplied by the value of the lower 16 bits in register `ax` and right-shifted by the value of the lower 6 bits in register `ay`, and then the result obtained will overwrite the value of the segment. Otherwise, the value of the segment will remain unchanged.

Operation

```

1  qs[ 15: 0] = (qs[ 15: 0]<=0) ? (qs[ 15: 0] * ax[15:0]) >> ay[5:0] : qs[ 15: 0]
2  qs[ 31: 16] = (qs[ 31: 16]<=0) ? (qs[ 31: 16] * ax[15:0]) >> ay[5:0] : qs[ 31: 16]
3  ...
4  qs[127:112] = (qs[127:112]<=0) ? (qs[127:112] * ax[15:0]) >> ay[5:0] : qs[127:112]

```

1.8.185 EE.VRELU.S8

Instruction Word

11	qs[2:1]	1101	qs[0]	101	ax[3:0]	ay[3:0]	0100
----	---------	------	-------	-----	---------	---------	------

Assembler Syntax

EE.VRELU.S8 qs, ax, ay

Description

This instruction divides register `qs` into 16 data segments by 8 bits. If the value of the segment is not greater than 0, it will be multiplied by the value of the lower 8 bits in register `ax` and right-shifted by the value of the lower 5 bits in register `ay`, and then the result obtained will overwrite the value of the segment. Otherwise, the value of the segment will remain unchanged.

Operation

```

1  qs[ 7: 0] = (qs[ 7: 0]<=0) ? (qs[ 7: 0] * ax[7:0]) >> ay[4:0] : qs[ 7: 0]
2  qs[15: 8] = (qs[15: 8]<=0) ? (qs[15: 8] * ax[7:0]) >> ay[4:0] : qs[15: 8]
3  ...
4  qs[127:120] = (qs[127:120]<=0) ? (qs[127:120] * ax[7:0]) >> ay[4:0] : qs[127:120]

```

1.8.186 EE.VSL.32

Instruction Word

11	qs[2:1]	1101	qs[0]	01111110	qa[2:0]	0100
----	---------	------	-------	----------	---------	------

Assembler Syntax

EE.VSL.32 qa, qs

Description

This instruction performs a left shift on the four 32-bit data segments in register `qs` respectively. The left shift amount is the value in the 6-bit special register `SAR`. During the shift process, the lower bits are padded with 0. The lower 32 bits of the shift result are stored in the corresponding data segment in register `qa`.

Operation

- 1 $qa[31:0] = (qs[31:0] \ll SAR[5:0])$
- 2 $qa[63:32] = (qs[63:32] \ll SAR[5:0])$
- 3 $qa[95:64] = (qs[95:64] \ll SAR[5:0])$
- 4 $qa[127:96] = (qs[127:96] \ll SAR[5:0])$

1.8.187 EE.VSMULAS.S16.QACC

Instruction Word

10	sel8[2:1]	1110	sel8[0]	qy[2]	1	qy[1:0]	qx[2:0]	11000100
----	-----------	------	---------	-------	---	---------	---------	----------

Assembler Syntax

EE.VSMULAS.S16.QACC qx, qy, sel8

Description

This instruction selects one out of the eight 16-bit data segments in register `qy` according to immediate number `sel8` and performs a signed multiplication on it and the eight 16-bit data segments in register `qx` respectively. The 8 results obtained are added to the corresponding 40-bit data segment in special registers `QACC_H` and `QACC_L` respectively. Then, the result is saturated to a 40-bit signed number and then stored to the corresponding 40-bit data segment in `QACC_H` and `QACC_L`.

Operation

```

1  temp[15:0] = qy[sel8*16+15:sel8*16]
2  QACC_L[ 39: 0] = min(max(QACC_L[ 39: 0] + qx[ 15: 0] * temp[15:0], -2^{39}),
   2^{39}-1)
3  QACC_L[ 79: 40] = min(max(QACC_L[ 79: 40] + qx[ 31: 16] * temp[15:0], -2^{39}),
   2^{39}-1)
4  QACC_L[119: 80] = min(max(QACC_L[119: 80] + qx[ 47: 32] * temp[15:0], -2^{39}),
   2^{39}-1)
5  QACC_L[159:120] = min(max(QACC_L[159:120] + qx[ 63: 48] * temp[15:0], -2^{39}),
   2^{39}-1)
6  QACC_H[ 39: 0] = min(max(QACC_H[ 39: 0] + qx[ 79: 64] * temp[15:0], -2^{39}),
   2^{39}-1)
7  QACC_H[ 79: 40] = min(max(QACC_H[ 79: 40] + qx[ 95: 80] * temp[15:0], -2^{39}),
   2^{39}-1)
8  QACC_H[119: 80] = min(max(QACC_H[119: 80] + qx[111: 96] * temp[15:0], -2^{39}),
   2^{39}-1)
9  QACC_H[159:120] = min(max(QACC_H[159:120] + qx[127:112] * temp[15:0], -2^{39}),
   2^{39}-1)

```

1.8.188 EE.VSMULAS.S16.QACC.LD.INCP**Instruction Word**

111000	qu[2:1]	qy[0]	111	qu[0]	sel8[2:0]	qx[1:0]	qy[2:1]	1100	as[3:0]	111	qx[2]
--------	---------	-------	-----	-------	-----------	---------	---------	------	---------	-----	-------

Assembler Syntax

EE.VSMULAS.S16.QACC.LD.INCP qu, as, qx, qy, sel8

Description

This instruction selects one out of the eight 16-bit data segments in register qy according to immediate number sel8 and performs a signed multiplication on it and the eight 16-bit data segments in register qx respectively. The 8 results obtained are added to the corresponding 40-bit data segment in special registers QACC_H and QACC_L respectively. Then, the result is saturated to a 40-bit signed number and then stored to the corresponding 40-bit data segment in QACC_H and QACC_L.

During the operation, the lower 4 bits of the access address in register as are forced to be 0, and then the 16-byte data is loaded from the memory to register qu. After the access, the value in register as is incremented by 16.

Operation

```

1  temp[15:0] = qy[sel8*16+15:sel8*16]
2  QACC_L[ 39: 0] = min(max(QACC_L[ 39: 0] + qx[ 15: 0] * temp[15:0], -2^{39}),
   2^{39}-1)
3  QACC_L[ 79: 40] = min(max(QACC_L[ 79: 40] + qx[ 31: 16] * temp[15:0], -2^{39}),
   2^{39}-1)
4  QACC_L[119: 80] = min(max(QACC_L[119: 80] + qx[ 47: 32] * temp[15:0], -2^{39}),
   2^{39}-1)
5  QACC_L[159:120] = min(max(QACC_L[159:120] + qx[ 63: 48] * temp[15:0], -2^{39}),
   2^{39}-1)
6  QACC_H[ 39: 0] = min(max(QACC_H[ 39: 0] + qx[ 79: 64] * temp[15:0], -2^{39}),
   2^{39}-1)
7  QACC_H[ 79: 40] = min(max(QACC_H[ 79: 40] + qx[ 95: 80] * temp[15:0], -2^{39}),
   2^{39}-1)
8  QACC_H[119: 80] = min(max(QACC_H[119: 80] + qx[111: 96] * temp[15:0], -2^{39}),
   2^{39}-1)
9  QACC_H[159:120] = min(max(QACC_H[159:120] + qx[127:112] * temp[15:0], -2^{39}),
   2^{39}-1)
10
11  qu[127:0] = load128({as[31:4],4{0}})
12  as[31:0] = as[31:0] + 16

```

1.8.189 EE.VSMULAS.S8.QACC

Instruction Word

10	sel16[3:2]	1110	sel16[1]	qy[2]	0	qy[1:0]	qx[2:0]	010	sel16[0]	0100
----	------------	------	----------	-------	---	---------	---------	-----	----------	------

Assembler Syntax

EE.VSMULAS.S8.QACC qx, qy, sel16

Description

This instruction selects one out of the 16 8-bit data segments in register `qy` according to immediate number `sel16` and performs a signed multiplication on it and the 16 8-bit data segments in register `qx` respectively. The 16 results obtained are added to the corresponding 20-bit data segment in special registers `QACC_H` and `QACC_L` respectively. Then, the result is saturated to a 20-bit signed number and then stored to the corresponding 20-bit data segment in `QACC_H` and `QACC_L`.

Operation

```

1  temp[7:0] = qy[sel16*8+7:sel16*8]
2  QACC_L[ 19: 0] = min(max(QACC_L[ 19: 0] + qx[ 7: 0] * temp[7:0], -2^{19}), 2^{19}-1)
3  QACC_L[ 39: 20] = min(max(QACC_L[ 39: 20] + qx[ 15: 8] * temp[7:0], -2^{19}), 2^{19}-1)
4  QACC_L[ 59: 40] = min(max(QACC_L[ 59: 40] + qx[ 23: 16] * temp[7:0], -2^{19}), 2^{19}-1)
5  QACC_L[ 79: 60] = min(max(QACC_L[ 79: 60] + qx[ 31: 24] * temp[7:0], -2^{19}), 2^{19}-1)
6  QACC_L[ 99: 80] = min(max(QACC_L[ 99: 80] + qx[ 39: 32] * temp[7:0], -2^{19}), 2^{19}-1)
7  QACC_L[119:100] = min(max(QACC_L[119:100] + qx[ 47: 40] * temp[7:0], -2^{19}), 2^{19}-1)
8  QACC_L[139:120] = min(max(QACC_L[139:120] + qx[ 55: 48] * temp[7:0], -2^{19}), 2^{19}-1)
9  QACC_L[159:140] = min(max(QACC_L[159:140] + qx[ 63: 56] * temp[7:0], -2^{19}), 2^{19}-1)
10 QACC_H[ 19: 0] = min(max(QACC_H[ 19: 0] + qx[ 71: 64] * temp[7:0], -2^{19}), 2^{19}-1)
11 QACC_H[ 39: 20] = min(max(QACC_H[ 39: 20] + qx[ 79: 72] * temp[7:0], -2^{19}), 2^{19}-1)
12 QACC_H[ 59: 40] = min(max(QACC_H[ 59: 40] + qx[ 87: 80] * temp[7:0], -2^{19}), 2^{19}-1)
13 QACC_H[ 79: 60] = min(max(QACC_H[ 79: 60] + qx[ 95: 88] * temp[7:0], -2^{19}), 2^{19}-1)
14 QACC_H[ 99: 80] = min(max(QACC_H[ 99: 80] + qx[103: 96] * temp[7:0], -2^{19}), 2^{19}-1)
15 QACC_H[119:100] = min(max(QACC_H[119:100] + qx[111:104] * temp[7:0], -2^{19}), 2^{19}-1)
16 QACC_H[139:120] = min(max(QACC_H[139:120] + qx[119:112] * temp[7:0], -2^{19}), 2^{19}-1)
17 QACC_H[159:140] = min(max(QACC_H[159:140] + qx[127:120] * temp[7:0], -2^{19}), 2^{19}-1)

```

1.8.190 EE.VSMULAS.S8.QACC.LD.INCP

Instruction Word

111000	qu[2:1]	qy[0]	01	sel16[0]	qu[0]	sel16[3:1]	qx[1:0]	qy[2:1]	1100	as[3:0]	111	qx[2]
--------	---------	-------	----	----------	-------	------------	---------	---------	------	---------	-----	-------

Assembler Syntax

EE.VSMULAS.S8.QACC.LD.INCP qu, as, qx, qy, sel16

Description

This instruction selects one out of the 16 8-bit data segments in register `qy` according to immediate number `sel16` and performs a signed multiplication on it and the 16 8-bit data segments in register `qx` respectively. The 16 results obtained are added to the corresponding 20-bit data segment in special registers `QACC_H` and `QACC_L` respectively. Then, the result is saturated to a 20-bit signed number and then stored to the corresponding 20-bit data segment in `QACC_H` and `QACC_L`.

During the operation, the lower 4 bits of the access address in register `as` are forced to be 0, and then the 16-byte data is loaded from the memory to register `qu`. After the access, the value in register `as` is incremented by 16.

Operation

```

1  temp[7:0] = qy[sel16*8+7:sel16*8]
2  QACC_L[ 19: 0] = min(max(QACC_L[ 19: 0] + qx[ 7: 0] * temp[7:0], -2^{19}), 2^{19}-1)
3  QACC_L[ 39: 20] = min(max(QACC_L[ 39: 20] + qx[ 15: 8] * temp[7:0], -2^{19}), 2^{19}-1)
4  QACC_L[ 59: 40] = min(max(QACC_L[ 59: 40] + qx[ 23: 16] * temp[7:0], -2^{19}), 2^{19}-1)
5  QACC_L[ 79: 60] = min(max(QACC_L[ 79: 60] + qx[ 31: 24] * temp[7:0], -2^{19}), 2^{19}-1)
6  QACC_L[ 99: 80] = min(max(QACC_L[ 99: 80] + qx[ 39: 32] * temp[7:0], -2^{19}), 2^{19}-1)
7  QACC_L[119:100] = min(max(QACC_L[119:100] + qx[ 47: 40] * temp[7:0], -2^{19}), 2^{19}-1)
8  QACC_L[139:120] = min(max(QACC_L[139:120] + qx[ 55: 48] * temp[7:0], -2^{19}), 2^{19}-1)
9  QACC_L[159:140] = min(max(QACC_L[159:140] + qx[ 63: 56] * temp[7:0], -2^{19}), 2^{19}-1)
10 QACC_H[ 19: 0] = min(max(QACC_H[ 19: 0] + qx[ 71: 64] * temp[7:0], -2^{19}), 2^{19}-1)
11 QACC_H[ 39: 20] = min(max(QACC_H[ 39: 20] + qx[ 79: 72] * temp[7:0], -2^{19}), 2^{19}-1)
12 QACC_H[ 59: 40] = min(max(QACC_H[ 59: 40] + qx[ 87: 80] * temp[7:0], -2^{19}), 2^{19}-1)
13 QACC_H[ 79: 60] = min(max(QACC_H[ 79: 60] + qx[ 95: 88] * temp[7:0], -2^{19}), 2^{19}-1)
14 QACC_H[ 99: 80] = min(max(QACC_H[ 99: 80] + qx[103: 96] * temp[7:0], -2^{19}), 2^{19}-1)
15 QACC_H[119:100] = min(max(QACC_H[119:100] + qx[111:104] * temp[7:0], -2^{19}), 2^{19}-1)
16 QACC_H[139:120] = min(max(QACC_H[139:120] + qx[119:112] * temp[7:0], -2^{19}), 2^{19}-1)
17 QACC_H[159:140] = min(max(QACC_H[159:140] + qx[127:120] * temp[7:0], -2^{19}), 2^{19}-1)
18
19 qu[127:0] = load128({as[31:4],4{0}})
20 as[31:0] = as[31:0] + 16

```

1.8.191 EE.VSR.32

Instruction Word

11	qs[2:1]	1101	qs[0]	01111111	qa[2:0]	0100
----	---------	------	-------	----------	---------	------

Assembler Syntax

EE.VSR.32 qa, qs

Description

This instruction performs an arithmetic right shift on the four 32-bit data segments in register `qs` respectively. The shift amount is the value in the 6-bit special register `SAR`. During the shift process, the higher bits are padded with signed bit. The lower 32 bits of the shift result are stored in the corresponding data segment in register `qa`.

Operation

```

1  qa[ 31: 0] = (qs[ 31: 0] >> SAR[5:0])
2  qa[ 63: 32] = (qs[ 63: 32] >> SAR[5:0])
3  qa[ 95: 64] = (qs[ 95: 64] >> SAR[5:0])
4  qa[127: 96] = (qs[127: 96] >> SAR[5:0])

```

1.8.192 EE.VST.128.IP

Instruction Word

1	imm16[7]	qv[2:1]	1010	qv[0]	imm16[6:0]	as[3:0]	0100
---	----------	---------	------	-------	------------	---------	------

Assembler Syntax

EE.VST.128.IP qv, as, -2048..2032

Description

This instruction forces the lower 4 bits of the access address in register `as` to 0 and stores the 128 bits in register `qv` to memory. After the access is completed, the value in register `as` is incremented by 8-bit sign-extended constant in the instruction code segment left-shifted by 4.

Operation

- 1 `qv[127:0] => store128({as[31:4],4{0}})`
- 2 `as[31:0] = as[31:0] + {20{imm16[7]},imm16[7:0],4{0}}`

1.8.193 EE.VST.128.XP

Instruction Word

10	qv[2:1]	1101	qv[0]	111	ad[3:0]	as[3:0]	0100
----	---------	------	-------	-----	---------	---------	------

Assembler Syntax

EE.VST.128.XP qv, as, ad

Description

This instruction forces the lower 4 bits of the access address in register as to 0 and stores the 128 bits in register qv to memory. After the access is completed, the value in register as is incremented by the value in register ad.

Operation

```
1  qv[127:0] => store128({as[31:4],4{0}})
2  as[31:0] = as[31:0] + ad[31:0]
```

1.8.194 EE.VST.H.64.IP

Instruction Word

1	imm8[7]	qv[2:1]	1011	qv[0]	imm8[6:0]	as[3:0]	0100
---	---------	---------	------	-------	-----------	---------	------

Assembler Syntax

EE.VST.H.64.IP qv, as, -1024..1016

Description

This instruction forces the lower 3 bits of the access address in register as to 0 and stores the upper 64 bits in register qv to memory. After the access is completed, the value in register as is incremented by 8-bit sign-extended constant in the instruction code segment left-shifted by 3.

Operation

```

1  qv[127: 64] => store64({as[31:3],3{0}})
2  as[31:0] = as[31:0] + {21{imm8[7]},imm8[7:0],3{0}}
```

1.8.195 EE.VST.H.64.XP

Instruction Word

11	qv[2:1]	1101	qv[0]	000	ad[3:0]	as[3:0]	0100
----	---------	------	-------	-----	---------	---------	------

Assembler Syntax

EE.VST.H.64.XP qv, as, ad

Description

This instruction forces the lower 3 bits of the access address in register as to 0 and stores the upper 64 bits in register qv to memory. After the access is completed, the value in register as is incremented by the value in register ad.

Operation

```

1  qv[127: 64] => store64({as[31:3],3{0}})
2  as = as + ad[31:0]

```

1.8.196 EE.VST.L.64.IP

Instruction Word

1	imm8[7]	qv[2:1]	0100	qv[0]	imm8[6:0]	as[3:0]	0100
---	---------	---------	------	-------	-----------	---------	------

Assembler Syntax

EE.VST.L.64.IP qv, as, -1024..1016

Description

This instruction forces the lower 3 bits of the access address in register as to 0 and stores the lower 64 bits in register qv to memory. After the access is completed, the value in register as is incremented by 8-bit sign-extended constant in the instruction code segment left-shifted by 3.

Operation

```

1  qv[ 63: 0] => store64({as[31:3],3{0}})
2  as[31:0] = as[31:0] + {21{imm8[7]},imm8[7:0],3{0}}
```

1.8.197 EE.VST.L.64.XP

Instruction Word

11	qv[2:1]	1101	qv[0]	100	ad[3:0]	as[3:0]	0100
----	---------	------	-------	-----	---------	---------	------

Assembler Syntax

EE.VST.L.64.XP qv, as, ad

Description

This instruction forces the lower 3 bits of the access address in register as to 0 and stores the lower 64 bits in register qv to memory. After the access is completed, the value in register as is incremented by the value in register ad.

Operation

```
1  qv[63:0] => store64({as[31:3], 3{0}})
2  as = as + ad[31:0]
```

1.8.198 EE.VSUBS.S16

Instruction Word

10	qa[2:1]	1110	qa[0]	qy[2]	1	qy[1:0]	qx[2:0]	11010100
----	---------	------	-------	-------	---	---------	---------	----------

Assembler Syntax

EE.VSUBS.S16 qa, qx, qy

Description

This instruction performs a vector subtraction on 16-bit data. Registers qx and qy are the subtrahend and the minuend respectively. Then, the 8 results obtained from the calculation are saturated and then written into register qa.

Operation

```

1  qa[ 15: 0] = min(max(qx[ 15: 0] - qy[ 15: 0], -2{15}), 2{15}-1)
2  qa[ 31: 16] = min(max(qx[ 31: 16] - qy[ 31: 16], -2{15}), 2{15}-1)
3  ...

```

1.8.199 EE.VSUBS.S16.LD.INCP

Instruction Word

111000	qu[2:1]	qy[0]	100	qu[0]	qa[2:0]	qx[1:0]	qy[2:1]	1101	as[3:0]	111	qx[2]
--------	---------	-------	-----	-------	---------	---------	---------	------	---------	-----	-------

Assembler Syntax

EE.VSUBS.S16.LD.INCP qu, as, qa, qx, qy

Description

This instruction performs a vector subtraction on 16-bit data. Registers qx and qy are the subtrahend and the minuend respectively. Then, the 8 results obtained from the calculation are saturated and then written into register qa.

During the operation, the lower 4 bits of the access address in register as are forced to be 0, and then the 16-byte data is loaded from the memory to register qu. After the access, the value in register as is incremented by 16.

Operation

```

1  qa[ 15: 0] = min(max(qx[ 15: 0] - qy[ 15: 0], -2{15}), 2{15}-1)
2  qa[ 31: 16] = min(max(qx[ 31: 16] - qy[ 31: 16], -2{15}), 2{15}-1)
3  ...
4
5  qu[127:0] = load128({as[31:4],4{0}})
6  as[31:0] = as[31:0] + 16

```

1.8.200 EE.VSUBS.S16.ST.INCP

Instruction Word

11101000	qy[0]	qv[2:0]	1	qa[2:0]	qx[1:0]	qy[2:1]	0001	as[3:0]	111	qx[2]
----------	-------	---------	---	---------	---------	---------	------	---------	-----	-------

Assembler Syntax

EE.VSUBS.S16.ST.INCP qv, as, qa, qx, qy

Description

This instruction performs a vector subtraction on 16-bit data. Registers qx and qy are the subtrahend and the minuend respectively. Then, the 8 results obtained from the calculation are saturated and then written into register qa.

During the operation, the instruction forces the lower 4 bits of the access address in register as to 0 and stores the value in register qv to memory. After the access, the value in register as is incremented by 16.

Operation

```

1  qa[ 15: 0] = min(max(qx[ 15: 0] - qy[ 15: 0], -2{15}), 2{15}-1)
2  qa[ 31: 16] = min(max(qx[ 31: 16] - qy[ 31: 16], -2{15}), 2{15}-1)
3  ...
4
5  qv[127:0] => store128({as[31:4],4{0}})
6  as[31:0] = as[31:0] + 16

```

1.8.201 EE.VSUBS.S32

Instruction Word

10	qa[2:1]	1110	qa[0]	qy[2]	1	qy[1:0]	qx[2:0]	11100100
----	---------	------	-------	-------	---	---------	---------	----------

Assembler Syntax

EE.VSUBS.S32 qa, qx, qy

Description

This instruction performs a vector subtraction on 32-bit data. Registers qx and qy are the subtrahend and the minuend respectively. Then, the 4 results obtained from the calculation are saturated and then written into register qa.

Operation

```

1  qa[ 31:  0] = min(max(qx[ 31:  0] - qy[ 31:  0], -2{31}), 2{31}-1)
2  qa[ 63: 32] = min(max(qx[ 63: 32] - qy[ 63: 32], -2{31}), 2{31}-1)
3  ...

```

1.8.202 EE.VSUBS.S32.LD.INCP

Instruction Word

111000	qu[2:1]	qy[0]	101	qu[0]	qa[2:0]	qx[1:0]	qy[2:1]	1101	as[3:0]	111	qx[2]
--------	---------	-------	-----	-------	---------	---------	---------	------	---------	-----	-------

Assembler Syntax

EE.VSUBS.S32.LD.INCP qu, as, qa, qx, qy

Description

This instruction performs a vector subtraction on 32-bit data. Registers qx and qy are the subtrahend and the minuend respectively. Then, the 4 results obtained from the calculation are saturated and then written into register qa.

During the operation, the lower 4 bits of the access address in register as are forced to be 0, and then the 16-byte data is loaded from the memory to register qu. After the access, the value in register as is incremented by 16.

Operation

```

1  qa[31:0] = min(max(qx[31:0] - qy[31:0], -2{31}), 2{31}-1)
2  qa[63:32] = min(max(qx[63:32] - qy[63:32], -2{31}), 2{31}-1)
3  ...
4
5  qu[127:0] = load128({as[31:4], 4{0}})
6  as[31:0] = as[31:0] + 16

```

1.8.203 EE.VSUBS.S32.ST.INCP

Instruction Word

11101000	qy[0]	qv[2:0]	1	qa[2:0]	qx[1:0]	qy[2:1]	0010	as[3:0]	111	qx[2]
----------	-------	---------	---	---------	---------	---------	------	---------	-----	-------

Assembler Syntax

EE.VSUBS.S32.ST.INCP qv, as, qa, qx, qy

Description

This instruction performs a vector subtraction on 32-bit data. Registers qx and qy are the subtrahend and the minuend respectively. Then, the 4 results obtained from the calculation are saturated and then written into register qa.

During the operation, the instruction forces the lower 4 bits of the access address in register as to 0 and stores the value in register qv to memory. After the access, the value in register as is incremented by 16.

Operation

```

1  qa[ 31: 0] = min(max(qx[ 31: 0] - qy[ 31: 0], -2^{31}), 2^{31}-1)
2  qa[ 63: 32] = min(max(qx[ 63: 32] - qy[ 63: 32], -2^{31}), 2^{31}-1)
3  ...
4
5  qv[127:0] => store128({as[31:4],4{0}})
6  as[31:0] = as[31:0] + 16

```

1.8.204 EE.VSUBS.S8

Instruction Word

10	qa[2:1]	1110	qa[0]	qy[2]	1	qy[1:0]	qx[2:0]	11110100
----	---------	------	-------	-------	---	---------	---------	----------

Assembler Syntax

EE.VSUBS.S8 qa, qx, qy

Description

This instruction performs a vector subtraction on 8-bit data. Registers qx and qy are the subtrahend and the minuend respectively. Then, the 16 results obtained from the calculation are saturated and then written into register qa.

Operation

```

1  qa[ 7: 0] = min(max(qx[ 7: 0] - qy[ 7: 0], -2{7}), 2{7}-1)
2  qa[15: 8] = min(max(qx[15: 8] - qy[15: 8], -2{7}), 2{7}-1)
3  ...

```

1.8.205 EE.VSUBS.S8.LD.INCP

Instruction Word

111000	qu[2:1]	qy[0]	110	qu[0]	qa[2:0]	qx[1:0]	qy[2:1]	1101	as[3:0]	111	qx[2]
--------	---------	-------	-----	-------	---------	---------	---------	------	---------	-----	-------

Assembler Syntax

EE.VSUBS.S8.LD.INCP qu, as, qa, qx, qy

Description

This instruction performs a vector subtraction on 8-bit data. Registers qx and qy are the subtrahend and the minuend respectively. Then, the 16 results obtained from the calculation are saturated and then written into register qa.

During the operation, the lower 4 bits of the access address in register as are forced to be 0, and then the 16-byte data is loaded from the memory to register qu. After the access, the value in register as is incremented by 16.

Operation

```

1  qa[ 7: 0] = min(max(qx[ 7: 0] - qy[ 7: 0], -2{7}), 2{7}-1)
2  qa[15: 8] = min(max(qx[15: 8] - qy[15: 8], -2{7}), 2{7}-1)
3  ...
4
5  qu[127:0] = load128({as[31:4],4{0}})
6  as[31:0] = as[31:0] + 16

```

1.8.206 EE.VSUBS.S8.ST.INCP

Instruction Word

11101000	qy[0]	qv[2:0]	1	qa[2:0]	qx[1:0]	qy[2:1]	0011	as[3:0]	111	qx[2]
----------	-------	---------	---	---------	---------	---------	------	---------	-----	-------

Assembler Syntax

EE.VSUBS.S8.ST.INCP qv, as, qa, qx, qy

Description

This instruction performs a vector subtraction on 8-bit data. Registers qx and qy are the subtrahend and the minuend respectively. Then, the 16 results obtained from the calculation are saturated and then written into register qa.

During the operation, the instruction forces the lower 4 bits of the access address in register as to 0 and stores the value in register qv to memory. After the access, the value in register as is incremented by 16.

Operation

```

1  qa[ 7: 0] = min(max(qx[ 7: 0] - qy[ 7: 0], -2{7}), 2{7}-1)
2  qa[15: 8] = min(max(qx[15: 8] - qy[15: 8], -2{7}), 2{7}-1)
3  ...
4
5  qv[127:0] => store128({as[31:4],4{0}})
6  as[31:0] = as[31:0] + 16

```

1.8.207 EE.VUNZIP.16

Instruction Word

11	qs1[2:1]	1100	qs1[0]	qs0[2:0]	001110000100
----	----------	------	--------	----------	--------------

Assembler Syntax

EE.VUNZIP.16 qs0, qs1

Description

This instruction implements the unzip algorithm on 16-bit vector data.

Operation

```

1  qs0[ 15: 0] = qs0[ 15: 0]
2  qs0[ 31: 16] = qs0[ 47: 32]
3  qs0[ 47: 32] = qs0[ 79: 64]
4  qs0[ 63: 48] = qs0[111: 96]
5  qs0[ 79: 64] = qs1[ 15: 0]
6  qs0[ 95: 80] = qs1[ 47: 32]
7  qs0[111: 96] = qs1[ 79: 64]
8  qs0[127:112] = qs1[111: 96]
9  qs1[ 15: 0] = qs0[ 31: 16]
10 qs1[ 31: 16] = qs0[ 63: 48]
11 qs1[ 47: 32] = qs0[ 95: 80]
12 qs1[ 63: 48] = qs0[127:112]
13 qs1[ 79: 64] = qs1[ 31: 16]
14 qs1[ 95: 80] = qs1[ 63: 48]
15 qs1[111: 96] = qs1[ 95: 80]
16 qs1[127:112] = qs1[127:112]
```

1.8.208 EE.VUNZIP.32

Instruction Word

11	qs1[2:1]	1100	qs1[0]	qs0[2:0]	001110010100
----	----------	------	--------	----------	--------------

Assembler Syntax

EE.VUNZIP.32 qs0, qs1

Description

This instruction implements the unzip algorithm on 32-bit vector data.

Operation

```

1  qs0[ 31: 0] = qs0[ 31: 0]
2  qs0[ 63: 32] = qs0[ 95: 64]
3  qs0[ 95: 64] = qs1[ 31: 0]
4  qs0[127: 96] = qs1[ 95: 64]
5  qs1[ 31: 0] = qs0[ 63: 32]
6  qs1[ 63: 32] = qs0[127: 96]
7  qs1[ 95: 64] = qs1[ 63: 32]
8  qs1[127: 96] = qs1[127: 96]
```

1.8.209 EE.VUNZIP.8

Instruction Word

11	qs1[2:1]	1100	qs1[0]	qs0[2:0]	001110100100
----	----------	------	--------	----------	--------------

Assembler Syntax

EE.VUNZIP.8 qs0, qs1

Description

This instruction implements the unzip algorithm on 8-bit vector data.

Operation

```

1  qs0[ 7: 0] = qs0[ 7: 0]
2  qs0[ 15: 8] = qs0[ 23: 16]
3  qs0[ 23: 16] = qs0[ 39: 32]
4  qs0[ 31: 24] = qs0[ 55: 48]
5  qs0[ 39: 32] = qs0[ 71: 64]
6  qs0[ 47: 40] = qs0[ 87: 80]
7  qs0[ 55: 48] = qs0[103: 96]
8  qs0[ 63: 56] = qs0[119:112]
9  qs0[ 71: 64] = qs1[ 7: 0]
10 qs0[ 79: 72] = qs1[ 23: 16]
11 qs0[ 87: 80] = qs1[ 39: 32]
12 qs0[ 95: 88] = qs1[ 55: 48]
13 qs0[103: 96] = qs1[ 71: 64]
14 qs0[111:104] = qs1[ 87: 80]
15 qs0[119:112] = qs1[103: 96]
16 qs0[127:120] = qs1[119:112]
17 qs1[ 7: 0] = qs0[ 15: 8]
18 qs1[ 15: 8] = qs0[ 31: 24]
19 qs1[ 23: 16] = qs0[ 47: 40]
20 qs1[ 31: 24] = qs0[ 63: 56]
21 qs1[ 39: 32] = qs0[ 79: 72]
22 qs1[ 47: 40] = qs0[ 95: 88]
23 qs1[ 55: 48] = qs0[111:104]
24 qs1[ 63: 56] = qs0[127:120]
25 qs1[ 71: 64] = qs1[ 15: 8]
26 qs1[ 79: 72] = qs1[ 31: 24]
27 qs1[ 87: 80] = qs1[ 47: 40]
28 qs1[ 95: 88] = qs1[ 63: 56]
29 qs1[103: 96] = qs1[ 79: 72]
30 qs1[111:104] = qs1[ 95: 88]
31 qs1[119:112] = qs1[111:104]
32 qs1[127:120] = qs1[127:120]

```

1.8.210 EE.VZIP.16

Instruction Word

11	qs1[2:1]	1100	qs1[0]	qs0[2:0]	001110110100
----	----------	------	--------	----------	--------------

Assembler Syntax

EE.VZIP.16 qs0, qs1

Description

This instruction implements the zip algorithm on 16-bit vector data.

Operation

```

1  qs0[ 15: 0] = qs0[ 15: 0]
2  qs0[ 31: 16] = qs1[ 15: 0]
3  qs0[ 47: 32] = qs0[ 31: 16]
4  qs0[ 63: 48] = qs1[ 31: 16]
5  qs0[ 79: 64] = qs0[ 47: 32]
6  qs0[ 95: 80] = qs1[ 47: 32]
7  qs0[111: 96] = qs0[ 63: 48]
8  qs0[127:112] = qs1[ 63: 48]
9  qs1[ 15: 0] = qs0[ 79: 64]
10 qs1[ 31: 16] = qs1[ 79: 64]
11 qs1[ 47: 32] = qs0[ 95: 80]
12 qs1[ 63: 48] = qs1[ 95: 80]
13 qs1[ 79: 64] = qs0[111: 96]
14 qs1[ 95: 80] = qs1[111: 96]
15 qs1[111: 96] = qs0[127:112]
16 qs1[127:112] = qs1[127:112]

```

1.8.211 EE.VZIP.32

Instruction Word

11	qs1[2:1]	1100	qs1[0]	qs0[2:0]	001111000100
----	----------	------	--------	----------	--------------

Assembler Syntax

EE.VZIP.32 qs0, qs1

Description

This instruction implements the zip algorithm on 32-bit vector data.

Operation

```

1  qs0[ 31: 0] = qs0[ 31: 0]
2  qs0[ 63: 32] = qs1[ 31: 0]
3  qs0[ 95: 64] = qs0[ 63: 32]
4  qs0[127: 96] = qs1[ 63: 32]
5  qs1[ 31: 0] = qs0[ 95: 64]
6  qs1[ 63: 32] = qs1[ 95: 64]
7  qs1[ 95: 64] = qs0[127: 96]
8  qs1[127: 96] = qs1[127: 96]

```

1.8.212 EE.VZIP.8

Instruction Word

11	qs1[2:1]	1100	qs1[0]	qs0[2:0]	001111010100
----	----------	------	--------	----------	--------------

Assembler Syntax

EE.VZIP.8 qs0, qs1

Description

This instruction implements the zip algorithm on 8-bit vector data.

Operation

```

1  qs0[ 7: 0] = qs0[ 7: 0]
2  qs0[15: 8] = qs1[ 7: 0]
3  qs0[23:16] = qs0[15: 8]
4  qs0[31:24] = qs1[15: 8]
5  qs0[39:32] = qs0[23:16]
6  qs0[47:40] = qs1[23:16]
7  qs0[55:48] = qs0[31:24]
8  qs0[63:56] = qs1[31:24]
9  qs0[71:64] = qs0[39:32]
10 qs0[79:72] = qs1[39:32]
11 qs0[87:80] = qs0[47:40]
12 qs0[95:88] = qs1[47:40]
13 qs0[103:96] = qs0[55:48]
14 qs0[111:104] = qs1[55:48]
15 qs0[119:112] = qs0[63:56]
16 qs0[127:120] = qs1[63:56]
17 qs1[ 7: 0] = qs0[71:64]
18 qs1[15: 8] = qs1[71:64]
19 qs1[23:16] = qs0[79:72]
20 qs1[31:24] = qs1[79:72]
21 qs1[39:32] = qs0[87:80]
22 qs1[47:40] = qs1[87:80]
23 qs1[55:48] = qs0[95:88]
24 qs1[63:56] = qs1[95:88]
25 qs1[71:64] = qs0[103:96]
26 qs1[79:72] = qs1[103:96]
27 qs1[87:80] = qs0[111:104]
28 qs1[95:88] = qs1[111:104]
29 qs1[103:96] = qs0[119:112]
30 qs1[111:104] = qs1[119:112]
31 qs1[119:112] = qs0[127:120]
32 qs1[127:120] = qs1[127:120]

```

1.8.213 EE.WR_MASK_GPIO_OUT

Instruction Word

011100100100	ax[3:0]	as[3:0]	0100
--------------	---------	---------	------

Assembler Syntax

EE.WR_MASK_GPIO_OUT as, ax

Description

It is a dedicated CPU GPIO instruction to set specified bits in GPIO_OUT. The lower 8 bits in register ax store the mask, and the lower 8 bits in register as store the assignment content.

Operation

```
1 GPIO_OUT[7:0] = (GPIO_OUT[7:0] & ~ax[7:0]) | (as[7:0] & ax[7:0])
```

1.8.214 EE.XORQ

Instruction Word

11	qa[2:1]	1101	qa[0]	011	qy[2:1]	01	qx[2:1]	qy[0]	qx[0]	0100
----	---------	------	-------	-----	---------	----	---------	-------	-------	------

Assembler Syntax

EE.XORQ qa, qx, qy

Description

This instruction performs a bitwise XOR operation on registers qx and qy and writes the result of the logical operation to register qa.

Operation

```
1  qa = qx ^ qy
```

1.8.215 EE.ZERO.ACCX

Instruction Word

```
001001010000100000000100
```

Assembler Syntax

```
EE.ZERO.ACCX
```

Description

This instruction clears the value in special register ACCX to 0.

Operation

```
1 ACCX = 0
```

1.8.216 EE.ZERO.Q

Instruction Word

11	qa[2:1]	1101	qa[0]	111111110100100
----	---------	------	-------	-----------------

Assembler Syntax

EE.ZERO.Q qa

Description

This instruction clears the value in register qa to 0.

Operation

1 qa = 0

1.8.217 EE.ZERO.QACC

Instruction Word

```
001001010000100001000100
```

Assembler Syntax

```
EE.ZERO.QACC
```

Description

This instruction clears the values in special registers QACC_L and QACC_H to 0.

Operation

- 1 QACC_L = 0
- 2 QACC_H = 0

2 ULP Coprocessor (ULP-FSM, ULP-RISC-V)

2.1 Overview

The ULP coprocessor is an ultra-low-power processor that remains powered on when the chip is in Deep-sleep (see Chapter 10 *Low-power Management (RTC_CNTL)*). Hence, users can store in RTC memory a program for the ULP coprocessor to access RTC peripherals, internal sensors, and RTC registers during Deep-sleep.

In power-sensitive scenarios, the main CPU goes to sleep mode to lower power consumption. Meanwhile, the coprocessor is woken up by ULP timer, and then monitors the external environment or interacts with the external circuit by controlling peripherals such as RTC GPIO, RTC I2C, SAR ADC, or temperature sensor (TSENS). The coprocessor wakes the main CPU up once a wakeup condition is reached.

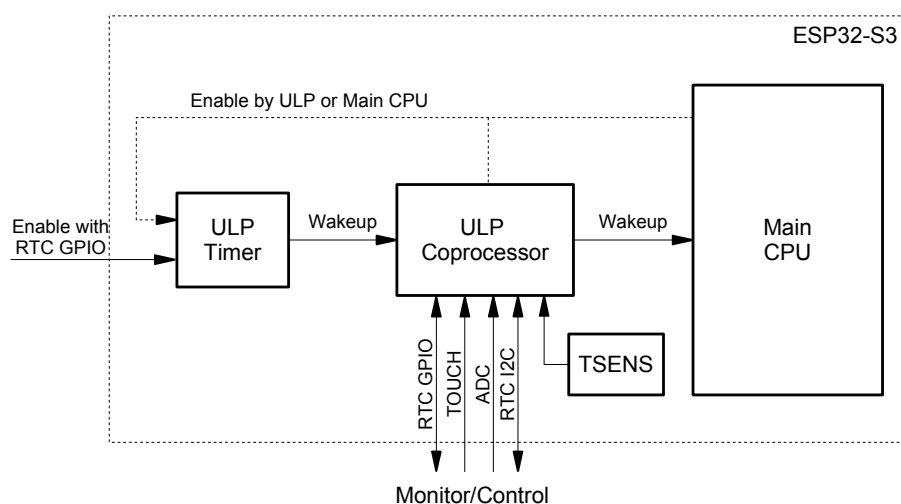

Figure 2-1. ULP Coprocessor Overview

ESP32-S3 has two ULP coprocessors, with one based on RISC-V instruction set architecture (ULP-RISC-V) and the other on finite state machine (ULP-FSM). Users can choose between the two coprocessors depending on their needs.

2.2 Features

- Access up to 8 KB of SRAM RTC slow memory for instructions and data
- Clocked with 17.5 MHz RTC_FAST_CLK
- Support working in normal mode and in monitor mode
- Wake up the CPU or send an interrupt to the CPU
- Access peripherals, internal sensors and RTC registers

ULP-FSM and ULP-RISC-V can not be used simultaneously. Users can only choose one of them as the ULP coprocessor of ESP32-S3. The differences between the two coprocessors are shown in the table below.

Table 2-1. Comparison of the Two Coprocessors

Feature		ULP Coprocessors	
		ULP-FSM	ULP-RISC-V
Memory (RTC Slow Memory)		8 KB	
Work Clock Frequency		17.5 MHz	
Wakeup Source		ULP Timer	
Work Mode	Normal Mode	Assist the main CPU to complete some tasks after the chip is woken up.	
	Monitor Mode	Retrieve data from sensors to monitor environment, when the chip is in sleep.	
Control Low-Power Peripherals		ADC1/ADC2	
		RTC I2C	
		RTC GPIO	
		Touch Sensors	
		Temperature Sensor	
Architecture		Programmable FSM	RISC-V
Development		Special instruction set	Standard C compiler

ULP coprocessor can access the modules in RTC domain via RTC registers. In many cases the ULP coprocessor can be a good supplement to, or replacement of, the main CPU, especially for power-sensitive applications. Figure 2-2 shows the overall layout of ESP32-S3 coprocessor.

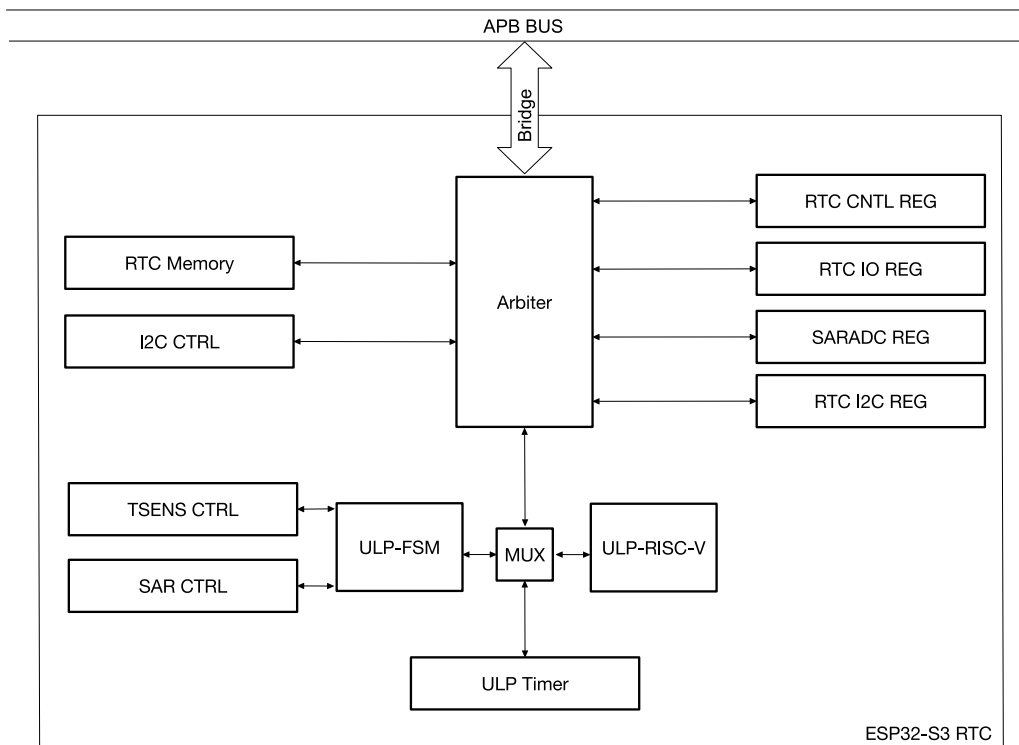

Figure 2-2. ULP Coprocessor Diagram

2.3 Programming Workflow

The ULP-RISC-V is intended for programming using C language. The program in C is then compiled to

[RV32IMC](#) standard instruction code. The ULP-FSM is using custom instructions normally not supported by high-level programming language. Users develop their programs using ULP-FSM instructions (see Section 2.5.2).

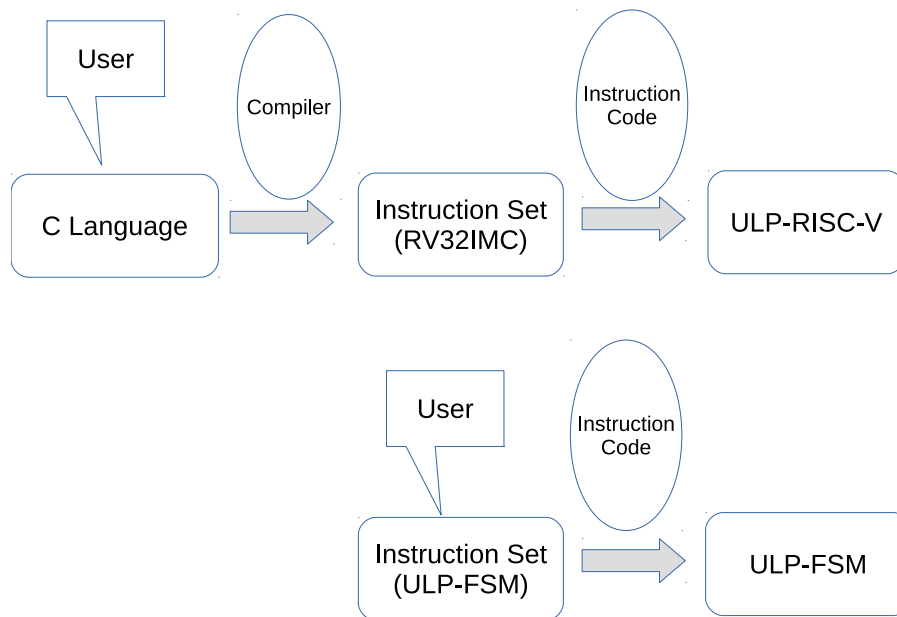

Figure 2-3. Programming Workflow

2.4 ULP Coprocessor Sleep and Wakeup Workflow

ULP coprocessor is designed to operate independently of the CPU, while the CPU is either in sleep or running.

In a typical power-saving scenario, the chip goes to Deep-sleep mode to lower power consumption. Before setting the chip to sleep mode, users should complete the following operations.

1. Flash the program to be executed by ULP coprocessor into RTC slow memory.
2. Select the working ULP coprocessor by configuring [RTC_CNTL_COCPU_SEL](#).
 - 0: select ULP-RISC-V
 - 1: select ULP-FSM
3. If ULP-RISC-V is selected as working ULP coprocessor, please
 - set and reset [RTC_CNTL_COCPU_CLK_FO](#);
 - set [RTC_CNTL_COCPU_CLKGATE_EN](#).
4. Set sleep cycles for the timer by configuring [RTC_CNTL_ULP_CP_TIMER_1_REG](#).
5. Enable the timer by software or by RTC GPIO;
 - By software: set [RTC_CNTL_ULP_CP_SLP_TIMER_EN](#).
 - By RTC GPIO: set [RTC_CNTL_ULP_CP_GPIO_WAKEUP_ENA](#). For more information, see Chapter 10 [Low-power Management \(RTC_CNTL\)](#).
6. Set the system into sleep mode.

When the system is in Deep-sleep mode:

1. The timer periodically sets the low-power controller (see Chapter 10 *Low-power Management (RTC_CNTL)*) to Monitor mode and then wakes up the coprocessor.
2. Coprocessor executes some necessary operations, such as monitoring external environment via low-power sensors.
3. After the operations are finished, the system goes back to Deep-sleep mode.
4. ULP coprocessor goes back to halt mode and waits for next wakeup.

In monitor mode, ULP coprocessor is woken up and goes to halt as shown in Figure 2-4.

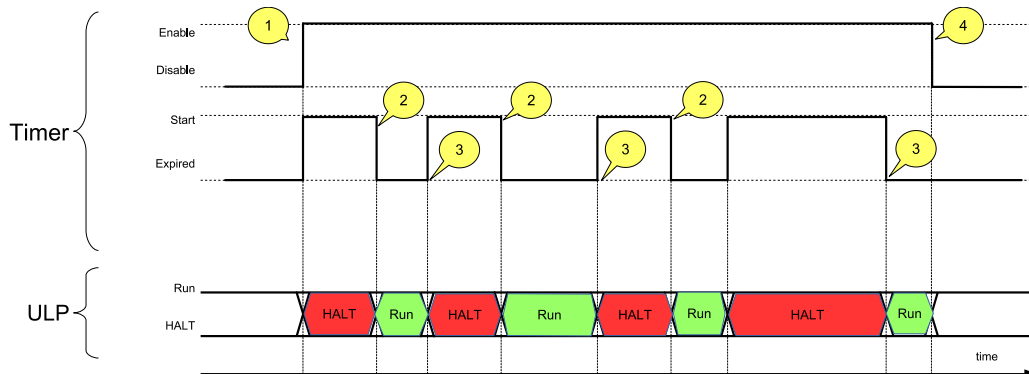

Figure 2-4. ULP Sleep and Wakeup Sequence

1. Enable the timer and the timer starts counting.
2. The timer expires and wakes up the ULP coprocessor. ULP coprocessor starts running and executes the program flashed in RTC slow memory.
3. ULP coprocessor goes to halt and the timer starts counting again.
 - Put ULP-RISC-V into HALT: set `RTC_CNTL_COCPU_DONE`.
 - Put ULP-FSM into HALT: execute HALT instruction.
4. Disable the timer by ULP program or by software. ULP coprocessor exits from monitor mode.
 - Disabled by software: clear `RTC_CNTL_ULP_CP_SLP_TIMER_EN`.
 - Disabled by RTC GPIO: clear `RTC_CNTL_ULP_CP_GPIO_WAKEUP_ENA` and set `RTC_CNTL_ULP_CP_GPIO_WAKEUP_CLR`.

Note:

- If the timer is enabled by software (RTC GPIO), it should be disabled by software (RTC GPIO).
- Before setting ULP-RISC-V to HALT, users should configure `RTC_CNTL_COCPU_DONE` first, therefore, it is recommended to end the flashed program with the following pattern:
 - Set `RTC_CNTL_COCPU_DONE` to end the operation of ULP-RISC-V and put it into halt;
 - Set `RTC_CNTL_COCPU_SHUT_RESET_EN` to reset ULP-RISC-V.

Enough time is reserved for the ULP-RISC-V to complete the operations above before it goes to halt.

Figure 2-5 shows the relationship between the signals and register bits.

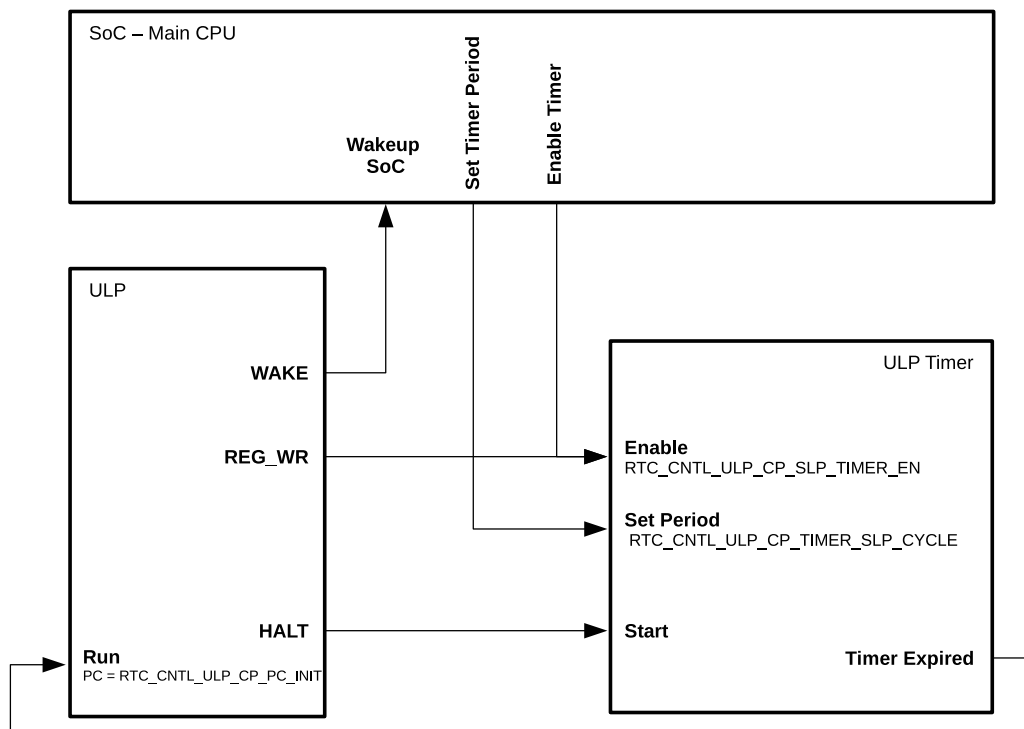

Figure 2-5. Control of ULP Program Execution

2.5 ULP-FSM

2.5.1 Features

ULP-FSM is a programmable finite state machine that can work while the main CPU is in Deep-sleep. ULP-FSM supports instructions for complex logic and arithmetic operations, and also provides dedicated instructions for RTC controllers or peripherals. ULP-FSM can access up to 8 KB of SRAM RTC slow memory (accessible by the CPU) for instructions and data. Hence, such memory is usually used to store instructions and share data between the ULP coprocessor and the CPU. ULP-FSM can be stopped by running HALT instruction.

ULP-FSM has the following features.

- Provides four 16-bit general-purpose registers (R0, R1, R2, and R3) for manipulating data and accessing memory.
- Provides one 8-bit stage count register (Stage_cnt) which can be manipulated by ALU and used in JUMP instructions.
- Supports built-in instructions specially for direct control of low-power peripherals, such as SAR ADC and temperature sensor.

2.5.2 Instruction Set

ULP-FSM supports the following instructions.

- ALU: perform arithmetic and logic operations
- LD, ST, REG_RD and REG_WR: load and store data
- JUMP: jump to a certain address

- WAIT/HALT: manage program execution
- WAKE: wake up CPU or communicate with CPU
- TSENS and ADC: take measurements

Figure 2-6 shows the format of ULP-FSM instructions.

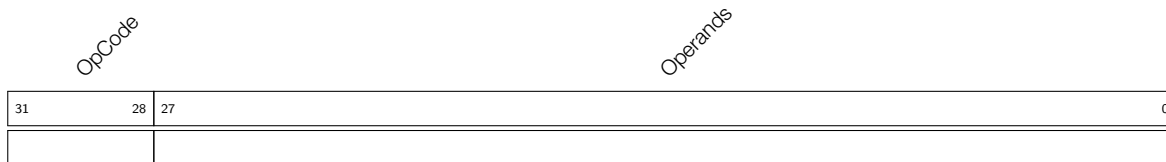

Figure 2-6. ULP-FSM Instruction Format

An instruction, which has one OpCode, can perform various operations, depending on the setting of Operands bits. A good example is the ALU instruction, which is able to perform 10 arithmetic and logic operations; or the JUMP instruction, which may be conditional or unconditional, absolute or relative.

Each instruction has a fixed width of 32 bits. A series of instructions can make a program be executed by the coprocessor. The execution flow inside the program uses 32-bit addressing. The program is stored in a dedicated region called Slow Memory, which is visible to the main CPU under an address range of 0x5000_0000 to 0x5000_1FFF (8 KB).

2.5.2.1 ALU - Perform Arithmetic and Logic Operations

ALU (Arithmetic and Logic Unit) performs arithmetic and logic operations on values stored in ULP coprocessor registers, and on immediate values stored in the instruction itself. The following operations are supported.

- Arithmetic: ADD and SUB
- Logic: bitwise logical AND and bitwise logical OR
- Bit shifting: LSH and RSH
- Moving data to register: MOVE
- PC register operations - STAGE_RST, STAGE_INC, and STAGE_DEC

The ALU instruction, which has one OpCode (7), can perform various arithmetic and logic operations, depending on the setting of the instruction bits [27:21].

Operations Among Registers

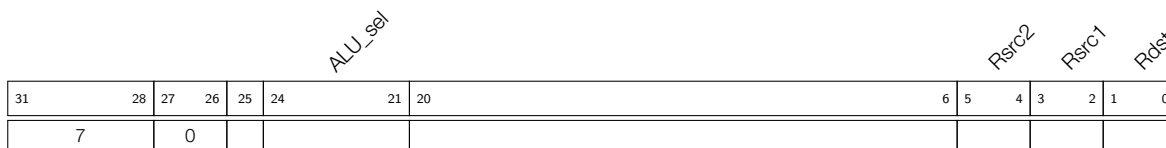

Figure 2-7. Instruction Type – ALU for Operations Among Registers

When bits [27:26] of the instruction in Figure 2-7 are set to 0, ALU performs operations on the data stored in ULP-FSM registers R[0-3]. The types of operations depend on the setting of the instruction bits ALU_sel[24:21] presented in Table 2-2.

Operand Description - see Figure 2-7

<i>Rdst</i>	Register R[0-3], destination
<i>Rsrc1</i>	Register R[0-3], source
<i>Rsrc2</i>	Register R[0-3], source
<i>ALU_sel</i>	ALU operation selection, see Table 2-2

ALU_sel	Instruction	Operation	Description
0	ADD	$Rdst = Rsrc1 + Rsrc2$	Add to register
1	SUB	$Rdst = Rsrc1 - Rsrc2$	Subtract from register
2	AND	$Rdst = Rsrc1 \& Rsrc2$	Bitwise logical AND of two operands
3	OR	$Rdst = Rsrc1 Rsrc2$	Bitwise logical OR of two operands
4	MOVE	$Rdst = Rsrc1$	Move to register
5	LSH	$Rdst = Rsrc1 \ll Rsrc2$	Bit shifting left
6	RSH	$Rdst = Rsrc1 \gg Rsrc2$	Bit shifting right

Table 2-2. ALU Operations Among Registers**Note:**

- ADD or SUB operations can be used to set or clear the overflow flag in ALU.
- All ALU operations can be used to set or clear the zero flag in ALU.

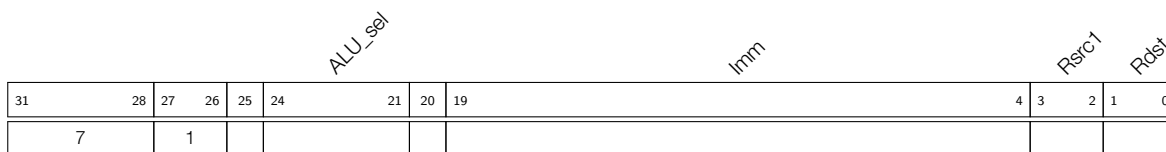
Operations with Immediate Value**Figure 2-8. Instruction Type — ALU for Operations with Immediate Value**

When bits [27:26] of the instruction in Figure 2-8 are set to 1, ALU performs operations using register R[0-3] and the immediate value stored in instruction bits [19:4]. The types of operations depend on the setting of the instruction bits *ALU_sel*[24:21] presented in Table 2-3.

Operand Description - see Figure 2-8

<i>Rdst</i>	Register R[0-3], destination
<i>Rsrc1</i>	Register R[0-3], source
<i>Imm</i>	16-bit signed immediate value
<i>ALU_sel</i>	ALU operation selection, see Table 2-3

Note:

- ADD or SUB operations can be used to set or clear the overflow flag in ALU.
- All ALU operations can be used to set or clear the zero flag in ALU.

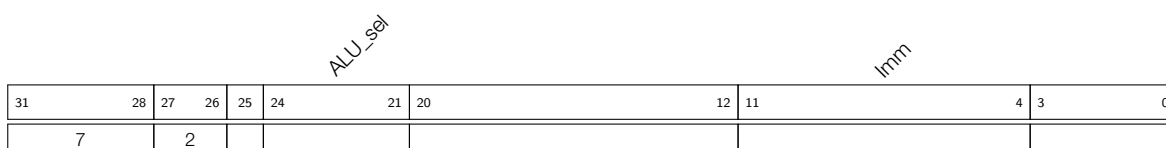
Operations with Stage Count Register

ALU_sel	Instruction	Operation	Description
0	ADD	$Rdst = Rsrc1 + Imm$	Add to register
1	SUB	$Rdst = Rsrc1 - Imm$	Subtract from register
2	AND	$Rdst = Rsrc1 \& Imm$	Bitwise logical AND of two operands
3	OR	$Rdst = Rsrc1 \mid Imm$	Bitwise logical OR of two operands
4	MOVE	$Rdst = Imm$	Move to register
5	LSH	$Rdst = Rsrc1 \ll Imm$	Bit shifting left
6	RSH	$Rdst = Rsrc1 \gg Imm$	Bit shifting right

Table 2-3. ALU Operations with Immediate Value

Figure 2-9. Instruction Type — ALU for Operations with Stage Count Register

ALU is also able to increment or decrement by a given value, or reset the 8-bit register Stage_cnt. To do so, bits [27:26] of instruction in Figure 2-9 should be set to 2. The type of operation depends on the setting of the instruction bits ALU_sel[24:21] presented in Table 2-9. The Stage_cnt is a separate register and is not a part of the instruction in Figure 2-9.

Operand	Description - see Figure 2-9
<i>Imm</i>	8-bit signed immediate value
<i>ALU_sel</i>	ALU operation selection, see Table 2-4
<i>Stage_cnt</i>	Stage count register, a 8-bit separate register used to store variables, such as loop index

ALU_sel	Instruction	Operation	Description
0	STAGE_INC	$Stage_cnt = Stage_cnt + Imm$	Increment stage count register
1	STAGE_DEC	$Stage_cnt = Stage_cnt - Imm$	Decrement stage count register
2	STAGE_RST	$Stage_cnt = 0$	Reset stage count register

Table 2-4. ALU Operations with Stage Count Register

Note: This instruction is mainly used with JUMPS instruction based on the stage count register to form a stage count for-loop. For the usage, please refer to the following pseudocode:

```

STAGE_RST                                // clear stage count register
STAGE_INC                                // stage count register ++
{...}                                     // loop body, containing n instructions
JUMPS (step = n, cond = 0, threshold = m) // If the value of stage count register is less than m, then jump to
STAGE_INC, otherwise jump out of the loop. By such way, a cumulative for-loop with threshold m is implemented.
    
```

2.5.2.2 ST – Store Data in Memory

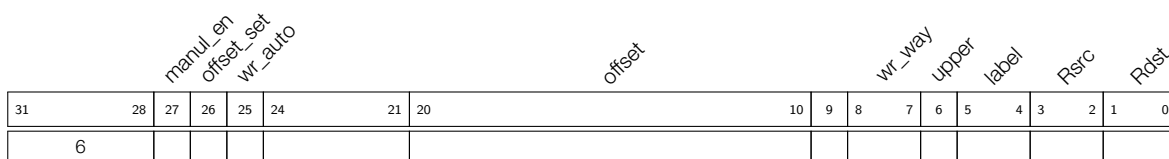
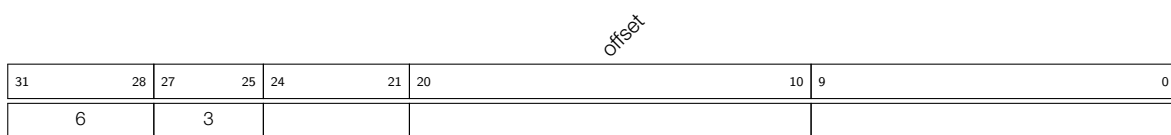

Figure 2-10. Instruction Type - ST

Operand Description - see Figure 2-10

<i>Rdst</i>	Register R[0-3], address of the destination, expressed in 32-bit words
<i>Rsrc</i>	Register R[0-3], 16-bit value to store
<i>label</i>	Data label, 2-bit user defined unsigned value
<i>upper</i>	0: write the low half-word; 1: write the high half-word
<i>wr_way</i>	0: write the full-word; 1: with the label; 3: without the label
<i>offset</i>	11-bit signed value, expressed in 32-bit words
<i>wr_auto</i>	Enable automatic storage mode
<i>offset_set</i>	Offset enable bit. 0: Do not configure the offset for automatic storage mode. 1: Configure the offset for automatic storage mode.
<i>manul_en</i>	Enable manual storage mode

Automatic Storage Mode**Figure 2-11. Instruction Type - Offset in Automatic Storage Mode (ST-OFFSET)****Operand Description** - see Figure 2-11

<i>offset</i>	Initial address offset, 11-bit signed value, expressed in 32-bit words
---------------	--

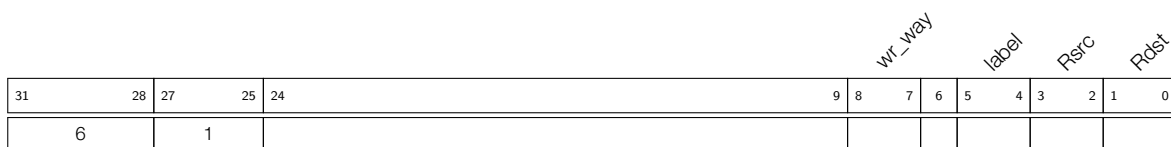
**Figure 2-12. Instruction Type - Data Storage in Automatic Storage Mode (ST-AUTO-DATA)****Operand Description** - See Figure 2-12

<i>Rdst</i>	Register R[0-3], address of the destination, expressed in 32-bit words
<i>Rsrc</i>	Register R[0-3], 16-bit value to store
<i>label</i>	Data label, 2-bit user defined unsigned value
<i>wr_way</i>	0: write the full-word; 1: with the label; 3: without the label

Description

This mode is used to access continuous addresses. Before using this mode for the first time, please configure the initial address using ST-OFFSET instruction. Executing the instruction ST-AUTO-DATA will store the 16-bit data in *Rsrc* into the memory address $Rdst + Offset$, see Table 2-5. Write_cnt here indicates the times of the instruction ST-AUTO-DATA executed.

wr_way	write_cnt	Store Data	Operation
0	*	Mem [Rdst + Offset]{31:0} = {PC[10:0],3'b0,Label[1:0],Rsrc[15:0]}	Write full-word, including the pointer and the data
1	odd	Mem [Rdst + Offset]{15:0} = {Label[1:0],Rsrc[13:0]}	Store the data with label in the low half-word
1	even	Mem [Rdst + Offset]{31:16} = {Label[1:0],Rsrc[13:0]}	Store the data with label in the high half-word
3	odd	Mem [Rdst + Offset]{15:0} = Rsrc[15:0]}	Store the data without label in the low half-word
3	even	Mem [Rdst + Offset]{31:16} = Rsrc[15:0]}	Store the data without label in the high half-word

Table 2-5. Data Storage Type - Automatic Storage Mode

The full-word written to RTC memory is built as follows:

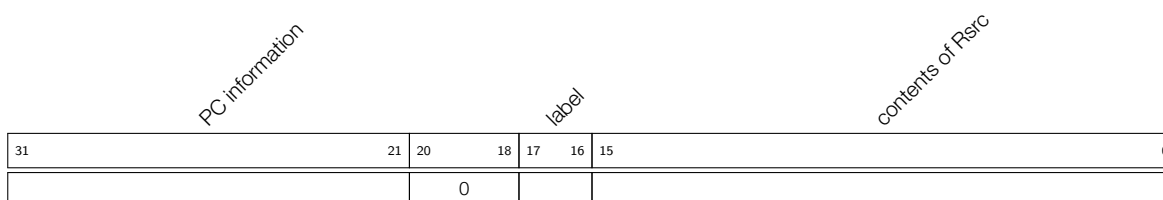

Figure 2-13. Data Structure of RTC_SLOW_MEM[Rdst + Offset]

- Bits** **Description** - See Figure 2-13
- bits [15:0]* store the content of Rsrc
 - bits [17:16]* data label, 2-bit user defined unsigned value
 - bits [20:18]* 3'b0 by default
 - bits [31:21]* hold the PC of current instruction, expressed in 32-bit words

Note:

- When full-word is written, the offset will be automatically incremented by 1 after each ST-AUTO-DATA execution.
- When half-word is written (low half-word first), the offset will be automatically incremented by 1 after twice ST-AUTO-DATA execution.
- This instruction can only access 32-bit memory words.
- The “Mem” written is the RTC_SLOW_MEM memory. Address 0, as seen by the ULP coprocessor, corresponds to address 0x50000000, as seen by the main CPU.

Manual Storage Mode

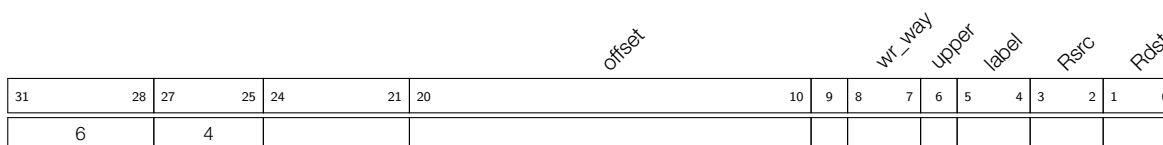

Figure 2-14. Instruction Type - Data Storage in Manual Storage Mode

Operand Description - See Figure 2-14

<i>Rdst</i>	Register R[0-3], address of the destination, expressed in 32-bit words
<i>Rsrc</i>	Register R[0-3], 16-bit value to store
<i>label</i>	Data label, 2-bit user defined unsigned value
<i>upper</i>	0: Write the low half-word; 1: write the high half-word
<i>wr_way</i>	0: Write the full-word; 1: with the label; 3: without the label
<i>offset</i>	11-bit signed value, expressed in 32-bit words

Description

Manual storage mode is mainly used for storing data into discontinuous addresses. Each instruction needs a storage address and offset. The detailed storage methods are shown in Table 2-6.

<i>wr_way</i>	<i>upper</i>	Data	Operation
0	*	Mem [Rdst + Offset]{31:0} = {PC[10:0],3'b0, Label[1:0],Rsrc[15:0]}	Write full-word, including the pointer and the data
1	0	Mem [Rdst + Offset]{15:0} = {Label[1:0],Rsrc[13:0]}	Store the data with label in the low half-word
1	1	Mem [Rdst + Offset]{31:16} = {Label[1:0],Rsrc[13:0]}	Store the data with label in the high half-word
3	0	Mem [Rdst + Offset]{15:0} = Rsrc[15:0]	Store the data without label in the low half-word
3	1	Mem [Rdst + Offset]{31:16} = Rsrc[15:0]	Store the data without label in the high half-word

Table 2-6. Data Storage - Manual Storage Mode

2.5.2.3 LD – Load Data from Memory

Figure 2-15. Instruction Type - LD

Operand Description - see Figure 2-15

<i>Rdst</i>	Register R[0-3], destination
<i>Rsrc</i>	Register R[0-3], address of destination memory, expressed in 32-bit words
<i>Offset</i>	11-bit signed value, expressed in 32-bit words
<i>rd_upper</i>	Choose which half-word to read: 1 - read the high half-word 0 - read the low half-word

Description

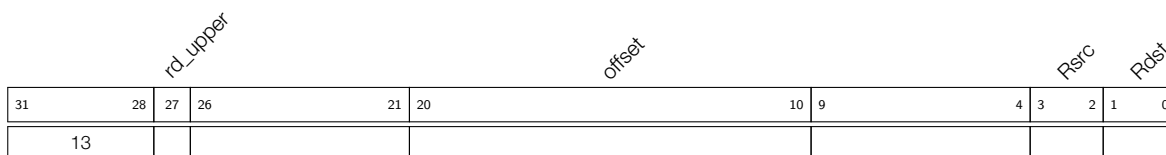
This instruction loads the low or high 16-bit half-word, depending on *rd_upper*, from memory with address *Rsrc* + *offset* into the destination register *Rdst*:

$$Rdst[15:0] = Mem[Rsrc + Offset]$$

Note:

- This instruction can only access 32-bit memory words.
- The “Mem” loaded is the RTC_SLOW_MEM memory. Address 0, as seen by the ULP coprocessor, corresponds to address 0x50000000, as seen by the main CPU.

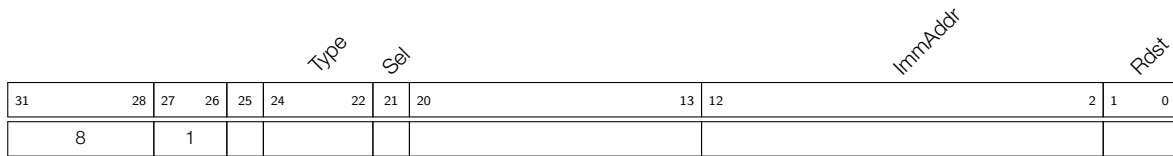
2.5.2.4 JUMP – Jump to an Absolute Address**Figure 2-16. Instruction Type - JUMP****Operand Description** - see Figure 2-16

Rdst Register R[0-3], containing address to jump to (expressed in 32-bit words)

ImmAddr 11-bit address, expressed in 32-bit words

Sel Select the address to jump to:
 0 - jump to the address stored in *ImmAddr*
 1 - jump to the address stored in *Rdst*

Type Jump type:
 0 - make an unconditional jump
 1 - jump only if the last ALU operation has set zero flag
 2 - jump only if the last ALU operation has set overflow flag

Note:

All jump addresses are expressed in 32-bit words.

Description

The instruction executes a jump to a specified address. The jump can be either unconditional or based on the ALU flag.

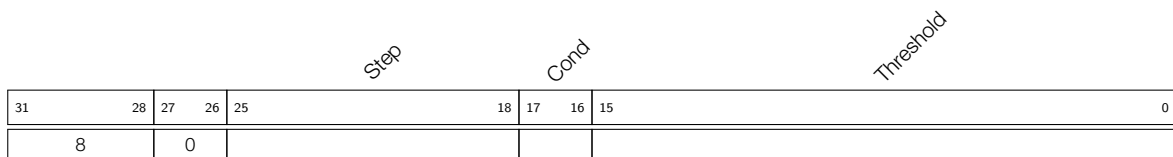
2.5.2.5 JUMPR – Jump to a Relative Address (Conditional upon R0)**Figure 2-17. Instruction Type - JUMPR**

Operand	Description - see Figure 2-17
<i>Threshold</i>	Threshold value for condition (see <i>Cond</i> below) to jump
<i>Cond</i>	Condition to jump: 0 - jump if $R0 < Threshold$ 1 - jump if $R0 > Threshold$ 2 - jump if $R0 = Threshold$
<i>Step</i>	Relative shift from current position, expressed in 32-bit words: if $Step[7] = 0$, then $PC = PC + Step[6:0]$ if $Step[7] = 1$, then $PC = PC - Step[6:0]$

Note:

All jump addresses are expressed in 32-bit words.

Description

The instruction executes a jump to a relative address, if the condition is true. The condition is the result of comparing the R0 register value and the *Threshold* value.

2.5.2.6 JUMPS – Jump to a Relative Address (Conditional upon Stage Count Register)

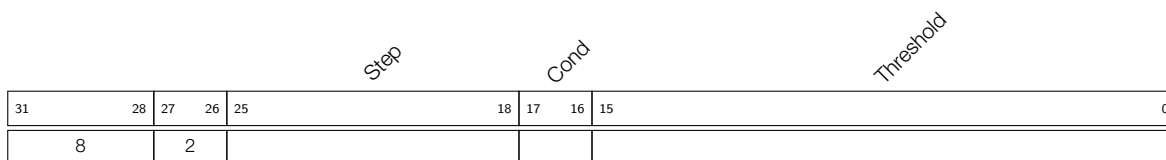

Figure 2-18. Instruction Type - JUMPS

Operand	Description - see Figure 2-18
<i>Threshold</i>	Threshold value for condition (see <i>Cond</i> below) to jump
<i>Cond</i>	Condition to jump: 1X - jump if $Stage_cnt \leq Threshold$ 00 - jump if $Stage_cnt < Threshold$ 01 - jump if $Stage_cnt \geq Threshold$
<i>Step</i>	Relative shift from current position, expressed in 32-bit words: if $Step[7] = 0$, then $PC = PC + Step[6:0]$ if $Step[7] = 1$, then $PC = PC - Step[6:0]$

Note:

- For more information about the stage count register, please refer to Section 2.5.2.1.
- All jump addresses are expressed in 32-bit words.

Description

The instruction executes a jump to a relative address if the condition is true. The condition itself is the result of comparing the value of *Stage_cnt* (stage count register) and the *Threshold* value.

2.5.2.7 HALT – End the Program

31	28	27			0
11					

Figure 2-19. Instruction Type - HALT

Description

The instruction ends the operation of the ULP-FSM and puts it into power-down mode.

Note:

After executing this instruction, the ULP coprocessor wakeup timer gets started.

2.5.2.8 WAKE – Wake up the Chip

31	28	27	26	25	1	0
9		0				
						1'b1

Figure 2-20. Instruction Type - WAKE

Description

This instruction sends an interrupt from the ULP-FSM to the RTC controller.

- If the chip is in Deep-sleep mode, and the ULP wakeup timer is enabled, the above-mentioned interrupt will wake up the chip.
- If the chip is not in Deep-sleep mode, and the ULP interrupt bit `RTC_CNTL_ULP_CP_INT_ENA` is set in register `RTC_CNTL_INT_ENA_REG`, an RTC interrupt will be triggered.

2.5.2.9 WAIT – Wait for a Number of Cycles

31	28	27			16	15	0
4							

Cycles

Figure 2-21. Instruction Type - WAIT

Operand **Description** - see Figure 2-21

Cycles The number of cycles to wait

Description

The instruction will delay the ULP-FSM for a given number of cycles.

2.5.2.10 TSENS – Take Measurement with Temperature Sensor

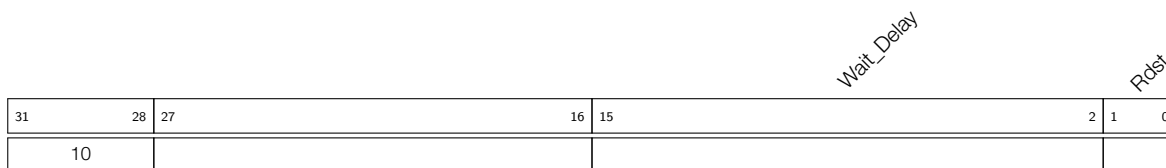

Figure 2-22. Instruction Type - TSENS

Operand Description - see Figure 2-22

Rdst Destination Register R[0-3], results will be stored in this register.

Wait_Delay Number of cycles used to perform the measurement.

Description

Increasing the measurement cycles *Wait_Delay* helps improve the accuracy and optimize the result. The instruction performs measurement via temperature sensor and stores the result into a general purpose register.

2.5.2.11 ADC – Take Measurement with ADC

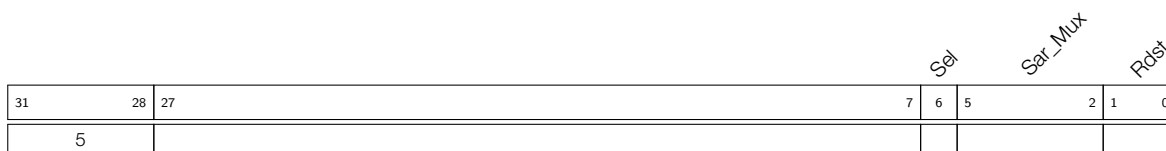

Figure 2-23. Instruction Type - ADC

Operand Description - see Figure 2-23

Rdst Destination Register R[0-3], results will be stored in this register.

Sar_Mux Enable SAR ADC channel. Channel No. is [Sar_Mux - 1]. For more information, see Chapter 39 *On-Chip Sensors and Analog Signal Processing*.

Sel Select ADC. 0: select SAR ADC1; 1: select SAR ADC2, see Table 2-7.

Table 2-7. Input Signals Measured Using the ADC Instruction

Pad/Signal/GPIO	<i>Sar_Mux</i>	ADC Selection (<i>Sel</i>)
GPIO1	1	<i>Sel</i> = 0, select SAR ADC1
GPIO2	2	
GPIO3	3	
GPIO4	4	
GPIO5	5	
GPIO6	6	
GPIO7	7	
GPIO8	8	
GPIO9	9	
GPIO10	10	

Pad/Signal/GPIO	<i>Sar_Mux</i>	ADC Selection <i>Sel</i>
GPIO11	1	<i>Sel</i> = 1, select SAR ADC2
GPIO12	2	
GPIO13	3	
GPIO14	4	
XTAL_32k_P	5	
XTAL_32k_N	6	
GPIO17	7	
GPIO18	8	
GPIO19	9	
GPIO20	10	

2.5.2.12 REG_RD – Read from Peripheral Register

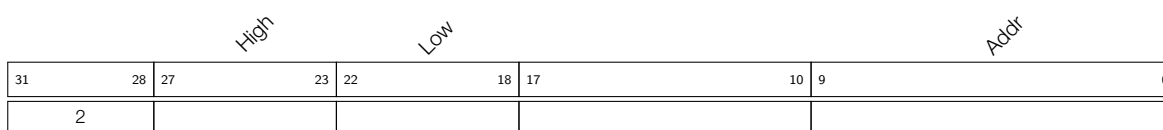

Figure 2-24. Instruction Type - REG_RD

Operand **Description** - see Figure 2-24

Addr Peripheral register address, in 32-bit words

Low Register start bit number

High Register end bit number

Description

The instruction reads up to 16 bits from a peripheral register into a general-purpose register:

$$R0 = \text{REG}[\text{Addr}][\text{High}:\text{Low}]$$

In case of more than 16 bits being requested, i.e. $\text{High} - \text{Low} + 1 > 16$, then the instruction will return $[\text{Low}+15:\text{Low}]$.

Note:

- This instruction can access registers in RTC_CNTL, RTC_IO, SENS, and RTC_I2C peripherals. Address of the register, as seen from the ULP coprocessor (*addr_ulp*), can be calculated from the address of the same register on the main bus (*addr_bus*), as follows:

$$\text{addr_ulp} = (\text{addr_bus} - \text{DR_REG_RTCCNTL_BASE})/4$$

- The *addr_ulp* is expressed in 32-bit words (not in bytes), and value 0 maps onto the DR_REG_RTCCNTL_BASE (as seen from the main CPU). Thus, 10 bits of address cover a 4096-byte range of peripheral register space, including regions DR_REG_RTCCNTL_BASE (0x6000800), DR_REG_RTCIO_BASE (0x60008400), DR_REG_SENS_BASE (0x60008800), and DR_REG_RTC_I2C_BASE (0x60008C00). For more information about address mapping, see Section 2.8.

2.5.2.13 REG_WR – Write to Peripheral Register

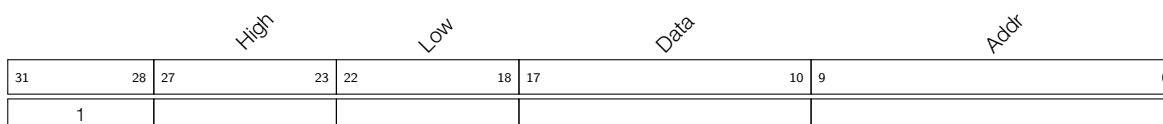

Figure 2-25. Instruction Type - REG_WR

Operand **Description** - see Figure 2-25

Addr Register address, expressed in 32-bit words

Data Value to write, 8 bits

Low Register start bit number

High Register end bit number

Description

This instruction writes up to 8 bits from an immediate data value into a peripheral register.

$$\text{REG}[\text{Addr}][\text{High}:\text{Low}] = \text{Data}$$

If more than 8 bits are requested, i.e. $\text{High} - \text{Low} + 1 > 8$, then the instruction will pad with zeros the bits above the eighth bit.

Note:

See notes regarding *addr_ulp* in Section 2.5.2.12.

2.6 ULP-RISC-V

2.6.1 Features

- Support [RV32IMC](#) instruction set
- Thirty-two 32-bit general-purpose registers
- 32-bit multiplier and divider
- Support for interrupts

2.6.2 Multiplier and Divider

ULP-RISC-V has an independent multiplication and division unit. The efficiency of multiplication and division instructions is shown in the following table.

Table 2-8. Instruction Efficiency

Operation	Instruction	Execution Cycle	Instruction Description
Multiply	MUL	34	Multiply two 32-bit integers and return the lower 32-bit of the result
	MULH	66	Multiply two 32-bit signed integers and return the higher 32-bit of the result
	MULHU	66	Multiply two 32-bit unsigned integers and return the higher 32-bit of the result
	MULHSU	66	Multiply a 32-bit signed integer with a unsigned integer and return the higher 32-bit of the result

Operation	Instruction	Execution Cycle	Instruction Description
Divide	DIV	34	Divide a 32-bit integer by a 32-bit integer and return the quotient
	DIVU	34	Divide a 32-bit unsigned integer by a 32-bit unsigned integer and return the quotient
	REM	34	Divide a 32-bit signed integer by a 32-bit signed integer and return the remainder
	REMU	34	Divide a 32-bit unsigned integer by a 32-bit unsigned integer and return the remainder

2.6.3 ULP-RISC-V Interrupts

2.6.3.1 Introduction

The interrupt controller of ULP-RISC-V is implemented by using a customized instruction set, instead of RISC-V Privileged ISA specification, aiming to reduce the size of ULP-RISC-V.

2.6.3.2 Interrupt Controller

ULP-RISC-V has 32 interrupt sources, but only four of them are available in the real design, as shown in the table below, including:

- internal sources: INT 0 ~ INT 2, triggered by internal interrupt events.
- external source: INT 31, triggered by the peripheral interrupts of ESP32-S3.

Type	IRQ	Triggered by
Internal	0	Internal timer interrupt
Internal	1	EBREAK/ECALL or Illegal Instruction
Internal	2	BUS Error (Unaligned Memory Access)
External	31	RTC peripheral interrupts

Table 2-9. ULP-RISC-V Interrupt Sources

Note:

If illegal instruction interrupt or bus error interrupt is disabled, ULP-RISC-V goes to HALT when the two errors occur.

ULP-RISC-V provides four 32-bit interrupt registers, Q0 ~ Q3, to handle interrupt service routine (ISR). Table 2-10 shows the function of each register.

Register	Function
Q0	Store the returned address. If the interrupt instruction is a compressed one, the lowest bit of this register will be set.
Q1	Bitmap. If the corresponding bit of an interrupt is set, this interrupt will trigger its ISR.
Q2	Reserved. An option for ISR to store data.
Q3	Reserved. An option for ISR to store data.

Table 2-10. ULP-RISC-V Interrupt Registers

Note:

- If more than one bits in Q1 are set, all the corresponding interrupts will call the same ISR. For such reason, users need to program ISR to check the interrupt number and execute corresponding program.
- After ULP-RISC-V is reset, all the interrupts are disabled.

2.6.3.3 Interrupt Instructions

All these interrupt instructions are standard R-type instructions, with the same OpCode of custom0 (0001011). Figure 2-26 shows the format of standard R-type instructions. Note the fields funct3 (f3) and rs2 are ignored in these instructions.

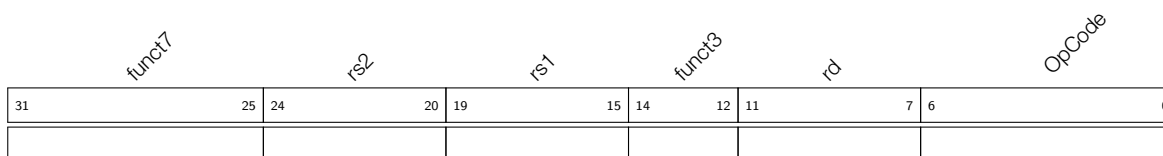

Figure 2-26. Standard R-type Instruction Format

Instruction: getq rd,qs

This instruction copies the value of Q_x into a general purpose register rd.

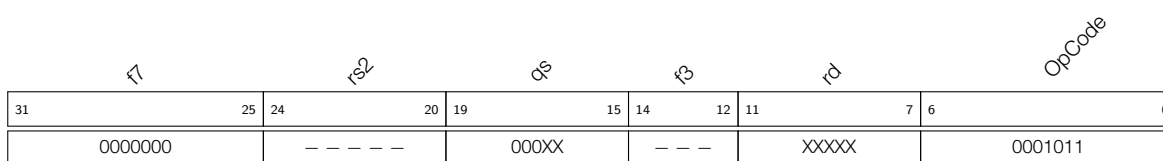

Figure 2-27. Interrupt Instruction - getq rd, qs

Operand Description - See Figure 2-27

- rd* Target general purpose register, holds the value of interrupt register specified by qs.
- qs* Address of interrupt register Q_x.
- f7* Interrupt instruction number.

Instruction: setq qd,rs

This instruction copies the value of general purpose register rs to Q_x.

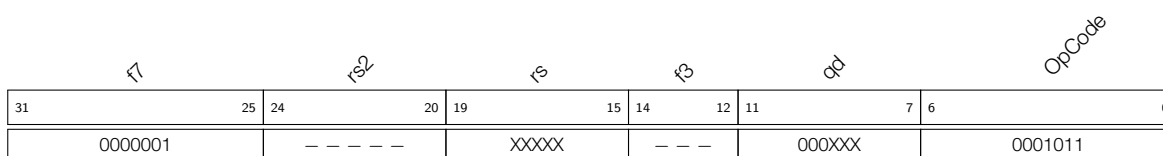

Figure 2-28. Interrupt Instruction - setq qd,rs

Operand **Description** - See Figure 2-28

qd Target interrupt register

rs Source general purpose register, stores the value to be written to interrupt register.

f7 Interrupt instruction number.

Instruction: retirq

This instruction copies the value of Q0 to CPU PC, and enables interrupt again.

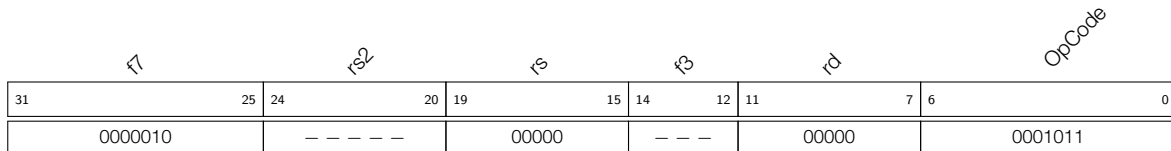

Figure 2-29. Interrupt Instruction - retirq

Operand **Description** - See Figure 2-29

f7 Interrupt instruction number.

Instruction: maskirq rd,rs

This instruction copies the value of Q1 to the register rd, and copies the value of register rs to Q1.

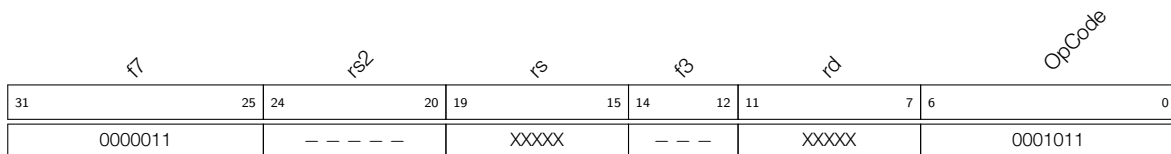

Figure 2-30. Interrupt Instruction — Maskirq rd rs

Operand **Description** - See Figure 2-30

rd Target general purpose register, stores current value of register Q1.

rs Source general purpose register, stores the value to be written to Q1.

f7 Interrupt instruction number.

2.6.3.4 RTC Peripheral Interrupts

The interrupts from some sensors, software, and RTC I2C can be routed to ULP-RISC-V. To enable the interrupts, please set the register [SENS_SAR_COCPU_INT_ENA_REG](#), see Table 2-11.

Enable bit	Interrupt	Description
0	TOUCH_DONE_INT	Triggered when the touch sensor completes the scan of a channel
1	TOUCH_INACTIVE_INT	Triggered when the touch pad is released
2	TOUCH_ACTIVE_INT	Triggered when the touch pad is touched
3	SARADC1_DONE_INT	Triggered when SAR ADC1 completes the conversion one time
4	SARADC2_DONE_INT	Triggered when SAR ADC2 completes the conversion one time
5	TSENS_DONE_INT	Triggered when the temperature sensor completes the dump of its data
6	RISCV_START_INT	Triggered when ULP-RISC-V powers on and starts working
7	SW_INT	Triggered by software
8	SWD_INT	Triggered by timeout of Super Watchdog (SWD)
9	TOUCH_TIME_OUT_INT	Triggered by touch pad sampling timeout
10	TOUCH_APPROACH_LOOP_DONE_INT	Triggered when touch pad completes an APPROACH sampling
11	TOUCH_SCAN_DONE_INT	Triggered when touch pad completes the scan of the final channel

Table 2-11. ULP-RISC-V Interrupt List

Note:

- Besides the above-mentioned interrupts, ULP-RISC-V can also handle the interrupt from RTC_IO by simply configuring RTC_IO as input mode. Users can configure `RTCIO_GPIO_PINn_INT_TYPE` to select the interrupt trigger modes, but only level trigger modes are available. For more details about RTC_IO configuration, see Chapter 6 *IO MUX and GPIO Matrix (GPIO, IO MUX)*.
- The interrupt from RTC_IO can be cleared by releasing RTC_IO and its source can be read from the register `RTCIO_RTC_GPIO_STATUS_REG`.
- The SW_INT interrupt is generated by configuring the register `RTC_CNTL_COCPU_SW_INT_TRIGGER`.
- For the information about RTC I2C interrupts, please refer to Section 2.7.4.

2.7 RTC I2C Controller

ULP coprocessor reads from or writes to external I2C slave devices via RTC I2C controller.

2.7.1 Connecting RTC I2C Signals

SDA and SCL signals can be mapped onto two out of the four GPIO pins, which are identified in Table RTC_MUX Pad List in Chapter 6 *IO MUX and GPIO Matrix (GPIO, IO MUX)*, using the register `RTCIO_SAR_I2C_IO_REG`.

2.7.2 Configuring RTC I2C

Before ULP coprocessor can communicate using I2C instruction, RTC I2C need to be configured. Configuration is performed by writing certain timing parameters into the RTC I2C registers. This can be done by the program running on the main CPU, or by the ULP coprocessor itself.

Note:

The timing parameters are configured in cycles of RTC_FAST_CLK running at 17.5 MHz.

1. Set the low and high SCL half-periods by configuring [RTC_I2C_SCL_LOW_PERIOD_REG](#) and [RTC_I2C_SCL_HIGH_PERIOD_REG](#) in RTC_FAST_CLK cycles (e.g. [RTC_I2C_SCL_LOW_PERIOD_REG](#) = 40, [RTC_I2C_SCL_HIGH_PERIOD_REG](#) = 40 for 100 kHz frequency).
2. Set the number of cycles between the SDA switch and the falling edge of SCL by using [RTC_I2C_SDA_DUTY_REG](#) in RTC_FAST_CLK (e.g. [RTC_I2C_SDA_DUTY_REG](#) = 16).
3. Set the waiting time after the START signal by using [RTC_I2C_SCL_START_PERIOD_REG](#) (e.g. [RTC_I2C_SCL_START_PERIOD](#) = 30).
4. Set the waiting time before the END signal by using [RTC_I2C_SCL_STOP_PERIOD_REG](#) (e.g. [RTC_I2C_SCL_STOP_PERIOD](#) = 44).
5. Set the transaction timeout by using [RTC_I2C_TIME_OUT_REG](#) (e.g. [RTC_I2C_TIME_OUT_REG](#) = 200).
6. Configure the RTC I2C controller into master mode by setting the bit [RTC_I2C_MS_MODE](#) in [RTC_I2C_CTRL_REG](#).
7. Configure the address(es) of external slave(s):
 - If ULP-RISC-V or main CPU is used, then write the slave address to [SENS_SAR_I2C_CTRL_REG\[9:0\]](#).
 - If ULP-FSM is used, then write the slave address to [SENS_I2C_SLAVE_ADDR \$n\$](#) (n : 0-7)

Up to eight slave addresses can be pre-programmed. One of these addresses can then be selected for each transaction as part of the RTC I2C instruction.

Once RTC I2C is configured, the main CPU or the ULP coprocessor can communicate with the external I2C devices.

2.7.3 Using RTC I2C

2.7.3.1 Instruction Format

The format of RTC I2C instruction is consistent with that of I2C0/I2C1, see Section I2C CMD Controller in Chapter 27 *I2C Controller (I2C)*. The only difference is that RTC I2C provides fixed instructions for different operations, as follows:

- Command 0 ~ Command 1: specifically for I2C write operation
- Command 2 ~ Command 6: specifically for I2C read operation

Note: All slave addresses are expressed in 7 bits.

2.7.3.2 I2C_RD - I2C Read Workflow

Preparation for RTC I2C read:

- Configure the instruction list of RTC I2C (see Section CMD_Controller in Chapter 27 *I2C Controller (I2C)*), including instruction order, instruction code, read data number (byte_num), and other information.
- Configure the slave register address by setting the register `SENS_SAR_I2C_CTRL[18:11]`.
- Start RTC I2C transmission by setting `SENS_SAR_I2C_START_FORCE` and `SENS_SAR_I2C_START`.
- When an `RTC_I2C_RX_DATA_INT` interrupt is received, transfer the read data stored in `RTC_I2C_RDATA` to SRAM RTC slow memory, or use the data directly.

The I2C_RD instruction performs the following operations (see Figure 2-31):

1. Master generates a START signal.
2. Master sends slave address, with r/w bit set to 0 (“write”). Slave address is obtained from `SENS_I2C_SLAVE_ADDRn`.
3. Slave generates ACK.
4. Master sends slave register address.
5. Slave generates ACK.
6. Master generates a repeated START (RSTART) signal.
7. Master sends slave address, with r/w bit set to 1 (“read”).
8. Slave sends one byte of data.
9. Master checks whether the number of transmitted bytes reaches the number set by the current instruction (byte_num). If yes, master jumps out of the read instruction and sends an NACK signal. Otherwise master repeats Step 8 and waits for the slave to send the next byte.
10. Master generates a STOP signal and stops reading.

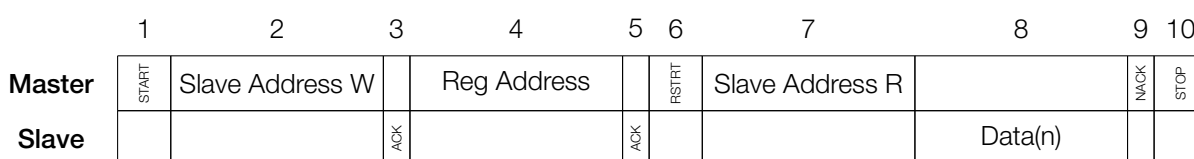

Figure 2-31. I2C Read Operation

Note:

The RTC I2C peripheral samples the SDA signals on the falling edge of SCL. If the slave changes SDA in less than 0.38 ms, the master may receive incorrect data.

2.7.3.3 I2C_WR - I2C Write Workflow

Preparation for RTC I2C write:

- Configure RTC I2C instruction list, including instruction order, instruction code, and the data to be written in byte (byte_num). See the configuration of I2C0/I2C1 in Section CMD_Controller in Chapter 27 *I2C Controller (I2C)*.

- Configure the slave register address by setting the register `SENS_SAR_I2C_CTRL[18:11]`, and the data to be transmitted in `SENS_SAR_I2C_CTRL[26:19]`.
- Set `SENS_SAR_I2C_START_FORCE` and `SENS_SAR_I2C_START` to start the transmission.
- Update the next data to be transmitted in `SENS_SAR_I2C_CTRL[26:19]`, each time when an `RTC_I2C_TX_DATA_INT` interrupt is received.

The `I2C_WR` instruction performs the following operations, see Figure 2-32.

1. Master generates a START signal.
2. Master sends slave address, with r/w bit set to 0 (“write”). Slave address is obtained from `SENS_I2C_SLAVE_ADDRn`.
3. Slave generates ACK.
4. Master sends slave register address.
5. Slave generates ACK.
6. Master generates a repeated START (RSTART) signal.
7. Master sends slave address, with r/w bit set to 0 (“write”).
8. Master sends one byte of data.
9. Slave generates ACK. Master checks whether the number of transmitted bytes reaches the number set by the current instruction (`byte_num`). If yes, master jumps out of the write instruction and starts the next instruction. Otherwise the master repeats Step 8 and sends the next byte.
10. Master generates a STOP signal and stops the transmission.

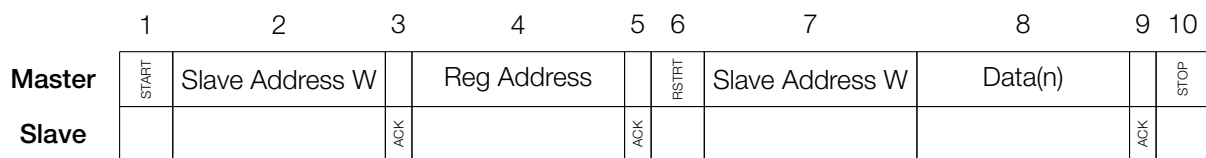

Figure 2-32. I2C Write Operation

2.7.3.4 Detecting Error Conditions

Applications can query specific bits in the `RTC_I2C_INT_ST_REG` register to check if the transaction is successful. To enable checking for specific communication events, their corresponding bits should be set in register `RTC_I2C_INT_ENA_REG`. **Note that the bit map is shifted by 1.** If a specific communication event is detected and its corresponding bit in register `RTC_I2C_INT_ST_REG` is set, the event can then be cleared using register `RTC_I2C_INT_CLR_REG`.

2.7.4 RTC I2C Interrupts

- `RTC_I2C_SLAVE_TRAN_COMP_INT`: Triggered when the slave finishes the transaction.
- `RTC_I2C_ARBITRATION_LOST_INT`: Triggered when the master loses control of the bus.
- `RTC_I2C_MASTER_TRAN_COMP_INT`: Triggered when the master completes the transaction.
- `RTC_I2C_TRANS_COMPLETE_INT`: Triggered when a STOP signal is detected.

- RTC_I2C_TIME_OUT_INT: Triggered by time out event.
- RTC_I2C_ACK_ERR_INT: Triggered by ACK error.
- RTC_I2C_RX_DATA_INT: Triggered when data is received.
- RTC_I2C_TX_DATA_INT: Triggered when data is transmitted.
- RTC_I2C_DETECT_START_INT: Triggered when a START signal is detected.

2.8 Address Mapping

Table 2-12 shows the address mapping and available base registers for the peripherals accessible by ULP coprocessors.

Table 2-12. Address Mapping

Peripheral(s)	Base Register	Main Bus Address	ULP-FSM Base	ULP-RISC-V Base
RTC Control	DR_REG_RTCCNTL_BASE	0x60008000	0x8000	0x8000
RTC GPIO	DR_REG_RTC_IO_BASE	0x60008400	0x8400	0xA400
ADC, Touch, TSENS	DR_REG_SENS_BASE	0x60008800	0x8800	0xC800
RTC I2C	DR_REG_RTC_I2C_BASE	0x60008C00	0x8C00	0xEC00

To find more information about registers for these peripherals, please check the following chapters.

Table 2-13. Description of Registers for Peripherals Accessible by ULP Coprocessors

Registers Available for Peripherals	Described in Which Chapter
Registers for RTC Control	Chapter 10 <i>Low-power Management (RTC_CNTL)</i>
Registers for RTC GPIO	Chapter 6 <i>IO MUX and GPIO Matrix (GPIO, IO MUX)</i>
Registers for ARC, Touch, TSENS	Chapter 39 <i>On-Chip Sensors and Analog Signal Processing</i>
Registers for RTC I2C	Section 2.9 <i>Register Summary</i> in this chapter

2.9 Register Summary

The following registers are used in ULP coprocessor:

- ULP (ALWAYS_ON) registers: not reset due to power down of RTC_PERI domain. See Chapter 10 *Low-power Management (RTC_CNTL)*.
- ULP (RTC_PERI) registers: reset due to power down of RTC_PERI domain. See Chapter 10 *Low-power Management (RTC_CNTL)*.
- RTC I2C registers: I2C related registers, including RTC I2C (RTC_PERI) and RTC I2C (I2C) registers.

2.9.1 ULP (ALWAYS_ON) Register Summary

The addresses in this section are relative to low-power management base address provided in Table 4-3 in Chapter 4 *System and Memory*.

Name	Description	Address	Access
ULP Timer Registers			
RTC_CNTL_ULP_CP_TIMER_REG	Configure the timer	0x00FC	varies
RTC_CNTL_ULP_CP_TIMER_1_REG	Configure sleep cycle of the timer	0x0134	R/W
ULP-FSM Register			
RTC_CNTL_ULP_CP_CTRL_REG	ULP-FSM configuration register	0x0100	R/W
ULP-RISC-V Register			
RTC_CNTL_COCPU_CTRL_REG	ULP-RISC-V configuration register	0x0104	varies

2.9.2 ULP (RTC_PERI) Register Summary

The addresses in this section are relative to low-power management base address provided in Table 4-3 in Chapter 4 *System and Memory*.

Name	Description	Address	Access
ULP-RISC-V Registers			
SENS_SAR_COCPU_INT_RAW_REG	Interrupt raw bit of ULP-RISC-V	0x00E8	RO
SENS_SAR_COCPU_INT_ENA_REG	Interrupt enable bit of ULP-RISC-V	0x00EC	R/W
SENS_SAR_COCPU_INT_ST_REG	Interrupt status bit of ULP-RISC-V	0x00F0	RO
SENS_SAR_COCPU_INT_CLR_REG	Interrupt clear bit of ULP-RISC-V	0x00F4	WO

2.9.3 RTC I2C (RTC_PERI) Register Summary

The addresses in this section are relative to low-power management base address + 0x0800 provided in Table 4-3 in Chapter 4 *System and Memory*.

Name	Description	Address	Access
RTC I2C Controller Register			
SENS_SAR_I2C_CTRL_REG	Configure RTC I2C transmission	0x0058	R/W
RTC I2C Slave Address Registers			
SENS_SAR_SLAVE_ADDR1_REG	Configure slave addresses 0-1 of RTC I2C	0x0040	R/W
SENS_SAR_SLAVE_ADDR2_REG	Configure slave addresses 2-3 of RTC I2C	0x0044	R/W
SENS_SAR_SLAVE_ADDR3_REG	Configure slave addresses 4-5 of RTC I2C	0x0048	R/W
SENS_SAR_SLAVE_ADDR4_REG	Configure slave addresses 6-7 of RTC I2C	0x004C	R/W

2.9.4 RTC I2C (I2C) Register Summary

The addresses in this section are relative to low-power management base address + 0x0C00 provided in Table 4-3 in Chapter 4 *System and Memory*.

Name	Description	Address	Access
RTC I2C Signal Setting Registers			
RTC_I2C_SCL_LOW_REG	Configure the low level width of SCL	0x0000	R/W
RTC_I2C_SCL_HIGH_REG	Configure the high level width of SCL	0x0014	R/W
RTC_I2C_SDA_DUTY_REG	Configure the SDA hold time after a negative SCL edge	0x0018	R/W

Name	Description	Address	Access
RTC_I2C_SCL_START_PERIOD_REG	Configure the delay between the SDA and SCL negative edge for a start condition	0x001C	R/W
RTC_I2C_SCL_STOP_PERIOD_REG	Configure the delay between SDA and SCL positive edge for a stop condition	0x0020	R/W
RTC I2C Control Registers			
RTC_I2C_CTRL_REG	Transmission setting	0x0004	R/W
RTC_I2C_STATUS_REG	RTC I2C status	0x0008	RO
RTC_I2C_TO_REG	Configure RTC I2C timeout	0x000C	R/W
RTC_I2C_SLAVE_ADDR_REG	Configure slave address	0x0010	R/W
RTC I2C Interrupt Registers			
RTC_I2C_INT_CLR_REG	Clear RTC I2C interrupt	0x0024	WO
RTC_I2C_INT_RAW_REG	RTC I2C raw interrupt	0x0028	RO
RTC_I2C_INT_ST_REG	RTC I2C interrupt status	0x002C	RO
RTC_I2C_INT_ENA_REG	Enable RTC I2C interrupt	0x0030	R/W
RTC I2C Status Register			
RTC_I2C_DATA_REG	RTC I2C read data	0x0034	varies
RTC I2C Command Registers			
RTC_I2C_CMD0_REG	RTC I2C Command 0	0x0038	varies
RTC_I2C_CMD1_REG	RTC I2C Command 1	0x003C	varies
RTC_I2C_CMD2_REG	RTC I2C Command 2	0x0040	varies
RTC_I2C_CMD3_REG	RTC I2C Command 3	0x0044	varies
RTC_I2C_CMD4_REG	RTC I2C Command 4	0x0048	varies
RTC_I2C_CMD5_REG	RTC I2C Command 5	0x004C	varies
RTC_I2C_CMD6_REG	RTC I2C Command 6	0x0050	varies
RTC_I2C_CMD7_REG	RTC I2C Command 7	0x0054	varies
RTC_I2C_CMD8_REG	RTC I2C Command 8	0x0058	varies
RTC_I2C_CMD9_REG	RTC I2C Command 9	0x005C	varies
RTC_I2C_CMD10_REG	RTC I2C Command 10	0x0060	varies
RTC_I2C_CMD11_REG	RTC I2C Command 11	0x0064	varies
RTC_I2C_CMD12_REG	RTC I2C Command 12	0x0068	varies
RTC_I2C_CMD13_REG	RTC I2C Command 13	0x006C	varies
RTC_I2C_CMD14_REG	RTC I2C Command 14	0x0070	varies
RTC_I2C_CMD15_REG	RTC I2C Command 15	0x0074	varies
Version register			
RTC_I2C_DATE_REG	Version control register	0x00FC	R/W

2.10 Registers

2.10.1 ULP (ALWAYS_ON) Registers

The addresses in this section are relative to low-power management base address provided in [Table 4-3](#) in [Chapter 4 System and Memory](#).

Register 2.1. RTC_CNTL_ULP_CP_TIMER_REG (0x00FC)

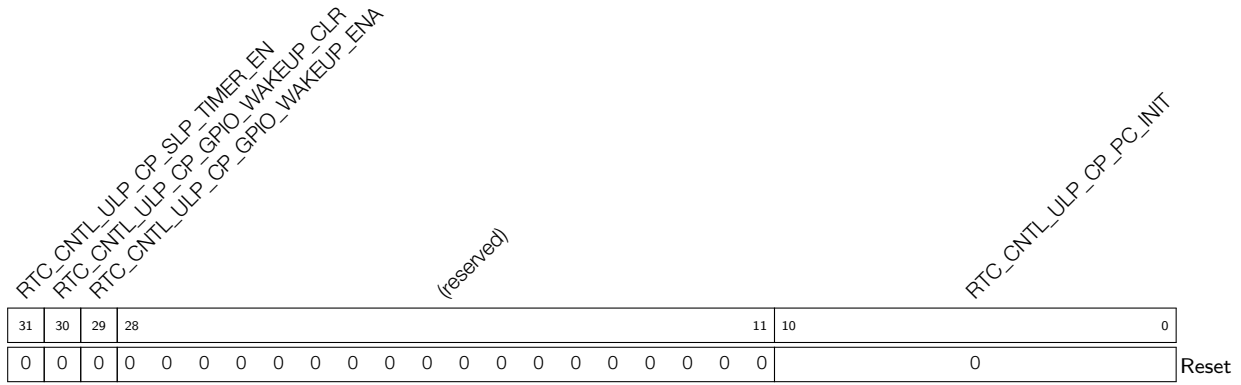

- RTC_CNTL_ULP_CP_PC_INIT** ULP coprocessor PC initial address. (R/W)
- RTC_CNTL_ULP_CP_GPIO_WAKEUP_ENA** Enable the option of ULP timer woken up by RTC GPIO. (R/W)
- RTC_CNTL_ULP_CP_GPIO_WAKEUP_CLR** Disable the option of ULP timer woken up by RTC GPIO. (WO)
- RTC_CNTL_ULP_CP_SLP_TIMER_EN** ULP coprocessor timer enable bit. 0: Disable hardware timer; 1: Enable hardware timer. (R/W)

Register 2.2. RTC_CNTL_ULP_CP_TIMER_1_REG (0x0134)

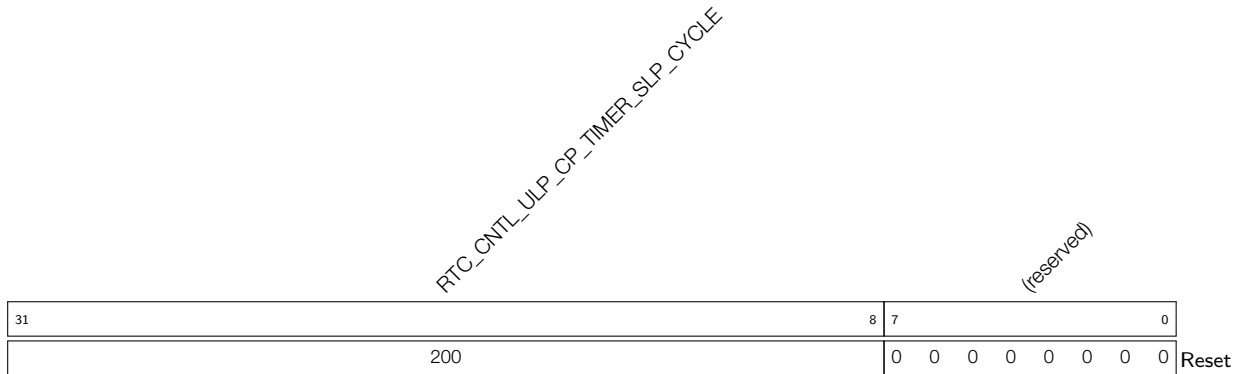

- RTC_CNTL_ULP_CP_TIMER_SLP_CYCLE** Set sleep cycles for ULP coprocessor timer. (R/W)

Register 2.3. RTC_CNTL_ULP_CP_CTRL_REG (0x0100)

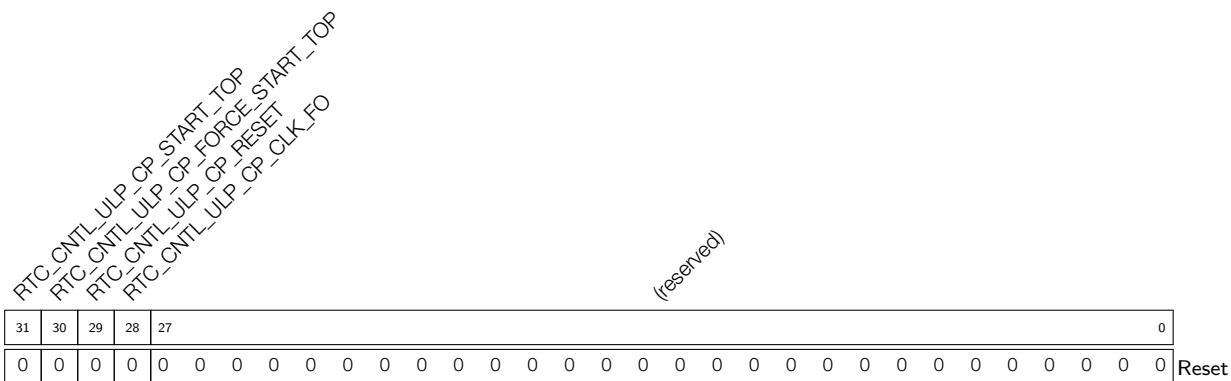

RTC_CNTL_ULP_CP_CLK_FO ULP-FSM clock force on. (R/W)

RTC_CNTL_ULP_CP_RESET ULP-FSM clock software reset. (R/W)

RTC_CNTL_ULP_CP_FORCE_START_TOP Write 1 to start ULP-FSM by software. (R/W)

RTC_CNTL_ULP_CP_START_TOP Write 1 to start ULP-FSM. (R/W)

Register 2.4. RTC_CNTL_COCPU_CTRL_REG (0x0104)

(reserved)				RTC_CNTL_COCPU_CLKGATE_EN				RTC_CNTL_COCPU_SW_INT_TRIGGER				RTC_CNTL_COCPU_SHUT_RESET_EN				RTC_CNTL_COCPU_SHUT_2_CLK_DIS				RTC_CNTL_COCPU_SHUT				RTC_CNTL_COCPU_START_2_INTR_EN				RTC_CNTL_COCPU_START_2_RESET_DIS				RTC_CNTL_COCPU_CLK_FO			
31	28	27	26	25	24	23	22	21	14	13	12	7	6	1	0																				
0	0	0	0	0	0	0	0	1	0	40				0	16				8				0	Reset											

RTC_CNTL_COCPU_CLK_FO ULP-RISC-V clock force on. (R/W)

RTC_CNTL_COCPU_START_2_RESET_DIS Time from ULP-RISC-V startup to pull down reset. (R/W)

RTC_CNTL_COCPU_START_2_INTR_EN Time from ULP-RISC-V startup to send out RISC_V_START_INT interrupt. (R/W)

RTC_CNTL_COCPU_SHUT Shut down ULP-RISC-V. (R/W)

RTC_CNTL_COCPU_SHUT_2_CLK_DIS Time from shut down ULP-RISC-V to disable clock. (R/W)

RTC_CNTL_COCPU_SHUT_RESET_EN This bit is used to reset ULP-RISC-V. (R/W)

RTC_CNTL_COCPU_SEL 0: select ULP-RISC-V; 1: select ULP-FSM. (R/W)

RTC_CNTL_COCPU_DONE_FORCE 0: select ULP-FSM DONE signal; 1: select ULP-RISC-V DONE signal. (R/W)

RTC_CNTL_COCPU_DONE DONE signal. Write 1 to this bit, ULP-RISC-V will go to HALT and the timer starts counting. (R/W)

RTC_CNTL_COCPU_SW_INT_TRIGGER Trigger ULP-RISC-V register interrupt. (WO)

RTC_CNTL_COCPU_CLKGATE_EN Enable ULP-RISC-V clock gate. (WO)

2.10.2 ULP (RTC_PERI) Registers

The addresses in this section are relative to low-power management base address provided in Table 4-3 in Chapter 4 *System and Memory*.

Register 2.5. SENS_SAR_COCPU_INT_RAW_REG (0x00E8)

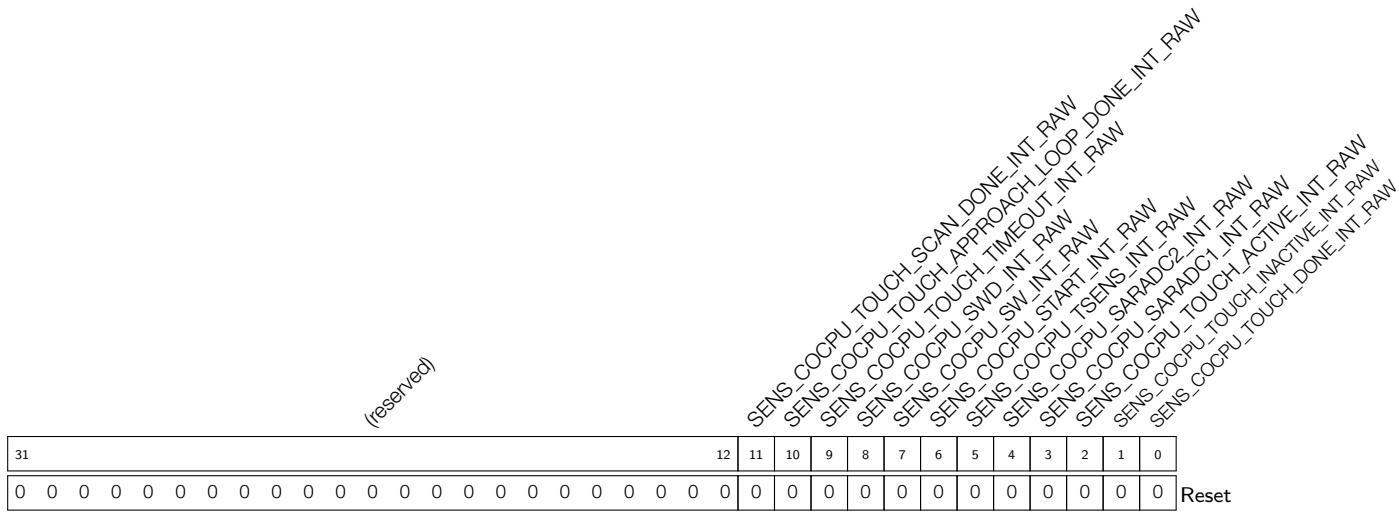

- SENS_COCPU_TOUCH_DONE_INT_RAW** [TOUCH_DONE_INT](#) interrupt raw bit. (RO)
- SENS_COCPU_TOUCH_INACTIVE_INT_RAW** [TOUCH_INACTIVE_INT](#) interrupt raw bit. (RO)
- SENS_COCPU_TOUCH_ACTIVE_INT_RAW** [TOUCH_ACTIVE_INT](#) interrupt raw bit. (RO)
- SENS_COCPU_SARADC1_INT_RAW** [SARADC1_DONE_INT](#) interrupt raw bit. (RO)
- SENS_COCPU_SARADC2_INT_RAW** [SARADC2_DONE_INT](#) interrupt raw bit. (RO)
- SENS_COCPU_TSENS_INT_RAW** [TSENS_DONE_INT](#) interrupt raw bit. (RO)
- SENS_COCPU_START_INT_RAW** [RISCV_START_INT](#) interrupt raw bit. (RO)
- SENS_COCPU_SW_INT_RAW** [SW_INT](#) interrupt raw bit. (RO)
- SENS_COCPU_SWD_INT_RAW** [SWD_INT](#) interrupt raw bit. (RO)
- SENS_COCPU_TOUCH_TIMEOUT_INT_RAW** [TOUCH_TIME_OUT](#) interrupt raw bit. (RO)
- SENS_COCPU_TOUCH_APPROACH_LOOP_DONE_INT_RAW** [TOUCH_APPROACH_LOOP_DONE_INT](#) interrupt raw bit. (RO)
- SENS_COCPU_TOUCH_SCAN_DONE_INT_RAW** [TOUCH_SCAN_DONE_INT](#) interrupt raw bit. (RO)

Register 2.6. SENS_SAR_COCPU_INT_ENA_REG (0x00EC)

(reserved)												SENS_COCPU_TOUCH_SCAN_DONE_INT_ENA SENS_COCPU_TOUCH_APPROACH_LOOP_DONE_INT_ENA SENS_COCPU_TOUCH_TIMEOUT_INT_ENA SENS_COCPU_SWD_INT_ENA SENS_COCPU_SW_INT_ENA SENS_COCPU_TSENS_INT_ENA SENS_COCPU_SARADC2_INT_ENA SENS_COCPU_SARADC1_INT_ENA SENS_COCPU_TOUCH_ACTIVE_INT_ENA SENS_COCPU_TOUCH_INACTIVE_INT_ENA												
31												12	11	10	9	8	7	6	5	4	3	2	1	0
0 0																								Reset

- SENS_COCPU_TOUCH_DONE_INT_ENA** [TOUCH_DONE_INT](#) interrupt enable bit. (R/W)
- SENS_COCPU_TOUCH_INACTIVE_INT_ENA** [TOUCH_INACTIVE_INT](#) interrupt enable bit. (R/W)
- SENS_COCPU_TOUCH_ACTIVE_INT_ENA** [TOUCH_ACTIVE_INT](#) interrupt enable bit. (R/W)
- SENS_COCPU_SARADC1_INT_ENA** [SARADC1_DONE_INT](#) interrupt enable bit. (R/W)
- SENS_COCPU_SARADC2_INT_ENA** [SARADC2_DONE_INT](#) interrupt enable bit. (R/W)
- SENS_COCPU_TSENS_INT_ENA** [TSENS_DONE_INT](#) interrupt enable bit. (R/W)
- SENS_COCPU_START_INT_ENA** [RISCV_START_INT](#) interrupt enable bit. (R/W)
- SENS_COCPU_SW_INT_ENA** [SW_INT](#) interrupt enable bit. (R/W)
- SENS_COCPU_SWD_INT_ENA** [SWD_INT](#) interrupt enable bit. (R/W)
- SENS_COCPU_TOUCH_TIMEOUT_INT_ENA** [TOUCH_TIME_OUT](#) interrupt enable bit. (R/W)
- SENS_COCPU_TOUCH_APPROACH_LOOP_DONE_INT_ENA** [TOUCH_APPROACH_LOOP_DONE_INT](#) interrupt enable bit. (R/W)
- SENS_COCPU_TOUCH_SCAN_DONE_INT_ENA** [TOUCH_SCAN_DONE_INT](#) interrupt enable bit. (R/W)

Register 2.7. SENS_SAR_COCPU_INT_ST_REG (0x00F0)

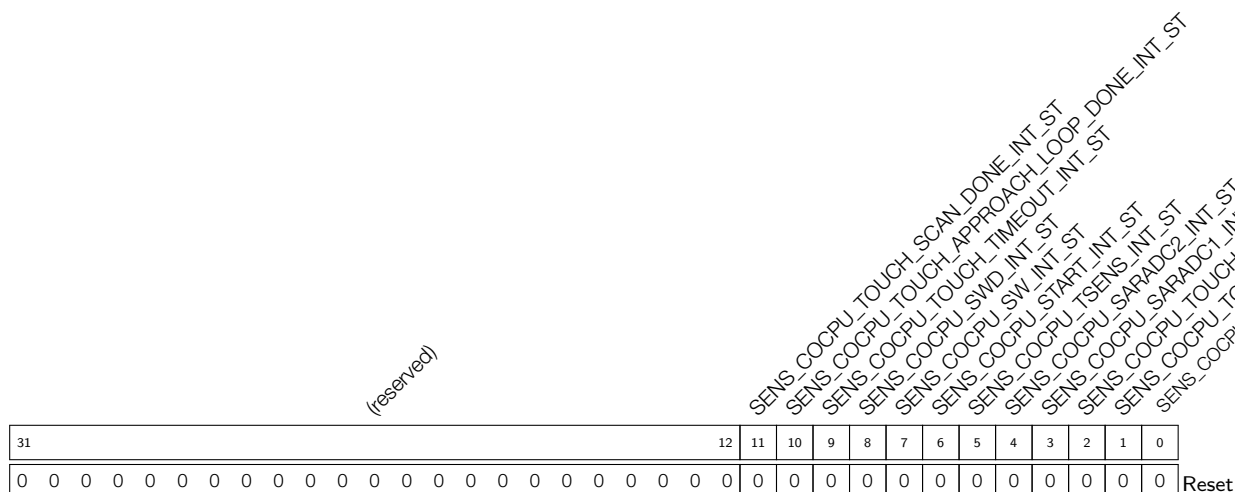

- SENS_COCPU_TOUCH_DONE_INT_ST TOUCH_DONE_INT interrupt status bit. (RO)
- SENS_COCPU_TOUCH_INACTIVE_INT_ST TOUCH_INACTIVE_INT interrupt status bit. (RO)
- SENS_COCPU_TOUCH_ACTIVE_INT_ST TOUCH_ACTIVE_INT interrupt status bit. (RO)
- SENS_COCPU_SARADC1_DONE_INT_ST SARADC1_DONE_INT interrupt status bit. (RO)
- SENS_COCPU_SARADC2_DONE_INT_ST SARADC2_DONE_INT interrupt status bit. (RO)
- SENS_COCPU_TSENS_DONE_INT_ST TSENS_DONE_INT interrupt status bit. (RO)
- SENS_COCPU_START_INT_ST RISC_V_START_INT interrupt status bit. (RO)
- SENS_COCPU_SW_INT_ST SW_INT interrupt status bit. (RO)
- SENS_COCPU_SWD_INT_ST SWD_INT interrupt status bit. (RO)
- SENS_COCPU_TOUCH_TIMEOUT_INT_ST TOUCH_TIME_OUT interrupt status bit. (RO)
- SENS_COCPU_TOUCH_APPROACH_LOOP_DONE_INT_ST TOUCH_APPROACH_LOOP_DONE_INT interrupt status bit. (RO)
- SENS_COCPU_TOUCH_SCAN_DONE_INT_ST TOUCH_SCAN_DONE_INT interrupt status bit. (RO)

Register 2.8. SENS_SAR_COCPU_INT_CLR_REG (0x00F4)

(reserved)												SENS_COCPU_TOUCH_SCAN_DONE_INT_CLR SENS_COCPU_TOUCH_APPROACH_LOOP_DONE_INT_CLR SENS_COCPU_TOUCH_INACTIVE_INT_CLR SENS_COCPU_TOUCH_ACTIVE_INT_CLR SENS_COCPU_SARADC1_DONE_INT_CLR SENS_COCPU_SARADC2_DONE_INT_CLR SENS_COCPU_TSSENS_DONE_INT_CLR SENS_COCPU_START_INT_CLR SENS_COCPU_SW_INT_CLR SENS_COCPU_SWD_INT_CLR SENS_COCPU_TOUCH_TIMEOUT_INT_CLR												
31											12	11	10	9	8	7	6	5	4	3	2	1	0	Reset
0 0																								

SENS_COCPU_TOUCH_DONE_INT_CLR [TOUCH_DONE_INT](#) interrupt clear bit. (WO)

SENS_COCPU_TOUCH_INACTIVE_INT_CLR [TOUCH_INACTIVE_INT](#) interrupt clear bit. (WO)

SENS_COCPU_TOUCH_ACTIVE_INT_CLR [TOUCH_ACTIVE_INT](#) interrupt clear bit. (WO)

SENS_COCPU_SARADC1_INT_CLR [SARADC1_DONE_INT](#) interrupt clear bit. (WO)

SENS_COCPU_SARADC2_INT_CLR [SARADC2_DONE_INT](#) interrupt clear bit. (WO)

SENS_COCPU_TSSENS_INT_CLR [TSSENS_DONE_INT](#) interrupt clear bit. (WO)

SENS_COCPU_START_INT_CLR [RISCV_START_INT](#) interrupt clear bit. (WO)

SENS_COCPU_SW_INT_CLR [SW_INT](#) interrupt clear bit. (WO)

SENS_COCPU_SWD_INT_CLR [SWD_INT](#) interrupt clear bit. (WO)

SENS_COCPU_TOUCH_TIMEOUT_INT_CLR [TOUCH_TIME_OUT](#) interrupt clear bit. (WO)

SENS_COCPU_TOUCH_APPROACH_LOOP_DONE_INT_CLR [TOUCH_APPROACH_LOOP_DONE_INT](#) interrupt clear bit. (WO)

SENS_COCPU_TOUCH_SCAN_DONE_INT_CLR [TOUCH_SCAN_DONE_INT](#) interrupt clear bit. (WO)

2.10.3 RTC I2C (RTC_PERI) Registers

The addresses in this section are relative to low-power management base address + 0x0800 provided in Table 4-3 in Chapter 4 *System and Memory*.

Register 2.9. SENS_SAR_I2C_CTRL_REG (0x0058)

(reserved)					SENS_SAR_I2C_START_FORCE					SENS_SAR_I2C_START					SENS_SAR_I2C_CTRL					
31	30	29	28	27																0
0	0	0	0							0										Reset

SENS_SAR_I2C_CTRL RTC I2C control data; active only when [SENS_SAR_I2C_START_FORCE](#) = 1. (R/W)

SENS_SAR_I2C_START Start RTC I2C; active only when [SENS_SAR_I2C_START_FORCE](#) = 1. (R/W)

SENS_SAR_I2C_START_FORCE 0: RTC I2C started by FSM; 1: RTC I2C started by software. (R/W)

Register 2.10. SENS_SAR_SLAVE_ADDR1_REG (0x0040)

(reserved)										SENS_I2C_SLAVE_ADDR0										SENS_I2C_SLAVE_ADDR1															
31											22	21											11	10											0
0	0	0	0	0	0	0	0	0	0	0	0x0										0x0										Reset				

SENS_I2C_SLAVE_ADDR1 RTC I2C slave address 1. (R/W)

SENS_I2C_SLAVE_ADDR0 RTC I2C slave address 0. (R/W)

Register 2.11. SENS_SAR_SLAVE_ADDR2_REG (0x0044)

(reserved)										SENS_I2C_SLAVE_ADDR2										SENS_I2C_SLAVE_ADDR3															
31											22	21											11	10											0
0	0	0	0	0	0	0	0	0	0	0	0x0										0x0										Reset				

SENS_I2C_SLAVE_ADDR3 RTC I2C slave address 3. (R/W)

SENS_I2C_SLAVE_ADDR2 RTC I2C slave address 2. (R/W)

Register 2.12. SENS_SAR_SLAVE_ADDR3_REG (0x0048)

(reserved)										SENS_I2C_SLAVE_ADDR4											SENS_I2C_SLAVE_ADDR5																
31											22	21												11	10												0
0 0 0 0 0 0 0 0 0 0										0x0											0x0											Reset					

SENS_I2C_SLAVE_ADDR5 RTC I2C slave address 5. (R/W)

SENS_I2C_SLAVE_ADDR4 RTC I2C slave address 4. (R/W)

Register 2.13. SENS_SAR_SLAVE_ADDR4_REG (0x004C)

(reserved)										SENS_I2C_SLAVE_ADDR6											SENS_I2C_SLAVE_ADDR7																
31											22	21												11	10												0
0 0 0 0 0 0 0 0 0 0										0x0											0x0											Reset					

SENS_I2C_SLAVE_ADDR7 RTC I2C slave address 7. (R/W)

SENS_I2C_SLAVE_ADDR6 RTC I2C slave address 6. (R/W)

2.10.4 RTC I2C (I2C) Registers

The addresses in this section are relative to low-power management base address + 0x0C00 provided in Table 4-3 in Chapter 4 *System and Memory*.

Register 2.14. RTC_I2C_SCL_LOW_REG (0x0000)

(reserved)										RTC_I2C_SCL_LOW_PERIOD														
31											20	19												0
0 0 0 0 0 0 0 0 0 0										0x100											Reset			

RTC_I2C_SCL_LOW_PERIOD This register is used to configure how many clock cycles SCL remains low. (R/W)

Register 2.15. RTC_I2C_SCL_HIGH_REG (0x0014)

RTC_I2C_SCL_HIGH_PERIOD This register is used to configure how many cycles SCL remains high.
(R/W)

Register 2.16. RTC_I2C_SDA_DUTY_REG (0x0018)

RTC_I2C_SDA_DUTY_NUM The number of clock cycles between the SDA switch and the falling edge of SCL. (R/W)

Register 2.17. RTC_I2C_SCL_START_PERIOD_REG (0x001C)

RTC_I2C_SCL_START_PERIOD Number of clock cycles to wait after generating a start condition.
(R/W)

Register 2.20. RTC_I2C_STATUS_REG (0x0008)

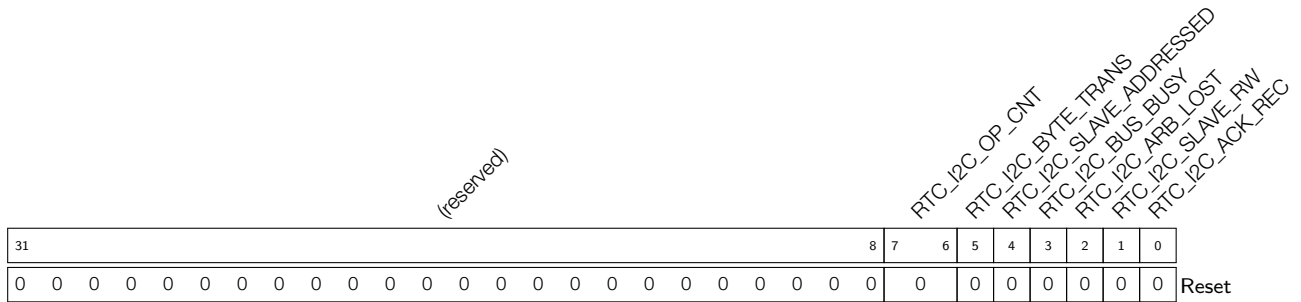

- RTC_I2C_ACK_REC** The received ACK value. 0: ACK; 1: NACK. (RO)
- RTC_I2C_SLAVE_RW** 0: master writes to slave; 1: master reads from slave. (RO)
- RTC_I2C_ARB_LOST** When the RTC I2C loses control of SCL line, the register changes to 1. (RO)
- RTC_I2C_BUS_BUSY** 0: RTC I2C bus is in idle state; 1: RTC I2C bus is busy transferring data. (RO)
- RTC_I2C_SLAVE_ADDRESSED** When the address sent by the master matches the address of the slave, then this bit will be set. (RO)
- RTC_I2C_BYTE_TRANS** This field changes to 1 when one byte is transferred. (RO)
- RTC_I2C_OP_CNT** Indicate which operation is working. (RO)

Register 2.21. RTC_I2C_TIMEOUT_REG (0x000C)

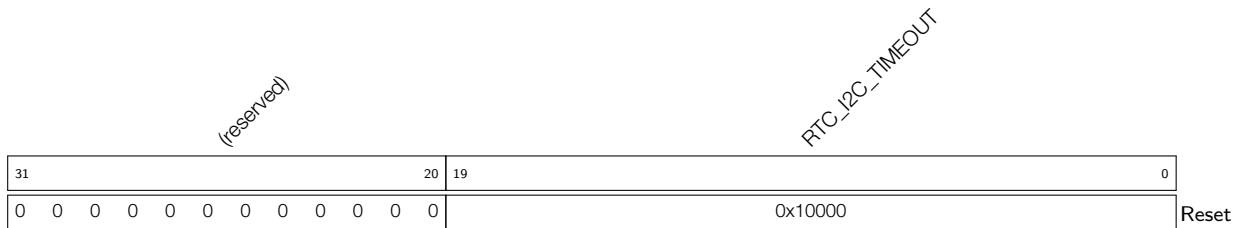

- RTC_I2C_TIMEOUT** Timeout threshold. (R/W)

Register 2.22. RTC_I2C_SLAVE_ADDR_REG (0x0010)

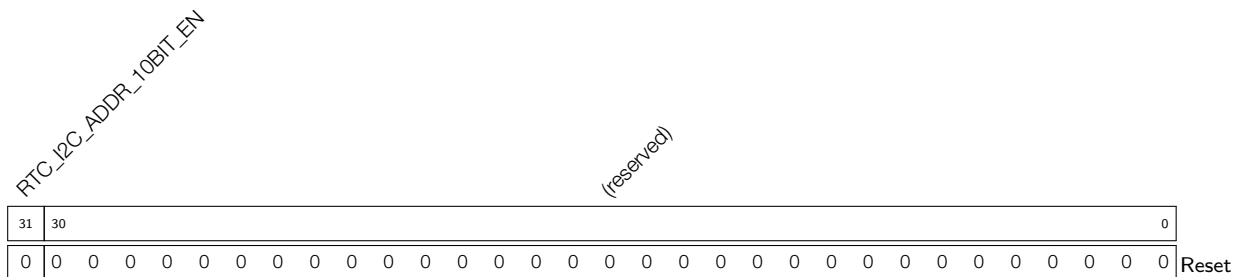

- RTC_I2C_ADDR_10BIT_EN** This field is used to enable the slave 10-bit addressing mode. (R/W)

Register 2.23. RTC_I2C_INT_CLR_REG (0x0024)

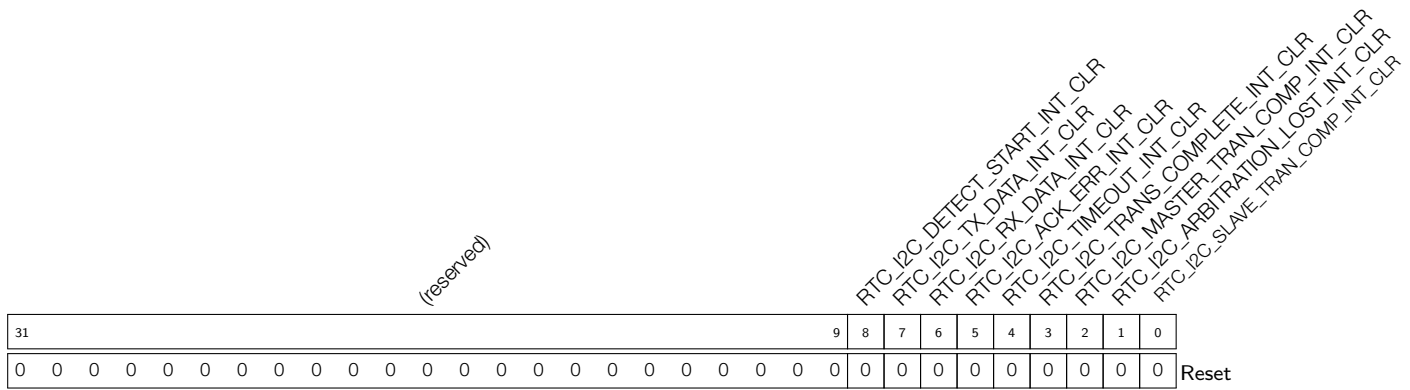

RTC_I2C_SLAVE_TRAN_COMP_INT_CLR [RTC_I2C_SLAVE_TRAN_COMP_INT](#) interrupt clear bit. (WO)

RTC_I2C_ARBITRATION_LOST_INT_CLR [RTC_I2C_ARBITRATION_LOST_INT](#) interrupt clear bit. (WO)

RTC_I2C_MASTER_TRAN_COMP_INT_CLR [RTC_I2C_MASTER_TRAN_COMP_INT](#) interrupt clear bit. (WO)

RTC_I2C_TRANS_COMPLETE_INT_CLR [RTC_I2C_TRANS_COMPLETE_INT](#) interrupt clear bit. (WO)

RTC_I2C_TIMEOUT_INT_CLR [RTC_I2C_TIMEOUT_INT](#) interrupt clear bit. (WO)

RTC_I2C_ACK_ERR_INT_CLR [RTC_I2C_ACK_ERR_INT](#) interrupt clear bit. (WO)

RTC_I2C_RX_DATA_INT_CLR [RTC_I2C_RX_DATA_INT](#) interrupt clear bit. (WO)

RTC_I2C_TX_DATA_INT_CLR [RTC_I2C_TX_DATA_INT](#) interrupt clear bit. (WO)

RTC_I2C_DETECT_START_INT_CLR [RTC_I2C_DETECT_START_INT](#) interrupt clear bit. (WO)

Register 2.24. RTC_I2C_INT_RAW_REG (0x0028)

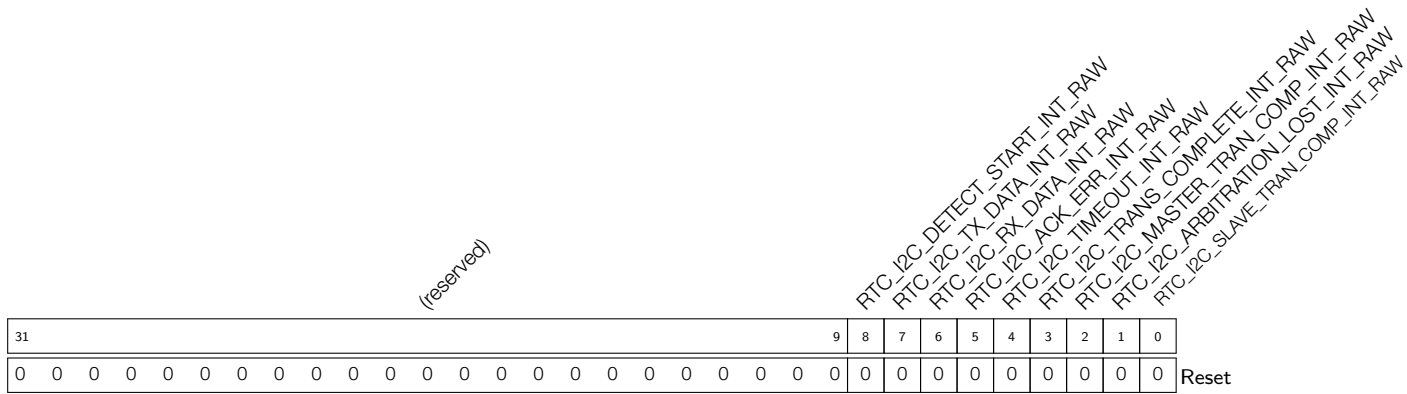

RTC_I2C_SLAVE_TRAN_COMP_INT_RAW [RTC_I2C_SLAVE_TRAN_COMP_INT](#) interrupt raw bit. (RO)

RTC_I2C_ARBITRATION_LOST_INT_RAW [RTC_I2C_ARBITRATION_LOST_INT](#) interrupt raw bit. (RO)

RTC_I2C_MASTER_TRAN_COMP_INT_RAW [RTC_I2C_MASTER_TRAN_COMP_INT](#) interrupt raw bit. (RO)

RTC_I2C_TRANS_COMPLETE_INT_RAW [RTC_I2C_TRANS_COMPLETE_INT](#) interrupt raw bit. (RO)

RTC_I2C_TIMEOUT_INT_RAW [RTC_I2C_TIMEOUT_INT](#) interrupt raw bit. (RO)

RTC_I2C_ACK_ERR_INT_RAW [RTC_I2C_ACK_ERR_INT](#) interrupt raw bit. (RO)

RTC_I2C_RX_DATA_INT_RAW [RTC_I2C_RX_DATA_INT](#) interrupt raw bit. (RO)

RTC_I2C_TX_DATA_INT_RAW [RTC_I2C_TX_DATA_INT](#) interrupt raw bit. (RO)

RTC_I2C_DETECT_START_INT_RAW [RTC_I2C_DETECT_START_INT](#) interrupt raw bit. (RO)

Register 2.25. RTC_I2C_INT_ST_REG (0x002C)

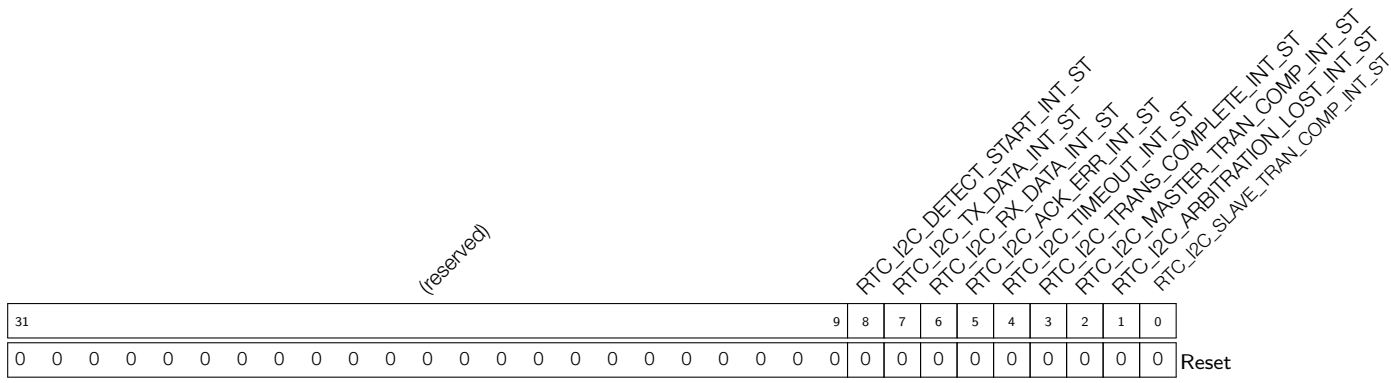

RTC_I2C_SLAVE_TRAN_COMP_INT_ST [RTC_I2C_SLAVE_TRAN_COMP_INT](#) interrupt status bit. (RO)

RTC_I2C_ARBITRATION_LOST_INT_ST [RTC_I2C_ARBITRATION_LOST_INT](#) interrupt status bit. (RO)

RTC_I2C_MASTER_TRAN_COMP_INT_ST [RTC_I2C_MASTER_TRAN_COMP_INT](#) interrupt status bit. (RO)

RTC_I2C_TRANS_COMPLETE_INT_ST [RTC_I2C_TRANS_COMPLETE_INT](#) interrupt status bit. (RO)

RTC_I2C_TIMEOUT_INT_ST [RTC_I2C_TIMEOUT_INT](#) interrupt status bit. (RO)

RTC_I2C_ACK_ERR_INT_ST [RTC_I2C_ACK_ERR_INT](#) interrupt status bit. (RO)

RTC_I2C_RX_DATA_INT_ST [RTC_I2C_RX_DATA_INT](#) interrupt status bit. (RO)

RTC_I2C_TX_DATA_INT_ST [RTC_I2C_TX_DATA_INT](#) interrupt status bit. (RO)

RTC_I2C_DETECT_START_INT_ST [RTC_I2C_DETECT_START_INT](#) interrupt status bit. (RO)

Register 2.26. RTC_I2C_INT_ENA_REG (0x0030)

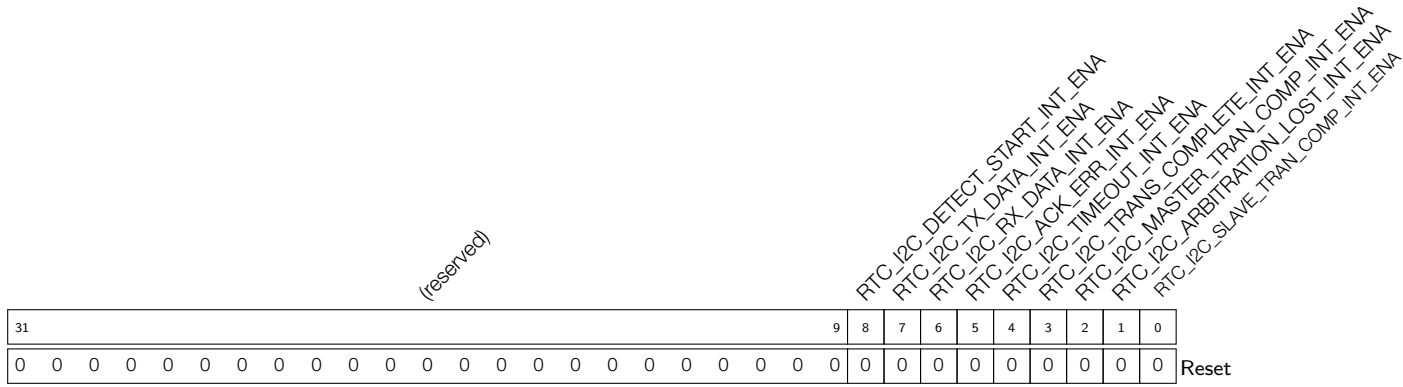

RTC_I2C_SLAVE_TRAN_COMP_INT_ENA [RTC_I2C_SLAVE_TRAN_COMP_INT](#) interrupt enable bit. (R/W)

RTC_I2C_ARBITRATION_LOST_INT_ENA [RTC_I2C_ARBITRATION_LOST_INT](#) interrupt enable bit. (R/W)

RTC_I2C_MASTER_TRAN_COMP_INT_ENA [RTC_I2C_MASTER_TRAN_COMP_INT](#) interrupt enable bit. (R/W)

RTC_I2C_TRANS_COMPLETE_INT_ENA [RTC_I2C_TRANS_COMPLETE_INT](#) interrupt enable bit. (R/W)

RTC_I2C_TIMEOUT_INT_ENA [RTC_I2C_TIMEOUT_INT](#) interrupt enable bit. (R/W)

RTC_I2C_ACK_ERR_INT_ENA [RTC_I2C_ACK_ERR_INT](#) interrupt enable bit. (R/W)

RTC_I2C_RX_DATA_INT_ENA [RTC_I2C_RX_DATA_INT](#) interrupt enable bit. (R/W)

RTC_I2C_TX_DATA_INT_ENA [RTC_I2C_TX_DATA_INT](#) interrupt enable bit. (R/W)

RTC_I2C_DETECT_START_INT_ENA [RTC_I2C_DETECT_START_INT](#) interrupt enable bit. (R/W)

Register 2.27. RTC_I2C_DATA_REG (0x0034)

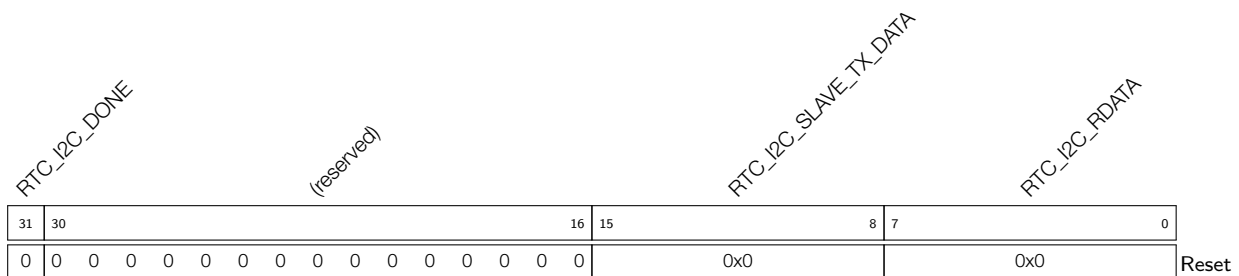

RTC_I2C_RDATA Data received. (RO)

RTC_I2C_SLAVE_TX_DATA The data sent by slave. (R/W)

RTC_I2C_DONE RTC I2C transmission is done. (RO)

Register 2.28. RTC_I2C_CMD0_REG (0x0038)

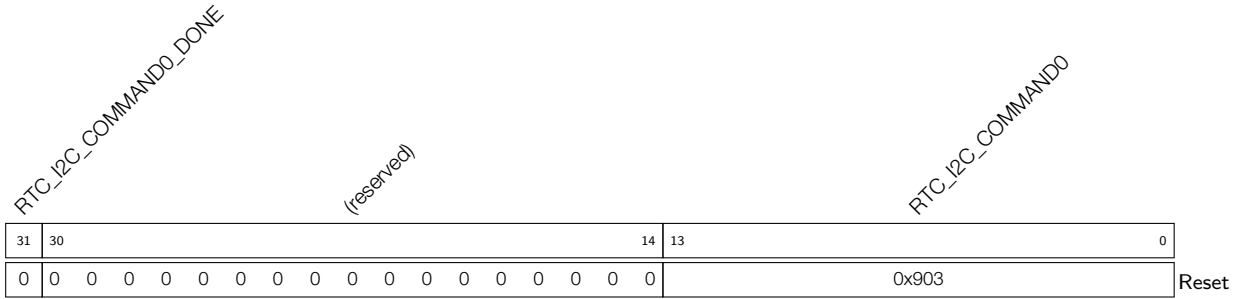

RTC_I2C_COMMAND0 Content of command 0. For more information, please refer to the register I2C_COMD0_REG in Chapter I2C Controller. (R/W)

RTC_I2C_COMMAND0_DONE When command 0 is done, this bit changes to 1. (RO)

Register 2.29. RTC_I2C_CMD1_REG (0x003C)

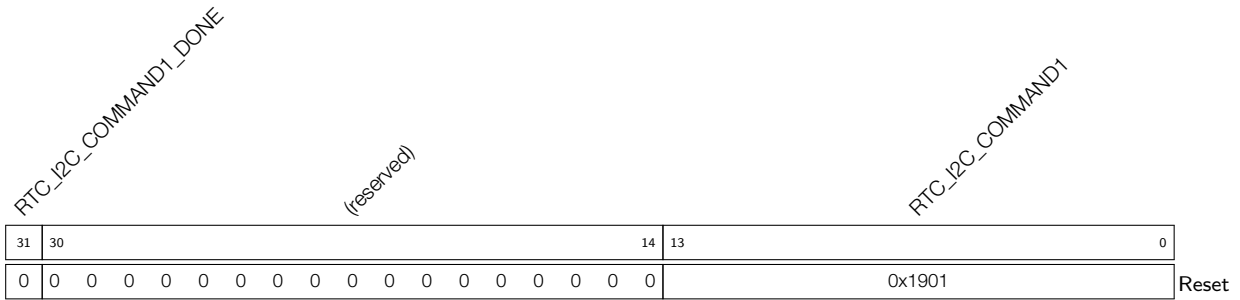

RTC_I2C_COMMAND1 Content of command 1. For more information, please refer to the register I2C_COMD1_REG in Chapter I2C Controller. (R/W)

RTC_I2C_COMMAND1_DONE When command 1 is done, this bit changes to 1. (RO)

Register 2.30. RTC_I2C_CMD2_REG (0x0040)

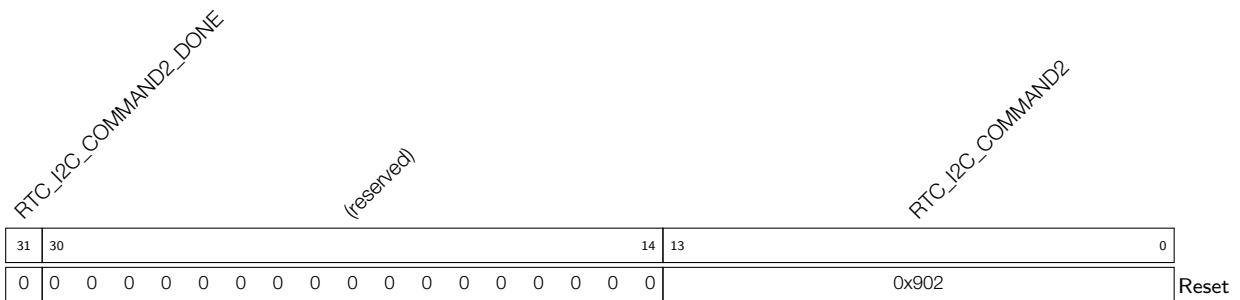

RTC_I2C_COMMAND2 Content of command 2. For more information, please refer to the register I2C_COMD2_REG in Chapter I2C Controller. (R/W)

RTC_I2C_COMMAND2_DONE When command 2 is done, this bit changes to 1. (RO)

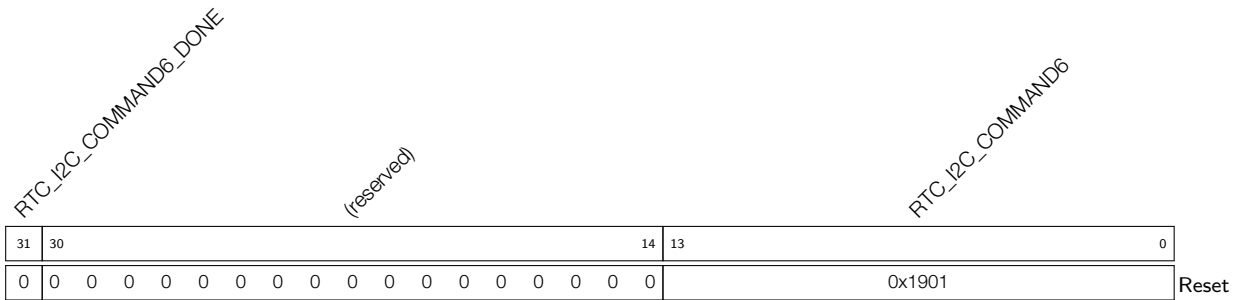
Register 2.34. RTC_I2C_CMD6_REG (0x0050)

RTC_I2C_COMMAND6 Content of command 6. For more information, please refer to the register I2C_COMD6_REG in Chapter I2C Controller. (R/W)

RTC_I2C_COMMAND6_DONE When command 6 is done, this bit changes to 1. (RO)

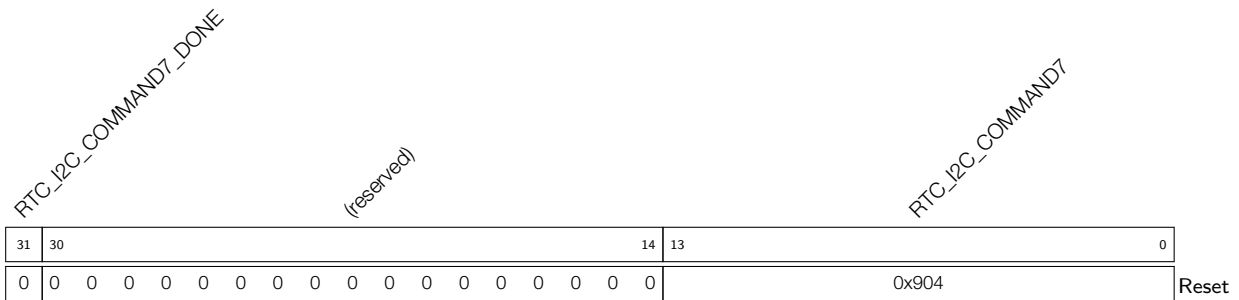
Register 2.35. RTC_I2C_CMD7_REG (0x0054)

RTC_I2C_COMMAND7 Content of command 7. For more information, please refer to the register I2C_COMD7_REG in Chapter I2C Controller. (R/W)

RTC_I2C_COMMAND7_DONE When command 7 is done, this bit changes to 1. (RO)

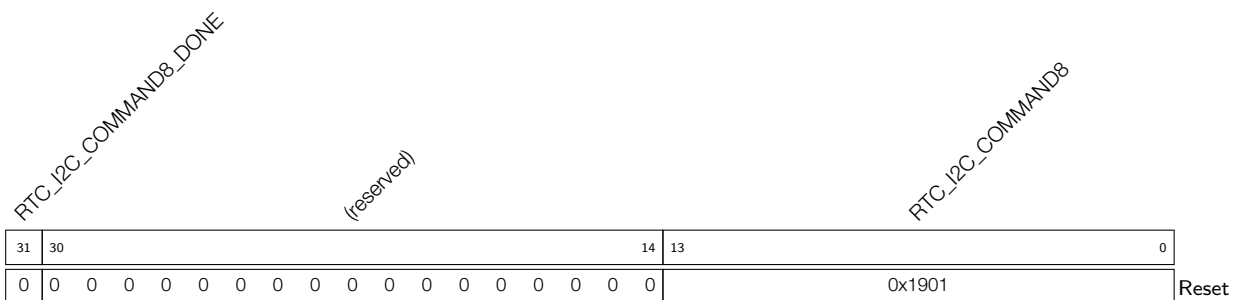
Register 2.36. RTC_I2C_CMD8_REG (0x0058)

RTC_I2C_COMMAND8 Content of command 8. For more information, please refer to the register I2C_COMD8_REG in Chapter I2C Controller. (R/W)

RTC_I2C_COMMAND8_DONE When command 8 is done, this bit changes to 1. (RO)

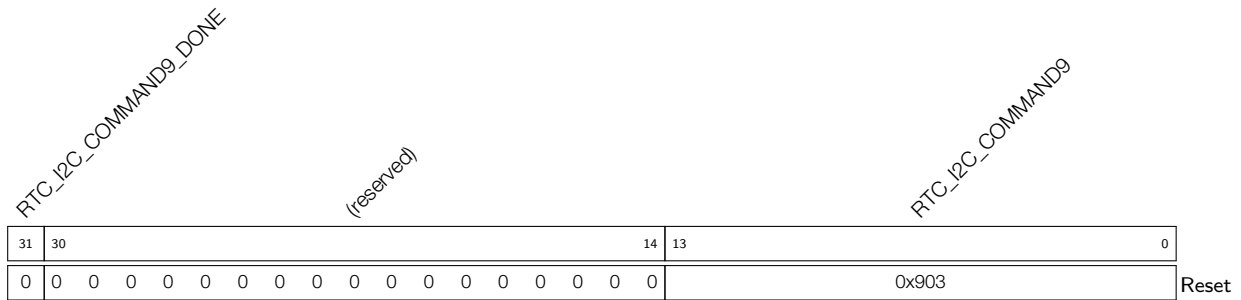
Register 2.37. RTC_I2C_CMD9_REG (0x005C)

RTC_I2C_COMMAND9 Content of command 9. For more information, please refer to the register I2C_COMD9_REG in Chapter I2C Controller. (R/W)

RTC_I2C_COMMAND9_DONE When command 9 is done, this bit changes to 1. (RO)

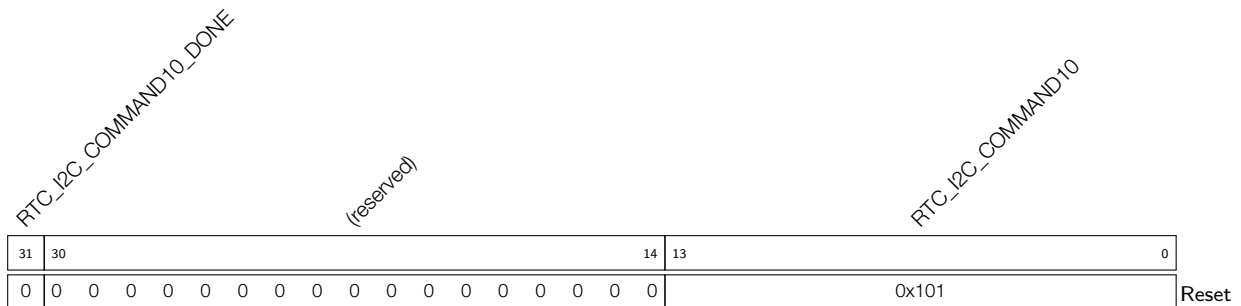
Register 2.38. RTC_I2C_CMD10_REG (0x0060)

RTC_I2C_COMMAND10 Content of command 10. For more information, please refer to the register I2C_COMD10_REG in Chapter I2C Controller. (R/W)

RTC_I2C_COMMAND10_DONE When command 10 is done, this bit changes to 1. (RO)

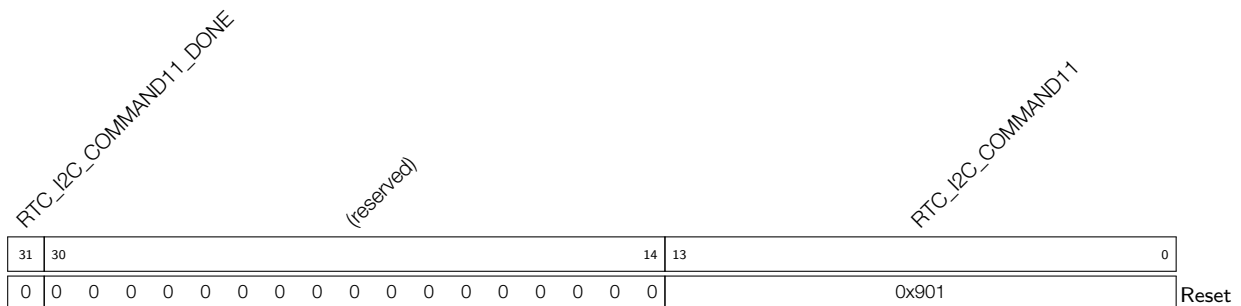
Register 2.39. RTC_I2C_CMD11_REG (0x0064)

RTC_I2C_COMMAND11 Content of command 11. For more information, please refer to the register I2C_COMD11_REG in Chapter I2C Controller. (R/W)

RTC_I2C_COMMAND11_DONE When command 11 is done, this bit changes to 1. (RO)

Register 2.40. RTC_I2C_CMD12_REG (0x0068)

<i>RTC_I2C_COMMAND12_DONE</i>															<i>(reserved)</i>															<i>RTC_I2C_COMMAND12</i>															
31															14	13														0															
0															0															0x1701															Reset

RTC_I2C_COMMAND12 Content of command 12. For more information, please refer to the register I2C_COMD12_REG in Chapter I2C Controller. (R/W)

RTC_I2C_COMMAND12_DONE When command 12 is done, this bit changes to 1. (RO)

Register 2.41. RTC_I2C_CMD13_REG (0x006C)

<i>RTC_I2C_COMMAND13_DONE</i>															<i>(reserved)</i>															<i>RTC_I2C_COMMAND13</i>															
31															14	13														0															
0															0															0x1901															Reset

RTC_I2C_COMMAND13 Content of command 13. For more information, please refer to the register I2C_COMD13_REG in Chapter I2C Controller. (R/W)

RTC_I2C_COMMAND13_DONE When command 13 is done, this bit changes to 1. (RO)

Register 2.42. RTC_I2C_CMD14_REG (0x0070)

<i>RTC_I2C_COMMAND14_DONE</i>															<i>(reserved)</i>															<i>RTC_I2C_COMMAND14</i>															
31															14	13														0															
0															0															0x00															Reset

RTC_I2C_COMMAND14 Content of command 14. For more information, please refer to the register I2C_COMD14_REG in Chapter I2C Controller. (R/W)

RTC_I2C_COMMAND14_DONE When command 14 is done, this bit changes to 1. (RO)

Register 2.43. RTC_I2C_CMD15_REG (0x0074)

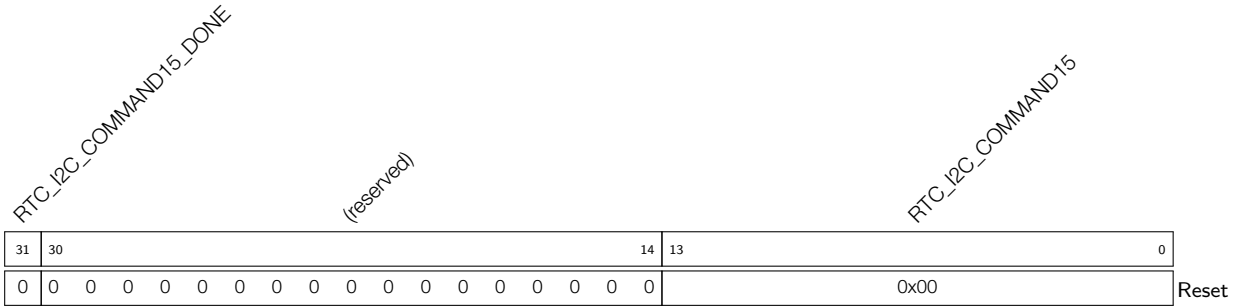

RTC_I2C_COMMAND15 Content of command 15. For more information, please refer to the register I2C_COMD15_REG in Chapter I2C Controller. (R/W)

RTC_I2C_COMMAND15_DONE When command 15 is done, this bit changes to 1. (RO)

Register 2.44. RTC_I2C_DATE_REG (0x00FC)

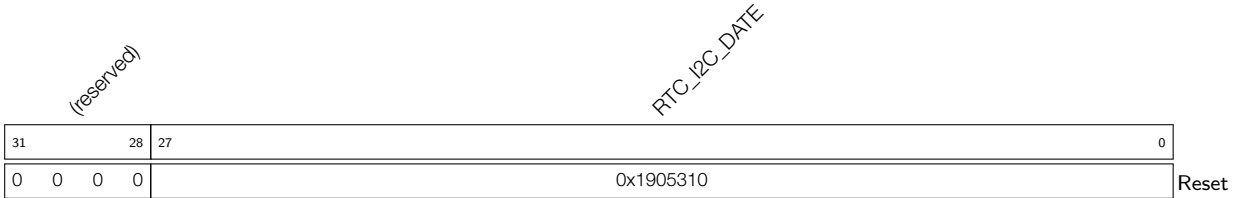

RTC_I2C_DATE Version control register (R/W)

3 GDMA Controller (GDMA)

3.1 Overview

General Direct Memory Access (GDMA) is a feature that allows peripheral-to-memory, memory-to-peripheral, and memory-to-memory data transfer at a high speed. The CPU is not involved in the GDMA transfer, and therefore it becomes more efficient with less workload.

The GDMA controller in ESP32-S3 has ten independent channels, i.e. five transmit channels and five receive channels. These ten channels are shared by peripherals with GDMA feature, namely SPI2, SPI3, UHCI0, I2S0, I2S1, LCD/CAM, AES, SHA, ADC, and RMT. You can assign the ten channels to any of these peripherals. Every channel supports access to internal RAM or external RAM.

The GDMA controller uses fixed-priority and round-robin channel arbitration schemes to manage peripherals' needs for bandwidth.

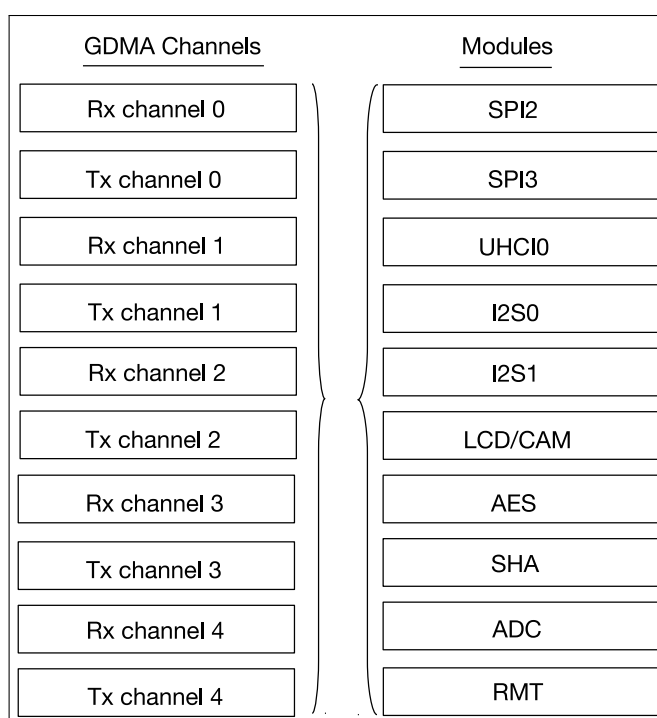

Figure 3-1. Modules with GDMA Feature and GDMA Channels

3.2 Features

The GDMA controller has the following features:

- AHB bus architecture
- Programmable length of data to be transferred in bytes
- Linked list of descriptors
- INCR burst transfer when accessing internal RAM
- Access to an address space of 480 KB at most in internal RAM
- Access to an address space of 32 MB at most in external RAM

- Five transmit channels and five receive channels
- Access to internal and external RAM supported by every channel
- Software-configurable selection of peripheral requesting its service supported by every channel
- Fixed channel priority and round-robin channel arbitration

3.3 Architecture

In ESP32-S3, all modules that need high-speed data transfer support GDMA. The GDMA controller and CPU data bus have access to the same address space in internal and external RAM. Figure 3-2 shows the basic architecture of the GDMA engine.

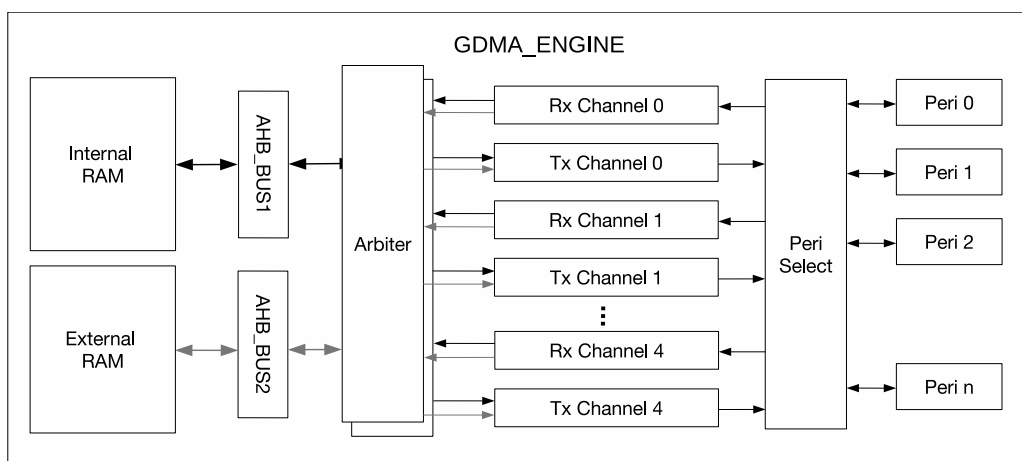

Figure 3-2. GDMA Engine Architecture

The GDMA controller has ten independent channels, i.e. five transmit channels and five receive channels. Every channel can be connected to different peripherals. In other words, channels are general-purpose, shared by peripherals.

The GDMA engine has two independent AHB bus referred to as AHB_BUS1 and AHB_BUS2 respectively. AHB_BUS1 is used to read data from or write data to internal RAM, whereas AHB_BUS2 is used to read data from or write data to external RAM. Before this, the GDMA controller uses fixed-priority arbitration scheme for channels requesting read or write access. For available address range of RAM, please see Chapter 4 *System and Memory*.

Software can use the GDMA engine through linked lists. These linked lists, stored in internal RAM, consist of outlink n and inlink n , where n indicates the channel number (ranging from 0 to 4). The GDMA controller reads an outlink n (i.e. a linked list of transmit descriptors) from internal RAM and transmits data in corresponding RAM according to the outlink n , or reads an inlink n (i.e. a linked list of receive descriptors) and stores received data into specific address space in RAM according to the inlink n .

3.4 Functional Description

3.4.1 Linked List

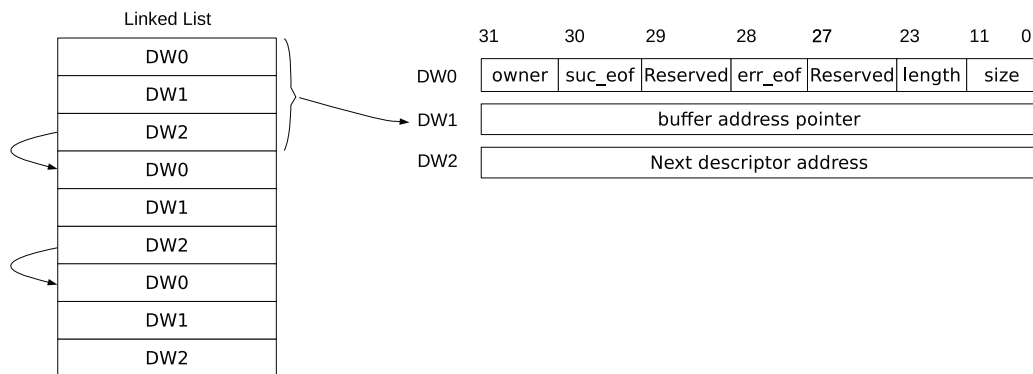

Figure 3-3. Structure of a Linked List

Figure 3-3 shows the structure of a linked list. An outlink and an inlink have the same structure. A linked list is formed by one or more descriptors, and each descriptor consists of three words. Linked lists should be in internal RAM for the GDMA engine to be able to use them. The meaning of each field is as follows:

- Owner (DW0) [31]: Specifies who is allowed to access the buffer that this descriptor points to.
 - 1'b0: CPU can access the buffer;
 - 1'b1: The GDMA controller can access the buffer.
 When the GDMA controller stops using the buffer, this bit in a receive descriptor is automatically cleared by hardware, and this bit in a transmit descriptor is automatically cleared by hardware only if `GDMA_OUT_AUTO_WBACK_CHn` is set to 1. When software loads a linked list, this bit should be set to 1.

Note: GDMA_OUT is the prefix of transmit channel registers, and GDMA_IN is the prefix of receive channel registers.
- suc_eof (DW0) [30]: Specifies whether this descriptor is the last descriptor in the list.
 - 1'b0: This descriptor is not the last one;
 - 1'b1: This descriptor is the last one.
 Software clears suc_eof bit in receive descriptors. When a frame or packet has been received, this bit in the last receive descriptor is set by hardware, and this bit in the last transmit descriptor is set by software.
- Reserved (DW0) [29]: Reserved. Value of this bit does not matter.
- err_eof (DW0) [28]: Specifies whether the received data have errors.

This bit is used only when UHCI0 uses GDMA to receive data. When an error is detected in the received frame or packet, this bit in the receive descriptor is set to 1 by hardware.
- Reserved (DW0) [27:24]: Reserved.
- Length (DW0) [23:12]: Specifies the number of valid bytes in the buffer that this descriptor points to. This field in a transmit descriptor is written by software and indicates how many bytes can be read from the buffer; this field in a receive descriptor is written by hardware automatically and indicates how many valid bytes have been stored into the buffer.
- Size (DW0) [11:0]: Specifies the size of the buffer that this descriptor points to.

- Buffer address pointer (DW1): Address of the buffer.
- Next descriptor address (DW2): Address of the next descriptor. If the current descriptor is the last one (suc_eof = 1), this value is 0. This field can only point to internal RAM.

If the length of data received is smaller than the size of the buffer, the GDMA controller will not use available space of the buffer in the next transaction.

3.4.2 Peripheral-to-Memory and Memory-to-Peripheral Data Transfer

The GDMA controller can transfer data from memory to peripheral (transmit) and from peripheral to memory (receive). A transmit channel transfers data in the specified memory location to a peripheral's transmitter via an outlink n , whereas a receive channel transfers data received by a peripheral to the specified memory location via an inlink n .

Every transmit and receive channel can be connected to any peripheral with GDMA feature. Table 3-1 illustrates how to select the peripheral to be connected via registers. When a channel is connected to a peripheral, the rest channels can not be connected to that peripheral. All transmit and receive channels support access to internal and external RAM. For details, please refer to Section 3.4.8 and Section 3.4.9.

Table 3-1. Selecting Peripherals via Register Configuration

GDMA_PERI_IN_SEL_CH n GDMA_PERI_OUT_SEL_CH n	Peripheral
0	SPI2
1	SPI3
2	UHCI0
3	I2S0
4	I2S1
5	LCD/CAM
6	AES
7	SHA
8	ADC
9	RMT

3.4.3 Memory-to-Memory Data Transfer

The GDMA controller also allows memory-to-memory data transfer. Such data transfer can be enabled by setting `GDMA_MEM_TRANS_EN_CH n` , which connects the output of transmit channel n to the input of receive channel n . Note that a transmit channel is only connected to the receive channel with the same number (n).

As every transmit and receive channel can be used to access internal and external RAM, there are four data transfer modes:

- from internal RAM to internal RAM
- from internal RAM to external RAM
- from external RAM to internal RAM
- from external RAM to external RAM

3.4.4 Channel Buffer

Every transmit and receive channel contains FIFOs at three levels, i.e. L1FIFO, L2FIFO, and L3FIFO. As Figure 3-4 shows, L1FIFO is close to the memory, L3FIFO is close to peripherals, and L2FIFO falls in between L1FIFO and L3FIFO. L1FIFO, L2FIFO and L3FIFO have fixed depth: 24, 128, and 16 bytes, respectively.

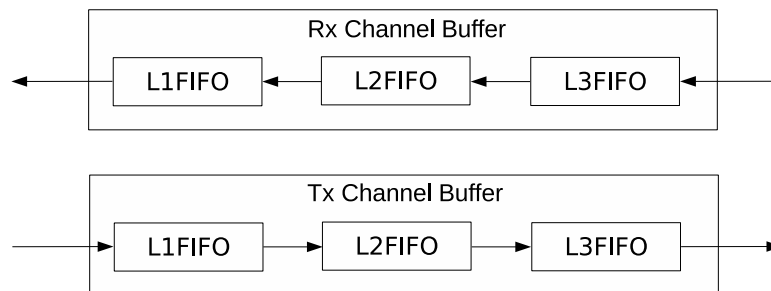

Figure 3-4. Channel Buffer

3.4.5 Enabling GDMA

Software uses the GDMA controller through linked lists. When the GDMA controller receives data, software loads an inlink, configures `GDMA_INLINK_ADDR_CHn` field with address of the first receive descriptor, and sets `GDMA_INLINK_START_CHn` bit to enable GDMA. When the GDMA controller transmits data, software loads an outlink, prepares data to be transmitted, configures `GDMA_OUTLINK_ADDR_CHn` field with address of the first transmit descriptor, and sets `GDMA_OUTLINK_START_CHn` bit to enable GDMA. `GDMA_INLINK_START_CHn` bit and `GDMA_OUTLINK_START_CHn` bit are cleared automatically by hardware.

In some cases, you may want to append more descriptors to a DMA transfer that is already started. Naively, it would seem to be possible to do this by clearing the EOF bit of the final descriptor in the existing list and setting its next descriptor address pointer field (DW2) to the first descriptor of the to-be-added list. However, this strategy fails if the existing DMA transfer is almost or entirely finished. Instead, the GDMA engine has specialized logic to make sure a DMA transfer can be continued or restarted: if it is still ongoing, it will make sure to take the appended descriptors into account; if the transfer has already finished, it will restart with the new descriptors. This is implemented in the Restart function.

When using the Restart function, software needs to rewrite the address of the first descriptor in the new list to DW2 of the last descriptor in the loaded list, and set `GDMA_INLINK_RESTART_CHn` bit or `GDMA_OUTLINK_RESTART_CHn` bit (these two bits are cleared automatically by hardware). As shown in Figure 3-5, by doing so hardware can obtain the address of the first descriptor in the new list when reading the last descriptor in the loaded list, and then read the new list.

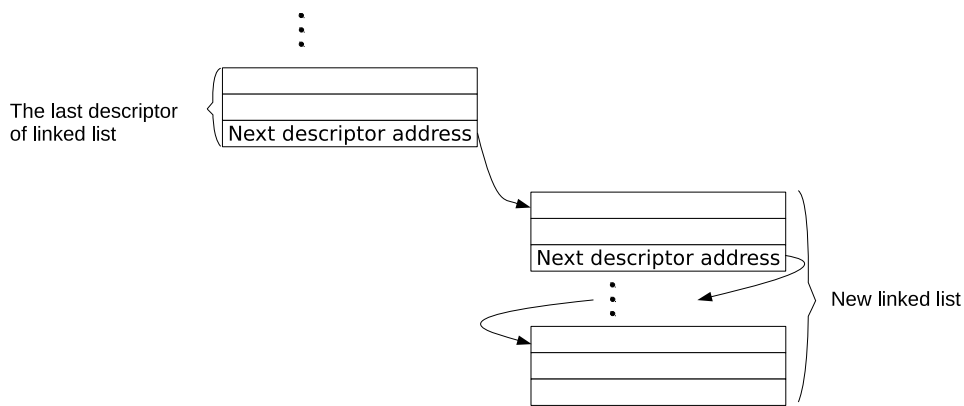

Figure 3-5. Relationship among Linked Lists

3.4.6 Linked List Reading Process

Once configured and enabled by software, the GDMA controller starts to read the linked list from internal RAM. The GDMA performs checks on descriptors in the linked list. Only if the descriptors pass the checks, will the corresponding GDMA channel transfer data. If the descriptors fail any of the checks, hardware will trigger descriptor error interrupt (either `GDMA_IN_DSCR_ERR_CH n _INT` or `GDMA_OUT_DSCR_ERR_CH n _INT`), and the channel will halt.

The checks performed on descriptors are:

- Owner bit check when `GDMA_IN_CHECK_OWNER_CH n` or `GDMA_OUT_CHECK_OWNER_CH n` is set to 1. If the owner bit is 0, the buffer is accessed by the CPU. In this case, the owner bit fails the check. The owner bit will not be checked if `GDMA_IN_CHECK_OWNER_CH n` or `GDMA_OUT_CHECK_OWNER_CH n` is 0;
- Buffer address pointer (DW1) check. If the buffer address pointer points to `0x3FC88000 ~ 0x3FCFFFFF` or `0x3C000000 ~ 0x3DFFFFFF` (please refer to Section 3.4.8), it passes the check.

After software detects a descriptor error interrupt, it must reset the corresponding channel, and enable GDMA by setting `GDMA_OUTLINK_START_CH n` or `GDMA_INLINK_START_CH n` bit.

Note: The third word (DW2) in a descriptor can only point to a location in internal RAM, given that the third word points to the next descriptor to use and that all descriptors must be in internal memory.

3.4.7 EOF

The GDMA controller uses EOF (end of frame) flags to indicate the end of data frame or packet transmission.

Before the GDMA controller transmits data, `GDMA_OUT_TOTAL_EOF_CH n _INT_ENA` bit should be set to enable `GDMA_OUT_TOTAL_EOF_CH n _INT` interrupt. If data in the buffer pointed by the last descriptor (with EOF) have been transmitted, a `GDMA_OUT_TOTAL_EOF_CH n _INT` interrupt is generated.

Before the GDMA controller receives data, `GDMA_IN_SUC_EOF_CH n _INT_ENA` bit should be set to enable `GDMA_IN_SUC_EOF_CH n _INT` interrupt. If a data frame or packet has been received successfully, a `GDMA_IN_SUC_EOF_CH n _INT` interrupt is generated. In addition, when GDMA channel is connected to UHCI0, the GDMA controller also supports `GDMA_IN_ERR_CH n _EOF_INT` interrupt. This interrupt is enabled by setting `GDMA_IN_ERR_EOF_CH n _INT_ENA` bit, and it indicates that a data frame or packet has been received with errors.

When detecting a `GDMA_OUT_TOTAL_EOF_CH n _INT` or a `GDMA_IN_SUC_EOF_CH n _INT` interrupt, software can record the value of `GDMA_OUT_EOF_DES_ADDR_CH n` or `GDMA_IN_SUC_EOF_DES_ADDR_CH n` field, i.e. address of the last descriptor. Therefore, software can tell which descriptors have been used and reclaim them.

Note: In this chapter, EOF of transmit descriptors refers to `suc_eof`, while EOF of receive descriptors refers to both `suc_eof` and `err_eof`.

3.4.8 Accessing Internal RAM

Any transmit and receive channels of GDMA can access `0x3FC88000 ~ 0x3FCFFFFF` in internal RAM. To improve data transfer efficiency, GDMA can send data in burst mode, which is disabled by default. This mode is enabled for receive channels by setting `GDMA_IN_DATA_BURST_EN_CH n` , and enabled for transmit channels by setting `GDMA_OUT_DATA_BURST_EN_CH n` .

Table 3-2. Descriptor Field Alignment Requirements for Accessing Internal RAM

Inlink/Outlink	Burst Mode	Size	Length	Buffer Address Pointer
Inlink	0	—	—	—
	1	Word-aligned	—	Word-aligned
Outlink	0	—	—	—
	1	—	—	—

Table 3-2 lists the requirements for descriptor field alignment when GDMA accesses internal RAM.

When burst mode is disabled, size, length, and buffer address pointer in both transmit and receive descriptors do not need to be word-aligned. That is to say, GDMA can read data of specified length (1 ~ 4095 bytes) from any start addresses in the accessible address range, or write received data of the specified length (1 ~ 4095 bytes) to any contiguous addresses in the accessible address range.

When burst mode is enabled, size, length, and buffer address pointer in transmit descriptors are also not necessarily word-aligned. However, size and buffer address pointer in receive descriptors except length should be word-aligned.

3.4.9 Accessing External RAM

Any transmit and receive channels of GDMA can access `0x3C000000 ~ 0x3DFFFFFF` in external RAM. GDMA can send data only in burst mode. The number of data bytes to transfer in one burst is defined as block size. Block size can be 16 bytes, 32 bytes or 64 bytes, configured via `GDMA_IN_EXT_MEM_BK_SIZE_CH n` for transmit channels and `GDMA_OUT_EXT_MEM_BK_SIZE_CH n` for receive channels.

Table 3-3. Descriptor Field Alignment Requirements for Accessing External RAM

Inlink/Outlink	Size	Length	Buffer Address Pointer
Inlink	Block-aligned	—	Block-aligned
Outlink	—	—	—

Table 3-3 lists the requirements for descriptor field alignment when GDMA accesses internal RAM. Size, length, and buffer address pointer in transmit descriptors do not need to be aligned. However, size and buffer address pointer in receive descriptors except length should be aligned with block size. Table 3-4 illustrates the value of

`GDMA_IN_EXT_MEM_BK_SIZE_CH n` or `GDMA_OUT_EXT_MEM_BK_SIZE_CH n` bit when fields in linked list descriptors are 16-byte, 32-byte and 64-byte aligned respectively.

Table 3-4. Relationship Between Configuration Register, Block Size and Alignment

<code>GDMA_IN_EXT_MEM_BK_SIZE_CHn</code> or <code>GDMA_OUT_EXT_MEM_BK_SIZE_CHn</code>	Block Size	Alignment
0	16 bytes	16-byte aligned
1	32 bytes	32-byte aligned
2	64 bytes	64-byte aligned

Note: For receive descriptors, if the data length received are not aligned with block size, GDMA will pad the data received with 0 until they are aligned to initiate burst transfer. You can read the length field in receive descriptors to obtain the length of valid data received.

3.4.10 External RAM Access Permissions

GDMA in ESP32-S3 has a permission control module for access to external RAM. As Figure 3-6 shows, the permission control module divided the 32 MB external RAM into four areas through three configurable boundaries, namely boundary 0, boundary 1, and boundary 2.

- Area 0: 0x3C000000 ~ boundary 0 (include 0x3C000000 but exclude boundary 0)
- Area 1: boundary 0 ~ boundary 1 (include boundary 0 but exclude boundary 1)
- Area 2: boundary 1 ~ boundary 2 (include boundary 1 but exclude boundary 2)
- Area 3: boundary 2 ~ 0x3DFFFFFF (include boundary 0)

Boundary 0, 1, and 2 are configured via `PMS_EDMA_BOUNDARY_0`, `PMS_EDMA_BOUNDARY_1`, and `PMS_EDMA_BOUNDARY_2`, respectively. For details about these fields, please refer to Chapter 15 *Permission Control (PMS)*. The unit of these fields is 4 KB. For example, if `PMS_EDMA_BOUNDARY_0` is 0x80, the address of boundary 0 should be $0x3C000000 + 0x80 * 4 \text{ KB} = 3c080000$, in which 0x3C000000 is the starting address of accessible external RAM.

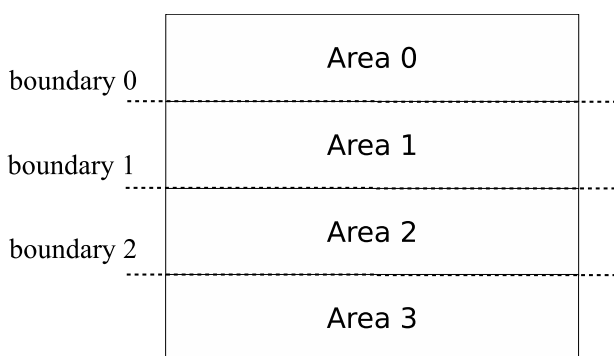

Figure 3-6. Dividing External RAM into Areas

All peripherals with GDMA feature (i.e. SPI2, SPI3, UHCI0, I2S0, I2S1, LCD/CAM, AES, SHA, ADC, and RMT) do not have access permissions for Area 0 and Area 3, but their permissions for Area 1 and Area 2 can be independently managed. The permission control module contains registers to manage such access permissions for Area 1 and Area 2. For example, the `PMS_EDMA_PMS_SPI2_ATTR1` field configures SPI2's permissions to

read and write Area 1. Specifically, when bit 0 of this field is 1, SPI2 is granted read permission; when bit 1 of this field is 1, SPI2 is granted write permission. Likewise, the [PMS_EDMA_PMS_SPI2_ATTR2](#) field configures SPI2's permissions to read and write Area 2.

Access violations are logged and can trigger the `GDMA_ETXMEN_REJECT_INT` interrupt. You can check the address where the address violation occurs, the peripheral involved, channel number and read or write attribute via [GDMA_ETXMEM_REJECT_ADDR](#), [GDMA_ETXMEN_REJECT_PERI_NUM](#), [GDMA_ETXMEN_REJECT_CHANNEL_NUM](#), and [GDMA_ETXMEM_REJECT_ATTR](#) respectively.

3.4.11 Seamless Access to Internal and External RAM

In some application scenarios, a data frame or packet contains data from both internal RAM and external RAM. To ensure real-time data processing, GDMA is designed in such a way that some descriptors in the linked list can be used to access internal RAM, while the other descriptors in the same linked list can be used to access external RAM. This design allows seamless access to internal and external RAM.

3.4.12 Arbitration

To ensure timely response to peripherals running at a high speed with low latency (such as SPI, LCD/CAM), the GDMA controller implements a fixed-priority channel arbitration scheme. That is to say, each channel can be assigned a priority from 0 ~ 9. The larger the number, the higher the priority, and the more timely the response. When several channels are assigned the same priority, the GDMA controller adopts a round-robin arbitration scheme.

Please note that the overall throughput of peripherals with GDMA feature cannot exceed the maximum bandwidth of the GDMA, so that requests from low-priority peripherals can be responded to.

3.5 GDMA Interrupts

- `GDMA_OUT_TOTAL_EOF_CH n _INT`: Triggered when all data corresponding to a linked list (including multiple descriptors) have been sent via transmit channel n .
- `GDMA_IN_DSCR_EMPTY_CH n _INT`: Triggered when the size of the buffer pointed by receive descriptors is smaller than the length of data to be received via receive channel n .
- `GDMA_OUT_DSCR_ERR_CH n _INT`: Triggered when an error is detected in a transmit descriptor on transmit channel n .
- `GDMA_IN_DSCR_ERR_CH n _INT`: Triggered when an error is detected in a receive descriptor on receive channel n .
- `GDMA_OUT_EOF_CH n _INT`: Triggered when EOF in a transmit descriptor is 1 and data corresponding to this descriptor have been sent via transmit channel n . If [GDMA_OUT_EOF_MODE_CH \$n\$](#) is 0, this interrupt will be triggered when the last byte of data corresponding to this descriptor enters GDMA's transmit channel; if [GDMA_OUT_EOF_MODE_CH \$n\$](#) is 1, this interrupt is triggered when the last byte of data is taken from GDMA's transmit channel.
- `GDMA_OUT_DONE_CH n _INT`: Triggered when all data corresponding to a transmit descriptor have been sent via transmit channel n .
- `GDMA_IN_ERR_EOF_CH n _INT`: Triggered when an error is detected in the data frame or packet received via receive channel n . This interrupt is used only for UHCI0 peripheral (UART0 or UART1).

- `GDMA_IN_SUC_EOF_CH n _INT`: Triggered when a data frame or packet has been received via receive channel n .
- `GDMA_IN_DONE_CH n _INT`: Triggered when all data corresponding to a receive descriptor have been received via receive channel n .

3.6 Programming Procedures

3.6.1 Programming Procedures for GDMA's Transmit Channel

To transmit data, GDMA's transmit channel should be configured by software as follows:

1. Set `GDMA_OUT_RST_CH n` first to 1 and then to 0, to reset the state machine of GDMA's transmit channel and FIFO pointer;
2. Load an outlink, and configure `GDMA_OUTLINK_ADDR_CH n` with address of the first transmit descriptor;
3. Configure `GDMA_PERI_OUT_SEL_CH n` with the value corresponding to the peripheral to be connected, as shown in Table 3-1;
4. Set `GDMA_OUTLINK_START_CH n` to enable GDMA's transmit channel for data transfer;
5. Configure and enable the corresponding peripheral (SPI2, SPI3, UHCI0 (UART0, UART1, or UART2), I2S0, I2S1, AES, SHA, and ADC). See details in individual chapters of these peripherals;
6. Wait for `GDMA_OUT_EOF_CH n _INT` interrupt, which indicates the completion of data transfer.

3.6.2 Programming Procedures for GDMA's Receive Channel

To receive data, GDMA's receive channel should be configured by software as follows:

1. Set `GDMA_IN_RST_CH n` first to 1 and then to 0, to reset the state machine of GDMA's receive channel and FIFO pointer;
2. Load an inlink, and configure `GDMA_INLINK_ADDR_CH n` with address of the first receive descriptor;
3. Configure `GDMA_PERI_IN_SEL_CH n` with the value corresponding to the peripheral to be connected, as shown in Table 3-1;
4. Set `GDMA_INLINK_START_CH n` to enable GDMA's receive channel for data transfer;
5. Configure and enable the corresponding peripheral (SPI2, SPI3, UHCI0 (UART0, UART1, or UART2), I2S0, I2S1, AES, SHA, and ADC). See details in individual chapters of these peripherals;
6. Wait for `GDMA_IN_SUC_EOF_CH n _INT` interrupt, which indicates that a data frame or packet has been received.

3.6.3 Programming Procedures for Memory-to-Memory Transfer

To transfer data from one memory location to another, GDMA should be configured by software as follows:

1. Set `GDMA_OUT_RST_CH n` first to 1 and then to 0, to reset the state machine of GDMA's transmit channel and FIFO pointer;
2. Set `GDMA_IN_RST_CH n` first to 1 and then to 0, to reset the state machine of GDMA's receive channel and FIFO pointer;

3. Load an outlink, and configure `GDMA_OUTLINK_ADDR_CHn` with address of the first transmit descriptor;
4. Load an inlink, and configure `GDMA_INLINK_ADDR_CHn` with address of the first receive descriptor;
5. Set `GDMA_MEM_TRANS_EN_CHn` to enable memory-to-memory transfer;
6. Set `GDMA_OUTLINK_START_CHn` to enable GDMA's transmit channel for data transfer;
7. Set `GDMA_INLINK_START_CHn` to enable GDMA's receive channel for data transfer;
8. Wait for `GDMA_IN_SUC_EOF_CHn_INT` interrupt, which indicates that a data transaction has been completed.

3.7 Register Summary

The addresses in this section are relative to **GDMA** base address provided in Table 4-3 in Chapter 4 *System and Memory*.

The abbreviations given in Column **Access** are explained in Section [Access Types for Registers](#).

Name	Description	Address	Access
Configuration Registers			
GDMA_IN_CONF0_CH0_REG	Configuration register 0 of RX channel 0	0x0000	R/W
GDMA_IN_CONF1_CH0_REG	Configuration register 1 of RX channel 0	0x0004	R/W
GDMA_IN_POP_CH0_REG	Pop control register of RX channel 0	0x001C	varies
GDMA_IN_LINK_CH0_REG	Link descriptor configuration and control register of RX channel 0	0x0020	varies
GDMA_OUT_CONF0_CH0_REG	Configuration register 0 of TX channel 0	0x0060	R/W
GDMA_OUT_CONF1_CH0_REG	Configuration register 1 of TX channel 0	0x0064	R/W
GDMA_OUT_PUSH_CH0_REG	Push control register of RX channel 0	0x007C	varies
GDMA_OUT_LINK_CH0_REG	Link descriptor configuration and control register of TX channel 0	0x0080	varies
GDMA_IN_CONF0_CH1_REG	Configuration register 0 of RX channel 1	0x00C0	R/W
GDMA_IN_CONF1_CH1_REG	Configuration register 1 of RX channel 1	0x00C4	R/W
GDMA_IN_POP_CH1_REG	Pop control register of RX channel 1	0x00DC	varies
GDMA_IN_LINK_CH1_REG	Link descriptor configuration and control register of RX channel 1	0x00E0	varies
GDMA_OUT_CONF0_CH1_REG	Configuration register 0 of TX channel 1	0x0120	R/W
GDMA_OUT_CONF1_CH1_REG	Configuration register 1 of TX channel 1	0x0124	R/W
GDMA_OUT_PUSH_CH1_REG	Push control register of RX channel 1	0x013C	varies
GDMA_OUT_LINK_CH1_REG	Link descriptor configuration and control register of TX channel 1	0x0140	varies
GDMA_IN_CONF0_CH2_REG	Configuration register 0 of RX channel 2	0x0180	R/W
GDMA_IN_CONF1_CH2_REG	Configuration register 1 of RX channel 2	0x0184	R/W
GDMA_IN_POP_CH2_REG	Pop control register of RX channel 2	0x019C	varies
GDMA_IN_LINK_CH2_REG	Link descriptor configuration and control register of RX channel 2	0x01A0	varies
GDMA_OUT_CONF0_CH2_REG	Configuration register 0 of TX channel 2	0x01E0	R/W
GDMA_OUT_CONF1_CH2_REG	Configuration register 1 of TX channel 2	0x01E4	R/W
GDMA_OUT_PUSH_CH2_REG	Push control register of RX channel 2	0x01FC	varies
GDMA_OUT_LINK_CH2_REG	Link descriptor configuration and control register of TX channel 2	0x0200	varies
GDMA_IN_CONF0_CH3_REG	Configuration register 0 of RX channel 3	0x0240	R/W
GDMA_IN_CONF1_CH3_REG	Configuration register 1 of RX channel 3	0x0244	R/W
GDMA_IN_POP_CH3_REG	Pop control register of RX channel 3	0x025C	varies
GDMA_IN_LINK_CH3_REG	Link descriptor configuration and control register of RX channel 3	0x0260	varies
GDMA_OUT_CONF0_CH3_REG	Configuration register 0 of TX channel 3	0x02A0	R/W
GDMA_OUT_CONF1_CH3_REG	Configuration register 1 of TX channel 3	0x02A4	R/W

Name	Description	Address	Access
GDMA_OUT_PUSH_CH3_REG	Push control register of RX channel 3	0x02BC	varies
GDMA_OUT_LINK_CH3_REG	Link descriptor configuration and control register of TX channel 3	0x02C0	varies
GDMA_IN_CONF0_CH4_REG	Configuration register 0 of RX channel 4	0x0300	R/W
GDMA_IN_CONF1_CH4_REG	Configuration register 1 of RX channel 4	0x0304	R/W
GDMA_IN_POP_CH4_REG	Pop control register of RX channel 4	0x031C	varies
GDMA_IN_LINK_CH4_REG	Link descriptor configuration and control register of RX channel 4	0x0320	varies
GDMA_OUT_CONF0_CH4_REG	Configuration register 0 of TX channel 4	0x0360	R/W
GDMA_OUT_CONF1_CH4_REG	Configuration register 1 of TX channel 4	0x0364	R/W
GDMA_OUT_PUSH_CH4_REG	Push control register of RX channel 4	0x037C	varies
GDMA_OUT_LINK_CH4_REG	Link descriptor configuration and control register of TX channel 4	0x0380	varies
GDMA_PD_CONF_REG	reserved	0x03C4	R/W
GDMA_MISC_CONF_REG	Miscellaneous register	0x03C8	R/W
Interrupt Registers			
GDMA_IN_INT_RAW_CH0_REG	Raw status interrupt of RX channel 0	0x0008	R/WTC/SS
GDMA_IN_INT_ST_CH0_REG	Masked interrupt of RX channel 0	0x000C	RO
GDMA_IN_INT_ENA_CH0_REG	Interrupt enable bits of RX channel 0	0x0010	R/W
GDMA_IN_INT_CLR_CH0_REG	Interrupt clear bits of RX channel 0	0x0014	WT
GDMA_OUT_INT_RAW_CH0_REG	Raw status interrupt of TX channel 0	0x0068	R/WTC/SS
GDMA_OUT_INT_ST_CH0_REG	Masked interrupt of TX channel 0	0x006C	RO
GDMA_OUT_INT_ENA_CH0_REG	Interrupt enable bits of TX channel 0	0x0070	R/W
GDMA_OUT_INT_CLR_CH0_REG	Interrupt clear bits of TX channel 0	0x0074	WT
GDMA_IN_INT_RAW_CH1_REG	Raw status interrupt of RX channel 1	0x00C8	R/WTC/SS
GDMA_IN_INT_ST_CH1_REG	Masked interrupt of RX channel 1	0x00CC	RO
GDMA_IN_INT_ENA_CH1_REG	Interrupt enable bits of RX channel 1	0x00D0	R/W
GDMA_IN_INT_CLR_CH1_REG	Interrupt clear bits of RX channel 1	0x00D4	WT
GDMA_OUT_INT_RAW_CH1_REG	Raw status interrupt of TX channel 1	0x0128	R/WTC/SS
GDMA_OUT_INT_ST_CH1_REG	Masked interrupt of TX channel 1	0x012C	RO
GDMA_OUT_INT_ENA_CH1_REG	Interrupt enable bits of TX channel 1	0x0130	R/W
GDMA_OUT_INT_CLR_CH1_REG	Interrupt clear bits of TX channel 1	0x0134	WT
GDMA_IN_INT_RAW_CH2_REG	Raw status interrupt of RX channel 2	0x0188	R/WTC/SS
GDMA_IN_INT_ST_CH2_REG	Masked interrupt of RX channel 2	0x018C	RO
GDMA_IN_INT_ENA_CH2_REG	Interrupt enable bits of RX channel 2	0x0190	R/W
GDMA_IN_INT_CLR_CH2_REG	Interrupt clear bits of RX channel 2	0x0194	WT
GDMA_OUT_INT_RAW_CH2_REG	Raw status interrupt of TX channel 2	0x01E8	R/WTC/SS
GDMA_OUT_INT_ST_CH2_REG	Masked interrupt of TX channel 2	0x01EC	RO
GDMA_OUT_INT_ENA_CH2_REG	Interrupt enable bits of TX channel 2	0x01F0	R/W
GDMA_OUT_INT_CLR_CH2_REG	Interrupt clear bits of TX channel 2	0x01F4	WT
GDMA_IN_INT_RAW_CH3_REG	Raw status interrupt of RX channel 3	0x0248	R/WTC/SS
GDMA_IN_INT_ST_CH3_REG	Masked interrupt of RX channel 3	0x024C	RO
GDMA_IN_INT_ENA_CH3_REG	Interrupt enable bits of RX channel 3	0x0250	R/W

Name	Description	Address	Access
GDMA_IN_INT_CLR_CH3_REG	Interrupt clear bits of RX channel 3	0x0254	WT
GDMA_OUT_INT_RAW_CH3_REG	Raw status interrupt of TX channel 3	0x02A8	R/WTC/SS
GDMA_OUT_INT_ST_CH3_REG	Masked interrupt of TX channel 3	0x02AC	RO
GDMA_OUT_INT_ENA_CH3_REG	Interrupt enable bits of TX channel 3	0x02B0	R/W
GDMA_OUT_INT_CLR_CH3_REG	Interrupt clear bits of TX channel 3	0x02B4	WT
GDMA_IN_INT_RAW_CH4_REG	Raw status interrupt of RX channel 4	0x0308	R/WTC/SS
GDMA_IN_INT_ST_CH4_REG	Masked interrupt of RX channel 4	0x030C	RO
GDMA_IN_INT_ENA_CH4_REG	Interrupt enable bits of RX channel 4	0x0310	R/W
GDMA_IN_INT_CLR_CH4_REG	Interrupt clear bits of RX channel 4	0x0314	WT
GDMA_OUT_INT_RAW_CH4_REG	Raw status interrupt of TX channel 4	0x0368	R/WTC/SS
GDMA_OUT_INT_ST_CH4_REG	Masked interrupt of TX channel 4	0x036C	RO
GDMA_OUT_INT_ENA_CH4_REG	Interrupt enable bits of TX channel 4	0x0370	R/W
GDMA_OUT_INT_CLR_CH4_REG	Interrupt clear bits of TX channel 4	0x0374	WT
GDMA_EXTMEM_REJECT_INT_RAW_REG	Raw interrupt status of external RAM permission	0x03FC	R/WTC/SS
GDMA_EXTMEM_REJECT_INT_ST_REG	Masked interrupt status of external RAM permission	0x0400	RO
GDMA_EXTMEM_REJECT_INT_ENA_REG	Interrupt enable bits of external RAM permission	0x0404	R/W
GDMA_EXTMEM_REJECT_INT_CLR_REG	Interrupt clear bits of external RAM permission	0x0408	WT
Status Registers			
GDMA_INFIFO_STATUS_CH0_REG	Receive FIFO status of RX channel 0	0x0018	RO
GDMA_IN_STATE_CH0_REG	Receive status of RX channel 0	0x0024	RO
GDMA_IN_SUC_EOF_DES_ADDR_CH0_REG	Inlink descriptor address when EOF occurs of RX channel 0	0x0028	RO
GDMA_IN_ERR_EOF_DES_ADDR_CH0_REG	Inlink descriptor address when errors occur of RX channel 0	0x002C	RO
GDMA_IN_DSCR_CH0_REG	Current inlink descriptor address of RX channel 0	0x0030	RO
GDMA_IN_DSCR_BF0_CH0_REG	The last inlink descriptor address of RX channel 0	0x0034	RO
GDMA_IN_DSCR_BF1_CH0_REG	The second-to-last inlink descriptor address of RX channel 0	0x0038	RO
GDMA_OUTFIFO_STATUS_CH0_REG	Transmit FIFO status of TX channel 0	0x0078	RO
GDMA_OUT_STATE_CH0_REG	Transmit status of TX channel 0	0x0084	RO
GDMA_OUT_EOF_DES_ADDR_CH0_REG	Outlink descriptor address when EOF occurs of TX channel 0	0x0088	RO
GDMA_OUT_EOF_BFR_DES_ADDR_CH0_REG	The last outlink descriptor address when EOF occurs of TX channel 0	0x008C	RO
GDMA_OUT_DSCR_CH0_REG	Current inlink descriptor address of TX channel 0	0x0090	RO
GDMA_OUT_DSCR_BF0_CH0_REG	The last inlink descriptor address of TX channel 0	0x0094	RO

Name	Description	Address	Access
GDMA_OUT_DSCR_BF1_CH0_REG	The second-to-last inlink descriptor address of TX channel 0	0x0098	RO
GDMA_INFIFO_STATUS_CH1_REG	Receive FIFO status of RX channel 1	0x00D8	RO
GDMA_IN_STATE_CH1_REG	Receive status of RX channel 1	0x00E4	RO
GDMA_IN_SUC_EOF_DES_ADDR_CH1_REG	Inlink descriptor address when EOF occurs of RX channel 1	0x00E8	RO
GDMA_IN_ERR_EOF_DES_ADDR_CH1_REG	Inlink descriptor address when errors occur of RX channel 1	0x00EC	RO
GDMA_IN_DSCR_CH1_REG	Current inlink descriptor address of RX channel 1	0x00F0	RO
GDMA_IN_DSCR_BF0_CH1_REG	The last inlink descriptor address of RX channel 1	0x00F4	RO
GDMA_IN_DSCR_BF1_CH1_REG	The second-to-last inlink descriptor address of RX channel 1	0x00F8	RO
GDMA_OUTFIFO_STATUS_CH1_REG	Transmit FIFO status of TX channel 1	0x0138	RO
GDMA_OUT_STATE_CH1_REG	Transmit status of TX channel 1	0x0144	RO
GDMA_OUT_EOF_DES_ADDR_CH1_REG	Outlink descriptor address when EOF occurs of TX channel 1	0x0148	RO
GDMA_OUT_EOF_BFR_DES_ADDR_CH1_REG	The last outlink descriptor address when EOF occurs of TX channel 1	0x014C	RO
GDMA_OUT_DSCR_CH1_REG	Current inlink descriptor address of TX channel 1	0x0150	RO
GDMA_OUT_DSCR_BF0_CH1_REG	The last inlink descriptor address of TX channel 1	0x0154	RO
GDMA_OUT_DSCR_BF1_CH1_REG	The second-to-last inlink descriptor address of TX channel 1	0x0158	RO
GDMA_INFIFO_STATUS_CH2_REG	Receive FIFO status of RX channel 2	0x0198	RO
GDMA_IN_STATE_CH2_REG	Receive status of RX channel 2	0x01A4	RO
GDMA_IN_SUC_EOF_DES_ADDR_CH2_REG	Inlink descriptor address when EOF occurs of RX channel 2	0x01A8	RO
GDMA_IN_ERR_EOF_DES_ADDR_CH2_REG	Inlink descriptor address when errors occur of RX channel 2	0x01AC	RO
GDMA_IN_DSCR_CH2_REG	Current inlink descriptor address of RX channel 2	0x01B0	RO
GDMA_IN_DSCR_BF0_CH2_REG	The last inlink descriptor address of RX channel 2	0x01B4	RO
GDMA_IN_DSCR_BF1_CH2_REG	The second-to-last inlink descriptor address of RX channel 2	0x01B8	RO
GDMA_OUTFIFO_STATUS_CH2_REG	Transmit FIFO status of TX channel 2	0x01F8	RO
GDMA_OUT_STATE_CH2_REG	Transmit status of TX channel 2	0x0204	RO
GDMA_OUT_EOF_DES_ADDR_CH2_REG	Outlink descriptor address when EOF occurs of TX channel 2	0x0208	RO
GDMA_OUT_EOF_BFR_DES_ADDR_CH2_REG	The last outlink descriptor address when EOF occurs of TX channel 2	0x020C	RO

Name	Description	Address	Access
GDMA_OUT_DSCR_CH2_REG	Current inlink descriptor address of TX channel 2	0x0210	RO
GDMA_OUT_DSCR_BF0_CH2_REG	The last inlink descriptor address of TX channel 2	0x0214	RO
GDMA_OUT_DSCR_BF1_CH2_REG	The second-to-last inlink descriptor address of TX channel 2	0x0218	RO
GDMA_INFIFO_STATUS_CH3_REG	Receive FIFO status of RX channel 3	0x0258	RO
GDMA_IN_STATE_CH3_REG	Receive status of RX channel 3	0x0264	RO
GDMA_IN_SUC_EOF_DES_ADDR_CH3_REG	Inlink descriptor address when EOF occurs of RX channel 3	0x0268	RO
GDMA_IN_ERR_EOF_DES_ADDR_CH3_REG	Inlink descriptor address when errors occur of RX channel 3	0x026C	RO
GDMA_IN_DSCR_CH3_REG	Current inlink descriptor address of RX channel 3	0x0270	RO
GDMA_IN_DSCR_BF0_CH3_REG	The last inlink descriptor address of RX channel 3	0x0274	RO
GDMA_IN_DSCR_BF1_CH3_REG	The second-to-last inlink descriptor address of RX channel 3	0x0278	RO
GDMA_OUTFIFO_STATUS_CH3_REG	Transmit FIFO status of TX channel 3	0x02B8	RO
GDMA_OUT_STATE_CH3_REG	Transmit status of TX channel 3	0x02C4	RO
GDMA_OUT_EOF_DES_ADDR_CH3_REG	Outlink descriptor address when EOF occurs of TX channel 3	0x02C8	RO
GDMA_OUT_EOF_BFR_DES_ADDR_CH3_REG	The last outlink descriptor address when EOF occurs of TX channel 3	0x02CC	RO
GDMA_OUT_DSCR_CH3_REG	Current inlink descriptor address of TX channel 3	0x02D0	RO
GDMA_OUT_DSCR_BF0_CH3_REG	The last inlink descriptor address of TX channel 3	0x02D4	RO
GDMA_OUT_DSCR_BF1_CH3_REG	The second-to-last inlink descriptor address of TX channel 3	0x02D8	RO
GDMA_INFIFO_STATUS_CH4_REG	Receive FIFO status of RX channel 4	0x0318	RO
GDMA_IN_STATE_CH4_REG	Receive status of RX channel 4	0x0324	RO
GDMA_IN_SUC_EOF_DES_ADDR_CH4_REG	Inlink descriptor address when EOF occurs of RX channel 4	0x0328	RO
GDMA_IN_ERR_EOF_DES_ADDR_CH4_REG	Inlink descriptor address when errors occur of RX channel 4	0x032C	RO
GDMA_IN_DSCR_CH4_REG	Current inlink descriptor address of RX channel 4	0x0330	RO
GDMA_IN_DSCR_BF0_CH4_REG	The last inlink descriptor address of RX channel 4	0x0334	RO
GDMA_IN_DSCR_BF1_CH4_REG	The second-to-last inlink descriptor address of RX channel 4	0x0338	RO
GDMA_OUTFIFO_STATUS_CH4_REG	Transmit FIFO status of TX channel 4	0x0378	RO
GDMA_OUT_STATE_CH4_REG	Transmit status of TX channel 4	0x0384	RO

Name	Description	Address	Access
GDMA_OUT_EOF_DES_ADDR_CH4_REG	Outlink descriptor address when EOF occurs of TX channel 4	0x0388	RO
GDMA_OUT_EOF_BFR_DES_ADDR_CH4_REG	The last outlink descriptor address when EOF occurs of TX channel 4	0x038C	RO
GDMA_OUT_DSCR_CH4_REG	Current inlink descriptor address of TX channel 4	0x0390	RO
GDMA_OUT_DSCR_BF0_CH4_REG	The last inlink descriptor address of TX channel 4	0x0394	RO
GDMA_OUT_DSCR_BF1_CH4_REG	The second-to-last inlink descriptor address of TX channel 4	0x0398	RO
Priority Registers			
GDMA_IN_PRI_CH0_REG	Priority register of RX channel 0	0x0044	R/W
GDMA_OUT_PRI_CH0_REG	Priority register of TX channel 0	0x00A4	R/W
GDMA_IN_PRI_CH1_REG	Priority register of RX channel 1	0x0104	R/W
GDMA_OUT_PRI_CH1_REG	Priority register of TX channel 1	0x0164	R/W
GDMA_IN_PRI_CH2_REG	Priority register of RX channel 2	0x01C4	R/W
GDMA_OUT_PRI_CH2_REG	Priority register of TX channel 2	0x0224	R/W
GDMA_IN_PRI_CH3_REG	Priority register of RX channel 3	0x0284	R/W
GDMA_OUT_PRI_CH3_REG	Priority register of TX channel 3	0x02E4	R/W
GDMA_IN_PRI_CH4_REG	Priority register of RX channel 4	0x0344	R/W
GDMA_OUT_PRI_CH4_REG	Priority register of TX channel 4	0x03A4	R/W
Peripheral Selection Registers			
GDMA_IN_PERI_SEL_CH0_REG	Peripheral selection of RX channel 0	0x0048	R/W
GDMA_OUT_PERI_SEL_CH0_REG	Peripheral selection of TX channel 0	0x00A8	R/W
GDMA_IN_PERI_SEL_CH1_REG	Peripheral selection of RX channel 1	0x0108	R/W
GDMA_OUT_PERI_SEL_CH1_REG	Peripheral selection of TX channel 1	0x0168	R/W
GDMA_IN_PERI_SEL_CH2_REG	Peripheral selection of RX channel 2	0x01C8	R/W
GDMA_OUT_PERI_SEL_CH2_REG	Peripheral selection of TX channel 2	0x0228	R/W
GDMA_IN_PERI_SEL_CH3_REG	Peripheral selection of RX channel 3	0x0288	R/W
GDMA_OUT_PERI_SEL_CH3_REG	Peripheral selection of TX channel 3	0x02E8	R/W
GDMA_IN_PERI_SEL_CH4_REG	Peripheral selection of RX channel 4	0x0348	R/W
GDMA_OUT_PERI_SEL_CH4_REG	Peripheral selection of TX channel 4	0x03A8	R/W
Permission Status Registers			
GDMA_EXTMEM_REJECT_ADDR_REG	External RAM address where access violation occurs	0x03F4	RO
GDMA_EXTMEM_REJECT_ST_REG	Status of external RAM where access violation occurs	0x03F8	RO
Version Register			
GDMA_DATE_REG	Version control register	0x040C	R/W

3.8 Registers

The addresses in this section are relative to **GDMA** base address provided in Table 4-3 in Chapter 4 *System and Memory*.

Register 3.1. GDMA_IN_CONF0_CH n _REG (n : 0-4) (0x0000+192* n)

(reserved)																GDMA_MEM_TRANS_EN_CH0 GDMA_IN_DATA_BURST_EN_CH0 GDMA_INDSR_BURST_EN_CH0 GDMA_IN_LOOP_TEST_CH0 GDMA_IN_RST_CH0					
31															5	4	3	2	1	0	Reset
0																0	0	0	0	0	

GDMA_IN_RST_CH n This bit is used to reset GDMA channel 0 RX FSM and RX FIFO pointer. (R/W)

GDMA_IN_LOOP_TEST_CH n Reserved. (R/W)

GDMA_INDSR_BURST_EN_CH n Set this bit to 1 to enable INCR burst transfer for RX channel 0 reading descriptor when accessing internal RAM. (R/W)

GDMA_IN_DATA_BURST_EN_CH n Set this bit to 1 to enable INCR burst transfer for RX channel 0 receiving data when accessing internal RAM. (R/W)

GDMA_MEM_TRANS_EN_CH n Set this bit 1 to enable automatic transmitting data from memory to memory via GDMA. (R/W)

Register 3.2. GDMA_IN_CONF1_CH n _REG (n : 0-4) (0x0004+192* n)

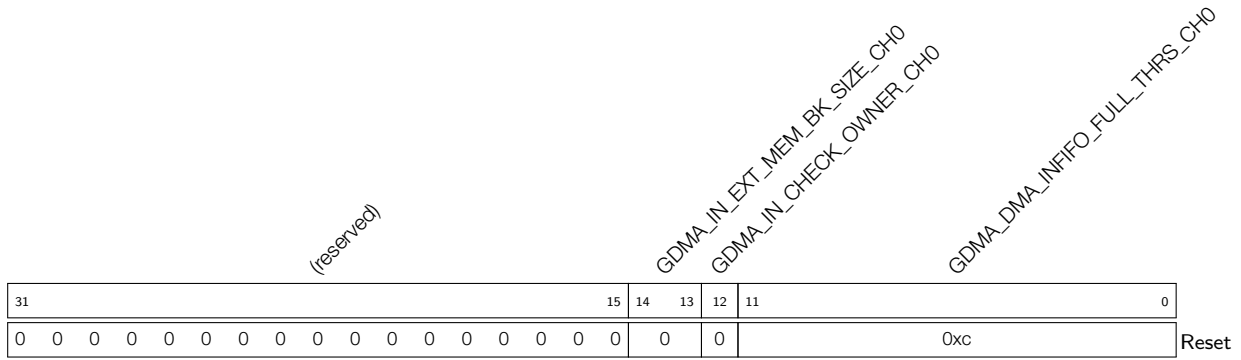

GDMA_DMA_INFIFO_FULL_THRS_CH n This register is used to generate the GDMA_INFIFO_FULL_WM_INT interrupt when RX channel 0 received byte number in RX FIFO is up to the value of the register. (R/W)

GDMA_IN_CHECK_OWNER_CH n Set this bit to enable checking the owner attribute of the descriptor. (R/W)

GDMA_IN_EXT_MEM_BK_SIZE_CH n Block size of RX channel 0 when GDMA access external RAM. 0: 16 bytes; 1: 32 bytes; 2: 64 bytes; 3: Reserved. (R/W)

Register 3.3. GDMA_IN_POP_CH n _REG (n : 0-4) (0x001C+192* n)

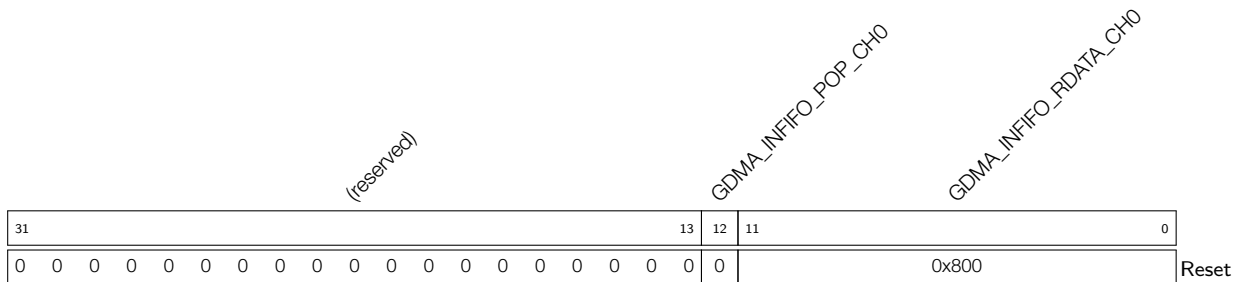

GDMA_INFIFO_RDATA_CH n This register stores the data popping from GDMA FIFO (intended for debugging). (RO)

GDMA_INFIFO_POP_CH n Set this bit to pop data from GDMA FIFO (intended for debugging). (R/W/SC)

Register 3.4. GDMA_INLINK_CH n _REG (n : 0-4) (0x0020+192* n)

(reserved)							GDMA_INLINK_PARK_CH0 GDMA_INLINK_RESTART_CH0 GDMA_INLINK_START_CH0 GDMA_INLINK_STOP_CH0 GDMA_INLINK_AUTO_RET_CH0					GDMA_INLINK_ADDR_CH0											
31						25	24	23	22	21	20	19											0
0 0 0 0 0 0 0							1	0	0	0	1	0x000										Reset	

GDMA_INLINK_ADDR_CH n This register stores the 20 least significant bits of the first receive descriptor's address. (R/W)

GDMA_INLINK_AUTO_RET_CH n Set this bit to return to current receive descriptor's address, when there are some errors in current receiving data. (R/W)

GDMA_INLINK_STOP_CH n Set this bit to stop GDMA's receive channel from receiving data. (R/W/SC)

GDMA_INLINK_START_CH n Set this bit to enable GDMA's receive channel for data transfer. (R/W/SC)

GDMA_INLINK_RESTART_CH n Set this bit to mount a new receive descriptor. (R/W/SC)

GDMA_INLINK_PARK_CH n 1: the receive descriptor's FSM is in idle state; 0: the receive descriptor's FSM is working. (RO)

Register 3.5. GDMA_OUT_CONF0_CH n _REG (n : 0-4) (0x0060+192* n)

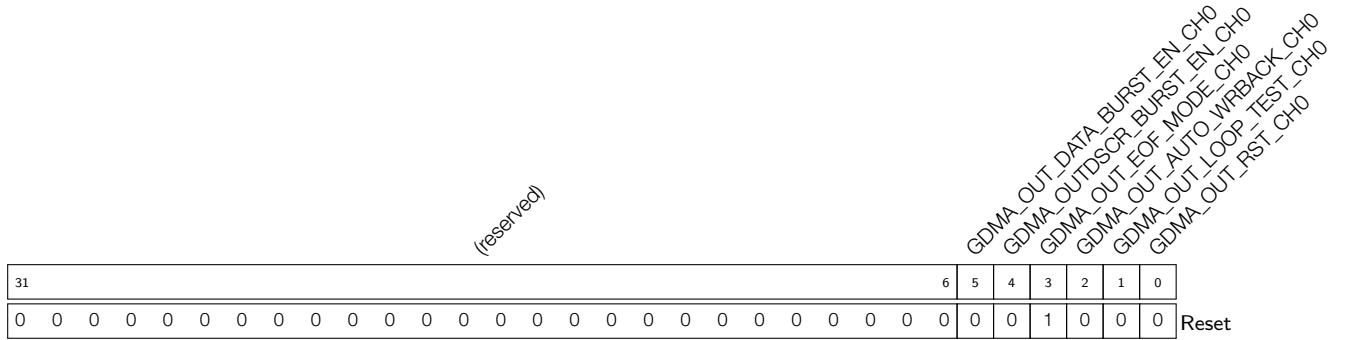

GDMA_OUT_RST_CH n This bit is used to reset GDMA channel 0 TX FSM and TX FIFO pointer. (R/W)

GDMA_OUT_LOOP_TEST_CH n Reserved. (R/W)

GDMA_OUT_AUTO_WRBACK_CH n Set this bit to enable automatic outlink-writeback when all the data in TX FIFO has been transmitted. (R/W)

GDMA_OUT_EOF_MODE_CH n EOF flag generation mode when transmitting data. 1: EOF flag for TX channel 0 is generated when data need to transmit has been popped from FIFO in GDMA. (R/W)

GDMA_OUTDSCR_BURST_EN_CH n Set this bit to 1 to enable INCR burst transfer for TX channel 0 reading descriptor when accessing internal RAM. (R/W)

GDMA_OUT_DATA_BURST_EN_CH n Set this bit to 1 to enable INCR burst transfer for TX channel 0 transmitting data when accessing internal RAM. (R/W)

Register 3.6. GDMA_OUT_CONF1_CH n _REG (n : 0-4) (0x0064+192* n)

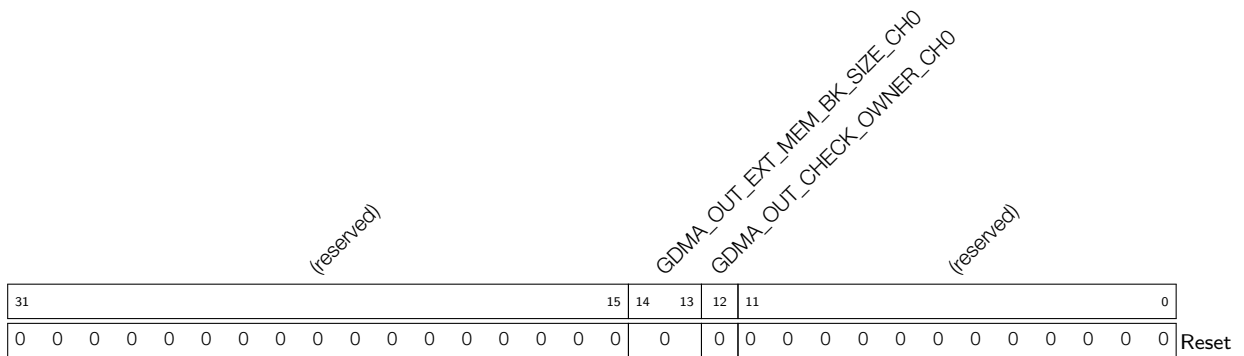

GDMA_OUT_CHECK_OWNER_CH n Set this bit to enable checking the owner attribute of the descriptor. (R/W)

GDMA_OUT_EXT_MEM_BK_SIZE_CH n Block size of TX channel 0 when GDMA access external RAM. 0: 16 bytes; 1: 32 bytes; 2: 64 bytes; 3: Reserved. (R/W)

Register 3.7. GDMA_OUT_PUSH_CH n _REG (n : 0-4) (0x007C+192* n)

(reserved)										GDMA_OUTFIFO_PUSH_CH0		GDMA_OUTFIFO_WDATA_CH0		
31										10	9	8	0	
0 0 0 0 0 0 0 0 0 0										0		0x0		Reset

GDMA_OUTFIFO_WDATA_CH n This register stores the data that need to be pushed into GDMA FIFO. (R/W)

GDMA_OUTFIFO_PUSH_CH n Set this bit to push data into GDMA FIFO. (R/W/SC)

Register 3.8. GDMA_OUT_LINK_CH n _REG (n : 0-4) (0x0080+192* n)

(reserved)								GDMA_OUTLINK_PARK_CH0				GDMA_OUTLINK_ADDR_CH0					
								GDMA_OUTLINK_RESTART_CH0				GDMA_OUTLINK_STOP_CH0					
31								24	23	22	21	20	19				0
0 0 0 0 0 0 0 0								1 0 0 0				0x000				Reset	

GDMA_OUTLINK_ADDR_CH n This register stores the 20 least significant bits of the first transmit descriptor's address. (R/W)

GDMA_OUTLINK_STOP_CH n Set this bit to stop GDMA's transmit channel from transferring data. (R/W/SC)

GDMA_OUTLINK_START_CH n Set this bit to enable GDMA's transmit channel for data transfer. (R/W/SC)

GDMA_OUTLINK_RESTART_CH n Set this bit to restart a new outlink from the last address. (R/W/SC)

GDMA_OUTLINK_PARK_CH n 1: the transmit descriptor's FSM is in idle state; 0: the transmit descriptor's FSM is working. (RO)

Register 3.9. GDMA_PD_CONF_REG (0x03C4)

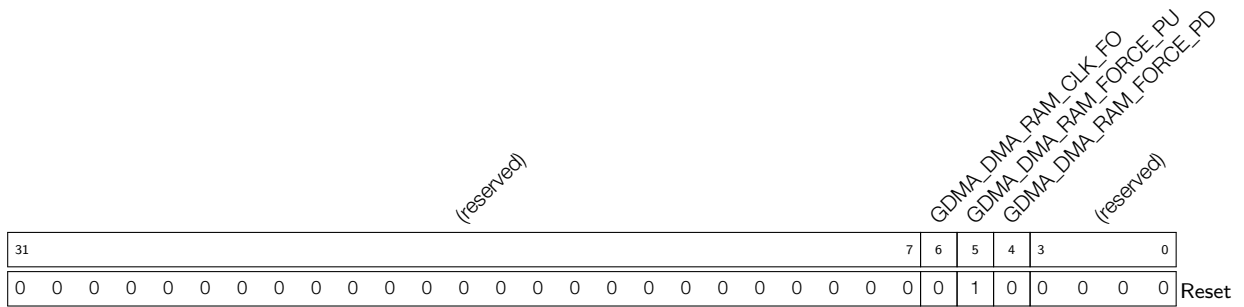

GDMA_DMA_RAM_FORCE_PD Set this bit to force power down GDMA internal memory. (R/W)

GDMA_DMA_RAM_FORCE_PU Set this bit to force power up GDMA internal memory. (R/W)

GDMA_DMA_RAM_CLK_FO 1: Force to open the clock and bypass the gate-clock when accessing the RAM in GDMA; 0: A gate-clock will be used when accessing the RAM in GDMA. (R/W)

Register 3.10. GDMA_MISC_CONF_REG (0x03C8)

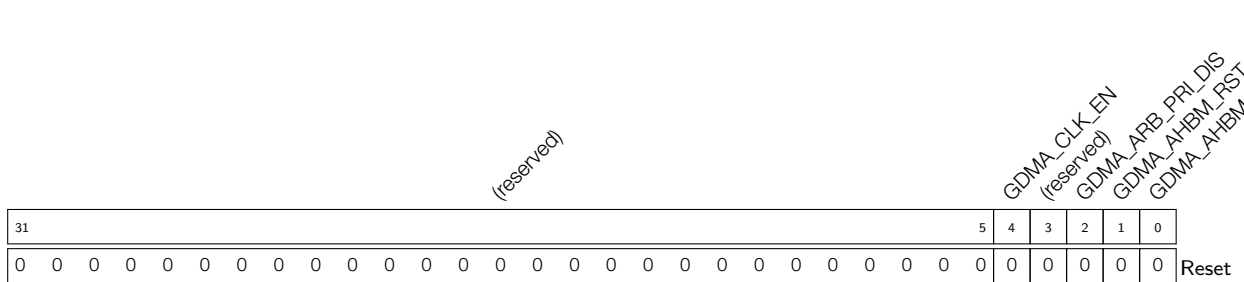

GDMA_AHBM_RST_INTER Set this bit, then clear this bit to reset the internal AHB FSM. (R/W)

GDMA_AHBM_RST_EXTER Set this bit, then clear this bit to reset the external AHB FSM. (R/W)

GDMA_ARB_PRI_DIS Set this bit to disable priority arbitration function. (R/W)

GDMA_CLK_EN 1: Force clock on for registers; 0: Support clock only when application writes registers. (R/W)

Register 3.11. GDMA_IN_INT_RAW_CH n _REG (n : 0-4) (0x0008+192* n)

(reserved)															GDMA_IN_FIFO_FULL_WM_CH0_INT_RAW GDMA_IN_DSCR_EMPTY_CH0_INT_RAW GDMA_IN_DSCR_ERR_CH0_INT_RAW GDMA_IN_ERR_EOF_CH0_INT_RAW GDMA_IN_SUC_EOF_CH0_INT_RAW GDMA_IN_DONE_CH0_INT_RAW							
31															6	5	4	3	2	1	0	
0															0							Reset

GDMA_IN_DONE_CH n _INT_RAW The raw interrupt bit turns to high level when the last data pointed by one receive descriptor has been received for RX channel 0. (R/WTC/SS)

GDMA_IN_SUC_EOF_CH n _INT_RAW The raw interrupt bit turns to high level when the last data pointed by one receive descriptor has been received for RX channel 0. For UHCI0, the raw interrupt bit turns to high level when the last data pointed by one receive descriptor has been received and no data error is detected for RX channel 0. (R/WTC/SS)

GDMA_IN_ERR_EOF_CH n _INT_RAW The raw interrupt bit turns to high level when data error is detected only in the case that the peripheral is UHCI0 for RX channel 0. For other peripherals, this raw interrupt is reserved. (R/WTC/SS)

GDMA_IN_DSCR_ERR_CH n _INT_RAW The raw interrupt bit turns to high level when detecting receive descriptor error, including owner error, the second and third word error of receive descriptor for RX channel 0. (R/WTC/SS)

GDMA_IN_DSCR_EMPTY_CH n _INT_RAW The raw interrupt bit turns to high level when RX FIFO pointed by inlink is full and receiving data is not completed, but there is no more inlink for RX channel 0. (R/WTC/SS)

GDMA_IN_FIFO_FULL_WM_CH n _INT_RAW The raw interrupt bit turns to high level when received data byte number is up to threshold configured by GDMA_DMA_IN_FIFO_FULL_THRS_CH0 in RX FIFO of RX channel 0. (R/WTC/SS)

Register 3.12. GDMA_IN_INT_ST_CH n _REG (n : 0-4) (0x000C+192* n)

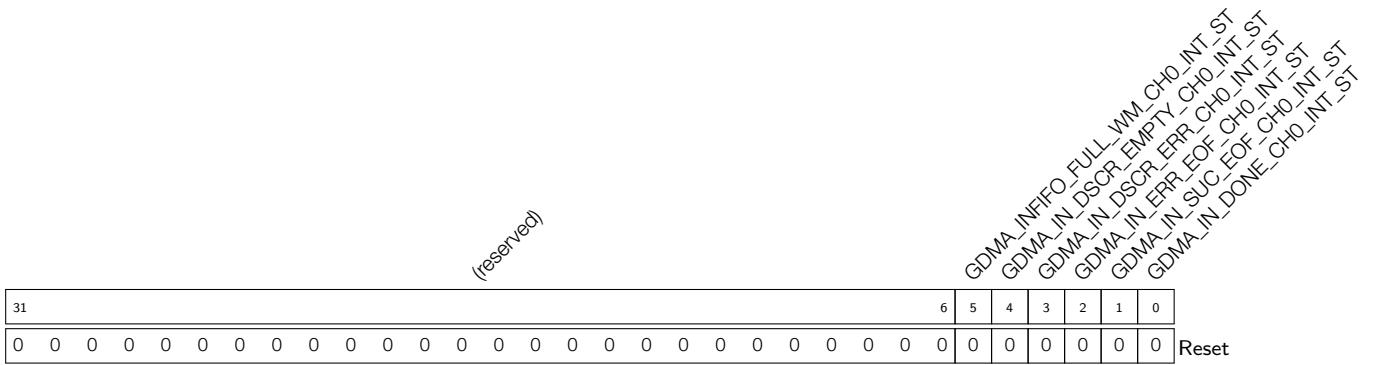

GDMA_IN_DONE_CH n _INT_ST The raw interrupt status bit for the GDMA_IN_DONE_CH_INT interrupt. (RO)

GDMA_IN_SUC_EOF_CH n _INT_ST The raw interrupt status bit for the GDMA_IN_SUC_EOF_CH_INT interrupt. (RO)

GDMA_IN_ERR_EOF_CH n _INT_ST The raw interrupt status bit for the GDMA_IN_ERR_EOF_CH_INT interrupt. (RO)

GDMA_IN_DSCR_ERR_CH n _INT_ST The raw interrupt status bit for the GDMA_IN_DSCR_ERR_CH_INT interrupt. (RO)

GDMA_IN_DSCR_EMPTY_CH n _INT_ST The raw interrupt status bit for the GDMA_IN_DSCR_EMPTY_CH_INT interrupt. (RO)

GDMA_INFIFO_FULL_WM_CH n _INT_ST The raw interrupt status bit for the GDMA_INFIFO_FULL_WM_CH_INT interrupt. (RO)

Register 3.13. GDMA_IN_INT_ENA_CH n _REG (n : 0-4) (0x0010+192* n)

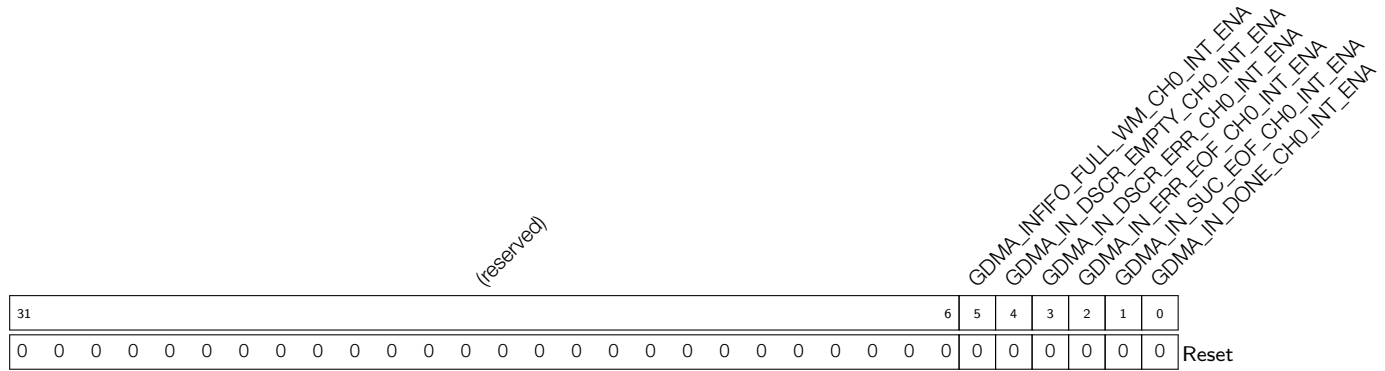

- GDMA_IN_DONE_CH n _INT_ENA** The interrupt enable bit for the GDMA_IN_DONE_CH_INT interrupt. (R/W)
- GDMA_IN_SUC_EOF_CH n _INT_ENA** The interrupt enable bit for the GDMA_IN_SUC_EOF_CH_INT interrupt. (R/W)
- GDMA_IN_ERR_EOF_CH n _INT_ENA** The interrupt enable bit for the GDMA_IN_ERR_EOF_CH_INT interrupt. (R/W)
- GDMA_IN_DSCR_ERR_CH n _INT_ENA** The interrupt enable bit for the GDMA_IN_DSCR_ERR_CH_INT interrupt. (R/W)
- GDMA_IN_DSCR_EMPTY_CH n _INT_ENA** The interrupt enable bit for the GDMA_IN_DSCR_EMPTY_CH_INT interrupt. (R/W)
- GDMA_INFIFO_FULL_WM_CH n _INT_ENA** The interrupt enable bit for the GDMA_INFIFO_FULL_WM_CH_INT interrupt. (R/W)

Register 3.14. GDMA_IN_INT_CLR_CH n _REG (n : 0-4) (0x0014+192* n)

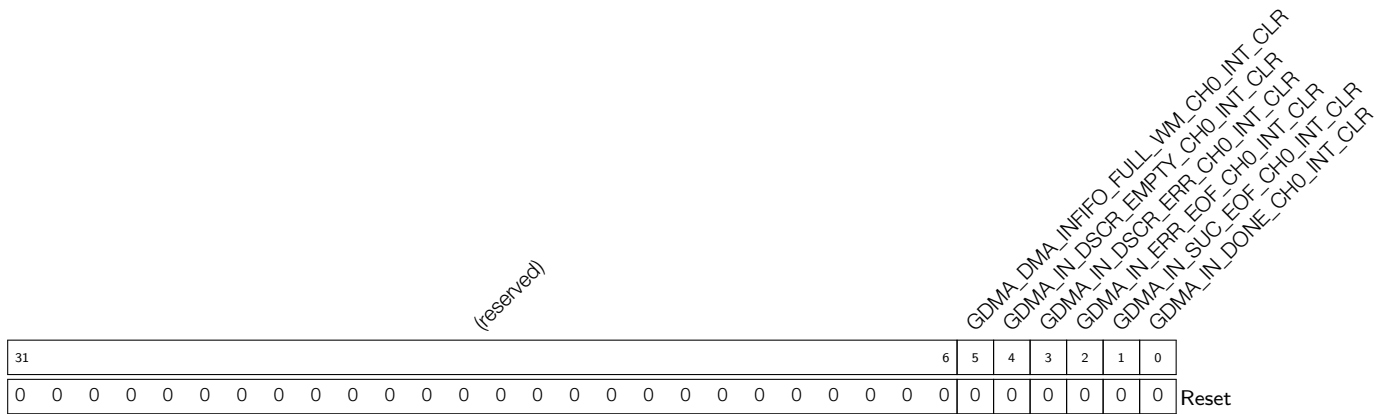

- GDMA_IN_DONE_CH n _INT_CLR** Set this bit to clear the GDMA_IN_DONE_CH_INT interrupt. (WT)
- GDMA_IN_SUC_EOF_CH n _INT_CLR** Set this bit to clear the GDMA_IN_SUC_EOF_CH_INT interrupt. (WT)
- GDMA_IN_ERR_EOF_CH n _INT_CLR** Set this bit to clear the GDMA_IN_ERR_EOF_CH_INT interrupt. (WT)
- GDMA_IN_DSCR_ERR_CH n _INT_CLR** Set this bit to clear the GDMA_IN_DSCR_ERR_CH_INT interrupt. (WT)
- GDMA_IN_DSCR_EMPTY_CH n _INT_CLR** Set this bit to clear the GDMA_IN_DSCR_EMPTY_CH_INT interrupt. (WT)
- GDMA_DMA_INFIFO_FULL_WM_CH n _INT_CLR** Set this bit to clear the GDMA_DMA_INFIFO_FULL_WM_CH_INT interrupt. (WT)

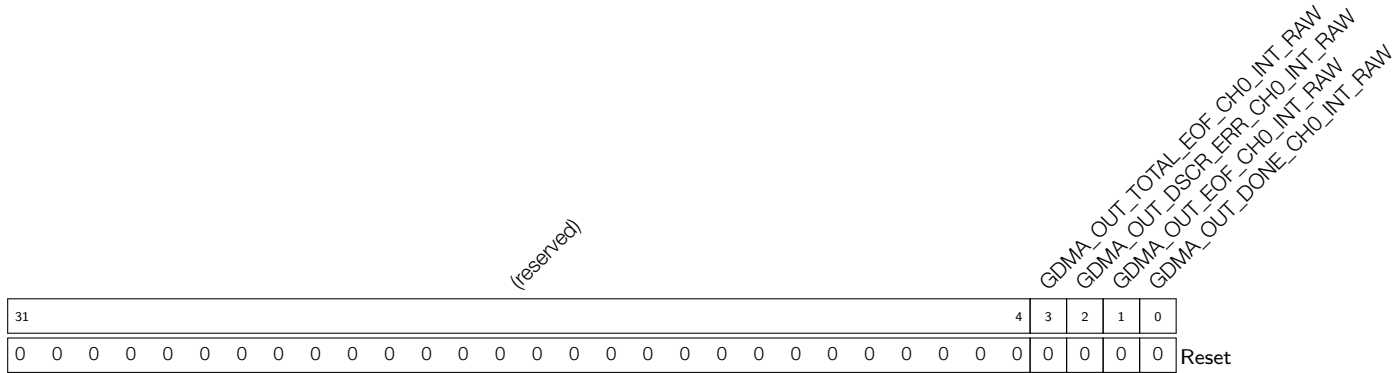
Register 3.15. GDMA_OUT_INT_RAW_CH n _REG (n : 0-4) (0x0068+192* n)

GDMA_OUT_DONE_CH n _INT_RAW The raw interrupt bit turns to high level when the last data pointed by one transmit descriptor has been transmitted to peripherals for TX channel 0. (R/WTC/SS)

GDMA_OUT_EOF_CH n _INT_RAW The raw interrupt bit turns to high level when the last data pointed by one transmit descriptor has been read from memory for TX channel 0. (R/WTC/SS)

GDMA_OUT_DSCR_ERR_CH n _INT_RAW The raw interrupt bit turns to high level when detecting transmit descriptor error, including owner error, the second and third word error of transmit descriptor for TX channel 0. (R/WTC/SS)

GDMA_OUT_TOTAL_EOF_CH n _INT_RAW The raw interrupt bit turns to high level when data corresponding a outlink (includes one descriptor or few descriptors) is transmitted out for TX channel 0. (R/WTC/SS)

Register 3.18. GDMA_OUT_INT_CLR_CH n _REG (n : 0-4) (0x0074+192* n)

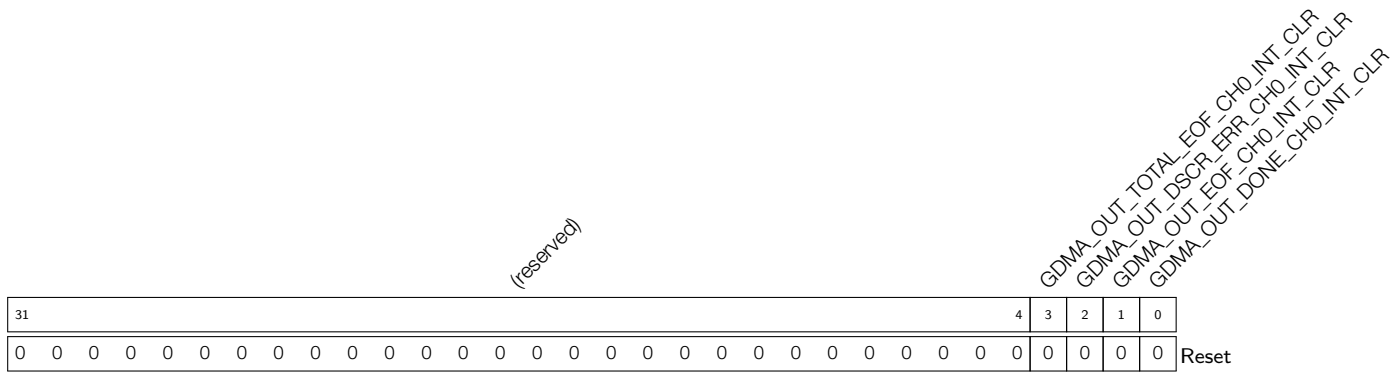

GDMA_OUT_DONE_CH n _INT_CLR Set this bit to clear the GDMA_OUT_DONE_CH_INT interrupt. (WT)

GDMA_OUT_EOF_CH n _INT_CLR Set this bit to clear the GDMA_OUT_EOF_CH_INT interrupt. (WT)

GDMA_OUT_DSCR_ERR_CH n _INT_CLR Set this bit to clear the GDMA_OUT_DSCR_ERR_CH_INT interrupt. (WT)

GDMA_OUT_TOTAL_EOF_CH n _INT_CLR Set this bit to clear the GDMA_OUT_TOTAL_EOF_CH_INT interrupt. (WT)

Register 3.19. GDMA_EXTMEM_REJECT_INT_RAW_REG (0x03FC)

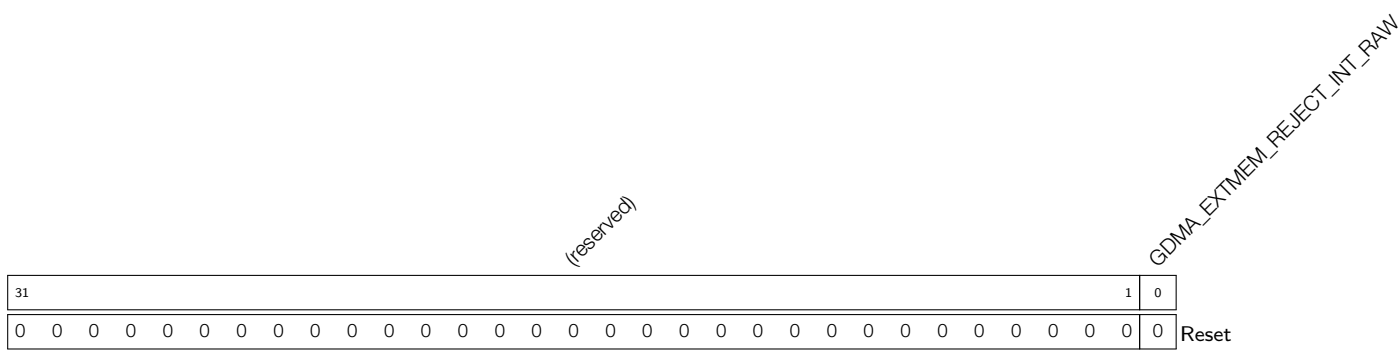

GDMA_EXTMEM_REJECT_INT_RAW The raw interrupt bit turns to high level when accessing external RAM is rejected by permission control. (R/WTC/SS)

Register 3.20. GDMA_EXTMEM_REJECT_INT_ST_REG (0x0400)

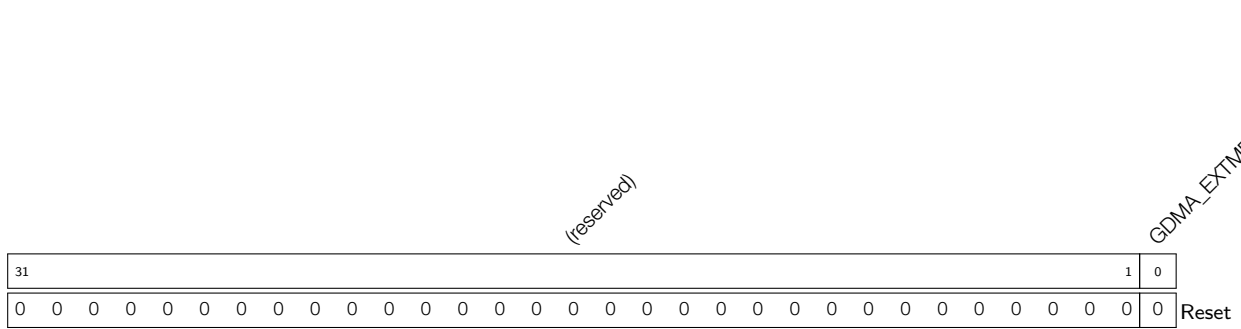

GDMA_EXTMEM_REJECT_INT_ST The raw interrupt status bit for the GDMA_EXTMEM_REJECT_INT interrupt. (RO)

Register 3.21. GDMA_EXTMEM_REJECT_INT_ENA_REG (0x0404)

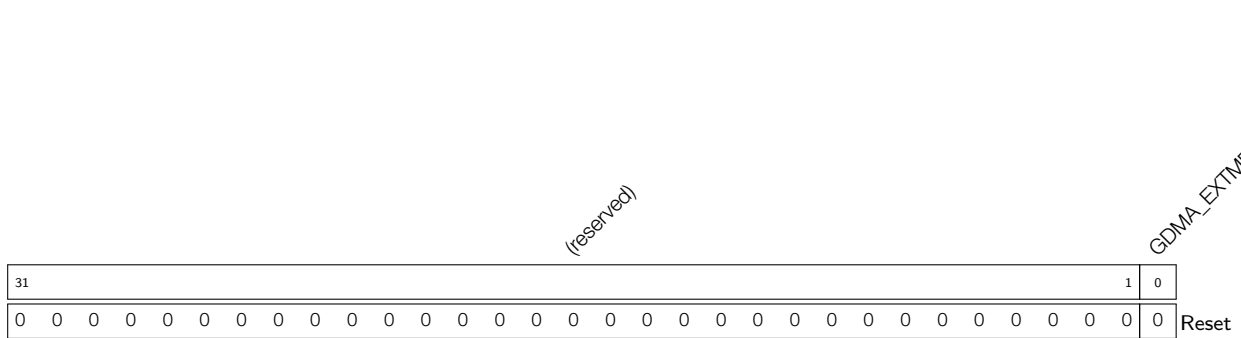

GDMA_EXTMEM_REJECT_INT_ENA The interrupt enable bit for the GDMA_EXTMEM_REJECT_INT interrupt. (R/W)

Register 3.22. GDMA_EXTMEM_REJECT_INT_CLR_REG (0x0408)

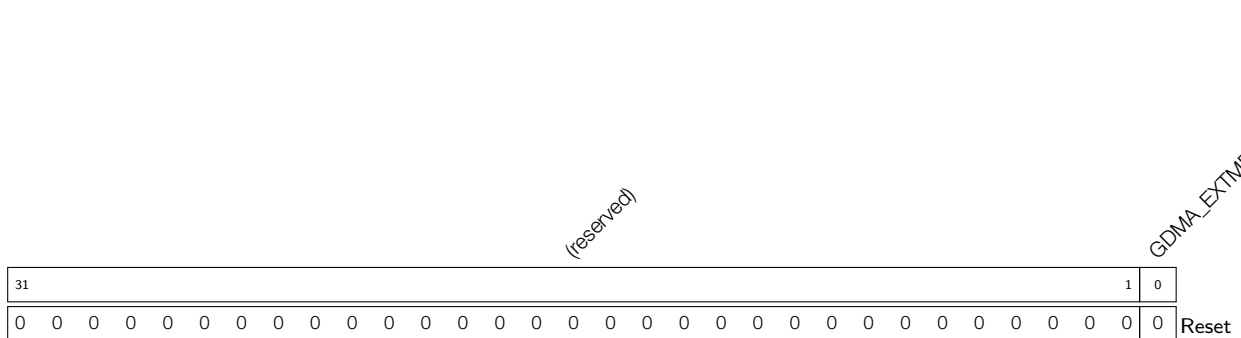

GDMA_EXTMEM_REJECT_INT_CLR Set this bit to clear the GDMA_EXTMEM_REJECT_INT interrupt. (WT)

Register 3.23. GDMA_INFIFO_STATUS_CH n _REG (n : 0-4) (0x0018+192* n)

(reserved)				GDMA_INFIFO_CNT_L3_CH0				GDMA_INFIFO_CNT_L2_CH0				GDMA_INFIFO_CNT_L1_CH0				GDMA_INFIFO_EMPTY_L3_CH0				GDMA_INFIFO_FULL_L3_CH0				GDMA_INFIFO_EMPTY_L2_CH0				GDMA_INFIFO_FULL_L2_CH0				GDMA_INFIFO_EMPTY_L1_CH0				GDMA_INFIFO_FULL_L1_CH0			
31	29	28	27	26	25	24	23	19	18	12	11	6	5	4	3	2	1	0	31	29	28	27	26	25	24	23	19	18	12	11	6	5	4	3	2	1	0	Reset	
0	0	0	0	1	1	1	1	0	0	0	0	1	1	1	0	1	0	0	0	0	0	0	0	0	0	0	0	0	0	0	0	0	0	0	0	0	0		

GDMA_INFIFO_FULL_L1_CH n L1 RX FIFO full signal for RX channel 0. (RO)

GDMA_INFIFO_EMPTY_L1_CH n L1 RX FIFO empty signal for RX channel 0. (RO)

GDMA_INFIFO_FULL_L2_CH n L2 RX FIFO full signal for RX channel 0. (RO)

GDMA_INFIFO_EMPTY_L2_CH n L2 RX FIFO empty signal for RX channel 0. (RO)

GDMA_INFIFO_FULL_L3_CH n L3 RX FIFO full signal for RX channel 0. (RO)

GDMA_INFIFO_EMPTY_L3_CH n L3 RX FIFO empty signal for RX channel 0. (RO)

GDMA_INFIFO_CNT_L1_CH n The register stores the byte number of the data in L1 RX FIFO for RX channel 0. (RO)

GDMA_INFIFO_CNT_L2_CH n The register stores the byte number of the data in L2 RX FIFO for RX channel 0. (RO)

GDMA_INFIFO_CNT_L3_CH n The register stores the byte number of the data in L3 RX FIFO for RX channel 0. (RO)

Register 3.24. GDMA_IN_STATE_CH n _REG (n : 0-4) (0x0024+192* n)

(reserved)								GDMA_INLINK_DSCR_ADDR_CH0								
31	23	22	20	19	18	17	0	31	23	22	20	19	18	17	0	Reset
0	0	0	0	0	0	0	0	0	0	0	0	0	0	0	0	0

GDMA_INLINK_DSCR_ADDR_CH n This register stores the current receive descriptor's address. (RO)

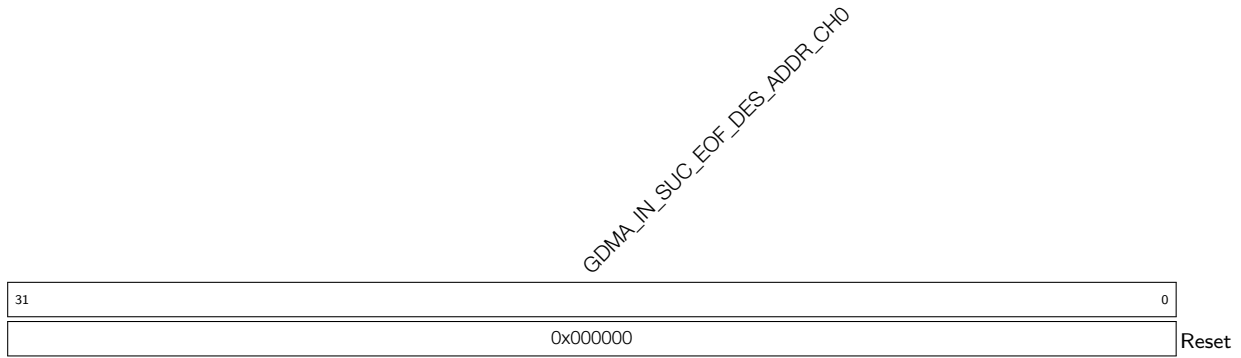
Register 3.25. GDMA_IN_SUC_EOF_DES_ADDR_CH n _REG (n : 0-4) (0x0028+192* n)

GDMA_IN_SUC_EOF_DES_ADDR_CH n This register stores the address of the receive descriptor when the EOF bit in this descriptor is 1. (RO)

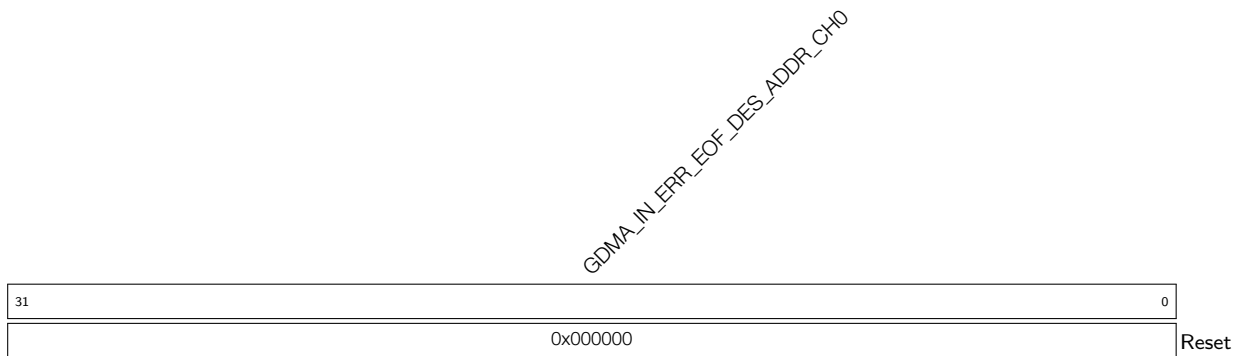
Register 3.26. GDMA_IN_ERR_EOF_DES_ADDR_CH n _REG (n : 0-4) (0x002C+192* n)

GDMA_IN_ERR_EOF_DES_ADDR_CH n This register stores the address of the receive descriptor when there are some errors in current receiving data. Only used when peripheral is UHCI0. (RO)

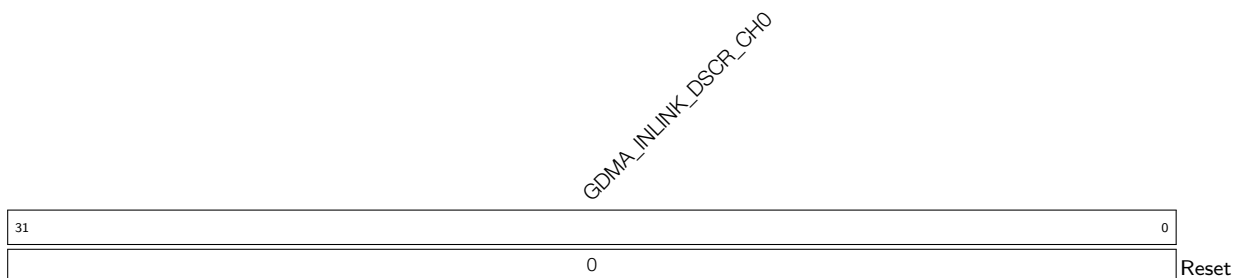
Register 3.27. GDMA_IN_DSCR_CH n _REG (n : 0-4) (0x0030+192* n)

GDMA_INLINK_DSCR_CH n The address of the current receive descriptor x. (RO)

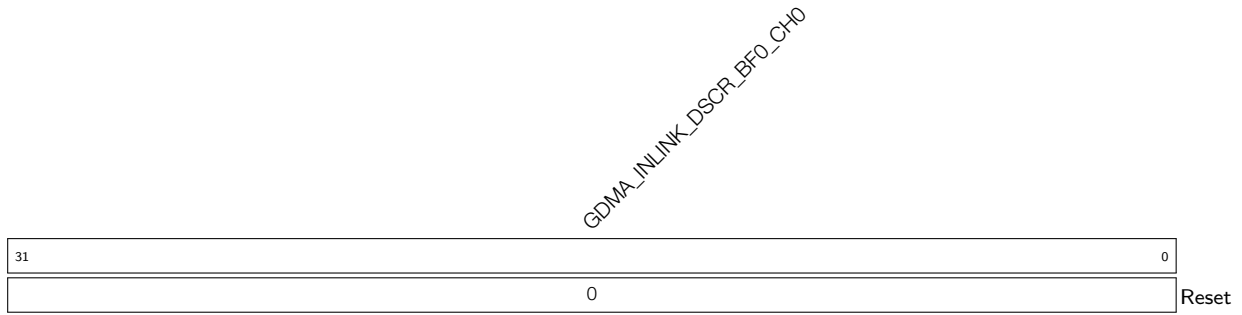
Register 3.28. GDMA_IN_DSCR_BF0_CH n _REG (n : 0-4) (0x0034+192* n)

GDMA_INLINK_DSCR_BF0_CH n The address of the last receive descriptor x-1. (RO)

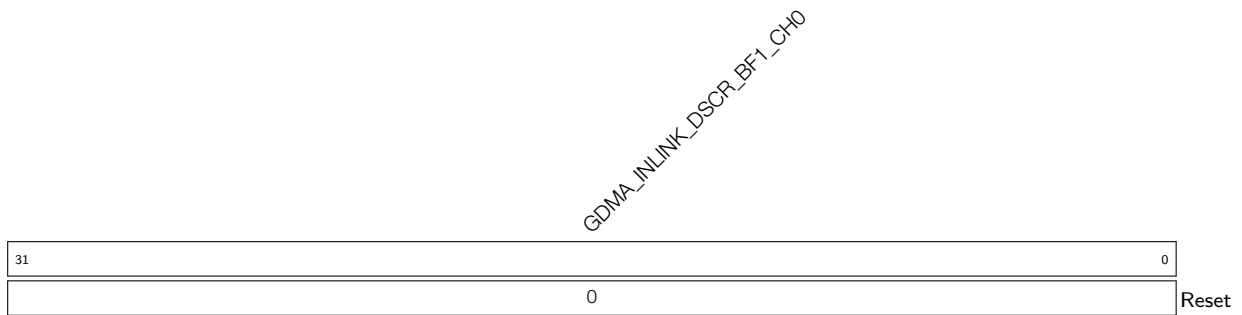
Register 3.29. GDMA_IN_DSCR_BF1_CH n _REG (n : 0-4) (0x0038+192* n)

GDMA_INLINK_DSCR_BF1_CH n The address of the second-to-last receive descriptor x-2. (RO)

Register 3.30. GDMA_OUTFIFO_STATUS_CH n _REG (n : 0-4) (0x0078+192* n)

(reserved)					GDMA_OUT_REMAIN_UNDER_4B_L3_CH0				GDMA_OUT_REMAIN_UNDER_3B_L3_CH0				GDMA_OUT_REMAIN_UNDER_2B_L3_CH0				GDMA_OUT_REMAIN_UNDER_1B_L3_CH0				GDMA_OUTFIFO_CNT_L3_CH0				GDMA_OUTFIFO_CNT_L2_CH0				GDMA_OUTFIFO_CNT_L1_CH0				GDMA_OUTFIFO_EMPTY_L3_CH0				GDMA_OUTFIFO_FULL_L3_CH0				GDMA_OUTFIFO_EMPTY_L2_CH0				GDMA_OUTFIFO_FULL_L2_CH0				GDMA_OUTFIFO_EMPTY_L1_CH0				GDMA_OUTFIFO_FULL_L1_CH0			
31	27	26	25	24	23	22	18	17	11	10	6	5	4	3	2	1	0	Reset																																						
0	0	0	0	0	1	1	1	1	0	0	0	1	0	1	0	1	0	0																																						

GDMA_OUTFIFO_FULL_L1_CH n L1 TX FIFO full signal for TX channel 0. (RO)

GDMA_OUTFIFO_EMPTY_L1_CH n L1 TX FIFO empty signal for TX channel 0. (RO)

GDMA_OUTFIFO_FULL_L2_CH n L2 TX FIFO full signal for TX channel 0. (RO)

GDMA_OUTFIFO_EMPTY_L2_CH n L2 TX FIFO empty signal for TX channel 0. (RO)

GDMA_OUTFIFO_FULL_L3_CH n L3 TX FIFO full signal for TX channel 0. (RO)

GDMA_OUTFIFO_EMPTY_L3_CH n L3 TX FIFO empty signal for TX channel 0. (RO)

GDMA_OUTFIFO_CNT_L1_CH n The register stores the byte number of the data in L1 TX FIFO for TX channel 0. (RO)

GDMA_OUTFIFO_CNT_L2_CH n The register stores the byte number of the data in L2 TX FIFO for TX channel 0. (RO)

GDMA_OUTFIFO_CNT_L3_CH n The register stores the byte number of the data in L3 TX FIFO for TX channel 0. (RO)

GDMA_OUT_REMAIN_UNDER_1B_L3_CH n Reserved. (RO)

GDMA_OUT_REMAIN_UNDER_2B_L3_CH n Reserved. (RO)

GDMA_OUT_REMAIN_UNDER_3B_L3_CH n Reserved. (RO)

GDMA_OUT_REMAIN_UNDER_4B_L3_CH n Reserved. (RO)

Register 3.31. GDMA_OUT_STATE_CH n _REG (n : 0-4) (0x0084+192* n)

(reserved)										GDMA_OUT_STATE_CH0				GDMA_OUT_DSCR_STATE_CH0				GDMA_OUTLINK_DSCR_ADDR_CH0					
31									23	22	20	19	18	17									0
0 0 0 0 0 0 0 0 0 0										0				0				0				Reset	

GDMA_OUTLINK_DSCR_ADDR_CH n This register stores the current transmit descriptor's address. (RO)

GDMA_OUT_DSCR_STATE_CH n Reserved. (RO)

GDMA_OUT_STATE_CH n Reserved. (RO)

Register 3.32. GDMA_OUT_EOF_DES_ADDR_CH n _REG (n : 0-4) (0x0088+192* n)

GDMA_OUT_EOF_DES_ADDR_CH0																																
31																															0	
0x000000																																Reset

GDMA_OUT_EOF_DES_ADDR_CH n This register stores the address of the transmit descriptor when the EOF bit in this descriptor is 1. (RO)

Register 3.33. GDMA_OUT_EOF_BFR_DES_ADDR_CH n _REG (n : 0-4) (0x008C+192* n)

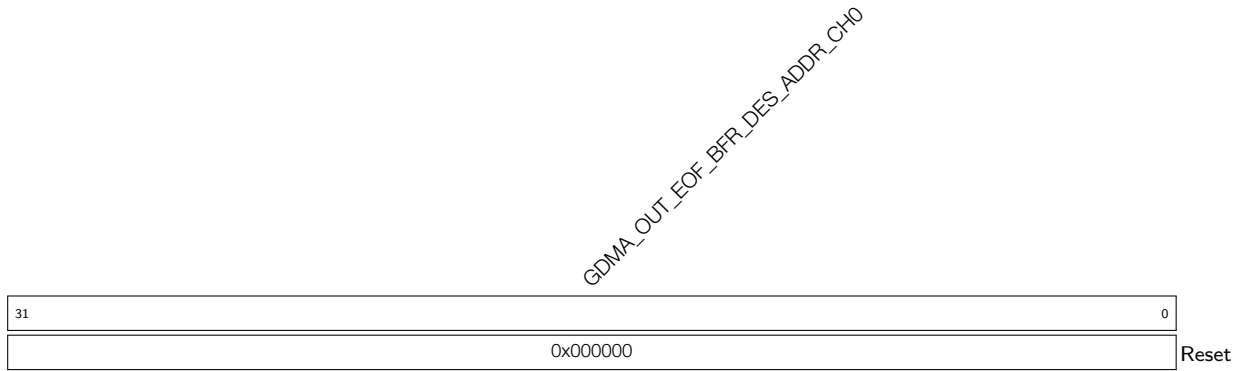

GDMA_OUT_EOF_BFR_DES_ADDR_CH n This register stores the address of the transmit descriptor before the last transmit descriptor. (RO)

Register 3.34. GDMA_OUT_DSCR_CH n _REG (n : 0-4) (0x0090+192* n)

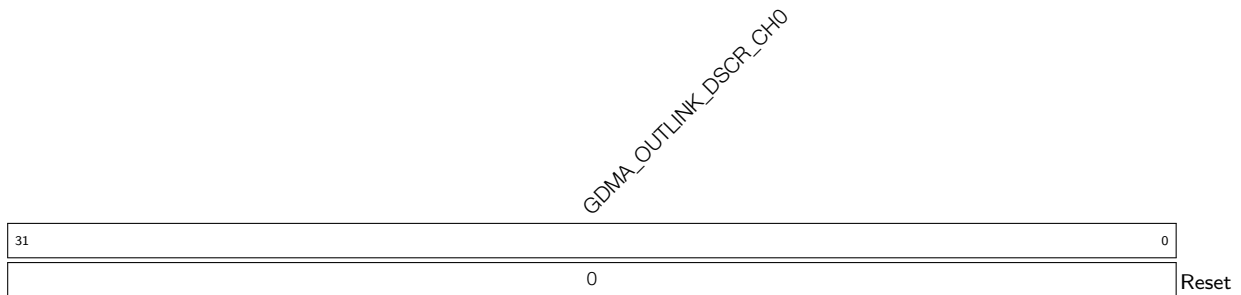

GDMA_OUTLINK_DSCR_CH n The address of the current transmit descriptor y . (RO)

Register 3.35. GDMA_OUT_DSCR_BF0_CH n _REG (n : 0-4) (0x0094+192* n)

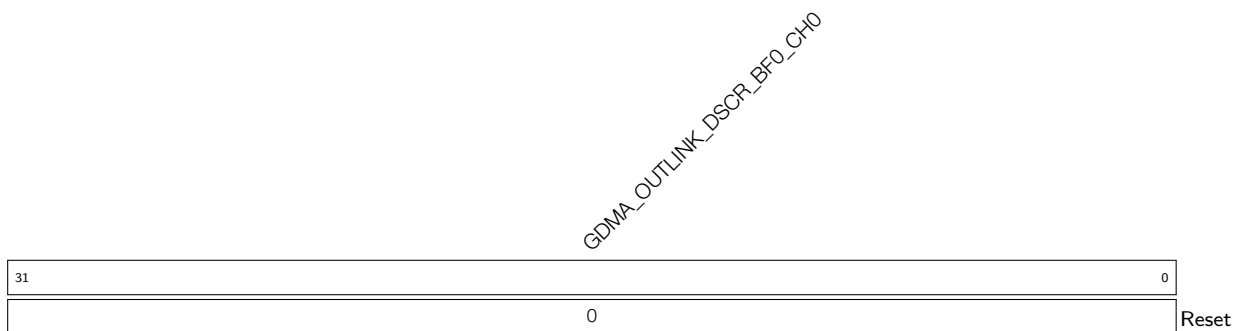

GDMA_OUTLINK_DSCR_BF0_CH n The address of the last transmit descriptor $y-1$. (RO)

Register 3.36. GDMA_OUT_DSCR_BF1_CH n _REG (n : 0-4) (0x0098+192* n)

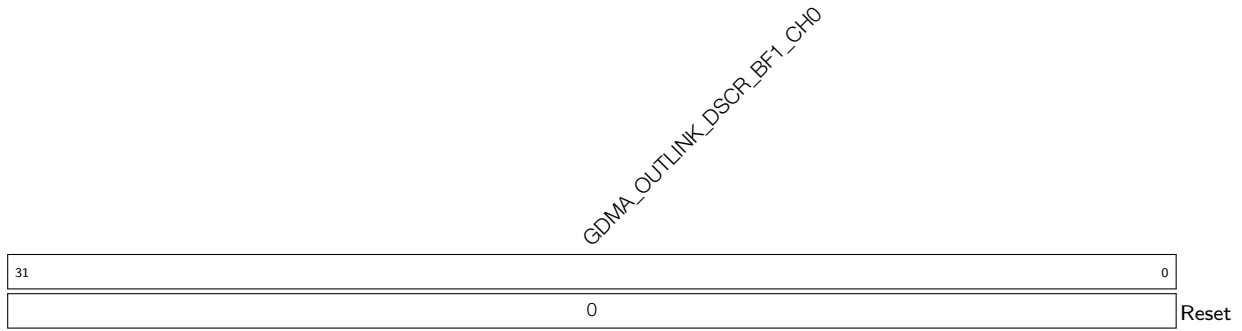

GDMA_OUTLINK_DSCR_BF1_CH n The address of the second-to-last receive descriptor x-2. (RO)

Register 3.37. GDMA_IN_PRI_CH n _REG (n : 0-4) (0x0044+192* n)

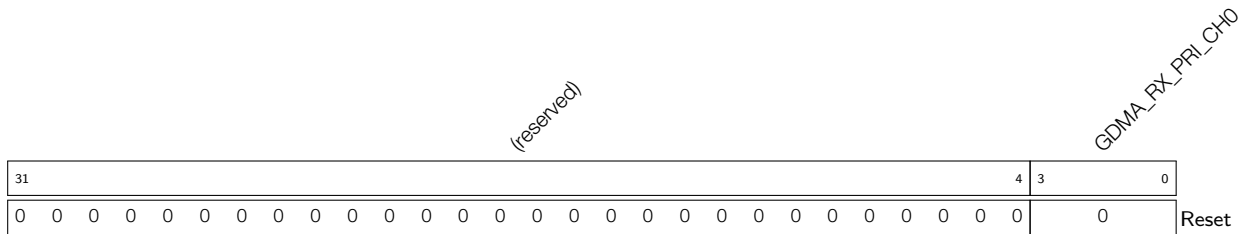

GDMA_RX_PRI_CH n The priority of RX channel 0. The larger the value, the higher the priority. (R/W)

Register 3.38. GDMA_OUT_PRI_CH n _REG (n : 0-4) (0x00A4+192* n)

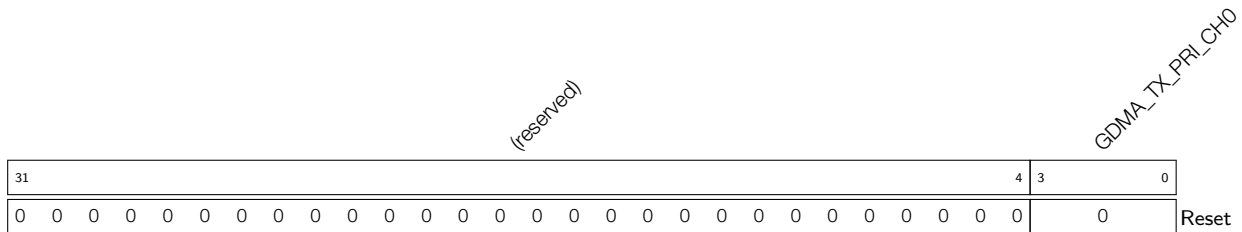

GDMA_TX_PRI_CH n The priority of TX channel 0. The larger the value, the higher the priority. (R/W)

Register 3.39. GDMA_IN_PERI_SEL_CH n _REG (n : 0-4) (0x0048+192* n)

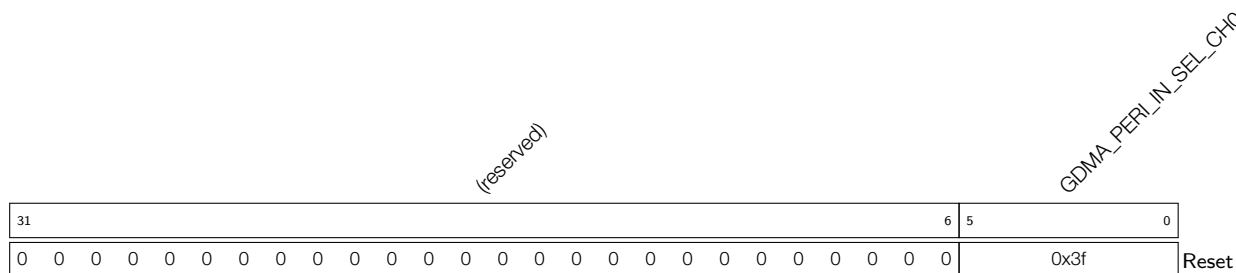

GDMA_PERI_IN_SEL_CH n This register is used to select peripheral for RX channel 0. 0: SPI2; 1: SPI3; 2: UHCI0; 3: I2S0; 4: I2S1; 5: LCD_CAM; 6: AES; 7: SHA; 8: ADC_DAC; 9: RMT. (R/W)

Register 3.40. GDMA_OUT_PERI_SEL_CH n _REG (n : 0-4) (0x00A8+192* n)

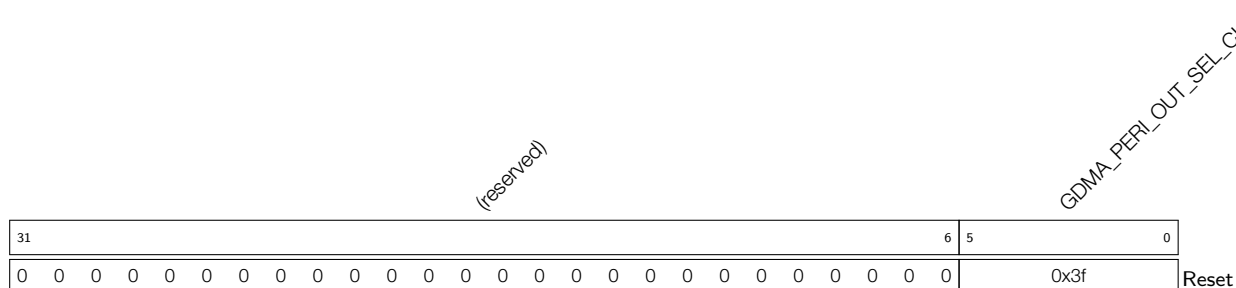

GDMA_PERI_OUT_SEL_CH n This register is used to select peripheral for TX channel 0. 0: SPI2; 1: SPI3; 2: UHCI0; 3: I2S0; 4: I2S1; 5: LCD_CAM; 6: AES; 7: SHA; 8: ADC_DAC; 9: RMT. (R/W)

Register 3.41. GDMA_EXTMEM_REJECT_ADDR_REG (0x03F4)

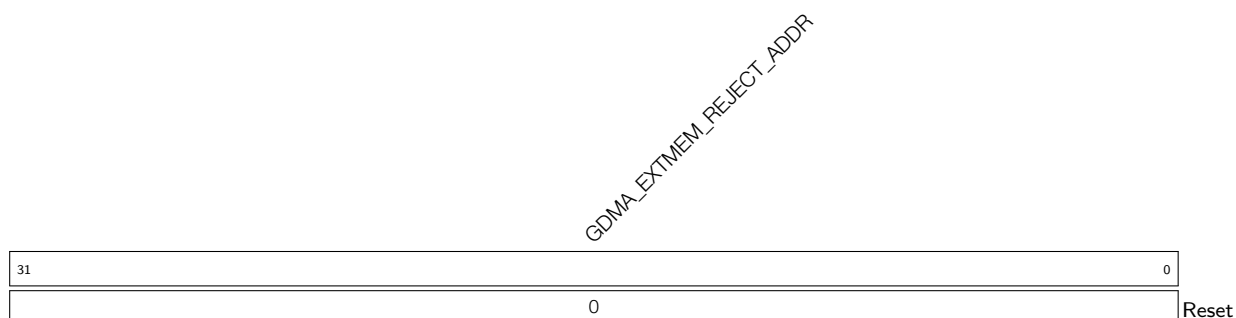

GDMA_EXTMEM_REJECT_ADDR This register store the first address rejected by permission control when accessing external RAM. (RO)

Register 3.42. GDMA_EXTMEM_REJECT_ST_REG (0x03F8)

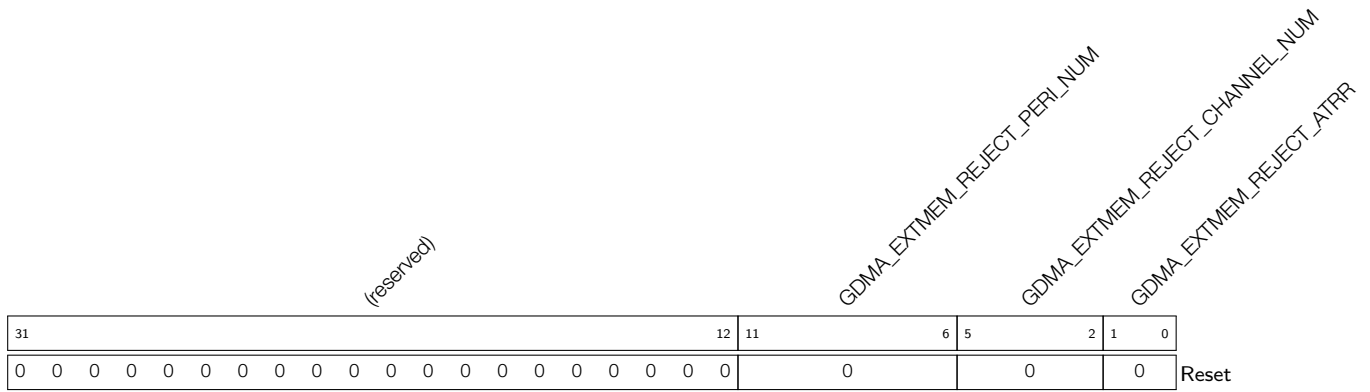

GDMA_EXTMEM_REJECT_ATTR Read or write attribute of the rejected access. Bit 0: if this bit is 1, the rejected access is READ. Bit 1: if this bit is 1, the rejected access is WRITE. (RO)

GDMA_EXTMEM_REJECT_CHANNEL_NUM This field indicates the channel used for the rejected access. (RO)

GDMA_EXTMEM_REJECT_PERI_NUM This bit indicates the peripheral whose access was rejected. (RO)

Register 3.43. GDMA_DATE_REG (0x040C)

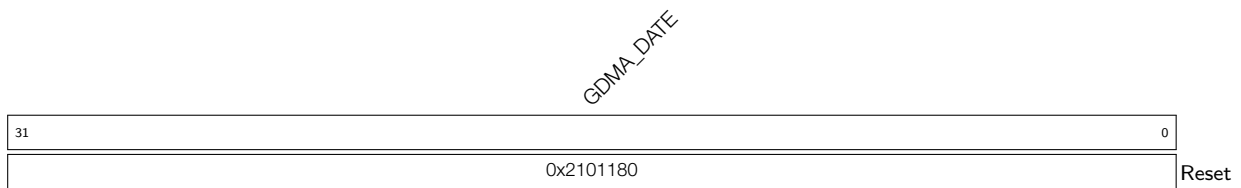

GDMA_DATE This is the version control register. (R/W)

4 System and Memory

4.1 Overview

The ESP32-S3 is a dual-core system with two Harvard Architecture Xtensa® LX7 CPUs. All internal memory, external memory, and peripherals are located on the CPU buses.

4.2 Features

- **Address Space**
 - 848 KB of internal memory address space accessed from the instruction bus
 - 560 KB of internal memory address space accessed from the data bus
 - 836 KB of peripheral address space
 - 32 MB of external memory virtual address space accessed from the instruction bus
 - 32 MB external memory virtual address space accessed from the data bus
 - 480 KB of internal DMA address space
 - 32 MB of external DMA address space
- **Internal Memory**
 - 384 KB Internal ROM
 - 512 KB Internal SRAM
 - 8 KB RTC FAST Memory
 - 8 KB RTC SLOW Memory
- **External Memory**
 - Supports up to 1 GB external flash
 - Supports up to 1 GB external RAM
- **Peripheral Space**
 - 45 modules/peripherals in total
- **GDMA**
 - 11 GDMA-supported modules/peripherals

Figure 4-1 illustrates the system structure and address mapping.

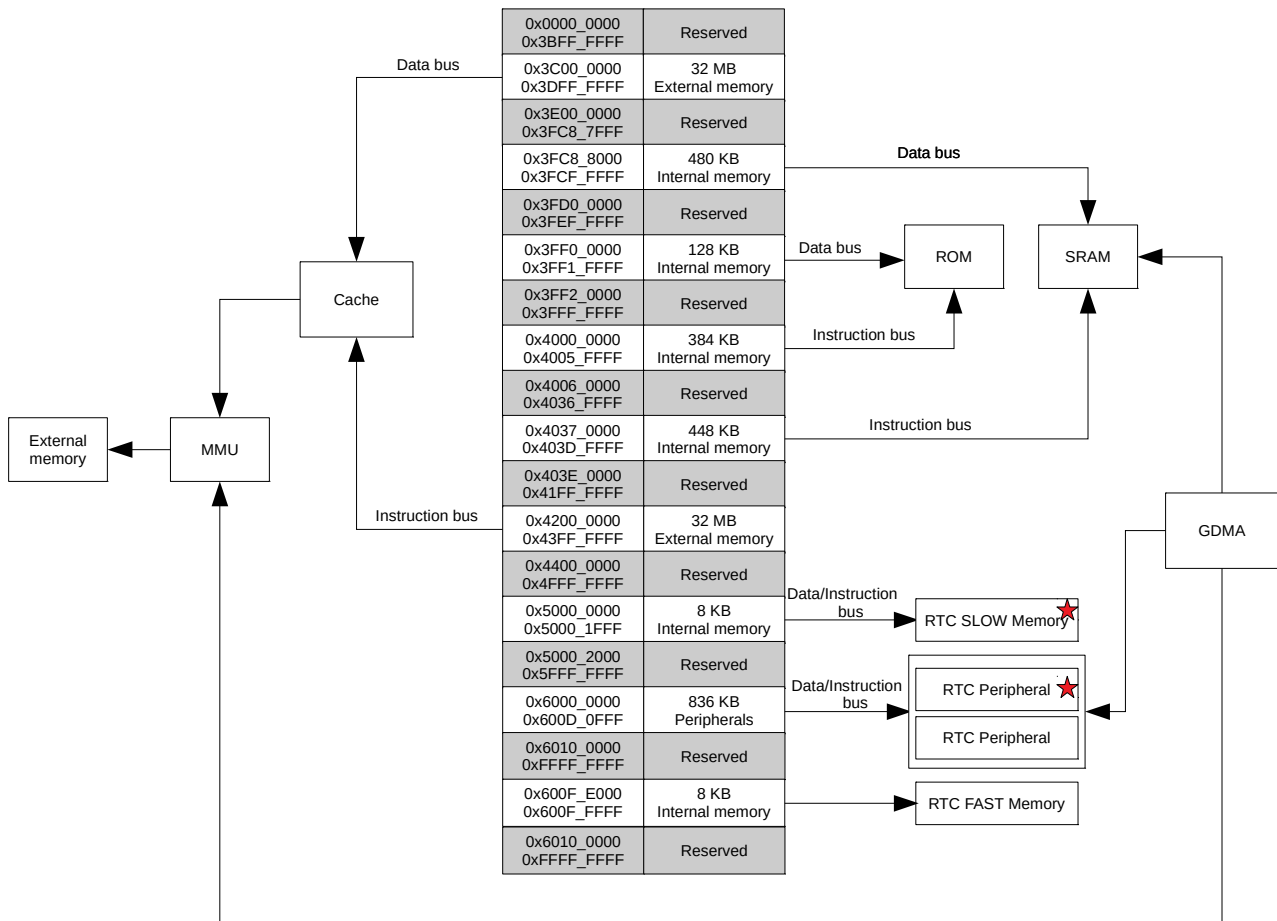

Figure 4-1. System Structure and Address Mapping

Note:

- The address space with gray background is not available to users.
- The memory or peripheral marked with a red pentagram can be accessed by the ULP co-processor.
- The range of addresses available in the address space may be larger than the actual available memory of a particular type.

4.3 Functional Description

4.3.1 Address Mapping

The system contains two Harvard Architecture Xtensa® LX7 CPUs, and both can access the same range of address space.

Addresses below 0x4000_0000 are accessed using the data bus. Addresses in the range of 0x4000_0000 ~ 0x4FFF_FFFF are accessed using the instruction bus. Addresses over and including 0x5000_0000 are shared by both data bus and instruction bus.

Both data bus and instruction bus are little-endian. The CPU can access data via the data bus using single-byte, double-byte, 4-byte and 16-byte alignment. The CPU can also access data via the instruction bus, but only in

4-byte aligned manner; non-aligned data access will cause a CPU exception.

The CPU can:

- directly access the internal memory via both data bus and instruction bus;
- directly access the external memory which is mapped into the address space via cache;
- directly access modules/peripherals via data bus.

Figure 4-1 lists the address ranges on the data bus and instruction bus and their corresponding target memory.

Some internal and external memory can be accessed via both data bus and instruction bus. In such cases, the CPU can access the same memory using multiple addresses.

4.3.2 Internal Memory

The ESP32-S3 consists of the following three types of internal memory:

- Internal ROM (384 KB): The internal ROM is a read-only memory and cannot be programmed. Internal ROM contains the ROM code (software instructions and some software read-only data) of some low level system software.
- Internal SRAM (512 KB): The Internal Static RAM (SRAM) is a volatile memory that can be quickly accessed by the CPU (generally within a single CPU clock cycle).
 - A part of the SRAM can be configured to operate as a cache for external memory access, which cannot be accessed by CPU in such case.
 - Some parts of the SRAM can only be accessed via the CPU's instruction bus.
 - Some parts of the SRAM can only be accessed via the CPU's data bus.
 - Some parts of the SRAM can be accessed via both the CPU's instruction bus and the CPU's data bus.
- RTC Memory (16 KB): The RTC (Real Time Clock) memory implemented as Static RAM (SRAM) and thus is volatile. However, RTC memory has the added feature of being persistent throughout deep sleep (i.e., the RTC memory retains its values throughout deep sleep).
 - RTC FAST Memory (8 KB): RTC FAST memory can only be accessed by the CPU, and cannot be accessed by the ULP co-processor. It is generally used to store instructions and data that needs to persist across a deep sleep.
 - RTC SLOW Memory (8 KB): The RTC SLOW memory can be accessed by both the CPU and the ULP co-processor, and thus is generally used to store instructions and share data between the CPU and the ULP co-processor.

Based on the three different types of internal memory described above, the internal memory of the ESP32-S3 is split into four segments: Internal ROM (384 KB), Internal SRAM (512 KB), RTC FAST Memory (8 KB) and RTC SLOW Memory (8 KB). However, within each segment, there may be different bus access restrictions (e.g., some parts of the segment may only be accessible by the CPU's instruction bus). Therefore, some segments are also further divided down into parts. Table 4-1 describes each part of internal memory and their address ranges on the data bus and/or instruction bus.

Table 4-1. Internal Memory Address Mapping

Bus Type	Boundary Address		Size (KB)	Target
	Low Address	High Address		
Data bus	0x3FF0_0000	0x3FF1_FFFF	128	Internal ROM 1
	0x3FC8_8000	0x3FCE_FFFF	416	Internal SRAM 1
	0x3FCF_0000	0x3FCF_FFFF	64	Internal SRAM 2
Instruction bus	0x4000_0000	0x4003_FFFF	256	Internal ROM 0
	0x4004_0000	0x4005_FFFF	128	Internal ROM 1
	0x4037_0000	0x4037_7FFF	32	Internal SRAM 0
	0x4037_8000	0x403D_FFFF	416	Internal SRAM 1
Data/Instruction bus	0x5000_0000	0x5000_1FFF	8	RTC SLOW Memory
	0x600F_E000	0x600F_FFFF	8	RTC FAST Memory

Note:

All of the internal memories are managed by Permission Control module. An internal memory can only be accessed when it is allowed by Permission Control, then the internal memory can be available to the CPU. For more information about Permission Control, please refer to Chapter 15 *Permission Control (PMS)*.

1. Internal ROM 0

Internal ROM 0 is a 256 KB, read-only memory space, addressed by the CPU only through the instruction bus, as shown in Table 4-1.

2. Internal ROM 1

Internal ROM 1 is a 128 KB, read-only memory space, addressed by the CPU through the instruction bus via 0x4004_0000 ~ 0x4005_FFFF or through the data bus via 0x3FF0_0000 ~ 0x3FF1_FFFF in the same order, as shown in Table 4-1.

This means, for example, address 0x4004_0000 and 0x3FF0_0000 correspond to the same word, 0x4004_0004 and 0x3FF0_0004 correspond to the same word, 0x4004_0008 and 0x3FF0_0008 correspond to the same word, etc (same below).

3. Internal SRAM 0

Internal SRAM 0 is a 32 KB, read-and-write memory space, addressed by the CPU through the instruction bus, as shown in Table 4-1.

A 16 KB or the total 32 KB of this memory space can be configured as instruction cache (ICache) to store instructions or read-only data of the external memory. In this case, the occupied memory space cannot be accessed by the CPU, while the remaining can still be accessed by the CPU.

4. Internal SRAM 1

Internal SRAM 1 is a 416 KB, read-and-write memory space, addressed by the CPU through the data bus or instruction bus in the same order, as shown in Table 4-1.

The total 416 KB memory space comprises multiple 8 KB and 16 KB memory (sub-memory) blocks. A memory block (up to 16 KB) can be used as a Trace Memory, in which case this block can still be accessed by the CPU.

5. Internal SRAM 2

Internal SRAM 2 is a 64 KB, read-and-write memory space, addressed by the CPU through the data bus, as shown in Table 4-1.

A 32 KB or the total 64 KB can be configured as data cache (DCache) to cache data of the external memory. The space used as DCache cannot be accessed by the CPU, while the remaining space can still be accessed by the CPU.

6. RTC FAST Memory

RTC FAST Memory is a 8 KB, read-and-write SRAM, addressed by the CPU through the data/instruction bus via the shared address 0x600F_E000 ~ 0x600F_FFFF, as described in Table 4-1.

7. RTC SLOW Memory

RTC SLOW Memory is a 8 KB, read-and-write SRAM, addressed by the CPU through the data/instruction bus via shared address 0x5000_E000 ~ 0x5001_FFFF, as described in Table 4-1.

RTC SLOW Memory can also be used as a peripheral addressable to the CPU via 0x6002_1000 ~ 0x6002_2FFF.

4.3.3 External Memory

ESP32-S3 supports SPI, Dual SPI, Quad SPI, Octal SPI, QPI, and OPI interfaces that allow connection to external flash and RAM. It also supports hardware encryption and decryption based on XTS_AES algorithm to protect users' programs and data in the external flash and RAM.

4.3.3.1 External Memory Address Mapping

The CPU accesses the external memory via the cache. According to information inside the MMU (Memory Management Unit), the cache maps the CPU's instruction/data bus address into a physical address of the external flash and RAM. Due to this address mapping, ESP32-S3 can address up to 1 GB external flash and 1 GB external RAM.

Using the cache, ESP32-S3 is able to support the following address space mappings at a time:

- Up to 32 MB instruction bus address space can be mapped to the external flash or RAM as individual 64 KB blocks via the ICache. 4-byte aligned reads and fetches are supported.
- Up to 32 MB data bus address space can be mapped to the external RAM as individual 64 KB blocks via the DCache. Single-byte, double-byte, 4-byte, 16-byte aligned reads and writes are supported. This address space can also be mapped to the external flash or RAM for read operations only.

Table 4-2 lists the mapping between the cache and the corresponding address ranges on the data bus and instruction bus.

Table 4-2. External Memory Address Mapping

Bus Type	Boundary Address		Size (MB)	Target
	Low Address	High Address		
Data bus	0x3C00_0000	0x3DFF_FFFF	32	DCache
Instruction bus	0x4200_0000	0x43FF_FFFF	32	ICache

Note:

Only if the CPU obtains permission for accessing the external memory, can it be responded for memory access. For more detailed information about permission control, please refer to Chapter 15 *Permission Control (PMS)*.

4.3.3.2 Cache

As shown in Figure 4-2, ESP32-S3 has a dual-core-shared ICache and DCache structure, which allows prompt response upon simultaneous requests from the instruction bus and data bus. Some internal memory space can be used as cache (see Internal SRAM 0 and Internal SRAM 2 in Section 4.3.2).

When the instruction bus of two cores initiate a request on ICache simultaneously, the arbiter determines which core gets the access to the ICache first; when the data bus of two cores initiate a request on DCache simultaneously, the arbiter determines which gets the access to the DCache first. When a cache miss occurs, the cache controller will initiate a request to the external memory. When ICache and DCache initiate requests on the

external memory simultaneously, the arbiter determines which gets the access to the external memory first. The size of ICache can be configured to 16 KB or 32 KB, while its block size can be configured to 16 B or 32 B. When an ICache is configured to 32 KB, its block cannot be 16 B. The size of DCache can be configured to 32 KB or 64 KB, while its block size can be configured to 16 B, 32 B or 64 B. When a DCache is configured to 64 KB, its block cannot be 16 B.

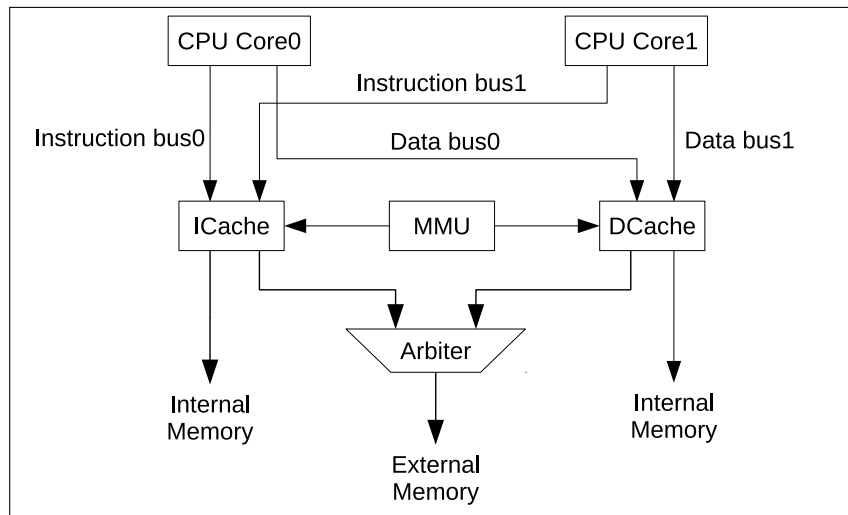

Figure 4-2. Cache Structure

4.3.3.3 Cache Operations

ESP32-S3 caches support the following operations:

1. **Write-Back:** This operation is used to clear the dirty bits in dirty blocks and update the new data to the external memory. After the write-back operation finished, both the external memory and the cache are bearing the new data. The CPU can then read/write the data directly from the cache. Only DCache has this function.

If the data in the cache is newer than the one stored in the external memory, then the new data will be considered as a dirty block. The cache tracks these dirty blocks through their dirty bits. When the dirty bits of a data are cleared, the cache will consider the data as new.

2. **Clean:** This operation is used to clear dirty bits in the dirty block, without updating data to the external memory. After the clean operation finish, there will still be old data stored in the external memory, while the cache keeps the new one (but the cache does not know about this). The CPU can then read/write the data directly from the cache. Only DCache has this function.
3. **Invalidate:** This operation is used to remove valid data in the cache. Even if the data is a dirty block mentioned above, it will not be updated to the external memory. But for the non-dirty data, it will be only stored in the external memory after this operation. The CPU needs to access the external memory in order to read/write this data. As for the dirty blocks, they will be totally lost with only old data in the external memory after this operation. There are two types of invalidate operation: automatic invalidation (Auto-Invalidate) and manual invalidation (Manual-Invalidate). Manual-Invalidate is performed only on data in the specified area in the cache, while Auto-Invalidate is performed on all data in the cache. Both ICache and DCache have this function.
4. **Preload:** This operation is to load instructions and data into the cache in advance. The minimum unit of

preload-operation is one block. There are two types of preload-operation: manual preload (Manual-Preload) and automatic preload (Auto-Preload). Manual-Preload means that the hardware prefetches a piece of continuous data according to the virtual address specified by the software. Auto-Preload means the hardware prefetches a piece of continuous data according to the current address where the cache hits or misses (depending on configuration). Both ICache and DCache have this function.

5. **Lock/Unlock:** The lock operation is used to prevent the data in the cache from being easily replaced. There are two types of lock: prelock and manual lock. When prelock is enabled, the cache locks the data in the specified area when filling the missing data to cache memory, while the data outside the specified area will not be locked. When manual lock is enabled, the cache checks the data that is already in the cache memory and locks the data only if it falls in the specified area, and leaves the data outside the specified area unlocked. When there are missing data, the cache will replace the data in the unlocked way first, so the data in the locked way is always stored in the cache and will not be replaced. But when all ways within the cache are locked, the cache will replace data, as if it was not locked. Unlocking is the reverse of locking, except that it only can be done manually. Both ICache and DCache have this function.

Please note that the writing-back, cleaning and Manual-Invalidate operations will only work on the unlocked data. If you expect to perform such operations on the locked data, please unlock them first.

4.3.4 GDMA Address Space

The GDMA (General Direct Memory Access) peripheral in ESP32-S3 can provide DMA (Direct Memory Access) services including:

- Data transfers between different locations of internal memory;
- Data transfers between internal memory and external memory;
- Data transfers between different locations of external memory.

GDMA uses the same addresses as the CPU's data bus to access Internal SRAM 1 and Internal SRAM 2. Specifically, GDMA uses address range 0x3FC8_8000 ~ 0x3FCE_FFFF to access Internal SRAM 1 and 0x3FCF_0000 ~ 0x3FCF_FFFF to access Internal SRAM 2. Note that GDMA cannot access the internal memory occupied by cache.

In addition, GDMA can access the external memory (only RAM) via the same address as CPU accessing DCache (0x3C00_0000 ~ 0x3DFF_FFFF). When DCache and GDMA access the external memory simultaneously, the software needs to make sure the data is consistent.

Besides, some peripherals/modules of the ESP32-S3 can work together with GDMA. In these cases, GDMA can provide the following powerful services for them:

- Data transfers between modules/peripherals and internal memory;
- Data transfers between modules/peripherals and external memory.

There are 11 peripherals/modules that can work together with GDMA. As shown in Figure 4-3, these 11 vertical lines in turn correspond to these 11 peripherals/modules with GDMA function, the horizontal line represents a certain channel of GDMA (can be any channel), and the intersection of the vertical line and the horizontal line indicates that a peripheral/module has the ability to access the corresponding channel of GDMA. If there are multiple intersections on the same line, it means that these peripherals/modules cannot enable the GDMA function at the same time.

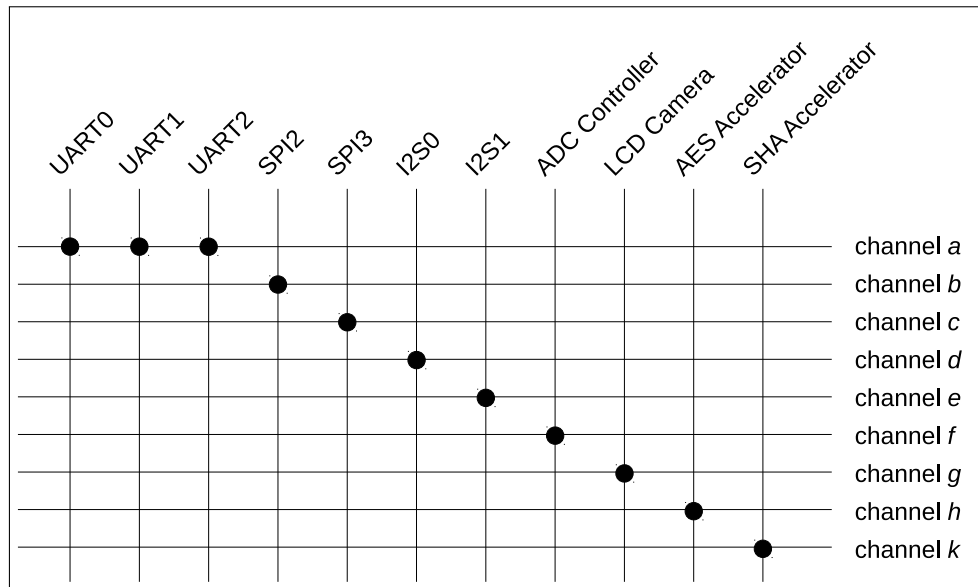

Figure 4-3. Peripherals/modules that can work with GDMA

These peripherals/modules can access any memory available to GDMA. For more information, please refer to Chapter 3 *GDMA Controller (GDMA)*.

Note:

When accessing a memory via GDMA, a corresponding access permission is needed, otherwise this access may fail. For more information about permission control, please refer to Chapter 15 *Permission Control (PMS)*.

4.3.5 Modules/Peripherals

The CPU can access modules/peripherals via 0x6000_0000 ~ 0x600D_0FFF shared by the data/instruction bus.

4.3.5.1 Module/Peripheral Address Mapping

Table 4-3 lists all the modules/peripherals and their respective address ranges. Note that the address space of specific modules/peripherals is defined by "Boundary Address" (including both Low Address and High Address).

Table 4-3. Module/Peripheral Address Mapping

Target	Boundary Address		Size (KB)	Notes
	Low Address	High Address		
UART Controller 0	0x6000_0000	0x6000_0FFF	4	
Reserved	0x6000_1000	0x6000_1FFF		
SPI Controller 1	0x6000_2000	0x6000_2FFF	4	
SPI Controller 0	0x6000_3000	0x6000_3FFF	4	
GPIO	0x6000_4000	0x6000_4FFF	4	
Reserved	0x6000_5000	0x6000_6FFF		

Cont'd on next page

Table 4-3 – cont'd from previous page

Target	Boundary Address		Size (KB)	Notes
	Low Address	High Address		
eFuse Controller	0x6000_7000	0x6000_7FFF	4	
Low-Power Management	0x6000_8000	0x6000_8FFF	4	
IO MUX	0x6000_9000	0x6000_9FFF	4	
Reserved	0x6000_A000	0x6000_EFFF		
I2S Controller 0	0x6000_F000	0x6000_FFFF	4	
UART Controller 1	0x6001_0000	0x6001_0FFF	4	
Reserved	0x6001_1000	0x6001_2FFF		
I2C Controller 0	0x6001_3000	0x6001_3FFF	4	
UHCI0	0x6001_4000	0x6001_4FFF	4	
Reserved	0x6001_5000	0x6001_5FFF		
Remote Control Peripheral	0x6001_6000	0x6001_6FFF	4	
Pulse Count Controller	0x6001_7000	0x6001_7FFF	4	
Reserved	0x6001_8000	0x6001_8FFF		
LED PWM Controller	0x6001_9000	0x6001_9FFF	4	
Reserved	0x6001_A000	0x6001_DFFF		
Motor Control PWM 0	0x6001_E000	0x6001_EFFF	4	
Timer Group 0	0x6001_F000	0x6001_FFFF	4	
Timer Group 1	0x6002_0000	0x6002_0FFF	4	
RTC SLOW Memory	0x6002_1000	0x6002_2FFF	8	
System Timer	0x6002_3000	0x6002_3FFF	4	
SPI Controller 2	0x6002_4000	0x6002_4FFF	4	
SPI Controller 3	0x6002_5000	0x6002_5FFF	4	
APB Controller	0x6002_6000	0x6002_6FFF	4	
I2C Controller 1	0x6002_7000	0x6002_7FFF	4	
SD/MMC Host Controller	0x6002_8000	0x6002_8FFF	4	
Reserved	0x6002_9000	0x6002_AFFF		
Two-wire Automotive Interface	0x6002_B000	0x6002_BFFF	4	
Motor Control PWM 1	0x6002_C000	0x6002_CFFF	4	
I2S Controller 1	0x6002_D000	0x6002_DFFF	4	
UART controller 2	0x6002_E000	0x6002_EFFF	4	
Reserved	0x6002_F000	0x6003_7FFF		
USB Serial/JTAG Controller	0x6003_8000	0x6003_8FFF	4	
USB External Control registers	0x6003_9000	0x6003_9FFF	4	1
AES Accelerator	0x6003_A000	0x6003_AFFF	4	
SHA Accelerator	0x6003_B000	0x6003_BFFF	4	
RSA Accelerator	0x6003_C000	0x6003_CFFF	4	
Digital Signature	0x6003_D000	0x6003_DFFF	4	
HMAC Accelerator	0x6003_E000	0x6003_EFFF	4	
GDMA Controller	0x6003_F000	0x6003_FFFF	4	
ADC Controller	0x6004_0000	0x6004_0FFF	4	
Camera-LCD Controller	0x6004_1000	0x6004_1FFF	4	

Cont'd on next page

Table 4-3 – cont'd from previous page

Target	Boundary Address		Size (KB)	Notes
	Low Address	High Address		
Reserved	0x6004_2000	0x6007_FFFF		
USB core registers	0x6008_0000	0x600B_FFFF	256	1
System Registers	0x600C_0000	0x600C_0FFF	4	
Sensitive Register	0x600C_1000	0x600C_1FFF	4	
Interrupt Matrix	0x600C_2000	0x600C_2FFF	4	
Reserved	0x600C_3000	0x600C_3FFF		
Configure Cache	0x600C_4000	0x600C_BFFF	32	
External Memory Encryption and Decryption	0x600C_C000	0x600C_CFFF	4	
Reserved	0x600C_D000	0x600C_DFFF		
Debug Assist	0x600C_E000	0x600C_EFFF	4	
Reserved	0x600C_F000	0x600C_FFFF		
World Controller	0x600D_0000	0x600D_0FFF	4	

Note:

1. The address space in this module/peripheral is not continuous.
2. The CPU needs to obtain the access permission to a certain module/peripheral when initiating a request to access it, otherwise it may fail. For more information of permission control, please see Chapter 15 [Permission Control \(PMS\)](#).

5 eFuse Controller

5.1 Overview

The ESP32-S3 contains a 4-Kbit eFuse to store parameters. These parameters are burned and read by an eFuse Controller. Once an eFuse bit is programmed to 1, it can never be reverted to 0. The eFuse controller programs individual bits of parameters in eFuse according to users configurations. Some of these parameters can be read by users using the eFuse controller. If read-protection for some data is not enabled, that data is readable from outside the chip. If read-protection is enabled, that data can not be read from outside the chip. In all cases, however, some keys stored in eFuse can still be used internally by hardware cryptography modules such as Digital Signature, HMAC, etc., without exposing this data to the outside world.

5.2 Features

- 4-Kbit in total, with 1792 bits available for users
- One-time programmable storage
- Configurable write protection
- Configurable read protection
- Various hardware encoding schemes protect against data corruption

5.3 Functional Description

5.3.1 Structure

The eFuse data is organized in 11 blocks (BLOCK0 ~ BLOCK10). BLOCK0 has 640 bits in total. BLOCK1 has 288 bits and each block of BLOCK2 ~ 10 has 352 bits.

BLOCK0, which holds most parameters, has 25 bits that are readable but useless to users (the details are showed in Section 5.3.2), and 29 further bits are reserved for future use.

Table 5-1 lists all the parameters in BLOCK0 and their offsets, bit widths, as well as information on whether they can be used by hardware, which bits are write-protected, and corresponding descriptions.

The [EFUSE_WR_DIS](#) parameter is used to disable the writing of other parameters, while [EFUSE_RD_DIS](#) is used to disable users from reading BLOCK4 ~ BLOCK10. For more information on these two parameters, please see Section 5.3.1.1 and Section 5.3.1.2.

Table 5-1. Parameters in eFuse BLOCK0

Parameters	Bit Width	Accessible by Hardware	Programming-Protection by EFUSE_WR_DIS Bit Number	Description
EFUSE_WR_DIS	32	Y	N/A	Represents whether writing of individual eFuses is disabled.
EFUSE_RD_DIS	7	Y	0	Represents whether users' reading from BLOCK4 ~ 10 is disabled.
EFUSE_DIS_ICACHE	1	Y	2	Represents whether iCache is disabled.
EFUSE_DIS_DCACHE	1	Y	2	Represents whether dCache is disabled.
EFUSE_DIS_DOWNLOAD_ICACHE	1	Y	2	Represents whether iCache is disabled in Download mode.
EFUSE_DIS_DOWNLOAD_DCACHE	1	Y	2	Represents whether dCache is disabled in Download mode.
EFUSE_DIS_FORCE_DOWNLOAD	1	Y	2	Represents whether the function that forces chip into download mode is disabled.
EFUSE_DIS_USB_OTG	1	Y	2	Represents whether USB OTG function is disabled.
EFUSE_DIS_TWAI	1	Y	2	Represents whether TWAI Controller is disable.
EFUSE_DIS_APP_CPU	1	Y	2	Represents whether app CPU is disable.
EFUSE_SOFT_DIS_JTAG	3	Y	31	Represents whether JTAG with soft-disable is disabled.
EFUSE_DIS_PAD_JTAG	1	Y	2	Represents whether pad JTAG is permanently disabled.
EFUSE_DIS_DOWNLOAD_MANUAL_ENCRYPT	1	Y	2	Represents whether flash encryption is disabled in Download boot modes.
EFUSE_USB_EXCHG_PINS	1	Y	30	Represents whether USB D+ and D- pins are swapped.
EFUSE_EXT_PHY_ENABLE	1	N	30	Represents whether external USB PHY is disabled.
EFUSE_VDD_SPI_XPD	1	Y	3	Represents whether Flash Voltage Regulator is powered up.
EFUSE_VDD_SPI_TIEH	1	Y	3	Represents whether Flash Voltage Regulator output is short connected to VDD3P3_RTC_IO.
EFUSE_VDD_SPI_FORCE	1	Y	3	Represents whether to force using EFUSE_VDD_SPI_XPD and EFUSE_VDD_SPI_TIEH to configure flash voltage LDO.
EFUSE_WDT_DELAY_SEL	2	Y	3	Represents RTC watchdog timeout threshold.
EFUSE_SPI_BOOT_CRYPT_CNT	3	Y	4	Represents whether SPI boot encrypt/decrypt is disabled.

Cont'd on next page

Table 5-1 – cont'd from previous page

Parameters	Bit Width	Accessible by Hardware	Programming-Protection by EFUSE_WR_DIS Bit Number	Description
EFUSE_SECURE_BOOT_KEY_REVOKE0	1	N	5	Represents whether the first secure boot key is revoked.
EFUSE_SECURE_BOOT_KEY_REVOKE1	1	N	6	Represents whether the second secure boot key is revoked.
EFUSE_SECURE_BOOT_KEY_REVOKE2	1	N	7	Represents whether the third secure boot key is revoked.
EFUSE_KEY_PURPOSE_0	4	Y	8	Represents Key0 purpose, see Table 5-2.
EFUSE_KEY_PURPOSE_1	4	Y	9	Represents Key1 purpose, see Table 5-2.
EFUSE_KEY_PURPOSE_2	4	Y	10	Represents Key2 purpose, see Table 5-2.
EFUSE_KEY_PURPOSE_3	4	Y	11	Represents Key3 purpose, see Table 5-2.
EFUSE_KEY_PURPOSE_4	4	Y	12	Represents Key4 purpose, see Table 5-2.
EFUSE_KEY_PURPOSE_5	4	Y	13	Represents Key5 purpose, see Table 5-2.
EFUSE_SECURE_BOOT_EN	1	N	15	Represents whether secure boot is enabled.
EFUSE_SECURE_BOOT_AGGRESSIVE_REVOKE	1	N	16	Represents whether aggressive revoke of secure boot keys is enabled.
EFUSE_DIS_USB_JTAG	1	Y	2	Represents whether the function of usb_serial_jtag that switch usb to jtag is disabled.
EFUSE_DIS_USB_SERIAL_JTAG	1	Y	2	Represents whether usb_serial_jtag function is disabled.
EFUSE_STRAP_JTAG_SEL	1	Y	2	Represents whether to enable selection between usb_to_jtag or pad_to_jtag through GPIO3. 0: pad_to_jtag; 1: usb_to_jtag.
EFUSE_USB_PHY_SEL	1	Y	2	Represents the connection relationship between internal PHY, external PHY, and USB OTG, USB Serial/JTAG.
EFUSE_FLASH_TPUW	4	N	18	Represents flash waiting time after power-up.
EFUSE_DIS_DOWNLOAD_MODE	1	N	18	Represents whether all download modes are disabled.
EFUSE_DIS_LEGACY_SPI_BOOT	1	N	18	Represents whether Legacy SPI is disabled.
EFUSE_DIS_USB_PRINT	1	N	18	Represents whether USB printing is disabled.
EFUSE_FLASH_ECC_MODE	1	N	18	Represents the flash ECC mode in ROM.

Cont'd on next page

Table 5-1 – cont'd from previous page

Parameters	Bit Width	Accessible by Hardware	Programming-Protection by EFUSE_WR_DIS Bit Number	Description
EFUSE_DIS_USB_SERIAL_JTAG_DOWNLOAD_MODE	1	N	18	Represents whether download through USB-Serial-JTAG is disabled.
EFUSE_ENABLE_SECURITY_DOWNLOAD	1	N	18	Represents whether secure UART download mode is enabled.
EFUSE_UART_PRINT_CONTROL	2	N	18	Represents the default UART boot message output mode.
EFUSE_PIN_POWER_SELECTION	1	N	18	Represents GPIO33 ~ GPIO37 power supply selection.
EFUSE_FLASH_TYPE	1	N	18	Represents the maximum data lines of SPI flash.
EFUSE_FLASH_PAGE_SIZE	2	N	18	Represents the page size of flash.
EFUSE_FLASH_ECC_EN	1	N	18	Represents whether ECC for flash boot is enabled.
EFUSE_FORCE_SEND_RESUME	1	N	18	Represents whether to force ROM code to send a resume command during SPI boot.
EFUSE_SECURE_VERSION	16	N	18	Represents IDF secure version.
EFUSE_DIS_USB_OTG_DOWNLOAD_MODE	1	N	19	Represents whether download through USB-OTG is disabled.

Table 5-2 lists all key purpose and their values. Setting the eFuse parameter EFUSE_KEY_PURPOSE_*n* declares the purpose of KEY_{*n*} (*n*: 0 ~ 5).

Table 5-2. Secure Key Purpose Values

Key Purpose Values	Purposes
0	User purposes
1	Reserved
2	XTS_AES_256_KEY_1 (flash/SRAM encryption and decryption)
3	XTS_AES_256_KEY_2 (flash/SRAM encryption and decryption)
4	XTS_AES_128_KEY (flash/SRAM encryption and decryption)
5	HMAC Downstream mode
6	JTAG in HMAC Downstream mode
7	Digital Signature peripheral in HMAC Downstream mode
8	HMAC Upstream mode
9	SECURE_BOOT_DIGEST0 (secure boot key digest)
10	SECURE_BOOT_DIGEST1 (secure boot key digest)
11	SECURE_BOOT_DIGEST2 (secure boot key digest)

Table 5-3 provides the details of parameters in BLOCK1 ~ BLOCK10.

Table 5-3. Parameters in BLOCK1 to BLOCK10

BLOCK	Parameters	Bit Width	Accessible by Hardware	Write Protection by EFUSE_WR_DIS Bit Number	Read Protection by EFUSE_RD_DIS Bit Number	Description
BLOCK1	EFUSE_MAC	48	N	20	N/A	MAC address
	EFUSE_SPI_PAD_CONFIGURE	[0:5]	N	20	N/A	CLK
		[6:11]	N	20	N/A	Q (D1)
		[12:17]	N	20	N/A	D (D0)
		[18:23]	N	20	N/A	CS
		[24:29]	N	20	N/A	HD (D3)
		[30:35]	N	20	N/A	WP (D2)
		[36:41]	N	20	N/A	DQS
		[42:47]	N	20	N/A	D4
		[48:53]	N	20	N/A	D5
	[54:59]	N	20	N/A	D6	
	[60:65]	N	20	N/A	D7	
	EFUSE_WAFER_VERSION	[0:2]	N	20	N/A	System data
EFUSE_PKG_VERSION	[0:2]	N	20	N/A	System data	
EFUSE_SYS_DATA_PART0	72	N	20	N/A	System data	
BLOCK2	EFUSE_OPTIONAL_UNIQUE_ID	128	N	20	N/A	System data
	EFUSE_SYS_DATA_PART1	128	N	21	N/A	System data
BLOCK2	EFUSE_SYS_DATA_PART1	256	N	21	N/A	System data
BLOCK3	EFUSE_USR_DATA	256	N	22	N/A	User data
BLOCK4	EFUSE_KEY0_DATA	256	Y	23	0	KEY0 or user data
BLOCK5	EFUSE_KEY1_DATA	256	Y	24	1	KEY1 or user data
BLOCK6	EFUSE_KEY2_DATA	256	Y	25	2	KEY2 or user data
BLOCK7	EFUSE_KEY3_DATA	256	Y	26	3	KEY3 or user data
BLOCK8	EFUSE_KEY4_DATA	256	Y	27	4	KEY4 or user data
BLOCK9	EFUSE_KEY5_DATA	256	Y	28	5	KEY5 or user data

Cont'd on next page

Table 5-3 – cont'd from previous page

BLOCK	Parameters	Bit Width	Accessible by Hardware	Write Protection by EFUSE_WR_DIS Bit Number	Read Protection by EFUSE_RD_DIS Bit Number	Description
BLOCK10	EFUSE_SYS_DATA_PART2	256	N	29	6	System data

Among these blocks, BLOCK4 ~ 9 store KEY0 ~ 5, respectively. Up to six 256-bit keys can be written into eFuse. Whenever a key is written, its purpose value should also be written (see table 5-2). For example, when a key for the JTAG function in HMAC Downstream mode is written to KEY3 (i.e., BLOCK7), its key purpose value 6 should also be written to EFUSE_KEY_PURPOSE_3.

BLOCK1 ~ BLOCK10 use the RS coding scheme, so there are some restrictions on writing to these parameters. For more detailed information, please refer to Section 5.3.1.3 and 5.3.2.

5.3.1.1 EFUSE_WR_DIS

Parameter EFUSE_WR_DIS determines whether individual eFuse parameters are write-protected. After EFUSE_WR_DIS has been programmed, execute an eFuse read operation to let the new values take effect (see Section 5.3.3).

Column “Write Protection by EFUSE_WR_DIS Bit Number” in Table 5-1 and Table 5-3 list the specific bits in EFUSE_WR_DIS that disable writing.

When the write protection bit of a parameter is set to 0, it means that this parameter is not write-protected and can be programmed.

Setting the write protection bit of a parameter to 1 enables write-protection for it and none of its bits can be modified afterwards. Non-programmed bits always remain 0 while programmed bits always remain 1.

5.3.1.2 EFUSE_RD_DIS

Only the eFuse blocks BLOCK4 ~ BLOCK10 can be individually read protected to prevent any access from outside the chip, as shown in column “Read Protection by EFUSE_RD_DIS Bit Number” of Table 5-3. After EFUSE_RD_DIS has been programmed, execute an eFuse read operation to let the new values take effect (see Section 5.3.3).

If a bit in EFUSE_RD_DIS is 0, then the eFuse block can be read by users; if a bit in EFUSE_RD_DIS is 1, then the parameter controlled by this bit is user read protected.

Other parameters that are not in BLOCK4 ~ BLOCK10 can always be read by users.

When BLOCK4 ~ BLOCK10 are set to be read-protected, the data in these blocks are not readable by users, but they can still be used internally by hardware cryptography modules, if the EFUSE_KEY_PURPOSE_*n* bit is set accordingly.

5.3.1.3 Data Storage

According to the different types of eFuse bits, eFuse controller use two hardware encoding schemes to protect eFuse bits from corruption.

All BLOCK0 parameters except for EFUSE_WR_DIS are stored with four backups, meaning each bit is stored four times. This scheme is transparent to the user. This encoding scheme is invisible for users.

BLOCK1 ~ BLOCK10 store key data and some parameters and use RS (44, 32) coding scheme that supports up to 6 bytes of automatic error correction. The primitive polynomial of RS (44, 32) is

$$p(x) = x^8 + x^4 + x^3 + x^2 + 1.$$

The shift register circuit shown in Figure 5-1 and 5-2 processes 32 data bytes using RS (44, 32). This coding scheme encodes 32 bytes of data into 44 bytes:

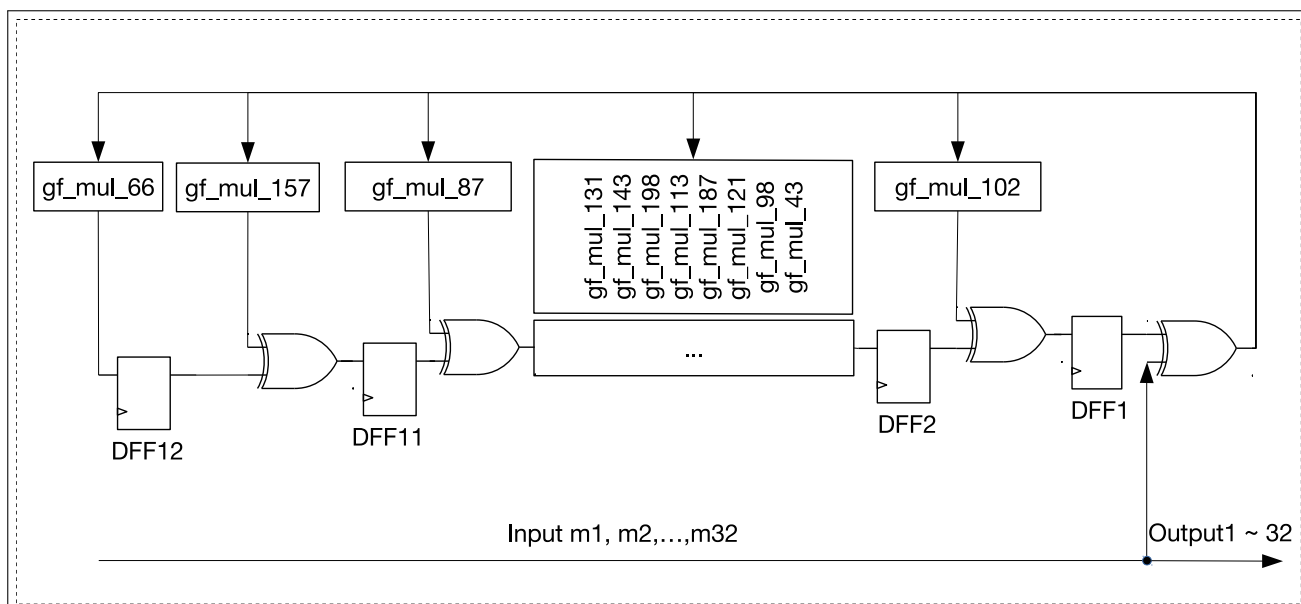

Figure 5-1. Shift Register Circuit (output of first 32 bytes)

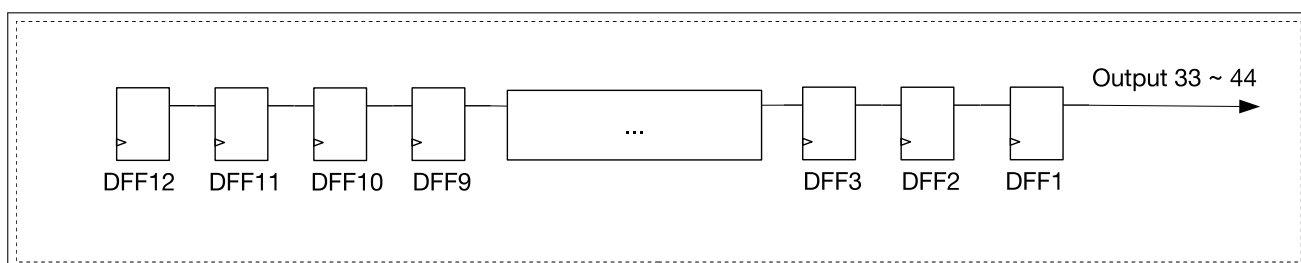

Figure 5-2. Shift Register Circuit (output of last 12 bytes)

- Bytes [0:31] are the data bytes itself
- Bytes [32:43] are the encoded parity bytes stored in 8-bit flip-flops DFF1, DFF2, ..., DFF12 (gf_mul_n, where n is an integer, is the result of multiplying a byte of data ...)

After that, the hardware burns into eFuse the 44-byte codeword consisting of the data bytes followed by the parity bytes.

When the eFuse block is read back, the eFuse controller automatically decodes the codeword and applies error correction if needed.

Because the RS check codes are generated on the entire 256-bit eFuse block, each block can only be written once.

5.3.2 Programming of Parameters

The eFuse controller can only program eFuse parameters of one block at a time. BLOCK0 ~ BLOCK10 share the same address range to store the parameters to be programmed. Configure parameter [EFUSE_BLK_NUM](#) to indicate which block should be programmed.

Before programming, make sure the eFuse programming voltage VDDQ is configured correctly as described in Section [5.3.4](#).

Programming BLOCK0

When [EFUSE_BLK_NUM](#) is set to 0, BLOCK0 will be programmed. Register [EFUSE_PGM_DATA0_REG](#) stores [EFUSE_WR_DIS](#). Registers [EFUSE_PGM_DATA1_REG](#) ~ [EFUSE_PGM_DATA5_REG](#) store the information of parameters to be programmed. Note that 25 bits are readable but useless to users and must always be set to 0 in the programming registers. The specific bits are:

- [EFUSE_PGM_DATA1_REG](#)[27:31]
- [EFUSE_PGM_DATA1_REG](#)[21:24]
- [EFUSE_PGM_DATA2_REG](#)[7:15]
- [EFUSE_PGM_DATA2_REG](#)[0:3]
- [EFUSE_PGM_DATA3_REG](#)[26:27]
- [EFUSE_PGM_DATA4_REG](#)[30]

Data in registers [EFUSE_PGM_DATA6_REG](#) ~ [EFUSE_PGM_DATA7_REG](#) and [EFUSE_PGM_CHECK_VALUE0_REG](#) ~ [EFUSE_PGM_CHECK_VALUE2_REG](#) are ignored when programming BLOCK0.

Programming BLOCK1

When [EFUSE_BLK_NUM](#) is set to 1, registers [EFUSE_PGM_DATA0_REG](#) ~ [EFUSE_PGM_DATA5_REG](#) store the BLOCK1 parameters to be programmed. Registers [EFUSE_PGM_CHECK_VALUE0_REG](#) ~ [EFUSE_PGM_CHECK_VALUE2_REG](#) store the corresponding RS check codes. Data in registers [EFUSE_PGM_DATA6_REG](#) ~ [EFUSE_PGM_DATA7_REG](#) is ignored when programming BLOCK1, and the RS check codes will be calculated with these bits all treated as 0.

Programming BLOCK2 ~ 10

When [EFUSE_BLK_NUM](#) is set to 2 ~ 10, registers [EFUSE_PGM_DATA0_REG](#) ~ [EFUSE_PGM_DATA7_REG](#) store the parameters to be programmed to this block. Registers [EFUSE_PGM_CHECK_VALUE0_REG](#) ~ [EFUSE_PGM_CHECK_VALUE2_REG](#) store the corresponding RS check codes.

Programming process

The process of programming parameters is as follows:

1. Write the block number to [EFUSE_BLK_NUM](#) to determine the block to be programmed.
2. Write parameters to be programmed to registers [EFUSE_PGM_DATA0_REG](#) ~ [EFUSE_PGM_DATA7_REG](#) and the corresponding checksum values to [EFUSE_PGM_CHECK_VALUE0_REG](#) ~ [EFUSE_PGM_CHECK_VALUE2_REG](#).
3. Configure the field [EFUSE_OP_CODE](#) of register [EFUSE_CONF_REG](#) to 0x5A5A.
4. Configure the field [EFUSE_PGM_CMD](#) of register [EFUSE_CMD_REG](#) to 1.
5. Poll register [EFUSE_CMD_REG](#) until it is 0x0, or wait for a PGM_DONE interrupt. For more information on how to identify a PGM_DONE interrupt, please see the end of Section 5.3.3.
6. In order to avoid programming content leakage, please clear the parameters in [EFUSE_PGM_DATA0_REG](#) ~ [EFUSE_PGM_DATA7_REG](#) and [EFUSE_PGM_CHECK_VALUE0_REG](#) ~ [EFUSE_PGM_CHECK_VALUE2_REG](#).
7. Trigger an eFuse read operation (see Section 5.3.3) to update eFuse registers with the new values.

8. Check error record registers. If the values read in error record registers are not 0, the programming process should be performed again following above steps 1 ~ 7. Please check the following error record registers for different eFuse blocks:

- BLOCK0: [EFUSE_RD_REPEAT_ERR0_REG](#) ~ [EFUSE_RD_REPEAT_ERR4_REG](#)
- BLOCK1: [EFUSE_RD_RS_ERR0_REG](#)[2:0], [EFUSE_RD_RS_ERR0_REG](#)[7]
- BLOCK2: [EFUSE_RD_RS_ERR0_REG](#)[6:4], [EFUSE_RD_RS_ERR0_REG](#)[11]
- BLOCK3: [EFUSE_RD_RS_ERR0_REG](#)[10:8], [EFUSE_RD_RS_ERR0_REG](#)[15]
- BLOCK4: [EFUSE_RD_RS_ERR0_REG](#)[14:12], [EFUSE_RD_RS_ERR0_REG](#)[19]
- BLOCK5: [EFUSE_RD_RS_ERR0_REG](#)[18:16], [EFUSE_RD_RS_ERR0_REG](#)[23]
- BLOCK6: [EFUSE_RD_RS_ERR0_REG](#)[22:20], [EFUSE_RD_RS_ERR0_REG](#)[27]
- BLOCK7: [EFUSE_RD_RS_ERR0_REG](#)[26:24], [EFUSE_RD_RS_ERR0_REG](#)[31]
- BLOCK8: [EFUSE_RD_RS_ERR0_REG](#)[30:28], [EFUSE_RD_RS_ERR1_REG](#)[3]
- BLOCK9: [EFUSE_RD_RS_ERR1_REG](#)[2:0], [EFUSE_RD_RS_ERR1_REG](#)[2:0][7]
- BLOCK10: [EFUSE_RD_RS_ERR1_REG](#)[2:0][6:4]

Limitations

In BLOCK0, each bit can be programmed separately. However, we recommend to minimize programming cycles and program all the bits of a parameter in one programming action. In addition, after all parameters controlled by a certain bit of [EFUSE_WR_DIS](#) are programmed, that bit should be immediately programmed. The programming of parameters controlled by a certain bit of [EFUSE_WR_DIS](#), and the programming of the bit itself can even be completed at the same time. Repeated programming of already programmed bits is strictly forbidden, otherwise, programming errors will occur.

BLOCK1 cannot be programmed by users as it has been programmed at manufacturing.

BLOCK2 ~ 10 can only be programmed once. Repeated programming is not allowed.

5.3.3 User Read of Parameters

Users cannot read eFuse bits directly. The eFuse Controller hardware reads all eFuse bits and stores the results to their corresponding registers in its memory space. Then, users can read eFuse bits by reading the registers that start with [EFUSE_RD_](#). Details are provided in Table 5-4.

Table 5-4. Registers Information

BLOCK	Read Registers	Registers When Programming This Block
0	EFUSE_RD_WR_DIS_REG	EFUSE_PGM_DATA0_REG
0	EFUSE_RD_REPEAT_DATA0 ~ 4_REG	EFUSE_PGM_DATA1 ~ 5_REG
1	EFUSE_RD_MAC_SPI_SYS_0 ~ 5_REG	EFUSE_PGM_DATA0 ~ 5_REG
2	EFUSE_RD_SYS_PART1_0 ~ 7_REG	EFUSE_PGM_DATA0 ~ 7_REG
3	EFUSE_RD_USR_DATA0 ~ 7_REG	EFUSE_PGM_DATA0 ~ 7_REG
4 ~ 9	EFUSE_RD_KEY_n_DATA0 ~ 7_REG (<i>n</i> : 0 ~ 5)	EFUSE_PGM_DATA0 ~ 7_REG
10	EFUSE_RD_SYS_PART2_0 ~ 7_REG	EFUSE_PGM_DATA0 ~ 7_REG

Updating eFuse read registers

The eFuse Controller reads internal eFuses to update corresponding registers. This read operation happens on system reset and can also be triggered manually by users as needed (e.g., if new eFuse values have been programmed). The process of triggering a read operation by users is as follows:

1. Configure the field [EFUSE_OP_CODE](#) in register [EFUSE_CONF_REG](#) to 0x5AA5.
2. Configure the field [EFUSE_READ_CMD](#) in register [EFUSE_CMD_REG](#) to 1.
3. Poll register [EFUSE_CMD_REG](#) until it is 0x0, or wait for a READ_DONE interrupt. Information on how to identify a READ_DONE interrupt is provided below in this section.
4. users reads the values of each parameter from memory.

The eFuse read registers will hold all values until the next read operation.

Error detection

Error record registers allow users to detect if there are any inconsistencies in the stored backup eFuse parameters.

Registers [EFUSE_RD_REPEAT_ERR0 ~ 3_REG](#) indicate if there are any errors of programmed parameters (except for [EFUSE_WR_DIS](#)) in BLOCK0 (value 1 indicates an error is detected, and the bit becomes invalid; value 0 indicates no error).

Registers [EFUSE_RD_RS_ERR0 ~ 1_REG](#) store the number of corrected bytes as well as the result of RS decoding during eFuse reading BLOCK1 ~ BLOCK10.

The values of above registers will be updated every time after the eFuse read registers have been updated.

Identifying the completion of a program/read operation

The methods to identify the completion of a program/read operation are described below. Please note that bit 1 corresponds to a program operation, and bit 0 corresponds to a read operation.

- Method one:
 1. Poll bit 1/0 in register [EFUSE_INT_RAW_REG](#) until it becomes 1, which represents the completion of a program/read operation.
- Method two:
 1. Set bit 1/0 in register [EFUSE_INT_ENA_REG](#) to 1 to enable the eFuse Controller to post a PGM_DONE or READ_DONE interrupt.
 2. Configure the Interrupt Matrix to enable the CPU to respond to eFuse interrupt signals, see [Chapter 9 Interrupt Matrix \(INTERRUPT\)](#).
 3. Wait for the PGM/READ_DONE interrupt.
 4. Set bit 1/0 in register [EFUSE_INT_CLR_REG](#) to 1 to clear the PGM/READ_DONE interrupt.

Note

When eFuse controller updating its registers, it will use [EFUSE_PGM_DATA_n_REG](#) (n=0 1 ..,7) again to store data. So please do not write important data into these registers before this updating process initiated.

During the chip boot process, eFuse controller will update eFuse data into registers which can be accessed by users automatically. You can get programmed eFuse data by reading corresponding registers. Thus, it is no need to update eFuse read registers in such case.

5.3.4 eFuse VDDQ Timing

The eFuse Controller operates with 20 MHz, one cycle is 50 ns, and its programming voltage VDDQ should be configured as follows:

- [EFUSE_DAC_NUM](#) (store the rising period of VDDQ): The default value of VDDQ is 2.5 V and the voltage increases by 0.01 V in each clock cycle. Thus, the default value of this parameter is 255;
- [EFUSE_DAC_CLK_DIV](#) (the clock divisor of VDDQ): The clock period to program VDDQ should be larger than 1 μ s;
- [EFUSE_PWR_ON_NUM](#) (the power-up time for VDDQ): The programming voltage should be stabilized after this time, which means the value of this parameter should be configured to exceed the value of [EFUSE_DAC_CLK_DIV](#) multiply by [EFUSE_DAC_NUM](#);
- [EFUSE_PWR_OFF_NUM](#) (the power-out time for VDDQ): The value of this parameter should be larger than 10 μ s.

Table 5-5. Configuration of Default VDDQ Timing Parameters

EFUSE_DAC_NUM	EFUSE_DAC_CLK_DIV	EFUSE_PWR_ON_NUM	EFUSE_PWR_OFF_NUM
0xFF	0x28	0x3000	0x190

5.3.5 The Use of Parameters by Hardware Modules

Some hardware modules are directly connected to the eFuse peripheral in order to use the parameters listed in Table 5-1 and Table 5-3, specifically those marked with “Y” in columns “Accessible by Hardware”. Users cannot intervene in this process.

5.3.6 Interrupts

- PGM_DONE interrupt: Triggered when eFuse programming has finished. Set [EFUSE_PGM_DONE_INT_ENA](#) to enable this interrupt;
- READ_DONE interrupt: Triggered when eFuse reading has finished. Set [EFUSE_READ_DONE_INT_ENA](#) to enable this interrupt.

5.4 Register Summary

The addresses in this section are relative to eFuse Controller base address provided in Table 4-3 in Chapter 4 *System and Memory*.

The abbreviations given in Column **Access** are explained in Section [Access Types for Registers](#).

07

Name	Description	Address	Access
PGM Data Register			
EFUSE_PGM_DATA0_REG	Register 0 that stores data to be programmed	0x0000	R/W
EFUSE_PGM_DATA1_REG	Register 1 that stores data to be programmed	0x0004	R/W
EFUSE_PGM_DATA2_REG	Register 2 that stores data to be programmed	0x0008	R/W
EFUSE_PGM_DATA3_REG	Register 3 that stores data to be programmed	0x000C	R/W
EFUSE_PGM_DATA4_REG	Register 4 that stores data to be programmed	0x0010	R/W
EFUSE_PGM_DATA5_REG	Register 5 that stores data to be programmed	0x0014	R/W
EFUSE_PGM_DATA6_REG	Register 6 that stores data to be programmed	0x0018	R/W
EFUSE_PGM_DATA7_REG	Register 7 that stores data to be programmed	0x001C	R/W
EFUSE_PGM_CHECK_VALUE0_REG	Register 0 that stores the RS code to be programmed	0x0020	R/W
EFUSE_PGM_CHECK_VALUE1_REG	Register 1 that stores the RS code to be programmed	0x0024	R/W
EFUSE_PGM_CHECK_VALUE2_REG	Register 2 that stores the RS code to be programmed	0x0028	R/W
Read Data Register			
EFUSE_RD_WR_DIS_REG	BLOCK0 data register 0	0x002C	RO
EFUSE_RD_REPEAT_DATA0_REG	BLOCK0 data register 1	0x0030	RO
EFUSE_RD_REPEAT_DATA1_REG	BLOCK0 data register 2	0x0034	RO
EFUSE_RD_REPEAT_DATA2_REG	BLOCK0 data register 3	0x0038	RO
EFUSE_RD_REPEAT_DATA3_REG	BLOCK0 data register 4	0x003C	RO
EFUSE_RD_REPEAT_DATA4_REG	BLOCK0 data register 5	0x0040	RO
EFUSE_RD_MAC_SPI_SYS_0_REG	BLOCK1 data register 0	0x0044	RO
EFUSE_RD_MAC_SPI_SYS_1_REG	BLOCK1 data register 1	0x0048	RO
EFUSE_RD_MAC_SPI_SYS_2_REG	BLOCK1 data register 2	0x004C	RO
EFUSE_RD_MAC_SPI_SYS_3_REG	BLOCK1 data register 3	0x0050	RO
EFUSE_RD_MAC_SPI_SYS_4_REG	BLOCK1 data register 4	0x0054	RO
EFUSE_RD_MAC_SPI_SYS_5_REG	BLOCK1 data register 5	0x0058	RO
EFUSE_RD_SYS_PART1_DATA0_REG	Register 0 of BLOCK2 (system)	0x005C	RO
EFUSE_RD_SYS_PART1_DATA1_REG	Register 1 of BLOCK2 (system)	0x0060	RO
EFUSE_RD_SYS_PART1_DATA2_REG	Register 2 of BLOCK2 (system)	0x0064	RO
EFUSE_RD_SYS_PART1_DATA3_REG	Register 3 of BLOCK2 (system)	0x0068	RO
EFUSE_RD_SYS_PART1_DATA4_REG	Register 4 of BLOCK2 (system)	0x006C	RO
EFUSE_RD_SYS_PART1_DATA5_REG	Register 5 of BLOCK2 (system)	0x0070	RO
EFUSE_RD_SYS_PART1_DATA6_REG	Register 6 of BLOCK2 (system)	0x0074	RO
EFUSE_RD_SYS_PART1_DATA7_REG	Register 7 of BLOCK2 (system)	0x0078	RO
EFUSE_RD_USR_DATA0_REG	Register 0 of BLOCK3 (user)	0x007C	RO

Name	Description	Address	Access
EFUSE_RD_USR_DATA1_REG	Register 1 of BLOCK3 (user)	0x0080	RO
EFUSE_RD_USR_DATA2_REG	Register 2 of BLOCK3 (user)	0x0084	RO
EFUSE_RD_USR_DATA3_REG	Register 3 of BLOCK3 (user)	0x0088	RO
EFUSE_RD_USR_DATA4_REG	Register 4 of BLOCK3 (user)	0x008C	RO
EFUSE_RD_USR_DATA5_REG	Register 5 of BLOCK3 (user)	0x0090	RO
EFUSE_RD_USR_DATA6_REG	Register 6 of BLOCK3 (user)	0x0094	RO
EFUSE_RD_USR_DATA7_REG	Register 7 of BLOCK3 (user)	0x0098	RO
EFUSE_RD_KEY0_DATA0_REG	Register 0 of BLOCK4 (KEY0)	0x009C	RO
EFUSE_RD_KEY0_DATA1_REG	Register 1 of BLOCK4 (KEY0)	0x00A0	RO
EFUSE_RD_KEY0_DATA2_REG	Register 2 of BLOCK4 (KEY0)	0x00A4	RO
EFUSE_RD_KEY0_DATA3_REG	Register 3 of BLOCK4 (KEY0)	0x00A8	RO
EFUSE_RD_KEY0_DATA4_REG	Register 4 of BLOCK4 (KEY0)	0x00AC	RO
EFUSE_RD_KEY0_DATA5_REG	Register 5 of BLOCK4 (KEY0)	0x00B0	RO
EFUSE_RD_KEY0_DATA6_REG	Register 6 of BLOCK4 (KEY0)	0x00B4	RO
EFUSE_RD_KEY0_DATA7_REG	Register 7 of BLOCK4 (KEY0)	0x00B8	RO
EFUSE_RD_KEY1_DATA0_REG	Register 0 of BLOCK5 (KEY1)	0x00BC	RO
EFUSE_RD_KEY1_DATA1_REG	Register 1 of BLOCK5 (KEY1)	0x00C0	RO
EFUSE_RD_KEY1_DATA2_REG	Register 2 of BLOCK5 (KEY1)	0x00C4	RO
EFUSE_RD_KEY1_DATA3_REG	Register 3 of BLOCK5 (KEY1)	0x00C8	RO
EFUSE_RD_KEY1_DATA4_REG	Register 4 of BLOCK5 (KEY1)	0x00CC	RO
EFUSE_RD_KEY1_DATA5_REG	Register 5 of BLOCK5 (KEY1)	0x00D0	RO
EFUSE_RD_KEY1_DATA6_REG	Register 6 of BLOCK5 (KEY1)	0x00D4	RO
EFUSE_RD_KEY1_DATA7_REG	Register 7 of BLOCK5 (KEY1)	0x00D8	RO
EFUSE_RD_KEY2_DATA0_REG	Register 0 of BLOCK6 (KEY2)	0x00DC	RO
EFUSE_RD_KEY2_DATA1_REG	Register 1 of BLOCK6 (KEY2)	0x00E0	RO
EFUSE_RD_KEY2_DATA2_REG	Register 2 of BLOCK6 (KEY2)	0x00E4	RO
EFUSE_RD_KEY2_DATA3_REG	Register 3 of BLOCK6 (KEY2)	0x00E8	RO
EFUSE_RD_KEY2_DATA4_REG	Register 4 of BLOCK6 (KEY2)	0x00EC	RO
EFUSE_RD_KEY2_DATA5_REG	Register 5 of BLOCK6 (KEY2)	0x00F0	RO
EFUSE_RD_KEY2_DATA6_REG	Register 6 of BLOCK6 (KEY2)	0x00F4	RO
EFUSE_RD_KEY2_DATA7_REG	Register 7 of BLOCK6 (KEY2)	0x00F8	RO
EFUSE_RD_KEY3_DATA0_REG	Register 0 of BLOCK7 (KEY3)	0x00FC	RO
EFUSE_RD_KEY3_DATA1_REG	Register 1 of BLOCK7 (KEY3)	0x0100	RO
EFUSE_RD_KEY3_DATA2_REG	Register 2 of BLOCK7 (KEY3)	0x0104	RO
EFUSE_RD_KEY3_DATA3_REG	Register 3 of BLOCK7 (KEY3)	0x0108	RO
EFUSE_RD_KEY3_DATA4_REG	Register 4 of BLOCK7 (KEY3)	0x010C	RO
EFUSE_RD_KEY3_DATA5_REG	Register 5 of BLOCK7 (KEY3)	0x0110	RO
EFUSE_RD_KEY3_DATA6_REG	Register 6 of BLOCK7 (KEY3)	0x0114	RO
EFUSE_RD_KEY3_DATA7_REG	Register 7 of BLOCK7 (KEY3)	0x0118	RO
EFUSE_RD_KEY4_DATA0_REG	Register 0 of BLOCK8 (KEY4)	0x011C	RO
EFUSE_RD_KEY4_DATA1_REG	Register 1 of BLOCK8 (KEY4)	0x0120	RO
EFUSE_RD_KEY4_DATA2_REG	Register 2 of BLOCK8 (KEY4)	0x0124	RO
EFUSE_RD_KEY4_DATA3_REG	Register 3 of BLOCK8 (KEY4)	0x0128	RO

Name	Description	Address	Access
EFUSE_RD_KEY4_DATA4_REG	Register 4 of BLOCK8 (KEY4)	0x012C	RO
EFUSE_RD_KEY4_DATA5_REG	Register 5 of BLOCK8 (KEY4)	0x0130	RO
EFUSE_RD_KEY4_DATA6_REG	Register 6 of BLOCK8 (KEY4)	0x0134	RO
EFUSE_RD_KEY4_DATA7_REG	Register 7 of BLOCK8 (KEY4)	0x0138	RO
EFUSE_RD_KEY5_DATA0_REG	Register 0 of BLOCK9 (KEY5)	0x013C	RO
EFUSE_RD_KEY5_DATA1_REG	Register 1 of BLOCK9 (KEY5)	0x0140	RO
EFUSE_RD_KEY5_DATA2_REG	Register 2 of BLOCK9 (KEY5)	0x0144	RO
EFUSE_RD_KEY5_DATA3_REG	Register 3 of BLOCK9 (KEY5)	0x0148	RO
EFUSE_RD_KEY5_DATA4_REG	Register 4 of BLOCK9 (KEY5)	0x014C	RO
EFUSE_RD_KEY5_DATA5_REG	Register 5 of BLOCK9 (KEY5)	0x0150	RO
EFUSE_RD_KEY5_DATA6_REG	Register 6 of BLOCK9 (KEY5)	0x0154	RO
EFUSE_RD_KEY5_DATA7_REG	Register 7 of BLOCK9 (KEY5)	0x0158	RO
EFUSE_RD_SYS_PART2_DATA0_REG	Register 0 of BLOCK10 (system)	0x015C	RO
EFUSE_RD_SYS_PART2_DATA1_REG	Register 1 of BLOCK10 (system)	0x0160	RO
EFUSE_RD_SYS_PART2_DATA2_REG	Register 2 of BLOCK10 (system)	0x0164	RO
EFUSE_RD_SYS_PART2_DATA3_REG	Register 3 of BLOCK10 (system)	0x0168	RO
EFUSE_RD_SYS_PART2_DATA4_REG	Register 4 of BLOCK10 (system)	0x016C	RO
EFUSE_RD_SYS_PART2_DATA5_REG	Register 5 of BLOCK10 (system)	0x0170	RO
EFUSE_RD_SYS_PART2_DATA6_REG	Register 6 of BLOCK10 (system)	0x0174	RO
EFUSE_RD_SYS_PART2_DATA7_REG	Register 7 of BLOCK10 (system)	0x0178	RO
Report Register			
EFUSE_RD_REPEAT_ERR0_REG	Programming error record register 0 of BLOCK0	0x017C	RO
EFUSE_RD_REPEAT_ERR1_REG	Programming error record register 1 of BLOCK0	0x0180	RO
EFUSE_RD_REPEAT_ERR2_REG	Programming error record register 2 of BLOCK0	0x0184	RO
EFUSE_RD_REPEAT_ERR3_REG	Programming error record register 3 of BLOCK0	0x0188	RO
EFUSE_RD_REPEAT_ERR4_REG	Programming error record register 4 of BLOCK0	0x0190	RO
EFUSE_RD_RS_ERR0_REG	Programming error record register 0 of BLOCK1 ~ 10	0x01C0	RO
EFUSE_RD_RS_ERR1_REG	Programming error record register 1 of BLOCK1 ~ 10	0x01C4	RO
Configuration Register			
EFUSE_CLK_REG	eFuse clock configuration register	0x01C8	R/W
EFUSE_CONF_REG	eFuse operation mode configuration register	0x01CC	R/W
EFUSE_CMD_REG	eFuse command register	0x01D4	varies
EFUSE_DAC_CONF_REG	Controls the eFuse programming voltage	0x01E8	R/W
EFUSE_RD_TIM_CONF_REG	Configures read timing parameters	0x01EC	R/W
EFUSE_WR_TIM_CONF1_REG	Configuration register 1 of eFuse programming timing parameters	0x01F4	R/W
EFUSE_WR_TIM_CONF2_REG	Configuration register 2 of eFuse programming timing parameters	0x01F8	R/W
Status Register			
EFUSE_STATUS_REG	eFuse status register	0x01D0	RO
Interrupt Register			

Name	Description	Address	Access
EFUSE_INT_RAW_REG	eFuse raw interrupt register	0x01D8	R/WC/SS
EFUSE_INT_ST_REG	eFuse interrupt status register	0x01DC	RO
EFUSE_INT_ENA_REG	eFuse interrupt enable register	0x01E0	R/W
EFUSE_INT_CLR_REG	eFuse interrupt clear register	0x01E4	WO
Version Register			
EFUSE_DATE_REG	Version control register	0x01FC	R/W

5.5 Registers

The addresses in this section are relative to eFuse Controller base address provided in Table 4-3 in Chapter 4 *System and Memory*.

Register 5.1. EFUSE_PGM_DATA0_REG (0x0000)

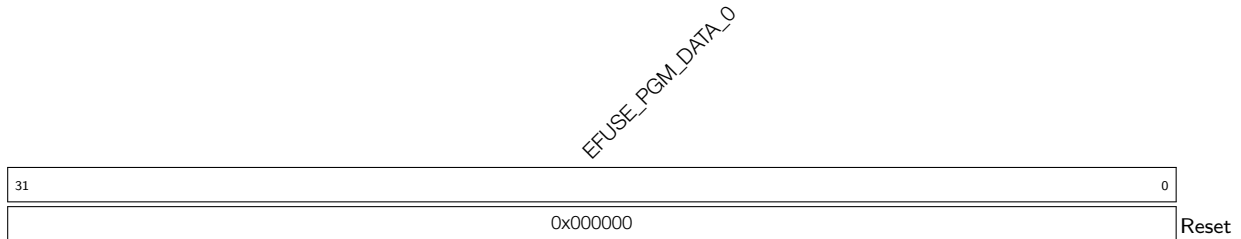

EFUSE_PGM_DATA_0 Configures the content of the 0th 32-bit data to be programmed. (R/W)

Register 5.2. EFUSE_PGM_DATA1_REG (0x0004)

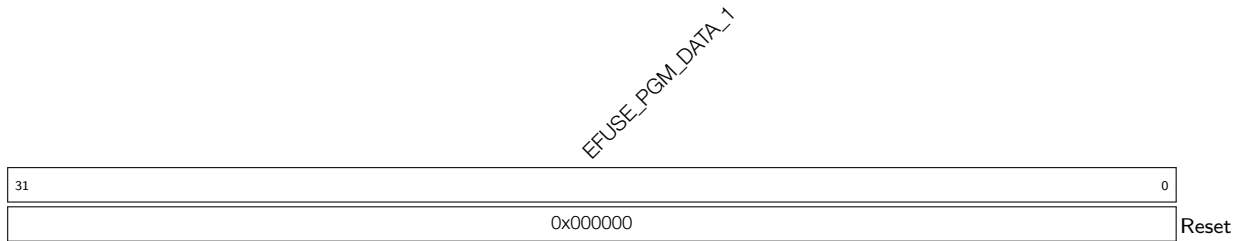

EFUSE_PGM_DATA_1 Configures the content of the 1st data to be programmed. (R/W)

Register 5.3. EFUSE_PGM_DATA2_REG (0x0008)

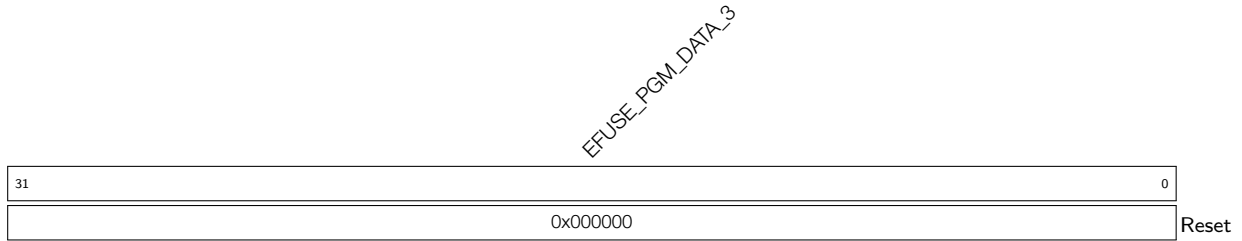

EFUSE_PGM_DATA_2 Configures the content of the 2nd 32-bit data to be programmed. (R/W)

Register 5.4. EFUSE_PGM_DATA3_REG (0x000C)

EFUSE_PGM_DATA_3 Configures the content of the 3rd 32-bit data to be programmed. (R/W)

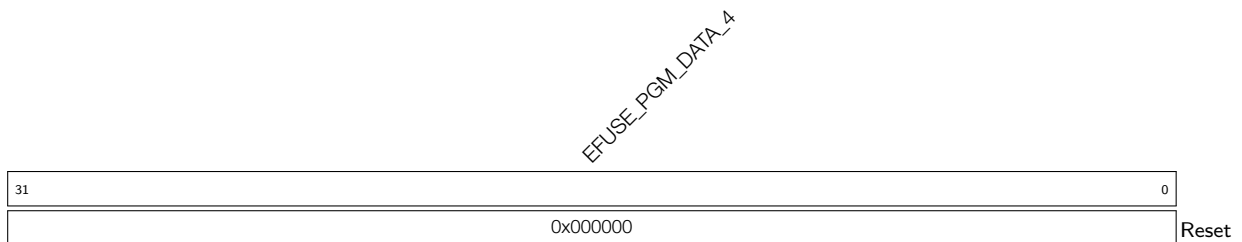
Register 5.5. EFUSE_PGM_DATA4_REG (0x0010)

EFUSE_PGM_DATA_4 Configures the content of the 4th 32-bit data to be programmed. (R/W)

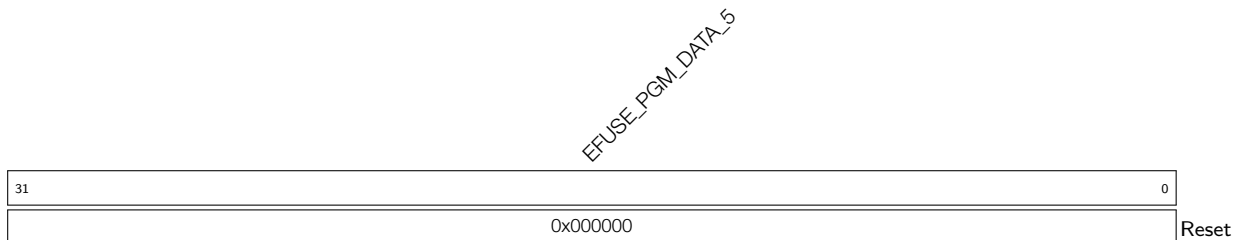
Register 5.6. EFUSE_PGM_DATA5_REG (0x0014)

EFUSE_PGM_DATA_5 Configures the content of the 5th 32-bit data to be programmed. (R/W)

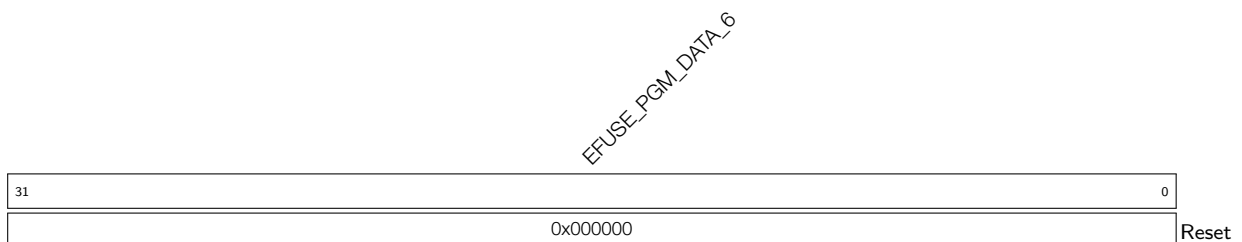
Register 5.7. EFUSE_PGM_DATA6_REG (0x0018)

EFUSE_PGM_DATA_6 Configures the content of the 6th 32-bit data to be programmed. (R/W)

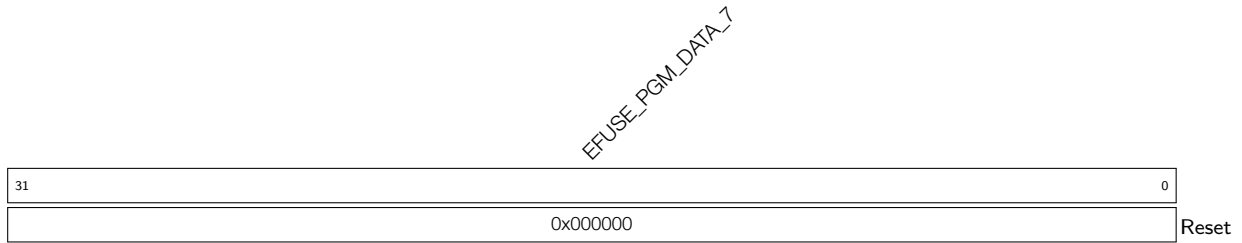
Register 5.8. EFUSE_PGM_DATA7_REG (0x001C)

EFUSE_PGM_DATA_7 Configures the content of the 7th 32-bit data to be programmed. (R/W)

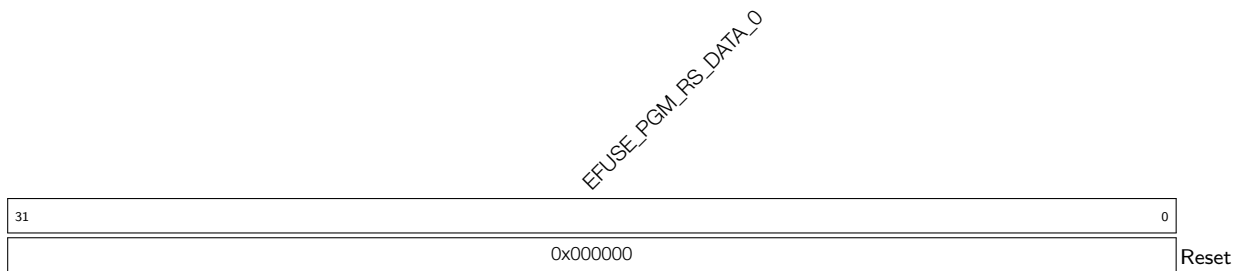
Register 5.9. EFUSE_PGM_CHECK_VALUE0_REG (0x0020)

EFUSE_PGM_RS_DATA_0 Configures the content of the 0th 32-bit RS code to be programmed.
(R/W)

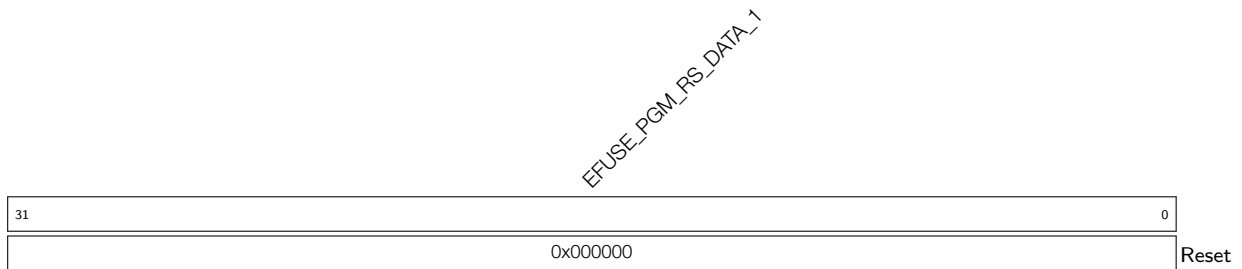
Register 5.10. EFUSE_PGM_CHECK_VALUE1_REG (0x0024)

EFUSE_PGM_RS_DATA_1 Configures the content of the 1st 32-bit RS code to be programmed.
(R/W)

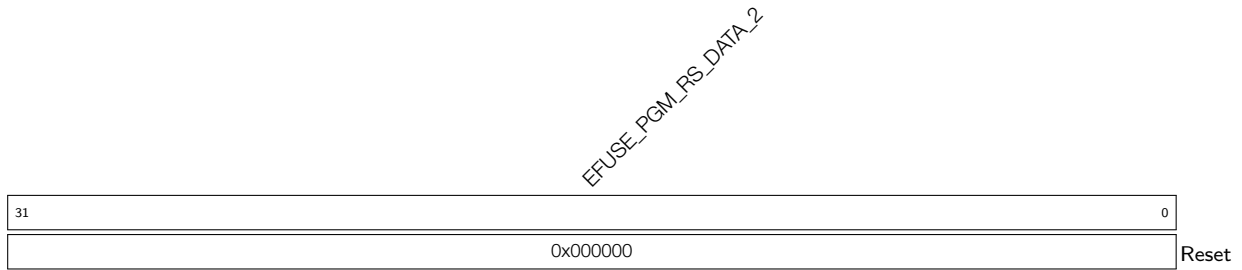
Register 5.11. EFUSE_PGM_CHECK_VALUE2_REG (0x0028)

EFUSE_PGM_RS_DATA_2 Configures the content of the 2nd 32-bit RS code to be programmed.
(R/W)

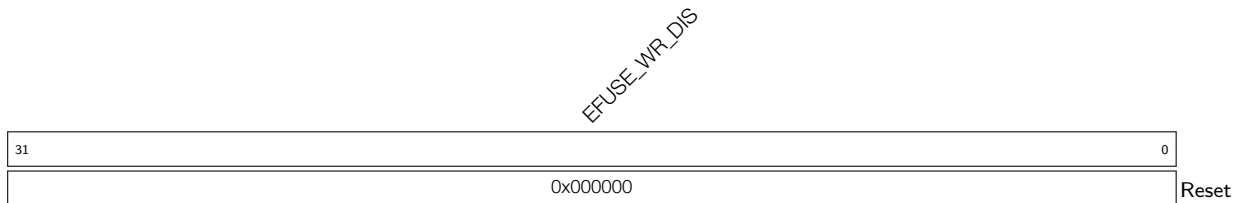
Register 5.12. EFUSE_RD_WR_DIS_REG (0x002C)

EFUSE_WR_DIS Represents whether programming of corresponding eFuse part is disabled or enabled. 1: Disabled. 0: Enabled. (RO)

Register 5.13. EFUSE_RD_REPEAT_DATA0_REG (0x0030)

31	27	26	25	24	21	20	19	18	16	15	14	13	12	11	10	9	8	7	6	0
0	0	0	0	0	0	0	0	0x0	0	0	0	0	0	0	0	0	0	0	0x0	Reset

EFUSE_RD_DIS Represents whether users' reading from BLOCK4 ~ 10 is disabled or enabled. 1: Disabled. 0: Enabled. (RO)

EFUSE_RPT4_RESERVED3 Reserved (used four backups method). (RO)

EFUSE_DIS_ICACHE Represents whether iCache is disabled or enabled. 1: Disabled. 0: Enabled. (RO)

EFUSE_DIS_DCACHE Represents whether dCache is disabled or enabled. 1: Disabled. 0: Enabled. (RO)

EFUSE_DIS_DOWNLOAD_ICACHE Represents whether iCache is disabled or enabled in download mode (boot_mode[3:0] is 0, 1, 2, 3, 6, 7). 1: Disabled. 0: Enabled. (RO)

EFUSE_DIS_DOWNLOAD_DCACHE Represents whether dCache is disabled or enabled in download mode (boot_mode[3:0] is 0, 1, 2, 3, 6, 7). 1: Disabled. 0: Enabled. (RO)

EFUSE_DIS_FORCE_DOWNLOAD Represents whether the function that forces chip into download mode is disabled or enabled. 1: Disabled. 0: Enabled. (RO)

EFUSE_DIS_USB_OTG Represents whether USB OTG function is disabled or enabled. 1: Disabled. 0: Enabled. (RO)

EFUSE_DIS_TWAI Represents whether TWAI function is disabled or enabled. 1: Disabled. 0: Enabled. (RO)

EFUSE_DIS_APP_CPU Represents whether app CPU is disabled or enabled. 1: Disabled. 0: Enabled. (RO)

EFUSE_SOFT_DIS_JTAG Represents whether JTAG is disabled in the soft way or not. Odd number of 1: Disabled. Users can re-enable JTAG by HMAC module again. Even number of 1: Enabled. (RO)

EFUSE_DIS_PAD_JTAG Represents whether pad JTAG is permanently disabled or enabled. 1: Disabled. 0: Enabled. (RO)

EFUSE_DIS_DOWNLOAD_MANUAL_ENCRYPT Represents whether flash encryption is disabled or enabled in download boot modes. 1: Disabled. 0: Enabled. (RO)

Continued on the next page...

Register 5.13. EFUSE_RD_REPEAT_DATA0_REG (0x0030)

Continued from the previous page...

EFUSE_USB_EXCHG_PINS Represents whether or not USB D+ and D- pins are swapped. 1: Swapped. 0: Not swapped. (RO)

Note: The eFuse has a design flaw and does **not** move the pullup (needed to detect USB speed), resulting in the PC thinking the chip is a low-speed device, which stops communication. For detailed information, please refer to Chapter [33 USB Serial/JTAG Controller \(USB_SERIAL_JTAG\)](#).

EFUSE_EXT_PHY_ENABLE Represents whether the external PHY is enabled or disabled. 1: Enabled. 0: Disabled. (RO)

Register 5.14. EFUSE_RD_REPEAT_DATA1_REG (0x0034)

EFUSE_KEY_PURPOSE_1		EFUSE_KEY_PURPOSE_0		EFUSE_SECURE_BOOT_KEY_REVOKE2		EFUSE_SECURE_BOOT_KEY_REVOKE1		EFUSE_SECURE_BOOT_KEY_REVOKE0		EFUSE_SPI_BOOT_CRYPT_CNT		EFUSE_WDT_DELAY_SEL		(reserved)		EFUSE_VDD_SPI_FORCE		EFUSE_VDD_SPI_TIEH		EFUSE_VDD_SPI_XPD		(reserved)		
31	28	27	24	23	22	21	20	18	17	16	15					7	6	5	4	3			0	
0x0		0x0		0	0	0	0x0		0x0		0	0	0	0	0	0	0	0	0	0	0	0	0	Reset

EFUSE_VDD_SPI_XPD Represents whether or not Flash Voltage Regulator is powered up. 1: Powered up. 0: Not powered up. (RO)

EFUSE_VDD_SPI_TIEH Represents whether or not Flash Voltage Regulator output is short connected to VDD3P3_RTC_IO. 1: Short connected to VDD3P3_RTC_IO. 0: connect to 1.8 V Flash Voltage Regulator. (RO)

EFUSE_VDD_SPI_FORCE Represents whether or not to force using the parameters in eFuse, including [EFUSE_VDD_SPI_XPD](#) and [EFUSE_VDD_SPI_TIEH](#), to configure flash voltage LDO. 1: Use. 0: Not use. (RO)

EFUSE_WDT_DELAY_SEL Represents RTC watchdog timeout threshold. Measurement unit: slow clock cycle. 00: 40000, 01: 80000, 10: 160000, 11:320000. (RO)

EFUSE_SPI_BOOT_CRYPT_CNT Represents whether SPI boot encrypt/decrypt is disabled or enabled. Odd number of 1: Enabled. Even number of 1: Disabled. (RO)

EFUSE_SECURE_BOOT_KEY_REVOKE0 Represents whether or not the first secure boot key is revoked. 1: Revoked. 0: Not revoked. (RO)

EFUSE_SECURE_BOOT_KEY_REVOKE1 Represents whether or not the second secure boot key is revoked. 1: Revoked. 0: Not revoked. (RO)

EFUSE_SECURE_BOOT_KEY_REVOKE2 Represents whether or not the third secure boot key is revoked. 1: Revoked. 0: Not revoked. (RO)

EFUSE_KEY_PURPOSE_0 Represents purpose of Key0. (RO)

EFUSE_KEY_PURPOSE_1 Represents purpose of Key1. (RO)

Register 5.15. EFUSE_RD_REPEAT_DATA2_REG (0x0038)

31	28	27	26	25	24	23	22	21	20	19	16	15	12	11	8	7	4	3	0
0x0	0x0	0	0	0	0	0	0	0	0	0x0	0x0	0x0	0x0	0x0	0x0	0x0	0x0	0x0	0x0

Reset

EFUSE_KEY_PURPOSE_2 Represents purpose of Key2. (RO)

EFUSE_KEY_PURPOSE_3 Represents purpose of Key3. (RO)

EFUSE_KEY_PURPOSE_4 Represents purpose of Key4. (RO)

EFUSE_KEY_PURPOSE_5 Represents purpose of Key5. (RO)

EFUSE_RPT4_RESERVED0 Reserved (used four backups method). (RO)

EFUSE_SECURE_BOOT_EN Represents whether secure boot is enabled or disabled. 1: Enabled. 0: Disabled. (RO)

EFUSE_SECURE_BOOT_AGGRESSIVE_REVOKE Represents whether aggressive revoke of secure boot keys is enabled or disabled. 1: Enabled. 0: Disabled. (RO)

EFUSE_DIS_USB_JTAG Represents whether USB OTG function that can be switched to JTAG interface is disabled or enabled. 1: Disabled. 0: Enabled. (RO)

EFUSE_DIS_USB_SERIAL_JTAG Represents whether usb_serial_jtag function is disabled or enabled. 1: Disabled. 0: Enabled. (RO)

EFUSE_STRAP_JTAG_SEL Represents whether or not to enable selection between usb_to_jtag and pad_to_jtag through strapping GPIO3 when both reg_dis_usb_jtag and reg_dis_pad_jtag are equal to 0. 1: Enabled. 0: Disabled. (RO)

EFUSE_USB_PHY_SEL Represents the connection relationship between internal PHY, external PHY and USB OTG, USB Serial/JTAG. 0: internal PHY is assigned to USB Serial/JTAG while external PHY is assigned to USB OTG. 1: internal PHY is assigned to USB OTG while external PHY is assigned to USB Serial/JTAG. (RO)

EFUSE_FLASH_TPUW Represents flash waiting time after power-up. Measurement unit: ms. If the value is less than 15, the waiting time is the configurable value. Otherwise, the waiting time is always 30ms. (RO)

Register 5.16. EFUSE_RD_REPEAT_DATA3_REG (0x003C)

<i>EFUSE_DIS_USB_OTG_DOWNLOAD_MODE (reserved)</i>														<i>EFUSE_SECURE_VERSION</i>			<i>EFUSE_FORCE_SEND_RESUME EFUSE_FLASH_ECC_EN EFUSE_FLASH_PAGE_SIZE EFUSE_FLASH_TYPE EFUSE_PIN_POWER_SELECTION EFUSE_UART_PRINT_SELECTION EFUSE_ENABLE_SECURITY_DOWNLOAD EFUSE_DIS_USB_SERIAL_JTAG_DOWNLOAD_MODE EFUSE_FLASH_ECC_MODE EFUSE_DIS_USB_PRINT EFUSE_DIS_LEGACY_SPI_BOOT EFUSE_DIS_DOWNLOAD_MODE</i>															
31	30	29												14	13	12	11	10	9	8	7	6	5	4	3	2	1	0				
0	0	0x00											0	0	0x0	0	0	0x0	0	0	0	0	0	0	0	0	0	0	0	0	0	Reset

EFUSE_DIS_DOWNLOAD_MODE Represents whether download mode (boot_mode[3:0] = 0, 1, 2, 3, 6, 7) is disabled or enabled. 1: Disabled. 0: Enabled. (RO)

EFUSE_DIS_LEGACY_SPI_BOOT Represents whether Legacy SPI boot mode (boot_mode[3:0] = 4) is disabled or enabled. 1: Disabled. 0: Enabled. (RO)

EFUSE_DIS_USB_PRINT Represents whether USB printing is disabled or enabled. 1: Disabled. 0: Enabled. (RO)

EFUSE_FLASH_ECC_MODE Represents the flash ECC mode in ROM. 0: 16-to-18 byte mode. 1: 16-to-17 byte mode. (RO)

EFUSE_DIS_USB_SERIAL_JTAG_DOWNLOAD_MODE Represents whether download through USB-Serial-JTAG is disabled or enabled. 1: Disabled. 0: Enabled. (RO)

EFUSE_ENABLE_SECURITY_DOWNLOAD Represents whether secure UART download mode is enabled or disabled (read/write flash only). 1: Enabled. 0: Disabled. (RO)

EFUSE_UART_PRINT_CONTROL Represents the default UART boot message output mode. 00: Enabled. 01: Enabled when GPIO46 is low at reset. 10: Enabled when GPIO46 is high at reset. 11: Disabled. (RO)

EFUSE_PIN_POWER_SELECTION Represents GPIO33 ~ GPIO37 power supply selection while ROM code is executed. 0: VDD3P3_CPU. 1: VDD_SPI. (RO)

EFUSE_FLASH_TYPE Represents the maximum data lines of SPI flash. 0: four lines. 1: eight lines. (RO)

EFUSE_FLASH_PAGE_SIZE Represents flash page size. 0: 256 Byte. 1: 512 Byte. 2: 1 KB. 3: 2 KB. (RO)

EFUSE_FLASH_ECC_EN Represents whether ECC for flash boot is enabled or disabled. 1: Enabled. 0: Disabled. (RO)

EFUSE_FORCE_SEND_RESUME Represents whether or not to force ROM code to send a resume command during SPI boot. 1: Send. 0: Not send. (RO)

Continued on the next page...

Register 5.16. EFUSE_RD_REPEAT_DATA3_REG (0x003C)

Continued from the previous page...

EFUSE_SECURE_VERSION Represents the values of version control register (used by ESP-IDF anti-rollback feature). (RO)

EFUSE_DIS_USB_OTG_DOWNLOAD_MODE Represents whether download through USB-OTG is disabled or enabled. 1: Disabled. 0: Enabled. (RO)

Register 5.17. EFUSE_RD_REPEAT_DATA4_REG (0x0040)

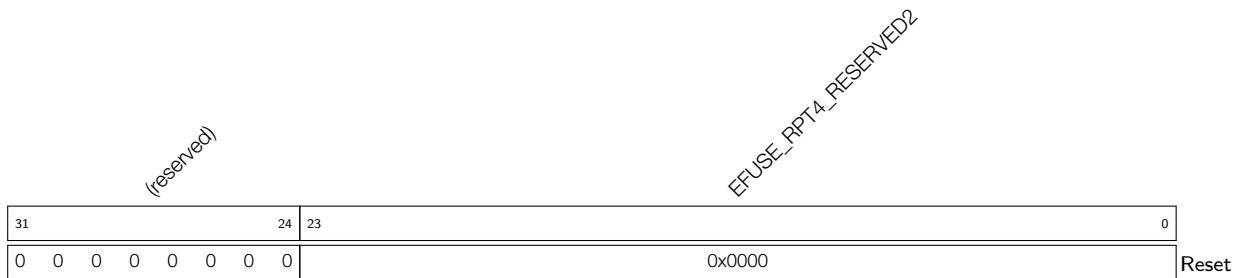

EFUSE_RPT4_RESERVED2 Reserved (used for four backups method). (RO)

Register 5.18. EFUSE_RD_MAC_SPI_SYS_0_REG (0x0044)

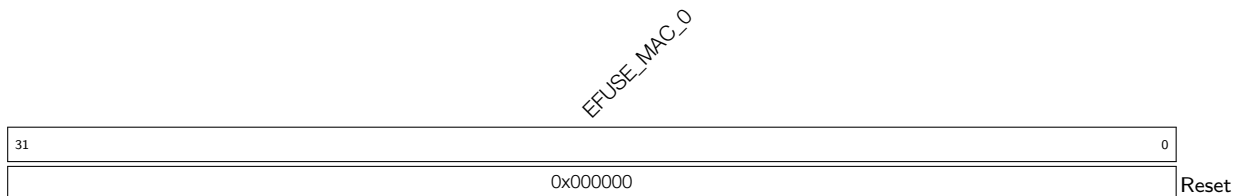

EFUSE_MAC_0 Represents the low 32 bits of MAC address. (RO)

Register 5.19. EFUSE_RD_MAC_SPI_SYS_1_REG (0x0048)

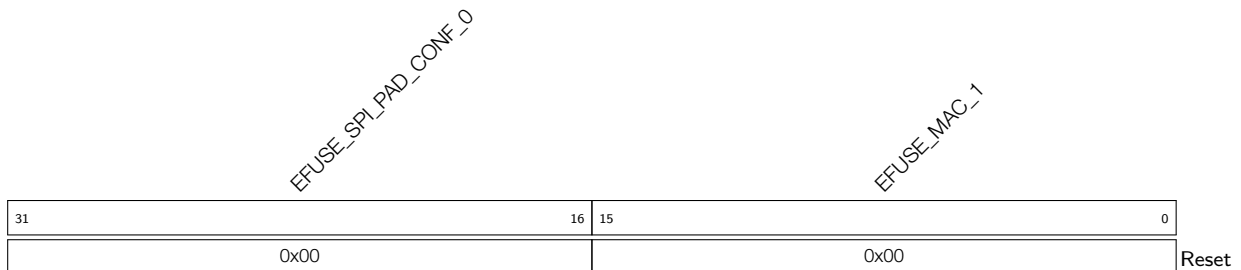

EFUSE_MAC_1 Represents the high 16 bits of MAC address. (RO)

EFUSE_SPI_PAD_CONF_0 Represents the first part of SPI_PAD_CONF. (RO)

Register 5.20. EFUSE_RD_MAC_SPI_SYS_2_REG (0x004C)

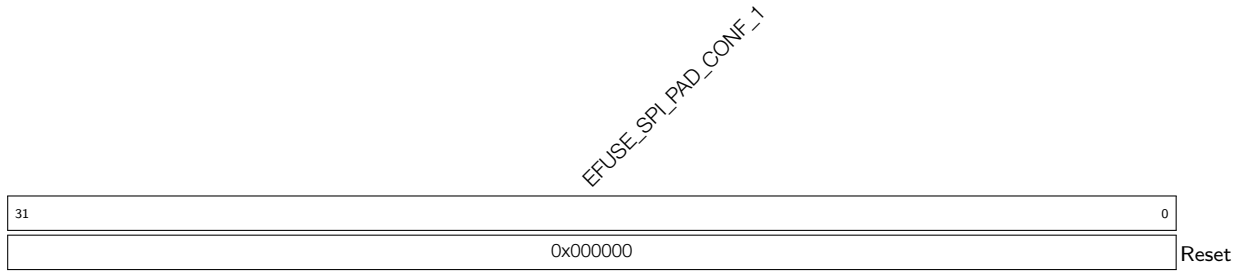

EFUSE_SPI_PAD_CONF_1 Represents the second part of SPI_PAD_CONF. (RO)

Register 5.21. EFUSE_RD_MAC_SPI_SYS_3_REG (0x0050)

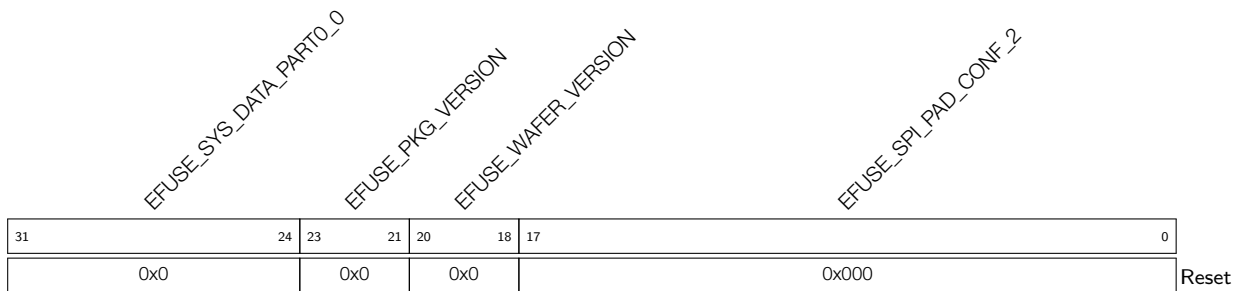

EFUSE_SPI_PAD_CONF_2 Represents the second part of SPI_PAD_CONF. (RO)

EFUSE_WAFER_VERSION Represents wafer version information. (RO)

EFUSE_PKG_VERSION Represents package version information. (RO)

EFUSE_SYS_DATA_PART0_0 Represents the bits 0~7 of the first part of system data. (RO)

Register 5.22. EFUSE_RD_MAC_SPI_SYS_4_REG (0x0054)

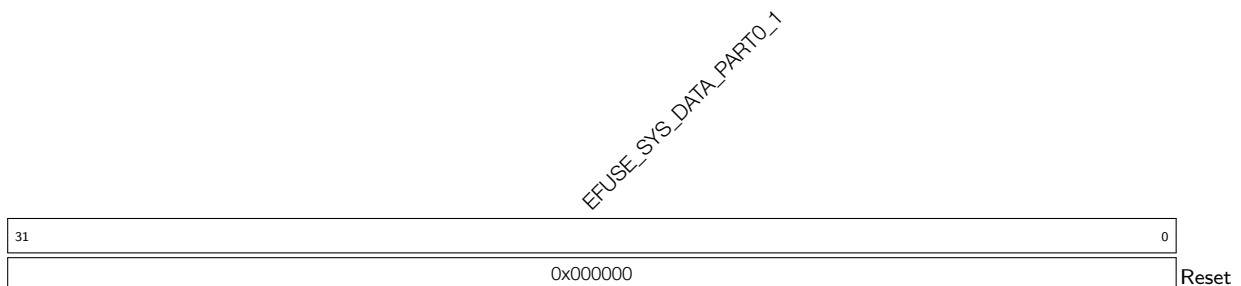

EFUSE_SYS_DATA_PART0_1 Represents the bits 8~39 of the first part of system data. (RO)

Register 5.23. EFUSE_RD_MAC_SPI_SYS_5_REG (0x0058)

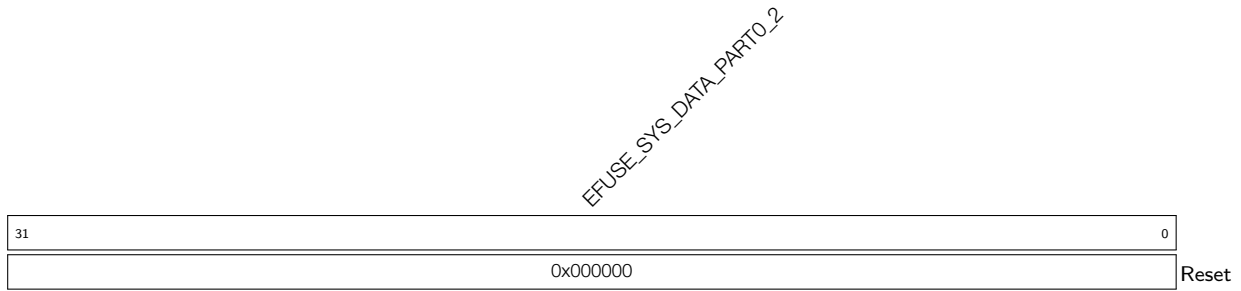

EFUSE_SYS_DATA_PART0_2 Represents the bits 40~71 of the first part of system data. (RO)

Register 5.24. EFUSE_RD_SYS_PART1_DATA0_REG (0x005C)

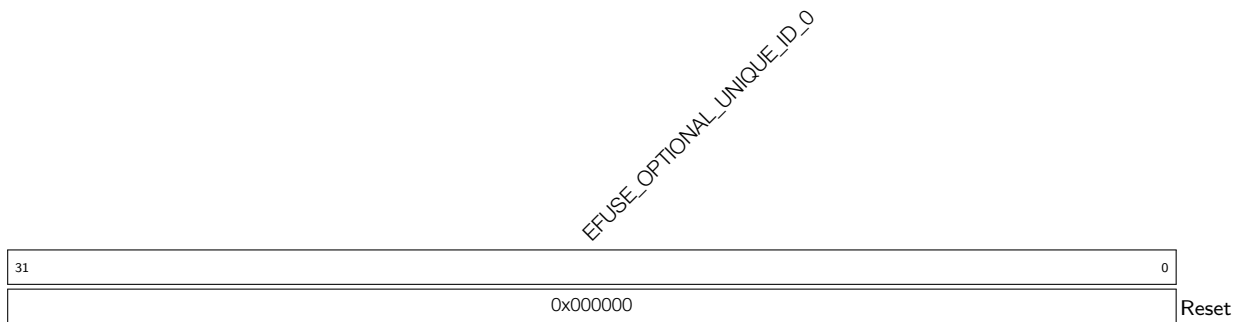

EFUSE_OPTIONAL_UNIQUE_ID_0 Represents the bits 0~31 of the optional unique id information. (RO)

Register 5.25. EFUSE_RD_SYS_PART1_DATA1_REG (0x0060)

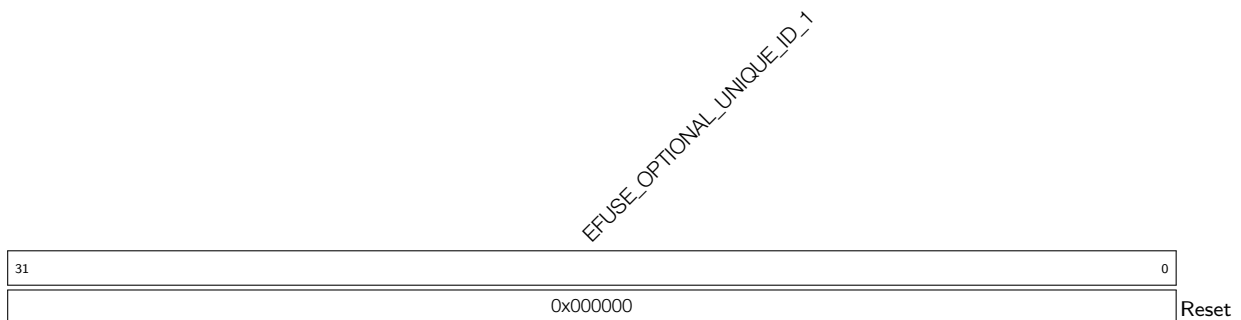

EFUSE_OPTIONAL_UNIQUE_ID_1 Represents the bits 32~63 of the optional unique id information. (RO)

Register 5.26. EFUSE_RD_SYS_PART1_DATA2_REG (0x0064)

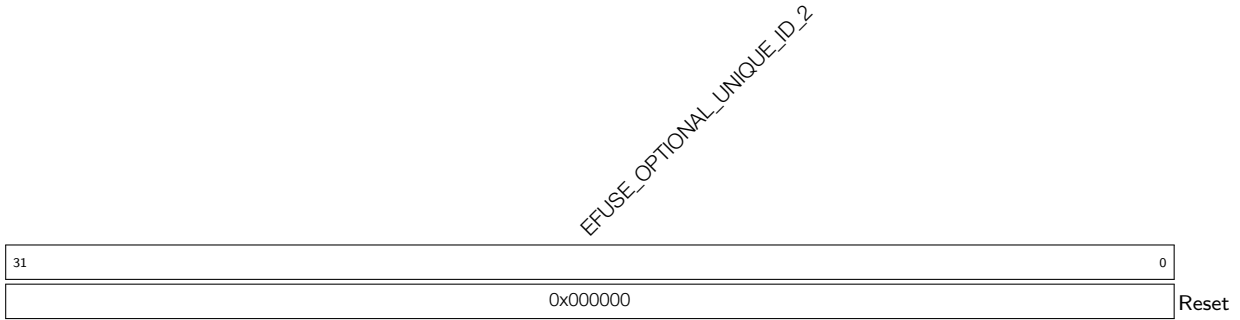

EFUSE_OPTIONAL_UNIQUE_ID_2 Represents the bits 64~95 of the optional unique id information.
(RO)

Register 5.27. EFUSE_RD_SYS_PART1_DATA3_REG (0x0068)

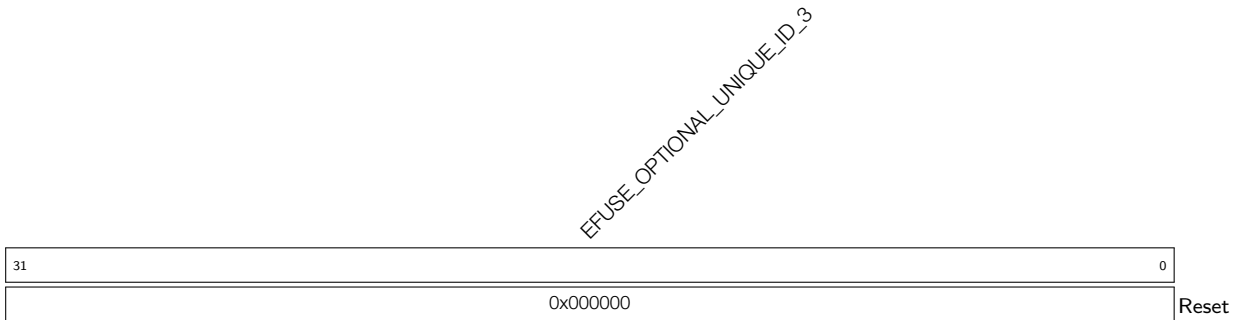

EFUSE_OPTIONAL_UNIQUE_ID_3 Represents the bits 96~127 of the optional unique id information.
(RO)

Register 5.28. EFUSE_RD_SYS_PART1_DATA4_REG (0x006C)

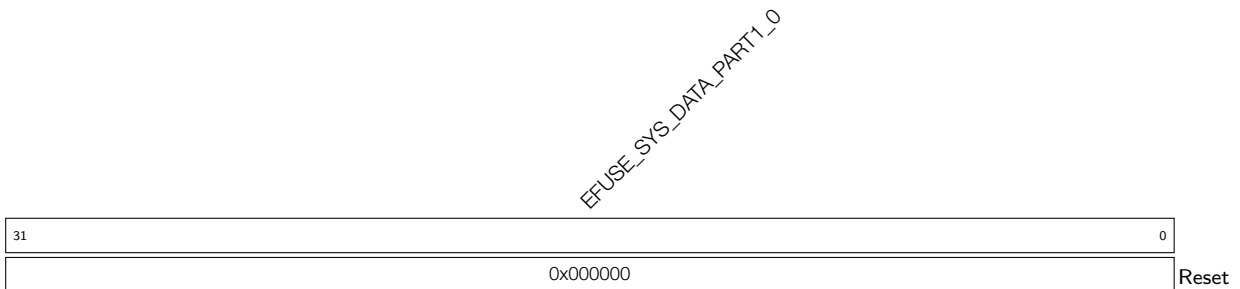

EFUSE_SYS_DATA_PART1_0 Represents the first 32 bits of the second part of system data. (RO)

Register 5.29. EFUSE_RD_SYS_PART1_DATA5_REG (0x0070)

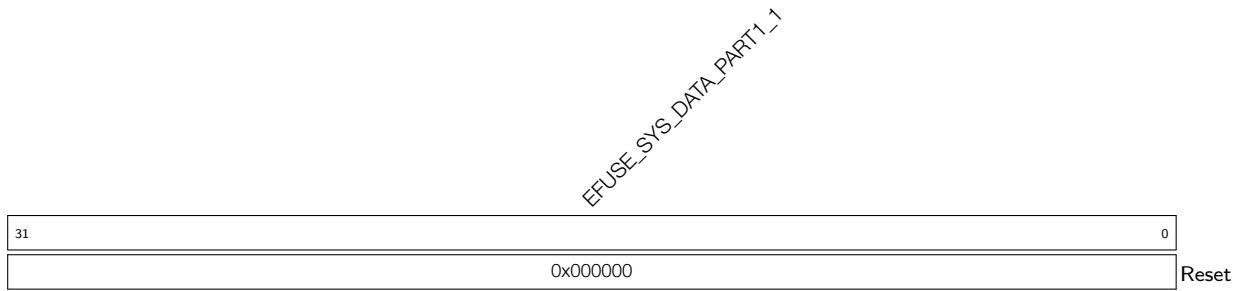

EFUSE_SYS_DATA_PART1_1 Represents the second 32 bits of the second part of system data. (RO)

Register 5.30. EFUSE_RD_SYS_PART1_DATA6_REG (0x0074)

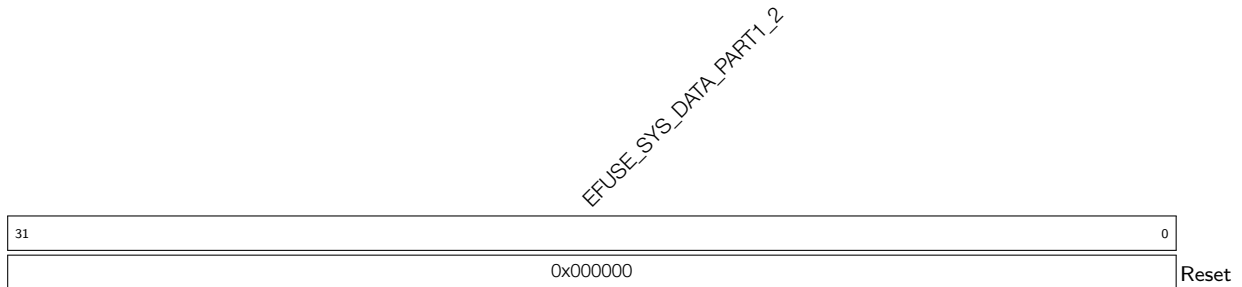

EFUSE_SYS_DATA_PART1_2 Represents the third 32 bits of the second part of system data. (RO)

Register 5.31. EFUSE_RD_SYS_PART1_DATA7_REG (0x0078)

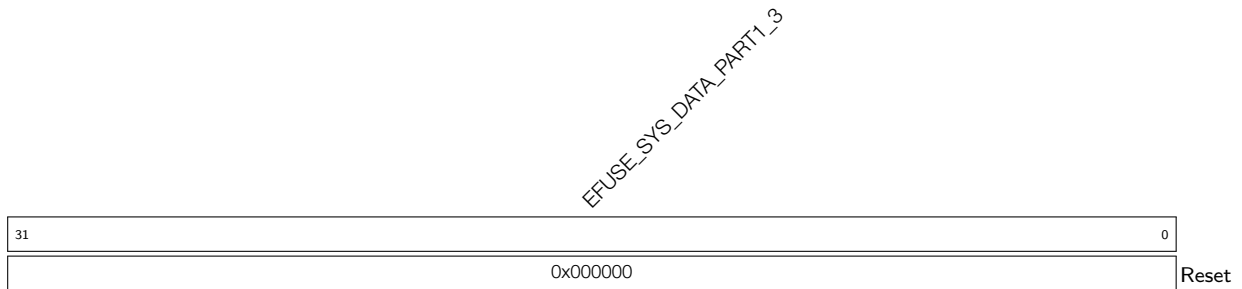

EFUSE_SYS_DATA_PART1_3 Represents the fourth 32 bits of the second part of system data. (RO)

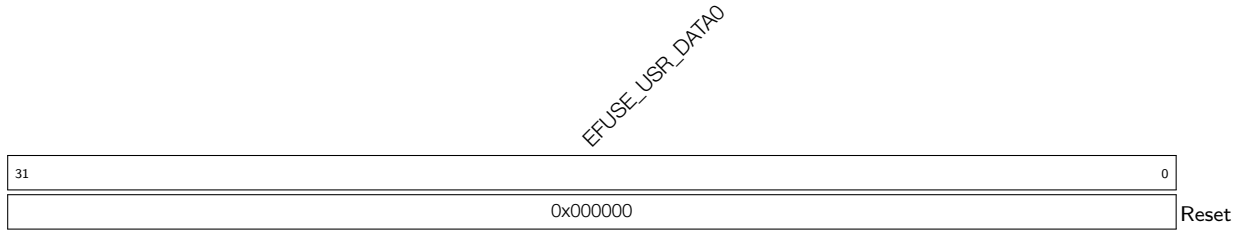
Register 5.32. EFUSE_RD_USR_DATA0_REG (0x007C)

EFUSE_USR_DATA0 Represents the bits [0:31] of BLOCK3 (user). (RO)

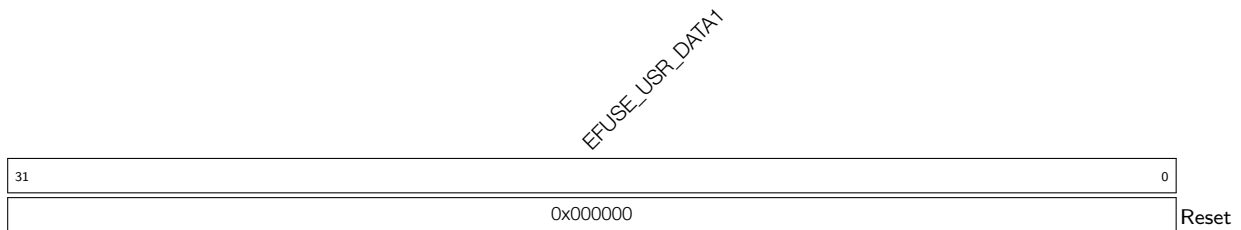
Register 5.33. EFUSE_RD_USR_DATA1_REG (0x0080)

EFUSE_USR_DATA1 Represents the bits [32:63] of BLOCK3 (user). (RO)

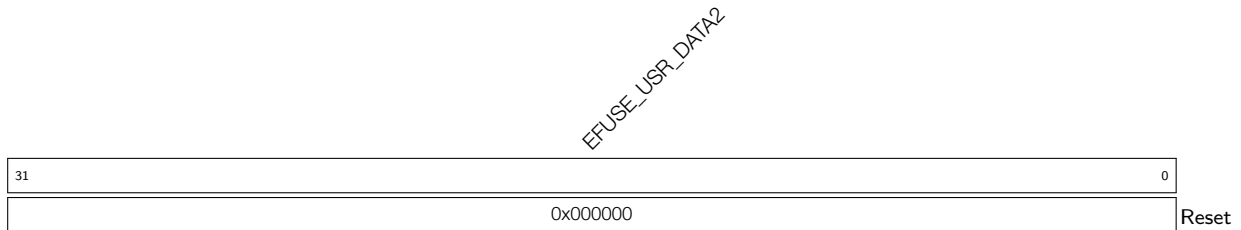
Register 5.34. EFUSE_RD_USR_DATA2_REG (0x0084)

EFUSE_USR_DATA2 Represents the bits [64:95] of BLOCK3 (user). (RO)

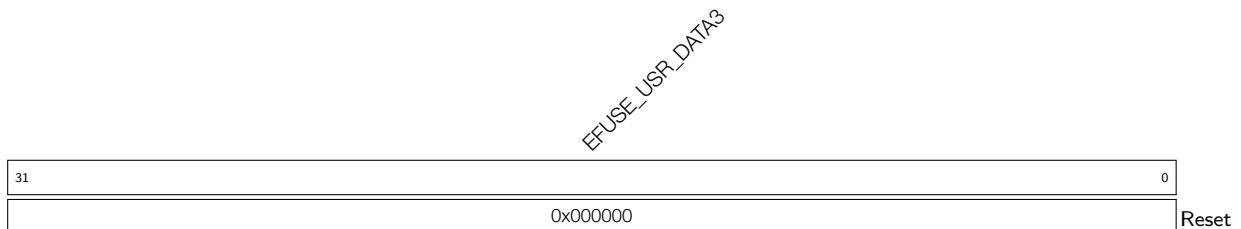
Register 5.35. EFUSE_RD_USR_DATA3_REG (0x0088)

EFUSE_USR_DATA3 Represents the bits [96:127] of BLOCK3 (user). (RO)

Register 5.36. EFUSE_RD_USR_DATA4_REG (0x008C)

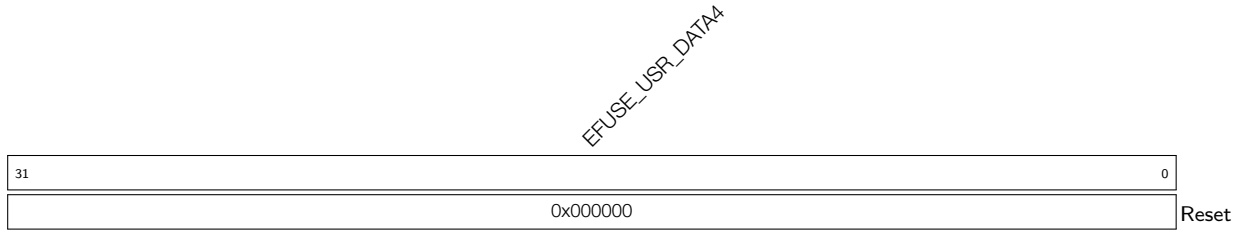

EFUSE_USR_DATA4 Represents the bits [128:159] of BLOCK3 (user). (RO)

Register 5.37. EFUSE_RD_USR_DATA5_REG (0x0090)

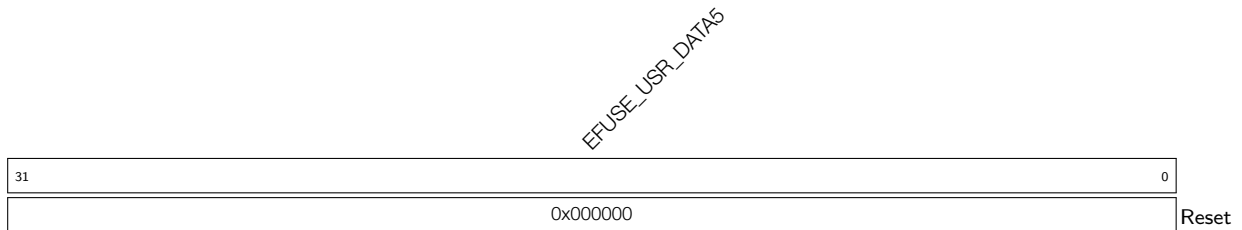

EFUSE_USR_DATA5 Represents the bits [160:191] of BLOCK3 (user). (RO)

Register 5.38. EFUSE_RD_USR_DATA6_REG (0x0094)

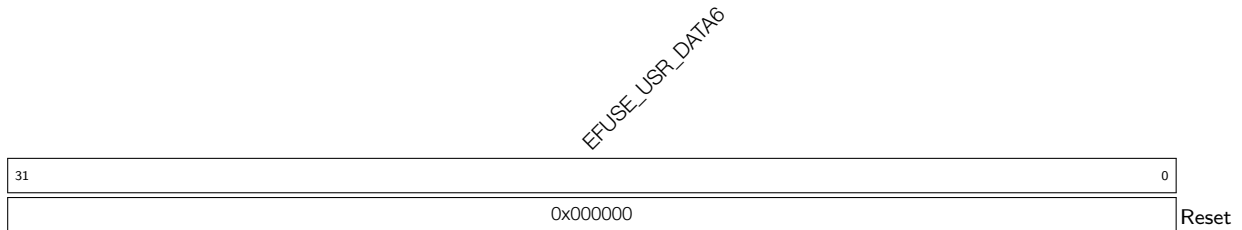

EFUSE_USR_DATA6 Represents the bits [192:223] of BLOCK3 (user). (RO)

Register 5.39. EFUSE_RD_USR_DATA7_REG (0x0098)

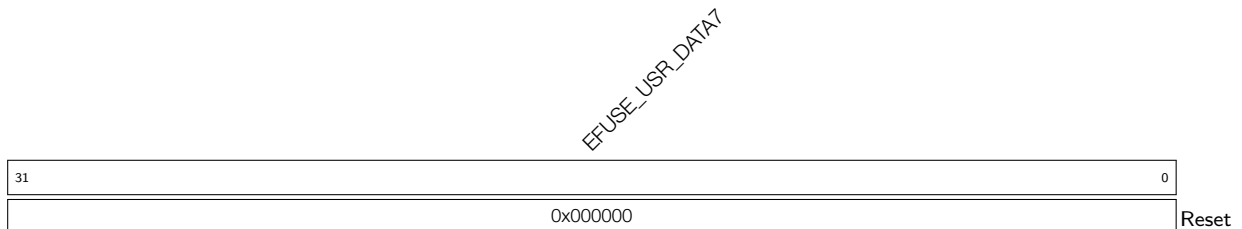

EFUSE_USR_DATA7 Represents the bits [224:255] of BLOCK3 (user). (RO)

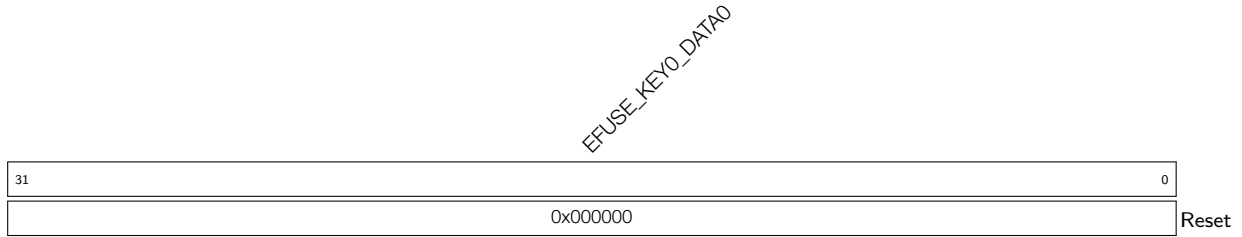
Register 5.40. EFUSE_RD_KEY0_DATA0_REG (0x009C)

EFUSE_KEY0_DATA0 Represents the first 32 bits of KEY0. (RO)

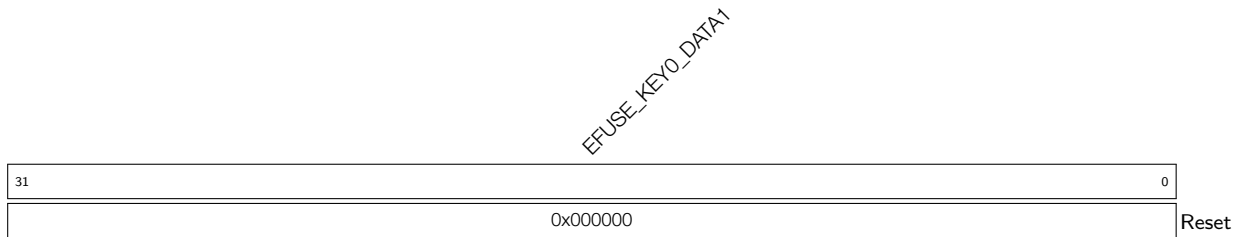
Register 5.41. EFUSE_RD_KEY0_DATA1_REG (0x00A0)

EFUSE_KEY0_DATA1 Represents the second 32 bits of KEY0. (RO)

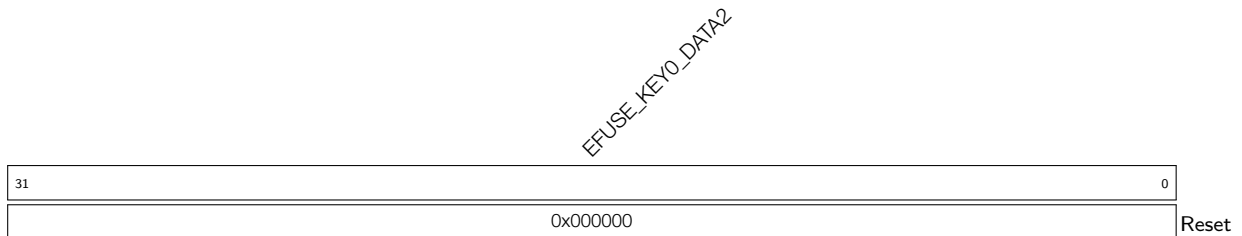
Register 5.42. EFUSE_RD_KEY0_DATA2_REG (0x00A4)

EFUSE_KEY0_DATA2 Represents the third 32 bits of KEY0. (RO)

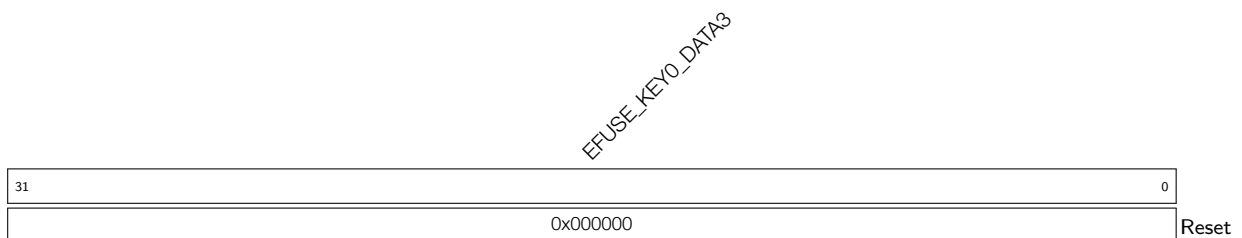
Register 5.43. EFUSE_RD_KEY0_DATA3_REG (0x00A8)

EFUSE_KEY0_DATA3 Represents the fourth 32 bits of KEY0. (RO)

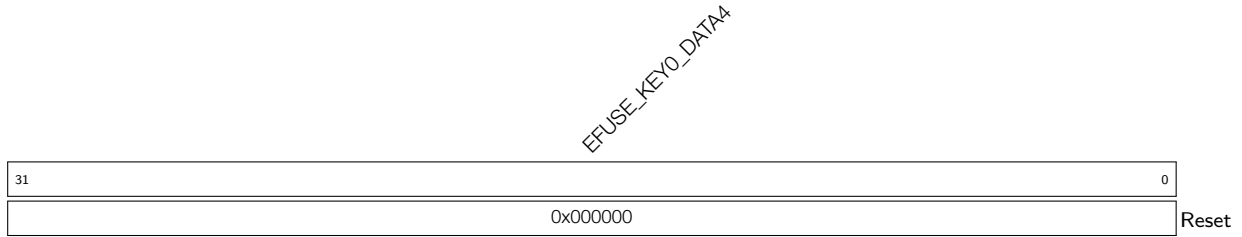
Register 5.44. EFUSE_RD_KEY0_DATA4_REG (0x00AC)

EFUSE_KEY0_DATA4 Represents the fifth 32 bits of KEY0. (RO)

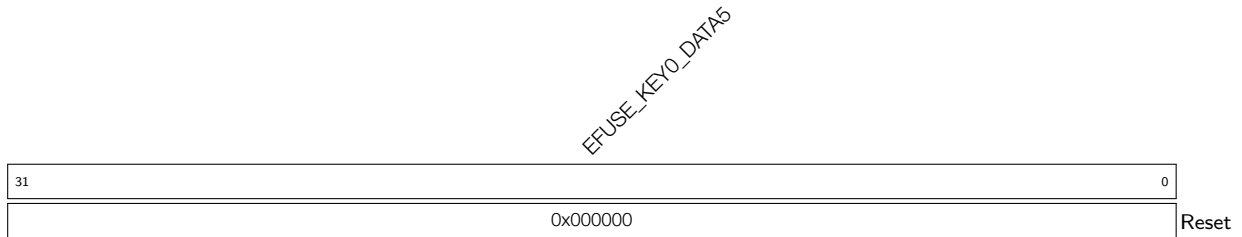
Register 5.45. EFUSE_RD_KEY0_DATA5_REG (0x00B0)

EFUSE_KEY0_DATA5 Represents the sixth 32 bits of KEY0. (RO)

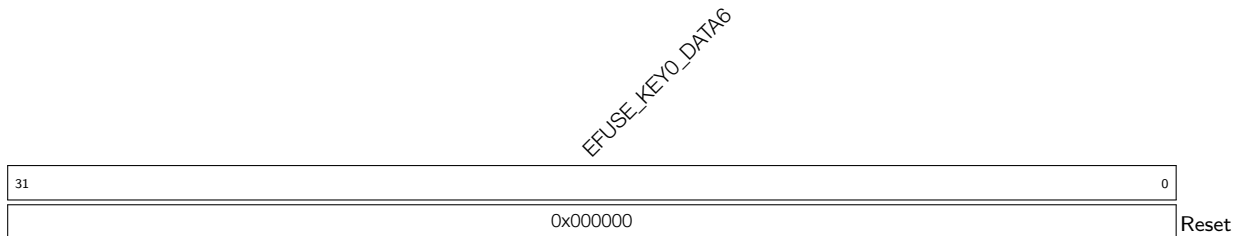
Register 5.46. EFUSE_RD_KEY0_DATA6_REG (0x00B4)

EFUSE_KEY0_DATA6 Represents the seventh 32 bits of KEY0. (RO)

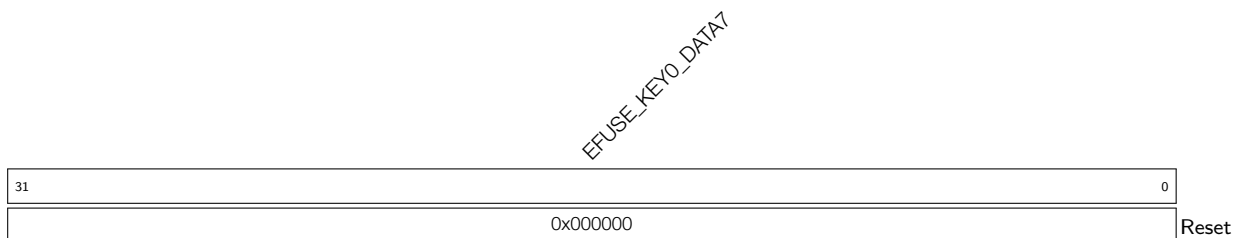
Register 5.47. EFUSE_RD_KEY0_DATA7_REG (0x00B8)

EFUSE_KEY0_DATA7 Represents the eighth 32 bits of KEY0. (RO)

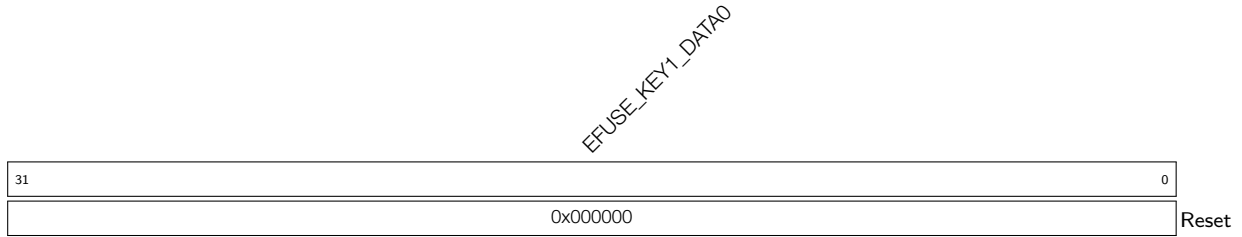
Register 5.48. EFUSE_RD_KEY1_DATA0_REG (0x00BC)

EFUSE_KEY1_DATA0 Represents the first 32 bits of KEY1. (RO)

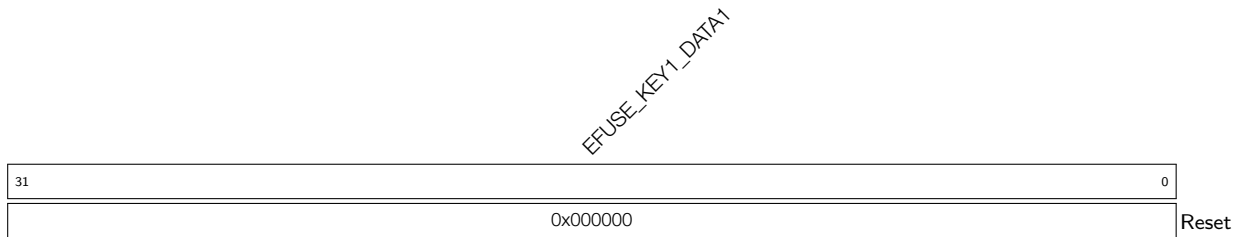
Register 5.49. EFUSE_RD_KEY1_DATA1_REG (0x00C0)

EFUSE_KEY1_DATA1 Represents the second 32 bits of KEY1. (RO)

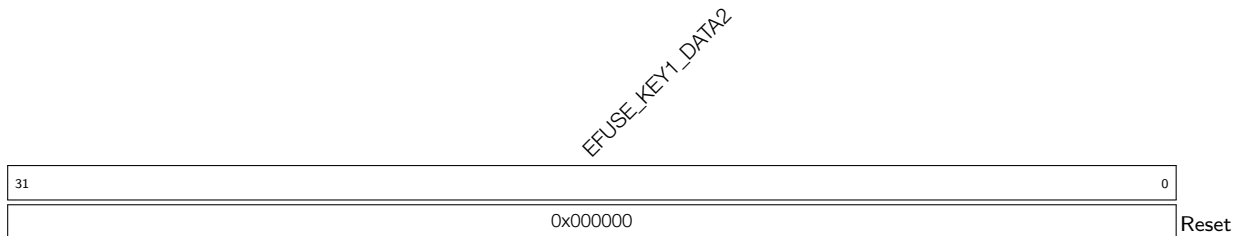
Register 5.50. EFUSE_RD_KEY1_DATA2_REG (0x00C4)

EFUSE_KEY1_DATA2 Represents the third 32 bits of KEY1. (RO)

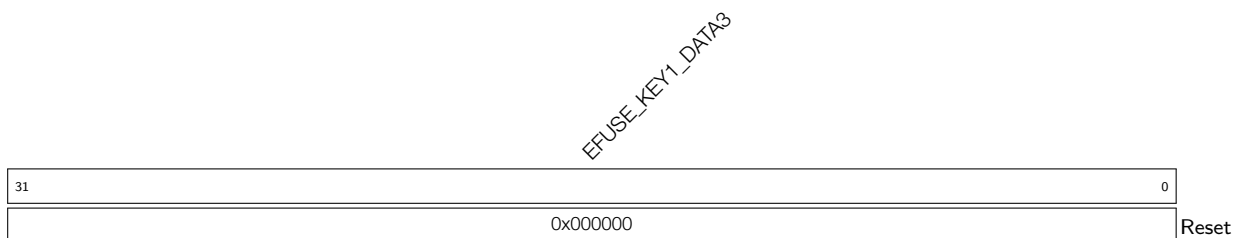
Register 5.51. EFUSE_RD_KEY1_DATA3_REG (0x00C8)

EFUSE_KEY1_DATA3 Represents the fourth 32 bits of KEY1. (RO)

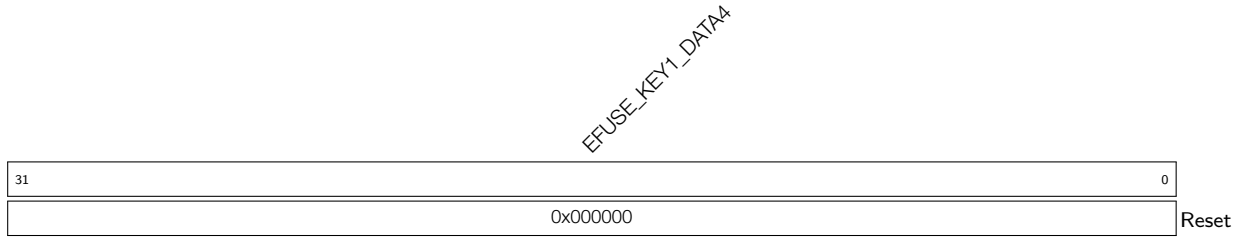
Register 5.52. EFUSE_RD_KEY1_DATA4_REG (0x00CC)

EFUSE_KEY1_DATA4 Represents the fifth 32 bits of KEY1. (RO)

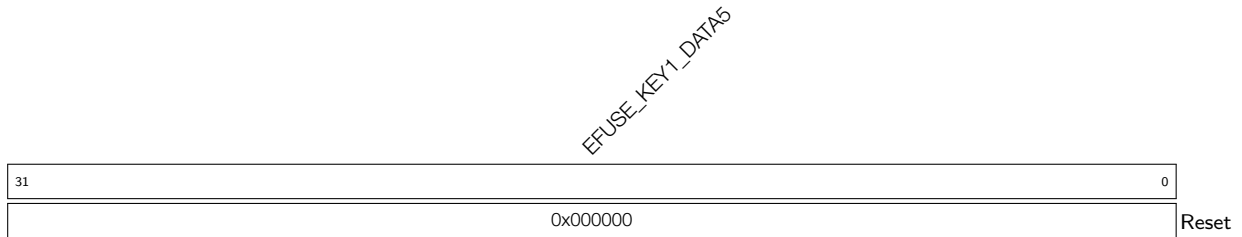
Register 5.53. EFUSE_RD_KEY1_DATA5_REG (0x00D0)

EFUSE_KEY1_DATA5 Represents the sixth 32 bits of KEY1. (RO)

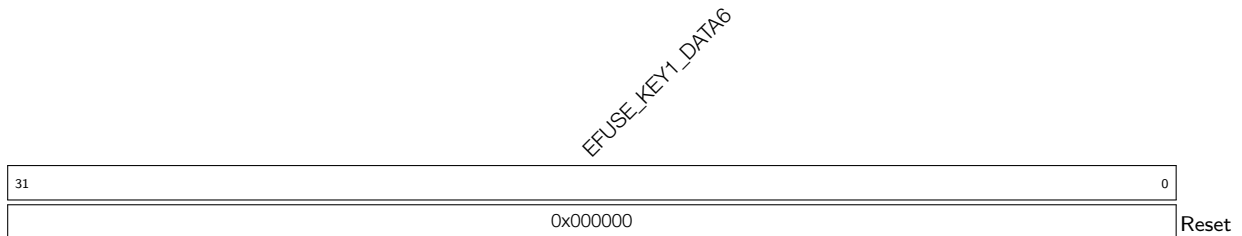
Register 5.54. EFUSE_RD_KEY1_DATA6_REG (0x00D4)

EFUSE_KEY1_DATA6 Represents the seventh 32 bits of KEY1. (RO)

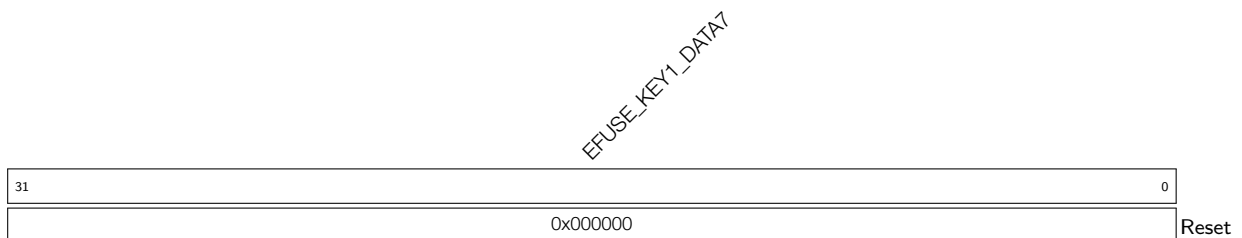
Register 5.55. EFUSE_RD_KEY1_DATA7_REG (0x00D8)

EFUSE_KEY1_DATA7 Represents the eighth 32 bits of KEY1. (RO)

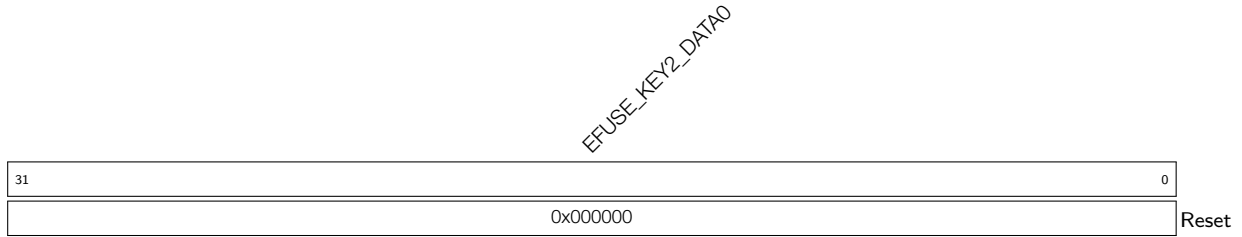
Register 5.56. EFUSE_RD_KEY2_DATA0_REG (0x00DC)

EFUSE_KEY2_DATA0 Represents the first 32 bits of KEY2. (RO)

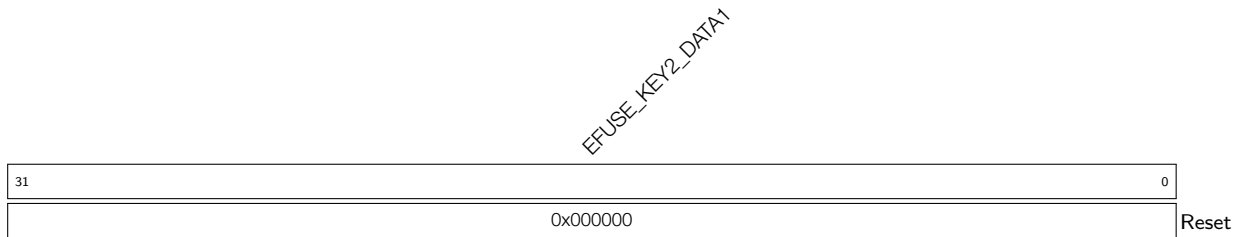
Register 5.57. EFUSE_RD_KEY2_DATA1_REG (0x00E0)

EFUSE_KEY2_DATA1 Represents the second 32 bits of KEY2. (RO)

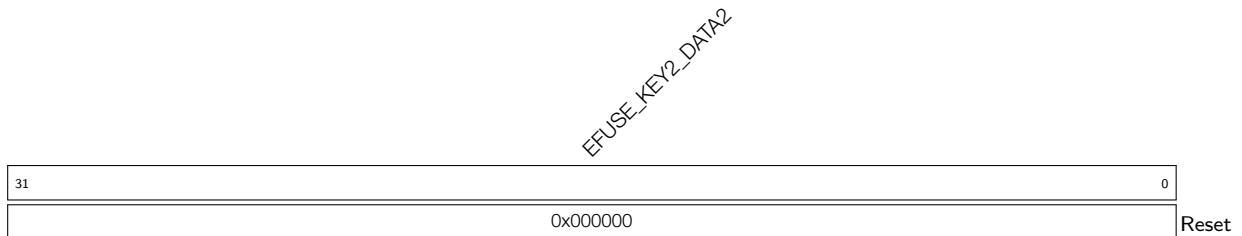
Register 5.58. EFUSE_RD_KEY2_DATA2_REG (0x00E4)

EFUSE_KEY2_DATA2 Represents the third 32 bits of KEY2. (RO)

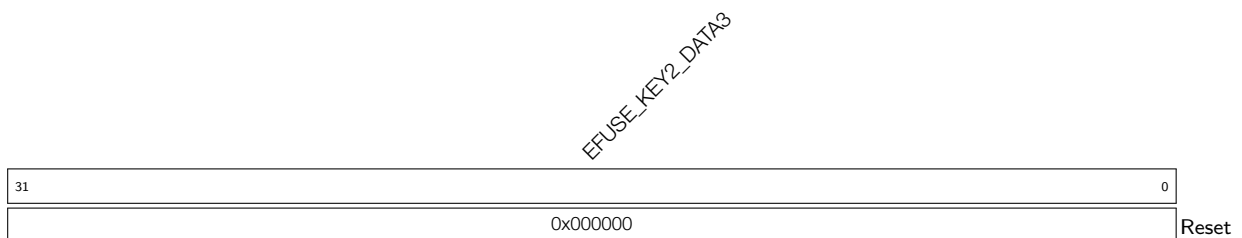
Register 5.59. EFUSE_RD_KEY2_DATA3_REG (0x00E8)

EFUSE_KEY2_DATA3 Represents the fourth 32 bits of KEY2. (RO)

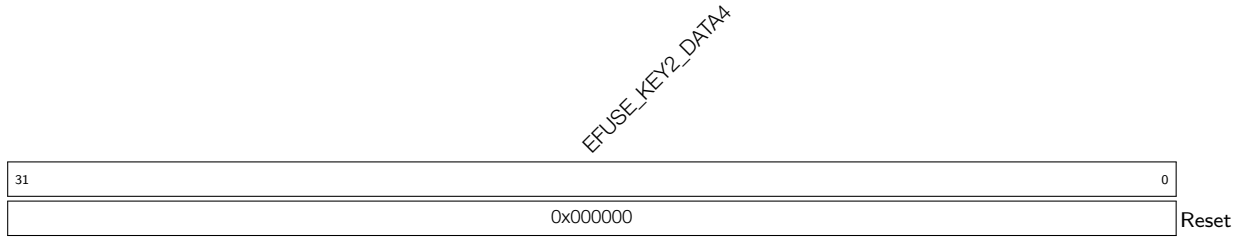
Register 5.60. EFUSE_RD_KEY2_DATA4_REG (0x00EC)

EFUSE_KEY2_DATA4 Represents the fifth 32 bits of KEY2. (RO)

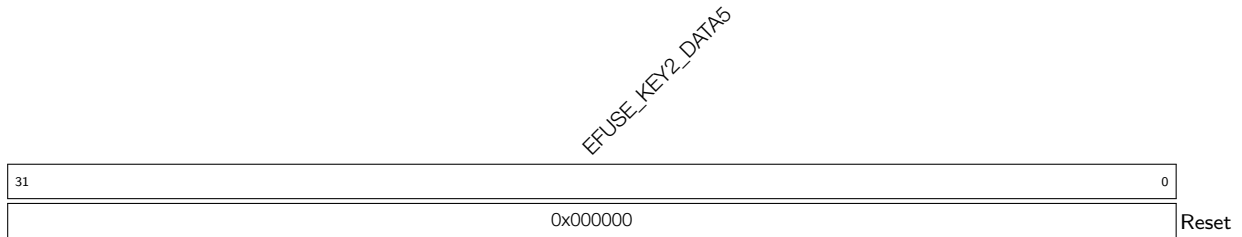
Register 5.61. EFUSE_RD_KEY2_DATA5_REG (0x00F0)

EFUSE_KEY2_DATA5 Represents the sixth 32 bits of KEY2. (RO)

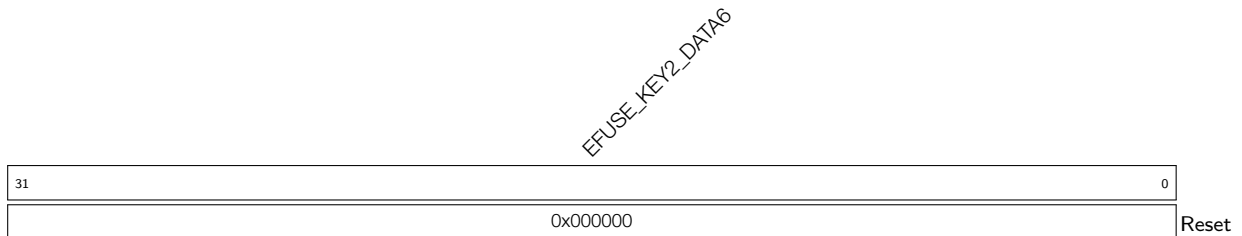
Register 5.62. EFUSE_RD_KEY2_DATA6_REG (0x00F4)

EFUSE_KEY2_DATA6 Represents the seventh 32 bits of KEY2. (RO)

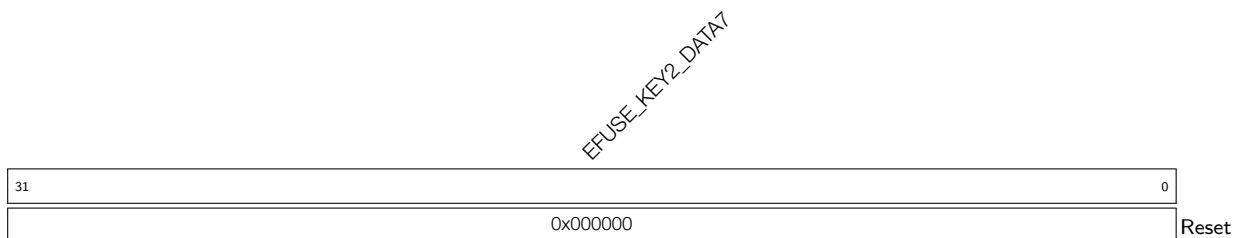
Register 5.63. EFUSE_RD_KEY2_DATA7_REG (0x00F8)

EFUSE_KEY2_DATA7 Represents the eighth 32 bits of KEY2. (RO)

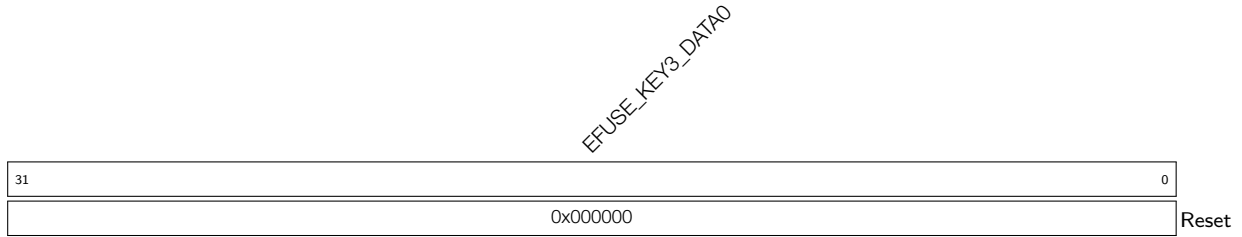
Register 5.64. EFUSE_RD_KEY3_DATA0_REG (0x00FC)

EFUSE_KEY3_DATA0 Represents the first 32 bits of KEY3. (RO)

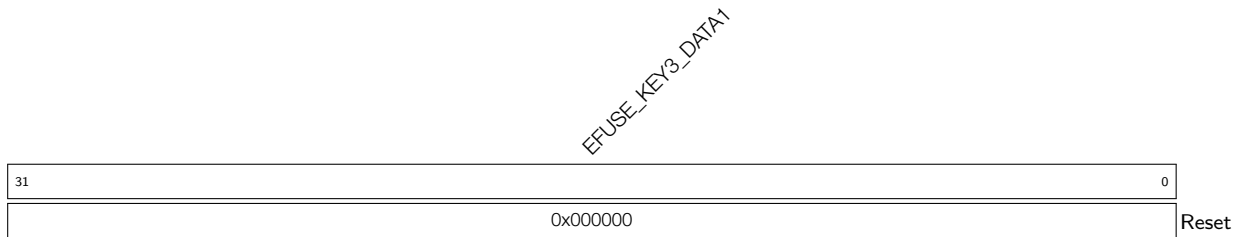
Register 5.65. EFUSE_RD_KEY3_DATA1_REG (0x0100)

EFUSE_KEY3_DATA1 Represents the second 32 bits of KEY3. (RO)

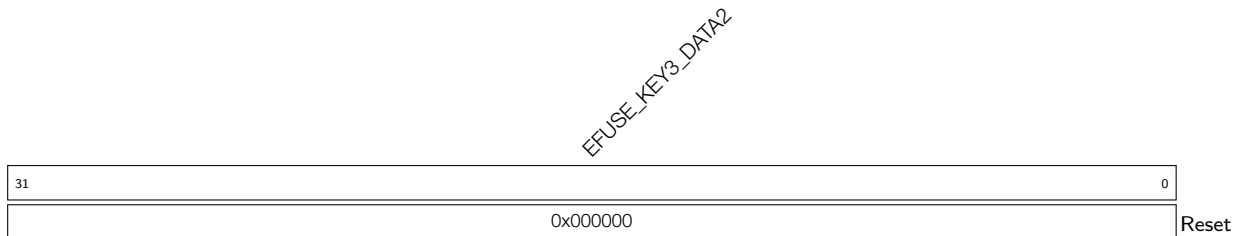
Register 5.66. EFUSE_RD_KEY3_DATA2_REG (0x0104)

EFUSE_KEY3_DATA2 Represents the third 32 bits of KEY3. (RO)

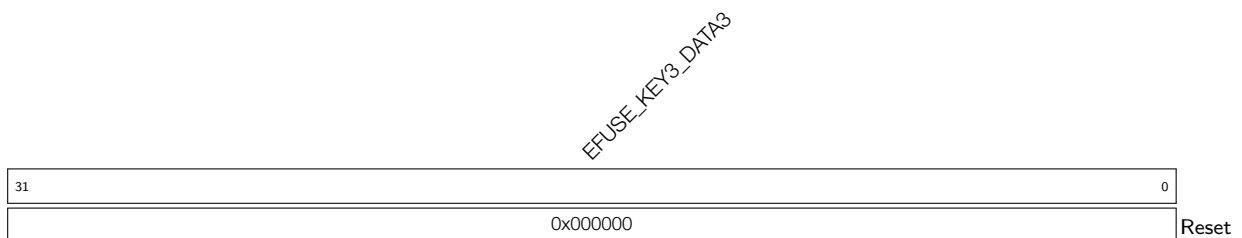
Register 5.67. EFUSE_RD_KEY3_DATA3_REG (0x0108)

EFUSE_KEY3_DATA3 Represents the fourth 32 bits of KEY3. (RO)

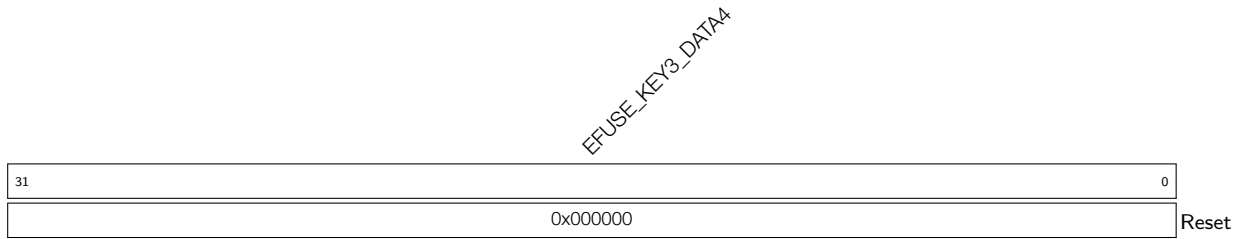
Register 5.68. EFUSE_RD_KEY3_DATA4_REG (0x010C)

EFUSE_KEY3_DATA4 Represents the fifth 32 bits of KEY3. (RO)

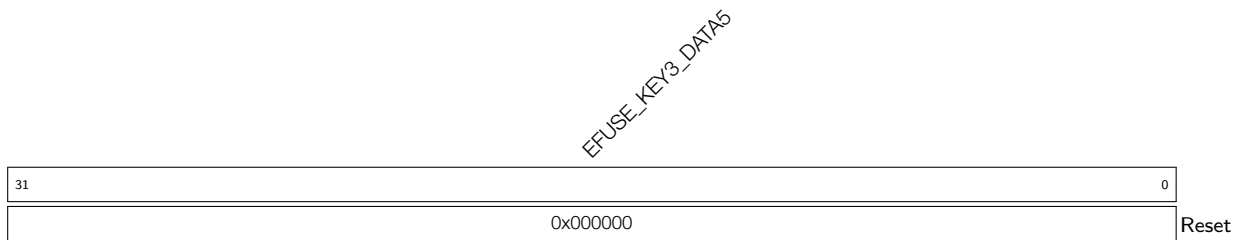
Register 5.69. EFUSE_RD_KEY3_DATA5_REG (0x0110)

EFUSE_KEY3_DATA5 Represents the sixth 32 bits of KEY3. (RO)

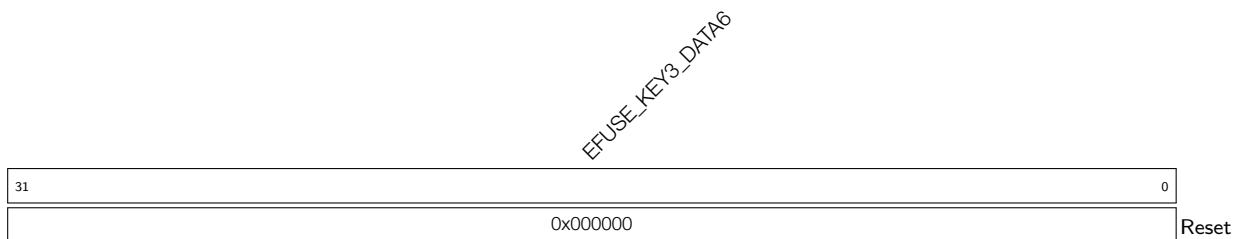
Register 5.70. EFUSE_RD_KEY3_DATA6_REG (0x0114)

EFUSE_KEY3_DATA6 Represents the seventh 32 bits of KEY3. (RO)

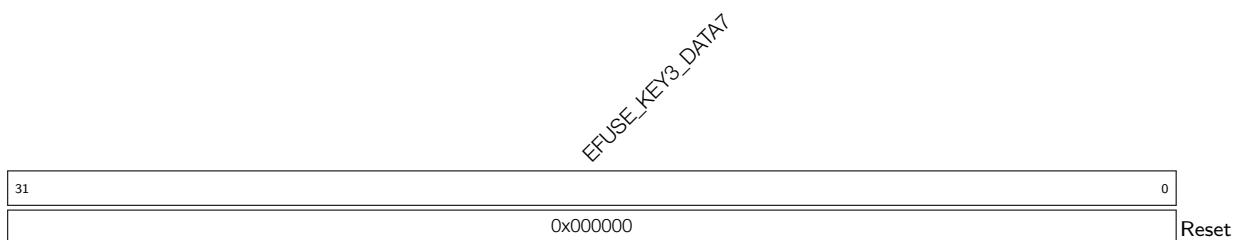
Register 5.71. EFUSE_RD_KEY3_DATA7_REG (0x0118)

EFUSE_KEY3_DATA7 Represents the eighth 32 bits of KEY3. (RO)

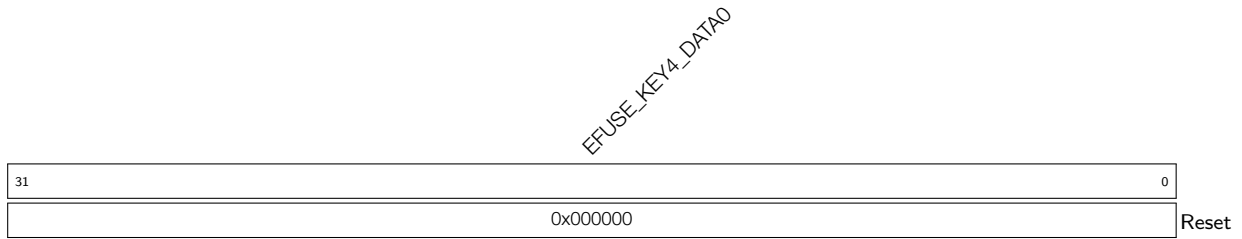
Register 5.72. EFUSE_RD_KEY4_DATA0_REG (0x011C)

EFUSE_KEY4_DATA0 Represents the first 32 bits of KEY4. (RO)

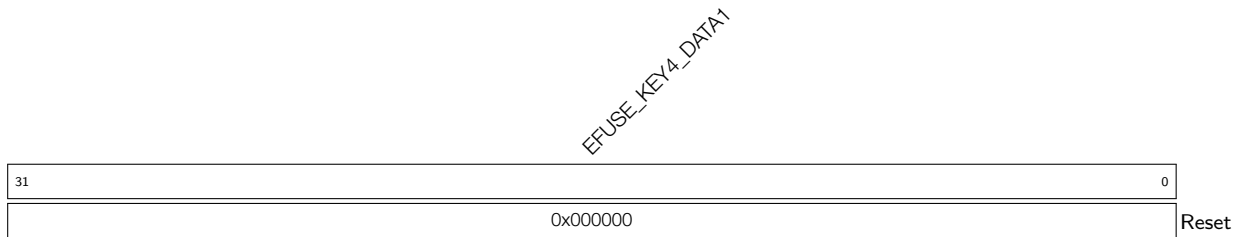
Register 5.73. EFUSE_RD_KEY4_DATA1_REG (0x0120)

EFUSE_KEY4_DATA1 Represents the second 32 bits of KEY4. (RO)

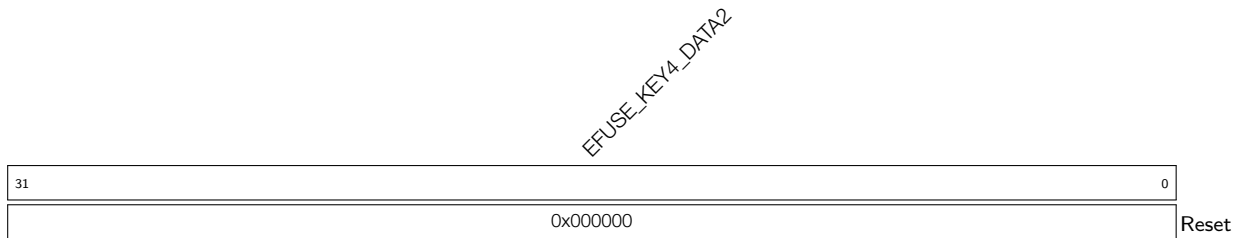
Register 5.74. EFUSE_RD_KEY4_DATA2_REG (0x0124)

EFUSE_KEY4_DATA2 Represents the third 32 bits of KEY4. (RO)

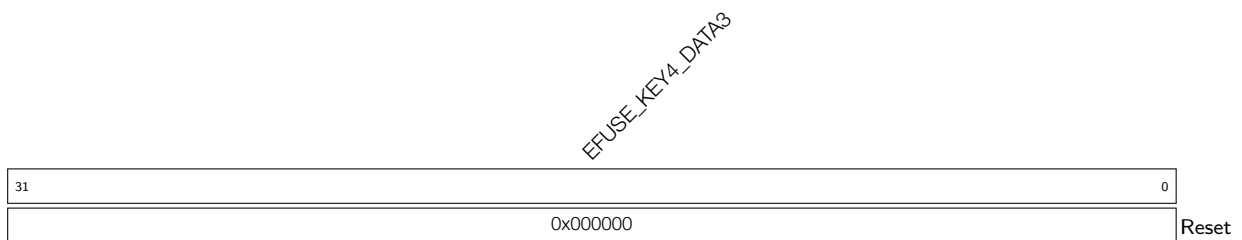
Register 5.75. EFUSE_RD_KEY4_DATA3_REG (0x0128)

EFUSE_KEY4_DATA3 Represents the fourth 32 bits of KEY4. (RO)

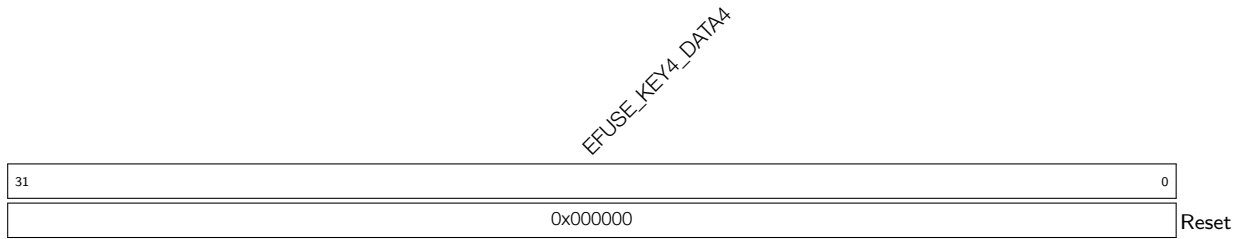
Register 5.76. EFUSE_RD_KEY4_DATA4_REG (0x012C)

EFUSE_KEY4_DATA4 Represents the fifth 32 bits of KEY4. (RO)

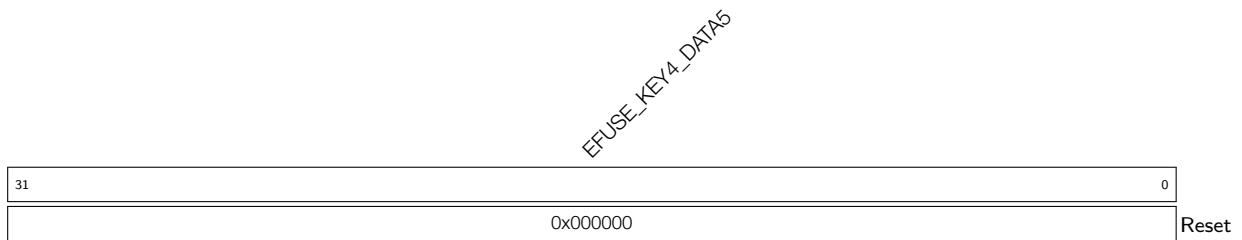
Register 5.77. EFUSE_RD_KEY4_DATA5_REG (0x0130)

EFUSE_KEY4_DATA5 Represents the sixth 32 bits of KEY4. (RO)

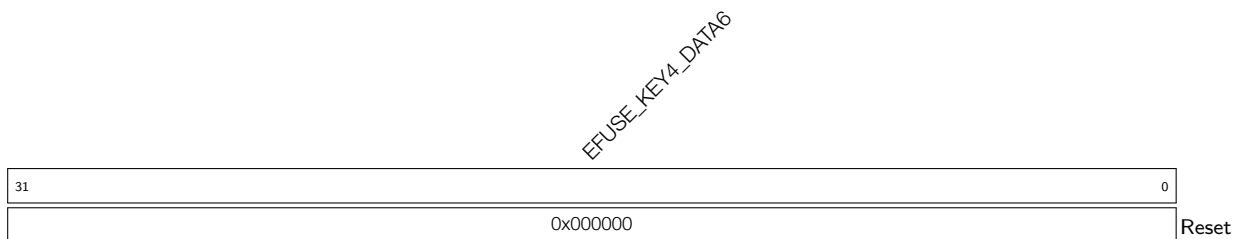
Register 5.78. EFUSE_RD_KEY4_DATA6_REG (0x0134)

EFUSE_KEY4_DATA6 Represents the seventh 32 bits of KEY4. (RO)

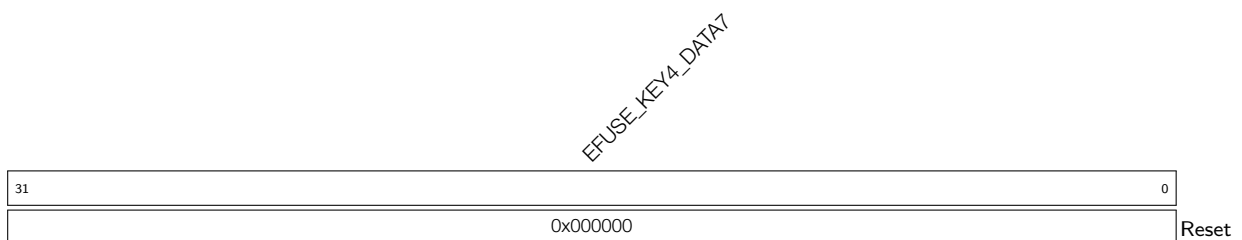
Register 5.79. EFUSE_RD_KEY4_DATA7_REG (0x0138)

EFUSE_KEY4_DATA7 Represents the eighth 32 bits of KEY4. (RO)

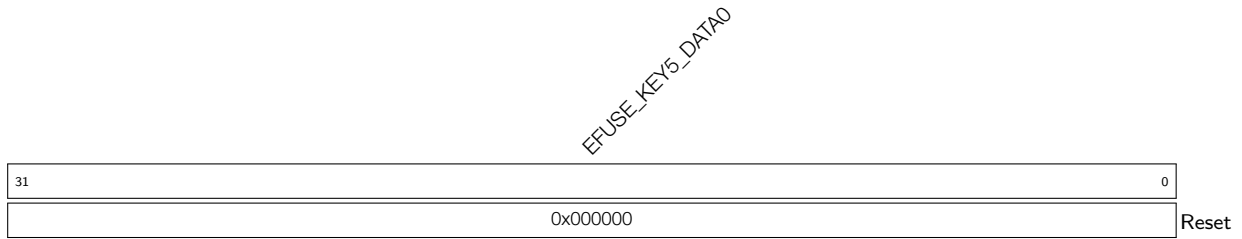
Register 5.80. EFUSE_RD_KEY5_DATA0_REG (0x013C)

EFUSE_KEY5_DATA0 Represents the first 32 bits of KEY5. (RO)

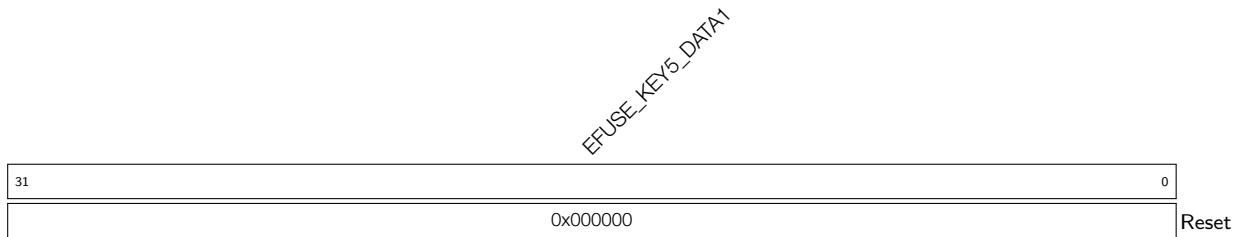
Register 5.81. EFUSE_RD_KEY5_DATA1_REG (0x0140)

EFUSE_KEY5_DATA1 Represents the second 32 bits of KEY5. (RO)

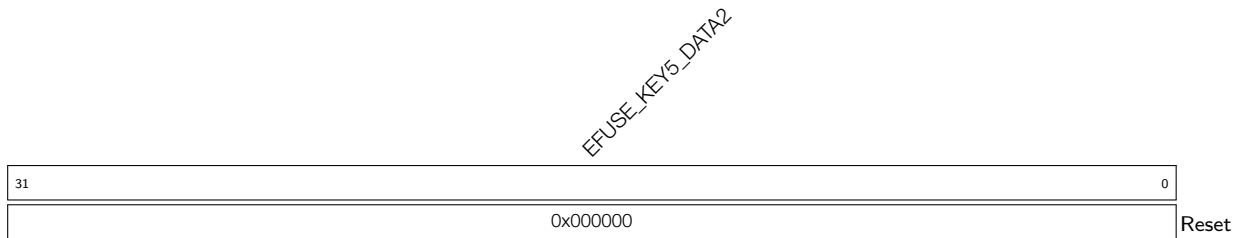
Register 5.82. EFUSE_RD_KEY5_DATA2_REG (0x0144)

EFUSE_KEY5_DATA2 Represents the third 32 bits of KEY5. (RO)

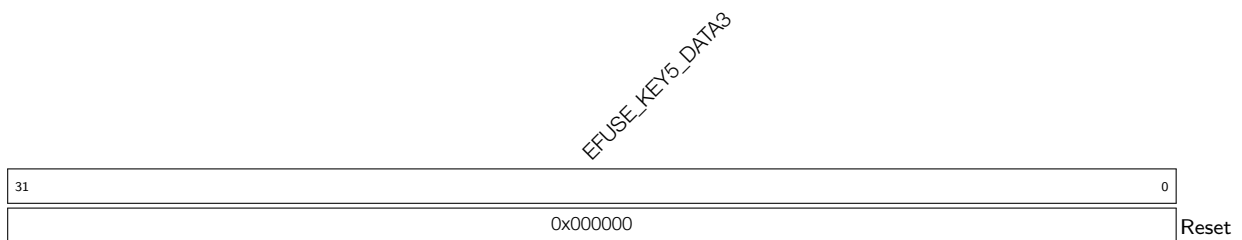
Register 5.83. EFUSE_RD_KEY5_DATA3_REG (0x0148)

EFUSE_KEY5_DATA3 Represents the fourth 32 bits of KEY5. (RO)

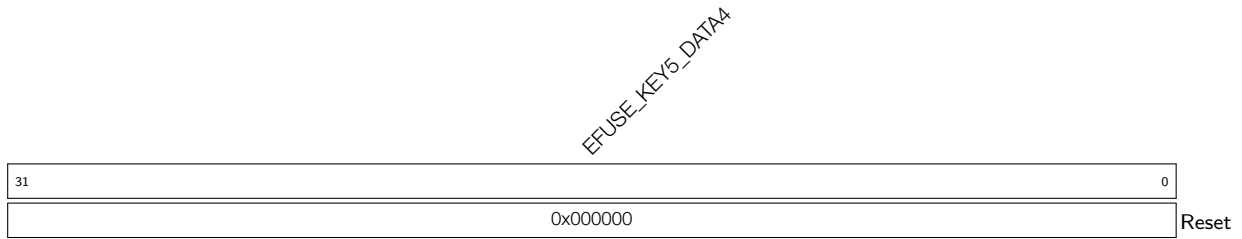
Register 5.84. EFUSE_RD_KEY5_DATA4_REG (0x014C)

EFUSE_KEY5_DATA4 Represents the fifth 32 bits of KEY5. (RO)

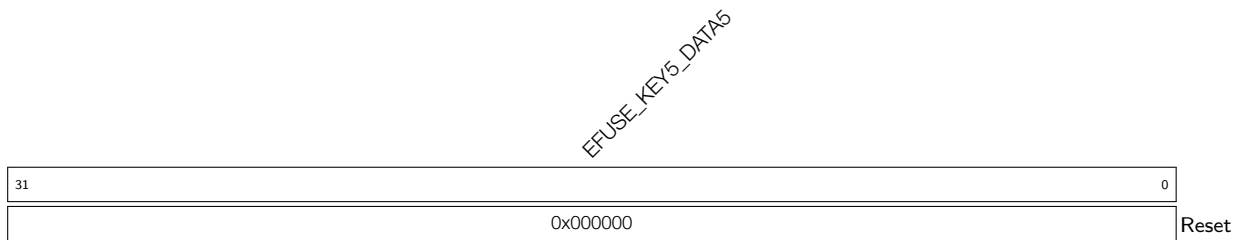
Register 5.85. EFUSE_RD_KEY5_DATA5_REG (0x0150)

EFUSE_KEY5_DATA5 Represents the sixth 32 bits of KEY5. (RO)

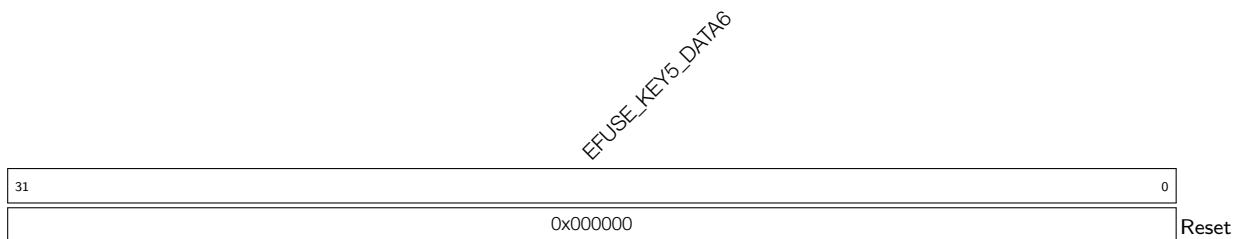
Register 5.86. EFUSE_RD_KEY5_DATA6_REG (0x0154)

EFUSE_KEY5_DATA6 Represents the seventh 32 bits of KEY5. (RO)

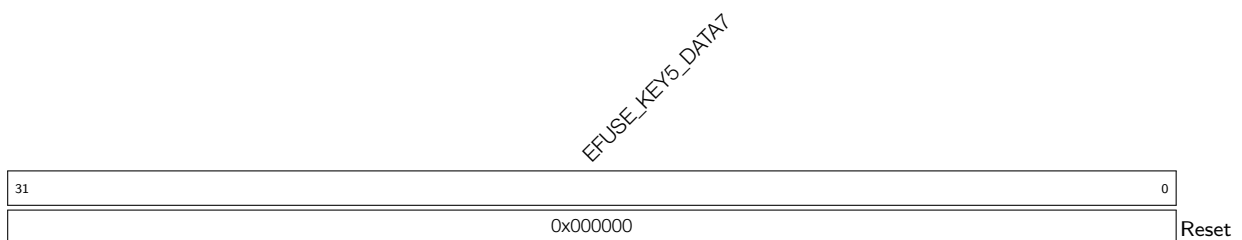
Register 5.87. EFUSE_RD_KEY5_DATA7_REG (0x0158)

EFUSE_KEY5_DATA7 Represents the eighth 32 bits of KEY5. (RO)

Register 5.88. EFUSE_RD_SYS_PART2_DATA0_REG (0x015C)

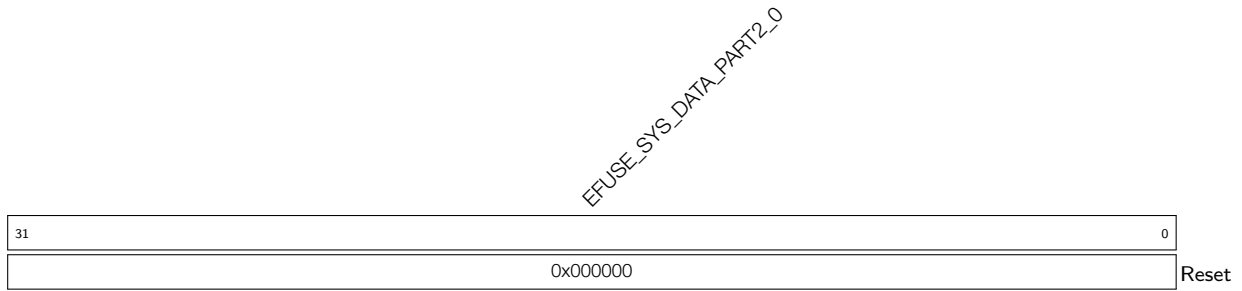

EFUSE_SYS_DATA_PART2_0 Represents the first 32 bits of the third part of system data. (RO)

Register 5.89. EFUSE_RD_SYS_PART2_DATA1_REG (0x0160)

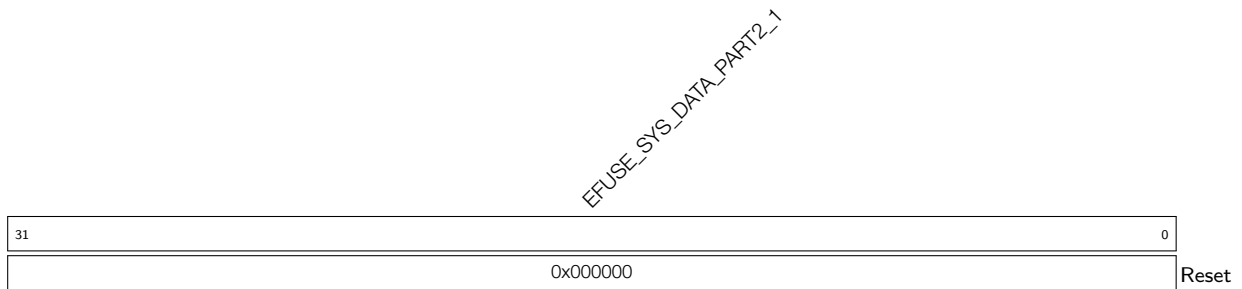

EFUSE_SYS_DATA_PART2_1 Represents the second 32 bits of the third part of system data. (RO)

Register 5.90. EFUSE_RD_SYS_PART2_DATA2_REG (0x0164)

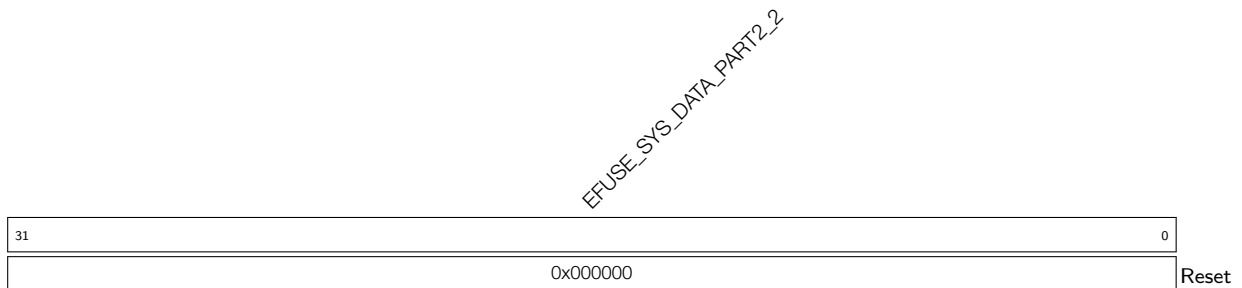

EFUSE_SYS_DATA_PART2_2 Represents the third 32 bits of the third part of system data. (RO)

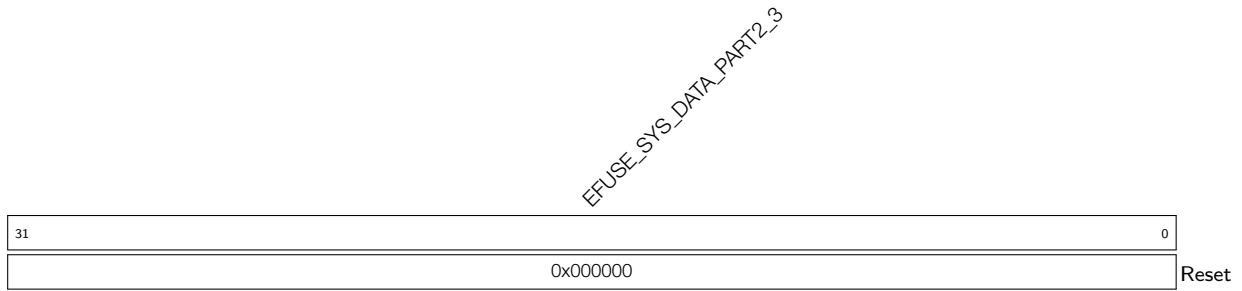
Register 5.91. EFUSE_RD_SYS_PART2_DATA3_REG (0x0168)

EFUSE_SYS_DATA_PART2_3 Represents the fourth 32 bits of the third part of system data. (RO)

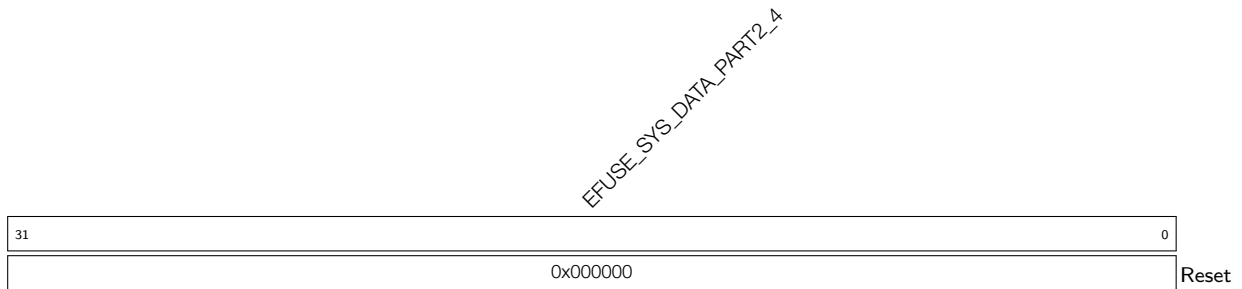
Register 5.92. EFUSE_RD_SYS_PART2_DATA4_REG (0x016C)

EFUSE_SYS_DATA_PART2_4 Represents the fifth 32 bits of the third part of system data. (RO)

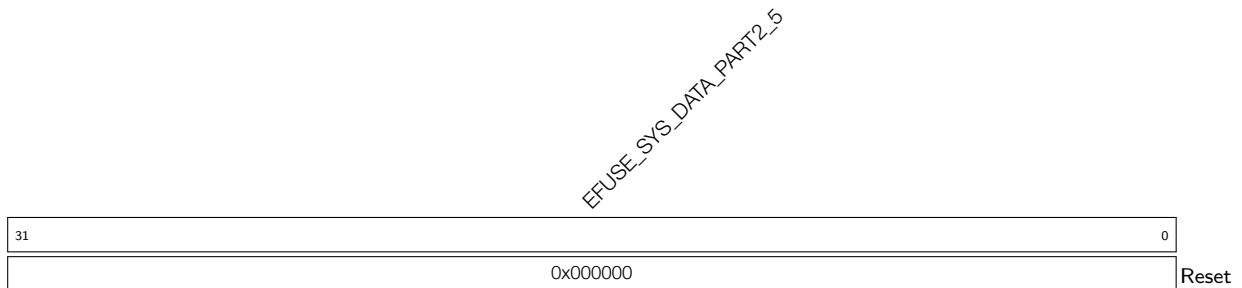
Register 5.93. EFUSE_RD_SYS_PART2_DATA5_REG (0x0170)

EFUSE_SYS_DATA_PART2_5 Represents the sixth 32 bits of the third part of system data. (RO)

Register 5.94. EFUSE_RD_SYS_PART2_DATA6_REG (0x0174)

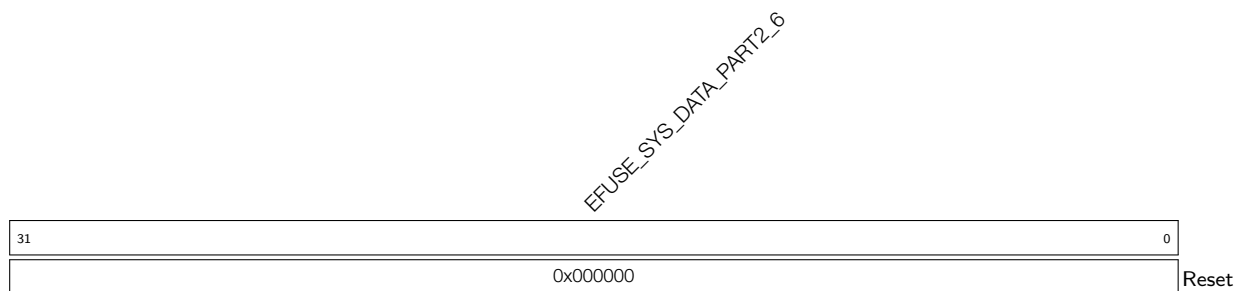

EFUSE_SYS_DATA_PART2_6 Represents the seventh 32 bits of the third part of system data. (RO)

Register 5.95. EFUSE_RD_SYS_PART2_DATA7_REG (0x0178)



EFUSE_SYS_DATA_PART2_7 Represents the eighth 32 bits of the third part of system data. (RO)

Register 5.96. EFUSE_RD_REPEAT_ERR0_REG (0x017C)

(reserved)				EFUSE_EXT_PHY_ENABLE_ERR				EFUSE_USB_EXCHG_PINS_ERR				(reserved)				EFUSE_DIS_DOWNLOAD_MANUAL_ENCRYPT_ERR				EFUSE_DIS_DOWNLOAD_PAD_JTAG_ERR				EFUSE_SOFT_DIS_JTAG_ERR				EFUSE_DIS_APP_CPU_ERR				EFUSE_DIS_TWAI_ERR				EFUSE_DIS_USB_ERR				EFUSE_DIS_FORCE_DOWNLOAD_ERR				EFUSE_DIS_DOWNLOAD_DCACHE_ERR				EFUSE_DIS_ICACHE_ERR				EFUSE_DIS_RTC_RAM_BOOT_ERR				EFUSE_RD_DIS_ERR			
31	27	26	25	24	21	20	19	18	16	15	14	13	12	11	10	9	8	7	6													0																											
0	0	0	0	0	0	0	0	0	0	0	0	0	0	0	0	0	0	0	0	0	0x0												0																										

Reset

EFUSE_RD_DIS_ERR Represents a programming error to corresponding eFuse bit if any bit in this field is 1. (RO)

EFUSE_DIS_RTC_RAM_BOOT_ERR Represents a programming error to corresponding eFuse bit if any bit in this field is 1. (RO)

EFUSE_DIS_ICACHE_ERR Represents a programming error to corresponding eFuse bit if any bit in this field is 1. (RO)

EFUSE_DIS_DCACHE_ERR Represents a programming error to corresponding eFuse bit if any bit in this field is 1. (RO)

EFUSE_DIS_DOWNLOAD_ICACHE_ERR Represents a programming error to corresponding eFuse bit if any bit in this field is 1. (RO)

EFUSE_DIS_DOWNLOAD_DCACHE_ERR Represents a programming error to corresponding eFuse bit if any bit in this field is 1. (RO)

EFUSE_DIS_FORCE_DOWNLOAD_ERR Represents a programming error to corresponding eFuse bit if any bit in this field is 1. (RO)

EFUSE_DIS_USB_OTG_ERR Represents a programming error to corresponding eFuse bit if any bit in this field is 1. (RO)

EFUSE_DIS_TWAI_ERR Represents a programming error to corresponding eFuse bit if any bit in this field is 1. (RO)

EFUSE_DIS_APP_CPU_ERR Represents a programming error to corresponding eFuse bit if any bit in this field is 1. (RO)

EFUSE_SOFT_DIS_JTAG_ERR Represents a programming error to corresponding eFuse bit if any bit in this field is 1. (RO)

EFUSE_DIS_PAD_JTAG_ERR Represents a programming error to corresponding eFuse bit if any bit in this field is 1. (RO)

Continued on the next page...

Register 5.96. EFUSE_RD_REPEAT_ERR0_REG (0x017C)

Continued from the previous page...

EFUSE_DIS_DOWNLOAD_MANUAL_ENCRYPT_ERR Represents a programming error to corresponding eFuse bit if any bit in this field is 1. (RO)

EFUSE_USB_EXCHG_PINS_ERR Represents a programming error to corresponding eFuse bit if any bit in this field is 1. (RO)

EFUSE_EXT_PHY_ENABLE_ERR Represents a programming error to corresponding eFuse bit if any bit in this field is 1. (RO)

Register 5.97. EFUSE_RD_REPEAT_ERR1_REG (0x0180)

EFUSE_KEY_PURPOSE_1_ERR		EFUSE_KEY_PURPOSE_0_ERR		EFUSE_SECURE_BOOT_KEY_REVOKE2_ERR		EFUSE_SECURE_BOOT_KEY_REVOKE1_ERR		EFUSE_SECURE_BOOT_KEY_REVOKE0_ERR		EFUSE_SPI_BOOT_CRYPT_CNT_ERR		EFUSE_WDT_DELAY_SEL_ERR		(reserved)		EFUSE_VDD_SPI_FORCE_ERR		EFUSE_VDD_SPI_TIEH_ERR		EFUSE_VDD_SPI_XPD_ERR		(reserved)			
31	28	27	24	23	22	21	20	18	17	16	15	7	6	5	4	3	0								
0x0		0x0		0	0	0	0x0		0x0		0	0	0	0	0	0	0	0	0	0	0	0	0	0	Reset

EFUSE_VDD_SPI_XPD_ERR Represents a programming error to corresponding eFuse bit if any bit in this field is 1. (RO)

EFUSE_VDD_SPI_TIEH_ERR Represents a programming error to corresponding eFuse bit if any bit in this field is 1. (RO)

EFUSE_VDD_SPI_FORCE_ERR Represents a programming error to corresponding eFuse bit if any bit in this field is 1. (RO)

EFUSE_WDT_DELAY_SEL_ERR Represents a programming error to corresponding eFuse bit if any bit in this field is 1. (RO)

EFUSE_SPI_BOOT_CRYPT_CNT_ERR Represents a programming error to corresponding eFuse bit if any bit in this field is 1. (RO)

EFUSE_SECURE_BOOT_KEY_REVOKE0_ERR Represents a programming error to corresponding eFuse bit if any bit in this field is 1. (RO)

EFUSE_SECURE_BOOT_KEY_REVOKE1_ERR Represents a programming error to corresponding eFuse bit if any bit in this field is 1. (RO)

EFUSE_SECURE_BOOT_KEY_REVOKE2_ERR Represents a programming error to corresponding eFuse bit if any bit in this field is 1. (RO)

EFUSE_KEY_PURPOSE_0_ERR Represents a programming error to corresponding eFuse bit if any bit in this field is 1. (RO)

EFUSE_KEY_PURPOSE_1_ERR Represents a programming error to corresponding eFuse bit if any bit in this field is 1. (RO)

Register 5.98. EFUSE_RD_REPEAT_ERR2_REG (0x0184)

		EFUSE_FLASH_TPUW_ERR		(reserved)		EFUSE_USB_PHY_SEL_ERR		EFUSE_STRAP_JTAG_SEL_ERR		EFUSE_DIS_USB_SERIAL_JTAG_ERR		EFUSE_DIS_USB_JTAG_ERR		EFUSE_SECURE_BOOT_AGGRESSIVE_REVOKE_ERR		EFUSE_RPT4_RESERVED0_ERR		EFUSE_KEY_PURPOSE_5_ERR		EFUSE_KEY_PURPOSE_4_ERR		EFUSE_KEY_PURPOSE_3_ERR		EFUSE_KEY_PURPOSE_2_ERR	
31	28	27	26	25	24	23	22	21	20	19	16	15	12	11	8	7	4	3	0						
0x0		0x0		0	0	0	0x0	0	0	0x0		0x0		0x0		0x0		0x0		0x0		0x0		Reset	

EFUSE_KEY_PURPOSE_2_ERR Represents a programming error to corresponding eFuse bit if any bit in this field is 1. (RO)

EFUSE_KEY_PURPOSE_3_ERR Represents a programming error to corresponding eFuse bit if any bit in this field is 1. (RO)

EFUSE_KEY_PURPOSE_4_ERR Represents a programming error to corresponding eFuse bit if any bit in this field is 1. (RO)

EFUSE_KEY_PURPOSE_5_ERR Represents a programming error to corresponding eFuse bit if any bit in this field is 1. (RO)

EFUSE_RPT4_RESERVED0_ERR Represents a programming error to corresponding eFuse bit if any bit in this field is 1. (RO)

EFUSE_SECURE_BOOT_EN_ERR Represents a programming error to corresponding eFuse bit if any bit in this field is 1. (RO)

EFUSE_SECURE_BOOT_AGGRESSIVE_REVOKE_ERR Represents a programming error to corresponding eFuse bit if any bit in this field is 1. (RO)

EFUSE_DIS_USB_JTAG_ERR Represents a programming error to corresponding eFuse bit if any bit in this field is 1. (RO)

EFUSE_DIS_USB_SERIAL_JTAG_ERR Represents a programming error to corresponding eFuse bit if any bit in this field is 1. (RO)

EFUSE_STRAP_JTAG_SEL_ERR Represents a programming error to corresponding eFuse bit if any bit in this field is 1. (RO)

EFUSE_USB_PHY_SEL_ERR Represents a programming error to corresponding eFuse bit if any bit in this field is 1. (RO)

EFUSE_FLASH_TPUW_ERR Represents a programming error to corresponding eFuse bit if any bit in this field is 1. (RO)

Register 5.99. EFUSE_RD_REPEAT_ERR3_REG (0x0188)

<i>EFUSE_DIS_USB_OTG_DOWNLOAD_MODE_ERR (reserved)</i>															<i>EFUSE_SECURE_VERSION_ERR</i>			<i>EFUSE_FORCE_SEND_RESUME_ERR EFUSE_FLASH_ECC_EN_ERR EFUSE_FLASH_PAGE_SIZE_ERR EFUSE_FLASH_TYPE_ERR EFUSE_PIN_POWER_SELECTION_ERR EFUSE_UART_PRINT_SELECTION_ERR EFUSE_ENABLE_SECURITY_DOWNLOAD_ERR EFUSE_DIS_USB_SERIAL_JTAG_DOWNLOAD_ERR EFUSE_FLASH_ECC_MODE_ERR EFUSE_DIS_USB_PRINT_ERR EFUSE_DIS_LEGACY_SPI_BOOT_ERR EFUSE_DIS_DOWNLOAD_MODE_ERR</i>											
31	30	29												14	13	12	11	10	9	8	7	6	5	4	3	2	1	0	
0	0	0x00											0	0	0x0	0	0	0x0	0	0	0	0	0	0	0	0	0	0	0

Reset

EFUSE_DIS_DOWNLOAD_MODE_ERR Represents a programming error to corresponding eFuse bit if any bit in this field is 1. (RO)

EFUSE_DIS_LEGACY_SPI_BOOT_ERR Represents a programming error to corresponding eFuse bit if any bit in this field is 1. (RO)

EFUSE_DIS_USB_PRINT_ERR Represents a programming error to corresponding eFuse bit if any bit in this field is 1. (RO)

EFUSE_FLASH_ECC_MODE_ERR Represents a programming error to corresponding eFuse bit if any bit in this field is 1. (RO)

EFUSE_DIS_USB_SERIAL_JTAG_DOWNLOAD_MODE_ERR Represents a programming error to corresponding eFuse bit if any bit in this field is 1. (RO)

EFUSE_ENABLE_SECURITY_DOWNLOAD_ERR Represents a programming error to corresponding eFuse bit if any bit in this field is 1. (RO)

EFUSE_UART_PRINT_CONTROL_ERR Represents a programming error to corresponding eFuse bit if any bit in this field is 1. (RO)

EFUSE_PIN_POWER_SELECTION_ERR Represents a programming error to corresponding eFuse bit if any bit in this field is 1. (RO)

EFUSE_FLASH_TYPE_ERR Represents a programming error to corresponding eFuse bit if any bit in this field is 1. (RO)

EFUSE_FLASH_PAGE_SIZE_ERR Represents a programming error to corresponding eFuse bit if any bit in this field is 1. (RO)

EFUSE_FLASH_ECC_EN_ERR Represents a programming error to corresponding eFuse bit if any bit in this field is 1. (RO)

EFUSE_FORCE_SEND_RESUME_ERR Represents a programming error to corresponding eFuse bit if any bit in this field is 1. (RO)

Continued on the next page...

Register 5.99. EFUSE_RD_REPEAT_ERR3_REG (0x0188)

Continued from the previous page...

EFUSE_SECURE_VERSION_ERR Represents a programming error to corresponding eFuse bit if any bit in this field is 1. (RO)

EFUSE_DIS_USB_OTG_DOWNLOAD_MODE_ERR Represents a programming error to corresponding eFuse bit if any bit in this field is 1. (RO)

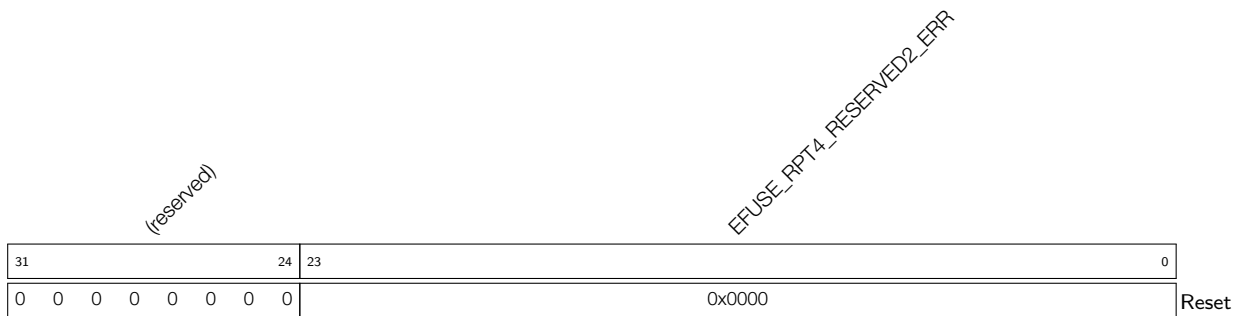
Register 5.100. EFUSE_RD_REPEAT_ERR4_REG (0x018C)

EFUSE_RPT4_RESERVED2_ERR Represents a programming error to corresponding eFuse bit if any bit in this field is 1. (RO)

Register 5.101. EFUSE_RD_RS_ERR0_REG (0x01C0)

<i>EFUSE_KEY4_FAIL</i>			<i>EFUSE_KEY4_ERR_NUM</i>			<i>EFUSE_KEY3_FAIL</i>			<i>EFUSE_KEY3_ERR_NUM</i>			<i>EFUSE_KEY2_FAIL</i>			<i>EFUSE_KEY2_ERR_NUM</i>			<i>EFUSE_KEY1_FAIL</i>			<i>EFUSE_KEY1_ERR_NUM</i>			<i>EFUSE_KEY0_FAIL</i>			<i>EFUSE_KEY0_ERR_NUM</i>			<i>EFUSE_USR_DATA_FAIL</i>			<i>EFUSE_USR_DATA_ERR_NUM</i>			<i>EFUSE_SYS_PART1_FAIL</i>			<i>EFUSE_SYS_PART1_NUM</i>			<i>EFUSE_MAC_SPI_8M_FAIL</i>			<i>EFUSE_MAC_SPI_8M_ERR_NUM</i>		
3	30	28	31	26	24	27	22	20	23	18	16	19	14	12	15	10	8	11	6	4	3	2	0																								
0	0x0	0	0x0	0	0x0	0	0x0	0	0x0	0	0x0	0	0x0	0	0x0	0	0x0	0	0x0	0	0x0	0	0x0	Reset																							

EFUSE_MAC_SPI_8M_ERR_NUM Represents the number of error bytes during programming MAC_SPI_8M. (RO)

EFUSE_MAC_SPI_8M_FAIL Represents whether or not the data is reliable. 0: Means no failure and that the data of MAC_SPI_8M is reliable. 1: Means that programming data of MAC_SPI_8M has failed and the number of error bytes is over 6. (RO)

EFUSE_SYS_PART1_NUM Represents the number of error bytes during programming system part1. (RO)

EFUSE_SYS_PART1_FAIL Represents whether or not the data is reliable. 0: Means no failure and that the data of system part1 is reliable. 1: Means that programming data of system part1 failed and the number of error bytes is over 6. (RO)

EFUSE_USR_DATA_ERR_NUM Represents the number of error bytes during programming user data. (RO)

EFUSE_USR_DATA_FAIL Represents whether or not the data is reliable. 0: Means no failure and that the user data is reliable. 1: Means that programming user data failed and the number of error bytes is over 6. (RO)

EFUSE_KEY0_ERR_NUM Represents the number of error bytes during programming KEY0. (RO)

EFUSE_KEY0_FAIL Represents whether or not the data is reliable. 0: Means no failure and that the data of key0 is reliable. 1: Means that programming key0 failed and the number of error bytes is over 6. (RO)

EFUSE_KEY1_ERR_NUM Represents the number of error bytes during programming KEY1. (RO)

EFUSE_KEY1_FAIL Represents whether or not the data is reliable. 0: Means no failure and that the data of key1 is reliable. 1: Means that programming key1 failed and the number of error bytes is over 6. (RO)

EFUSE_KEY2_ERR_NUM Represents the number of error bytes during programming KEY2. (RO)

EFUSE_KEY2_FAIL Represents whether or not the data is reliable. 0: Means no failure and that the data of key2 is reliable. 1: Means that programming key2 failed and the number of error bytes is over 6. (RO)

Continued on the next page...

Register 5.101. EFUSE_RD_RS_ERR0_REG (0x01C0)

Continued from the previous page...

EFUSE_KEY3_ERR_NUM Represents the number of error bytes during programming KEY3. (RO)

EFUSE_KEY3_FAIL Represents whether or not the data is reliable. 0: Means no failure and that the data of key3 is reliable. 1: Means that programming key3 failed and the number of error bytes is over 6. (RO)

EFUSE_KEY4_ERR_NUM Represents the number of error bytes during programming KEY4. (RO)

EFUSE_KEY4_FAIL Represents whether or not the data is reliable. 0: Means no failure and that the data of KEY4 is reliable. 1: Means that programming data of KEY4 failed and the number of error bytes is over 6. (RO)

Register 5.102. EFUSE_RD_RS_ERR1_REG (0x01C4)

31	(reserved)																8	7	6	4	7	2	0
																	0	0x0	0	0x0	Reset		

EFUSE_SYS_PART2_FAIL

EFUSE_SYS_PART2_ERR_NUM

EFUSE_KEY5_FAIL

EFUSE_KEY5_ERR_NUM

EFUSE_KEY5_ERR_NUM Represents the number of error bytes during programming KEY5. (RO)

EFUSE_KEY5_FAIL Represents whether or not the data is reliable. 0: Means no failure and that the data of KEY5 is reliable. 1: Means that programming data of KEY5 failed and the number of error bytes is over 6. (RO)

EFUSE_SYS_PART2_ERR_NUM Represents the number of error bytes during programming system part2. (RO)

EFUSE_SYS_PART2_FAIL Represents whether or not the data is reliable. 0: Means no failure and that the data of system part2 is reliable. 1: Means that programming data of system part2 failed and the number of error bytes is over 6. (RO)

Register 5.103. EFUSE_CLK_REG (0x01C8)

(reserved)													EFUSE_CLK_EN			(reserved)													EFUSE_EFUSE_MEM_FORCE_PU EFUSE_MEM_CLK_FORCE_ON EFUSE_EFUSE_MEM_FORCE_PD				
31															17	16	15												3	2	1	0	Reset
0 0 0 0 0 0 0 0 0 0 0 0 0 0 0 0 0																	0	0 0 0 0 0 0 0 0 0 0 0 0 0 0 0 0 0											0	1	0		

EFUSE_EFUSE_MEM_FORCE_PD Configures whether or not to force eFuse SRAM into power-saving mode. 1: Force. 0: No effect. (R/W)

EFUSE_MEM_CLK_FORCE_ON Configures whether or not to force on activate clock signal of eFuse SRAM. 1: Force. 0: No effect. (R/W)

EFUSE_EFUSE_MEM_FORCE_PU Configures whether or not to force eFuse SRAM into working mode. 1: Force. 0: No effect. (R/W)

EFUSE_CLK_EN Configures whether or not to enable clock signal of eFuse registers. 1: Enable. 0: No effect. (R/W)

Register 5.104. EFUSE_CONF_REG (0x01CC)

(reserved)																EFUSE_OP_CODE															
31															16	15												0	Reset		
0 0 0 0 0 0 0 0 0 0 0 0 0 0 0 0 0																	0x00														

EFUSE_OP_CODE Configures whether to operate programming command or read command. 0x5A5A: Operate programming command. 0x5AA5: Operate read command. (R/W)

Register 5.105. EFUSE_CMD_REG (0x01D4)

(reserved)																EFUSE_BLK_NUM		EFUSE_PGM_CMD	EFUSE_READ_CMD	
31															6	5	2	1	0	
0 0																0x0	0	0	Reset	

EFUSE_READ_CMD Configures whether or not to send read command. 1: Send. 0: No effect. (R/WS/SC)

EFUSE_PGM_CMD Configures whether or not to send programming command. 1: Send. 0: No effect. (R/WS/SC)

EFUSE_BLK_NUM Configures the index of the block to be programmed. Value 0 ~ 10 corresponds to block number 0 ~ 10 respectively. (R/W)

Register 5.106. EFUSE_DAC_CONF_REG (0x01E8)

(reserved)																EFUSE_OE_CLR		EFUSE_DAC_NUM			(reserved)		EFUSE_DAC_CLK_DIV		
31															18	17	16			9	8	7	0		
0 0 0 0 0 0 0 0 0 0 0 0 0 0 0 0 0																0	255			0	28			Reset	

EFUSE_DAC_CLK_DIV Configures the division factor of the clock for the programming voltage. (R/W)

EFUSE_DAC_NUM Configures the rising period of the programming voltage. (R/W)

EFUSE_OE_CLR Configures whether or not to reduce the power supply of the programming voltage. 1: Reduce. 0: No effect. (R/W)

Register 5.107. EFUSE_RD_TIM_CONF_REG (0x01EC)

(reserved)																								EFUSE_READ_INIT_NUM				
31																							24	23	0			
0 0																								0x12	0			Reset

EFUSE_READ_INIT_NUM Configures the initial read time of eFuse. (R/W)

Register 5.108. EFUSE_WR_TIME_CONF1_REG (0x01F4)

(reserved)								EFUSE_PWR_ON_NUM								(reserved)								
31								24	23							8	7							0
0 0 0 0 0 0 0 0								0x2880								0 0 0 0 0 0 0 0								Reset

EFUSE_PWR_ON_NUM Configures the power up time for VDDQ. (R/W)

Register 5.109. EFUSE_WR_TIM_CONF2_REG (0x01F8)

(reserved)																EFUSE_PWR_OFF_NUM																
31																16	15															0
0 0 0 0 0 0 0 0 0 0 0 0 0 0 0 0																0x190																Reset

EFUSE_PWR_OFF_NUM Configures the power off time for VDDQ. (R/W)

Register 5.110. EFUSE_STATUS_REG (0x01D0)

(reserved)																EFUSE_REPEAT_ERR_CNT				(reserved)				EFUSE_STATE				
31														18	17			10	9			4	3			0		
0 0 0 0 0 0 0 0 0 0 0 0 0 0 0 0																0x0				0 0 0 0 0 0 0 0				0x0				Reset

EFUSE_STATE Represents the state of the eFuse state machine. (RO)

EFUSE_REPEAT_ERR_CNT Represents the number of error bits during programming BLOCK0.
(RO)

Register 5.111. EFUSE_INT_RAW_REG (0x01D8)

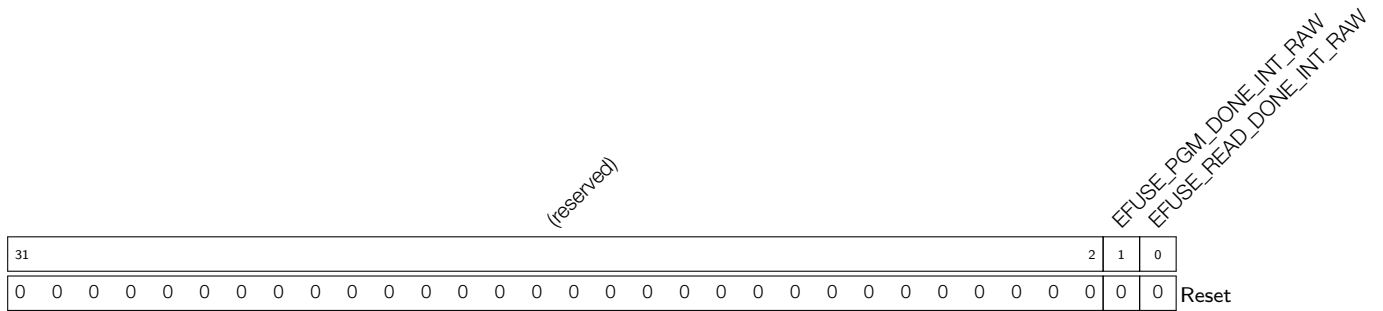

EFUSE_READ_DONE_INT_RAW The raw interrupt status of READ_DONE. (R/WC/SS)

EFUSE_PGM_DONE_INT_RAW The raw interrupt status of PGM_DONE. (R/WC/SS)

Register 5.112. EFUSE_INT_ST_REG (0x01DC)

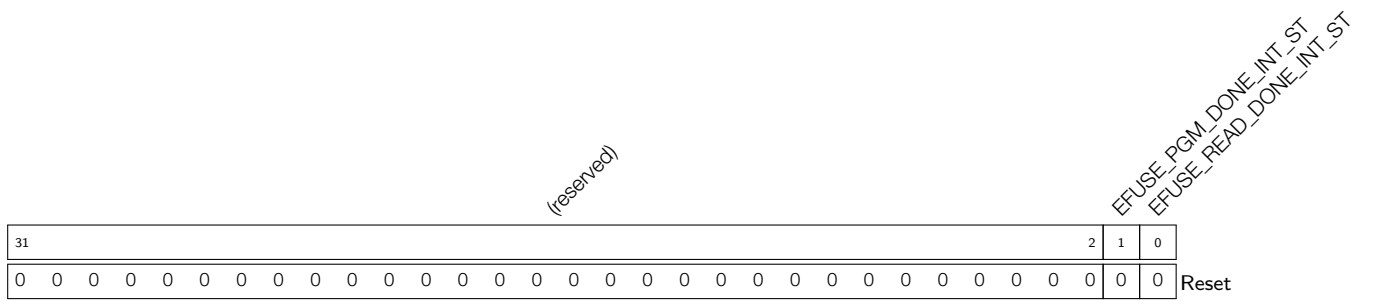

EFUSE_READ_DONE_INT_ST The masked interrupt status of READ_DONE. (RO)

EFUSE_PGM_DONE_INT_ST The masked interrupt status of PGM_DONE. (RO)

Register 5.113. EFUSE_INT_ENA_REG (0x01E0)

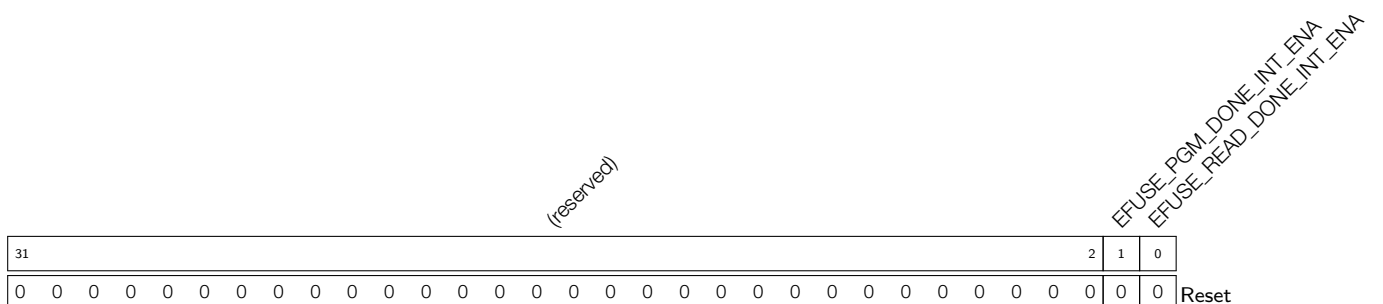

EFUSE_READ_DONE_INT_ENA Write 1 to enable READ_DONE. (R/W)

EFUSE_PGM_DONE_INT_ENA Write 1 to enable PGM_DONE. (R/W)

Register 5.114. EFUSE_INT_CLR_REG (0x01E4)

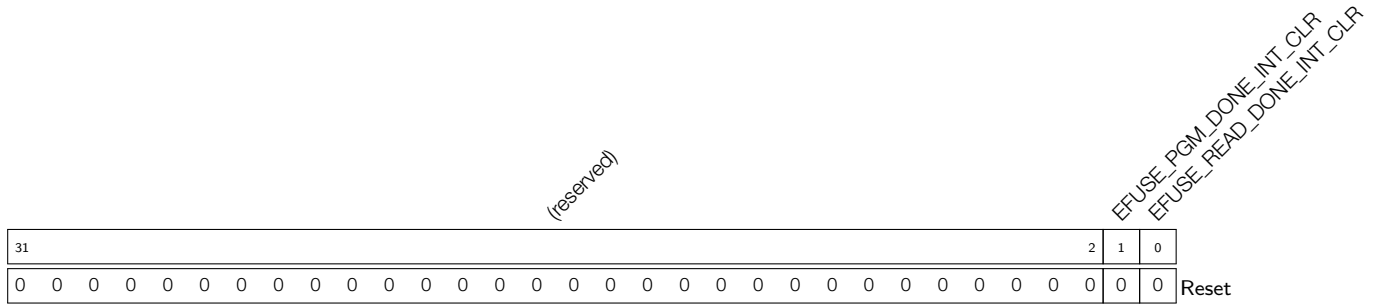

EFUSE_READ_DONE_INT_CLR Write 1 to clear READ_DONE. (WO)

EFUSE_PGM_DONE_INT_CLR Write 1 to clear PGM_DONE. (WO)

Register 5.115. EFUSE_DATE_REG (0x01FC)

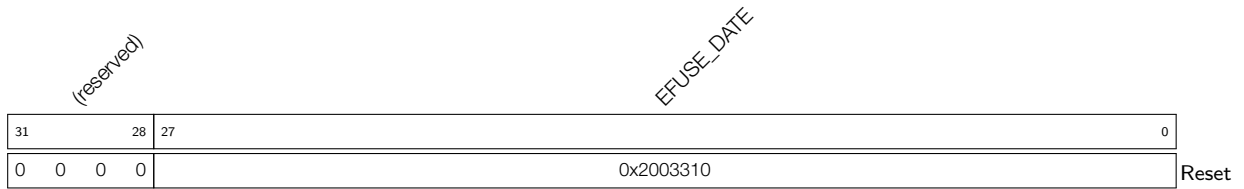

EFUSE_DATE Version control register. (R/W)

6 IO MUX and GPIO Matrix (GPIO, IO MUX)

6.1 Overview

The ESP32-S3 chip features 45 physical GPIO pins. Each pin can be used as a general-purpose I/O, or be connected to an internal peripheral signal. Through GPIO matrix, IO MUX, and RTC IO MUX, peripheral input signals can be from any GPIO pin, and peripheral output signals can be routed to any GPIO pin. Together these modules provide highly configurable I/O.

Note that the 45 GPIO pins are numbered from 0 ~ 21 and 26 ~ 48. All these pins can be configured either as input or output.

6.2 Features

GPIO Matrix Features

- A full-switching matrix between the peripheral input/output signals and the GPIO pins.
- 175 digital peripheral input signals can be sourced from the input of any GPIO pins.
- The output of any GPIO pins can be from any of the 184 digital peripheral output signals.
- Supports signal synchronization for peripheral inputs based on APB clock bus.
- Provides input signal filter.
- Supports sigma delta modulated output.
- Supports GPIO simple input and output.

IO MUX Features

- Provides one configuration register `IO_MUX_GPIO n _REG` for each GPIO pin. The pin can be configured to
 - perform GPIO function routed by GPIO matrix;
 - or perform direct connection bypassing GPIO matrix.
- Supports some high-speed digital signals (SPI, JTAG, UART) bypassing GPIO matrix for better high-frequency digital performance. In this case, IO MUX is used to connect these pins directly to peripherals.

RTC IO MUX Features

- Controls low power feature of 22 RTC GPIO pins.
- Controls analog functions of 22 RTC GPIO pins.
- Redirects 22 RTC input/output signals to RTC system.

6.3 Architectural Overview

Figure 6-1 shows in details how IO MUX, RTC IO MUX, and GPIO matrix route signals from pins to peripherals, and from peripherals to pins.

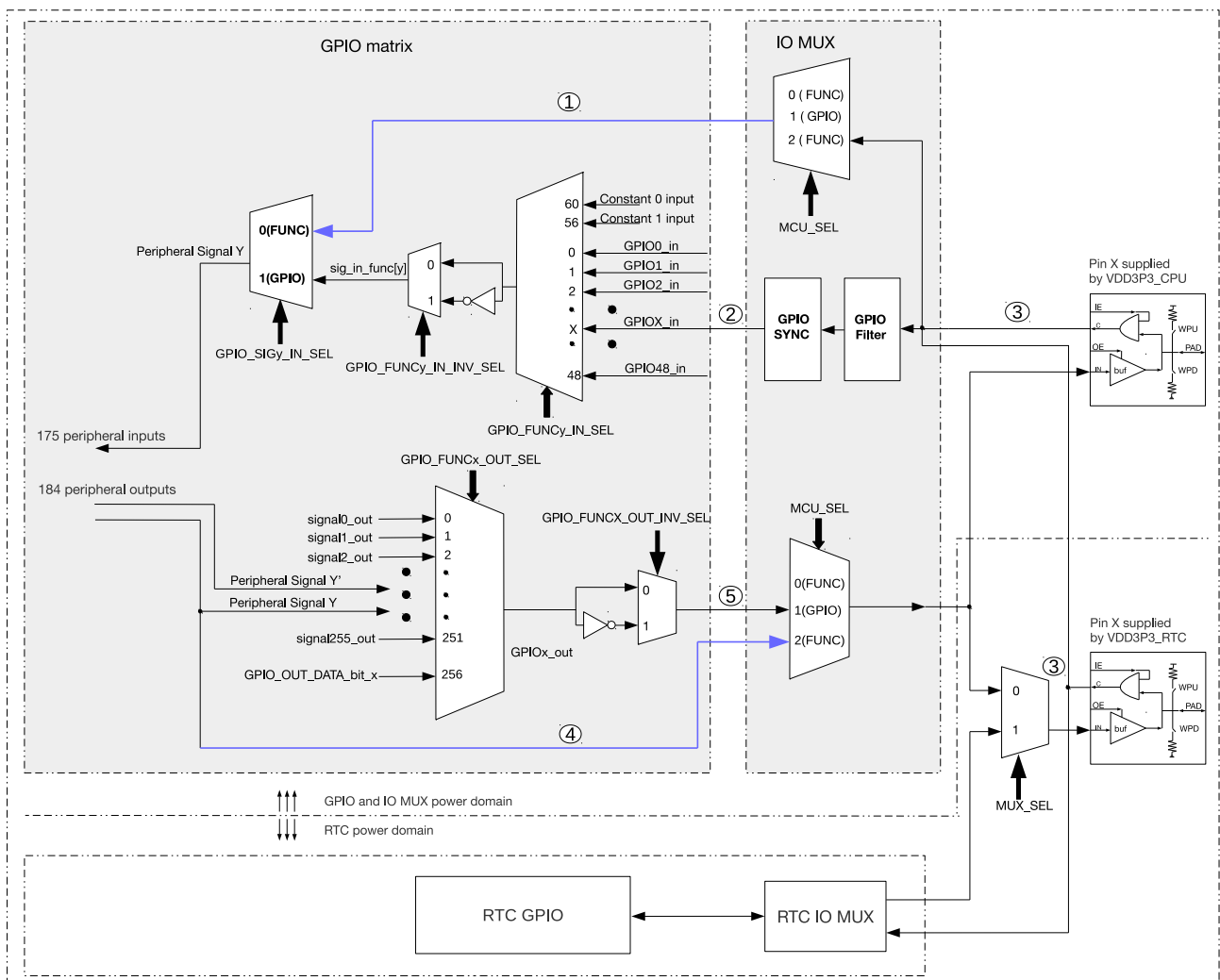

Figure 6-1. Architecture of IO MUX, RTC IO MUX, and GPIO Matrix

1. Only part of peripheral input signals (marked “yes” in column “Direct input through IO MUX” in Table 6-2) can bypass GPIO matrix. The other input signals can only be routed to peripherals via GPIO matrix.
2. There are only 45 inputs from GPIO SYNC to GPIO matrix, since ESP32-S3 provides 45 GPIO pins in total.
3. The pins supplied by VDD3P3_CPU or by VDD3P3_RTC are controlled by the signals: IE, OE, WPU, and WPD.
4. Only part of peripheral outputs (marked “yes” in column “Direct output through IO MUX” in Table 6-2) can be routed to pins bypassing GPIO matrix.
5. There are only 45 outputs (GPIO pin X: 0 ~ 21, 26 ~ 48) from GPIO matrix to IO MUX.

Figure 6-2 shows the internal structure of a pad, which is an electrical interface between the chip logic and the GPIO pin. The structure is applicable to all 45 GPIO pins and can be controlled using IE, OE, WPU, and WPD signals.

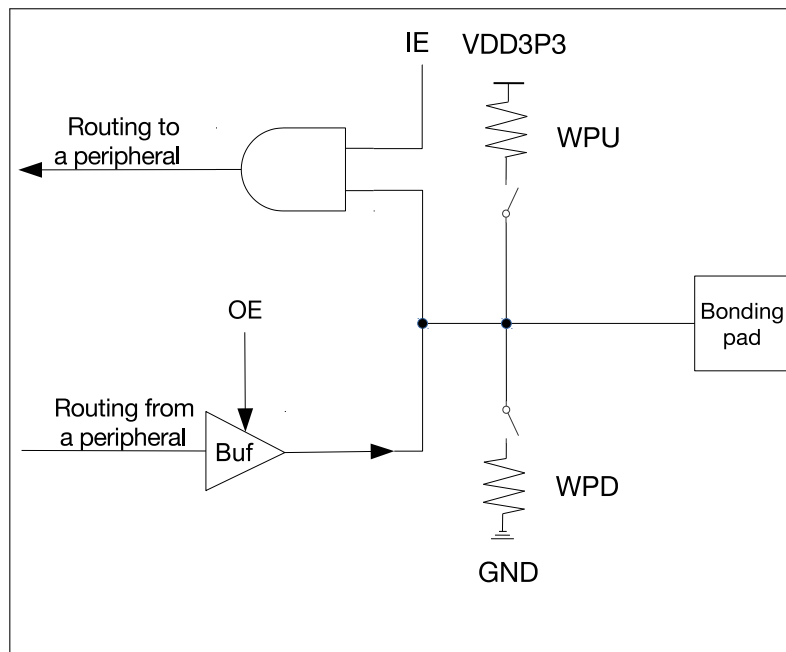

Figure 6-2. Internal Structure of a Pad

Note:

- IE: input enable
- OE: output enable
- WPU: internal weak pull-up
- WPD: internal weak pull-down
- Bonding pad: a terminal point of the chip logic used to make a physical connection from the chip die to GPIO pin in the chip package.

6.4 Peripheral Input via GPIO Matrix

6.4.1 Overview

To receive a peripheral input signal via GPIO matrix, the matrix is configured to source the peripheral input signal from one of the 45 GPIOs (0 ~ 21, 26 ~ 48), see Table 6-2. Meanwhile, register corresponding to the peripheral signal should be set to receive input signal via GPIO matrix.

6.4.2 Signal Synchronization

When signals are directed from pins using the GPIO matrix, the signals will be synchronized to the APB bus clock by the GPIO SYNC hardware, then go to GPIO matrix. This synchronization applies to all GPIO matrix signals but does not apply when using the IO MUX, see Figure 6-1.

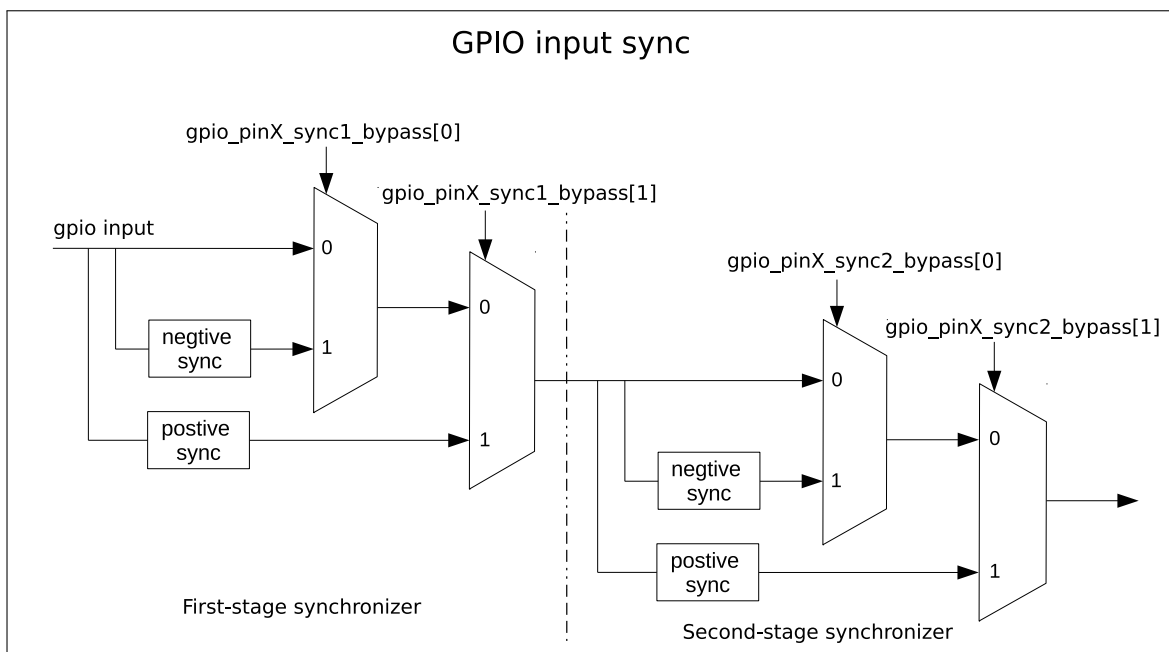

Figure 6-3. GPIO Input Synchronized on APB Clock Rising Edge or on Falling Edge

Figure 6-3 shows the functionality of GPIO SYNC. In the figure, negative sync and positive sync mean GPIO input is synchronized on APB clock falling edge and on APB clock rising edge, respectively.

6.4.3 Functional Description

To read GPIO pin X^1 into peripheral signal Y , follow the steps below:

1. Configure register `GPIO_FUNC y _IN_SEL_CFG_REG` corresponding to peripheral signal Y in GPIO matrix:
 - Set `GPIO_SIG y _IN_SEL` to enable peripheral signal input via GPIO matrix.
 - Set `GPIO_FUNC y _IN_SEL` to the desired GPIO pin, i.e. X here.

Note that some peripheral signals have no valid `GPIO_SIG y _IN_SEL` bit, namely, these peripherals can only receive input signals via GPIO matrix.

2. Optionally enable the filter for pin input signals by setting the register `IO_MUX_FILTER_EN`. Only the signals with a valid width of more than two APB clock cycles can be sampled, see Figure 6-4.

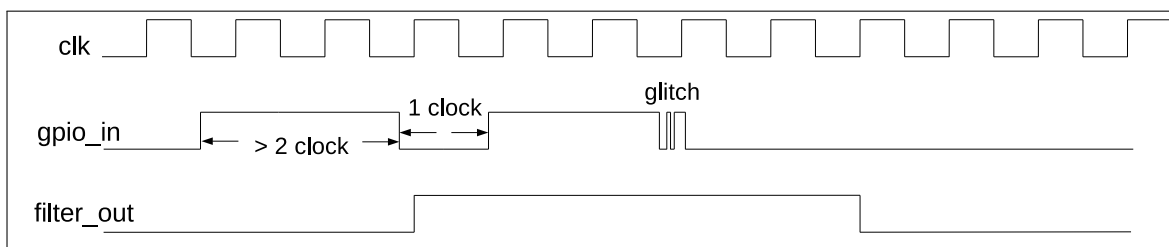

Figure 6-4. Filter Timing of GPIO Input Signals

3. Synchronize GPIO input. To do so, please set `GPIO_PIN x _REG` corresponding to GPIO pin X as follows:
 - Set `GPIO_PIN x _SYNC1_BYPASS` to enable input signal synchronized on rising edge or on falling edge in the first clock, see Figure 6-3.

- Set [GPIO_PIN \$x\$ _SYNC2_BYPASS](#) to enable input signal synchronized on rising edge or on falling edge in the second clock, see Figure 6-3.
4. Configure IO MUX register to enable pin input. For this end, please set [IO_MUX_X_REG](#) corresponding to GPIO pin x as follows:
 - Set [IO_MUX_FUN_IE](#) to enable input².
 - Set or clear [IO_MUX_FUN_WPU](#) and [IO_MUX_FUN_WPD](#), as desired, to enable or disable pull-up and pull-down resistors.

For example, to connect RMT channel 0 input signal³ (`rmt_sig_in0`, signal index 81) to GPIO40, please follow the steps below. Note that GPIO40 is also named as MTDO pin.

1. Set [GPIO_SIG81_IN_SEL](#) in register [GPIO_FUNC81_IN_SEL_CFG_REG](#) to enable peripheral signal input via GPIO matrix.
2. Set [GPIO_FUNC81_IN_SEL](#) in register [GPIO_FUNC81_IN_SEL_CFG_REG](#) to 40, i.e. select GPIO40.
3. Set [IO_MUX_FUN_IE](#) in register [IO_MUX_GPIO40_REG](#) to enable pin input.

Note:

1. One pin input can be connected to multiple peripheral input signals.
2. The input signal can be inverted by configuring [GPIO_FUNC \$y\$ _IN_INV_SEL](#).
3. It is possible to have a peripheral read a constantly low or constantly high input value without connecting this input to a pin. This can be done by selecting a special [GPIO_FUNC \$y\$ _IN_SEL](#) input, instead of a GPIO number:
 - When [GPIO_FUNC \$y\$ _IN_SEL](#) is set to 0x3C, input signal is always 0.
 - When [GPIO_FUNC \$y\$ _IN_SEL](#) is set to 0x38, input signal is always 1.

6.4.4 Simple GPIO Input

[GPIO_IN_REG](#)/[GPIO_IN1_REG](#) holds the input values of each GPIO pin. The input value of any GPIO pin can be read at any time without configuring GPIO matrix for a particular peripheral signal. However, it is necessary to enable pin input by setting [IO_MUX_FUN_IE](#) in register [IO_MUX_x_REG](#) corresponding to pin X , as described in Section 6.4.2.

6.5 Peripheral Output via GPIO Matrix

6.5.1 Overview

To output a signal from a peripheral via GPIO matrix, the matrix is configured to route peripheral output signals (only signals with a name assigned in the column "Output signal" in Table 6-2) to one of the 45 GPIOs (0 ~ 21, 26 ~ 48).

The output signal is routed from the peripheral into GPIO matrix and then into IO MUX. IO MUX must be configured to set the chosen pin to GPIO function. This enables the output GPIO signal to be connected to the pin.

Note:

There is a range of peripheral output signals (208 ~ 212 in Table 6-2) which are not connected to any peripheral, but to the

input signals (208 ~ 212) directly. These can be used to input a signal from one GPIO pin and output directly to another GPIO pin.

6.5.2 Functional Description

Some of the 256 output signals (signals with a name assigned in the column "Output signal" in Table 6-2) can be set to go through GPIO matrix into IO MUX and then to a pin. Figure 6-1 illustrates the configuration.

To output peripheral signal Y to a particular GPIO pin $X^1, 2$, follow these steps:

1. Configure `GPIO_FUNCx_OUT_SEL_CFG_REG` and `GPIO_ENABLE_REG[x]` corresponding to GPIO pin X in GPIO matrix. Recommended operation: use corresponding `W1TS` (write 1 to set) and `W1TC` (write 1 to clear) registers to set or clear `GPIO_ENABLE_REG`.
 - Set the `GPIO_FUNCx_OUT_SEL` field in register `GPIO_FUNCx_OUT_SEL_CFG_REG` to the index of the desired peripheral output signal Y .
 - If the signal should always be enabled as an output, set the bit `GPIO_FUNCx_OEN_SEL` in register `GPIO_FUNCx_OUT_SEL_CFG_REG` and the bit in register `GPIO_ENABLE/ENABLE1_W1TS_REG`, corresponding to GPIO pin X . To have the output enable signal decided by internal logic (for example, the `SPIQ_oe` in column "Output enable signal when `GPIO_FUNCn_OEN_SEL = 0`" in Table 6-2), clear the bit `GPIO_FUNCx_OEN_SEL` instead.
 - Set the corresponding bit in register `GPIO_ENABLE/ENABLE1_W1TC_REG` to disable the output from the GPIO pin.
2. For an open drain output, set the bit `GPIO_PINx_PAD_DRIVER` in register `GPIO_PINx_REG` corresponding to GPIO pin X .
3. Configure IO MUX register to enable output via GPIO matrix. Set the `IO_MUX_x_REG` corresponding to GPIO pin X as follows:
 - Set the field `IO_MUX_MCU_SEL` to desired IO MUX function corresponding to GPIO pin X . This is Function 1 (GPIO function), numeric value 1, for all pins.
 - Set the field `IO_MUX_FUN_DRV` to the desired value for output strength (0 ~ 3). The higher the driver strength, the more current can be sourced/sunk from the pin.
 - 0: ~5 mA
 - 1: ~10 mA
 - 2: ~20 mA (default value)
 - 3: ~40 mA
 - If using open drain mode, set/clear `IO_MUX_FUN_WPU` and `IO_MUX_FUN_WPD` to enable/disable the internal pull-up/pull-down resistors.

Note:

1. The output signal from a single peripheral can be sent to multiple pins simultaneously.
2. The output signal can be inverted by setting `GPIO_FUNCx_OUT_INV_SEL`.

6.5.3 Simple GPIO Output

GPIO matrix can also be used for simple GPIO output. This can be done as below:

- Set GPIO matrix `GPIO_FUNCn_OUT_SEL` with a special peripheral index 256 (0x100);
- Set the corresponding bit in `GPIO_OUT_REG[31:0]` or `GPIO_OUT1_REG[21:0]` to the desired GPIO output value.

Note:

- `GPIO_OUT_REG[21:0]` and `GPIO_OUT_REG[31:26]` correspond to GPIO0 ~ 21 and GPIO26 ~ 31, respectively. `GPIO_OUT_REG[25:22]` are invalid.
- `GPIO_OUT1_REG[16:0]` correspond to GPIO32 ~ 48, and `GPIO_OUT1_REG[21:17]` are invalid.
- Recommended operation: use corresponding W1TS and W1TC registers, such as `GPIO_OUT_W1TS/GPIO_OUT_W1TC` to set or clear the registers `GPIO_OUT_REG/GPIO_OUT1_REG`.

6.5.4 Sigma Delta Modulated Output

6.5.4.1 Functional Description

Eight out of the 256 peripheral outputs (index: 93 ~ 100 in Table 6-2) support 1-bit second-order sigma delta modulation. By default output is enabled for these eight channels. This Sigma Delta modulator can also output PDM (pulse density modulation) signal with configurable duty cycle. The transfer function is:

$$H(z) = X(z)z^{-1} + E(z)(1-z^{-1})^2$$

$E(z)$ is quantization error and $X(z)$ is the input.

This modulator supports scaling down of APB_CLK by divider 1 ~ 256:

- Set `GPIO_FUNCTION_CLK_EN` to enable the modulator clock.
- Configure `GPIO_SDn_PRESCALE` (n is 0 ~ 7 for eight channels).

After scaling, the clock cycle is equal to one pulse output cycle from the modulator.

`GPIO_SDn_IN` is a signed number with a range of [-128, 127] and is used to control the duty cycle¹ of PDM output signal.

- `GPIO_SDn_IN` = -128, the duty cycle of the output signal is 0%.
- `GPIO_SDn_IN` = 0, the duty cycle of the output signal is near 50%.
- `GPIO_SDn_IN` = 127, the duty cycle of the output signal is close to 100%.

The formula for calculating PDM signal duty cycle is shown as below:

$$Duty_Cycle = \frac{GPIO_SDn_IN + 128}{256}$$

Note:

For PDM signals, duty cycle refers to the percentage of high level cycles to the whole statistical period (several pulse

cycles, for example 256 pulse cycles).

6.5.4.2 SDM Configuration

The configuration of SDM is shown below:

- Route one of SDM outputs to a pin via GPIO matrix, see Section 6.5.2.
- Enable the modulator clock by setting `GPIO_FUNCTION_CLK_EN`.
- Configure the divider value by setting `GPIO_SD n _PRESCALE`.
- Configure the duty cycle of SDM output signal by setting `GPIO_SD n _IN`.

6.6 Direct Input and Output via IO MUX

6.6.1 Overview

Some high-speed signals (SPI and JTAG) can bypass GPIO matrix for better high-frequency digital performance. In this case, IO MUX is used to connect these pins directly to the peripherals.

This option is less flexible than routing signals via GPIO matrix, as the IO MUX register for each GPIO pin can only select from a limited number of functions, but high-frequency digital performance can be improved.

6.6.2 Functional Description

Two registers must be configured in order to bypass GPIO matrix for peripheral input signals:

1. `IO_MUX_MCU_SEL` for the GPIO pin must be set to the required pin function. For the list of pin functions, please refer to Section 6.12.
2. Clear `GPIO_SIG n _IN_SEL` to route the input directly to the peripheral.

To bypass GPIO matrix for peripheral output signals, `IO_MUX_MCU_SEL` for the GPIO pin must be set to the required pin function. For the list of pin functions, please refer to Section 6.12.

Note:

Not all signals can be connected to peripheral via IO MUX. Some input/output signals can only be connected to peripheral via GPIO matrix.

6.7 RTC IO MUX for Low Power and Analog Input/Output

6.7.1 Overview

ESP32-S3 provides 22 GPIO pins with low power capabilities (RTC) and analog functions, which are handled by the RTC subsystem of ESP32-S3. IO MUX and GPIO matrix are not used for these functions, rather, RTC IO MUX is used to redirect 22 RTC input/output signals to the RTC subsystem.

When configured as RTC GPIOs, the output pins can still retain the output level value when the chip is in Deep-sleep mode, and the input pins can wake up the chip from Deep-sleep.

6.7.2 Low Power Capabilities

The pins with RTC functions are controlled by `RTC_IO_TOUCH/RTC_PAD n _MUX_SEL` bit in register `RTC_IO_TOUCH/RTC_PAD n _REG`. By default all bits in these registers are set to 0, routing all input/output signals via IO MUX.

If `RTC_IO_TOUCH/RTC_PAD n _MUX_SEL` is set to 1, then input/output signals to and from that pin is routed to the RTC subsystem. In this mode, `RTC_IO_TOUCH/RTC_PAD n _REG` is used to control RTC low power pins. Note that `RTC_IO_TOUCH/RTC_PAD n _REG` applies the RTC GPIO pin numbering, not the GPIO pin numbering. See Table 6-4 for RTC functions of RTC IO MUX pins.

6.7.3 Analog Functions

When the pin is used for analog purpose, make sure this pin is left floating by configuring the register `RTC_IO_TOUCH/RTC_PAD n _REG`. By such way, external analog signal is connected to internal analog signal via GPIO pin. The configuration is as follows:

- Set `RTC_IO_TOUCH/RTC_PAD n _MUX_SEL`, to select RTC IO MUX to route input and output signals.
- Clear `RTC_IO_TOUCH/RTC_PAD n _FUN_IE`, `RTC_IO_TOUCH/RTC_PAD n _FUN_RUE`, and `RTC_IO_TOUCH/RTC_PAD n _FUN_RDE`, to set this pin floating.
- Configure `RTC_IO_TOUCH/RTC_PAD n _FUN_SEL` to 0, to enable analog function 0.
- Write 1 to `RTC_GPIO_ENABLE_W1TC`, to clear output enable.

See Table 6-5 for analog functions of RTC IO MUX pins.

6.8 Pin Functions in Light-sleep

Pins may provide different functions when ESP32-S3 is in Light-sleep mode. If `IO_MUX_SLP_SEL` in register `IO_MUX n _REG` for a GPIO pin is set to 1, a different set of bits will be used to control the pin when the chip is in Light-sleep mode.

Table 6-1. Bits Used to Control IO MUX Functions in Light-sleep Mode

IO MUX Functions	Normal Execution OR <code>IO_MUX_SLP_SEL = 0</code>	Light-sleep Mode AND <code>IO_MUX_SLP_SEL = 1</code>
Output Drive Strength	<code>IO_MUX_FUN_DRV</code>	<code>IO_MUX_MCU_DRV</code>
Pull-up Resistor	<code>IO_MUX_FUN_WPU</code>	<code>IO_MUX_MCU_WPU</code>
Pull-down Resistor	<code>IO_MUX_FUN_WPD</code>	<code>IO_MUX_MCU_WPD</code>
Output Enable	<code>OEN_SEL</code> from GPIO matrix *	<code>IO_MUX_MCU_OE</code>

Note:

If `IO_MUX_SLP_SEL` is set to 0, pin functions remain the same in both normal execution and Light-sleep mode. Please refer to Section 6.5.2 for how to enable output in normal execution.

6.9 Pin Hold Feature

Each GPIO pin (including the RTC pins) has an individual hold function controlled by an RTC register. When the pin is set to hold, the state is latched at that moment and will not change no matter how the internal signals change or how the IO MUX/GPIO configuration is modified. Users can use the hold function for the pins to retain the pin state through a core reset and system reset triggered by watchdog time-out or Deep-sleep events.

Note:

- For digital pins, to maintain pin input/output status in Deep-sleep mode, users can set `RTC_CNTL_DG_PAD_FORCE_UNHOLD` to 0 before powering down. For RTC pins, the input and output values are controlled by the corresponding bits of register `RTC_CNTL_PAD_HOLD_REG`, and users can set it to 1 to hold the value or set it to 0 to unhold the value.
- To disable the hold function after the chip is woken up, users can set `RTC_CNTL_DG_PAD_FORCE_UNHOLD` to 1. To maintain the hold function of the pin, users can set the corresponding bit in register `RTC_CNTL_PAD_HOLD_REG` to 1.

6.10 Power Supply and Management of GPIO Pins

6.10.1 Power Supply of GPIO Pins

For more information on the power supply for GPIO pins, please refer to Pin Definition in [ESP32-S3 Datasheet](#).

6.10.2 Power Supply Management

Each ESP32-S3 pin is connected to one of the three different power domains.

- `VDD3P3_RTC`: the input power supply for both RTC and CPU
- `VDD3P3_CPU`: the input power supply for CPU
- `VDD_SPI`: configurable input/output power supply

`VDD_SPI` can be configured to use an internal LDO. The LDO input and output both are 1.8 V. If the LDO is not enabled, `VDD_SPI` is connected directly to the same power supply as `VDD3P3_RTC`.

The `VDD_SPI` configuration is determined by the value of strapping pin GPIO45, or can be overridden by eFuse and/or register settings. See [ESP32-S3 Datasheet](#) sections Power Scheme and Strapping Pins for more details.

Note that GPIO33 ~ GPIO37 can be powered either by `VDD_SPI` or `VDD3P3_CPU`.

6.11 Peripheral Signals via GPIO Matrix

Table 6-2 shows the peripheral input/output signals via GPIO matrix.

Please pay attention to the configuration of the bit `GPIO_FUNC n _OEN_SEL`:

- `GPIO_FUNC n _OEN_SEL` = 1: the output enable is controlled by the corresponding bit n of `GPIO_ENABLE_REG`:
 - `GPIO_ENABLE_REG` = 0: output is disabled;

- `GPIO_ENABLE_REG = 1`: output is enabled;
- `GPIO_FUNC n _OEN_SEL = 0`: use the output enable signal from peripheral, for example `SPIQ_oe` in the column “Output enable signal when `GPIO_FUNC n _OEN_SEL = 0`” of Table 6-2. Note that the signals such as `SPIQ_oe` can be 1 (1'd1) or 0 (1'd0), depending on the configuration of corresponding peripherals. If it's 1'd1 in the “Output enable signal when `GPIO_FUNC n _OEN_SEL = 0`”, it indicates that once the register `GPIO_FUNC n _OEN_SEL` is cleared, the output signal is always enabled by default.

Note:

Signals are numbered consecutively, but not all signals are valid.

- Only the signals with a name assigned in the column “Input signal” in Table 6-2 are valid input signals.
- Only the signals with a name assigned in the column “Output signal” in Table 6-2 are valid output signals.

Table 6-2. Peripheral Signals via GPIO Matrix

Signal No.	Input Signal	Default value	Direct Input via IO MUX	Output Signal	Output enable signal when <code>GPIO_FUNC_n_OEN_SEL = 0</code>	Direct Output via IO MUX
0	SPIQ_in	0	yes	SPIQ_out	SPIQ_oe	yes
1	SPID_in	0	yes	SPID_out	SPID_oe	yes
2	SPIHD_in	0	yes	SPIHD_out	SPIHD_oe	yes
3	SPIWP_in	0	yes	SPIWP_out	SPIWP_oe	yes
4	-	-	-	SPICLK_out_mux	SPICLK_oe	yes
5	-	-	-	SPICS0_out	SPICS0_oe	yes
6	-	-	-	SPICS1_out	SPICS1_oe	yes
7	SPID4_in	0	yes	SPID4_out	SPID4_oe	yes
8	SPID5_in	0	yes	SPID5_out	SPID5_oe	yes
9	SPID6_in	0	yes	SPID6_out	SPID6_oe	yes
10	SPID7_in	0	yes	SPID7_out	SPID7_oe	yes
11	SPIDQS_in	0	yes	SPIDQS_out	SPIDQS_oe	yes
12	U0RXD_in	0	yes	U0TXD_out	1'd1	yes
13	U0CTS_in	0	yes	U0RTS_out	1'd1	yes
14	U0DSR_in	0	no	U0DTR_out	1'd1	no
15	U1RXD_in	0	yes	U1TXD_out	1'd1	yes
16	U1CTS_in	0	yes	U1RTS_out	1'd1	yes
17	U1DSR_in	0	no	U1DTR_out	1'd1	no
18	U2RXD_in	0	no	U2TXD_out	1'd1	no
19	U2CTS_in	0	no	U2RTS_out	1'd1	no
20	U2DSR_in	0	no	U2DTR_out	1'd1	no
21	I2S1_MCLK_in	0	no	I2S1_MCLK_out	1'd1	no
22	I2S0O_BCK_in	0	no	I2S0O_BCK_out	1'd1	no
23	I2S0_MCLK_in	0	no	I2S0_MCLK_out	1'd1	no
24	I2S0O_WS_in	0	no	I2S0O_WS_out	1'd1	no

Signal No.	Input Signal	Default value	Direct Input via IO MUX	Output Signal	Output enable signal when GPIO_FUNC n _OEN_SEL = 0	Direct Output via IO MUX
25	I2S0I_SD_in	0	no	I2S0O_SD_out	1'd1	no
26	I2S0I_BCK_in	0	no	I2S0I_BCK_out	1'd1	no
27	I2S0I_WS_in	0	no	I2S0I_WS_out	1'd1	no
28	I2S1O_BCK_in	0	no	I2S1O_BCK_out	1'd1	no
29	I2S1O_WS_in	0	no	I2S1O_WS_out	1'd1	no
30	I2S1I_SD_in	0	no	I2S1O_SD_out	1'd1	no
31	I2S1I_BCK_in	0	no	I2S1I_BCK_out	1'd1	no
32	I2S1I_WS_in	0	no	I2S1I_WS_out	1'd1	no
33	pcnt_sig_ch0_in0	0	no	-	1'd1	no
34	pcnt_sig_ch1_in0	0	no	-	1'd1	no
35	pcnt_ctrl_ch0_in0	0	no	-	1'd1	-
36	pcnt_ctrl_ch1_in0	0	no	-	1'd1	-
37	pcnt_sig_ch0_in1	0	no	-	1'd1	-
38	pcnt_sig_ch1_in1	0	no	-	1'd1	-
39	pcnt_ctrl_ch0_in1	0	no	-	1'd1	-
40	pcnt_ctrl_ch1_in1	0	no	-	1'd1	-
41	pcnt_sig_ch0_in2	0	no	-	1'd1	-
42	pcnt_sig_ch1_in2	0	no	-	1'd1	-
43	pcnt_ctrl_ch0_in2	0	no	-	1'd1	-
44	pcnt_ctrl_ch1_in2	0	no	-	1'd1	-
45	pcnt_sig_ch0_in3	0	no	-	1'd1	-
46	pcnt_sig_ch1_in3	0	no	-	1'd1	-
47	pcnt_ctrl_ch0_in3	0	no	-	1'd1	-
48	pcnt_ctrl_ch1_in3	0	no	-	1'd1	-
49	-	-	-	-	1'd1	-
50	-	-	-	-	1'd1	-
51	I2S0I_SD1_in	0	no	-	1'd1	-

Signal No.	Input Signal	Default value	Direct Input via IO MUX	Output Signal	Output enable signal when <code>GPIO_FUNCn_OEN_SEL = 0</code>	Direct Output via IO MUX
52	I2S0I_SD2_in	0	no	-	1'd1	-
53	I2S0I_SD3_in	0	no	-	1'd1	-
54	Core1_gpio_in7	0	no	Core1_gpio_out7	1'd1	no
55	-	-	-	-	1'd1	-
56	-	-	-	-	1'd1	-
57	-	-	-	-	1'd1	-
58	usb_otg_iddig_in	0	no	-	1'd1	-
59	usb_otg_avalid_in	0	no	-	1'd1	-
60	usb_srp_bvalid_in	0	no	usb_otg_idpullup	1'd1	no
61	usb_otg_vbusvalid_in	0	no	usb_otg_dppulldown	1'd1	no
62	usb_srp_sessend_in	0	no	usb_otg_dmpulldown	1'd1	no
63	-	-	-	usb_otg_drvvbus	1'd1	no
64	-	-	-	usb_srp_chrgvbus	1'd1	no
65	-	-	-	usb_srp_dischrgvbus	1'd1	no
66	SPI3_CLK_in	0	no	SPI3_CLK_out_mux	SPI3_CLK_oe	no
67	SPI3_Q_in	0	no	SPI3_Q_out	SPI3_Q_oe	no
68	SPI3_D_in	0	no	SPI3_D_out	SPI3_D_oe	no
69	SPI3_HD_in	0	no	SPI3_HD_out	SPI3_HD_oe	no
70	SPI3_WP_in	0	no	SPI3_WP_out	SPI3_WP_oe	no
71	SPI3_CS0_in	0	no	SPI3_CS0_out	SPI3_CS0_oe	no
72	-	-	-	SPI3_CS1_out	SPI3_CS1_oe	no
73	ext_adc_start	0	no	ledc_ls_sig_out0	1'd1	no
74	-	-	-	ledc_ls_sig_out1	1'd1	no
75	-	-	-	ledc_ls_sig_out2	1'd1	no
76	-	-	-	ledc_ls_sig_out3	1'd1	no
77	-	-	-	ledc_ls_sig_out4	1'd1	no
78	-	-	-	ledc_ls_sig_out5	1'd1	no

Signal No.	Input Signal	Default value	Direct Input via IO MUX	Output Signal	Output enable signal when GPIO_FUNC n _OEN_SEL = 0	Direct Output via IO MUX
79	-	-	-	ledc_ls_sig_out6	1'd1	no
80	-	-	-	ledc_ls_sig_out7	1'd1	no
81	rmt_sig_in0	0	no	rmt_sig_out0	1'd1	no
82	rmt_sig_in1	0	no	rmt_sig_out1	1'd1	no
83	rmt_sig_in2	0	no	rmt_sig_out2	1'd1	no
84	rmt_sig_in3	0	no	rmt_sig_out3	1'd1	no
85	-	-	-	-	1'd1	-
86	-	-	-	-	1'd1	-
87	-	-	-	-	1'd1	-
88	-	-	-	-	1'd1	-
89	I2CEXT0_SCL_in	1	no	I2CEXT0_SCL_out	I2CEXT0_SCL_oe	no
90	I2CEXT0_SDA_in	1	no	I2CEXT0_SDA_out	I2CEXT0_SDA_oe	no
91	I2CEXT1_SCL_in	1	no	I2CEXT1_SCL_out	I2CEXT1_SCL_oe	no
92	I2CEXT1_SDA_in	1	no	I2CEXT1_SDA_out	I2CEXT1_SDA_oe	no
93	-	-	-	gpio_sd0_out	1'd1	no
94	-	-	-	gpio_sd1_out	1'd1	no
95	-	-	-	gpio_sd2_out	1'd1	no
96	-	-	-	gpio_sd3_out	1'd1	no
97	-	-	-	gpio_sd4_out	1'd1	no
98	-	-	-	gpio_sd5_out	1'd1	no
99	-	-	-	gpio_sd6_out	1'd1	no
100	-	-	-	gpio_sd7_out	1'd1	no
101	FSPICLK_in	0	yes	FSPICLK_out_mux	FSPICLK_oe	yes
102	FSPIQ_in	0	yes	FSPIQ_out	FSPIQ_oe	yes
103	FSPID_in	0	yes	FSPID_out	FSPID_oe	yes
104	FSPIHD_in	0	yes	FSPIHD_out	FSPIHD_oe	yes
105	FSPIWP_in	0	yes	FSPIWP_out	FSPIWP_oe	yes

Signal No.	Input Signal	Default value	Direct Input via IO MUX	Output Signal	Output enable signal when <code>GPIO_FUNCn_OEN_SEL = 0</code>	Direct Output via IO MUX
106	FSPIIO4_in	0	yes	FSPIIO4_out	FSPIIO4_oe	yes
107	FSPIIO5_in	0	yes	FSPIIO5_out	FSPIIO5_oe	yes
108	FSPIIO6_in	0	yes	FSPIIO6_out	FSPIIO6_oe	yes
109	FSPIIO7_in	0	yes	FSPIIO7_out	FSPIIO7_oe	yes
110	FSPICS0_in	0	yes	FSPICS0_out	FSPICS0_oe	yes
111	-	-	-	FSPICS1_out	FSPICS1_oe	no
112	-	-	-	FSPICS2_out	FSPICS2_oe	no
113	-	-	-	FSPICS3_out	FSPICS3_oe	no
114	-	-	-	FSPICS4_out	FSPICS4_oe	no
115	-	-	-	FSPICS5_out	FSPICS5_oe	no
116	twai_rx	1	no	twai_tx	1'd1	no
117	-	-	-	twai_bus_off_on	1'd1	no
118	-	-	-	twai_clkout	1'd1	no
119	-	-	-	SUBSPICLK_out_mux	SUBSPICLK_oe	no
120	SUBSPIQ_in	0	yes	SUBSPIQ_out	SUBSPIQ_oe	yes
121	SUBSPID_in	0	yes	SUBSPID_out	SUBSPID_oe	yes
122	SUBSPIHD_in	0	yes	SUBSPIHD_out	SUBSPIHD_oe	yes
123	SUBSPIWP_in	0	yes	SUBSPIWP_out	SUBSPIWP_oe	yes
124	-	-	-	SUBSPICS0_out	SUBSPICS0_oe	yes
125	-	-	-	SUBSPICS1_out	SUBSPICS1_oe	yes
126	-	-	-	FSPIDQS_out	FSPIDQS_oe	yes
127	-	-	-	SPI3_CS2_out	SPI3_CS2_oe	no
128	-	-	-	I2S0O_SD1_out	1'd1	no
129	Core1_gpio_in0	0	no	Core1_gpio_out0	1'd1	no
130	Core1_gpio_in1	0	no	Core1_gpio_out1	1'd1	no
131	Core1_gpio_in2	0	no	Core1_gpio_out2	1'd1	no
132	-	-	-	LCD_CS	1'd1	no

Signal No.	Input Signal	Default value	Direct Input via IO MUX	Output Signal	Output enable signal when <code>GPIO_FUNCn_OEN_SEL = 0</code>	Direct Output via IO MUX
133	CAM_DATA_in0	0	no	LCD_DATA_out0	1'd1	no
134	CAM_DATA_in1	0	no	LCD_DATA_out1	1'd1	no
135	CAM_DATA_in2	0	no	LCD_DATA_out2	1'd1	no
136	CAM_DATA_in3	0	no	LCD_DATA_out3	1'd1	no
137	CAM_DATA_in4	0	no	LCD_DATA_out4	1'd1	no
138	CAM_DATA_in5	0	no	LCD_DATA_out5	1'd1	no
139	CAM_DATA_in6	0	no	LCD_DATA_out6	1'd1	no
140	CAM_DATA_in7	0	no	LCD_DATA_out7	1'd1	no
141	CAM_DATA_in8	0	no	LCD_DATA_out8	1'd1	no
142	CAM_DATA_in9	0	no	LCD_DATA_out9	1'd1	no
143	CAM_DATA_in10	0	no	LCD_DATA_out10	1'd1	no
144	CAM_DATA_in11	0	no	LCD_DATA_out11	1'd1	no
145	CAM_DATA_in12	0	no	LCD_DATA_out12	1'd1	no
146	CAM_DATA_in13	0	no	LCD_DATA_out13	1'd1	no
147	CAM_DATA_in14	0	no	LCD_DATA_out14	1'd1	no
148	CAM_DATA_in15	0	no	LCD_DATA_out15	1'd1	no
149	CAM_PCLK	0	no	CAM_CLK	1'd1	no
150	CAM_H_ENABLE	0	no	LCD_H_ENABLE	1'd1	no
151	CAM_H_SYNC	0	no	LCD_H_SYNC	1'd1	no
152	CAM_V_SYNC	0	no	LCD_V_SYNC	1'd1	no
153	-	-	-	LCD_DC	1'd1	no
154	-	-	-	LCD_PCLK	1'd1	no
155	SUBSPID4_in	0	yes	SUBSPID4_out	SUBSPID4_oe	no
156	SUBSPID5_in	0	yes	SUBSPID5_out	SUBSPID5_oe	no
157	SUBSPID6_in	0	yes	SUBSPID6_out	SUBSPID6_oe	no
158	SUBSPID7_in	0	yes	SUBSPID7_out	SUBSPID7_oe	no
159	SUBSPIDQS_in	0	yes	SUBSPIDQS_out	SUBSPIDQS_oe	no

Signal No.	Input Signal	Default value	Direct Input via IO MUX	Output Signal	Output enable signal when GPIO_FUNC n _OEN_SEL = 0	Direct Output via IO MUX
160	pwm0_sync0_in	0	no	pwm0_out0a	1'd1	no
161	pwm0_sync1_in	0	no	pwm0_out0b	1'd1	no
162	pwm0_sync2_in	0	no	pwm0_out1a	1'd1	no
163	pwm0_f0_in	0	no	pwm0_out1b	1'd1	no
164	pwm0_f1_in	0	no	pwm0_out2a	1'd1	no
165	pwm0_f2_in	0	no	pwm0_out2b	1'd1	no
166	pwm0_cap0_in	0	no	pwm1_out0a	1'd1	no
167	pwm0_cap1_in	0	no	pwm1_out0b	1'd1	no
168	pwm0_cap2_in	0	no	pwm1_out1a	1'd1	no
169	pwm1_sync0_in	0	no	pwm1_out1b	1'd1	no
170	pwm1_sync1_in	0	no	pwm1_out2a	1'd1	no
171	pwm1_sync2_in	0	no	pwm1_out2b	1'd1	no
172	pwm1_f0_in	0	no	sdhost_cclk_out_1	1'd1	no
173	pwm1_f1_in	0	no	sdhost_cclk_out_2	1'd1	no
174	pwm1_f2_in	0	no	sdhost_rst_n_1	1'd1	no
175	pwm1_cap0_in	0	no	sdhost_rst_n_2	1'd1	no
176	pwm1_cap1_in	0	no	sd-host_ccmd_od_pullup_en_n	1'd1	no
177	pwm1_cap2_in	0	no	sdio_tohost_int_out	1'd1	no
178	sdhost_ccmd_in_1	1	no	sdhost_ccmd_out_1	sdhost_ccmd_out_en_1	no
179	sdhost_ccmd_in_2	1	no	sdhost_ccmd_out_2	sdhost_ccmd_out_en_2	no
180	sdhost_cdata_in_10	1	no	sdhost_cdata_out_10	sdhost_cdata_out_en_10	no
181	sdhost_cdata_in_11	1	no	sdhost_cdata_out_11	sdhost_cdata_out_en_11	no
182	sdhost_cdata_in_12	1	no	sdhost_cdata_out_12	sdhost_cdata_out_en_12	no
183	sdhost_cdata_in_13	1	no	sdhost_cdata_out_13	sdhost_cdata_out_en_13	no
184	sdhost_cdata_in_14	1	no	sdhost_cdata_out_14	sdhost_cdata_out_en_14	no
185	sdhost_cdata_in_15	1	no	sdhost_cdata_out_15	sdhost_cdata_out_en_15	no

Signal No.	Input Signal	Default value	Direct Input via IO MUX	Output Signal	Output enable signal when <code>GPIO_FUNCn_OEN_SEL = 0</code>	Direct Output via IO MUX
186	sdhost_cdata_in_16	1	no	sdhost_cdata_out_16	sdhost_cdata_out_en_16	no
187	sdhost_cdata_in_17	1	no	sdhost_cdata_out_17	sdhost_cdata_out_en_17	no
188	-	-	-	-	1'd1	-
189	-	-	-	-	1'd1	-
190	-	-	-	-	1'd1	-
191	-	-	-	-	1'd1	-
192	sdhost_data_strobe_1	0	no	-	1'd1	-
193	sdhost_data_strobe_2	0	no	-	1'd1	-
194	sdhost_card_detect_n_1	0	no	-	1'd1	-
195	sdhost_card_detect_n_2	0	no	-	1'd1	-
196	sdhost_card_write_prt_1	0	no	-	1'd1	-
197	sdhost_card_write_prt_2	0	no	-	1'd1	-
198	sdhost_card_int_n_1	0	no	-	1'd1	-
199	sdhost_card_int_n_2	0	no	-	1'd1	-
200	-	-	-	-	1'd1	no
201	-	-	-	-	1'd1	no
202	-	-	-	-	1'd1	no
203	-	-	-	-	1'd1	no
204	-	-	-	-	1'd1	no
205	-	-	-	-	1'd1	no
206	-	-	-	-	1'd1	no
207	-	-	-	-	1'd1	no
208	sig_in_func_208	0	no	sig_in_func208	1'd1	no
209	sig_in_func_209	0	no	sig_in_func209	1'd1	no
210	sig_in_func_210	0	no	sig_in_func210	1'd1	no
211	sig_in_func_211	0	no	sig_in_func211	1'd1	no
212	sig_in_func_212	0	no	sig_in_func212	1'd1	no

Signal No.	Input Signal	Default value	Direct Input via IO MUX	Output Signal	Output enable signal when <code>GPIO_FUNCn_OEN_SEL = 0</code>	Direct Output via IO MUX
213	sdhost_cdata_in_20	1	no	sdhost_cdata_out_20	sdhost_cdata_out_en_20	no
214	sdhost_cdata_in_21	1	no	sdhost_cdata_out_21	sdhost_cdata_out_en_21	no
215	sdhost_cdata_in_22	1	no	sdhost_cdata_out_22	sdhost_cdata_out_en_22	no
216	sdhost_cdata_in_23	1	no	sdhost_cdata_out_23	sdhost_cdata_out_en_23	no
217	sdhost_cdata_in_24	1	no	sdhost_cdata_out_24	sdhost_cdata_out_en_24	no
218	sdhost_cdata_in_25	1	no	sdhost_cdata_out_25	sdhost_cdata_out_en_25	no
219	sdhost_cdata_in_26	1	no	sdhost_cdata_out_26	sdhost_cdata_out_en_26	no
220	sdhost_cdata_in_27	1	no	sdhost_cdata_out_27	sdhost_cdata_out_en_27	no
221	pro_alonegpio_in0	0	no	pro_alonegpio_out0	1'd1	no
222	pro_alonegpio_in1	0	no	pro_alonegpio_out1	1'd1	no
223	pro_alonegpio_in2	0	no	pro_alonegpio_out2	1'd1	no
224	pro_alonegpio_in3	0	no	pro_alonegpio_out3	1'd1	no
225	pro_alonegpio_in4	0	no	pro_alonegpio_out4	1'd1	no
226	pro_alonegpio_in5	0	no	pro_alonegpio_out5	1'd1	no
227	pro_alonegpio_in6	0	no	pro_alonegpio_out6	1'd1	no
228	pro_alonegpio_in7	0	no	pro_alonegpio_out7	1'd1	no
229	-	-	-	-	1'd1	-
230	-	-	-	-	1'd1	-
231	-	-	-	-	1'd1	-
232	-	-	-	-	1'd1	-
233	-	-	-	-	1'd1	-
234	-	-	-	-	1'd1	-
235	-	-	-	-	1'd1	-
236	-	-	-	-	1'd1	-
237	-	-	-	-	1'd1	-
238	-	-	-	-	1'd1	-
239	-	-	-	-	1'd1	-

Signal No.	Input Signal	Default value	Direct Input via IO MUX	Output Signal	Output enable signal when GPIO_FUNC n _OEN_SEL = 0	Direct Output via IO MUX
240	-	-	-	-	1'd1	-
241	-	-	-	-	1'd1	-
242	-	-	-	-	1'd1	-
243	-	-	-	-	1'd1	-
244	-	-	-	-	1'd1	-
245	-	-	-	-	1'd1	-
246	-	-	-	-	1'd1	-
247	-	-	-	-	1'd1	-
248	-	-	-	-	1'd1	-
249	-	-	-	-	1'd1	-
250	-	-	-	-	1'd1	-
251	usb_jtag_tdo_bridge	0	no	usb_jtag_trst	1'd1	no
252	Core1_gpio_in3	0	no	Core1_gpio_out3	1'd1	no
253	Core1_gpio_in4	0	no	Core1_gpio_out4	1'd1	no
254	Core1_gpio_in5	0	no	Core1_gpio_out5	1'd1	no
255	Core1_gpio_in6	0	no	Core1_gpio_out6	1'd1	no

6.12 IO MUX Function List

Table 6-3 shows the IO MUX functions of each GPIO pin.

Table 6-3. IO MUX Pin Functions

GPIO	Pin Name	Function 0	Function 1	Function 2	Function 3	Function 4	DRV	RST	Notes
0	GPIO0	GPIO0	GPIO0	-	-	-	2	3	R
1	GPIO1	GPIO1	GPIO1	-	-	-	2	1	R
2	GPIO2	GPIO2	GPIO2	-	-	-	2	1	R
3	GPIO3	GPIO3	GPIO3	-	-	-	2	1	R
4	GPIO4	GPIO4	GPIO4	-	-	-	2	0	R
5	GPIO5	GPIO5	GPIO5	-	-	-	2	0	R
6	GPIO6	GPIO6	GPIO6	-	-	-	2	0	R
7	GPIO7	GPIO7	GPIO7	-	-	-	2	0	R
8	GPIO8	GPIO8	GPIO8	-	SUBSPICS1	-	2	0	R
9	GPIO9	GPIO9	GPIO9	-	SUBSPIHD	FSPIHD	2	1	R
10	GPIO10	GPIO10	GPIO10	FSPIIO4	SUBSPICS0	FSPICS0	2	1	R
11	GPIO11	GPIO11	GPIO11	FSPIIO5	SUBSPID	FSPID	2	1	R
12	GPIO12	GPIO12	GPIO12	FSPIIO6	SUBSPICLK	FSPICLK	2	1	R
13	GPIO13	GPIO13	GPIO13	FSPIIO7	SUBSPIQ	FSPIQ	2	1	R
14	GPIO14	GPIO14	GPIO14	FSPIDQS	SUBSPIWP	FSPiWP	2	1	R
15	XTAL_32K_P	GPIO15	GPIO15	U0RTS	-	-	2	0	R
16	XTAL_32K_N	GPIO16	GPIO16	U0CTS	-	-	2	0	R
17	GPIO17	GPIO17	GPIO17	U1TXD	-	-	2	1	R
18	GPIO18	GPIO18	GPIO18	U1RXD	CLK_OUT3	-	2	1	R
19	GPIO19	GPIO19	GPIO19	U1RTS	CLK_OUT2	-	3	0	R
20	GPIO20	GPIO20	GPIO20	U1CTS	CLK_OUT1	-	3	0	R
21	GPIO21	GPIO21	GPIO21	-	-	-	2	0	R
26	SPICS1	SPICS1	GPIO26	-	-	-	2	3	-
27	SPIHD	SPIHD	GPIO27	-	-	-	2	3	-
28	SPIWP	SPIWP	GPIO28	-	-	-	2	3	-
29	SPICS0	SPICS0	GPIO29	-	-	-	2	3	-
30	SPICLK	SPICLK	GPIO30	-	-	-	2	3	-
31	SPIQ	SPIQ	GPIO31	-	-	-	2	3	-
32	SPID	SPID	GPIO32	-	-	-	2	3	-
33	GPIO33	GPIO33	GPIO33	FSPIHD	SUBSPIHD	SPIIO4	2	1	-
34	GPIO34	GPIO34	GPIO34	FSPICS0	SUBSPICS0	SPIIO5	2	1	-
35	GPIO35	GPIO35	GPIO35	FSPID	SUBSPID	SPIIO6	2	1	-
36	GPIO36	GPIO36	GPIO36	FSPICLK	SUBSPICLK	SPIIO7	2	1	-
37	GPIO37	GPIO37	GPIO37	FSPIQ	SUBSPIQ	SPIDQS	2	1	-
38	GPIO38	GPIO38	GPIO38	FSPiWP	SUBSPIWP	-	2	1	-
39	MTCK	MTCK	GPIO39	CLK_OUT3	SUBSPICS1	-	2	1*	-
40	MTDO	MTDO	GPIO40	CLK_OUT2	-	-	2	1	-
41	MTDI	MTDI	GPIO41	CLK_OUT1	-	-	2	1	-
42	MTMS	MTMS	GPIO42	-	-	-	2	1	-

GPIO	Pin Name	Function 0	Function 1	Function 2	Function 3	Function 4	DRV	RST	Notes
43	U0TXD	U0TXD	GPIO43	CLK_OUT1	-	-	2	4	-
44	U0RXD	U0RXD	GPIO44	CLK_OUT2	-	-	2	3	-
45	GPIO45	GPIO45	GPIO45	-	-	-	2	2	-
46	GPIO46	GPIO46	GPIO46	-	-	-	2	2	-
47	SPICLK_P	SPICLK_P_DIFF	GPIO47	SUBSPICLK_P_DIFF	-	-	2	1	-
48	SPICLK_N	SPICLK_N_DIFF	GPIO48	SUBSPICLK_N_DIFF	-	-	2	1	-

Drive Strength

“DRV” column shows the drive strength of each pin after reset:

- **0** - Drive current = ~5 mA
- **1** - Drive current = ~10 mA
- **2** - Drive current = ~20 mA
- **3** - Drive current = ~40 mA

Reset Configurations

“RST” column shows the default configuration of each pin after reset:

- **0** - IE = 0 (input disabled)
- **1** - IE = 1 (input enabled)
- **2** - IE = 1, WPD = 1 (input enabled, pull-down resistor enabled)
- **3** - IE = 1, WPU = 1 (input enabled, pull-up resistor enabled)
- **4** - OE = 1, WPU = 1 (output enabled, pull-up resistor enabled)
- **1*** - If `EFUSE_DIS_PAD_JTAG` = 1, the pin MTCK is left floating after reset, i.e. IE = 1. If `EFUSE_DIS_PAD_JTAG` = 0, the pin MTCK is connected to internal pull-up resistor, i.e. IE = 1, WPU = 1.

Note:

- **R** - Pin has RTC/analog functions via RTC IO MUX.

Please refer to Appendix A – ESP32-S3 Pin Lists in [ESP32-S3 Datasheet](#) for more details.

6.13 RTC IO MUX Pin List

Table 6-4 shows the RTC pins, their corresponding GPIO pins and RTC functions.

Table 6-4. RTC Functions of RTC IO MUX Pins

RTC GPIO Num	GPIO Num	Pin Name	RTC Function			
			0	1	2	3
0	0	GPIO0	RTC_GPIO0	-	-	sar_i2c_scl_0 ^a
1	1	GPIO1	RTC_GPIO1	-	-	sar_i2c_sda_0 ^a
2	2	GPIO2	RTC_GPIO2	-	-	sar_i2c_scl_1 ^a
3	3	GPIO3	RTC_GPIO3	-	-	sar_i2c_sda_1 ^a

Cont'd on next page

Table 6-4 – cont'd from previous page

RTC GPIO Num	GPIO Num	Pin Name	RTC Function			
			0	1	2	3
4	4	GPIO4	RTC_GPIO4	-	-	-
5	5	GPIO5	RTC_GPIO5	-	-	-
6	6	GPIO6	RTC_GPIO6	-	-	-
7	7	GPIO7	RTC_GPIO7	-	-	-
8	8	GPIO8	RTC_GPIO8	-	-	-
9	9	GPIO9	RTC_GPIO9	-	-	-
10	10	GPIO10	RTC_GPIO10	-	-	-
11	11	GPIO11	RTC_GPIO11	-	-	-
12	12	GPIO12	RTC_GPIO12	-	-	-
13	13	GPIO13	RTC_GPIO13	-	-	-
14	14	GPIO14	RTC_GPIO14	-	-	-
15	15	XTAL_32K_P	RTC_GPIO15	-	-	-
16	16	XTAL_32K_N	RTC_GPIO16	-	-	-
17	17	GPIO17	RTC_GPIO17	-	-	-
18	18	GPIO18	RTC_GPIO18	-	-	-
19	19	GPIO19	RTC_GPIO19	-	-	-
20	20	GPIO20	RTC_GPIO20	-	-	-
21	21	GPIO21	RTC_GPIO21	-	-	-

^a For more information on the configuration of sar_i2c_xx, see Section RTC I2C Controller in Chapter 2 *ULP Coprocessor (ULP-FSM, ULP-RISC-V)*.

Table 6-5 shows the RTC pins, their corresponding GPIO pins and analog functions.

Table 6-5. Analog Functions of RTC IO MUX Pins

RTC GPIO Num	GPIO Num	Pin Name	Analog Function	
			0	1
0	0	GPIO0	-	-
1	1	GPIO1	TOUCH1	ADC1_CH0
2	2	GPIO2	TOUCH2	ADC1_CH1
3	3	GPIO3	TOUCH3	ADC1_CH2
4	4	GPIO4	TOUCH4	ADC1_CH3
5	5	GPIO5	TOUCH5	ADC1_CH4
6	6	GPIO6	TOUCH6	ADC1_CH5
7	7	GPIO7	TOUCH7	ADC1_CH6
8	8	GPIO8	TOUCH8	ADC1_CH7
9	9	GPIO9	TOUCH9	ADC1_CH8
10	10	GPIO10	TOUCH10	ADC1_CH9
11	11	GPIO11	TOUCH11	ADC2_CH0
12	12	GPIO12	TOUCH12	ADC2_CH1
13	13	GPIO13	TOUCH13	ADC2_CH2
14	14	GPIO14	TOUCH14	ADC2_CH3

RTC GPIO Num	GPIO Num	Pin Name	Analog Function	
			0	1
15	15	XTAL_32K_P	XTAL_32K_P	ADC2_CH4
16	16	XTAL_32K_N	XTAL_32K_N	ADC2_CH5
17	17	GPIO17	-	ADC2_CH6
18	18	GPIO18	-	ADC2_CH7
19	19	GPIO19	USB_D-	ADC2_CH8
20	20	GPIO20	USB_D+	ADC2_CH9
21	21	GPIO21	-	-

6.14 Register Summary

6.14.1 GPIO Matrix Register Summary

The addresses in this section are relative to the GPIO base address provided in Table 4-3 in Chapter 4 *System and Memory*.

The abbreviations given in Column **Access** are explained in Section [Access Types for Registers](#).

Name	Description	Address	Access
GPIO Configuration Registers			
GPIO_BT_SELECT_REG	GPIO bit select register	0x0000	R/W
GPIO_OUT_REG	GPIO0 ~ 31 output register	0x0004	R/W
GPIO_OUT_W1TS_REG	GPIO0 ~ 31 output bit set register	0x0008	WO
GPIO_OUT_W1TC_REG	GPIO0 ~ 31 output bit clear register	0x000C	WO
GPIO_OUT1_REG	GPIO32 ~ 48 output register	0x0010	R/W
GPIO_OUT1_W1TS_REG	GPIO32 ~ 48 output bit set register	0x0014	WO
GPIO_OUT1_W1TC_REG	GPIO32 ~ 48 output bit clear register	0x0018	WO
GPIO_SDIO_SELECT_REG	GPIO SDIO selection register	0x001C	R/W
GPIO_ENABLE_REG	GPIO0 ~ 31 output enable register	0x0020	R/W
GPIO_ENABLE_W1TS_REG	GPIO0 ~ 31 output enable bit set register	0x0024	WO
GPIO_ENABLE_W1TC_REG	GPIO0 ~ 31 output enable bit clear register	0x0028	WO
GPIO_ENABLE1_REG	GPIO32 ~ 48 output enable register	0x002C	R/W
GPIO_ENABLE1_W1TS_REG	GPIO32 ~ 48 output enable bit set register	0x0030	WO
GPIO_ENABLE1_W1TC_REG	GPIO32 ~ 48 output enable bit clear register	0x0034	WO
GPIO_STRAP_REG	Strapping pin value register	0x0038	RO
GPIO_IN_REG	GPIO0 ~ 31 input register	0x003C	RO
GPIO_IN1_REG	GPIO32 ~ 48 input register	0x0040	RO
GPIO_PIN0_REG	Configuration for GPIO pin 0	0x0074	R/W
GPIO_PIN1_REG	Configuration for GPIO pin 1	0x0078	R/W
GPIO_PIN2_REG	Configuration for GPIO pin 2	0x007C	R/W
...
GPIO_PIN46_REG	Configuration for GPIO pin 46	0x012C	R/W
GPIO_PIN47_REG	Configuration for GPIO pin 47	0x0130	R/W
GPIO_PIN48_REG	Configuration for GPIO pin 48	0x0134	R/W
GPIO_FUNC0_IN_SEL_CFG_REG	Peripheral function 0 input selection register	0x0154	R/W

Name	Description	Address	Access
GPIO_FUNC1_IN_SEL_CFG_REG	Peripheral function 1 input selection register	0x0158	R/W
GPIO_FUNC2_IN_SEL_CFG_REG	Peripheral function 2 input selection register	0x015C	R/W
...
GPIO_FUNC253_IN_SEL_CFG_REG	Peripheral function 253 input selection register	0x0548	R/W
GPIO_FUNC254_IN_SEL_CFG_REG	Peripheral function 254 input selection register	0x054C	R/W
GPIO_FUNC255_IN_SEL_CFG_REG	Peripheral function 255 input selection register	0x0550	R/W
GPIO_FUNC0_OUT_SEL_CFG_REG	Peripheral output selection for GPIO0	0x0554	R/W
GPIO_FUNC1_OUT_SEL_CFG_REG	Peripheral output selection for GPIO1	0x0558	R/W
GPIO_FUNC2_OUT_SEL_CFG_REG	Peripheral output selection for GPIO2	0x055C	R/W
...
GPIO_FUNC47_OUT_SEL_CFG_REG	Peripheral output selection for GPIO47	0x0610	R/W
GPIO_FUNC48_OUT_SEL_CFG_REG	Peripheral output selection for GPIO47	0x0614	R/W
GPIO_CLOCK_GATE_REG	GPIO clock gating register	0x062C	R/W
Interrupt Status Registers			
GPIO_STATUS_REG	GPIO0 ~ 31 interrupt status register	0x0044	R/W
GPIO_STATUS1_REG	GPIO32 ~ 48 interrupt status register	0x0050	R/W
GPIO_CPU_INT_REG	GPIO0 ~ 31 CPU interrupt status register	0x005C	RO
GPIO_CPU_NMI_INT_REG	GPIO0 ~ 31 CPU non-maskable interrupt status register	0x0060	RO
GPIO_CPU_INT1_REG	GPIO32 ~ 48 CPU interrupt status register	0x0068	RO
GPIO_CPU_NMI_INT1_REG	GPIO32 ~ 48 CPU non-maskable interrupt status register	0x006C	RO
Interrupt Configuration Registers			
GPIO_STATUS_W1TS_REG	GPIO0 ~ 31 interrupt status bit set register	0x0048	WO
GPIO_STATUS_W1TC_REG	GPIO0 ~ 31 interrupt status bit clear register	0x004C	WO
GPIO_STATUS1_W1TS_REG	GPIO32 ~ 48 interrupt status bit set register	0x0054	WO
GPIO_STATUS1_W1TC_REG	GPIO32 ~ 48 interrupt status bit clear register	0x0058	WO
GPIO Interrupt Source Registers			
GPIO_STATUS_NEXT_REG	GPIO0 ~ 31 interrupt source register	0x014C	RO
GPIO_STATUS_NEXT1_REG	GPIO32 ~ 48 interrupt source register	0x0150	RO
Version Register			
GPIO_DATE_REG	Version control register	0x06FC	R/W

6.14.2 IO MUX Register Summary

The addresses in this section are relative to the IO MUX base address provided in Table 4-3 in Chapter 4 *System and Memory*.

The abbreviations given in Column **Access** are explained in Section [Access Types for Registers](#).

Name	Description	Address	Access
IO_MUX_PIN_CTRL_REG	Clock output configuration register	0x0000	R/W
IO_MUX_GPIO0_REG	Configuration register for pin GPIO0	0x0004	R/W
IO_MUX_GPIO1_REG	Configuration register for pin GPIO1	0x0008	R/W
IO_MUX_GPIO2_REG	Configuration register for pin GPIO2	0x000C	R/W

Name	Description	Address	Access
IO_MUX_GPIO3_REG	Configuration register for pin GPIO3	0x0010	R/W
IO_MUX_GPIO4_REG	Configuration register for pin GPIO4	0x0014	R/W
IO_MUX_GPIO5_REG	Configuration register for pin GPIO5	0x0018	R/W
IO_MUX_GPIO6_REG	Configuration register for pin GPIO6	0x001C	R/W
IO_MUX_GPIO7_REG	Configuration register for pin GPIO7	0x0020	R/W
IO_MUX_GPIO8_REG	Configuration register for pin GPIO8	0x0024	R/W
IO_MUX_GPIO9_REG	Configuration register for pin GPIO9	0x0028	R/W
IO_MUX_GPIO10_REG	Configuration register for pin GPIO10	0x002C	R/W
IO_MUX_GPIO11_REG	Configuration register for pin GPIO11	0x0030	R/W
IO_MUX_GPIO12_REG	Configuration register for pin GPIO12	0x0034	R/W
IO_MUX_GPIO13_REG	Configuration register for pin GPIO13	0x0038	R/W
IO_MUX_GPIO14_REG	Configuration register for pin GPIO14	0x003C	R/W
IO_MUX_GPIO15_REG	Configuration register for pad XTAL_32K_P	0x0040	R/W
IO_MUX_GPIO16_REG	Configuration register for pad XTAL_32K_N	0x0044	R/W
IO_MUX_GPIO17_REG	Configuration register for pad DAC_1	0x0048	R/W
IO_MUX_GPIO18_REG	Configuration register for pad DAC_2	0x004C	R/W
IO_MUX_GPIO19_REG	Configuration register for pin GPIO19	0x0050	R/W
IO_MUX_GPIO20_REG	Configuration register for pin GPIO20	0x0054	R/W
IO_MUX_GPIO21_REG	Configuration register for pin GPIO21	0x0058	R/W
IO_MUX_GPIO26_REG	Configuration register for pad SPICS1	0x006C	R/W
IO_MUX_GPIO27_REG	Configuration register for pad SPIHD	0x0070	R/W
IO_MUX_GPIO28_REG	Configuration register for pad SPIWP	0x0074	R/W
IO_MUX_GPIO29_REG	Configuration register for pad SPICS0	0x0078	R/W
IO_MUX_GPIO30_REG	Configuration register for pad SPICLK	0x007C	R/W
IO_MUX_GPIO31_REG	Configuration register for pad SPIQ	0x0080	R/W
IO_MUX_GPIO32_REG	Configuration register for pad SPID	0x0084	R/W
IO_MUX_GPIO33_REG	Configuration register for pin GPIO33	0x0088	R/W
IO_MUX_GPIO34_REG	Configuration register for pin GPIO34	0x008C	R/W
IO_MUX_GPIO35_REG	Configuration register for pin GPIO35	0x0090	R/W
IO_MUX_GPIO36_REG	Configuration register for pin GPIO36	0x0094	R/W
IO_MUX_GPIO37_REG	Configuration register for pin GPIO37	0x0098	R/W
IO_MUX_GPIO38_REG	Configuration register for pin GPIO38	0x009C	R/W
IO_MUX_GPIO39_REG	Configuration register for pad MTCK	0x00A0	R/W
IO_MUX_GPIO40_REG	Configuration register for pad MTDO	0x00A4	R/W
IO_MUX_GPIO41_REG	Configuration register for pad MTDI	0x00A8	R/W
IO_MUX_GPIO42_REG	Configuration register for pad MTMS	0x00AC	R/W
IO_MUX_GPIO43_REG	Configuration register for pad U0TXD	0x00B0	R/W
IO_MUX_GPIO44_REG	Configuration register for pad U0RXD	0x00B4	R/W
IO_MUX_GPIO45_REG	Configuration register for pin GPIO45	0x00B8	R/W
IO_MUX_GPIO46_REG	Configuration register for pin GPIO46	0x00BC	R/W
IO_MUX_GPIO47_REG	Configuration register for pin GPIO47	0x00C0	R/W
IO_MUX_GPIO48_REG	Configuration register for pin GPIO48	0x00C4	R/W

6.14.3 SDM Output Register Summary

The addresses in this section are relative to (GPIO base address provided in Table 4-3 in Chapter 4 *System and Memory* + 0x0F00).

The abbreviations given in Column **Access** are explained in Section [Access Types for Registers](#).

Name	Description	Address	Access
Configuration Registers			
GPIO_SIGMADELTA0_REG	Duty Cycle Configure Register of SDM0	0x0000	R/W
GPIO_SIGMADELTA1_REG	Duty Cycle Configure Register of SDM1	0x0004	R/W
GPIO_SIGMADELTA2_REG	Duty Cycle Configure Register of SDM2	0x0008	R/W
GPIO_SIGMADELTA3_REG	Duty Cycle Configure Register of SDM3	0x000C	R/W
GPIO_SIGMADELTA4_REG	Duty Cycle Configure Register of SDM4	0x0010	R/W
GPIO_SIGMADELTA5_REG	Duty Cycle Configure Register of SDM5	0x0014	R/W
GPIO_SIGMADELTA6_REG	Duty Cycle Configure Register of SDM6	0x0018	R/W
GPIO_SIGMADELTA7_REG	Duty Cycle Configure Register of SDM7	0x001C	R/W
GPIO_SIGMADELTA_CG_REG	Clock Gating Configure Register	0x0020	R/W
GPIO_SIGMADELTA_MISC_REG	MISC Register	0x0024	R/W
GPIO_SIGMADELTA_VERSION_REG	Version Control Register	0x0028	R/W

6.14.4 RTC IO MUX Register Summary

The addresses in this section are relative to (Low-Power Management base address provided in Table 4-3 in Chapter 4 *System and Memory* + 0x0400).

The abbreviations given in Column **Access** are explained in Section [Access Types for Registers](#).

Name	Description	Address	Access
GPIO configuration/data registers			
RTC_GPIO_OUT_REG	RTC GPIO output register	0x0000	R/W
RTC_GPIO_OUT_W1TS_REG	RTC GPIO output bit set register	0x0004	WO
RTC_GPIO_OUT_W1TC_REG	RTC GPIO output bit clear register	0x0008	WO
RTC_GPIO_ENABLE_REG	RTC GPIO output enable register	0x000C	R/W
RTC_GPIO_ENABLE_W1TS_REG	RTC GPIO output enable bit set register	0x0010	WO
RTC_GPIO_ENABLE_W1TC_REG	RTC GPIO output enable bit clear register	0x0014	WO
RTC_GPIO_STATUS_REG	RTC GPIO interrupt status register	0x0018	R/W
RTC_GPIO_STATUS_W1TS_REG	RTC GPIO interrupt status bit set register	0x001C	WO
RTC_GPIO_STATUS_W1TC_REG	RTC GPIO interrupt status bit clear register	0x0020	WO
RTC_GPIO_IN_REG	RTC GPIO input register	0x0024	RO
RTC_GPIO_PIN0_REG	RTC configuration for pin 0	0x0028	R/W
RTC_GPIO_PIN1_REG	RTC configuration for pin 1	0x002C	R/W
RTC_GPIO_PIN2_REG	RTC configuration for pin 2	0x0030	R/W
RTC_GPIO_PIN3_REG	RTC configuration for pin 3	0x0034	R/W
RTC_GPIO_PIN4_REG	RTC configuration for pin 4	0x0038	R/W
RTC_GPIO_PIN5_REG	RTC configuration for pin 5	0x003C	R/W
RTC_GPIO_PIN6_REG	RTC configuration for pin 6	0x0040	R/W

Name	Description	Address	Access
RTC_GPIO_PIN7_REG	RTC configuration for pin 7	0x0044	R/W
RTC_GPIO_PIN8_REG	RTC configuration for pin 8	0x0048	R/W
RTC_GPIO_PIN9_REG	RTC configuration for pin 9	0x004C	R/W
RTC_GPIO_PIN10_REG	RTC configuration for pin 10	0x0050	R/W
RTC_GPIO_PIN11_REG	RTC configuration for pin 11	0x0054	R/W
RTC_GPIO_PIN12_REG	RTC configuration for pin 12	0x0058	R/W
RTC_GPIO_PIN13_REG	RTC configuration for pin 13	0x005C	R/W
RTC_GPIO_PIN14_REG	RTC configuration for pin 14	0x0060	R/W
RTC_GPIO_PIN15_REG	RTC configuration for pin 15	0x0064	R/W
RTC_GPIO_PIN16_REG	RTC configuration for pin 16	0x0068	R/W
RTC_GPIO_PIN17_REG	RTC configuration for pin 17	0x006C	R/W
RTC_GPIO_PIN18_REG	RTC configuration for pin 18	0x0070	R/W
RTC_GPIO_PIN19_REG	RTC configuration for pin 19	0x0074	R/W
RTC_GPIO_PIN20_REG	RTC configuration for pin 20	0x0078	R/W
RTC_GPIO_PIN21_REG	RTC configuration for pin 21	0x007C	R/W
GPIO RTC function configuration registers			
RTC_IO_TOUCH_PAD0_REG	Touch pin 0 configuration register	0x0084	R/W
RTC_IO_TOUCH_PAD1_REG	Touch pin 1 configuration register	0x0088	R/W
RTC_IO_TOUCH_PAD2_REG	Touch pin 2 configuration register	0x008C	R/W
RTC_IO_TOUCH_PAD3_REG	Touch pin 3 configuration register	0x0090	R/W
RTC_IO_TOUCH_PAD4_REG	Touch pin 4 configuration register	0x0094	R/W
RTC_IO_TOUCH_PAD5_REG	Touch pin 5 configuration register	0x0098	R/W
RTC_IO_TOUCH_PAD6_REG	Touch pin 6 configuration register	0x009C	R/W
RTC_IO_TOUCH_PAD7_REG	Touch pin 7 configuration register	0x00A0	R/W
RTC_IO_TOUCH_PAD8_REG	Touch pin 8 configuration register	0x00A4	R/W
RTC_IO_TOUCH_PAD9_REG	Touch pin 9 configuration register	0x00A8	R/W
RTC_IO_TOUCH_PAD10_REG	Touch pin 10 configuration register	0x00AC	R/W
RTC_IO_TOUCH_PAD11_REG	Touch pin 11 configuration register	0x00B0	R/W
RTC_IO_TOUCH_PAD12_REG	Touch pin 12 configuration register	0x00B4	R/W
RTC_IO_TOUCH_PAD13_REG	Touch pin 13 configuration register	0x00B8	R/W
RTC_IO_TOUCH_PAD14_REG	Touch pin 14 configuration register	0x00BC	R/W
RTC_IO_XTAL_32P_PAD_REG	32 kHz crystal P-pin configuration register	0x00C0	R/W
RTC_IO_XTAL_32N_PAD_REG	32 kHz crystal N-pin configuration register	0x00C4	R/W
RTC_IO_RTC_PAD17_REG	RTC pin 17 configuration register	0x00C8	R/W
RTC_IO_RTC_PAD18_REG	RTC pin 18 configuration register	0x00CC	R/W
RTC_IO_RTC_PAD19_REG	RTC pin 19 configuration register	0x00D0	R/W
RTC_IO_RTC_PAD20_REG	RTC pin 20 configuration register	0x00D4	R/W
RTC_IO_RTC_PAD21_REG	RTC pin 21 configuration register	0x00D8	R/W
RTC_IO_XTL_EXT_CTR_REG	Crystal power down enable GPIO source	0x00E0	R/W
RTC_IO_SAR_I2C_IO_REG	RTC I2C pin selection	0x00E4	R/W
Version Register			
RTC_IO_DATE_REG	Version control register	0x01FC	R/W

6.15 Registers

6.15.1 GPIO Matrix Registers

The addresses in this section are relative to the GPIO base address provided in Table 4-3 in Chapter 4 *System and Memory*.

Register 6.1. GPIO_BT_SELECT_REG (0x0000)

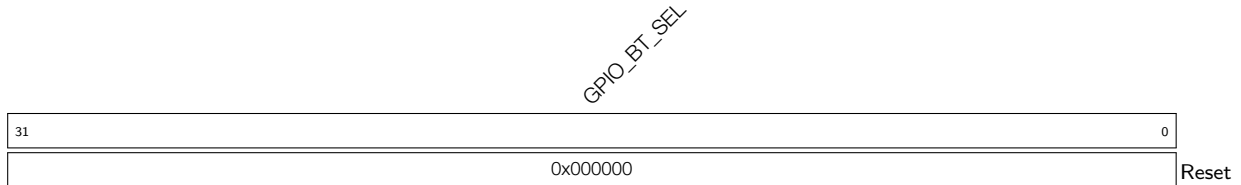

GPIO_BT_SEL Reserved (R/W)

Register 6.2. GPIO_OUT_REG (0x0004)

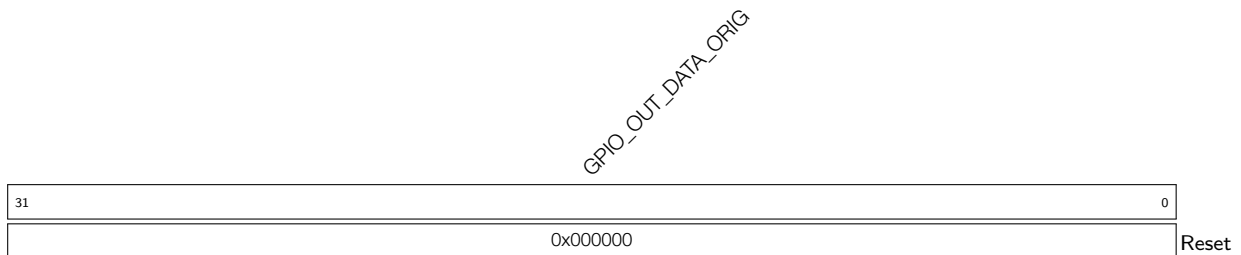

GPIO_OUT_DATA_ORIG GPIO0 ~ 21 and GPIO26 ~ 31 output values in simple GPIO output mode. The values of bit0 ~ bit21 correspond to the output values of GPIO0 ~ 21, and bit26 ~ bit31 to GPIO26 ~ 31. Bit22 ~ bit25 are invalid. (R/W)

Register 6.3. GPIO_OUT_W1TS_REG (0x0008)

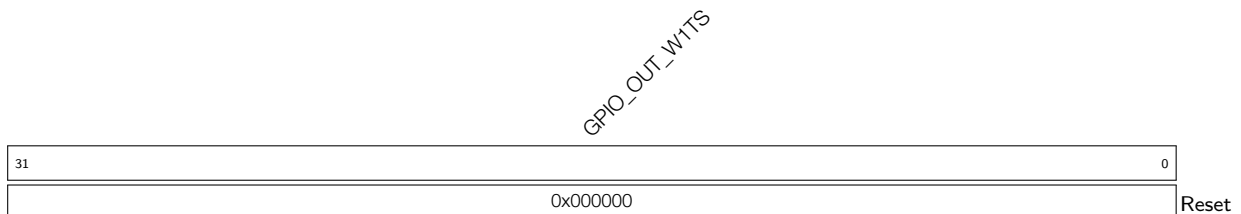

GPIO_OUT_W1TS GPIO0 ~ 31 output set register. If the value 1 is written to a bit here, the corresponding bit in **GPIO_OUT_REG** will be set to 1. Recommended operation: use this register to set **GPIO_OUT_REG**. (WO)

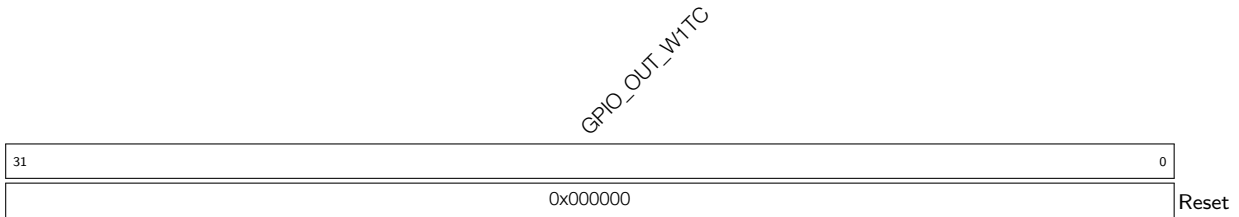
Register 6.4. GPIO_OUT_W1TC_REG (0x000C)

GPIO_OUT_W1TC GPIO0 ~ 31 output clear register. If the value 1 is written to a bit here, the corresponding bit in [GPIO_OUT_REG](#) will be cleared. Recommended operation: use this register to clear [GPIO_OUT_REG](#). (WO)

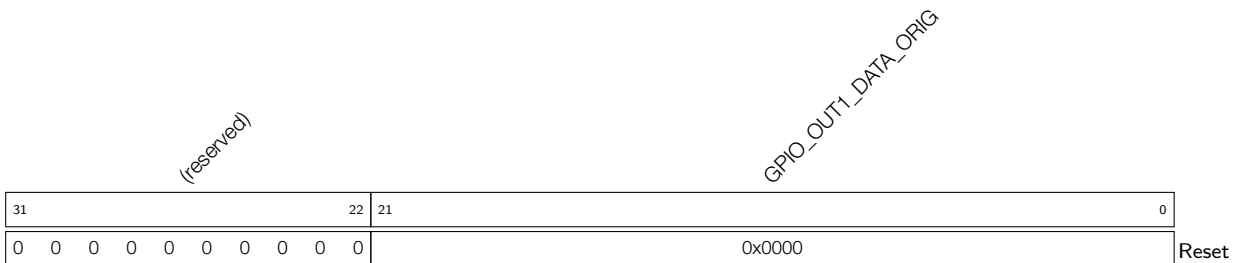
Register 6.5. GPIO_OUT1_REG (0x0010)

GPIO_OUT1_DATA_ORIG GPIO32 ~ 48 output value in simple GPIO output mode. The values of bit0 ~ bit16 correspond to GPIO32 ~ GPIO48. Bit17 ~ bit21 are invalid. (R/W)

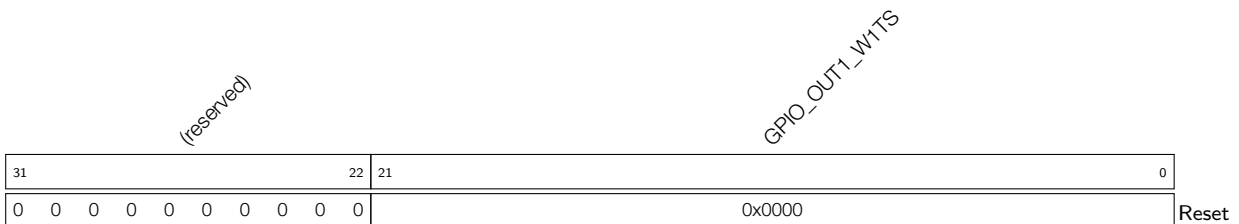
Register 6.6. GPIO_OUT1_W1TS_REG (0x0014)

GPIO_OUT1_W1TS GPIO32 ~ 48 output value set register. If the value 1 is written to a bit here, the corresponding bit in [GPIO_OUT1_REG](#) will be set to 1. Recommended operation: use this register to set [GPIO_OUT1_REG](#). (WO)

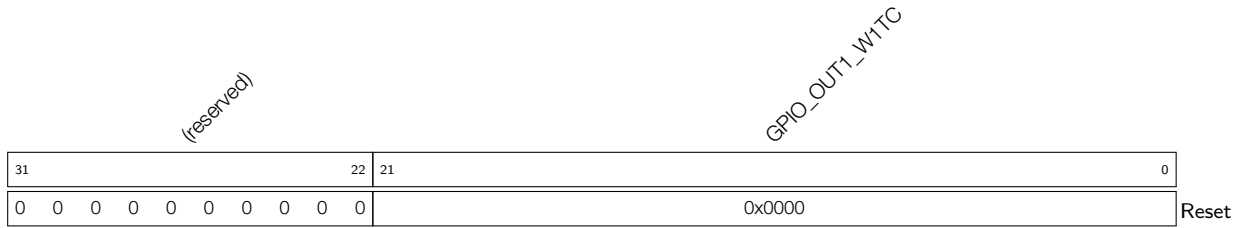
Register 6.7. GPIO_OUT1_W1TC_REG (0x0018)

GPIO_OUT1_W1TC GPIO32 ~ 48 output value clear register. If the value 1 is written to a bit here, the corresponding bit in [GPIO_OUT1_REG](#) will be cleared. Recommended operation: use this register to clear [GPIO_OUT1_REG](#). (WO)

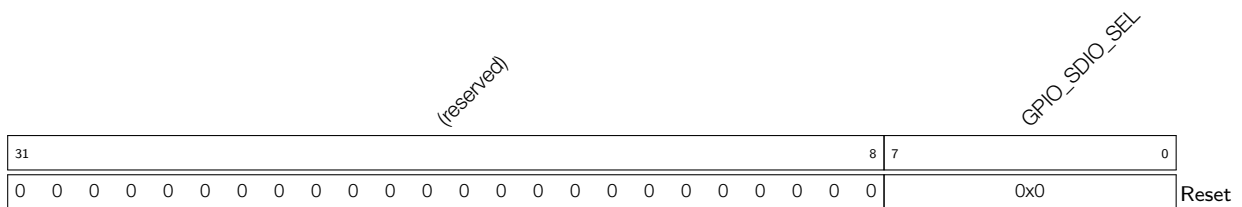
Register 6.8. GPIO_SDIO_SELECT_REG (0x001C)

GPIO_SDIO_SEL Reserved (R/W)

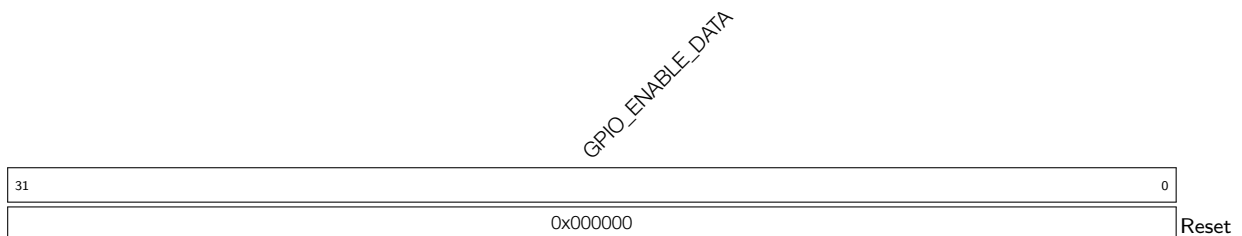
Register 6.9. GPIO_ENABLE_REG (0x0020)

GPIO_ENABLE_DATA GPIO0~31 output enable register. (R/W)

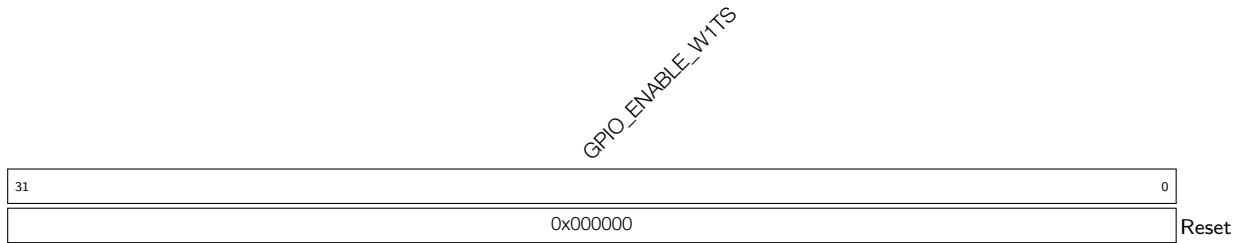
Register 6.10. GPIO_ENABLE_W1TS_REG (0x0024)

GPIO_ENABLE_W1TS GPIO0 ~ 31 output enable set register. If the value 1 is written to a bit here, the corresponding bit in [GPIO_ENABLE_REG](#) will be set to 1. Recommended operation: use this register to set [GPIO_ENABLE_REG](#). (WO)

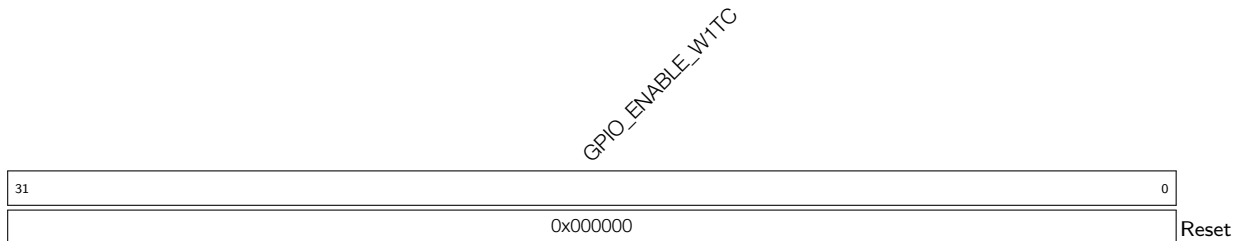
Register 6.11. GPIO_ENABLE_W1TC_REG (0x0028)

GPIO_ENABLE_W1TC GPIO0 ~ 31 output enable clear register. If the value 1 is written to a bit here, the corresponding bit in [GPIO_ENABLE_REG](#) will be cleared. Recommended operation: use this register to clear [GPIO_ENABLE_REG](#). (WO)

Register 6.12. GPIO_ENABLE1_REG (0x002C)

GPIO_ENABLE1_DATA GPIO32 ~ 48 output enable register. (R/W)

Register 6.13. GPIO_ENABLE1_W1TS_REG (0x0030)

(reserved)										GPIO_ENABLE1_W1TS											
31										22	21										0
0 0 0 0 0 0 0 0 0 0										0x0000										Reset	

GPIO_ENABLE1_W1TS GPIO32 ~ 48 output enable set register. If the value 1 is written to a bit here, the corresponding bit in [GPIO_ENABLE1_REG](#) will be set to 1. Recommended operation: use this register to set [GPIO_ENABLE1_REG](#). (WO)

Register 6.14. GPIO_ENABLE1_W1TC_REG (0x0034)

(reserved)										GPIO_ENABLE1_W1TC											
31										22	21										0
0 0 0 0 0 0 0 0 0 0										0x0000										Reset	

GPIO_ENABLE1_W1TC GPIO32 ~ 48 output enable clear register. If the value 1 is written to a bit here, the corresponding bit in [GPIO_ENABLE1_REG](#) will be cleared. Recommended operation: use this register to clear [GPIO_ENABLE1_REG](#). (WO)

Register 6.15. GPIO_STRAP_REG (0x0038)

(reserved)															GPIO_STRAPPING					
31											16	15						0		
0 0 0 0 0 0 0 0 0 0 0 0 0 0 0															0					Reset

GPIO_STRAPPING GPIO strapping values: bit5 ~ bit2 correspond to strapping pins GPIO3, GPIO45, GPIO0, and GPIO46 respectively. (RO)

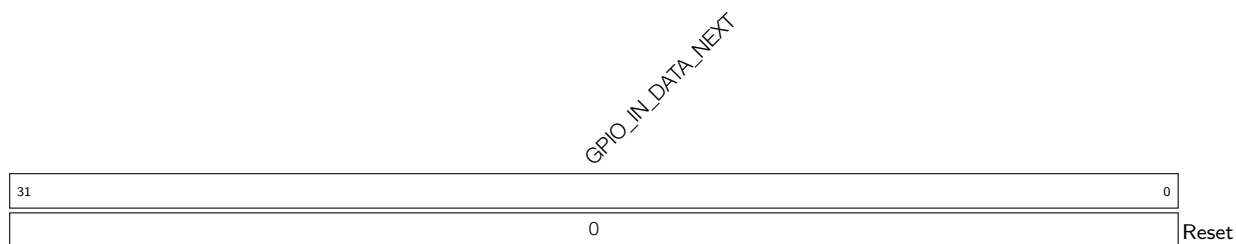
Register 6.16. GPIO_IN_REG (0x003C)

GPIO_IN_DATA_NEXT GPIO0 ~ 31 input value. Each bit represents a pin input value, 1 for high level and 0 for low level. (RO)

Register 6.17. GPIO_IN1_REG (0x0040)

GPIO_IN_DATA1_NEXT GPIO32 ~ 48 input value. Each bit represents a pin input value. (RO)

Register 6.18. GPIO_PIN n _REG (n : 0-48) (0x0074+0x4* n)

(reserved)																GPIO_PIN n _INT_ENA		GPIO_PIN n _CONFIG		GPIO_PIN n _WAKEUP_ENABLE		GPIO_PIN n _INT_TYPE		(reserved)		GPIO_PIN n _SYNC1_BYPASS		GPIO_PIN n _PAD_DRIVER		GPIO_PIN n _SYNC2_BYPASS		
31																18	17	13	12	11	10	9	7	6	5	4	3	2	1	0		
0 0 0 0 0 0 0 0 0 0 0 0 0 0 0 0																0x0		0x0		0		0x0		0 0		0x0		0		0x0		Reset

GPIO_PIN n _SYNC2_BYPASS For the second stage synchronization, GPIO input data can be synchronized on either edge of the APB clock. 0: no synchronization; 1: synchronized on falling edge; 2 and 3: synchronized on rising edge. (R/W)

GPIO_PIN n _PAD_DRIVER Pin driver selection. 0: normal output; 1: open drain output. (R/W)

GPIO_PIN n _SYNC1_BYPASS For the first stage synchronization, GPIO input data can be synchronized on either edge of the APB clock. 0: no synchronization; 1: synchronized on falling edge; 2 and 3: synchronized on rising edge. (R/W)

GPIO_PIN n _INT_TYPE Interrupt type selection. 0: GPIO interrupt disabled; 1: rising edge trigger; 2: falling edge trigger; 3: any edge trigger; 4: low level trigger; 5: high level trigger. (R/W)

GPIO_PIN n _WAKEUP_ENABLE GPIO wake-up enable bit, only wakes up the CPU from Light-sleep. (R/W)

GPIO_PIN n _CONFIG Reserved (R/W)

GPIO_PIN n _INT_ENA Interrupt enable bits. bit13: CPU interrupt enabled; bit14: CPU non-maskable interrupt enabled. (R/W)

Register 6.19. GPIO_FUNC y _IN_SEL_CFG_REG (y : 0-255) (0x0154+0x4* y)

(reserved)																							GPIO_SIG y _IN_SEL		GPIO_FUNC y _IN_INV_SEL		GPIO_FUNC y _IN_SEL		
31																					8	7	6	5	0				
0 0																							0 0		0x0		0x0		Reset

GPIO_FUNC y _IN_SEL Selection control for peripheral input signal Y , selects a pin from the 48 GPIO matrix pins to connect this input signal. Or selects 0x38 for a constantly high input or 0x3C for a constantly low input. (R/W)

GPIO_FUNC y _IN_INV_SEL 1: Invert the input value; 0: Do not invert the input value. (R/W)

GPIO_SIG y _IN_SEL Bypass GPIO matrix. 1: route signals via GPIO matrix, 0: connect signals directly to peripheral configured in IO MUX. (R/W)

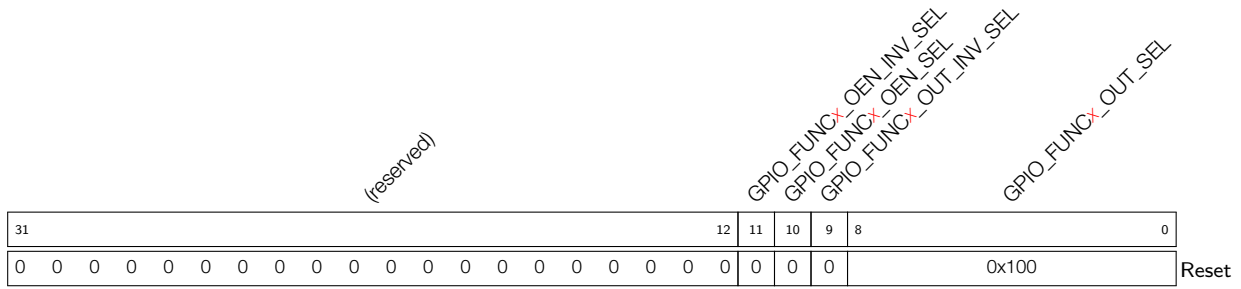
Register 6.20. GPIO_FUNC x _OUT_SEL_CFG_REG (x : 0-48) (0x0554+0x4 \times x)

GPIO_FUNC x _OUT_SEL Selection control for GPIO output X . If a value Y ($0 \leq Y < 256$) is written to this field, the peripheral output signal Y will be connected to GPIO output X . If a value 256 is written to this field, bit X of [GPIO_OUT_REG/GPIO_OUT1_REG](#) and [GPIO_ENABLE_REG/GPIO_ENABLE1_REG](#) will be selected as the output value and output enable. (R/W)

GPIO_FUNC x _OUT_INV_SEL 0: Do not invert the output value; 1: Invert the output value. (R/W)

GPIO_FUNC x _OEN_SEL 0: Use output enable signal from peripheral; 1: Force the output enable signal to be sourced from [GPIO_ENABLE_REG\[x\]](#). (R/W)

GPIO_FUNC n _OEN_INV_SEL 0: Do not invert the output enable signal; 1: Invert the output enable signal. (R/W)

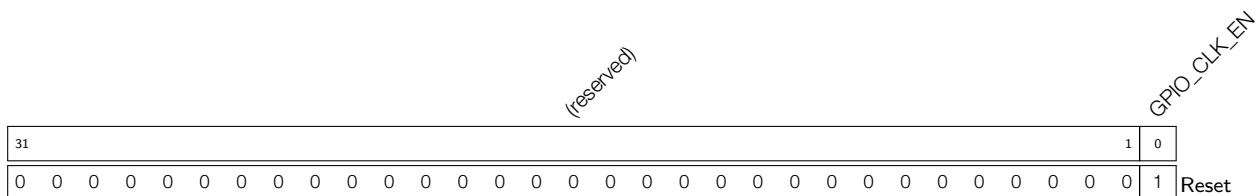
Register 6.21. GPIO_CLOCK_GATE_REG (0x062C)

GPIO_CLK_EN Clock gating enable bit. If set to 1, the clock is free running. (R/W)

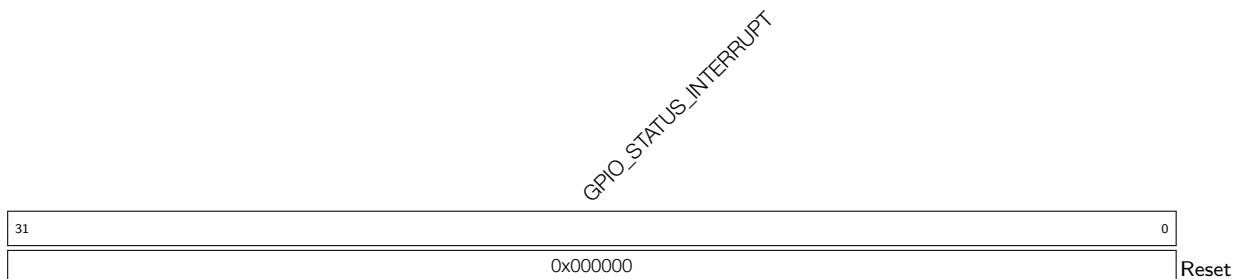
Register 6.22. GPIO_STATUS_REG (0x0044)

GPIO_STATUS_INTERRUPT GPIO0 ~ 31 interrupt status register. (R/W)

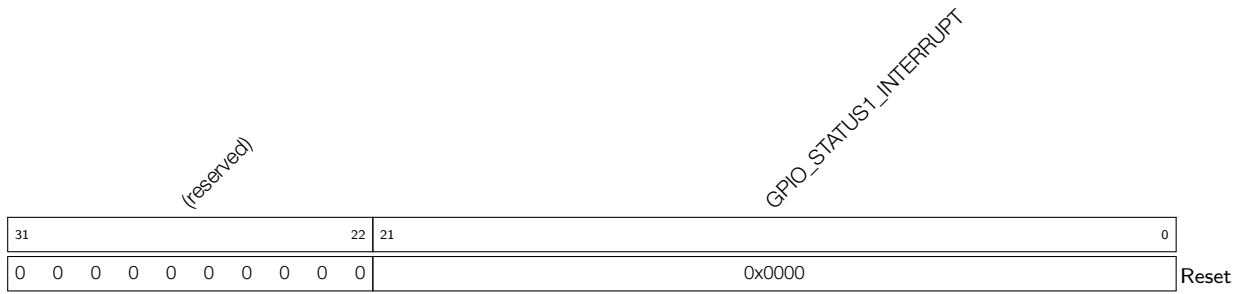
Register 6.23. GPIO_STATUS1_REG (0x0050)

GPIO_STATUS1_INTERRUPT GPIO32 ~ 48 interrupt status register. (R/W)

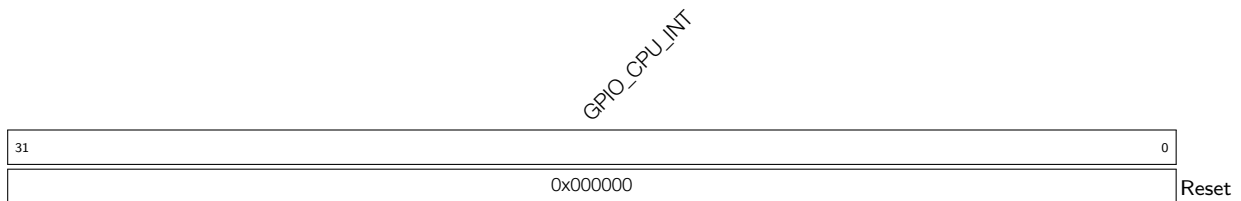
Register 6.24. GPIO_CPU_INT_REG (0x005C)

GPIO_CPU_INT GPIO0 ~ 31 CPU interrupt status. This interrupt status is corresponding to the bit in [GPIO_STATUS_REG](#) when assert (high) enable signal (bit13 of [GPIO_PIN \$n\$ _REG](#)). (RO)

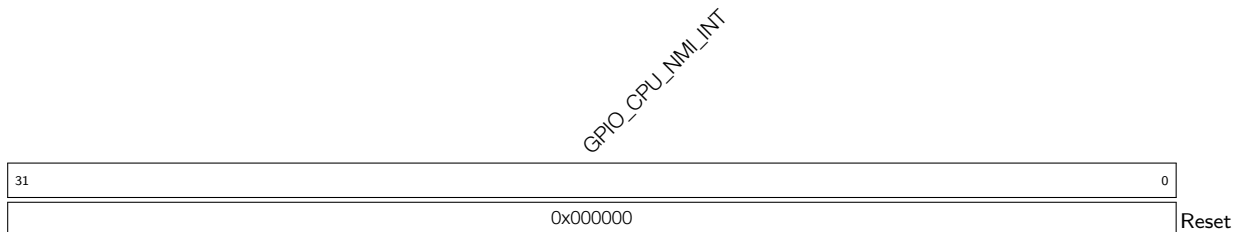
Register 6.25. GPIO_CPU_NMI_INT_REG (0x0060)

GPIO_CPU_NMI_INT GPIO0 ~ 31 CPU non-maskable interrupt status. This interrupt status is corresponding to the bit in [GPIO_STATUS_REG](#) when assert (high) enable signal (bit 14 of [GPIO_PIN \$n\$ _REG](#)). (RO)

Register 6.26. GPIO_CPU_INT1_REG (0x0068)

31	(reserved)	22	21	GPIO_CPU1_INT	0
0 0 0 0 0 0 0 0 0 0 0				0x0000	
Reset					

GPIO_CPU1_INT GPIO32 ~ 48 CPU interrupt status. This interrupt status is corresponding to the bit in [GPIO_STATUS1_REG](#) when assert (high) enable signal (bit 13 of [GPIO_PIN \$n\$ _REG](#)). (RO)

Register 6.27. GPIO_CPU_NMI_INT1_REG (0x006C)

31	(reserved)	22	21	GPIO_CPU_NMI1_INT	0
0 0 0 0 0 0 0 0 0 0 0				0x0000	
Reset					

GPIO_CPU_NMI1_INT GPIO32 ~ 48 CPU non-maskable interrupt status. This interrupt status is corresponding to bit in [GPIO_STATUS1_REG](#) when assert (high) enable signal (bit 14 of [GPIO_PIN \$n\$ _REG](#)). (RO)

Register 6.28. GPIO_STATUS_W1TS_REG (0x0048)

31	GPIO_STATUS_W1TS	0
0x000000		
Reset		

GPIO_STATUS_W1TS GPIO0 ~ 31 interrupt status set register. If the value 1 is written to a bit here, the corresponding bit in [GPIO_STATUS_INTERRUPT](#) will be set to 1. Recommended operation: use this register to set [GPIO_STATUS_INTERRUPT](#). (WO)

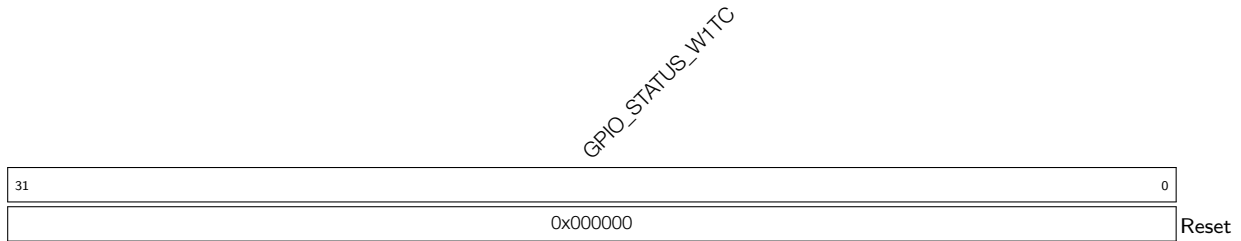
Register 6.29. GPIO_STATUS_W1TC_REG (0x004C)

GPIO_STATUS_W1TC GPIO0 ~ 31 interrupt status clear register. If the value 1 is written to a bit here, the corresponding bit in [GPIO_STATUS_INTERRUPT](#) will be cleared. Recommended operation: use this register to clear [GPIO_STATUS_INTERRUPT](#). (WO)

Register 6.30. GPIO_STATUS1_W1TS_REG (0x0054)

GPIO_STATUS1_W1TS GPIO32 ~ 48 interrupt status set register. If the value 1 is written to a bit here, the corresponding bit in [GPIO_STATUS1_REG](#) will be set to 1. Recommended operation: use this register to set [GPIO_STATUS1_REG](#). (WO)

Register 6.31. GPIO_STATUS1_W1TC_REG (0x0058)

GPIO_STATUS1_W1TC GPIO32 ~ 48 interrupt status clear register. If the value 1 is written to a bit here, the corresponding bit in [GPIO_STATUS1_REG](#) will be cleared. Recommended operation: use this register to clear [GPIO_STATUS1_REG](#). (WO)

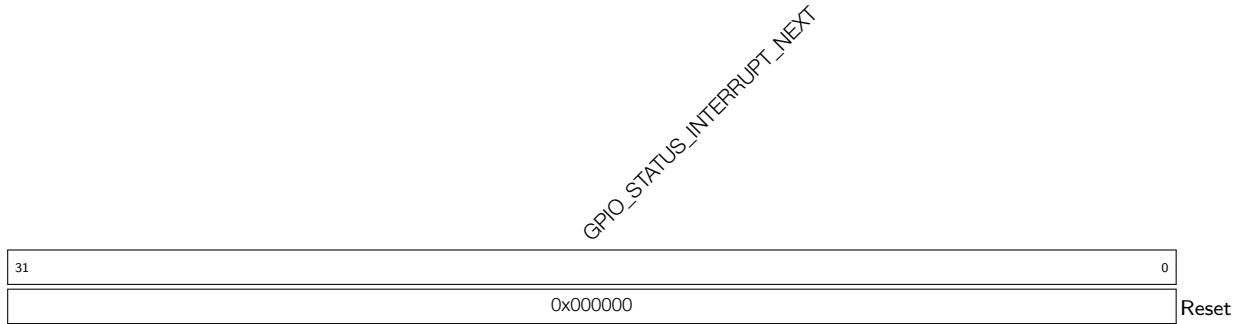
Register 6.32. GPIO_STATUS_NEXT_REG (0x014C)

GPIO_STATUS_INTERRUPT_NEXT Interrupt source signal of GPIO0 ~ 31, could be rising edge interrupt, falling edge interrupt, level sensitive interrupt and any edge interrupt. (RO)

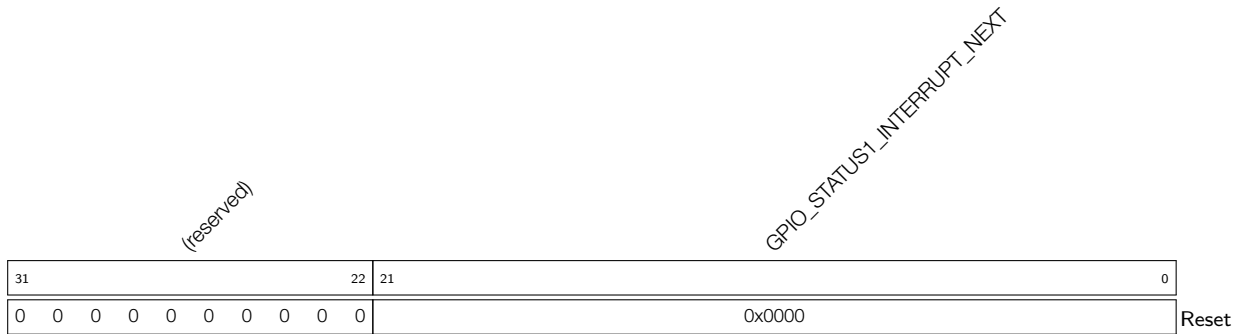
Register 6.33. GPIO_STATUS_NEXT1_REG (0x0150)

GPIO_STATUS1_INTERRUPT_NEXT Interrupt source signal of GPIO32 ~ 48. (RO)

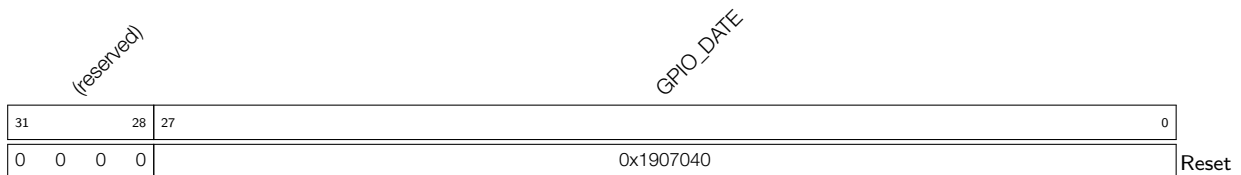
Register 6.34. GPIO_DATE_REG (0x06FC)

GPIO_DATE Version control register (R/W)

6.15.2 IO MUX Registers

The addresses in this section are relative to the IO MUX base address provided in Table 4-3 in Chapter 4 *System and Memory*.

Register 6.35. IO_MUX_PIN_CTRL_REG (0x0000)

(reserved)																IO_MUX_PAD_POWER_CTRL				IO_MUX_SWITCH_PRT_NUM				IO_MUX_PIN_CTRL_CLK3				IO_MUX_PIN_CTRL_CLK2				IO_MUX_PIN_CTRL_CLK1				
31																16	15	14	12	11			8	7			4	3			0					
0x0																0x0				0x2				0x0				0x0				0x0				Reset

IO_MUX_PIN_CTRL_CLK_x If you want to output clock for I2S0 to: (R/W)

CLK_OUT1 then set IO_MUX_PIN_CTRL_CLK1 = 0x0

CLK_OUT2 then set IO_MUX_PIN_CTRL_CLK2 = 0x0;

CLK_OUT3 then set IO_MUX_PIN_CTRL_CLK3 = 0x0.

If you want to output clock for I2S1 to: (R/W)

CLK_OUT1 then set IO_MUX_PIN_CTRL_CLK1 = 0xF

CLK_OUT2 then set IO_MUX_PIN_CTRL_CLK2 = 0xF;

CLK_OUT3 then set IO_MUX_PIN_CTRL_CLK3 = 0xF.

Note:

Only the above mentioned combinations of clock source and clock output pins are possible.

The CLK_OUT1 ~ 3 can be found in [IO_MUX Pin Function List](#).

IO_MUX_SWITCH_PRT_NUM GPIO pin power switch delay, delay unit is one APB clock. (R/W)

IO_MUX_PAD_POWER_CTRL Select power voltage for GPIO33 ~ 37. 1: select VDD_SPI 1.8 V; 0: select VDD3P3_CPU 3.3 V. (R/W)

Register 6.36. IO_MUX_*n***_REG** (*n*: GPIO0-GPIO21, GPIO26-GPIO48) (0x0010+4**n*)

(reserved)																IO_MUX_FILTER_EN	IO_MUX_MCU_SEL	IO_MUX_FUN_DRV	IO_MUX_FUN_IE	IO_MUX_FUN_WPU	IO_MUX_MCU_WPD	IO_MUX_MCU_DRV	IO_MUX_MCU_IE	IO_MUX_MCU_WPU	IO_MUX_SLP_SEL	IO_MUX_MCU_OE					
31	16	15	14	12	11	10	9	8	7	6	5	4	3	2	1	0															
0	0	0	0	0	0	0	0	0	0	0	0	0	0	0	0	0	0x0	0x0	0x2	0	0	0	00	0	0	0	0	0	0	0	Reset

IO_MUX_MCU_OE Output enable of the pin in sleep mode. 1: Output enabled; 0: Output disabled. (R/W)

IO_MUX_SLP_SEL Sleep mode selection of this pin. Set to 1 to put the pin in sleep mode. (R/W)

IO_MUX_MCU_WPD Pull-down enable of the pin during sleep mode. 1: Internal pull-down enabled; 0: Internal pull-down disabled. (R/W)

IO_MUX_MCU_WPU Pull-up enable of the pin during sleep mode. 1: Internal pull-up enabled; 0: Internal pull-up disabled.

IO_MUX_MCU_IE Input enable of the pin during sleep mode. 1: Input enabled; 0: Input disabled. (R/W)

IO_MUX_MCU_DRV Configures the drive strength of GPIO n during sleep mode.

- 0: ~5 mA
 - 1: ~ 10 mA
 - 2: ~ 20 mA
 - 3: ~40 mA
- (R/W)

IO_MUX_FUN_WPD Pull-down enable of the pin. 1: Pull-down enabled; 0: Pull-down disabled. (R/W)

IO_MUX_FUN_WPU Pull-up enable of the pin. 1: Internal pull-up enabled; 0: Internal pull-up disabled. (R/W)

IO_MUX_FUN_IE Input enable of the pin. 1: Input enabled; 0: Input disabled. (R/W)

IO_MUX_FUN_DRV Select the drive strength of the pin. 0: ~5 mA; 1: ~10 mA; 2: ~20 mA; 3: ~40 mA. (R/W)

IO_MUX_MCU_SEL Select IO MUX function for this signal. 0: Select Function 0; 1: Select Function 1, etc. (R/W)

IO_MUX_FILTER_EN Enable filter for pin input signals. 1: Filter enabled; 0: Filter disabled. (R/W)

6.15.3 SDM Output Registers

The addresses in this section are relative to (GPIO base address provided in Table 4-3 in Chapter 4 *System and Memory* + 0x0F00).

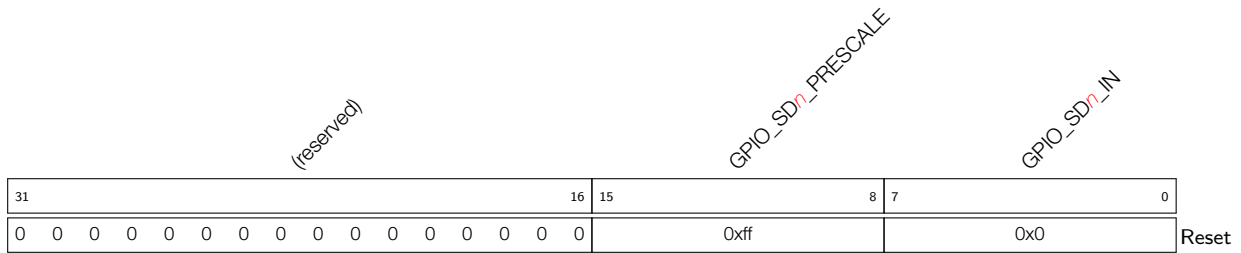
Register 6.37. GPIO_SIGMADELTA_n_REG (n: 0-7) (0x0000+4*n)

GPIO_SD_n_IN This field is used to configure the duty cycle of sigma delta modulation output. (R/W)

GPIO_SD_n_PRESCALE This field is used to set a divider value to divide APB clock. (R/W)

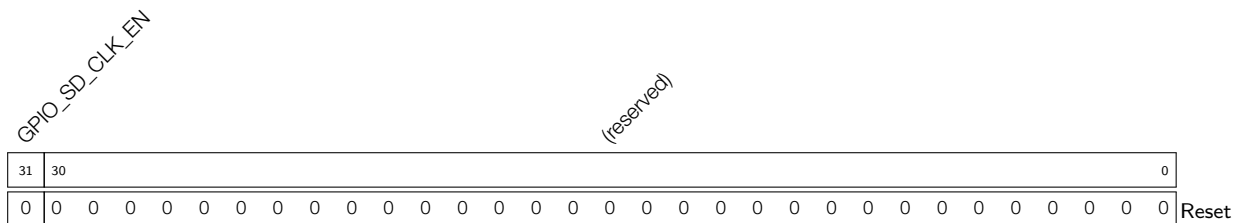
Register 6.38. GPIO_SIGMADELTA_CG_REG (0x0020)

GPIO_SD_CLK_EN Clock enable bit of configuration registers for sigma delta modulation. (R/W)

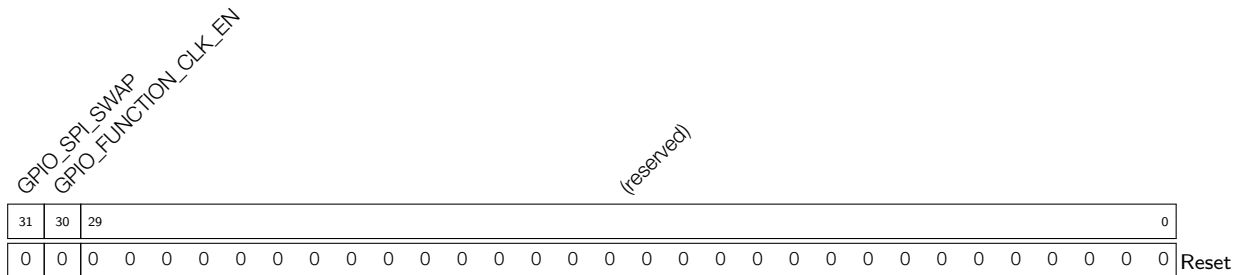
Register 6.39. GPIO_SIGMADELTA_MISC_REG (0x0024)

GPIO_FUNCTION_CLK_EN Clock enable bit of sigma delta modulation. (R/W)

GPIO_SPL_SWAP Reserved. (R/W)

Register 6.40. GPIO_SD_SIGMADELTA_VERSION_REG (0x0028)

(reserved)				GPIO_SD_DATE																0
31	28	27																	0	
0	0	0	0	0x1802260																0

GPIO_SD_DATE Version control register. (R/W)

6.15.4 RTC IO MUX Registers

The addresses in this section are relative to (Low-Power Management base address provided in Table 4-3 in Chapter 4 *System and Memory* + 0x0400).

Register 6.41. RTC_GPIO_OUT_REG (0x0000)

RTC_GPIO_OUT_DATA										(reserved)										0		
31										10	9											0
0										0 0 0 0 0 0 0 0 0 0 0 0 0 0 0 0										0		

RTC_GPIO_OUT_DATA GPIO0 ~ 21 output register. Bit10 corresponds to GPIO0, bit11 corresponds to GPIO1, etc. (R/W)

Register 6.42. RTC_GPIO_OUT_W1TS_REG (0x0004)

RTC_GPIO_OUT_DATA_W1TS										(reserved)										0		
31										10	9											0
0										0 0 0 0 0 0 0 0 0 0 0 0 0 0 0 0										0		

RTC_GPIO_OUT_DATA_W1TS GPIO0 ~ 21 output set register. If the value 1 is written to a bit here, the corresponding bit in RTC_GPIO_OUT_REG will be set to 1. Recommended operation: use this register to set RTC_GPIO_OUT_REG. (WO)

Register 6.43. RTC_GPIO_OUT_W1TC_REG (0x0008)

<i>RTC_GPIO_OUT_DATA_W1TC</i>										<i>(reserved)</i>													
31											10	9											0
0										0 0 0 0 0 0 0 0 0 0										Reset			

RTC_GPIO_OUT_DATA_W1TC GPIO0 ~ 21 output clear register. If the value 1 is written to a bit here, the corresponding bit in RTC_GPIO_OUT_REG will be cleared. Recommended operation: use this register to clear RTC_GPIO_OUT_REG. (WO)

Register 6.44. RTC_GPIO_ENABLE_REG (0x000C)

<i>RTC_GPIO_ENABLE</i>										<i>(reserved)</i>													
31											10	9											0
0										0 0 0 0 0 0 0 0 0 0										Reset			

RTC_GPIO_ENABLE GPIO0 ~ 21 output enable. Bit10 corresponds to GPIO0, bit11 corresponds to GPIO1, etc. If the bit is set to 1, it means this GPIO pin is output. (R/W)

Register 6.45. RTC_GPIO_ENABLE_W1TS_REG (0x0010)

<i>RTC_GPIO_ENABLE_W1TS</i>										<i>(reserved)</i>													
31											10	9											0
0										0 0 0 0 0 0 0 0 0 0										Reset			

RTC_GPIO_ENABLE_W1TS GPIO0 ~ 21 output enable set register. If the value 1 is written to a bit here, the corresponding bit in RTC_GPIO_ENABLE_REG will be set to 1. Recommended operation: use this register to set RTC_GPIO_ENABLE_REG. (WO)

Register 6.46. RTC_GPIO_ENABLE_W1TC_REG (0x0014)

<i>RTC_GPIO_ENABLE_W1TC</i>										<i>(reserved)</i>													
31											10	9											0
0										0 0 0 0 0 0 0 0 0 0										Reset			

RTC_GPIO_ENABLE_W1TC GPIO0 ~ 21 output enable clear register. If the value 1 is written to a bit here, the corresponding bit in RTC_GPIO_ENABLE_REG will be cleared. Recommended operation: use this register to clear RTC_GPIO_ENABLE_REG. (WO)

Register 6.47. RTC_GPIO_STATUS_REG (0x0018)

<i>RTC_GPIO_STATUS_INT</i>										<i>(reserved)</i>													
31											10	9											0
0										0 0 0 0 0 0 0 0 0 0										Reset			

RTC_GPIO_STATUS_INT GPIO0 ~ 21 interrupt status register. Bit10 corresponds to GPIO0, bit11 corresponds to GPIO1, etc. This register should be used together with RTC_GPIO_PIN n _INT_TYPE in RTC_GPIO_PIN n _REG. 0: no interrupt; 1: corresponding interrupt. (R/W)

Register 6.48. RTC_GPIO_STATUS_W1TS_REG (0x001C)

<i>RTC_GPIO_STATUS_INT_W1TS</i>										<i>(reserved)</i>													
31											10	9											0
0										0 0 0 0 0 0 0 0 0 0										Reset			

RTC_GPIO_STATUS_INT_W1TS GPIO0 ~ 21 interrupt set register. If the value 1 is written to a bit here, the corresponding bit in RTC_GPIO_STATUS_INT will be set to 1. Recommended operation: use this register to set RTC_GPIO_STATUS_INT. (WO)

Register 6.49. RTC_GPIO_STATUS_W1TC_REG (0x0020)

<i>RTC_GPIO_STATUS_INT_W1TC</i>										<i>(reserved)</i>													
31											10	9											0
0										0 0 0 0 0 0 0 0 0 0										Reset			

RTC_GPIO_STATUS_INT_W1TC GPIO0 ~ 21 interrupt clear register. If the value 1 is written to a bit here, the corresponding bit in RTC_GPIO_STATUS_INT will be cleared. Recommended operation: use this register to clear RTC_GPIO_STATUS_INT. (WO)

Register 6.50. RTC_GPIO_IN_REG (0x0024)

<i>RTC_GPIO_IN_NEXT</i>										<i>(reserved)</i>													
31											10	9											0
0										0 0 0 0 0 0 0 0 0 0										Reset			

RTC_GPIO_IN_NEXT GPIO0 ~ 21 input value. Bit10 corresponds to GPIO0, bit11 corresponds to GPIO1, etc. Each bit represents a pin input value, 1 for high level, and 0 for low level. (RO)

Register 6.51. RTC_GPIO_PIN n _REG (n : 0-21) (0x0028+0x4* n)

<i>(reserved)</i>										<i>RTC_GPIO_PINn_WAKEUP_ENABLE</i>										<i>RTC_GPIO_PINn_INT_TYPE</i>										<i>(reserved)</i>										<i>RTC_GPIO_PINn_PAD_DRIVER</i>										
31											11	10	9											7	6											3	2	1	0											
0 0 0 0 0 0 0 0 0 0										0 0 0 0 0 0 0 0 0 0										0 0 0 0 0 0 0 0 0 0										0 0 0 0 0 0 0 0 0 0										0 0 0 0 0 0 0 0 0 0										Reset

RTC_GPIO_PIN n _PAD_DRIVER Pin driver selection. 0: normal output; 1: open drain. (R/W)

RTC_GPIO_PIN n _INT_TYPE GPIO interrupt type selection. 0: GPIO interrupt disabled; 1: rising edge trigger; 2: falling edge trigger; 3: any edge trigger; 4: low level trigger; 5: high level trigger. (R/W)

RTC_GPIO_PIN n _WAKEUP_ENABLE GPIO wake-up enable. This will only wake up the chip from Light-sleep. (R/W)

Register 6.52. RTC_IO_TOUCH_PAD n _REG (n : 0-14) (0x0084+0x4* n)

	31	30	29	28	27	26	23	22	21	20	19	18	17	16	15	14	13	12	0		
(reserved)	0	2	1	0	0	0	0	0	0	0	0	0	0	0	0	0	0	0	0	0	Reset

RTC_IO_TOUCH_PAD n _FUN_IE Input enable in normal execution. (R/W)

RTC_IO_TOUCH_PAD n _SLP_OE Output enable in sleep mode. (R/W)

RTC_IO_TOUCH_PAD n _SLP_IE Input enable in sleep mode. (R/W)

RTC_IO_TOUCH_PAD n _SLP_SEL 0: no sleep mode; 1: enable sleep mode. (R/W)

RTC_IO_TOUCH_PAD n _FUN_SEL Function selection. (R/W)

RTC_IO_TOUCH_PAD n _MUX_SEL Connect the RTC pin input or digital pin input. 0 is available, i.e. select digital pin input. (R/W)

RTC_IO_TOUCH_PAD n _XPD Touch sensor power on. (R/W)

RTC_IO_TOUCH_PAD n _TIE_OPT The tie option of touch sensor. 0: tie low; 1: tie high. (R/W)

RTC_IO_TOUCH_PAD n _START Start touch sensor. (R/W)

RTC_IO_TOUCH_PAD n _RUE Pull-up enable of the pin. 1: internal pull-up enabled; 0: internal pull-up disabled. (R/W)

RTC_IO_TOUCH_PAD n _RDE Pull-down enable of the pin. 1: internal pull-down enabled, 0: internal pull-down disabled. (R/W)

RTC_IO_TOUCH_PAD n _DRV Select the drive strength of the pin. 0: ~5 mA; 1: ~10 mA; 2: ~20 mA; 3: ~40 mA. (R/W)

Register 6.53. RTC_IO_XTAL_32P_PAD_REG (0x00C0)

(reserved)				RTC_IO_X32P_DRV				RTC_IO_X32P_RDE				RTC_IO_X32P_RUE				(reserved)				RTC_IO_X32P_MUX_SEL				RTC_IO_X32P_FUN_SEL				RTC_IO_X32P_SLP_SEL				RTC_IO_X32P_SLP_IE				RTC_IO_X32P_SLP_OE				(reserved)			
31	30	29	28	27	26	25	24	23	22	21	20	19	18	17	16	15	14	13	12	11	10	9	8	7	6	5	4	3	2	1	0												
0	2	0	0	0	0	0	0	0	0	0	0	0	0	0	0	0	0	0	0	0	0	0	0	0	0	0	0	0	0	0	0												

Reset

RTC_IO_X32P_FUN_IE Input enable in normal execution. (R/W)

RTC_IO_X32P_SLP_OE Output enable in sleep mode. (R/W)

RTC_IO_X32P_SLP_IE Input enable in sleep mode. (R/W)

RTC_IO_X32P_SLP_SEL 1: enable sleep mode; 0: no sleep mode. (R/W)

RTC_IO_X32P_FUN_SEL Function selection. (R/W)

RTC_IO_X32P_MUX_SEL 1: use RTC GPIO; 0: use digital GPIO. (R/W)

RTC_IO_X32P_RUE Pull-up enable of the pin. 1: internal pull-up enabled; 0: internal pull-up disabled. (R/W)

RTC_IO_X32P_RDE Pull-down enable of the pin. 1: internal pull-down enabled, 0: internal pull-down disabled. (R/W)

RTC_IO_X32P_DRV Select the drive strength of the pin. 0: ~5 mA; 1: ~10 mA; 2: ~20 mA; 3: ~40 mA. (R/W)

Register 6.54. RTC_IO_XTAL_32N_PAD_REG (0x00C4)

(reserved)				RTC_IO_X32N_DRV				RTC_IO_X32N_RDE				RTC_IO_X32N_RUE				(reserved)				RTC_IO_X32N_MUX_SEL				RTC_IO_X32N_FUN_SEL				RTC_IO_X32N_SLP_SEL				RTC_IO_X32N_SLP_IE				RTC_IO_X32N_SLP_OE				(reserved)			
31	30	29	28	27	26	25	24	23	22	21	20	19	18	17	16	15	14	13	12	11	10	9	8	7	6	5	4	3	2	1	0												
0	2	0	0	0	0	0	0	0	0	0	0	0	0	0	0	0	0	0	0	0	0	0	0	0	0	0	0	0	0	0	0												

Reset

RTC_IO_X32N_FUN_IE Input enable in normal execution. (R/W)

RTC_IO_X32N_SLP_OE Output enable in sleep mode. (R/W)

RTC_IO_X32N_SLP_IE Input enable in sleep mode. (R/W)

RTC_IO_X32N_SLP_SEL 1: enable sleep mode; 0: no sleep mode. (R/W)

RTC_IO_X32N_FUN_SEL Function selection. (R/W)

RTC_IO_X32N_MUX_SEL 1: use RTC GPIO; 0: use digital GPIO. (R/W)

RTC_IO_X32N_RUE Pull-up enable of the pin. 1: internal pull-up enabled; 0: internal pull-up disabled. (R/W)

RTC_IO_X32N_RDE Pull-down enable of the pin. 1: internal pull-down enabled, 0: internal pull-down disabled. (R/W)

RTC_IO_X32N_DRV Select the drive strength of the pin. 0: ~5 mA; 1: ~10 mA; 2: ~20 mA; 3: ~40 mA. (R/W)

Register 6.57. RTC_IO_SAR_I2C_IO_REG (0x00E4)

RTC_IO_SAR_I2C_SDA_SEL		RTC_IO_SAR_I2C_SCL_SEL		(reserved)																											0	
31	30	29	28	27																												0
0	0	0	0	0	0																											0

Reset

RTC_IO_SAR_I2C_SCL_SEL Selects a pin the RTC I2C SCL signal connects to. 0: use RTC GPIO0; 1: use RTC GPIO2. (R/W)

RTC_IO_SAR_I2C_SDA_SEL Selects a pin the RTC I2C SDA signal connects to. 0: use RTC GPIO1; 1: use RTC GPIO3. (R/W)

Register 6.58. RTC_IO_DATE_REG (0x01FC)

(reserved)				RTC_IO_DATE																											0		
31				28	27																												0
0	0	0	0	0x1903170																											0		

Reset

RTC_IO_DATE Version control register (R/W)

7 Reset and Clock

7.1 Reset

7.1.1 Overview

ESP32-S3 provides four reset levels, namely CPU Reset, Core Reset, System Reset, and Chip Reset.

All reset levels mentioned above (except Chip Reset) maintain the data stored in internal memory. Figure 7-1 shows the affected subsystems of the four reset levels.

7.1.2 Architectural Overview

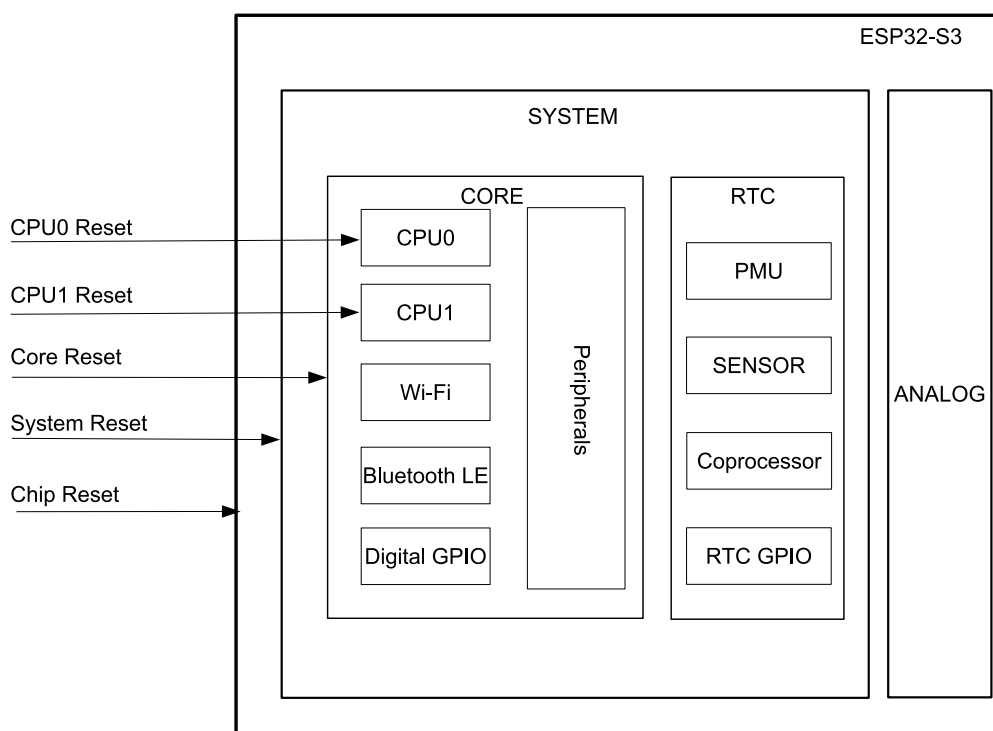

Figure 7-1. Reset Levels

7.1.3 Features

- Support four reset levels:
 - CPU Reset: only resets CPU x core. CPU x can be CPU0 or CPU1 here. Once such reset is released, programs will be executed from CPU x reset vector. Each CPU core has its own reset logic.
 - Core Reset: resets the whole digital system except RTC, including CPU0, CPU1, peripherals, Wi-Fi, Bluetooth[®] LE (BLE), and digital GPIOs.
 - System Reset: resets the whole digital system, including RTC.
 - Chip Reset: resets the whole chip.
- Support software reset and hardware reset:
 - Software reset is triggered by CPU x configuring its corresponding registers.

- Hardware reset is directly triggered by the circuit.

Note:

If CPU Reset is from CPU0, the [sensitive registers](#) will be reset, too.

7.1.4 Functional Description

CPU0 and CPU1 will be reset immediately when any of the reset above occurs. After the reset is released, CPU0 and CPU1 can read from the registers RTC_CNTL_RESET_CAUSE_PROCPU and RTC_CNTL_RESET_CAUSE_APPCPU to get the reset source, respectively. The reset sources recorded in the two registers are shared by the two CPUs, except the CPU reset sources, i.e. each CPU has its own CPU reset sources.

Table 7-1 lists the reset sources and the types of reset they trigger.

Table 7-1. Reset Sources

Code	Source	Reset Type	Comments
0x01	Chip reset ¹	Chip Reset	-
0x0F	Brown-out system reset	Chip Reset or System Reset	Triggered by brown-out detector ²
0x10	RWDT system reset	System Reset	See Chapter 13 <i>Watchdog Timers (WDT)</i>
0x12	Super Watchdog reset	System Reset	See Chapter 13 <i>Watchdog Timers (WDT)</i>
0x13	GLITCH reset	System Reset	See Chapter 24 <i>Clock Glitch Detection</i>
0x03	Software system reset	Core Reset	Triggered by configuring RTC_CNTL_SW_SYS_RST
0x05	Deep-sleep reset	Core Reset	See Chapter 10 <i>Low-power Management (RTC_CNTL)</i>
0x07	MWDT0 core reset	Core Reset	See Chapter 13 <i>Watchdog Timers (WDT)</i>
0x08	MWDT1 core reset	Core Reset	See Chapter 13 <i>Watchdog Timers (WDT)</i>
0x09	RWDT core reset	Core Reset	See Chapter 13 <i>Watchdog Timers (WDT)</i>
0x14	eFuse reset	Core Reset	Triggered by eFuse CRC error
0x15	USB (UART) reset	Core Reset	Triggered when external USB host sends a specific command to the Serial interface of USB-Serial-JTAG. See 33 <i>USB Serial/JTAG Controller (USB_SERIAL_JTAG)</i>
0x16	USB (JTAG) reset	Core Reset	Triggered when external USB host sends a specific command to the JTAG interface of USB-Serial-JTAG. See 33 <i>USB Serial/JTAG Controller (USB_SERIAL_JTAG)</i>
0x0B	MWDT0 CPU _x reset	CPU Reset	See Chapter 13 <i>Watchdog Timers (WDT)</i>
0x0C	Software CPU _x reset	CPU Reset	Triggered by configuring RTC_CNTL_SW_PRO(APP)CPU_RST
0x0D	RWDT CPU _x reset	CPU Reset	See Chapter 13 <i>Watchdog Timers (WDT)</i>
0x11	MWDT1 CPU _x reset	CPU Reset	See Chapter 13 <i>Watchdog Timers (WDT)</i>

¹ Chip Reset can be triggered by the following three sources:

- Triggered by chip power-on;
- Triggered by brown-out detector;
- Triggered by Super Watchdog (SWD).

² Once brown-out status is detected, the detector will trigger System Reset or Chip Reset, depending on register configuration. For more information, please see Chapter 10 *Low-power Management (RTC_CNTL)*.

7.2 Clock

7.2.1 Overview

ESP32-S3 clocks are mainly sourced from oscillator (OSC), RC, and PLL circuit, and then processed by the dividers/selectors, which allows most functional modules to select their working clock according to their power consumption and performance requirements. Figure 7-2 shows the system clock structure.

7.2.2 Architectural Overview

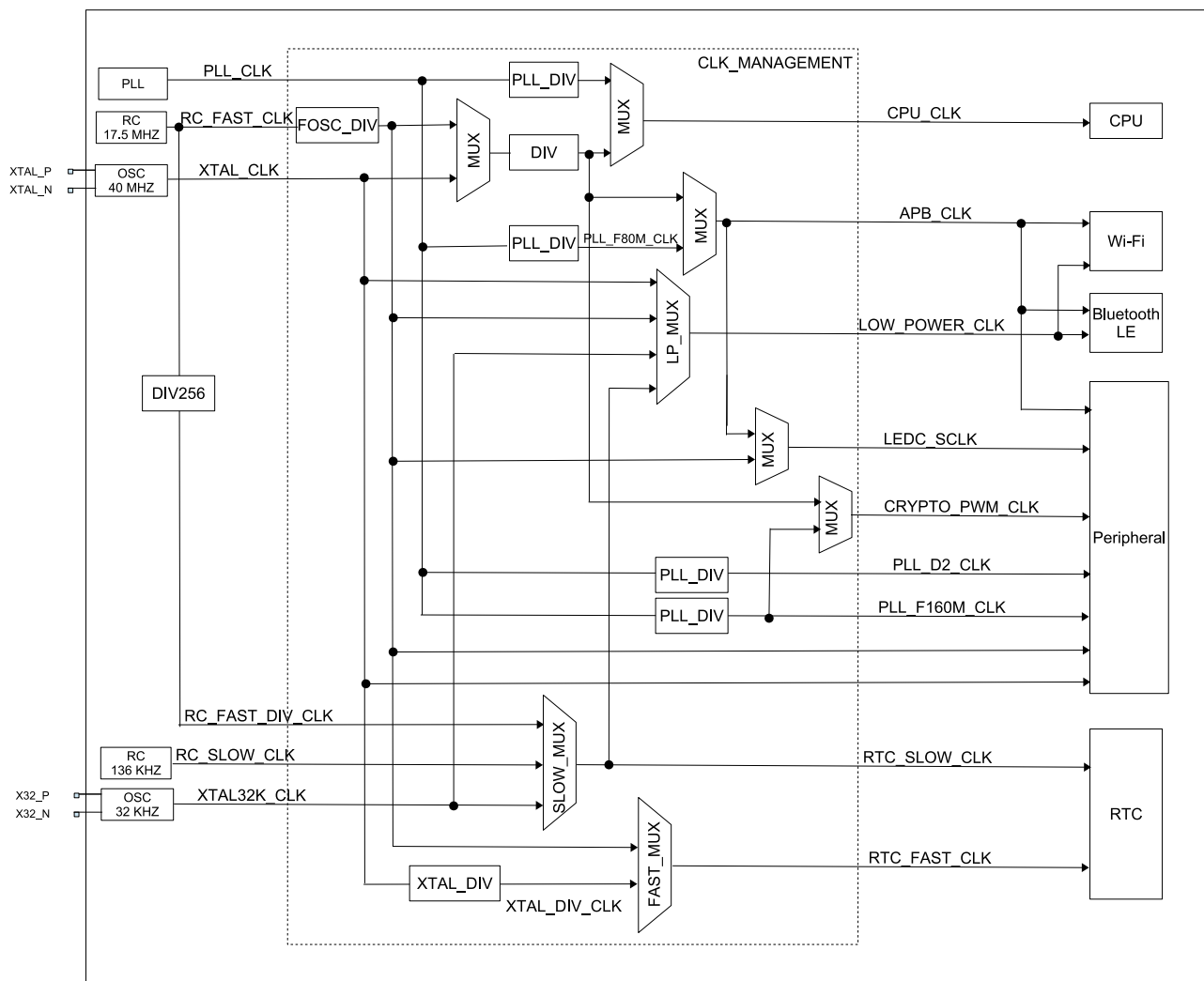

Figure 7-2. Clock Structure

7.2.3 Features

ESP32-S3 clocks can be classified in two types depending on their frequencies:

- High speed clocks for devices working at a higher frequency, such as CPU and digital peripherals
 - PLL_CLK (320 MHz or 480 MHz): internal PLL clock
 - XTAL_CLK (40 MHz): external crystal clock
- Slow speed clocks for low-power devices, such as RTC module and low-power peripherals
 - XTAL32K_CLK (32 kHz): external crystal clock

- RC_FAST_CLK (17.5 MHz by default): internal fast RC oscillator clock with adjustable frequency
- RC_FAST_DIV_CLK: internal fast RC oscillator clock derived from RC_FAST_CLK divided by 256
- RC_SLOW_CLK (136 kHz by default): internal low RC oscillator clock with adjustable frequency

7.2.4 Functional Description

7.2.4.1 CPU Clock

As Figure 7-2 shows, CPU_CLK is the master clock for CPU_x and it can be as high as 240 MHz when CPU_x works in high performance mode. Alternatively, CPU_x can run at lower frequencies, such as at 2 MHz, to lower power consumption.

Users can set PLL_CLK, RC_FAST_CLK or XTAL_CLK as CPU_CLK clock source by configuring register SYSTEM_SOC_CLK_SEL, see Table 7-2 and Table 7-3. By default, the CPU clock is sourced from XTAL_CLK with a divider of 2, i.e. the CPU clock is 20 MHz.

Table 7-2. CPU Clock Source

SYSTEM_SOC_CLK_SEL Value	CPU Clock Source
0	XTAL_CLK
1	PLL_CLK
2	RC_FAST_CLK

Table 7-3. CPU Clock Frequency

CPU Clock Source	SEL_0*	SEL_1*	SEL_2*	CPU Clock Frequency
XTAL_CLK	0	-	-	CPU_CLK = XTAL_CLK/(SYSTEM_PRE_DIV_CNT + 1) SYSTEM_PRE_DIV_CNT ranges from 0 ~ 1023. Default is 1
PLL_CLK (480 MHz)	1	1	0	CPU_CLK = PLL_CLK/6 CPU_CLK frequency is 80 MHz
PLL_CLK (480 MHz)	1	1	1	CPU_CLK = PLL_CLK/3 CPU_CLK frequency is 160 MHz
PLL_CLK (480 MHz)	1	1	2	CPU_CLK = PLL_CLK/2 CPU_CLK frequency is 240 MHz
PLL_CLK (320 MHz)	1	0	0	CPU_CLK = PLL_CLK/4 CPU_CLK frequency is 80 MHz
PLL_CLK (320 MHz)	1	0	1	CPU_CLK = PLL_CLK/2 CPU_CLK frequency is 160 MHz
RC_FAST_CLK	2	-	-	CPU_CLK = RC_FAST_CLK/(SYSTEM_PRE_DIV_CNT + 1) SYSTEM_PRE_DIV_CNT ranges from 0 ~ 1023. Default is 1

* The value of register SYSTEM_SOC_CLK_SEL.

* The value of register SYSTEM_PLL_FREQ_SEL.

* The value of register SYSTEM_CPUPERIOD_SEL.

7.2.4.2 Peripheral Clocks

Peripheral clocks include APB_CLK, CRYPTO_PWM_CLK, PLL_F160M_CLK, PLL_D2_CLK, LEDC_CLK, XTAL_CLK, and RC_FAST_CLK. Table 7-4 shows which clock can be used by each peripheral.

Table 7-4. Peripheral Clocks

Peripheral	XTAL_CLK	APB_CLK	PLL_F160M_CLK	PLL_D2_CLK	RC_FAST_CLK	CRYPTO_PWM_CLK	LEDC_CLK
TIMG	Y	Y					
I2S	Y		Y	Y			
UHCI		Y					
UART	Y	Y			Y		
RMT	Y	Y			Y		
PWM						Y	
I2C	Y				Y		
SPI	Y	Y					
PCNT		Y					
eFuse Controller	Y	Y					
SARADC		Y		Y			
USB		Y					
CRYPTO						Y	
TWAI Controller		Y					
SDIO HOST	Y		Y				
LEDC	Y	Y			Y		Y
LCD_CAM	Y		Y	Y			
SYS_TIMER	Y	Y					

APB_CLK

APB_CLK frequency is determined by the clock source of CPU_CLK as shown in Table 7-5.

Table 7-5. APB_CLK Frequency

CPU_CLK Source	APB_CLK Frequency
PLL_CLK	80 MHz
XTAL_CLK	CPU_CLK
RC_FAST_CLK	CPU_CLK

CRYPTO_PWM_CLK

The frequency of CRYPTO_PWM_CLK is determined by the CPU_CLK source, as shown in Table 7-6.

Table 7-6. CRYPTO_PWM_CLK Frequency

CPU_CLK Source	CRYPTO_PWM_CLK Frequency
PLL_CLK	160 MHz
XTAL_CLK	CPU_CLK
RC_FAST_CLK	CPU_CLK

PLL_F160M_CLK

PLL_F160M_CLK is divided from PLL_CLK according to current PLL frequency, so the frequency of PLL_F160M_CLK is always 160 Mhz.

PLL_D2_CLK

PLL_D2_CLK is divided from PLL_CLK according to current PLL frequency.

LEDC_CLK

LEDC module uses RC_FAST_CLK as clock source when APB_CLK is disabled. In other words, when the system is in low-power mode, most peripherals will be halted (APB_CLK is turned off), but LEDC can work normally via RC_FAST_CLK.

7.2.4.3 Wi-Fi and Bluetooth LE Clock

Wi-Fi and Bluetooth LE can work only when CPU_CLK uses PLL_CLK as its clock source. Suspending PLL_CLK requires that Wi-Fi and Bluetooth LE has entered low-power mode first.

LOW_POWER_CLK uses XTAL32K_CLK, XTAL_CLK, RC_FAST_CLK or RTC_SLOW_CLK (the low clock selected by RTC) as its clock source for Wi-Fi and Bluetooth LE in low-power mode.

7.2.4.4 RTC Clock

The clock sources for RTC_SLOW_CLK and RTC_FAST_CLK are low-frequency clocks. RTC module can operate when most other clocks are stopped.

RTC_SLOW_CLK is derived from RC_SLOW_CLK, XTAL32K_CLK or RC_FAST_DIV_CLK and used to clock Power Management module. RTC_FAST_CLK is used to clock On-chip Sensor module. It can be sourced from a divided XTAL_CLK or from RC_FAST_CLK.

8 Chip Boot Control

8.1 Overview

ESP32-S3 has four strapping pins:

- GPIO0
- GPIO3
- GPIO45
- GPIO46

These strapping pins are used to control the following functions during chip power-on or hardware reset:

- control chip boot mode
- enable or disable ROM messages printing
- control the voltage of VDD_SPI
- control the source of JTAG signals

During power-on-reset, RTC watchdog reset, brownout reset, analog super watchdog reset, and crystal clock glitch detection reset (see Chapter 7 *Reset and Clock*), hardware captures samples and stores the voltage level of strapping pins as strapping bit of “0” or “1” in latches, and holds these bits until the chip is powered down or shut down. Software can read the latch status (strapping value) from the register [GPIO_STRAPPING](#).

By default, GPIO0, GPIO45, and GPIO46 are connected to the chip’s internal pull-up/pull-down resistors. If these pins are not connected or connected to an external high-impedance circuit, the internal weak pull-up/pull-down determines the default input level of these strapping pins (see Table 8-1).

Table 8-1. Default Configuration of Strapping Pins

Strapping Pin	Default Configuration
GPIO0	Pull-up
GPIO3	N/A
GPIO45	Pull-down
GPIO46	Pull-down

To change the strapping bit values, users can apply external pull-down/pull-up resistors, or use host MCU GPIOs to control the voltage level of these pins when powering on ESP32-S3. After the reset is released, the strapping pins work as normal-function pins.

Note:

The following section provides description of the chip functions and the pattern of the strapping pins values to invoke each function. Only documented patterns should be used. If some pattern is not documented, it may trigger unexpected behavior.

8.2 Boot Mode Control

GPIO0 and GPIO46 control the boot mode after the reset is released.

Table 8-2. Boot Mode Control

Boot Mode	GPIO0	GPIO46
SPI Boot	1	x
Download Boot	0	0

Table 8-2 shows the strapping pin values of GPIO0 and GPIO46, and the associated boot modes. “x” means that this value is ignored. The ESP32-S3 chip only supports the two boot modes listed above. The strapping combination of GPIO0 = 0 and GPIO46 = 1 is not supported and will trigger unexpected behavior.

In SPI Boot mode, the CPU boots the system by reading the program stored in SPI flash. SPI Boot mode can be further classified as follows:

- Normal Flash Boot: supports Security Boot and programs run in RAM.
- Direct Boot: does not support Security Boot and programs run directly in flash. To enable this mode, make sure that the first two words of the bin file downloading to flash (address: 0x42000000) are 0xaedb041d.

In Download Boot mode, users can download code to flash using UART0 or USB interface. It is also possible to load a program into SRAM and execute it in this mode.

The following eFuses control boot mode behaviors:

- [EFUSE_DIS_FORCE_DOWNLOAD](#)

If this eFuse is 0 (default), software can force switch the chip from SPI Boot mode to Download Boot mode by setting register `RTC_CNTL_FORCE_DOWNLOAD_BOOT` and triggering a CPU reset. If this eFuse is 1, `RTC_CNTL_FORCE_DOWNLOAD_BOOT` is disabled.

- [EFUSE_DIS_DOWNLOAD_MODE](#)

If this eFuse is 1, Download Boot mode is disabled.

- [EFUSE_ENABLE_SECURITY_DOWNLOAD](#)

If this eFuse is 1, Download Boot mode only allows reading, writing, and erasing plaintext flash and does not support any SRAM or register operations. Ignore this eFuse if Download Boot mode is disabled.

USB Serial/JTAG Controller can also force the chip into Download Boot mode from SPI Boot mode, as well as force the chip into SPI Boot mode from Download Boot mode. For detailed information, please refer to Chapter [33 USB Serial/JTAG Controller \(USB_SERIAL_JTAG\)](#).

8.3 ROM Messages Printing Control

During the boot process, ROM messages are printed to both UART0 and USB Serial/JTAG controller by default. The printing to UART0 or USB Serial/JTAG controller can be disabled in various boot modes or configuration.

Printing to UART0 is controlled as described in the table below.

Table 8-3. Control of ROM Messages Printing to UART0

Boot Mode	Register ¹	eFuse ²	GPIO46	ROM Messages Printing to UART0
Download Boot Mode	x ³	x	x	Enabled
SPI Boot Mode	0	0	x	Enabled
		1	0	Enabled
			1	Disabled
		2	0	Disabled
			1	Enabled
	3	x	Disabled	
1	x	x	Disabled	

¹ Register: [RTC_CNTL_RTC_STORE4_REG\[0\]](#).

² eFuse: [EFUSE_UART_PRINT_CONTROL](#).

³ x: the value is ignored.

Printing to USB Serail/JTAG controller is controlled as described in the table below.

Table 8-4. Control of ROM Messages Printing to USB Serail/JTAG controller

Boot Mode	Register ¹	eFuse_1 ²	eFuse_2 ³	eFuse_3 ⁴	ROM Messages Printing to USB Serial/JTAG controller
Download Boot Mode	x ⁵	0	0	0	Enabled
		Others			Disabled
SPI Boot Mode	0	1	1	x	Enabled
		00/10/01		0	Enabled
		00/10/01		1	Disabled
	1	x	x	x	Disabled

¹ Register: [RTC_CNTL_RTC_STORE4_REG\[0\]](#).

² eFuse_1: [EFUSE_DIS_USB_SERIAL_JTAG](#).

³ eFuse_2: In Download Boot mode, eFuse_2 is [EFUSE_DIS_USB_SERIAL_JTAG_DOWNLOAD_MODE](#); In SPI Boot mode, eFuse_2 is [EFUSE_DIS_USB_OTG](#).

⁴ eFuse_3: In Download Boot mode, eFuse_3 is [EFUSE_DIS_DOWNLOAD_MODE](#); In SPI Boot mode, eFuse_3 is [EFUSE_DIS_USB_PRINT](#).

⁵ x: the value is ignored.

Note:

The value of [RTC_CNTL_RTC_STORE4_REG\[0\]](#) can be read and written any number of times, whereas eFuse can only be burned once. Therefore, [RTC_CNTL_RTC_STORE4_REG\[0\]](#) can be used to temporarily disable ROM messages printing, while eFuse can be used to permanently disable ROM messages printing.

8.4 VDD_SPI Voltage Control

GPIO45 is used to select the VDD_SPI power supply voltage at reset:

- GPIO45 = 0, VDD_SPI pin is powered directly from VDD3P3_RTC via resistor R_{SPI}. Typically this voltage is

3.3 V. For more information, see Figure: ESP32-S3 Power Scheme in [ESP32-S3 Datasheet](#).

- GPIO45 = 1, VDD_SPI pin is powered from internal 1.8 V LDO.

This functionality can be overridden by setting eFuse bit [EFUSE_VDD_SPI_FORCE](#) to 1, in which case the [EFUSE_](#)

[VDD_SPI_TIEH](#) determines the VDD_SPI voltage:

- [EFUSE_VDD_SPI_TIEH](#) = 0, VDD_SPI connects to 1.8 V LDO.
- [EFUSE_VDD_SPI_TIEH](#) = 1, VDD_SPI connects to VDD3P3_RTC.

8.5 JTAG Signal Source Control

GPIO3 controls the source of JTAG signals during the early boot process. This GPIO is used together with [EFUSE_DIS_PAD_JTAG](#), [EFUSE_DIS_USB_JTAG](#), and [EFUSE_STRAP_JTAG_SEL](#), see Table 8-5.

Table 8-5. JTAG Signal Source Control

eFuse 1 ^a	eFuse 2 ^b	eFuse 3 ^c	GPIO3	Signal Source
0	0	0	x	JTAG signals come from USB Serial/JTAG Controller.
		1	0	JTAG signals come from corresponding pins ^d
				1
0	1	x	x	JTAG signals come from corresponding pins ^d
1	0	x	x	JTAG signals come from USB Serial/JTAG Controller.
1	1	x	x	JTAG is disabled.

^a eFuse 1: [EFUSE_DIS_PAD_JTAG](#)

^b eFuse 2: [EFUSE_DIS_USB_JTAG](#)

^c eFuse 3: [EFUSE_STRAP_JTAG_SEL](#)

^d JTAG pins: MTDI, MTCK, MTMS, and MTDO.

9 Interrupt Matrix (INTERRUPT)

9.1 Overview

The interrupt matrix embedded in ESP32-S3 independently allocates peripheral interrupt sources to the two CPUs' peripheral interrupts, to timely inform CPU0 or CPU1 to process the interrupts once the interrupt signals are generated.

Peripheral interrupt sources must be routed to CPU0/CPU1 peripheral interrupts via this interrupt matrix due to the following considerations:

- ESP32-S3 has 99 peripheral interrupt sources. To map them to 32 CPU0 interrupts or 32 CPU1 interrupts, this matrix is needed.
- Through this matrix, one peripheral interrupt source can be mapped to multiple CPU0 interrupts or CPU1 interrupts according to application requirements.

9.2 Features

- Accept 99 peripheral interrupt sources as input
- Generate 26 peripheral interrupts to CPU0 and 26 peripheral interrupts to CPU1 as output. Note that the remaining six CPU0 interrupts and six CPU1 interrupts are internal interrupts.
- Support to disable CPU non-maskable interrupt (NMI) sources
- Support to query current interrupt status of peripheral interrupt sources

Figure 9-1 shows the structure of the interrupt matrix.

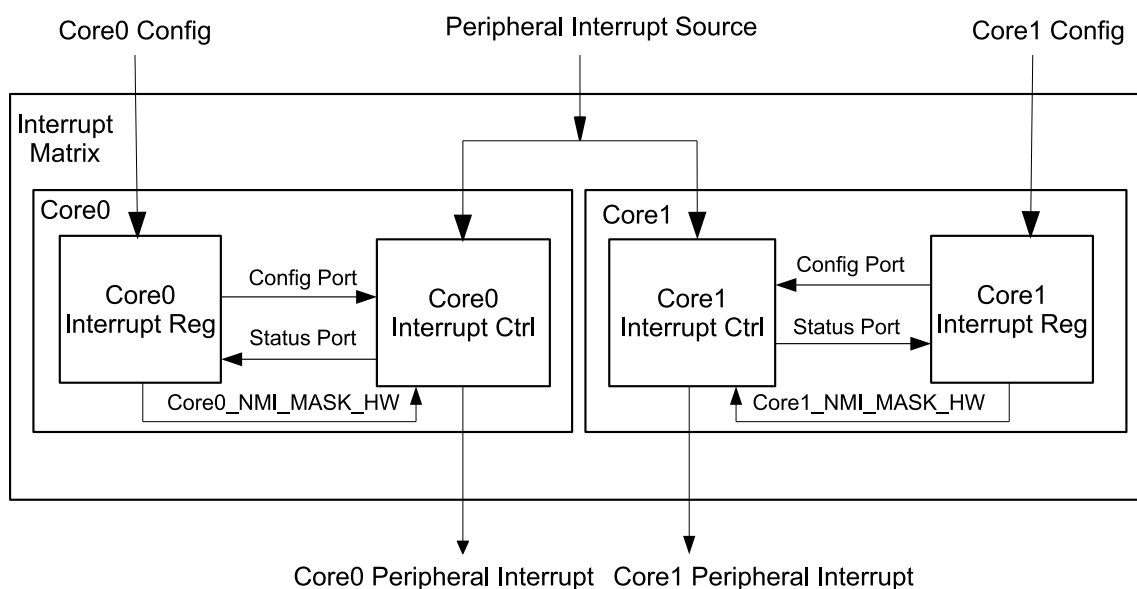

Figure 9-1. Interrupt Matrix Structure

All the interrupts generated by the peripheral interrupt sources can be handled by CPU0 or CPU1. Users can configure [CPU0 interrupt registers](#) (“Core0 Interrupt Reg” module in Figure 9-1) to allocate peripheral interrupt sources to CPU0, or configure [CPU1 interrupt registers](#) (“Core1 Interrupt Reg” module in Figure 9-1) to allocate

peripheral interrupt sources to CPU1. Peripheral interrupt sources can be allocated both to CPU0 and CPU1 simultaneously, if so, CPU0 and CPU1 will accept the interrupts.

9.3 Functional Description

9.3.1 Peripheral Interrupt Sources

ESP32-S3 has 99 peripheral interrupt sources in total. For the peripheral interrupt sources and their configuration/status registers, please refer to Table 9-1.

- Column “No.”: the peripheral interrupt source number, can be 0 ~ 98
- Column “Source”: all peripheral interrupt sources available
- Column “Configuration Register”: the registers used for routing the peripheral interrupt sources to CPU0/CPU1 peripheral interrupts
- Column “Status Register”: the registers used for indicating the interrupt status of peripheral interrupt sources
 - Column “Status Register - Bit”: the bit position in status registers
 - Column “Status Register - Name”: the name of status registers

The register in column “Configuration Register” and the bit in column “Bit” correspond to the peripheral interrupt source in column “Source”. For example, the configuration register for interrupt source MAC_INTR is [INTERRUPT_COREx_MAC_INTR_MAP_REG](#), and its status bit in [INTERRUPT_COREx_INTR_STATUS_0_REG](#) is bit0.

Note that CORE_x in the table can be CORE0 (CPU0) or CORE1 (CPU1).

Table 9-1. CPU Peripheral Interrupt Configuration/Status Registers and Peripheral Interrupt Sources

No.	Source	Configuration Register	Bit	Status Register Name
0	MAC_INTR	INTERRUPT_COREx_MAC_INTR_MAP_REG	0	INTERRUPT_COREx_INTR_STATUS_0_REG
1	MAC_NMI	INTERRUPT_COREx_MAC_NMI_MAP_REG	1	
2	PWR_INTR	INTERRUPT_COREx_PWR_INTR_MAP_REG	2	
3	BB_INT	INTERRUPT_COREx_BB_INT_MAP_REG	3	
4	BT_MAC_INT	INTERRUPT_COREx_BT_MAC_INT_MAP_REG	4	
5	BT_BB_INT	INTERRUPT_COREx_BT_BB_INT_MAP_REG	5	
6	BT_BB_NMI	INTERRUPT_COREx_BT_BB_NMI_MAP_REG	6	
7	RWBT_IRQ	INTERRUPT_COREx_RWBT_IRQ_MAP_REG	7	
8	RWBLE_IRQ	INTERRUPT_COREx_RWBLE_IRQ_MAP_REG	8	
9	RWBT_NMI	INTERRUPT_COREx_RWBT_NMI_MAP_REG	9	
10	RWBLE_NMI	INTERRUPT_COREx_RWBLE_NMI_MAP_REG	10	
11	I2C_MST_INT	INTERRUPT_COREx_I2C_MST_INT_MAP_REG	11	
12	reserved	reserved	12	
13	reserved	reserved	13	
14	UHCIO_INTR	INTERRUPT_COREx_UHCIO_INTR_MAP_REG	14	
15	reserved	reserved	15	
16	GPIO_INTERRUPT_CPU	INTERRUPT_COREx_GPIO_INTERRUPT_CPU_MAP_REG	16	
17	GPIO_INTERRUPT_CPU_NMI	INTERRUPT_COREx_GPIO_INTERRUPT_CPU_NMI_MAP_REG	17	
18	reserved	reserved	18	
19	reserved	reserved	19	
20	SPI_INTR_1	INTERRUPT_COREx_SPI_INTR_1_MAP_REG	20	
21	SPI_INTR_2	INTERRUPT_COREx_SPI_INTR_2_MAP_REG	21	
22	SPI_INTR_3	INTERRUPT_COREx_SPI_INTR_3_MAP_REG	22	
23	reserved	reserved	23	
24	LCD_CAM_INT	INTERRUPT_COREx_LCD_CAM_INT_MAP_REG	24	
25	I2S0_INT	INTERRUPT_COREx_I2S0_INT_MAP_REG	25	
26	I2S1_INT	INTERRUPT_COREx_I2S1_INT_MAP_REG	26	
27	UART_INTR	INTERRUPT_COREx_UART_INTR_MAP_REG	27	
28	UART1_INTR	INTERRUPT_COREx_UART1_INTR_MAP_REG	28	
29	UART2_INTR	INTERRUPT_COREx_UART2_INTR_MAP_REG	29	
30	SDIO_HOST_INTERRUPT	INTERRUPT_COREx_SDIO_HOST_INTERRUPT_MAP_REG	30	
31	PWM0_INTR	INTERRUPT_COREx_PWM0_INTR_MAP_REG	31	
32	PWM1_INTR	INTERRUPT_COREx_PWM1_INTR_MAP_REG	0	INTERRUPT_COREx_INTR_STATUS_1_REG
33	reserved	reserved	1	
34	reserved	reserved	2	

No.	Source	Configuration Register	Bit	Status Register Name	
35	LEDC_INT	INTERRUPT_COREx_LEDC_INT_MAP_REG	3	INTERRUPT_COREx_INTR_STATUS_1_REG	
36	EFUSE_INT	INTERRUPT_COREx_EFUSE_INT_MAP_REG	4		
37	TWAI_INT	INTERRUPT_COREx_TWAI_INT_MAP_REG	5		
38	USB_INTR	INTERRUPT_COREx_USB_INTR_MAP_REG	6		
39	RTC_CORE_INTR	INTERRUPT_COREx_RTC_CORE_INTR_MAP_REG	7		
40	RMT_INTR	INTERRUPT_COREx_RMT_INTR_MAP_REG	8		
41	PCNT_INTR	INTERRUPT_COREx_PCNT_INTR_MAP_REG	9		
42	I2C_EXT0_INTR	INTERRUPT_COREx_I2C_EXT0_INTR_MAP_REG	10		
43	I2C_EXT1_INTR	INTERRUPT_COREx_I2C_EXT1_INTR_MAP_REG	11		
44	reserved	reserved	12		
45	reserved	reserved	13		
46	reserved	reserved	14		
47	reserved	reserved	15		
48	reserved	reserved	16		
49	reserved	reserved	17		
50	TG_T0_INT	INTERRUPT_COREx_TG_T0_INT_MAP_REG	18		
51	TG_T1_INT	INTERRUPT_COREx_TG_T1_INT_MAP_REG	19		
52	TG_WDT_INT	INTERRUPT_COREx_TG_WDT_INT_MAP_REG	20		
53	TG1_T0_INT	INTERRUPT_COREx_TG1_T0_INT_MAP_REG	21		
54	TG1_T1_INT	INTERRUPT_COREx_TG1_T1_INT_MAP_REG	22		
55	TG1_WDT_INT	INTERRUPT_COREx_TG1_WDT_INT_MAP_REG	23		
56	CACHE_IA_INT	INTERRUPT_COREx_CACHE_IA_INT_MAP_REG	24		
57	SYSTIMER_TARGET0_INT	INTERRUPT_COREx_SYSTIMER_TARGET0_INT_MAP_REG	25		
58	SYSTIMER_TARGET1_INT	INTERRUPT_COREx_SYSTIMER_TARGET1_INT_MAP_REG	26		
59	SYSTIMER_TARGET2_INT	INTERRUPT_COREx_SYSTIMER_TARGET2_INT_MAP_REG	27		
60	SPI_MEM_REJECT_INTR	INTERRUPT_COREx_SPI_MEM_REJECT_INTR_MAP_REG	28		
61	DCACHE_PRELOAD_INT	INTERRUPT_COREx_DCACHE_PRELOAD_INT_MAP_REG	29		
62	ICACHE_PRELOAD_INT	INTERRUPT_COREx_ICACHE_PRELOAD_INT_MAP_REG	30		
63	DCACHE_SYNC_INT	INTERRUPT_COREx_DCACHE_SYNC_INT_MAP_REG	31		
64	ICACHE_SYNC_INT	INTERRUPT_COREx_ICACHE_SYNC_INT_MAP_REG	0		INTERRUPT_COREx_INTR_STATUS_2_REG
65	APB_ADC_INT	INTERRUPT_COREx_APB_ADC_INT_MAP_REG	1		
66	DMA_IN_CH0_INT	INTERRUPT_COREx_DMA_IN_CH0_INT_MAP_REG	2		
67	DMA_IN_CH1_INT	INTERRUPT_COREx_DMA_IN_CH1_INT_MAP_REG	3		
68	DMA_IN_CH2_INT	INTERRUPT_COREx_DMA_IN_CH2_INT_MAP_REG	4		
69	DMA_IN_CH3_INT	INTERRUPT_COREx_DMA_IN_CH3_INT_MAP_REG	5		
70	DMA_IN_CH4_INT	INTERRUPT_COREx_DMA_IN_CH4_INT_MAP_REG	6		
71	DMA_OUT_CH0_INT	INTERRUPT_COREx_DMA_OUT_CH0_INT_MAP_REG	7		

No.	Source	Configuration Register	Bit	Status Register Name	
72	DMA_OUT_CH1_INT	INTERRUPT_COREx_DMA_OUT_CH1_INT_MAP_REG	8	INTERRUPT_COREx_INTR_STATUS_2_REG	
73	DMA_OUT_CH2_INT	INTERRUPT_COREx_DMA_OUT_CH2_INT_MAP_REG	9		
74	DMA_OUT_CH3_INT	INTERRUPT_COREx_DMA_OUT_CH3_INT_MAP_REG	10		
75	DMA_OUT_CH4_INT	INTERRUPT_COREx_DMA_OUT_CH4_INT_MAP_REG	11		
76	RSA_INTR	INTERRUPT_COREx_RSA_INTR_MAP_REG	12		
77	AES_INTR	INTERRUPT_COREx_AES_INTR_MAP_REG	13		
78	SHA_INTR	INTERRUPT_COREx_SHA_INTR_MAP_REG	14		
79	CPU_INTR_FROM_CPU_0	INTERRUPT_COREx_CPU_INTR_FROM_CPU_0_MAP_REG	15		
80	CPU_INTR_FROM_CPU_1	INTERRUPT_COREx_CPU_INTR_FROM_CPU_1_MAP_REG	16		
81	CPU_INTR_FROM_CPU_2	INTERRUPT_COREx_CPU_INTR_FROM_CPU_2_MAP_REG	17		
82	CPU_INTR_FROM_CPU_3	INTERRUPT_COREx_CPU_INTR_FROM_CPU_3_MAP_REG	18		
83	ASSIST_DEBUG_INTR	INTERRUPT_COREx_ASSIST_DEBUG_INTR_MAP_REG	19		
84	DMA_APB_PMS_MONITOR_VIOLATE_INTR	INTERRUPT_COREx_DMA_APB_PMS_MONITOR_VIOLATE_INTR_MAP_REG	20		
85	CORE_0_IRAM0_PMS_MONITOR_VIOLATE_INTR	INTERRUPT_COREx_CORE_0_IRAM0_PMS_MONITOR_VIOLATE_INTR_MAP_REG	21		
86	CORE_0_DRAM0_PMS_MONITOR_VIOLATE_INTR	INTERRUPT_COREx_CORE_0_DRAM0_PMS_MONITOR_VIOLATE_INTR_MAP_REG	22		
87	CORE_0_PIF_PMS_MONITOR_VIOLATE_INTR	INTERRUPT_COREx_CORE_0_PIF_PMS_MONITOR_VIOLATE_INTR_MAP_REG	23		
88	CORE_0_PIF_PMS_MONITOR_VIOLATE_SIZE_INTR	INTERRUPT_COREx_CORE_0_PIF_PMS_MONITOR_VIOLATE_SIZE_INTR_MAP_REG	24		
89	CORE_1_IRAM0_PMS_MONITOR_VIOLATE_INTR	INTERRUPT_COREx_CORE_1_IRAM0_PMS_MONITOR_VIOLATE_INTR_MAP_REG	25		
90	CORE_1_DRAM0_PMS_MONITOR_VIOLATE_INTR	INTERRUPT_COREx_CORE_1_DRAM0_PMS_MONITOR_VIOLATE_INTR_MAP_REG	26		
91	CORE_1_PIF_PMS_MONITOR_VIOLATE_INTR	INTERRUPT_COREx_CORE_1_PIF_PMS_MONITOR_VIOLATE_INTR_MAP_REG	27		
92	CORE_1_PIF_PMS_MONITOR_VIOLATE_SIZE_INTR	INTERRUPT_COREx_CORE_1_PIF_PMS_MONITOR_VIOLATE_SIZE_INTR_MAP_REG	28		
93	BACKUP_PMS_VIOLATE_INT	INTERRUPT_COREx_BACKUP_PMS_VIOLATE_INTR_MAP_REG	29		
94	CACHE_CORE0_ACS_INT	INTERRUPT_COREx_CACHE_CORE0_ACS_INT_MAP_REG	30		
95	CACHE_CORE1_ACS_INT	INTERRUPT_COREx_CACHE_CORE1_ACS_INT_MAP_REG	31		
96	USB_DEVICE_INT	INTERRUPT_COREx_USB_DEVICE_INT_MAP_REG	0		INTERRUPT_COREx_INTR_STATUS_3_REG
97	PERI_BACKUP_INT	INTERRUPT_COREx_PERI_BACKUP_INT_MAP_REG	1		
98	DMA_EXTMEM_REJECT_INT	INTERRUPT_COREx_DMA_EXTMEM_REJECT_INT_MAP_REG	2		

9.3.2 CPU Interrupts

Each CPU has 32 interrupts, numbered from 0 ~ 31, including 26 peripheral interrupts and six internal interrupts.

- Peripheral interrupts: triggered by peripheral interrupt sources, include the following types:
 - Level-triggered interrupts: triggered by a high level signal. The interrupt sources should hold the level till the CPU_x handles the interrupts.
 - Edge-triggered interrupts: triggered on a rising edge. CPU_x responds to this kind of interrupts immediately.
 - NMI interrupt: once triggered, the NMI interrupt can not be masked by software using the CPU_x internal registers. World Controller provides a way to mask this kind of interrupt. For more information, see Chapter 16 *World Controller (WCL)*.
- Internal interrupts: generated inside CPU_x, include the following types:
 - Timer interrupts: triggered by internal timers and are used to generate periodic interrupts.
 - Software interrupts: triggered when software writes to special registers.
 - Profiling interrupt: triggered for performance monitoring and analysis.

Level-triggered and edge-triggered both describe the ways of CPU_x to accept interrupt signals. For level-triggered interrupts, the level of interrupt signal should be kept till the CPU handles the interrupt, otherwise the interrupt may be lost. For edge-triggered interrupts, when a rising edge is detected, this edge will be recorded by CPU_x, which then allows the interrupt signal to be released.

Interrupt matrix routes the peripheral interrupt sources to any of the CPU_x peripheral interrupts. By such way, CPU_x can receive the interrupt signals from peripheral interrupt sources. Table 9-2 lists all the interrupts and their types as well as priorities.

ESP32-S3 supports the above-mentioned 32 interrupts at six levels as shown in the table below. A higher level corresponds to a higher priority. NMI has the highest interrupt priority and once triggered, the CPU_x must handle such interrupt. Nested interrupts are also supported, i.e. low-level interrupts can be stopped by high-level interrupts.

Table 9-2. CPU Interrupts

No.	Category	Type	Priority
0	Peripheral	Level-triggered	1
1	Peripheral	Level-triggered	1
2	Peripheral	Level-triggered	1
3	Peripheral	Level-triggered	1
4	Peripheral	Level-triggered	1
5	Peripheral	Level-triggered	1
6	Internal	Timer.0	1
7	Internal	Software	1
8	Peripheral	Level-triggered	1
9	Peripheral	Level-triggered	1
10	Peripheral	Level-triggered	1

No.	Category	Type	Priority
11	Internal	Profiling	3
12	Peripheral	Level-triggered	1
13	Peripheral	Level-triggered	1
14	Peripheral	NMI	NMI
15	Internal	Timer.1	3
16	Internal	Timer.2	5
17	Peripheral	Level-triggered	1
18	Peripheral	Level-triggered	1
19	Peripheral	Level-triggered	2
20	Peripheral	Level-triggered	2
21	Peripheral	Level-triggered	2
22	Peripheral	Level-triggered	3
23	Peripheral	Level-triggered	3
24	Peripheral	Level-triggered	4
25	Peripheral	Level-triggered	4
26	Peripheral	Level-triggered	5
27	Peripheral	Level-triggered	3
28	Peripheral	Level-triggered	4
29	Internal	Software	3
30	Peripheral	Level-triggered	4
31	Peripheral	Level-triggered	5

9.3.3 Allocate Peripheral Interrupt Source to CPU_x Interrupt

In this section, the following terms are used to describe the operation of the interrupt matrix.

- Source_Y: stands for a peripheral interrupt source, wherein, *Y* means the number of this interrupt source in Table 9-1.
- INTERRUPT_CORE_x_SOURCE_Y_MAP_REG: stands for a configuration register for the peripheral interrupt source (Source_Y) of CPU_x.
- Interrupt_P: stands for the CPU_x peripheral interrupt numbered as Num_P. The value of Num_P can be 0 ~ 5, 8 ~ 10, 12 ~ 14, 17 ~ 28, and 30 ~ 31. See Table 9-2.
- Interrupt_I: stands for the CPU_x internal interrupt numbered as Num_I. The value of Num_I can be 6, 7, 11, 15, 16, and 29. See Table 9-2.

9.3.3.1 Allocate one peripheral interrupt source (Source_Y) to CPU_x

Setting the corresponding configuration register INTERRUPT_CORE_x_SOURCE_Y_MAP_REG of Source_Y to Num

_P allocates this interrupt source to Interrupt_P. Num_P here can be any value from 0 ~ 5, 8 ~ 10, 12 ~ 14, 17 ~ 28, and 30 ~ 31. Note that one CPU_x interrupt can be shared by multiple peripherals.

9.3.3.2 Allocate multiple peripheral interrupt sources (Source_{Yn}) to CPU_x

Setting the corresponding configuration register `INTERRUPT_COREx_SOURCE_Yn_MAP_REG` of each interrupt source to the same Num_P allocates multiple sources to the same Interrupt_P. Any of these sources can trigger CPU_x Interrupt_P. When an interrupt signal is generated, CPU_x checks the interrupt status registers to figure out which peripheral the signal comes from.

9.3.3.3 Disable CPU_x peripheral interrupt source (Source_Y)

Setting the corresponding configuration register `INTERRUPT_COREx_SOURCE_Y_MAP_REG` of the source to any Num_I disables this interrupt Source_Y. The choice of Num_I (6, 7, 11, 15, 16, 29) does not matter, as none of peripheral interrupt sources allocated to Num_I is connected to the CPU_x. Therefore this functionality can be used to disable peripheral interrupt sources.

9.3.4 Disable CPU_x NMI Interrupt

All CPU_x interrupts, except for NMI interrupt (No.14 in Table 9-2), can be masked and enabled by software using CPU special register (INTENABLE). NMI interrupt can not be masked by the way above, but ESP32-S3 provides two ways to mask NMI interrupt:

- Disconnect peripheral interrupt sources from NMI interrupt, i.e. the sources routed to NMI interrupt before are now routed to other interrupts. By such way, the previous NMI interrupt is maskable.
- Connect peripheral interrupt sources with NMI interrupt, but use World Controller module to mask NMI interrupt. For more information, see Chapter Chapter 16 *World Controller (WCL)*.

9.3.5 Query Current Interrupt Status of Peripheral Interrupt Source

Users can query current interrupt status of a CPU_x peripheral interrupt source by reading the bit value in `INTERRUPT_COREx_INTR_STATUS_n_REG` (read only). For the mapping between `INTERRUPT_COREx_INTR_STATUS_n_REG` and peripheral interrupt sources, please refer to Table 9-1.

9.4 Register Summary

The addresses in this section are relative to the Interrupt Matrix base address provided in Table 4-3 in Chapter 4 *System and Memory*.

The abbreviations given in Column **Access** are explained in Section [Access Types for Registers](#).

9.4.1 CPU0 Interrupt Register Summary

Name	Description	Address	Access
Configuration Registers			
INTERRUPT_CORE0_MAC_INTR_MAP_REG	MAC interrupt configuration register	0x0000	R/W
INTERRUPT_CORE0_MAC_NMI_MAP_REG	MAC_NMI interrupt configuration register	0x0004	R/W
INTERRUPT_CORE0_PWR_INTR_MAP_REG	PWR interrupt configuration register	0x0008	R/W
INTERRUPT_CORE0_BB_INT_MAP_REG	BB interrupt configuration register	0x000C	R/W
INTERRUPT_CORE0_BT_MAC_INT_MAP_REG	BB_MAC interrupt configuration register	0x0010	R/W
INTERRUPT_CORE0_BT_BB_INT_MAP_REG	BT_BB interrupt configuration register	0x0014	R/W
INTERRUPT_CORE0_BT_BB_NMI_MAP_REG	BT_BB_NMI interrupt configuration register	0x0018	R/W
INTERRUPT_CORE0_RWBT_IRQ_MAP_REG	RWBT_IRQ interrupt configuration register	0x001C	R/W
INTERRUPT_CORE0_RWBLE_IRQ_MAP_REG	RWBLE_IRQ interrupt configuration register	0x0020	R/W
INTERRUPT_CORE0_RWBT_NMI_MAP_REG	RWBT_NMI interrupt configuration register	0x0024	R/W
INTERRUPT_CORE0_RWBLE_NMI_MAP_REG	RWBLE_NMI interrupt configuration register	0x0028	R/W
INTERRUPT_CORE0_I2C_MST_INT_MAP_REG	I2C_MST interrupt configuration register	0x002C	R/W
INTERRUPT_CORE0_UHCI0_INTR_MAP_REG	UHCI0 interrupt configuration register	0x0038	R/W
INTERRUPT_CORE0_GPIO_INTERRUPT_CPU_MAP_REG	GPIO_INTERRUPT_CPU interrupt configuration register	0x0040	R/W
INTERRUPT_CORE0_GPIO_INTERRUPT_CPU_NMI_MAP_REG	GPIO_INTERRUPT_CPU_NMI interrupt configuration register	0x0044	R/W
INTERRUPT_CORE0_SPI_INTR_1_MAP_REG	SPI_INTR_1 interrupt configuration register	0x0050	R/W
INTERRUPT_CORE0_SPI_INTR_2_MAP_REG	SPI_INTR_2 interrupt configuration register	0x0054	R/W
INTERRUPT_CORE0_SPI_INTR_3_MAP_REG	SPI_INTR_3 interrupt configuration register	0x0058	R/W
INTERRUPT_CORE0_LCD_CAM_INT_MAP_REG	LCD_CAM interrupt configuration register	0x0060	R/W
INTERRUPT_CORE0_I2S0_INT_MAP_REG	I2S0 interrupt configuration register	0x0064	R/W
INTERRUPT_CORE0_I2S1_INT_MAP_REG	I2S1 interrupt configuration register	0x0068	R/W
INTERRUPT_CORE0_UART_INTR_MAP_REG	UART interrupt configuration register	0x006C	R/W
INTERRUPT_CORE0_UART1_INTR_MAP_REG	UART1 interrupt configuration register	0x0070	R/W
INTERRUPT_CORE0_UART2_INTR_MAP_REG	UART2 interrupt configuration register	0x0074	R/W
INTERRUPT_CORE0_SDIO_HOST_INTERRUPT_MAP_REG	SDIO_HOST interrupt configuration register	0x0078	R/W
INTERRUPT_CORE0_PWM0_INTR_MAP_REG	PWM0 interrupt configuration register	0x007C	R/W

Name	Description	Address	Access
INTERRUPT_CORE0_PWM1_INTR_MAP_REG	PWM1 interrupt configuration register	0x0080	R/W
INTERRUPT_CORE0_LEDC_INT_MAP_REG	LEDC interrupt configuration register	0x008C	R/W
INTERRUPT_CORE0_EFUSE_INT_MAP_REG	EFUSE interrupt configuration register	0x0090	R/W
INTERRUPT_CORE0_TWAI_INT_MAP_REG	CAN interrupt configuration register	0x0094	R/W
INTERRUPT_CORE0_USB_INTR_MAP_REG	USB interrupt configuration register	0x0098	R/W
INTERRUPT_CORE0_RTC_CORE_INTR_MAP_REG	RTC_CORE interrupt configuration register	0x009C	R/W
INTERRUPT_CORE0_RMT_INTR_MAP_REG	RMT interrupt configuration register	0x00A0	R/W
INTERRUPT_CORE0_PCNT_INTR_MAP_REG	PCNT interrupt configuration register	0x00A4	R/W
INTERRUPT_CORE0_I2C_EXT0_INTR_MAP_REG	I2C_EXT0 interrupt configuration register	0x00A8	R/W
INTERRUPT_CORE0_I2C_EXT1_INTR_MAP_REG	I2C_EXT1 interrupt configuration register	0x00AC	R/W
INTERRUPT_CORE0_TG_T0_INT_MAP_REG	TG_T0 interrupt configuration register	0x00C8	R/W
INTERRUPT_CORE0_TG_T1_INT_MAP_REG	TG_T1 interrupt configuration register	0x00CC	R/W
INTERRUPT_CORE0_TG_WDT_INT_MAP_REG	TG_WDT interrupt configuration register	0x00D0	R/W
INTERRUPT_CORE0_TG1_T0_INT_MAP_REG	TG1_T0 interrupt configuration register	0x00D4	R/W
INTERRUPT_CORE0_TG1_T1_INT_MAP_REG	TG1_T1 interrupt configuration register	0x00D8	R/W
INTERRUPT_CORE0_TG1_WDT_INT_MAP_REG	TG1_WDT interrupt configuration register	0x00DC	R/W
INTERRUPT_CORE0_CACHE_IA_INT_MAP_REG	CACHE_IA interrupt configuration register	0x00E0	R/W
INTERRUPT_CORE0_SYSTIMER_TARGET0_INT_MAP_REG	SYSTIMER_TARGET0 interrupt configuration register	0x00E4	R/W
INTERRUPT_CORE0_SYSTIMER_TARGET1_INT_MAP_REG	SYSTIMER_TARGET1 interrupt configuration register	0x00E8	R/W
INTERRUPT_CORE0_SYSTIMER_TARGET2_INT_MAP_REG	SYSTIMER_TARGET2 interrupt configuration register	0x00EC	R/W
INTERRUPT_CORE0_SPI_MEM_REJECT_INTR_MAP_REG	SPI_MEM_REJECT interrupt configuration register	0x00F0	R/W
INTERRUPT_CORE0_DCACHE_PRELOAD_INT_MAP_REG	DCACHE_PRELOAD interrupt configuration register	0x00F4	R/W
INTERRUPT_CORE0_ICACHE_PRELOAD_INT_MAP_REG	ICACHE_PRELOAD interrupt configuration register	0x00F8	R/W
INTERRUPT_CORE0_DCACHE_SYNC_INT_MAP_REG	DCACHE_SYNC interrupt configuration register	0x00FC	R/W
INTERRUPT_CORE0_ICACHE_SYNC_INT_MAP_REG	ICACHE_SYNC interrupt configuration register	0x0100	R/W
INTERRUPT_CORE0_APB_ADC_INT_MAP_REG	APB_ADC interrupt configuration register	0x0104	R/W
INTERRUPT_CORE0_DMA_IN_CH0_INT_MAP_REG	DMA_IN_CH0 interrupt configuration register	0x0108	R/W
INTERRUPT_CORE0_DMA_IN_CH1_INT_MAP_REG	DMA_IN_CH1 interrupt configuration register	0x010C	R/W
INTERRUPT_CORE0_DMA_IN_CH2_INT_MAP_REG	DMA_IN_CH2 interrupt configuration register	0x0110	R/W

Name	Description	Address	Access
INTERRUPT_CORE0_DMA_IN_CH3_INT_MAP_REG	DMA_IN_CH3 interrupt configuration register	0x0114	R/W
INTERRUPT_CORE0_DMA_IN_CH4_INT_MAP_REG	DMA_IN_CH4 interrupt configuration register	0x0118	R/W
INTERRUPT_CORE0_DMA_OUT_CH0_INT_MAP_REG	DMA_OUT_CH0 interrupt configuration register	0x011C	R/W
INTERRUPT_CORE0_DMA_OUT_CH1_INT_MAP_REG	DMA_OUT_CH1 interrupt configuration register	0x0120	R/W
INTERRUPT_CORE0_DMA_OUT_CH2_INT_MAP_REG	DMA_OUT_CH2 interrupt configuration register	0x0124	R/W
INTERRUPT_CORE0_DMA_OUT_CH3_INT_MAP_REG	DMA_OUT_CH3 interrupt configuration register	0x0128	R/W
INTERRUPT_CORE0_DMA_OUT_CH4_INT_MAP_REG	DMA_OUT_CH4 interrupt configuration register	0x012C	R/W
INTERRUPT_CORE0_RSA_INT_MAP_REG	RSA interrupt configuration register	0x0130	R/W
INTERRUPT_CORE0_AES_INT_MAP_REG	AES interrupt configuration register	0x0134	R/W
INTERRUPT_CORE0_SHA_INT_MAP_REG	SHA interrupt configuration register	0x0138	R/W
INTERRUPT_CORE0_CPU_INTR_FROM_CPU_0_MAP_REG	CPU_INTR_FROM_CPU_0 interrupt configuration register	0x013C	R/W
INTERRUPT_CORE0_CPU_INTR_FROM_CPU_1_MAP_REG	CPU_INTR_FROM_CPU_1 interrupt configuration register	0x0140	R/W
INTERRUPT_CORE0_CPU_INTR_FROM_CPU_2_MAP_REG	CPU_INTR_FROM_CPU_2 interrupt configuration register	0x0144	R/W
INTERRUPT_CORE0_CPU_INTR_FROM_CPU_3_MAP_REG	CPU_INTR_FROM_CPU_3 interrupt configuration register	0x0148	R/W
INTERRUPT_CORE0_ASSIST_DEBUG_INTR_MAP_REG	ASSIST_DEBUG interrupt configuration register	0x014C	R/W
INTERRUPT_CORE0_DMA_APBPERI_PMS_MONITOR_VIOLATE_INTR_MAP_REG	dma_pms_monitor_violatile interrupt configuration register	0x0150	R/W
INTERRUPT_CORE0_CORE_0_IRAM0_PMS_MONITOR_VIOLATE_INTR_MAP_REG	core0_IRam0_pms_monitor_violatile interrupt configuration register	0x0154	R/W
INTERRUPT_CORE0_CORE_0_DRAM0_PMS_MONITOR_VIOLATE_INTR_MAP_REG	core0_DRam0_pms_monitor_violatile interrupt configuration register	0x0158	R/W
INTERRUPT_CORE0_CORE_0_PIF_PMS_MONITOR_VIOLATE_INTR_MAP_REG	core0_PIF_pms_monitor_violatile interrupt configuration register	0x015C	R/W
INTERRUPT_CORE0_CORE_0_PIF_PMS_MONITOR_VIOLATE_SIZE_INTR_MAP_REG	core0_PIF_pms_monitor_violatile_size interrupt configuration register	0x0160	R/W
INTERRUPT_CORE0_CORE_1_IRAM0_PMS_MONITOR_VIOLATE_INTR_MAP_REG	core1_IRam0_pms_monitor_violatile interrupt configuration register	0x0164	R/W
INTERRUPT_CORE0_CORE_1_DRAM0_PMS_MONITOR_VIOLATE_INTR_MAP_REG	core1_DRam0_pms_monitor_violatile interrupt configuration register	0x0168	R/W

Name	Description	Address	Access
INTERRUPT_CORE0_CORE_1_PIF_PMS_MONITOR_VIOLATE_INTR_MAP_REG	core1_PIF_pms_monitor_violatile interrupt configuration register	0x016C	R/W
INTERRUPT_CORE0_CORE_1_PIF_PMS_MONITOR_VIOLATE_SIZE_INTR_MAP_REG	core1_PIF_pms_monitor_violatile_size interrupt configuration register	0x0170	R/W
INTERRUPT_CORE0_BACKUP_PMS_VIOLATE_INTR_MAP_REG	BACKUP_PMS_MONITOR_VIOLATILE interrupt configuration register	0x0174	R/W
INTERRUPT_CORE0_CACHE_CORE0_ACS_INT_MAP_REG	CACHE_CORE0_ACS interrupt configuration register	0x0178	R/W
INTERRUPT_CORE0_CACHE_CORE1_ACS_INT_MAP_REG	CACHE_CORE1_ACS interrupt configuration register	0x017C	R/W
INTERRUPT_CORE0_USB_DEVICE_INT_MAP_REG	USB_DEVICE interrupt configuration register	0x0180	R/W
INTERRUPT_CORE0_PERI_BACKUP_INT_MAP_REG	PERI_BACKUP interrupt configuration register	0x0184	R/W
INTERRUPT_CORE0_DMA_EXTMEM_REJECT_INT_MAP_REG	DMA_EXTMEM_REJECT interrupt configuration register	0x0188	R/W
Status Registers			
INTERRUPT_CORE0_INTR_STATUS_0_REG	Interrupt status register	0x018C	RO
INTERRUPT_CORE0_INTR_STATUS_1_REG	Interrupt status register	0x0190	RO
INTERRUPT_CORE0_INTR_STATUS_2_REG	Interrupt status register	0x0194	RO
INTERRUPT_CORE0_INTR_STATUS_3_REG	Interrupt status register	0x0198	RO
Clock Register			
INTERRUPT_CORE0_CLOCK_GATE_REG	Clock gate register	0x019C	R/W
Version Register			
INTERRUPT_CORE0_DATE_REG	Version control register	0x07FC	R/W

9.4.2 CPU1 Interrupt Register Summary

Name	Description	Address	Access
Configuration Registers			
INTERRUPT_CORE1_MAC_INTR_MAP_REG	MAC interrupt configuration register	0x0800	R/W
INTERRUPT_CORE1_MAC_NMI_MAP_REG	MAC_NMI interrupt configuration register	0x0804	R/W
INTERRUPT_CORE1_PWR_INTR_MAP_REG	PWR interrupt configuration register	0x0808	R/W
INTERRUPT_CORE1_BB_INT_MAP_REG	BB interrupt configuration register	0x080C	R/W

Name	Description	Address	Access
INTERRUPT_CORE1_BT_MAC_INT_MAP_REG	BB_MAC interrupt configuration register	0x0810	R/W
INTERRUPT_CORE1_BT_BB_INT_MAP_REG	BT_BB interrupt configuration register	0x0814	R/W
INTERRUPT_CORE1_BT_BB_NMI_MAP_REG	BT_BB_NMI interrupt configuration register	0x0818	R/W
INTERRUPT_CORE1_RWBT_IRQ_MAP_REG	RWBT_IRQ interrupt configuration register	0x081C	R/W
INTERRUPT_CORE1_RWBLE_IRQ_MAP_REG	RWBLE_IRQ interrupt configuration register	0x0820	R/W
INTERRUPT_CORE1_RWBT_NMI_MAP_REG	RWBT_NMI interrupt configuration register	0x0824	R/W
INTERRUPT_CORE1_RWBLE_NMI_MAP_REG	RWBLE_NMI interrupt configuration register	0x0828	R/W
INTERRUPT_CORE1_I2C_MST_INT_MAP_REG	I2C_MST interrupt configuration register	0x082C	R/W
INTERRUPT_CORE1_UHCI0_INTR_MAP_REG	UHCI0 interrupt configuration register	0x0838	R/W
INTERRUPT_CORE1_GPIO_INTERRUPT_CPU_MAP_REG	GPIO_INTERRUPT_CPU interrupt configuration register	0x0840	R/W
INTERRUPT_CORE1_GPIO_INTERRUPT_CPU_NMI_MAP_REG	GPIO_INTERRUPT_CPU_NMI Interrupt configuration register	0x0844	R/W
INTERRUPT_CORE1_SPI_INTR_1_MAP_REG	SPI_INTR_1 interrupt configuration register	0x0850	R/W
INTERRUPT_CORE1_SPI_INTR_2_MAP_REG	SPI_INTR_2 interrupt configuration register	0x0854	R/W
INTERRUPT_CORE1_SPI_INTR_3_MAP_REG	SPI_INTR_3 interrupt configuration register	0x0858	R/W
INTERRUPT_CORE1_LCD_CAM_INT_MAP_REG	LCD_CAM interrupt configuration register	0x0860	R/W
INTERRUPT_CORE1_I2S0_INT_MAP_REG	I2S0 interrupt configuration register	0x0864	R/W
INTERRUPT_CORE1_I2S1_INT_MAP_REG	I2S1 interrupt configuration register	0x0868	R/W
INTERRUPT_CORE1_UART_INTR_MAP_REG	UART interrupt configuration register	0x086C	R/W
INTERRUPT_CORE1_UART1_INTR_MAP_REG	UART1 interrupt configuration register	0x0870	R/W
INTERRUPT_CORE1_UART2_INTR_MAP_REG	UART2 interrupt configuration register	0x0874	R/W
INTERRUPT_CORE1_SDIO_HOST_INTERRUPT_MAP_REG	SDIO_HOST interrupt configuration register	0x0878	R/W
INTERRUPT_CORE1_PWM0_INTR_MAP_REG	PWM0 interrupt configuration register	0x087C	R/W
INTERRUPT_CORE1_PWM1_INTR_MAP_REG	PWM1 interrupt configuration register	0x0880	R/W
INTERRUPT_CORE1_LEDC_INT_MAP_REG	LEDC interrupt configuration register	0x088C	R/W
INTERRUPT_CORE1_EFUSE_INT_MAP_REG	EFUSE interrupt configuration register	0x0890	R/W
INTERRUPT_CORE1_TWAI_INT_MAP_REG	TWAI interrupt configuration register	0x0894	R/W
INTERRUPT_CORE1_USB_INTR_MAP_REG	USB interrupt configuration register	0x0898	R/W
INTERRUPT_CORE1_RTC_CORE_INTR_MAP_REG	RTC_CORE interrupt configuration register	0x089C	R/W
INTERRUPT_CORE1_RMT_INTR_MAP_REG	RMT interrupt configuration register	0x08A0	R/W

Name	Description	Address	Access
INTERRUPT_CORE1_PCNT_INTR_MAP_REG	PCNT interrupt configuration register	0x08A4	R/W
INTERRUPT_CORE1_I2C_EXT0_INTR_MAP_REG	I2C_EXT0 interrupt configuration register	0x08A8	R/W
INTERRUPT_CORE1_I2C_EXT1_INTR_MAP_REG	I2C_EXT1 interrupt configuration register	0x08AC	R/W
INTERRUPT_CORE1_TG_T1_INT_MAP_REG	TG_T1 interrupt configuration register	0x08CC	R/W
INTERRUPT_CORE1_TG_WDT_INT_MAP_REG	TG_WDT interrupt configuration register	0x08D0	R/W
INTERRUPT_CORE1_TG1_T0_INT_MAP_REG	TG1_T0 interrupt configuration register	0x08D4	R/W
INTERRUPT_CORE1_TG1_T1_INT_MAP_REG	TG1_T1 interrupt configuration register	0x08D8	R/W
INTERRUPT_CORE1_TG1_WDT_INT_MAP_REG	TG1_WDT interrupt configuration register	0x08DC	R/W
INTERRUPT_CORE1_CACHE_IA_INT_MAP_REG	CACHE_IA interrupt configuration register	0x08E0	R/W
INTERRUPT_CORE1_SYSTIMER_TARGET0_INT_MAP_REG	SYSTIMER_TARGET0 interrupt configuration register	0x08E4	R/W
INTERRUPT_CORE1_SYSTIMER_TARGET1_INT_MAP_REG	SYSTIMER_TARGET1 interrupt configuration register	0x08E8	R/W
INTERRUPT_CORE1_SYSTIMER_TARGET2_INT_MAP_REG	SYSTIMER_TARGET2 interrupt configuration register	0x08EC	R/W
INTERRUPT_CORE1_SPI_MEM_REJECT_INTR_MAP_REG	SPI_MEM_REJECT interrupt configuration register	0x08F0	R/W
INTERRUPT_CORE1_DCACHE_PRELOAD_INT_MAP_REG	DCACHE_PRELOAD interrupt configuration register	0x08F4	R/W
INTERRUPT_CORE1_ICACHE_PRELOAD_INT_MAP_REG	ICACHE_PRELOAD interrupt configuration register	0x08F8	R/W
INTERRUPT_CORE1_DCACHE_SYNC_INT_MAP_REG	DCACHE_SYNC interrupt configuration register	0x08FC	R/W
INTERRUPT_CORE1_ICACHE_SYNC_INT_MAP_REG	ICACHE_SYNC interrupt configuration register	0x0900	R/W
INTERRUPT_CORE1_APB_ADC_INT_MAP_REG	APB_ADC interrupt configuration register	0x0904	R/W
INTERRUPT_CORE1_DMA_IN_CH0_INT_MAP_REG	DMA_IN_CH0 interrupt configuration register	0x0908	R/W
INTERRUPT_CORE1_DMA_IN_CH1_INT_MAP_REG	DMA_IN_CH1 interrupt configuration register	0x090C	R/W
INTERRUPT_CORE1_DMA_IN_CH2_INT_MAP_REG	DMA_IN_CH2 interrupt configuration register	0x0910	R/W
INTERRUPT_CORE1_DMA_IN_CH3_INT_MAP_REG	DMA_IN_CH3 interrupt configuration register	0x0914	R/W
INTERRUPT_CORE1_DMA_IN_CH4_INT_MAP_REG	DMA_IN_CH4 interrupt configuration register	0x0918	R/W
INTERRUPT_CORE1_DMA_OUT_CH0_INT_MAP_REG	DMA_OUT_CH0 interrupt configuration register	0x091C	R/W
INTERRUPT_CORE1_DMA_OUT_CH1_INT_MAP_REG	DMA_OUT_CH1 interrupt configuration register	0x0920	R/W
INTERRUPT_CORE1_DMA_OUT_CH2_INT_MAP_REG	DMA_OUT_CH2 interrupt configuration register	0x0924	R/W
INTERRUPT_CORE1_DMA_OUT_CH3_INT_MAP_REG	DMA_OUT_CH3 interrupt configuration register	0x0928	R/W
INTERRUPT_CORE1_DMA_OUT_CH4_INT_MAP_REG	DMA_OUT_CH4 interrupt configuration register	0x092C	R/W
INTERRUPT_CORE1_RSA_INT_MAP_REG	RSA interrupt configuration register	0x0930	R/W

Name	Description	Address	Access
INTERRUPT_CORE1_AES_INT_MAP_REG	AES interrupt configuration register	0x0934	R/W
INTERRUPT_CORE1_SHA_INT_MAP_REG	SHA interrupt configuration register	0x0938	R/W
INTERRUPT_CORE1_CPU_INTR_FROM_CPU_0_MAP_REG	CPU_INTR_FROM_CPU_0 interrupt configuration register	0x093C	R/W
INTERRUPT_CORE1_CPU_INTR_FROM_CPU_1_MAP_REG	CPU_INTR_FROM_CPU_1 interrupt configuration register	0x0940	R/W
INTERRUPT_CORE1_CPU_INTR_FROM_CPU_2_MAP_REG	CPU_INTR_FROM_CPU_2 interrupt configuration register	0x0944	R/W
INTERRUPT_CORE1_CPU_INTR_FROM_CPU_3_MAP_REG	CPU_INTR_FROM_CPU_3 interrupt configuration register	0x0948	R/W
INTERRUPT_CORE1_ASSIST_DEBUG_INTR_MAP_REG	ASSIST_DEBUG interrupt configuration register	0x094C	R/W
INTERRUPT_CORE1_DMA_APBPERI_PMS_MONITOR_VIOLATE_INTR_MAP_REG	dma_pms_monitor_violatile interrupt configuration register	0x0950	R/W
INTERRUPT_CORE1_CORE_0_IRAM0_PMS_MONITOR_VIOLATE_INTR_MAP_REG	core0_IRam0_pms_monitor_violatile interrupt configuration register	0x0954	R/W
INTERRUPT_CORE1_CORE_0_DRAM0_PMS_MONITOR_VIOLATE_INTR_MAP_REG	core0_DRam0_pms_monitor_violatile interrupt configuration register	0x0958	R/W
INTERRUPT_CORE1_CORE_0_PIF_PMS_MONITOR_VIOLATE_INTR_MAP_REG	core0_PIF_pms_monitor_violatile interrupt configuration register	0x095C	R/W
INTERRUPT_CORE1_CORE_0_PIF_PMS_MONITOR_VIOLATE_SIZE_INTR_MAP_REG	core0_PIF_pms_monitor_violatile_size interrupt configuration register	0x0960	R/W
INTERRUPT_CORE1_CORE_1_IRAM0_PMS_MONITOR_VIOLATE_INTR_MAP_REG	core1_IRam0_pms_monitor_violatile interrupt configuration register	0x0964	R/W
INTERRUPT_CORE1_CORE_1_DRAM0_PMS_MONITOR_VIOLATE_INTR_MAP_REG	core1_DRam0_pms_monitor_violatile interrupt configuration register	0x0968	R/W
INTERRUPT_CORE1_CORE_1_PIF_PMS_MONITOR_VIOLATE_INTR_MAP_REG	core1_PIF_pms_monitor_violatile interrupt configuration register	0x096C	R/W
INTERRUPT_CORE1_CORE_1_PIF_PMS_MONITOR_VIOLATE_SIZE_INTR_MAP_REG	core1_PIF_pms_monitor_violatile_size interrupt configuration register	0x0970	R/W
INTERRUPT_CORE1_BACKUP_PMS_VIOLATE_INTR_MAP_REG	BACKUP_PMS_MONITOR_VIOLATILE interrupt configuration register	0x0974	R/W
INTERRUPT_CORE1_CACHE_CORE0_ACS_INT_MAP_REG	CACHE_CORE0_ACS interrupt configuration register REG	0x0978	R/W
INTERRUPT_CORE1_CACHE_CORE1_ACS_INT_MAP_REG	CACHE_CORE1_ACS interrupt configuration register REG	0x097C	R/W

Name	Description	Address	Access
INTERRUPT_CORE1_USB_DEVICE_INT_MAP_REG	USB_DEVICE interrupt configuration register	0x0980	R/W
INTERRUPT_CORE1_PERI_BACKUP_INT_MAP_REG	PERI_BACKUP interrupt configuration register	0x0984	R/W
INTERRUPT_CORE1_DMA_EXTMEM_REJECT_INT_MAP_REG	DMA_EXTMEM_REJECT interrupt configuration register	0x0988	R/W
Status Registers			
INTERRUPT_CORE1_INTR_STATUS_0_REG	Interrupt status register	0x098C	RO
INTERRUPT_CORE1_INTR_STATUS_1_REG	Interrupt status register	0x0990	RO
INTERRUPT_CORE1_INTR_STATUS_2_REG	Interrupt status register	0x0994	RO
INTERRUPT_CORE1_INTR_STATUS_3_REG	Interrupt status register	0x0998	RO
Clock Register			
INTERRUPT_CORE1_CLOCK_GATE_REG	Clock gate register	0x099C	R/W
Version Register			
INTERRUPT_CORE1_DATE_REG	Version control register	0x0FFC	R/W

9.5 Registers

9.5.1 CPU0 Interrupt Registers

- Register 9.1. INTERRUPT_CORE0_MAC_INTR_MAP_REG (0x0000)
- Register 9.2. INTERRUPT_CORE0_MAC_NMI_MAP_REG (0x0004)
- Register 9.3. INTERRUPT_CORE0_PWR_INTR_MAP_REG (0x0008)
- Register 9.4. INTERRUPT_CORE0_BB_INT_MAP_REG (0x000C)
- Register 9.5. INTERRUPT_CORE0_BT_MAC_INT_MAP_REG (0x0010)
- Register 9.6. INTERRUPT_CORE0_BT_BB_INT_MAP_REG (0x0014)
- Register 9.7. INTERRUPT_CORE0_BT_BB_NMI_MAP_REG (0x0018)
- Register 9.8. INTERRUPT_CORE0_RWBT_IRQ_MAP_REG (0x001C)
- Register 9.9. INTERRUPT_CORE0_RWBLE_IRQ_MAP_REG (0x0020)
- Register 9.10. INTERRUPT_CORE0_RWBT_NMI_MAP_REG (0x0024)
- Register 9.11. INTERRUPT_CORE0_RWBLE_NMI_MAP_REG (0x0028)
- Register 9.12. INTERRUPT_CORE0_I2C_MST_INT_MAP_REG (0x002C)
- Register 9.13. INTERRUPT_CORE0_UHCIO_INTR_MAP_REG (0x0038)
- Register 9.14. INTERRUPT_CORE0_GPIO_INTERRUPT_CPU_MAP_REG (0x0040)
- Register 9.15. INTERRUPT_CORE0_GPIO_INTERRUPT_CPU_NMI_MAP_REG (0x0044)
- Register 9.16. INTERRUPT_CORE0_SPL_INTR_1_MAP_REG (0x0050)
- Register 9.17. INTERRUPT_CORE0_SPL_INTR_2_MAP_REG (0x0054)
- Register 9.18. INTERRUPT_CORE0_SPL_INTR_3_MAP_REG (0x0058)
- Register 9.19. INTERRUPT_CORE0_LCD_CAM_INT_MAP_REG (0x0060)
- Register 9.20. INTERRUPT_CORE0_I2S0_INT_MAP_REG (0x0064)
- Register 9.21. INTERRUPT_CORE0_I2S1_INT_MAP_REG (0x0068)
- Register 9.22. INTERRUPT_CORE0_UART_INTR_MAP_REG (0x006C)
- Register 9.23. INTERRUPT_CORE0_UART1_INTR_MAP_REG (0x0070)
- Register 9.24. INTERRUPT_CORE0_UART2_INTR_MAP_REG (0x0074)
- Register 9.25. INTERRUPT_CORE0_SDIO_HOST_INTERRUPT_MAP_REG (0x0078)
- Register 9.26. INTERRUPT_CORE0_PWM0_INTR_MAP_REG (0x007C)
- Register 9.27. INTERRUPT_CORE0_PWM1_INTR_MAP_REG (0x0080)
- Register 9.28. INTERRUPT_CORE0_LEDC_INT_MAP_REG (0x008C)
- Register 9.29. INTERRUPT_CORE0_EFUSE_INT_MAP_REG (0x0090)
- Register 9.30. INTERRUPT_CORE0_TWAI_INT_MAP_REG (0x0094)
- Register 9.31. INTERRUPT_CORE0_USB_INTR_MAP_REG (0x0098)
- Register 9.32. INTERRUPT_CORE0_RTC_CORE_INTR_MAP_REG (0x009C)

- Register 9.33. INTERRUPT_CORE0_RMT_INTR_MAP_REG (0x00A0)
- Register 9.34. INTERRUPT_CORE0_PCNT_INTR_MAP_REG (0x00A4)
- Register 9.35. INTERRUPT_CORE0_I2C_EXT0_INTR_MAP_REG (0x00A8)
- Register 9.36. INTERRUPT_CORE0_I2C_EXT1_INTR_MAP_REG (0x00AC)
- Register 9.37. INTERRUPT_CORE0_TG_T0_INT_MAP_REG (0x00C8)
- Register 9.38. INTERRUPT_CORE0_TG_T1_INT_MAP_REG (0x00CC)
- Register 9.39. INTERRUPT_CORE0_TG_WDT_INT_MAP_REG (0x00D0)
- Register 9.40. INTERRUPT_CORE0_TG1_T0_INT_MAP_REG (0x00D4)
- Register 9.41. INTERRUPT_CORE0_TG1_T1_INT_MAP_REG (0x00D8)
- Register 9.42. INTERRUPT_CORE0_TG1_WDT_INT_MAP_REG (0x00DC)
- Register 9.43. INTERRUPT_CORE0_CACHE_IA_INT_MAP_REG (0x00E0)
- Register 9.44. INTERRUPT_CORE0_SYSTIMER_TARGET0_INT_MAP_REG (0x00E4)
- Register 9.45. INTERRUPT_CORE0_SYSTIMER_TARGET1_INT_MAP_REG (0x00E8)
- Register 9.46. INTERRUPT_CORE0_SYSTIMER_TARGET2_INT_MAP_REG (0x00EC)
- Register 9.47. INTERRUPT_CORE0_SPI_MEM_REJECT_INTR_MAP_REG (0x00F0)
- Register 9.48. INTERRUPT_CORE0_DCACHE_PRELOAD_INT_MAP_REG (0x00F4)
- Register 9.49. INTERRUPT_CORE0_ICACHE_PRELOAD_INT_MAP_REG (0x00F8)
- Register 9.50. INTERRUPT_CORE0_DCACHE_SYNC_INT_MAP_REG (0x00FC)
- Register 9.51. INTERRUPT_CORE0_ICACHE_SYNC_INT_MAP_REG (0x0100)
- Register 9.52. INTERRUPT_CORE0_APB_ADC_INT_MAP_REG (0x0104)
- Register 9.53. INTERRUPT_CORE0_DMA_IN_CH0_INT_MAP_REG (0x0108)
- Register 9.54. INTERRUPT_CORE0_DMA_IN_CH1_INT_MAP_REG (0x010C)
- Register 9.55. INTERRUPT_CORE0_DMA_IN_CH2_INT_MAP_REG (0x0110)
- Register 9.56. INTERRUPT_CORE0_DMA_IN_CH3_INT_MAP_REG (0x0114)
- Register 9.57. INTERRUPT_CORE0_DMA_IN_CH4_INT_MAP_REG (0x0118)
- Register 9.58. INTERRUPT_CORE0_DMA_OUT_CH0_INT_MAP_REG (0x011C)
- Register 9.59. INTERRUPT_CORE0_DMA_OUT_CH1_INT_MAP_REG (0x0120)
- Register 9.60. INTERRUPT_CORE0_DMA_OUT_CH2_INT_MAP_REG (0x0124)
- Register 9.61. INTERRUPT_CORE0_DMA_OUT_CH3_INT_MAP_REG (0x0128)
- Register 9.62. INTERRUPT_CORE0_DMA_OUT_CH4_INT_MAP_REG (0x012C)
- Register 9.63. INTERRUPT_CORE0_RSA_INT_MAP_REG (0x0130)
- Register 9.64. INTERRUPT_CORE0_AES_INT_MAP_REG (0x0134)
- Register 9.65. INTERRUPT_CORE0_SHA_INT_MAP_REG (0x0138)
- Register 9.66. INTERRUPT_CORE0_CPU_INTR_FROM_CPU_0_MAP_REG (0x013C)
- Register 9.67. INTERRUPT_CORE0_CPU_INTR_FROM_CPU_1_MAP_REG (0x0140)

Register 9.68. INTERRUPT_CORE0_CPU_INTR_FROM_CPU_2_MAP_REG (0x0144)

Register 9.69. INTERRUPT_CORE0_CPU_INTR_FROM_CPU_3_MAP_REG (0x0148)

Register 9.70. INTERRUPT_CORE0_ASSIST_DEBUG_INTR_MAP_REG (0x014C)

Register 9.71. INTERRUPT_CORE0_DMA_APBPERI_PMS_MONITOR_VIOLATE_INTR_MAP_REG (0x0150)

Register 9.72. INTERRUPT_CORE0_CORE_0_IRAM0_PMS_MONITOR_VIOLATE_INTR_MAP_REG (0x0154)

Register 9.73. INTERRUPT_CORE0_CORE_0_DRAM0_PMS_MONITOR_VIOLATE_INTR_MAP_REG (0x0158)

Register 9.74. INTERRUPT_CORE0_CORE_0_PIF_PMS_MONITOR_VIOLATE_INTR_MAP_REG (0x015C)

Register 9.75. INTERRUPT_CORE0_CORE_0_PIF_PMS_MONITOR_VIOLATE_SIZE_INTR_MAP_REG (0x0160)

Register 9.76. INTERRUPT_CORE0_CORE_1_IRAM0_PMS_MONITOR_VIOLATE_INTR_MAP_REG (0x0164)

Register 9.77. INTERRUPT_CORE0_CORE_1_DRAM0_PMS_MONITOR_VIOLATE_INTR_MAP_REG (0x0168)

Register 9.78. INTERRUPT_CORE0_CORE_1_PIF_PMS_MONITOR_VIOLATE_INTR_MAP_REG (0x016C)

Register 9.79. INTERRUPT_CORE0_CORE_1_PIF_PMS_MONITOR_VIOLATE_SIZE_INTR_MAP_REG (0x0170)

Register 9.80. INTERRUPT_CORE0_BACKUP_PMS_VIOLATE_INTR_MAP_REG (0x0174)

Register 9.81. INTERRUPT_CORE0_CACHE_CORE0_ACS_INT_MAP_REG (0x0178)

Register 9.82. INTERRUPT_CORE0_CACHE_CORE1_ACS_INT_MAP_REG (0x017C)

Register 9.83. INTERRUPT_CORE0_USB_DEVICE_INT_MAP_REG (0x0180)

Register 9.84. INTERRUPT_CORE0_PERI_BACKUP_INT_MAP_REG (0x0184)

Register 9.85. INTERRUPT_CORE0_DMA_EXTMEM_REJECT_INT_MAP_REG (0x0188)

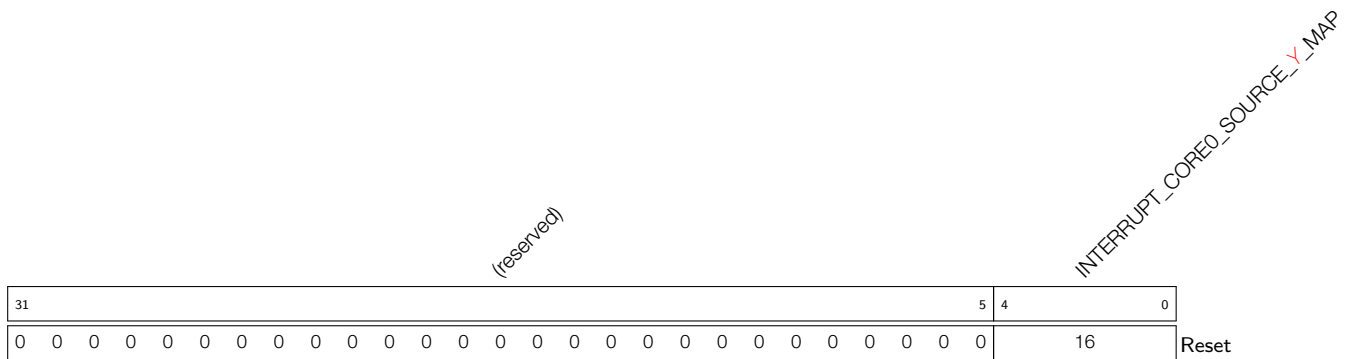

INTERRUPT_CORE0_SOURCE_Y_MAP Map interrupt signal of Source_Y to one of CPU0 external interrupt, can be configured as 0 ~ 5, 8 ~ 10, 12 ~ 14, 17 ~ 28, 30 ~ 31. The remaining values are invalid. For Source_Y, see Table 9-1. (R/W)

Register 9.86. INTERRUPT_CORE0_INTR_STATUS_0_REG (0x018C)

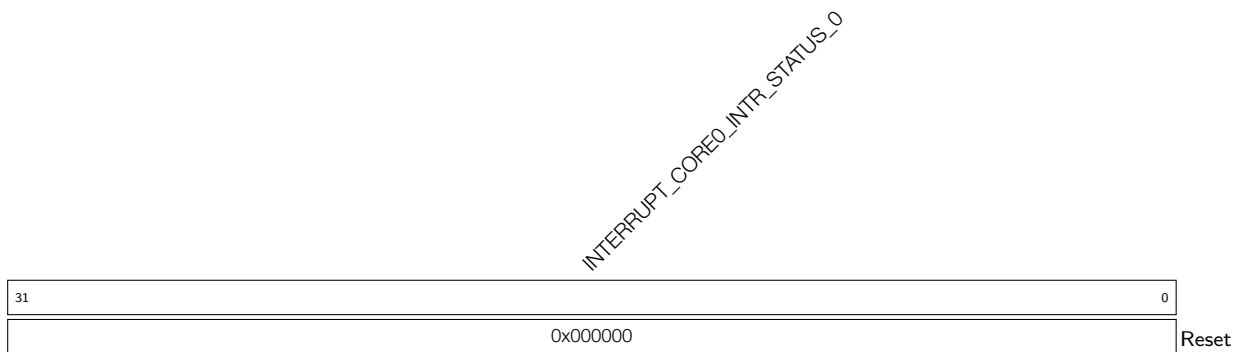

INTERRUPT_CORE0_INTR_STATUS_0 This register stores the status of the first 32 interrupt sources. (RO)

Register 9.87. INTERRUPT_CORE0_INTR_STATUS_1_REG (0x0190)

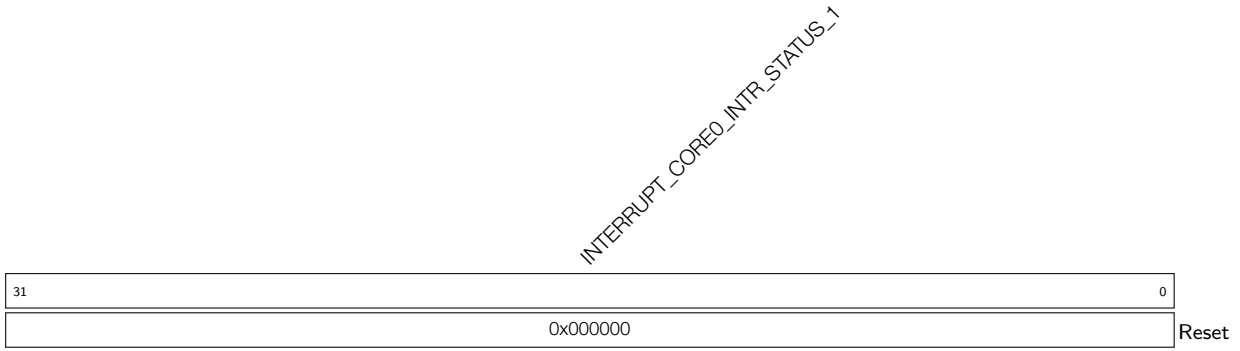

INTERRUPT_CORE0_INTR_STATUS_1 This register stores the status of the second 32 interrupt sources. (RO)

Register 9.88. INTERRUPT_CORE0_INTR_STATUS_2_REG (0x0194)

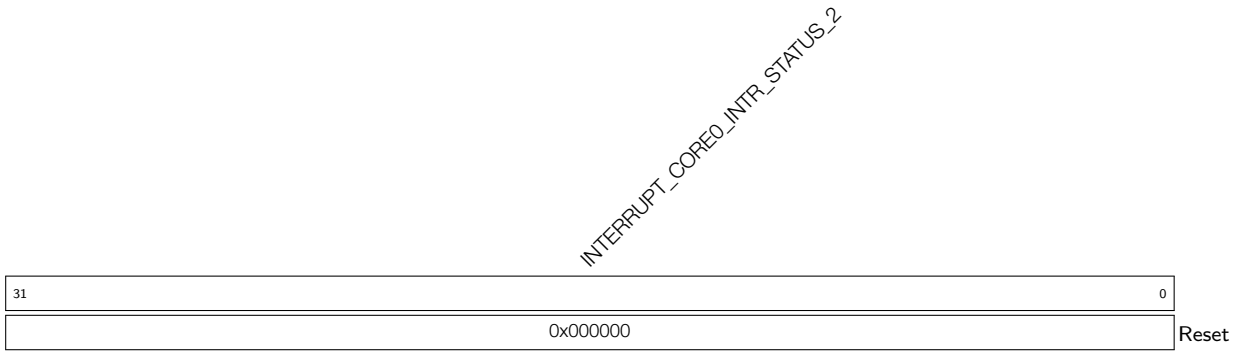

INTERRUPT_CORE0_INTR_STATUS_2 This register stores the status of the third 32 interrupt sources. (RO)

Register 9.89. INTERRUPT_CORE0_INTR_STATUS_3_REG (0x0198)

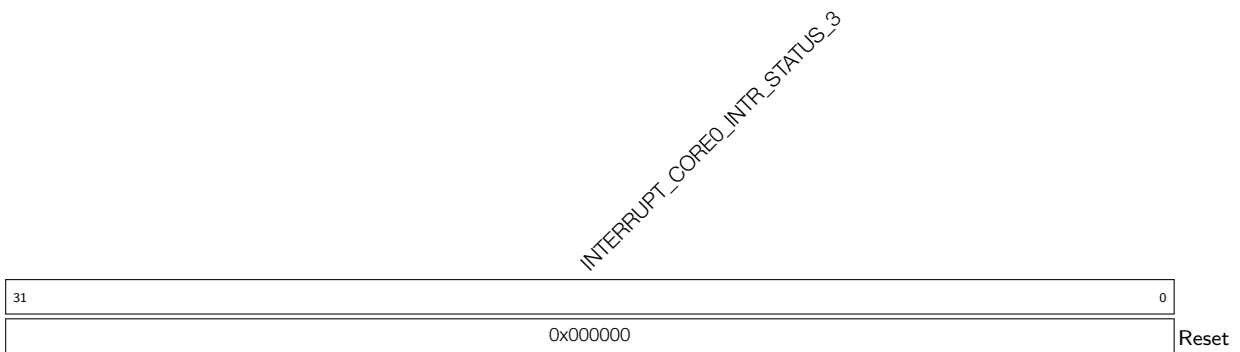

INTERRUPT_CORE0_INTR_STATUS_3 This register stores the status of the last 3 interrupt sources. (RO)

Register 9.90. INTERRUPT_CORE0_CLOCK_GATE_REG (0x019C)

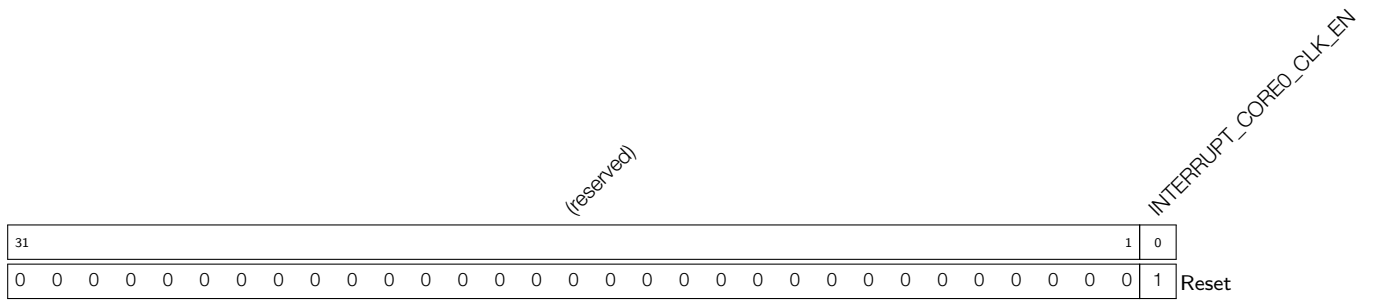

INTERRUPT_CORE0_CLK_EN This register is used to control clock-gating of interrupt matrix. (R/W)

Register 9.91. INTERRUPT_CORE0_DATE_REG (0x07FC)

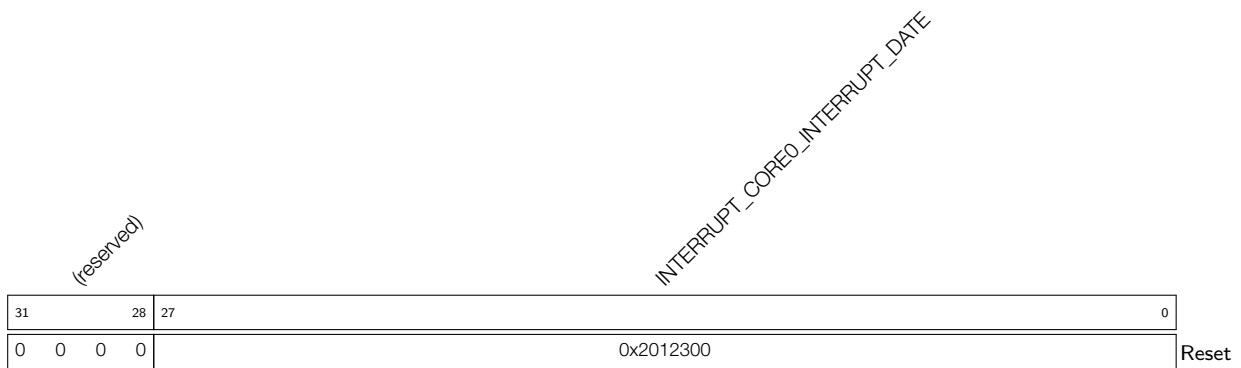

INTERRUPT_CORE0_INTERRUPT_DATE Version control register (R/W)

9.5.2 CPU1 Interrupt Registers

- Register 9.92. INTERRUPT_CORE1_MAC_INTR_MAP_REG (0x0800)
- Register 9.93. INTERRUPT_CORE1_MAC_NMI_MAP_REG (0x0804)
- Register 9.94. INTERRUPT_CORE1_PWR_INTR_MAP_REG (0x0808)
- Register 9.95. INTERRUPT_CORE1_BB_INT_MAP_REG (0x080C)
- Register 9.96. INTERRUPT_CORE1_BT_MAC_INT_MAP_REG (0x0810)
- Register 9.97. INTERRUPT_CORE1_BT_BB_INT_MAP_REG (0x0814)
- Register 9.98. INTERRUPT_CORE1_BT_BB_NMI_MAP_REG (0x0818)
- Register 9.99. INTERRUPT_CORE1_RWBT_IRQ_MAP_REG (0x081C)
- Register 9.100. INTERRUPT_CORE1_RWBLE_IRQ_MAP_REG (0x0820)
- Register 9.101. INTERRUPT_CORE1_RWBT_NMI_MAP_REG (0x0824)
- Register 9.102. INTERRUPT_CORE1_RWBLE_NMI_MAP_REG (0x0828)
- Register 9.103. INTERRUPT_CORE1_I2C_MST_INT_MAP_REG (0x082C)

- Register 9.104. INTERRUPT_CORE1_UHCIO_INTR_MAP_REG (0x0838)
- Register 9.105. INTERRUPT_CORE1_GPIO_INTERRUPT_CPU_MAP_REG (0x0840)
- Register 9.106. INTERRUPT_CORE1_GPIO_INTERRUPT_CPU_NMI_MAP_REG (0x0844)
- Register 9.107. INTERRUPT_CORE1_SPI_INTR_1_MAP_REG (0x0850)
- Register 9.108. INTERRUPT_CORE1_SPI_INTR_2_MAP_REG (0x0854)
- Register 9.109. INTERRUPT_CORE1_SPI_INTR_3_MAP_REG (0x0858)
- Register 9.110. INTERRUPT_CORE1_LCD_CAM_INT_MAP_REG (0x0860)
- Register 9.111. INTERRUPT_CORE1_I2S0_INT_MAP_REG (0x0864)
- Register 9.112. INTERRUPT_CORE1_I2S1_INT_MAP_REG (0x0868)
- Register 9.113. INTERRUPT_CORE1_UART_INTR_MAP_REG (0x086C)
- Register 9.114. INTERRUPT_CORE1_UART1_INTR_MAP_REG (0x0870)
- Register 9.115. INTERRUPT_CORE1_UART2_INTR_MAP_REG (0x0874)
- Register 9.116. INTERRUPT_CORE1_SDIO_HOST_INTERRUPT_MAP_REG (0x0878)
- Register 9.117. INTERRUPT_CORE1_PWM0_INTR_MAP_REG (0x087C)
- Register 9.118. INTERRUPT_CORE1_PWM1_INTR_MAP_REG (0x0880)
- Register 9.119. INTERRUPT_CORE1_LEDC_INT_MAP_REG (0x088C)
- Register 9.120. INTERRUPT_CORE1_EFUSE_INT_MAP_REG (0x0890)
- Register 9.121. INTERRUPT_CORE1_TWAI_INT_MAP_REG (0x0894)
- Register 9.122. INTERRUPT_CORE1_USB_INTR_MAP_REG (0x0898)
- Register 9.123. INTERRUPT_CORE1_RTC_CORE_INTR_MAP_REG (0x089C)
- Register 9.124. INTERRUPT_CORE1_RMT_INTR_MAP_REG (0x08A0)
- Register 9.125. INTERRUPT_CORE1_PCNT_INTR_MAP_REG (0x08A4)
- Register 9.126. INTERRUPT_CORE1_I2C_EXT0_INTR_MAP_REG (0x08A8)
- Register 9.127. INTERRUPT_CORE1_I2C_EXT1_INTR_MAP_REG (0x08AC)
- Register 9.128. INTERRUPT_CORE1_TG_T0_INT_MAP_REG (0x08C8)
- Register 9.129. INTERRUPT_CORE1_TG_T1_INT_MAP_REG (0x08CC)
- Register 9.130. INTERRUPT_CORE1_TG_WDT_INT_MAP_REG (0x08D0)
- Register 9.131. INTERRUPT_CORE1_TG1_T0_INT_MAP_REG (0x08D4)
- Register 9.132. INTERRUPT_CORE1_TG1_T1_INT_MAP_REG (0x08D8)
- Register 9.133. INTERRUPT_CORE1_TG1_WDT_INT_MAP_REG (0x08DC)
- Register 9.134. INTERRUPT_CORE1_CACHE_IA_INT_MAP_REG (0x08E0)
- Register 9.135. INTERRUPT_CORE1_SYSTIMER_TARGET0_INT_MAP_REG (0x08E4)
- Register 9.136. INTERRUPT_CORE1_SYSTIMER_TARGET1_INT_MAP_REG (0x08E8)
- Register 9.137. INTERRUPT_CORE1_SYSTIMER_TARGET2_INT_MAP_REG (0x08EC)
- Register 9.138. INTERRUPT_CORE1_SPI_MEM_REJECT_INTR_MAP_REG (0x08F0)

- Register 9.139. INTERRUPT_CORE1_DCACHE_PRELOAD_INT_MAP_REG (0x08F4)
- Register 9.140. INTERRUPT_CORE1_ICACHE_PRELOAD_INT_MAP_REG (0x08F8)
- Register 9.141. INTERRUPT_CORE1_DCACHE_SYNC_INT_MAP_REG (0x08FC)
- Register 9.142. INTERRUPT_CORE1_ICACHE_SYNC_INT_MAP_REG (0x0900)
- Register 9.143. INTERRUPT_CORE1_APB_ADC_INT_MAP_REG (0x0904)
- Register 9.144. INTERRUPT_CORE1_DMA_IN_CH0_INT_MAP_REG (0x0908)
- Register 9.145. INTERRUPT_CORE1_DMA_IN_CH1_INT_MAP_REG (0x090C)
- Register 9.146. INTERRUPT_CORE1_DMA_IN_CH2_INT_MAP_REG (0x0910)
- Register 9.147. INTERRUPT_CORE1_DMA_IN_CH3_INT_MAP_REG (0x0914)
- Register 9.148. INTERRUPT_CORE1_DMA_IN_CH4_INT_MAP_REG (0x0918)
- Register 9.149. INTERRUPT_CORE1_DMA_OUT_CH0_INT_MAP_REG (0x091C)
- Register 9.150. INTERRUPT_CORE1_DMA_OUT_CH1_INT_MAP_REG (0x0920)
- Register 9.151. INTERRUPT_CORE1_DMA_OUT_CH2_INT_MAP_REG (0x0924)
- Register 9.152. INTERRUPT_CORE1_DMA_OUT_CH3_INT_MAP_REG (0x0928)
- Register 9.153. INTERRUPT_CORE1_DMA_OUT_CH4_INT_MAP_REG (0x092C)
- Register 9.154. INTERRUPT_CORE1_RSA_INT_MAP_REG (0x0930)
- Register 9.155. INTERRUPT_CORE1_AES_INT_MAP_REG (0x0934)
- Register 9.156. INTERRUPT_CORE1_SHA_INT_MAP_REG (0x0938)
- Register 9.157. INTERRUPT_CORE1_CPU_INTR_FROM_CPU_0_MAP_REG (0x093C)
- Register 9.158. INTERRUPT_CORE1_CPU_INTR_FROM_CPU_1_MAP_REG (0x0940)
- Register 9.159. INTERRUPT_CORE1_CPU_INTR_FROM_CPU_2_MAP_REG (0x0944)
- Register 9.160. INTERRUPT_CORE1_CPU_INTR_FROM_CPU_3_MAP_REG (0x0948)
- Register 9.161. INTERRUPT_CORE1_ASSIST_DEBUG_INTR_MAP_REG (0x094C)
- Register 9.162. INTERRUPT_CORE1_DMA_APBPERI_PMS_MONITOR_VIOLATE_INTR_MAP_REG (0x0950)
- Register 9.163. INTERRUPT_CORE1_CORE_0_IRAM0_PMS_MONITOR_VIOLATE_INTR_MAP_REG (0x0954)
- Register 9.164. INTERRUPT_CORE1_CORE_0_DRAM0_PMS_MONITOR_VIOLATE_INTR_MAP_REG (0x0958)
- Register 9.165. INTERRUPT_CORE1_CORE_0_PIF_PMS_MONITOR_VIOLATE_INTR_MAP_REG (0x095C)
- Register 9.166. INTERRUPT_CORE1_CORE_0_PIF_PMS_MONITOR_VIOLATE_SIZE_INTR_MAP_REG (0x0960)
- Register 9.167. INTERRUPT_CORE1_CORE_1_IRAM0_PMS_MONITOR_VIOLATE_INTR_MAP_REG (0x0964)
- Register 9.168. INTERRUPT_CORE1_CORE_1_DRAM0_PMS_MONITOR_VIOLATE_INTR_MAP_REG (0x0968)
- Register 9.169. INTERRUPT_CORE1_CORE_1_PIF_PMS_MONITOR_VIOLATE_INTR_MAP_REG (0x096C)
- Register 9.170. INTERRUPT_CORE1_CORE_1_PIF_PMS_MONITOR_VIOLATE_SIZE_INTR_MAP_REG (0x0970)
- Register 9.171. INTERRUPT_CORE1_BACKUP_PMS_VIOLATE_INTR_MAP_REG (0x0974)
- Register 9.172. INTERRUPT_CORE1_CACHE_CORE0_ACS_INT_MAP_REG (0x0978)

Register 9.173. INTERRUPT_CORE1_CACHE_CORE1_ACS_INT_MAP_REG (0x097C)

Register 9.174. INTERRUPT_CORE1_USB_DEVICE_INT_MAP_REG (0x0980)

Register 9.175. INTERRUPT_CORE1_PERI_BACKUP_INT_MAP_REG (0x0984)

Register 9.176. INTERRUPT_CORE1_DMA_EXTMEM_REJECT_INT_MAP_REG (0x0988)

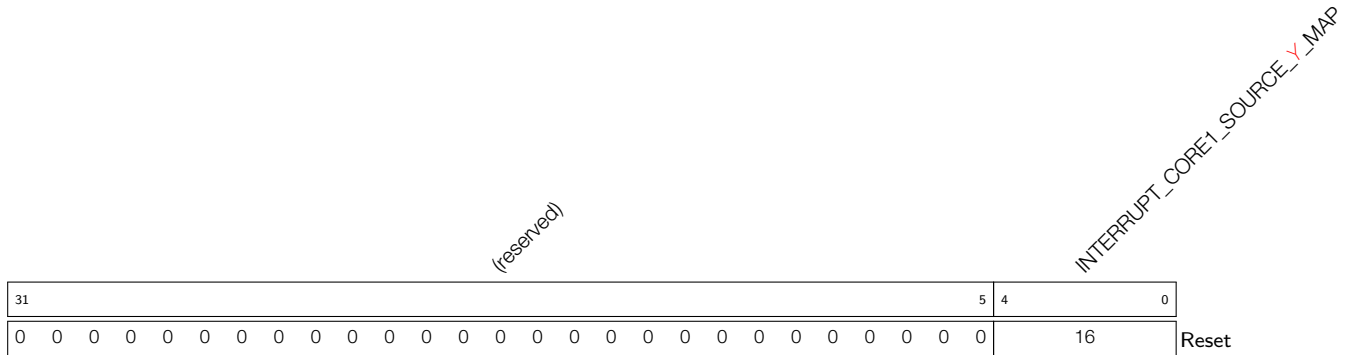

INTERRUPT_CORE1_SOURCE_Y_MAP Map interrupt signal of Source_Y to one of CPU1 external interrupt, can be configured as 0 ~ 5, 8 ~ 10, 12 ~ 14, 17 ~ 28, 30 ~ 31. The remaining values are invalid. For Source_Y, see Table 9-1. (R/W)

Register 9.177. INTERRUPT_CORE1_INTR_STATUS_0_REG (0x098C)

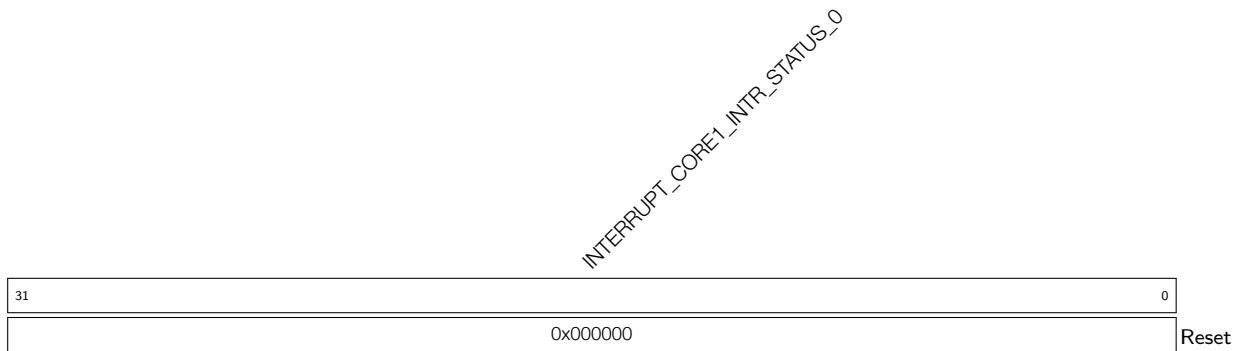

INTERRUPT_CORE1_INTR_STATUS_0 This register stores the status of the first 32 interrupt sources. (RO)

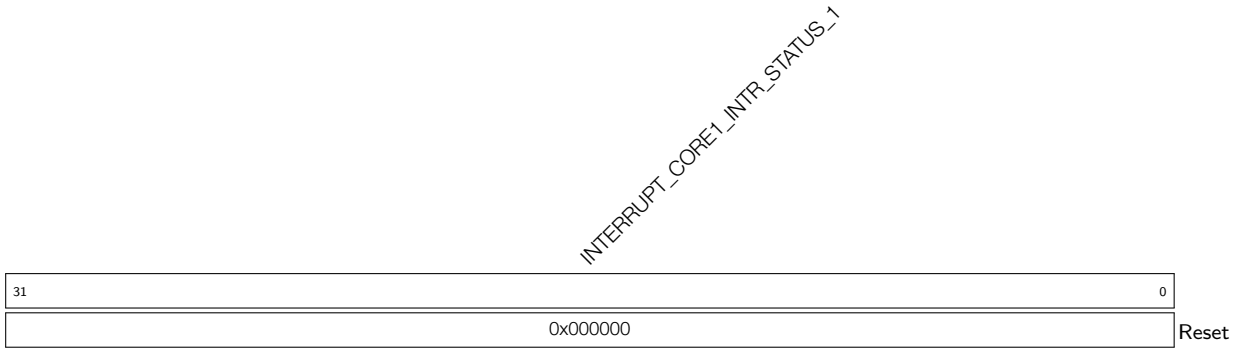
Register 9.178. INTERRUPT_CORE1_INTR_STATUS_1_REG (0x0990)

INTERRUPT_CORE1_INTR_STATUS_1 This register stores the status of the second 32 interrupt sources. (RO)

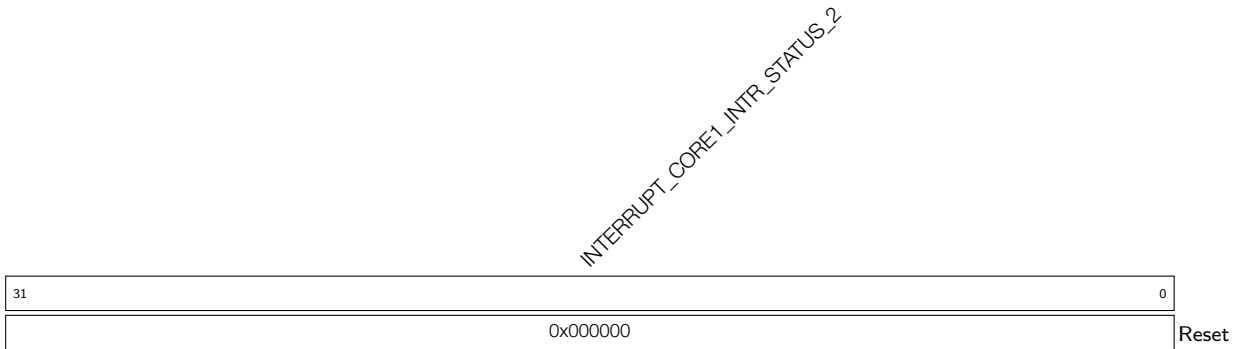
Register 9.179. INTERRUPT_CORE1_INTR_STATUS_2_REG (0x0994)

INTERRUPT_CORE1_INTR_STATUS_2 This register stores the status of the third 32 interrupt sources. (RO)

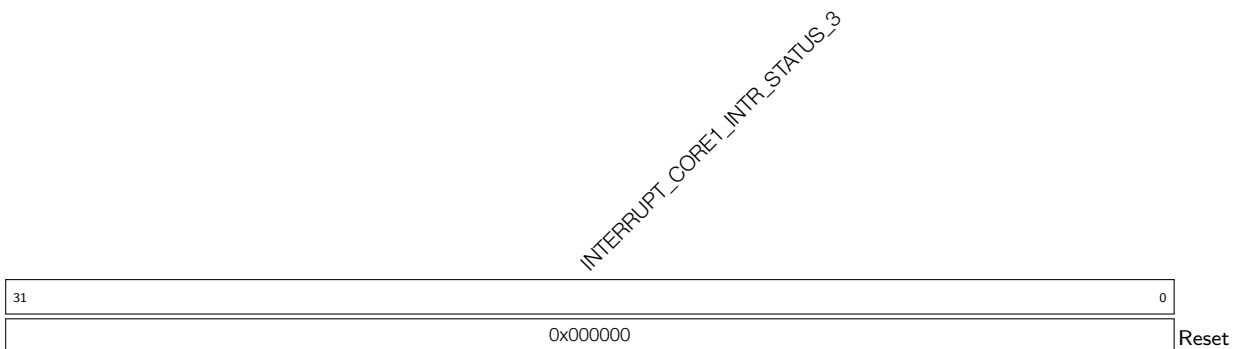
Register 9.180. INTERRUPT_CORE1_INTR_STATUS_3_REG (0x0998)

INTERRUPT_CORE1_INTR_STATUS_3 This register stores the status of the last 3 interrupt sources. (RO)

Register 9.181. INTERRUPT_CORE1_CLOCK_GATE_REG (0x099C)

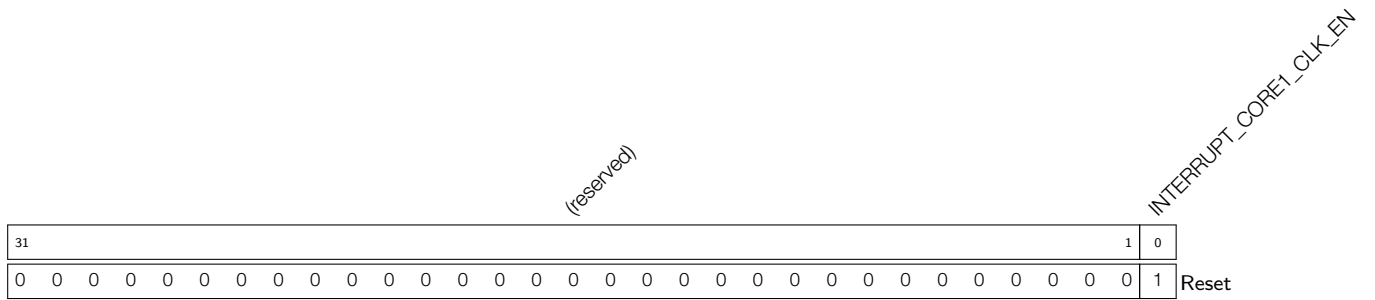

INTERRUPT_CORE1_CLK_EN This register is used to control clock-gating of interrupt matrix. (R/W)

Register 9.182. INTERRUPT_CORE1_DATE_REG (0x0FFC)

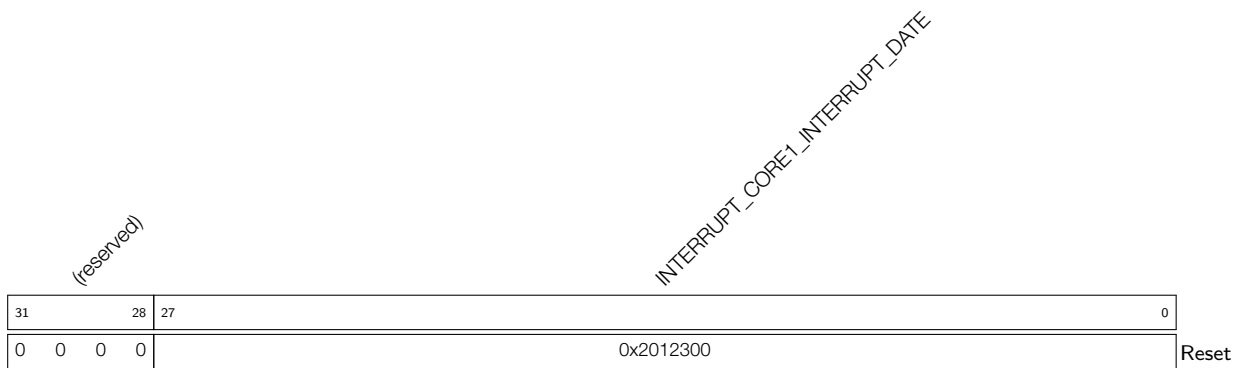

INTERRUPT_CORE1_INTERRUPT_DATE Version control register. (R/W)

10 Low-power Management (RTC_CNTL)

10.1 Introduction

ESP32-S3 has an advanced Power Management Unit (PMU), which can flexibly power up different power domains of the chip, to achieve the best balance among chip performance, power consumption, and wakeup latency. To simplify power management for typical scenarios, ESP32-S3 has predefined four power modes, which are preset configurations that power up different combinations of power domains. On top of that, the chip also allows the users to independently power up any particular power domain to meet more complex requirements. ESP32-S3 has integrated two Ultra-Low-Power coprocessors (ULP co-processors), which allow the chip to work when most of the power domains are powered down, thus achieving extremely low-power consumption.

10.2 Features

ESP32-S3's low-power management supports the following features:

- Four predefined power modes to simplify power management for typical scenarios
- Up to 16 KB of retention memory (slow memory and fast memory)
- 8 x 32-bit retention registers
- RTC Boot supported for reduced wakeup latency
- ULP co-processors supported in all power modes

In this chapter, we first introduce the working process of ESP32-S3's low-power management, then introduce the predefined power modes of the chip, and at last, introduce the RTC boot of the chip.

10.3 Functional Description

ESP32-S3's low-power management involves the following components:

- Power management unit: controls the power supply to three power domain categories
 - Real Time Controller (RTC)
 - Digital
 - Analog

For a complete list of 10 power domains grouped in these three power domain categories, see Section [10.4.1](#).

- Power isolation unit: isolates different power domains, so powered up and powered down domains do not affect each other.
- Low-power clocks: provide clocks to power domains working in low-power modes.
- Timers:
 - RTC timer: logs the status of the RTC main state machine in dedicated registers.
 - ULP timer: wakes up the ULP co-processors at a predefined time. For details, please refer to Chapter [2 ULP Coprocessor \(ULP-FSM, ULP-RISC-V\)](#).

- Touch sensor timer: wakes up the touch sensor at a predefined time. For details, please refer to Chapter 39 *On-Chip Sensors and Analog Signal Processing*.
- 8 x 32-bit “always-on” retention registers: These registers are always powered up and are not affected by any low-power modes, thus can be used for storing data that cannot be lost.
- 22 x “always-on” pins: These pins are always powered up and not affected by any low-power modes. They can be used as wakeup sources when the chip is working in the low-power modes (for details, please refer to Section 10.4.4), or can be used as regular GPIOs (for details, please refer to Chapter 6 *IO MUX and GPIO Matrix (GPIO, IO MUX)*).
- RTC slow memory: 8 KB SRAM that works under RTC fast clock (`rtc_fast_clk`), which can be used as extended memory or to store ULP co-processor directives and data.
- RTC fast memory: 8 KB SRAM that works under CPU clock (`CPU_CLK`), which can be used as extended memory.
- Voltage regulators: regulate the power supply to different power domains.

The schematic diagram of ESP32-S3’s low-power management is shown in Figure 10-1.

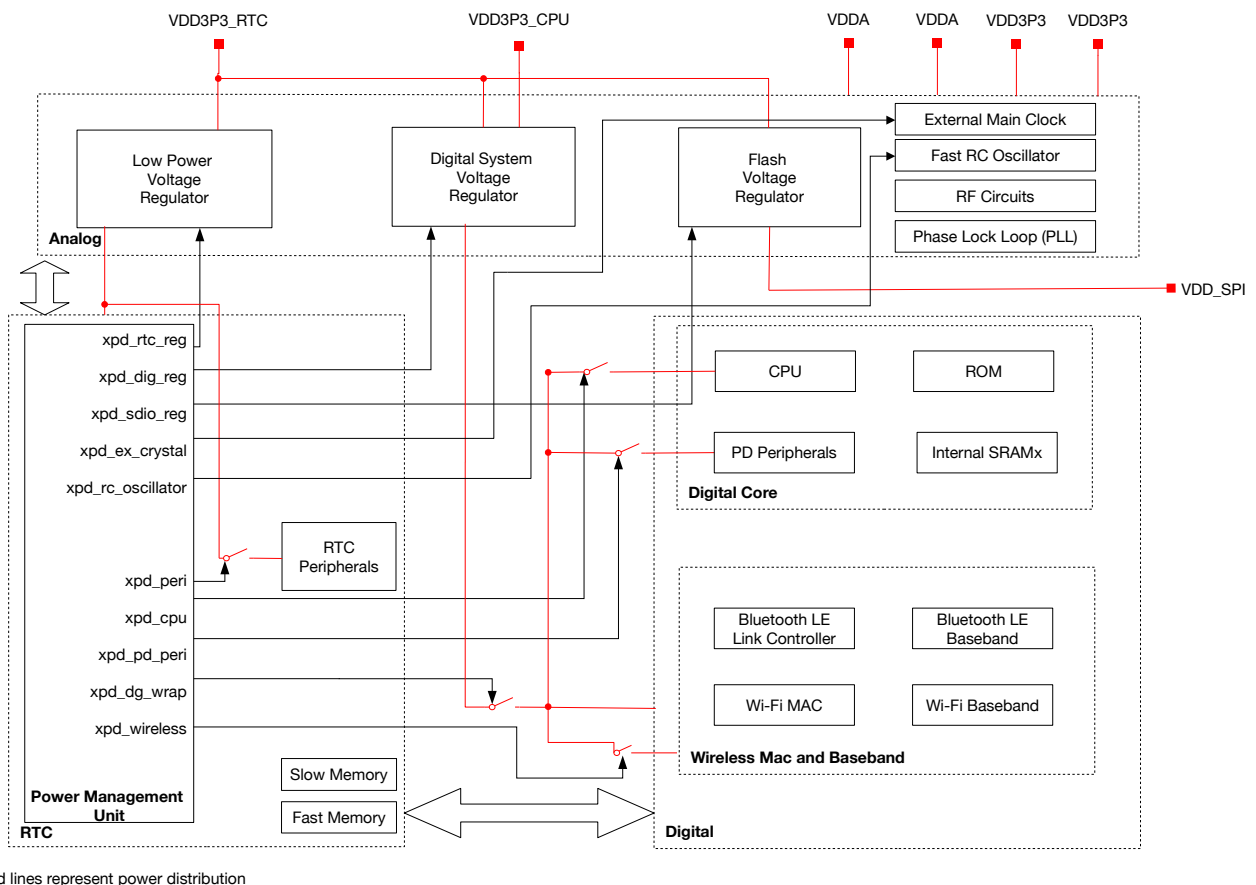

Figure 10-1. Low-power Management Schematics

Note:

- For a complete list of all power domains and power domain categories, please check Section 10.4.1.
- Signals in the above diagram are described below:
 - xpd_rtc_reg:
 - * When [RTC_CNTL_RTC_REGULATOR_FORCE_PU](#) is set to 1, low power voltage regulator is always-on;
 - * Otherwise, the low power voltage regulator is off when chip enters Light-sleep and Deep-sleep modes. In this case, the RTC domain is powered by an ultra low-power internal power source.
 - xpd_dig_reg:
 - * When [RTC_CNTL_DG_WRAP_PD_EN](#) is enabled, the digital voltage regulator is off when the chip enters Light-sleep and Deep-sleep modes;
 - * Otherwise, the digital voltage regulator is always on.
 - xpd_peri:
 - * When [RTC_CNTL_RTC_PD_EN](#) is enabled, RTC peripherals is off when chip enters Light-sleep and Deep-sleep modes;
 - * Otherwise, the RTC peripherals are always on.
 - xpd_cpu:
 - * When [RTC_CNTL_CPU_PD_EN](#) is enabled, CPU is off when chip enters Light-sleep and Deep-sleep modes;
 - * Otherwise, the CPU is always on.
 - xpd_pd_peri:
 - * When [RTC_CNTL_DG_PERI_PD_EN](#) is enabled, the PD Peripherals are off when chip enters Light-sleep and Deep-sleep modes;
 - * Otherwise, the PD peripherals are always on.
 - xpd_dg_wrap: this signal is always the same with xpd_dig_reg.
 - xpd_wireless:
 - * When [RTC_CNTL_WIFI_PD_EN](#) is enabled, the wireless circuit is off when chip enters Light-sleep and Deep-sleep modes;
 - * Otherwise, the wireless circuit is always on.
 - xpd_sdio_reg: see Section 10.3.4.3 below.
 - xpd_ex_crystal:
 - * When [RTC_CNTL_XTL_FORCE_PU](#) is set to 1, the external main crystal clock is always-on;
 - * Otherwise, the external main crystal clock is off when chip enters Light-sleep and Deep-sleep modes.
 - xpd_rc_oscillator:
 - * when [RTC_CNTL_CK8M_FORCE_PU](#) is set to 1, the fast RC oscillator is always-on;
 - * Otherwise, the fast RC oscillator is off when chip enters Light-sleep and Deep-sleep modes.
 - RF Circuits and Phase Lock Loop (PLL) are controlled by internal signals and cannot be modified by users.

10.3.1 Power Management Unit

ESP32-S3's power management unit controls the power supply to different power domains. The main components of the power management unit include:

- RTC main state machine: generates power gating, clock gating, and reset signals.
- Power controllers: power up and power down different power domains, according to the power gating signals from the main state machine.

- Sleep / wakeup controllers: send sleep or wakeup requests to the RTC main state machine.
- Clock controller: selects and powers up / down clock sources.
- Protection Timer: controls the transition interval between main state machine states.

In ESP32-S3's power management unit, the sleep / wakeup controllers send sleep or wakeup requests to the RTC main state machine, which then generates power gating, clock gating, and reset signals. Then, the power controller and clock controller power up and power down different power domains and clock sources, according to the signals generated by the RTC main state machine, so that the chip enters or exits the low-power modes. The main workflow is shown in Figure 10-2.

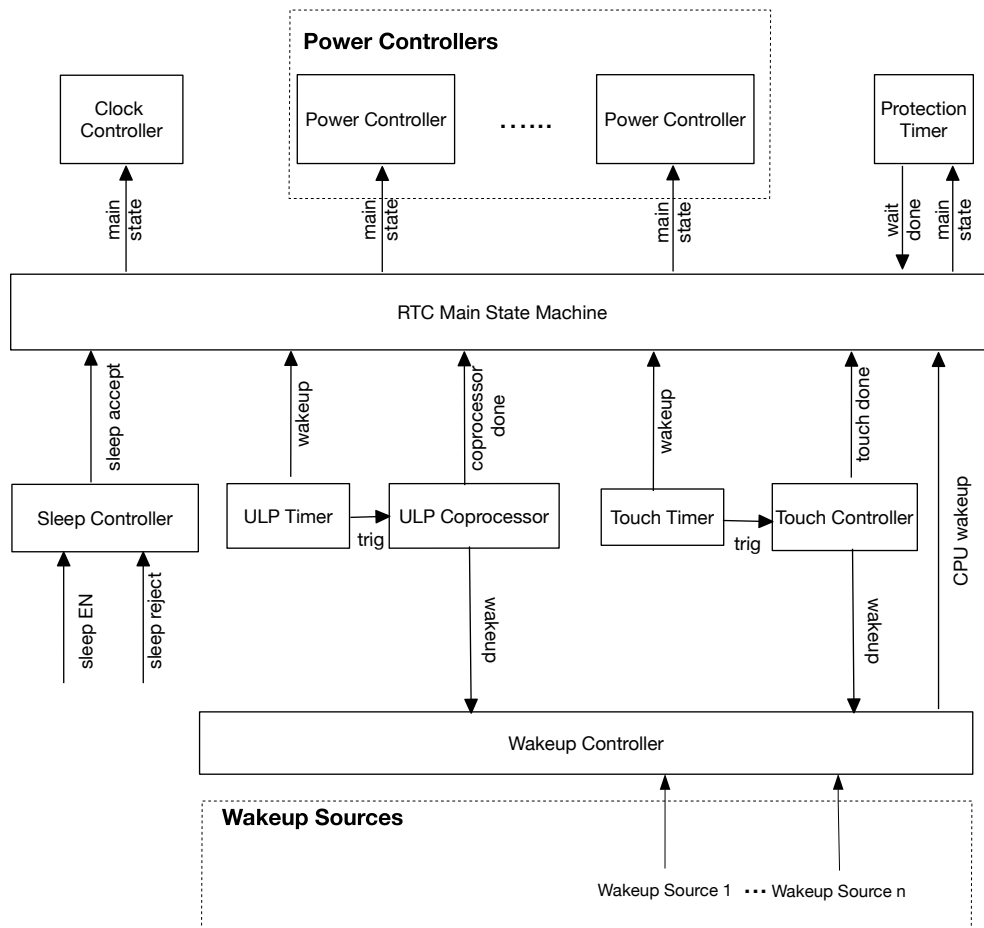

Figure 10-2. Power Management Unit Workflow

Note:

1. For a complete list of power domains, please refer to Section 10.4.1.
2. For a complete list of all the available wakeup sources, please refer to Table 10-5.

10.3.2 Low-Power Clocks

In general, ESP32-S3 powers down its external crystal XTAL_CLK and PLL to reduce power consumption when working in low-power modes. During this time, the chip's low-power clocks remain on to provide clocks to different power domains, such as the power management unit, RTC peripherals, RTC fast memory, RTC slow

memory, and wireless circuits in the digital domain.

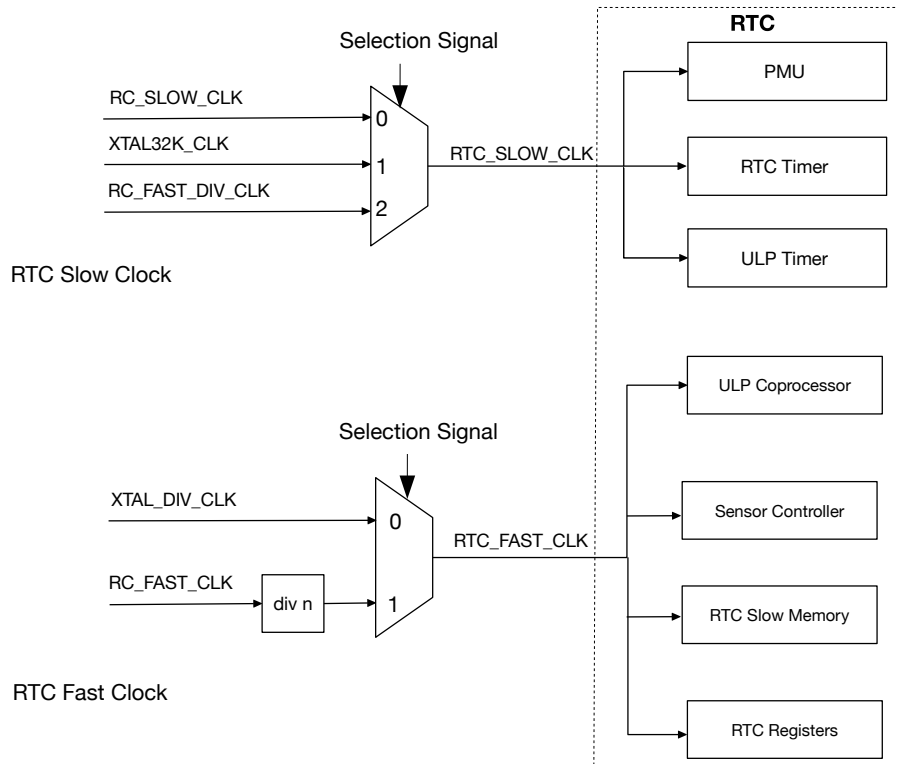

Figure 10-3. RTC Clocks

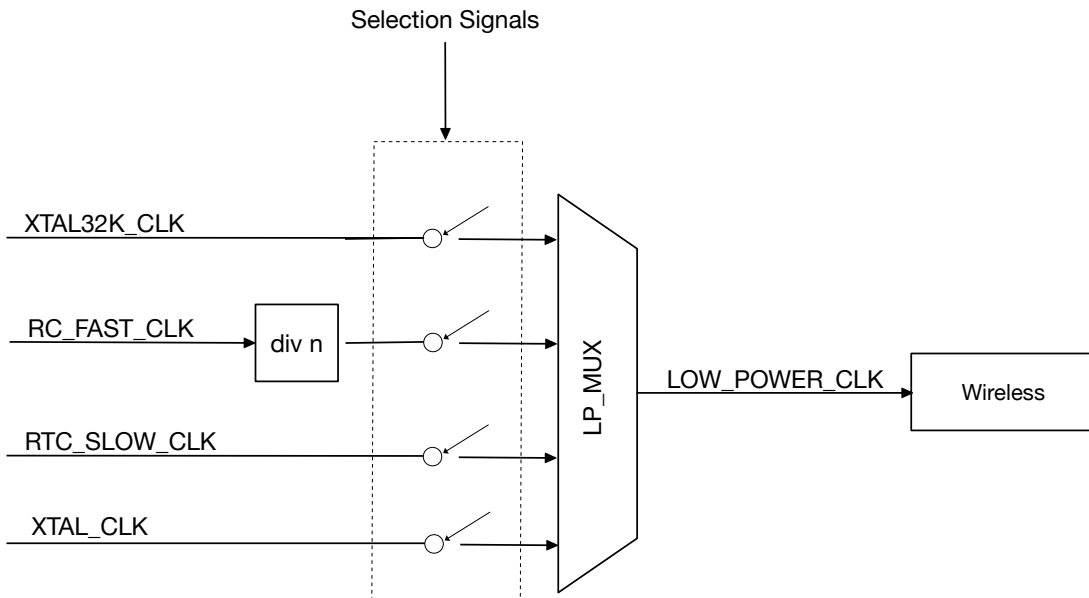

Figure 10-4. Wireless Clocks

Table 10-1. Low-Power Clocks

Clock Type	Clock Source	Selection Option	Effective for
RTC Slow Clock	XTAL32K_CLK	RTC_CNTL_ANA_CLK_RTC_SEL	Power management unit
	RC_FAST_DIV_CLK		RTC Timers
	RC_SLOW_CLK (Default)		ULP Timers
RTC Fast Clock	RC_FAST_CLK divided by n (Default)	RTC_CNTL_FAST_CLK_RTC_SEL	ULP co-processor
	XTAL_DIV_CLK		Sensor controller RTC registers RTC slow memory
Wireless Clock	XTAL32K_CLK	SYSTEM_LPCLK_SEL_XTAL32K	Wireless modules (Wi-Fi/BT) in the digital domain working in low-power modes
	RC_FAST_CLK divided by n	SYSTEM_LPCLK_SEL_8M	
	RTC_SLOW_CLK	SYSTEM_LPCLK_SEL_RTC_SLOW	
	XTAL_CLK	SYSTEM_LPCLK_SEL_XTAL	

For more detailed description about clocks, please refer to [7 Reset and Clock](#).

10.3.3 Timers

ESP32-S3's low-power management uses 3 timers:

- RTC timer
- ULP timer
- Touch timer

This section only introduces the RTC timer. For detailed description of ULP timer, please refer to Chapters [2 ULP Coprocessor \(ULP-FSM, ULP-RISC-V\)](#). For detailed description of touch timer, please refer to Chapters [39 On-Chip Sensors and Analog Signal Processing](#).

The readable 48-bit RTC timer is a real-time counter (using RTC slow clock) that can be configured to log the time when one of the following events happens. For details, see [Table 10-2](#).

Table 10-2. The Triggering Conditions for the RTC Timer

Enabling Options	Triggering Conditions
RTC_CNTL_TIMER_XTL_OFF	RTC main state machine powers down or XTAL_CLK crystal powers up.
RTC_CNTL_TIMER_SYS_STALL	CPU enters or exits the stall state. This is to ensure the SYS_TIMER is continuous in time.
RTC_CNTL_TIMER_SYS_RST	Resetting digital core completes.
RTC_REG_TIME_UPDATE	Register RTC_CNTL_RTC_TIME_UPDATE is configured by CPU (i.e. users).

The RTC timer updates two groups of registers upon any new trigger. The first group logs the time of the current trigger, and the other logs the previous trigger. Detailed information about these two register groups is shown below:

- Register group 0: logs the status of RTC timer at the current trigger.

- [RTC_CNTL_RTC_TIME_HIGH0_REG](#)
- [RTC_CNTL_RTC_TIME_LOW0_REG](#)
- Register group 1: logs the status of RTC timer at the previous trigger.
 - [RTC_CNTL_RTC_TIME_HIGH1_REG](#)
 - [RTC_CNTL_RTC_TIME_LOW1_REG](#)

On a new trigger, information on previous trigger is moved from register group 0 to register group 1 (and the original trigger logged in register group 1 is overwritten), and this new trigger is logged in register group 0. Therefore, only the last two triggers can be logged at any time.

It should be noted that any reset / sleep other than power-up reset will not stop or reset the RTC timer.

Also, the RTC timer can be used as a wakeup source. For details, see Section [10.4.4](#).

10.3.4 Voltage Regulators

ESP32-S3 has three voltage regulators to regulate the power supply to different power domains:

- Digital voltage regulator for digital power domains;
- Low-power voltage regulator for RTC power domains;
- Flash voltage regulator for the rest of power domains.

Note:

For a full list of power domains, please refer to Section [10.4.1](#).

10.3.4.1 Digital Voltage Regulator

ESP32-S3's built-in digital voltage regulator converts the external power supply (typically 3.3 V) to 1.1 V for digital power domains. This regulator is controlled by `xpd_dig_reg` (see details in Figure [10-1](#)). For the architecture of the ESP32-S3 digital voltage regulator, see Figure [10-5](#).

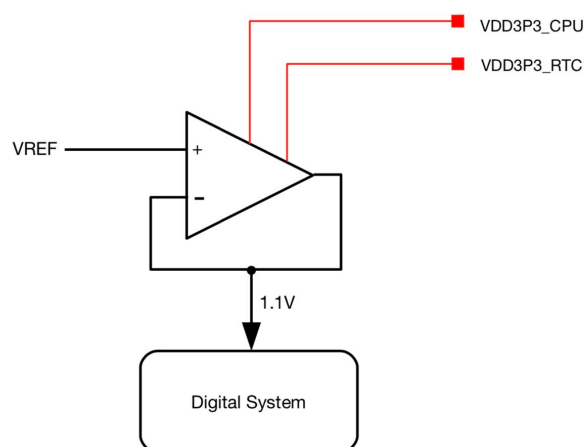

Figure 10-5. Digital Voltage Regulator

10.3.4.2 Low-power Voltage Regulator

ESP32-S3's built-in low-power voltage regulator converts the external power supply (typically 3.3 V) to 1.1 V for RTC power domains. When the pin CHIP_PU is at a high level, the RTC domain is always-on. The low power voltage regulator is off when chip enters Light-sleep and Deep-sleep modes. In this case, the RTC domain is powered by an ultra low-power built-in power supply (This power supply cannot be turned off). For the architecture of the ESP32-S3 low-power voltage regulator, see Figure 10-1.

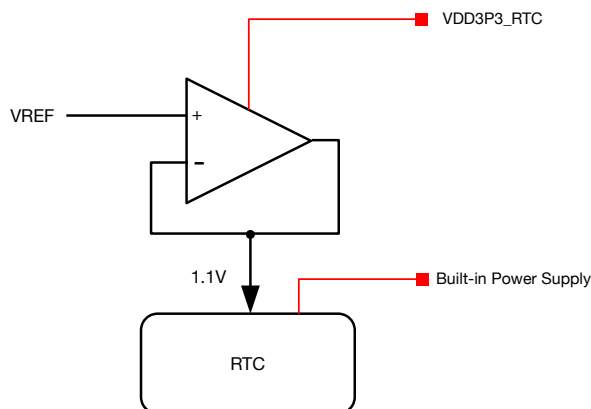

Figure 10-6. Low-power Voltage Regulator

10.3.4.3 Flash Voltage Regulator

ESP32-S3's built-in flash voltage regulator can supply a voltage of 3.3 V or 1.8 V to other components outside of digital and RTC, such as flash. For the architecture of the ESP32-S3 flash voltage regulator, see Figure 10-7.

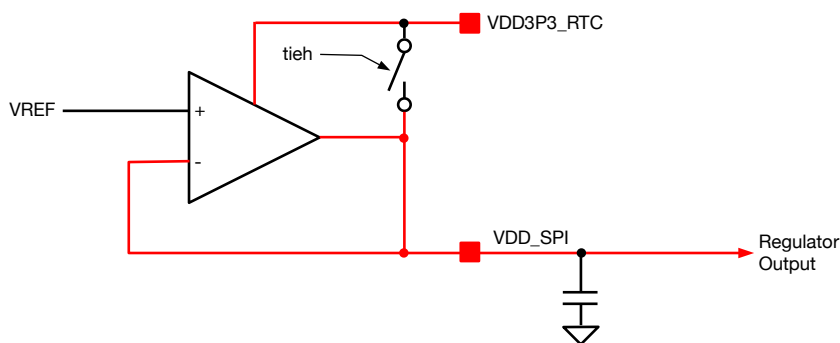

Figure 10-7. Flash Voltage Regulator

1. Configure XPD_SDIO_REG to select power source to components outside of the digital and RTC:
 - 1: the voltage regulator outputs a voltage of 3.3 V or 1.8 V;
 - 0: the voltage regulator outputs high-impedance. In this case, the voltage is provided by the external power supply.
2. Configure SDIO_TIEH to choose between 3.3 V or 1.8 V:

- 1: the voltage regulator shorts pin VDD_SPI to pin VDD3P3_RTC, and outputs a voltage of 3.3 V, which is the voltage of pin VDD3P3_RTC.
- 0: the voltage regulator outputs the reference voltage VREF, which is typically 1.8V.

The signals mentioned above can be configured as below:

- The configuration of XPD_SDIO_REG:
 - When the chip is in active mode, `RTC_CNTL_SDIO_FORCE == 0` and `EFUSE_VDD_SPI_FORCE == 1`, the XPD_SDIO_REG voltage is defined by `EFUSE_VDD_SPI_XPD`;
 - When the chip is in sleep modes and `RTC_CNTL_SDIO_REG_PD_EN == 1`, XPD_SDIO_REG is 0;
 - When `RTC_CNTL_SDIO_FORCE == 1`, XPD_SDIO_REG is defined by `RTC_CNTL_XPD_SDIO_REG`.
- The configuration of SDIO_TIEH:
 - When `RTC_CNTL_SDIO_FORCE == 0` and `EFUSE_VDD_SPI_FORCE == 1`, `SDIO_TIEH = EFUSE_VDD_SPI_TIEH`
 - Otherwise, `SDIO_TIEH = RTC_CNTL_SDIO_TIEH`.

10.3.4.4 Brownout Detector

The brownout detector checks the voltage of pins VDD3P3, VDD3P3_RTC and VDD3P3_CPU. If the voltage of these pins drops below the predefined threshold (2.7 V by default), the detector would trigger a signal to shut down some power-consuming blocks (such as LNA, PA, etc.) to allow extra time for the digital to save and transfer important data.

The brownout detector has ultra-low power consumption and remains enabled whenever the chip is powered up. For the architecture of the ESP32-S3 brownout detector, see Figure 10-8.

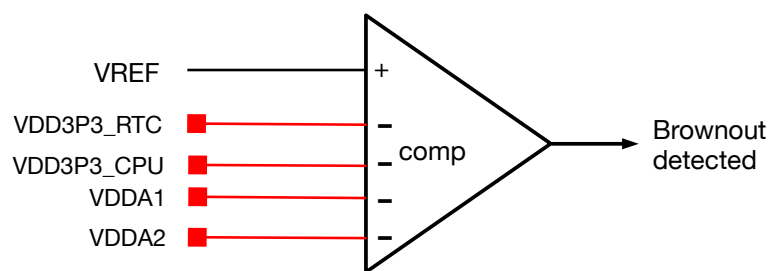

Figure 10-8. Brown-out detector

`RTC_CNTL_RTC_BROWN_OUT_DET` indicates the output level of brown-out detector. This register is low level by default, and outputs high level when the voltage of the detected pin drops below the predefined threshold.

When a brown-out signal is detected, the brownout detector can handle it in one of the two methods described below:

- mode0: triggers an interrupt when the counter counts to the thresholds pre-defined in int comparer and rst comparer, then resets the chip based on the rst_sel configuration. This method can be enabled by setting the bod_mode0_en signal.
- mode1: resets the system directly.

Workflow is illustrated in the diagram below:

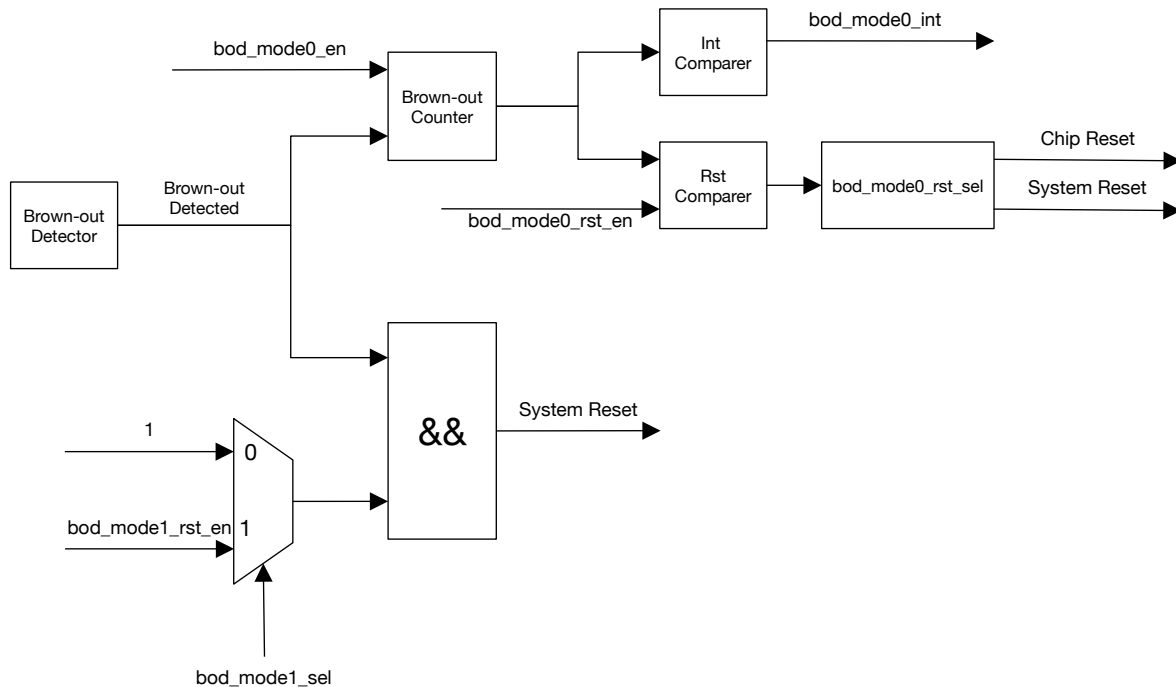

Figure 10-9. Brown-out detector

Registers for controlling related signals are described below:

- bod_mode0_en: [RTC_CNTL_BROWN_OUT_ENA](#)
- bod_mode0_rst_en: [RTC_CNTL_BROWN_OUT_RST_ENA](#)
- bod_mode0_rst_sel: [RTC_CNTL_BROWN_OUT_RST_SEL](#) configures the reset type. For more information regarding Chip Reset and System Reset, please refer to [7 Reset and Clock](#).
 - 0: resets the chip
 - 1: resets the system
- bod_mode1_sel: the first bit of [RTC_CNTL_RTC_FIB_SEL](#).
- bod_mode1_rst_en: [RTC_CNTL_BROWN_OUT_ANA_RST_EN](#)

10.4 Power Modes Management

10.4.1 Power Domain

ESP32-S3 has 10 power domains in three power domain categories:

- RTC

- Power management unit
- RTC peripherals, including RTC GPIO, RTC I2C, Temperature Sensor, Touch Sensor, RTC ADC Controller, and ULP Coprocessor
- Digital
 - Digital core
 - Wireless digital circuits
 - CPU
 - PD peripherals, including SPI2, GDMA, SHA, RSA, AES, HMAC, DS, and Secure Boot
- Analog
 - Fast RC Oscillator (RC_FAST_CLK)
 - External Main Clock (XTAL_CLK)
 - Phase Lock Loop (PLL)
 - RF circuits

10.4.2 RTC States

ESP32-S3 has three main RTC states: Active, Monitor, and Sleep. The transition process among these states can be seen in Figure 10-10.

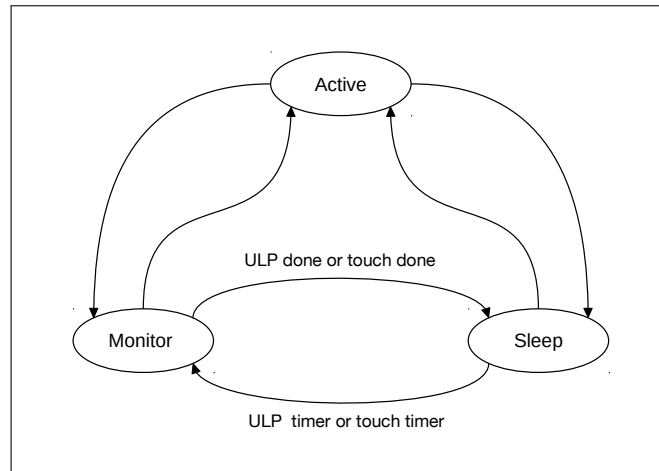

Figure 10-10. RTC States

Under different RTC states, different power domains are powered up or down by default, but can also be force-powered-up (FPU) or force-powered-down (FPD) individually based on actual requirements. For details, please refer to Table 10-3.

Table 10-3. RTC Statuses Transition

Power Domain		RTC Status		
Category	Sub-category	Active	Monitor	Sleep
RTC ^{1,2}	Power Management Unit ³	ON	ON	ON
	RTC Peripherals ⁴	ON	ON	OFF
Digital	CPU ⁵	ON	OFF*	OFF*
	Wireless digital circuits ⁶	ON	OFF*	OFF*
	Digital Core ⁷	ON	OFF*	OFF
	PD Peripherals	ON	OFF*	OFF*
Analog	RC_FAST_CLK	ON	ON	OFF
	XTAL_CLK	ON	OFF	OFF
	PLL	ON	OFF	OFF
	RF Circuits	-	-	-

* Configurable.

¹ RTC slow memory supports 8 KB SRAM, which can be used to reserve memory or to store ULP instructions and / or data. This memory (starting address is 0x5000_0000) can be accessed by CPU via PIF bus, and should be force-power-on. RTC slow memory is always OFF under the RTC state of Monitor with only one exception when the ULP coprocessor is working.

² RTC fast memory supports 8 KB SRAM, which can be used to reserve memory. This memory can be accessed by CPU via IRAM0 / DRAM0, and should be forced-power-up.

³ ESP32-S3's power management unit is specially designed to be "always-on", which means it is always on when the chip is powered up. Therefore, users cannot FPU or FPD the power management unit.

⁴ The RTC peripherals include [2 ULP Coprocessor \(ULP-FSM, ULP-RISC-V\)](#) and [39 On-Chip Sensors and Analog Signal Processing](#) (i.e. temperature sensor controller and SAR ADC controller).

⁵ CPU can be powered down separately in light-sleep, but retention DMA is required to resume CPU.

⁶ Power domain Wireless digital circuits includes Wi-Fi MAC, BT and BB (Base Band).

⁷ When the digital core of the digital is powered down, all components in the digital are turned off. It's worth noting that, ESP32-S3's ROM and SRAM are no longer controlled as independent power domains, thus cannot be force-powered-up or force-powered-down when the digital core is powered down.

10.4.3 Pre-defined Power Modes

As mentioned earlier, ESP32-S3 has four power modes, which are predefined configurations that power up different combinations of power domains. For details, please refer to Table 10-4.

Table 10-4. Predefined Power Modes

Power Mode	Power Domain									
	PMU	RTC Peripherals	Digital System	CPU	PD Peripherals	Wireless Digital Circuits	FOSC _CLK	XTAL _CLK	PLL	RF Circuits
Active	ON	ON	ON	ON	ON	ON	ON	ON	ON	ON
Modem-sleep	ON	ON	ON	ON	ON	ON*	ON	ON	ON	OFF
Light-sleep	ON	ON	ON	OFF	ON	OFF*	OFF	OFF	OFF	OFF
Deep-sleep	ON	ON	OFF	OFF	ON	OFF	OFF	OFF	OFF	OFF

* Configurable.

By default, ESP32-S3 first enters the Active mode after system resets, then enters different low-power modes (including Modem-sleep, Light-sleep, and Deep-sleep) to save power after the CPU stalls for a specific time (For example, when CPU is waiting to be wakened up by an external event). From modes Active to Deep-sleep, the number of available functionalities¹ and power consumption² decreases and wakeup latency increases. Also, the supported wakeup sources for different power modes are different³. Users can choose a power mode based on their requirements of performance, power consumption, wakeup latency, and available wakeup sources.

Note:

1. For details, please refer to Table 10-4.
2. For details on power consumption, please refer to the Current Consumption Characteristics in [ESP32-S3 Datasheet](#).
3. For details on the supported wakeup sources, please refer to Section 10.4.4.

10.4.4 Wakeup Source

The ESP32-S3 supports various wakeup sources, which could wake up the CPU in different sleep modes. The wakeup source is determined by `RTC_CNTL_RTC_WAKEUP_ENA` as shown in Table 10-5.

Table 10-5. Wakeup Source

WAKEUP_ENA	Wakeup Source ¹⁰	Light-sleep	Deep-sleep	Note
0x1	EXT0	Y	Y	1
0x2	EXT1	Y	Y	2
0x4	GPIO	Y	Y	3
0x8	RTC timer	Y	Y	-
0x20	Wi-Fi	Y	-	4
0x40	UART0	Y	-	5
0x80	UART1	Y	-	5
0x100	TOUCH Active	Y	-	6
0x200	ULP-FSM	Y	Y	7
0x400	BT	Y	-	4
0x800	ULP-RISC-V	Y	Y	
0x1000	XTAL_32K	Y	Y	8
0x2000	ULP-RISC-V Trap	Y	Y	9
0x8000	TOUCH Timeout	Y	Y	-
0xc000	BROWNOUT	Y	Y	-

Note:

- EXT0 can only wake up the chip from Light-sleep / Deep-sleep modes. If `RTC_CNTL_EXT_WAKEUP0_LV` is 1, it's triggered when the pin level is high. Otherwise, it's triggered when the pin level is low. Users can configure `RTCIO_EXT_WAKEUP0_SEL` to select an RTC pin as a wakeup source.
- EXT1 is especially designed to wake up the chip from any sleep modes, and can be triggered by a combination of pins. Users should define the combination of wakeup sources by configuring `RTC_CNTL_EXT_WAKEUP1_SEL[17:0]` according to the bitmap of selected wakeup source. When `RTC_CNTL_EXT_WAKEUP1_LV == 1`, the chip is waken up if any pin in the combination is high level. When `RTC_CNTL_EXT_WAKEUP1_LV == 0`, the chip is only waken up if all pins in the combination is low level.
- In Deep-sleep mode, only the RTC GPIOs (not regular GPIOs) can work as a wakeup source.
- To wake up the chip with a Wi-Fi or BT source, the chip switches between the Active, Modem-sleep, and Light-sleep modes. The CPU and radio are woken up at predetermined intervals to keep Wi-Fi / BT connections active.
- A wakeup is triggered when the number of RX pulses received exceeds the setting in the threshold register.
- A wakeup is triggered when any touch event is detected by the touch sensor.
- A wakeup is triggered when `RTC_CNTL_RTC_SW_CPU_INT` is configured by the ULP co-processor.
- When the 32 kHz crystal is working as RTC slow clock, a wakeup is triggered upon any detection of any crystal stops by the 32 kHz watchdog timer.
- A wakeup is triggered when the ULP co-processor starts capturing exceptions (e.g., stack overflow).
- All wakeup sources can also be configured as the causes to reject sleep, except UART.

10.4.5 Reject Sleep

ESP32-S3 implements a hardware mechanism that equips the chip with the ability to reject to sleep, which prevents the chip from going to sleep unexpectedly when some peripherals are still working but not detected by

the CPU, thus guaranteeing the proper functioning of the peripherals.

All the wakeup sources specified in Table 10-5 (except UART) can also be configured as the causes to reject sleep.

Users can configure the reject to sleep option via the following registers.

- Configure the [RTC_CNTL_RTC_SLEEP_REJECT_ENA](#) field to enable or disable the option to reject to sleep:
 - Set [RTC_CNTL_LIGHT_SLP_REJECT_EN](#) to enable reject-to-light-sleep.
 - Set [RTC_CNTL_DEEP_SLP_REJECT_EN](#) to enable reject-to-deep-sleep.
- Read [RTC_CNTL_SLP_REJECT_CAUSE_REG](#) to check the reason for rejecting to sleep.

10.5 Retention DMA

ESP32-S3 can power off the CPU in the Light-sleep mode to further reduce the power consumption. To facilitate the CPU to wake up from Light-sleep and resume execution from the previous breakpoint, ESP32-S3 introduced a retention DMA.

ESP32-S3's retention DMA stores CPU information to the Internal SRAM Block2 to Block8 before CPU enters into sleep, and restore such information from Internal SRAM to CPU after CPU wakes up from sleep, thus enabling the CPU to resume execution from the previous breakpoint.

ESP32-S3's Retention DMA:

- Retention DMA operates on data of 128 bits, and only supports address alignment of four words.
- Retention DMA's link list is specifically designed that it can be used to execute both write and read transactions. The configuration of Retention DMA is similar to that of GDMA:
 1. First allocate enough memory in SRAM before CPU enters sleep to store 432 words*: CPU registers (428 words) and configuration information (4 words).
 2. Then configure the link list according to the memory allocated in the first step. See details in Chapter 3 [GDMA Controller \(GDMA\)](#).

Note:

* Note that if the memory allocated is smaller than 432 words, then chip can only enter the Light-sleep mode and cannot further power down CPU.

After configuration, users can enable the Retention function by configuring the [RTC_CNTL_RETENTION_EN](#) field in Register [RTC_CNTL_RETENTION_CTRL_REG](#) to:

- Use Retention DMA to store CPU information before the chip enters sleep
- Restore information from Retention DMA to CPU after CPU wakes up.

10.6 RTC Boot

The wakeup time from Deep-sleep mode is much longer, compared to Light-sleep and Modem-sleep modes, because the ROMs and RAMs are both powered down in this case, and the CPU needs more time for SPI booting (data-copying from the flash). However, it's worth noting that both RTC fast memory and RTC slow memory remain powered up in the Deep-sleep mode. Therefore, users can store codes (so called “deep sleep wake stub” of up to 8 KB) either in RTC fast memory or RTC slow memory, which doesn't require the above-mentioned SPI booting, thus speeding up the wakeup process.

Method one: Boot using RTC slow memory

1. Set [RTC_CNTL_PROCPU_STAT_VECTOR_SEL](#) to 0.
2. Send the chip into sleep.
3. After the CPU is powered up, the reset vector starts resetting from 0x50000000 instead of 0x40000400, which does not involve any SPI booting. The codes stored in RTC slow memory starts running immediately after the CPU reset. The code stored in the RTC slow memory only needs to be partially initialized in a C environment.

Method two: Boot using RTC fast memory

1. Set [RTC_CNTL_PROCPU_STAT_VECTOR_SEL](#) to 1.
2. Calculate CRC for the RTC fast memory, and save the result in [RTC_CNTL_RTC_STORE7_REG\[31:0\]](#).
3. Set [RTC_CNTL_RTC_STORE6_REG\[31:0\]](#) to the entry address of RTC fast memory.
4. Send the chip into sleep.
5. ROM unpacking and some of the initialization starts after the CPU is powered up. After that, the CRC for the RTC fast memory will be calculated again. If the result matches with register [RTC_CNTL_RTC_STORE7_REG\[31:0\]](#), the CPU jumps to the entry address.

The boot flow is shown in Figure 10-11.

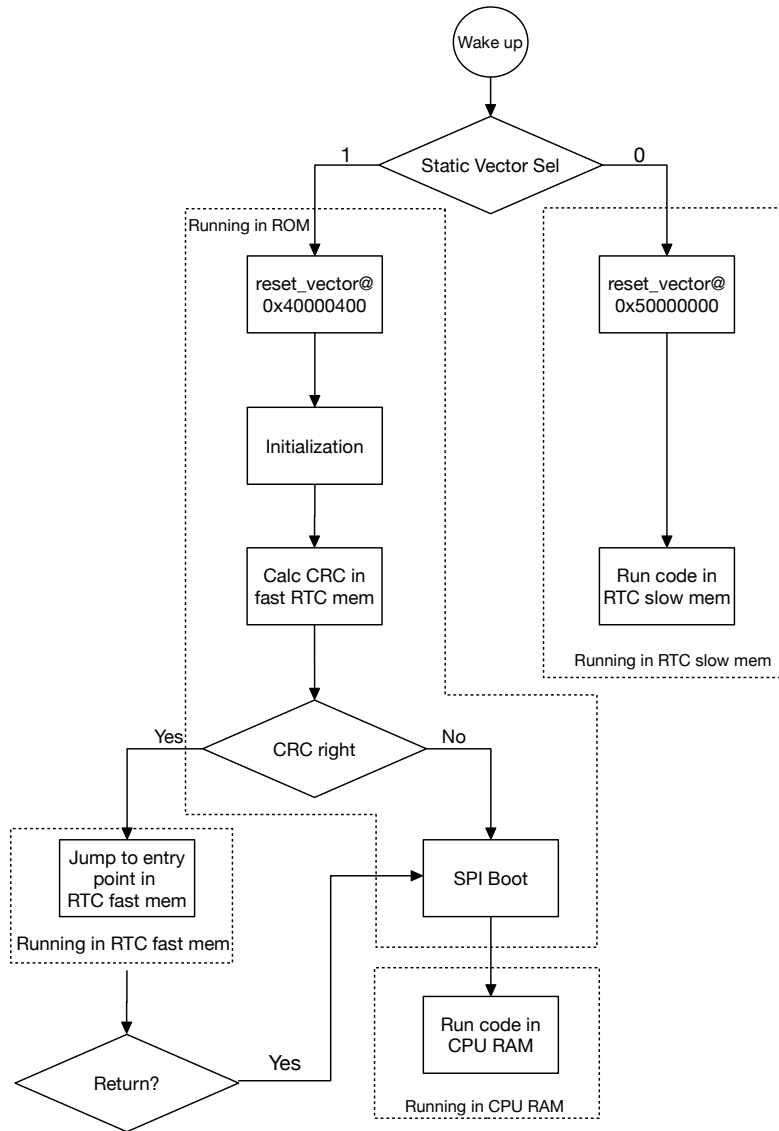

Figure 10-11. ESP32-S3 Boot Flow

10.7 Register Summary

The addresses in this section are relative to low-power management base address provided in Table 4-3 in Chapter 4 *System and Memory*.

The abbreviations given in Column **Access** are explained in Section [Access Types for Registers](#).

Name	Description	Address	Access
Control / Configuration Registers			
RTC_CNTL_RTC_OPTIONS0_REG	Sets the power options of crystal and PLL clocks, and initiates reset by software	0x0000	varies
RTC_CNTL_RTC_SLP_TIMER0_REG	RTC timer threshold register 0	0x0004	R/W
RTC_CNTL_RTC_SLP_TIMER1_REG	RTC timer threshold register 1	0x0008	varies
RTC_CNTL_RTC_TIME_UPDATE_REG	RTC timer update control register	0x000C	varies
RTC_CNTL_RTC_STATE0_REG	Configures the sleep / reject / wakeup state	0x0018	varies
RTC_CNTL_RTC_TIMER1_REG	Configures CPU stall options	0x001C	R/W
RTC_CNTL_RTC_TIMER2_REG	Configures RTC slow clock and touch controller	0x0020	R/W
RTC_CNTL_RTC_TIMER5_REG	Configures the minimal sleep cycles	0x002C	R/W
RTC_CNTL_RTC_ANA_CONF_REG	Configures the power options for I2C and PLLA	0x0034	R/W
RTC_CNTL_RTC_WAKEUP_STATE_REG	Wakeup bitmap enabling register	0x003C	R/W
RTC_CNTL_RTC_EXT_XTL_CONF_REG	32 kHz crystal oscillator configuration register	0x0060	varies
RTC_CNTL_RTC_EXT_WAKEUP_CONF_REG	GPIO wakeup configuration register	0x0064	R/W
RTC_CNTL_RTC_SLP_REJECT_CONF_REG	Configures sleep / reject options	0x0068	R/W
RTC_CNTL_RTC_CLK_CONF_REG	RTC clock configuration register	0x0074	R/W
RTC_CNTL_RTC_SLOW_CLK_CONF_REG	RTC slow clock configuration register	0x0078	R/W
RTC_CNTL_RTC_SDIO_CONF_REG	configure flash power	0x007C	varies
RTC_CNTL_RTC_REG	RTC/DIG regulator configuration register	0x0084	R/W
RTC_CNTL_RTC_PWC_REG	RTC power configuration register	0x0088	R/W
RTC_CNTL_DIG_PWC_REG	Digital system power configuration register	0x0090	R/W
RTC_CNTL_DIG_ISO_REG	Digital system ISO configuration register	0x0094	varies
RTC_CNTL_RTC_WDTCONFIG0_REG	RTC watchdog configuration register	0x0098	R/W
RTC_CNTL_RTC_WDTCONFIG1_REG	Configures the hold time of RTC watchdog at level 1	0x009C	R/W
RTC_CNTL_RTC_WDTCONFIG2_REG	Configures the hold time of RTC watchdog at level 2	0x00A0	R/W
RTC_CNTL_RTC_WDTCONFIG3_REG	Configures the hold time of RTC watchdog at level 3	0x00A4	R/W
RTC_CNTL_RTC_WDTCONFIG4_REG	Configures the hold time of RTC watchdog at level 4	0x00A8	R/W
RTC_CNTL_RTC_WDTFEED_REG	RTC watchdog SW feed configuration register	0x00AC	WO
RTC_CNTL_RTC_WDTWPROTECT_REG	RTC watchdog write protection configuration register	0x00B0	R/W

Name	Description	Address	Access
RTC_CNTL_RTC_SWD_CONF_REG	Super watchdog configuration register	0x00B4	varies
RTC_CNTL_RTC_SWD_WPROTECT_REG	Super watchdog write protection configuration register	0x00B8	R/W
RTC_CNTL_RTC_SW_CPU_STALL_REG	CPU stall configuration register	0x00BC	R/W
RTC_CNTL_RTC_LOW_POWER_ST_REG	Indicates the RTC is ready to be triggered by any wakeup source	0x00D0	RO
RTC_CNTL_RTC_PAD_HOLD_REG	Configures the hold options for RTC GPIOs	0x00D8	R/W
RTC_CNTL_DIG_PAD_HOLD_REG	Configures the hold option for digital GPIOs	0x00DC	R/W
RTC_CNTL_RTC_EXT_WAKEUP1_REG	EXT1 wakeup configuration register	0x00E0	varies
RTC_CNTL_RTC_BROWN_OUT_REG	Brownout configuration register	0x00E8	varies
RTC_CNTL_RTC_XTAL32K_CLK_FACTOR_REG	Configures the divider factor for the backup clock of 32 kHz crystal oscillator	0x00F4	R/W
RTC_CNTL_RTC_XTAL32K_CONF_REG	32 kHz crystal oscillator configuration register	0x00F8	R/W
RTC_CNTL_RTC_USB_CONF_REG	USB configuration register	0x0120	R/W
RTC_CNTL_RTC_OPTION1_REG	RTC option register	0x012C	R/W
RTC_CNTL_INT_ENA_RTC_W1TS_REG	RTC interrupt enabling register (W1TS)	0x0138	WO
RTC_CNTL_INT_ENA_RTC_W1TC_REG	RTC interrupt clear register (W1TC)	0x013C	WO
RTC_CNTL_RETENTION_CTRL_REG	Retention Configuration Register	0x0140	R/W
RTC_CNTL_RTC_FIB_SEL_REG	Brownout detector configuration register	0x0148	R/W
Status Registers			
RTC_CNTL_RTC_TIME_LOW0_REG	Stores the lower 32 bits of RTC timer 0	0x0010	RO
RTC_CNTL_RTC_TIME_HIGH0_REG	Stores the higher 16 bits of RTC timer 0	0x0014	RO
RTC_CNTL_RTC_RESET_STATE_REG	Indicates the CPU reset source	0x0038	varies
RTC_CNTL_RTC_STORE0_REG	Retention register	0x0050	R/W
RTC_CNTL_RTC_STORE1_REG	Retention register	0x0054	R/W
RTC_CNTL_RTC_STORE2_REG	Retention register	0x0058	R/W
RTC_CNTL_RTC_STORE3_REG	Retention register	0x005C	R/W
RTC_CNTL_RTC_STORE4_REG	Retention register 4	0x00C0	R/W
RTC_CNTL_RTC_STORE5_REG	Retention register 5	0x00C4	R/W
RTC_CNTL_RTC_STORE6_REG	Retention register 6	0x00C8	R/W
RTC_CNTL_RTC_STORE7_REG	Retention register 7	0x00CC	R/W
RTC_CNTL_RTC_EXT_WAKEUP1_STATUS_REG	EXT1 wakeup source register	0x00E4	RO
RTC_CNTL_RTC_TIME_LOW1_REG	Stores the lower 32 bits of RTC timer 1	0x00EC	RO
RTC_CNTL_RTC_TIME_HIGH1_REG	Stores the higher 16 bits of RTC timer 1	0x00F0	RO
RTC_CNTL_RTC_SLP_REJECT_CAUSE_REG	Stores the reject-to-sleep cause	0x0128	RO
RTC_CNTL_RTC_SLP_WAKEUP_CAUSE_REG	Stores the sleep-to-wakeup cause	0x0130	RO
Interrupt Registers			
RTC_CNTL_INT_ENA_RTC_REG	RTC interrupt enabling register	0x0040	R/W
RTC_CNTL_INT_RAW_RTC_REG	RTC interrupt raw register	0x0044	varies
RTC_CNTL_INT_ST_RTC_REG	RTC interrupt state register	0x0048	RO
RTC_CNTL_INT_CLR_RTC_REG	RTC interrupt clear register	0x004C	WO

10.8 Registers

The addresses in this section are relative to low-power management base address provided in Table 4-3 in Chapter 4 *System and Memory*.

Register 10.1. RTC_CNTL_RTC_OPTIONS0_REG (0x0000)

RTC_CNTL_SW_SYS_RST				(reserved)				RTC_CNTL_XTL_FORCE_PU				Reset						
RTC_CNTL_DG_WRAP_FORCE_NORST								RTC_CNTL_XTL_FORCE_PD										
RTC_CNTL_DG_WRAP_FORCE_RST								RTC_CNTL_BBPLL_FORCE_PD										
31	30	29	28	14	13	12	11	10	9	8	7	6	5	4	3	2	1	0
0	0	0	0	0	0	0	0	0	0	0	0	0	0	0	0	0	0	0

RTC_CNTL_SW_STALL_APPCPU_C0 When [RTC_CNTL_SW_STALL_APPCPU_C1](#) is configured to 0x21, setting this field to 0x2 stalls the CPU1 by SW. (R/W)

RTC_CNTL_SW_STALL_PROCPU_C0 When [RTC_CNTL_SW_STALL_PROCPU_C1](#) is configured to 0x21, setting this field to 0x2 stalls the CPU0 by SW. (R/W)

RTC_CNTL_SW_APPCPU_RST Set this bit to reset the CPU1 by SW. (WO)

RTC_CNTL_SW_PROCPU_RST Set this bit to reset the CPU0 by SW. (WO)

RTC_CNTL_BB_I2C_FORCE_PD Set this bit to FPD BB_I2C. (R/W)

RTC_CNTL_BB_I2C_FORCE_PU Set this bit to FPU BB_I2C. (R/W)

RTC_CNTL_BBPLL_I2C_FORCE_PD Set this bit to FPD BB_PLL_I2C. (R/W)

RTC_CNTL_BBPLL_I2C_FORCE_PU Set this bit to FPU BB_PLL_I2C. (R/W)

RTC_CNTL_BBPLL_FORCE_PD Set this bit to FPD BB_PLL. (R/W)

RTC_CNTL_BBPLL_FORCE_PU Set this bit to FPU BB_PLL. (R/W)

Continued on the next page...

Register 10.1. RTC_CNTL_RTC_OPTIONS0_REG (0x0000)

Continued from the previous page...

RTC_CNTL_XTL_FORCE_PD Set this bit to FPD the crystal oscillator. (R/W)

RTC_CNTL_XTL_FORCE_PU Set this bit to FPU the crystal oscillator. (R/W)

RTC_CNTL_DG_WRAP_FORCE_RST Set this bit to force reset the digital system in deep-sleep. (R/W)

RTC_CNTL_DG_WRAP_FORCE_NORST Set this bit to disable force reset to digital system in deep-sleep. (R/W)

RTC_CNTL_SW_SYS_RST Set this bit to reset the system via SW. (WO)

Register 10.2. RTC_CNTL_RTC_SLP_TIMER0_REG (0x0004)

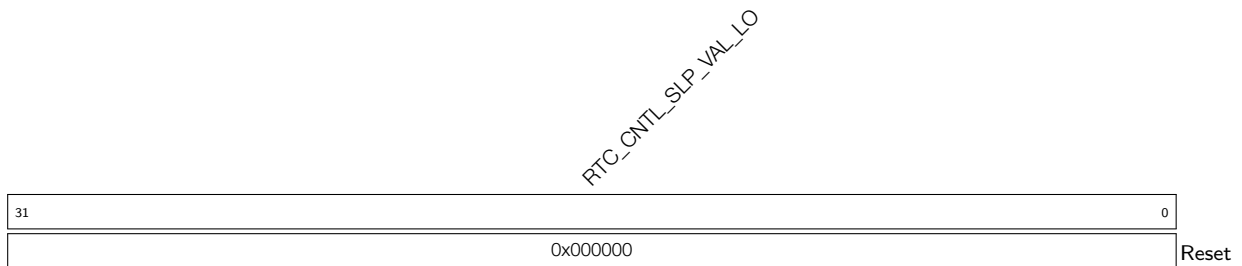

RTC_CNTL_RTC_SLP_VAL_LO Sets the lower 32 bits of the trigger threshold for the RTC timer. (R/W)

Register 10.3. RTC_CNTL_RTC_SLP_TIMER1_REG (0x0008)

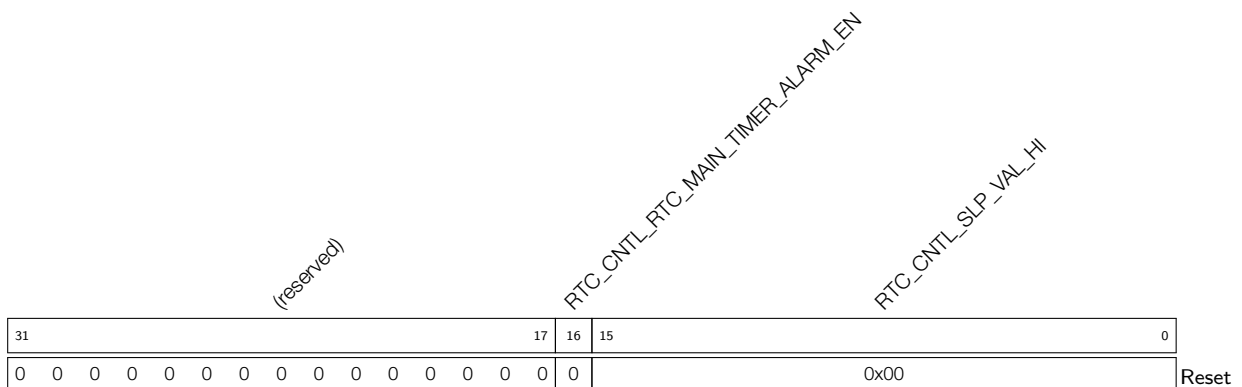

RTC_CNTL_RTC_SLP_VAL_HI Sets the higher 16 bits of the trigger threshold for the RTC timer. (R/W)

RTC_CNTL_RTC_MAIN_TIMER_ALARM_EN Sets this bit to enable the timer alarm. (WO)

Register 10.6. RTC_CNTL_RTC_TIME_HIGH0_REG (0x0014)

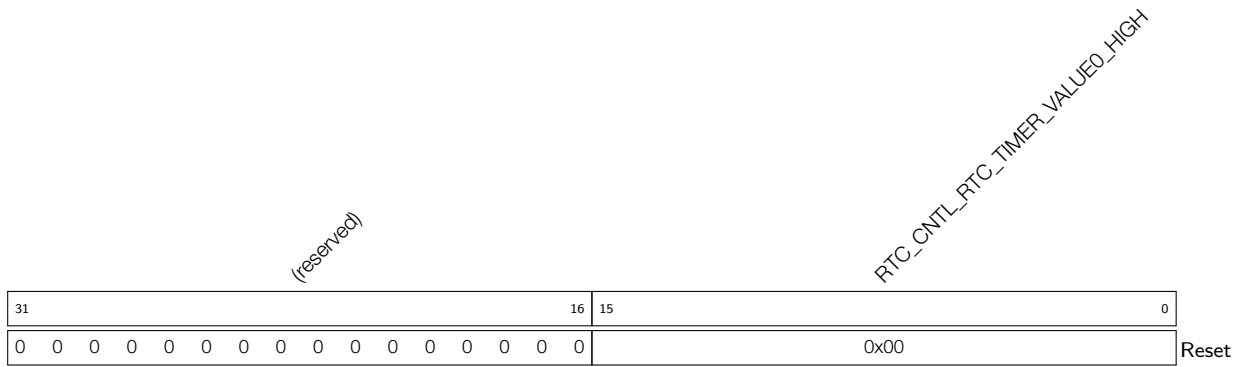

RTC_CNTL_RTC_TIMER_VALUE0_HIGH Stores the higher 16 bits of RTC timer 0. (RO)

Register 10.7. RTC_CNTL_RTC_STATE0_REG (0x0018)

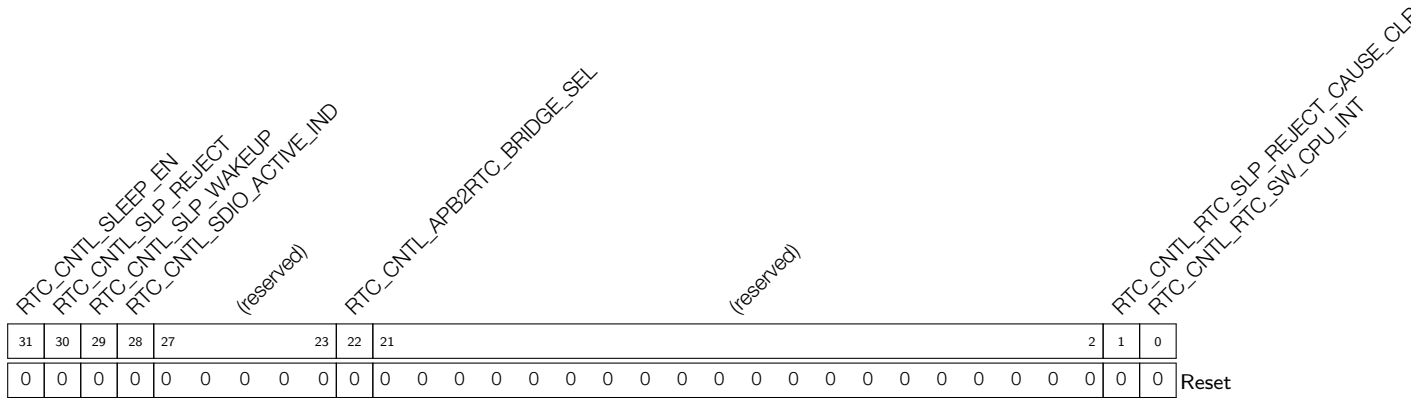

RTC_CNTL_RTC_SW_CPU_INT Sends a SW RTC interrupt to CPU. (WO)

RTC_CNTL_RTC_SLP_REJECT_CAUSE_CLR Clears the RTC reject-to-sleep cause. (WO)

RTC_CNTL_APB2RTC_BRIDGE_SEL 1: APB to RTC using bridge, 0: APB to RTC using sync (R/W)

RTC_CNTL_SDIO_ACTIVE_IND Indicates the SDIO is active. (RO)

RTC_CNTL_SLP_WAKEUP Indicates wakeup events. (R/W)

RTC_CNTL_SLP_REJECT Indicates reject-to-sleep event. (R/W)

RTC_CNTL_SLEEP_EN Sends the chip to sleep. (R/W)

Register 10.8. RTC_CNTL_RTC_TIMER1_REG (0x001C)

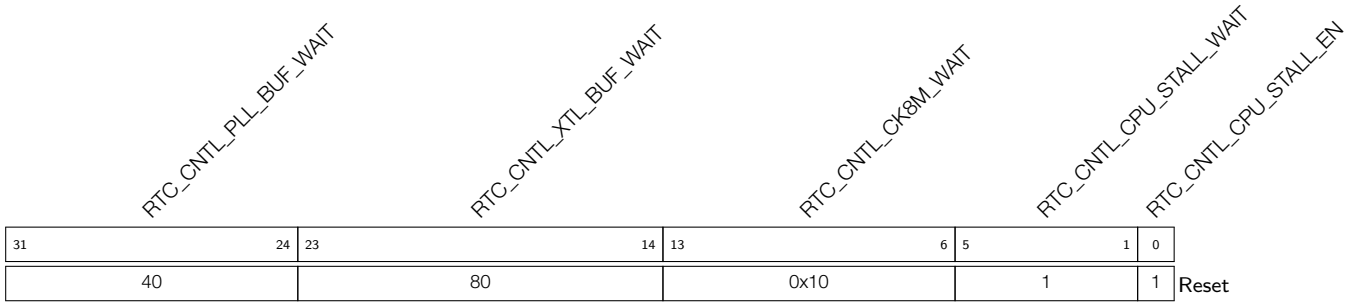

RTC_CNTL_CPU_STALL_EN Enables CPU stalling. (R/W)

RTC_CNTL_CPU_STALL_WAIT Sets the CPU stall waiting cycle (using the RTC fast clock). (R/W)

RTC_CNTL_CK8M_WAIT Sets the FOSC waiting cycle (using the RTC slow clock). (R/W)

RTC_CNTL_XTL_BUF_WAIT Sets the XTAL waiting cycle (using the RTC slow clock). (R/W)

RTC_CNTL_PLL_BUF_WAIT Sets the PLL waiting cycle (using the RTC slow clock). (R/W)

Register 10.9. RTC_CNTL_RTC_TIMER2_REG (0x0020)

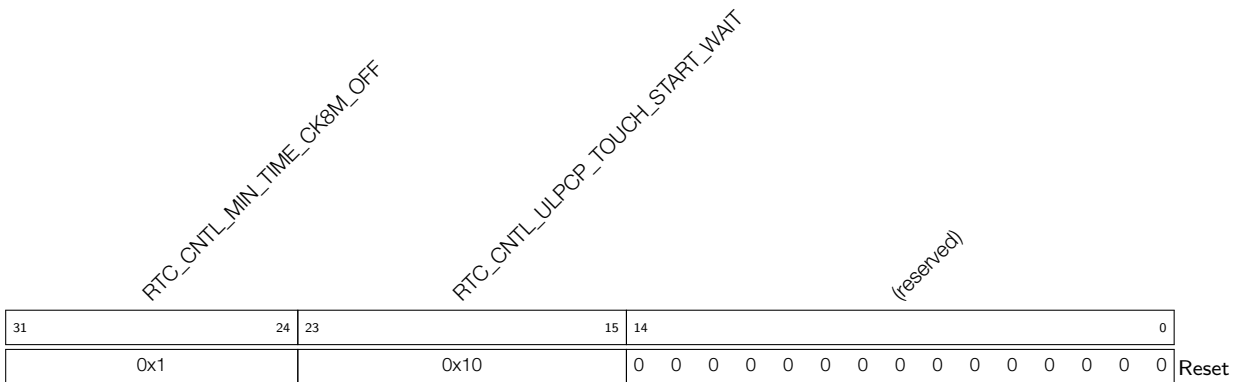

RTC_CNTL_ULPCP_TOUCH_START_WAIT Sets the waiting cycle (using the RTC slow clock) before the ULP co-processor starts to work. (R/W)

RTC_CNTL_MIN_TIME_CK8M_OFF Sets the minimal cycle for FOSC clock (using the RTC slow clock) when powered down. (R/W)

Register 10.10. RTC_CNTL_RTC_TIMER5_REG (0x002C)

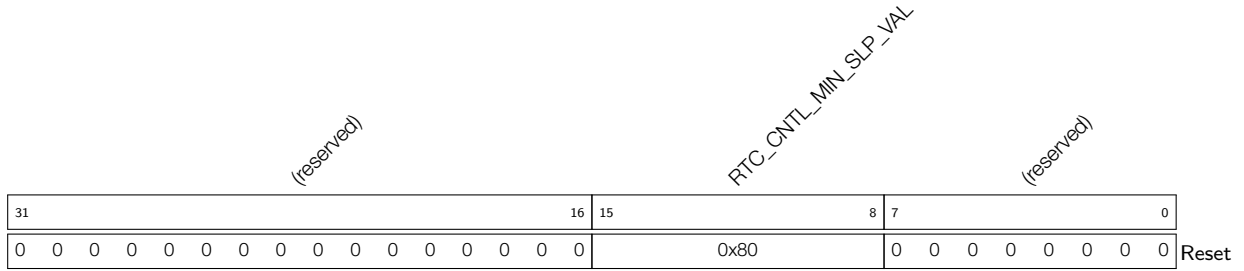

RTC_CNTL_MIN_SLP_VAL Sets the minimal sleep cycles (using the RTC slow clock). (R/W)

Register 10.11. RTC_CNTL_RTC_ANA_CONF_REG (0x0034)

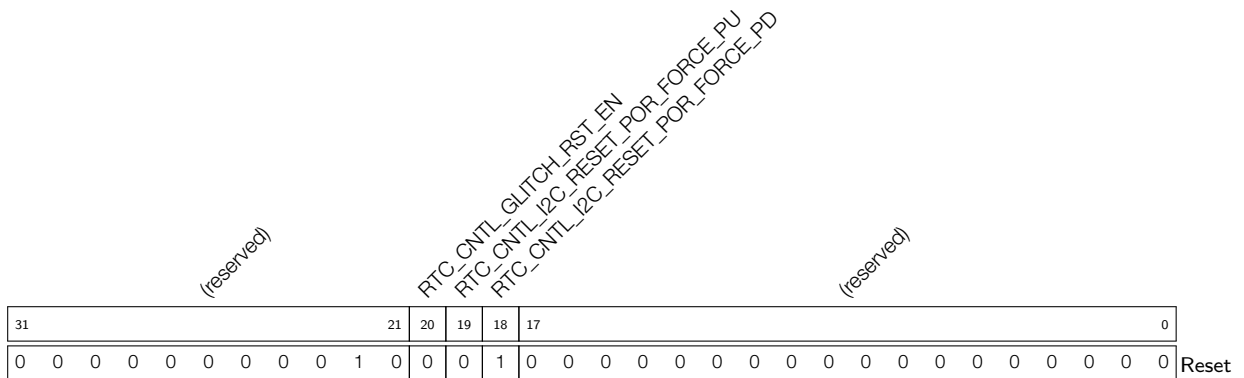

RTC_CNTL_I2C_RESET_POR_FORCE_PD Set this bit to FPD SLEEP_I2CPOR. (R/W)

RTC_CNTL_I2C_RESET_POR_FORCE_PU Set this bit to FPU SLEEP_I2CPOR. (R/W)

RTC_CNTL_GLITCH_RST_EN Set this bit to enable a reset when the system detects a glitch. (R/W)

Register 10.12. RTC_CNTL_RTC_RESET_STATE_REG (0x0038)

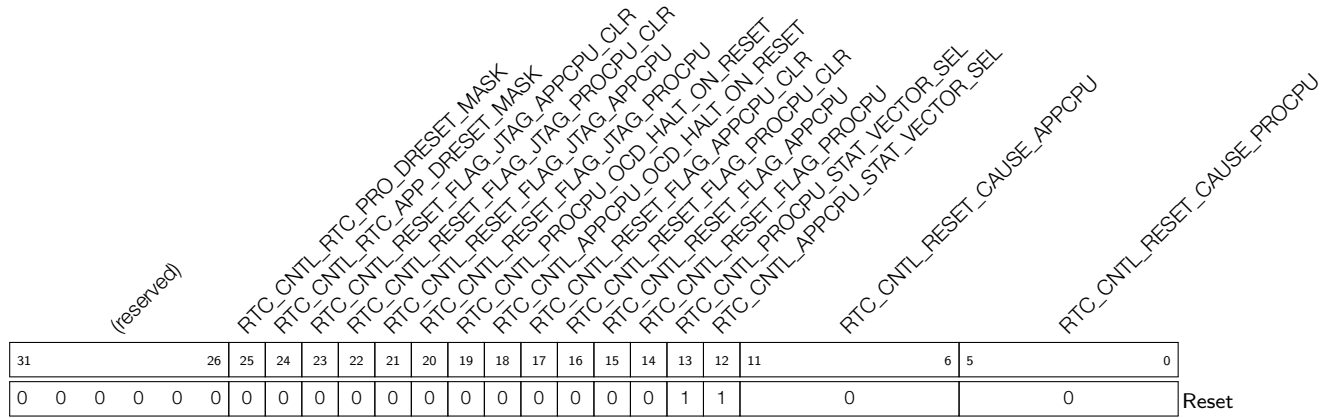

- RTC_CNTL_RESET_CAUSE_PROCPU** Stores CPU0's reset cause. (RO)
- RTC_CNTL_RESET_CAUSE_APPCPU** Stores CPU1's reset cause. (RO)
- RTC_CNTL_APPCPU_STAT_VECTOR_SEL** Selects CPU1 state vector. (R/W)
- RTC_CNTL_PROCPU_STAT_VECTOR_SEL** Selects CPU0 state vector. (R/W)
- RTC_CNTL_RESET_FLAG_PROCPU** Sets CPU0 reset flag. (RO)
- RTC_CNTL_RESET_FLAG_APPCPU** Sets CPU1 reset flag. (RO)
- RTC_CNTL_RESET_FLAG_PROCPU_CLR** Set this bit to clear CPU0 reset flag. (WO)
- RTC_CNTL_RESET_FLAG_APPCPU_CLR** Set this bit to clear CPU1 reset flag. (WO)
- RTC_CNTL_APPCPU_OCD_HALT_ON_RESET** Enables CPU1 to enter halt state after reset. (R/W)
- RTC_CNTL_PROCPU_OCD_HALT_ON_RESET** Enables CPU0 to enter halt state after reset. (R/W)

- RTC_CNTL_RESET_FLAG_JTAG_PROCPU** Sets CPU0's JTAG reset flag. (RO)
- RTC_CNTL_RESET_FLAG_JTAG_APPCPU** Sets CPU1's JTAG reset flag. (RO)
- RTC_CNTL_RESET_FLAG_JTAG_PROCPU_CLR** Set this bit to clear CPU0 JTAG reset flag. (WO)
- RTC_CNTL_RESET_FLAG_JTAG_APPCPU_CLR** Set this bit to clear CPU1 JTAG reset flag. (WO)
- RTC_CNTL_RTC_APP_DRESET_MASK** Set this bit to bypass CPU1 dreset. (R/W)
- RTC_CNTL_RTC_PRO_DRESET_MASK** Set this bit to bypass CPU0 dreset. (R/W)

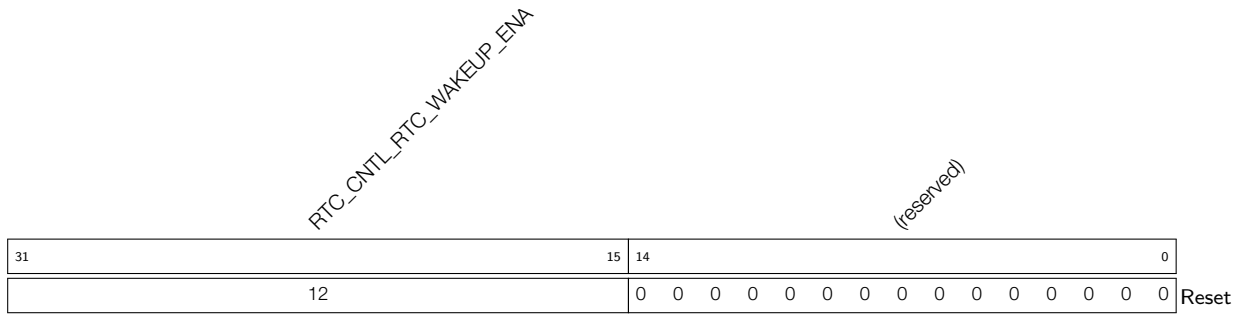
Register 10.13. RTC_CNTL_RTC_WAKEUP_STATE_REG (0x003C)

RTC_CNTL_RTC_WAKEUP_ENA Enables the wakeup bitmap. See details in Table 10-5. (R/W)

Register 10.14. RTC_CNTL_INT_ENA_RTC_REG (0x0040)

(reserved)												RTC_CNTL_RTC_TOUCH_APPROACH_LOOP_DONE_INT_ENA RTC_CNTL_RTC_TOUCH_GLITCH_DET_INT_ENA RTC_CNTL_RTC_TOUCH_TIMEOUT_INT_ENA RTC_CNTL_RTC_COOPU_TRAP_INT_ENA RTC_CNTL_RTC_XTAL32K_DEAD_INT_ENA RTC_CNTL_RTC_SWD_INT_ENA RTC_CNTL_RTC_SARADC2_INT_ENA RTC_CNTL_RTC_COOPU_INT_ENA RTC_CNTL_RTC_TSENS_INT_ENA RTC_CNTL_RTC_SARADC1_INT_ENA RTC_CNTL_RTC_MAIN_TIMER_INT_ENA RTC_CNTL_RTC_BROWN_OUT_INT_ENA RTC_CNTL_RTC_TOUCH_INACTIVE_INT_ENA RTC_CNTL_RTC_TOUCH_ACTIVE_INT_ENA RTC_CNTL_RTC_ULP_CP_INT_ENA RTC_CNTL_RTC_TOUCH_SCAN_DONE_INT_ENA RTC_CNTL_SDIO_IDLE_INT_ENA RTC_CNTL_SLP_REJECT_INT_ENA RTC_CNTL_SLP_WAKEUP_INT_ENA																			
31	21	20	19	18	17	16	15	14	13	12	11	10	9	8	7	6	5	4	3	2	1	0	Reset								
0	0	0	0	0	0	0	0	0	0	0	0	0	0	0	0	0	0	0	0	0	0	0	0	Reset							

RTC_CNTL_SLP_WAKEUP_INT_ENA Enables interrupt when the chip wakes up from sleep. (R/W)

RTC_CNTL_SLP_REJECT_INT_ENA Enables interrupt when the chip rejects to go to sleep. (R/W)

RTC_CNTL_SDIO_IDLE_INT_ENA Enables interrupt when the SDIO idles. (R/W)

RTC_CNTL_RTC_WDT_INT_ENA Enables the RTC watchdog interrupt. (R/W)

RTC_CNTL_RTC_TOUCH_SCAN_DONE_INT_ENA Enables interrupt upon the completion of a touch scanning. (R/W)

RTC_CNTL_RTC_ULP_CP_INT_ENA Enables the ULP co-processor interrupt. (R/W)

RTC_CNTL_RTC_TOUCH_DONE_INT_ENA Enables interrupt upon the completion of a single touch. (R/W)

RTC_CNTL_RTC_TOUCH_ACTIVE_INT_ENA Enables interrupt when a touch is detected. (R/W)

RTC_CNTL_RTC_TOUCH_INACTIVE_INT_ENA Enables interrupt when a touch is released. (R/W)

RTC_CNTL_RTC_BROWN_OUT_INT_ENA Enables the brown out interrupt. (R/W)

Continued on the next page...

Register 10.14. RTC_CNTL_INT_ENA_RTC_REG (0x0040)

Continued from the previous page...

RTC_CNTL_RTC_MAIN_TIMER_INT_ENA Enables the RTC main timer interrupt. (R/W)

RTC_CNTL_RTC_SARADC1_INT_ENA Enables the SAR ADC1 interrupt. (R/W)

RTC_CNTL_RTC_TSENS_INT_ENA Enables the temperature sensor interrupt. (R/W)

RTC_CNTL_RTC_COCPU_INT_ENA Enables the ULP-RISCV interrupt. (R/W)

RTC_CNTL_RTC_SARADC2_INT_ENA Enables the SAR ADC2 interrupt. (R/W)

RTC_CNTL_RTC_SWD_INT_ENA Enables the super watchdog interrupt. (R/W)

RTC_CNTL_RTC_XTAL32K_DEAD_INT_ENA Enables interrupt when the 32 kHz crystal is dead.
(R/W)

RTC_CNTL_RTC_COCPU_TRAP_INT_ENA Enables interrupt when the ULP-RISCV is trapped.
(R/W)

RTC_CNTL_RTC_TOUCH_TIMEOUT_INT_ENA Enables interrupt when touch sensor times out.
(R/W)

RTC_CNTL_RTC_GLITCH_DET_INT_ENA Enables interrupt when a glitch is detected. (R/W)

RTC_CNTL_RTC_TOUCH_APPROACH_LOOP_DONE_INT_ENA Enables interrupt upon the completion of a touch approach loop. (R/W)

Register 10.15. RTC_CNTL_INT_RAW_RTC_REG (0x0044)

(reserved)										RTC_CNTL_RTC_TOUCH_APPROACH_LOOP_DONE_INT_RAW RTC_CNTL_RTC_TOUCH_GLITCH_DET_INT_RAW RTC_CNTL_RTC_TOUCH_TIMEOUT_INT_RAW RTC_CNTL_RTC_COOPU_TRAP_INT_RAW RTC_CNTL_RTC_XTAL32K_DEAD_INT_RAW RTC_CNTL_RTC_SWD_INT_RAW RTC_CNTL_RTC_SARADC2_INT_RAW RTC_CNTL_RTC_COOPU_INT_RAW RTC_CNTL_RTC_TSENS_INT_RAW RTC_CNTL_RTC_SARADC1_INT_RAW RTC_CNTL_RTC_MAIN_TIMER_INT_RAW RTC_CNTL_RTC_BROWN_OUT_INT_RAW RTC_CNTL_RTC_TOUCH_INACTIVE_INT_RAW RTC_CNTL_RTC_TOUCH_ACTIVE_INT_RAW RTC_CNTL_RTC_ULP_CP_INT_RAW RTC_CNTL_RTC_TOUCH_SCAN_DONE_INT_RAW RTC_CNTL_RTC_WDT_IDLE_INT_RAW RTC_CNTL_SLP_REJECT_INT_RAW RTC_CNTL_SLP_WAKEUP_INT_RAW												
31	21	20	19	18	17	16	15	14	13	12	11	10	9	8	7	6	5	4	3	2	1	0
0	0	0	0	0	0	0	0	0	0	0	0	0	0	0	0	0	0	0	0	0	0	0

Reset

RTC_CNTL_SLP_WAKEUP_INT_RAW Stores the raw interrupt triggered when the chip wakes up from sleep. (RO)

RTC_CNTL_SLP_REJECT_INT_RAW Stores the raw interrupt triggered when the chip rejects to go to sleep. (RO)

RTC_CNTL_SDIO_IDLE_INT_RAW Stores the raw interrupt triggered when the SDIO idles. (RO)

RTC_CNTL_RTC_WDT_INT_RAW Stores the raw RTC watchdog interrupt. (RO)

RTC_CNTL_RTC_TOUCH_SCAN_DONE_INT_RAW Stores the raw interrupt triggered upon the completion of a touch scanning. (RO)

RTC_CNTL_RTC_ULP_CP_INT_RAW Stores the raw ULP co-processor interrupt. (RO)

RTC_CNTL_RTC_TOUCH_DONE_INT_RAW Stores the raw interrupt triggered upon the completion of a single touch. (RO)

RTC_CNTL_RTC_TOUCH_ACTIVE_INT_RAW Stores the raw interrupt triggered when a touch is detected. (RO)

RTC_CNTL_RTC_TOUCH_INACTIVE_INT_RAW Stores the raw interrupt triggered when a touch is released. (RO)

RTC_CNTL_RTC_BROWN_OUT_INT_RAW Stores the raw brown out interrupt. (RO)

Continued on the next page...

Register 10.15. RTC_CNTL_INT_RAW_RTC_REG (0x0044)

Continued from the previous page...

RTC_CNTL_RTC_MAIN_TIMER_INT_RAW Stores the raw RTC main timer interrupt. (RO)

RTC_CNTL_RTC_SARADC1_INT_RAW Stores the raw SAR ADC1 interrupt. (RO)

RTC_CNTL_RTC_TSENS_INT_RAW Stores the raw temperature sensor interrupt. (RO)

RTC_CNTL_RTC_COCPU_INT_RAW Stores the raw ULP-RISCV interrupt. (RO)

RTC_CNTL_RTC_SARADC2_INT_RAW Stores the raw SAR ADC2 interrupt. (RO)

RTC_CNTL_RTC_SWD_INT_RAW Stores the raw super watchdog interrupt. (RO)

RTC_CNTL_RTC_XTAL32K_DEAD_INT_RAW Stores the raw interrupt triggered when the 32 kHz crystal is dead. (RO)

RTC_CNTL_RTC_COCPU_TRAP_INT_RAW Stores the raw interrupt triggered when the ULP-RISCV is trapped. (RO)

RTC_CNTL_RTC_TOUCH_TIMEOUT_INT_RAW Stores the raw interrupt triggered when touch sensor times out. (RO)

RTC_CNTL_RTC_GLITCH_DET_INT_RAW Stores the raw interrupt triggered when a glitch is detected. (RO)

RTC_CNTL_RTC_TOUCH_APPROACH_LOOP_DONE_INT_RAW Stores the raw interrupt triggered upon the completion of a touch approach loop. (R/W)

Register 10.16. RTC_CNTL_INT_ST_RTC_REG (0x0048)

(reserved)																					RTC_CNTL_RTC_TOUCH_APPROACH_LOOP_DONE_INT_ST	RTC_CNTL_RTC_TOUCH_GLITCH_DET_INT_ST	RTC_CNTL_RTC_TOUCH_TIMEOUT_INT_ST	RTC_CNTL_RTC_TOUCH_COCPU_TRAP_INT_ST	RTC_CNTL_RTC_XTAL32K_DEAD_INT_ST	RTC_CNTL_RTC_SWD_INT_ST	RTC_CNTL_RTC_SARADC2_INT_ST	RTC_CNTL_RTC_COCPU_INT_ST	RTC_CNTL_RTC_TSENS_INT_ST	RTC_CNTL_RTC_SARADC1_INT_ST	RTC_CNTL_RTC_MAIN_TIMER_INT_ST	RTC_CNTL_RTC_BROWN_OUT_INT_ST	RTC_CNTL_RTC_TOUCH_INACTIVE_INT_ST	RTC_CNTL_RTC_TOUCH_ACTIVE_INT_ST	RTC_CNTL_RTC_ULP_CP_INT_ST	RTC_CNTL_RTC_TOUCH_DONE_INT_ST	RTC_CNTL_RTC_WDT_INT_ST	RTC_CNTL_SLP_REJECT_INT_ST	RTC_CNTL_SLP_WAKEUP_INT_ST	Reset
31	21	20	19	18	17	16	15	14	13	12	11	10	9	8	7	6	5	4	3	2	1	0																		
0	0	0	0	0	0	0	0	0	0	0	0	0	0	0	0	0	0	0	0	0	0	0																		

RTC_CNTL_SLP_WAKEUP_INT_ST Stores the status of the interrupt triggered when the chip wakes up from sleep. (RO)

RTC_CNTL_SLP_REJECT_INT_ST Stores the status of the interrupt triggered when the chip rejects to go to sleep. (RO)

RTC_CNTL_SDIO_IDLE_INT_ST Stores the status of the interrupt triggered when the SDIO idles. (RO)

RTC_CNTL_RTC_WDT_INT_ST Stores the status of the RTC watchdog interrupt. (RO)

RTC_CNTL_RTC_TOUCH_SCAN_DONE_INT_ST Stores the status of the interrupt triggered upon the completion of a touch scanning. (RO)

RTC_CNTL_RTC_ULP_CP_INT_ST Stores the status of the ULP co-processor interrupt. (RO)

RTC_CNTL_RTC_TOUCH_DONE_INT_ST Stores the status of the interrupt triggered upon the completion of a single touch. (RO)

RTC_CNTL_RTC_TOUCH_ACTIVE_INT_ST Stores the status of the interrupt triggered when a touch is detected. (RO)

RTC_CNTL_RTC_TOUCH_INACTIVE_INT_ST Stores the status of the interrupt triggered when a touch is released. (RO)

RTC_CNTL_RTC_BROWN_OUT_INT_ST Stores the status of the brown out interrupt. (RO)

Continued on the next page...

Register 10.16. RTC_CNTL_INT_ST_RTC_REG (0x0048)

Continued from the previous page...

RTC_CNTL_RTC_MAIN_TIMER_INT_ST Stores the status of the RTC main timer interrupt. (RO)

RTC_CNTL_RTC_SARADC1_INT_ST Stores the status of the SAR ADC1 interrupt. (RO)

RTC_CNTL_RTC_TSENS_INT_ST Stores the status of the temperature sensor interrupt. (RO)

RTC_CNTL_RTC_COCPU_INT_ST Stores the status of the ULP-RISCV interrupt. (RO)

RTC_CNTL_RTC_SARADC2_INT_ST Stores the status of the SAR ADC2 interrupt. (RO)

RTC_CNTL_RTC_SWD_INT_ST Stores the status of the super watchdog interrupt. (RO)

RTC_CNTL_RTC_XTAL32K_DEAD_INT_ST Stores the status of the interrupt triggered when the 32 kHz crystal is dead. (RO)

RTC_CNTL_RTC_COCPU_TRAP_INT_ST Stores the status of the interrupt triggered when the ULP-RISCV is trapped. (RO)

RTC_CNTL_RTC_TOUCH_TIMEOUT_INT_ST Stores the status of the interrupt triggered when touch sensor times out. (RO)

RTC_CNTL_RTC_GLITCH_DET_INT_ST Stores the status of the interrupt triggered when a glitch is detected. (RO)

RTC_CNTL_RTC_TOUCH_APPROACH_LOOP_DONE_INT_ST Stores the status of the interrupt triggered upon the completion of a touch approach loop. (RO)

Register 10.17. RTC_CNTL_INT_CLR_RTC_REG (0x004C)

Continued from the previous page...

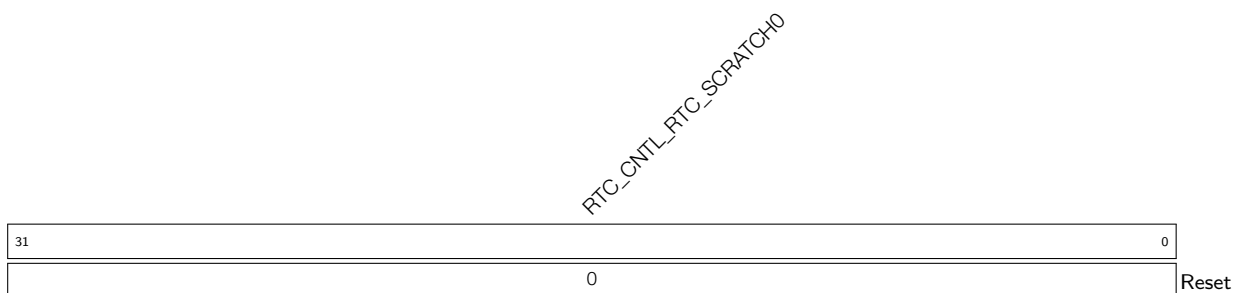
RTC_CNTL_RTC_MAIN_TIMER_INT_CLR Clears the RTC main timer interrupt. (WO)**RTC_CNTL_RTC_SARADC1_INT_CLR** Clears the SAR ADC1 interrupt. (WO)**RTC_CNTL_RTC_TSENS_INT_CLR** Clears the temperature sensor interrupt. (WO)**RTC_CNTL_RTC_COCPU_INT_CLR** Clears the ULP-RISCV interrupt. (WO)**RTC_CNTL_RTC_SARADC2_INT_CLR** Clears the SAR ADC2 interrupt. (WO)**RTC_CNTL_RTC_SWD_INT_CLR** Clears the super watchdog interrupt. (WO)**RTC_CNTL_RTC_XTAL32K_DEAD_INT_CLR** Clears the interrupt triggered when the 32 kHz crystal is dead. (WO)**RTC_CNTL_RTC_COCPU_TRAP_INT_CLR** Clears the interrupt triggered when the ULP-RISCV is trapped. (WO)**RTC_CNTL_RTC_TOUCH_TIMEOUT_INT_CLR** Clears the interrupt triggered when touch sensor times out. (WO)**RTC_CNTL_RTC_GLITCH_DET_INT_CLR** Clears the interrupt triggered when a glitch is detected. (WO)**RTC_CNTL_RTC_TOUCH_APPROACH_LOOP_DONE_INT_CLR** Clears the interrupt triggered upon the completion of a touch approach loop. (WO)**Register 10.18. RTC_CNTL_RTC_STORE0_REG (0x0050)****RTC_CNTL_RTC_SCRATCH0** Retention register (R/W)

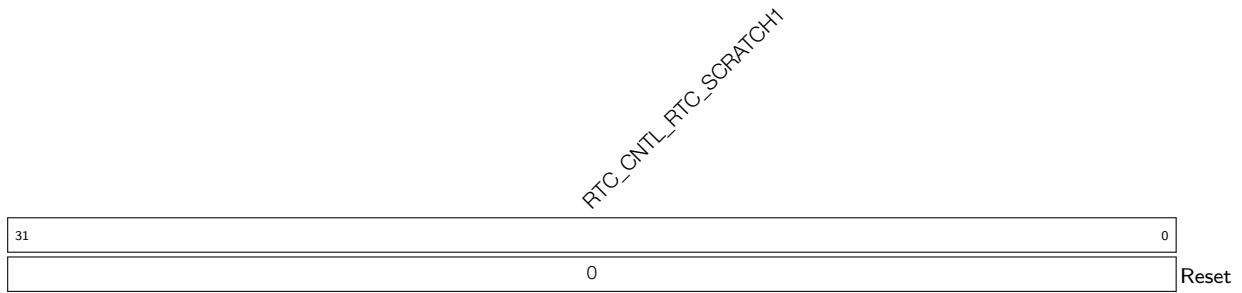
Register 10.19. RTC_CNTL_RTC_STORE1_REG (0x0054)

RTC_CNTL_RTC_SCRATCH1 Retention register (R/W)

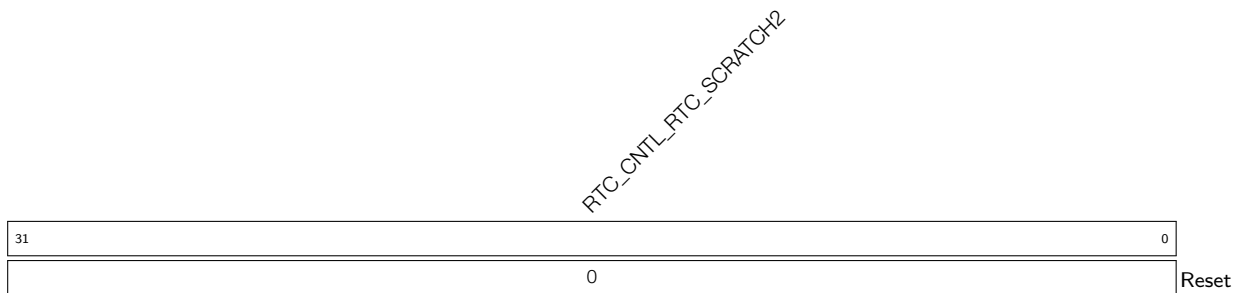
Register 10.20. RTC_CNTL_RTC_STORE2_REG (0x0058)

RTC_CNTL_RTC_SCRATCH2 Retention register (R/W)

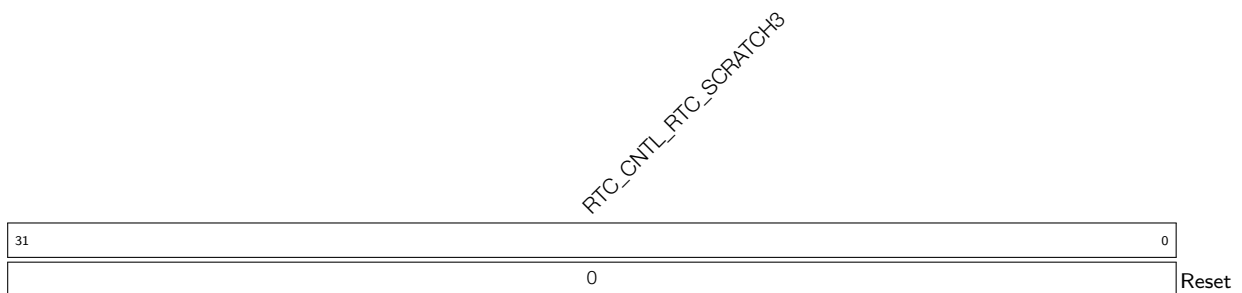
Register 10.21. RTC_CNTL_RTC_STORE3_REG (0x005C)

RTC_CNTL_RTC_SCRATCH3 Retention register (R/W)

Register 10.22. RTC_CNTL_RTC_EXT_XTL_CONF_REG (0x0060)

RTC_CNTL_XTL_EXT_CTRL_EN		RTC_CNTL_XTL_EXT_CTRL_LV		(reserved)		RTC_CNTL_RTC_XTAL32K_GPIO_SEL		RTC_CNTL_RTC_WDT_STATE		RTC_CNTL_DAC_XTAL_32K		RTC_CNTL_XPD_XTAL_32K		RTC_CNTL_DRES_XTAL_32K		RTC_CNTL_DGM_XTAL_32K		RTC_CNTL_DBUF_XTAL_32K		RTC_CNTL_ENCKINIT_XTAL_32K		RTC_CNTL_XTAL32K_XPD_FORCE		RTC_CNTL_XTAL32K_AUTO_RETURN		RTC_CNTL_XTAL32K_AUTO_RESTART		RTC_CNTL_XTAL32K_EXT_CLK_FO		RTC_CNTL_XTAL32K_WDT_RESET		RTC_CNTL_XTAL32K_WDT_CLK_FO	
31	30	29	28	27	26	25	24	23	22	21	20	19	18	17	16	15	14	13	12	11	10	9	8	7	6	5	4	3	2	1	0		
0	0	0	0	0	0	0	0	0	0x0	3	0	3	3	0	0	1	0	0	0	0	0	0	0	0	0	0	0	0	0	0	0		

Reset

RTC_CNTL_XTAL32K_WDT_EN Set this bit to enable the 32 kHz crystal watchdog. (R/W)

RTC_CNTL_XTAL32K_WDT_CLK_FO Set this bit to FPU the 32 kHz crystal watchdog clock. (R/W)

RTC_CNTL_XTAL32K_WDT_RESET Set this bit to reset the 32 kHz crystal watchdog by SW. (R/W)

RTC_CNTL_XTAL32K_EXT_CLK_FO Set this bit to FPU the external clock of 32 kHz crystal. (R/W)

RTC_CNTL_XTAL32K_AUTO_BACKUP Set this bit to switch to the backup clock when the 32 kHz crystal is dead. (R/W)

RTC_CNTL_XTAL32K_AUTO_RESTART Set this bit to restart the 32 kHz crystal automatically when the 32 kHz crystal is dead. (R/W)

RTC_CNTL_XTAL32K_AUTO_RETURN Set this bit to switch back to 32 kHz crystal when the 32 kHz crystal is restarted. (R/W)

RTC_CNTL_XTAL32K_XPD_FORCE Set 1 to allow the software to FPD the 32 kHz crystal. Set 0 to allow the FSM to FPD the 32 kHz crystal. (R/W) (R/W)

RTC_CNTL_ENCKINIT_XTAL_32K Applies an internal clock to help the 32 kHz crystal to start. (R/W)

RTC_CNTL_DBUF_XTAL_32K 0: single-end buffer 1: differential buffer (R/W)

RTC_CNTL_DGM_XTAL_32K xtal_32k gm control (R/W)

Continued on the next page...

Register 10.24. RTC_CNTL_RTC_SLP_REJECT_CONF_REG (0x0068)

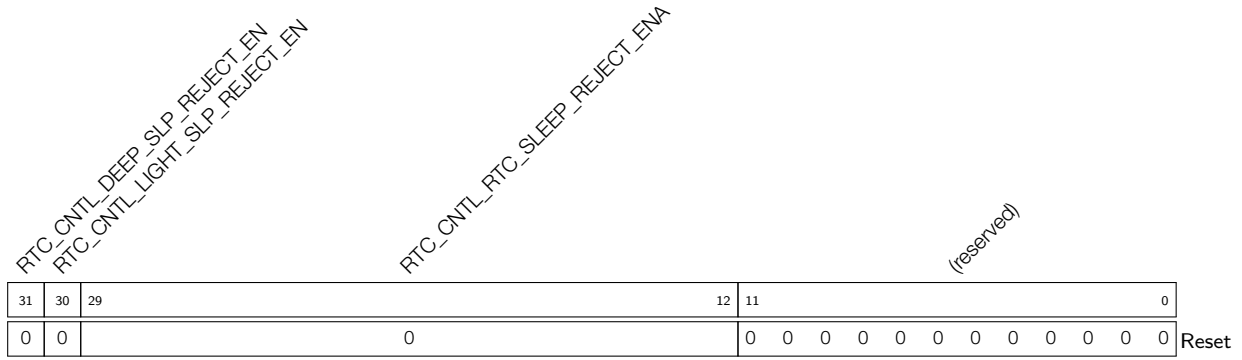

RTC_CNTL_RTC_SLEEP_REJECT_ENA Set this bit to enable reject-to-sleep. (R/W)

RTC_CNTL_LIGHT_SLP_REJECT_EN Set this bit to enable reject-to-light-sleep. (R/W)

RTC_CNTL_DEEP_SLP_REJECT_EN Set this bit to enable reject-to-deep-sleep. (R/W)

Register 10.25. RTC_CNTL_RTC_CLK_CONF_REG (0x0074)

RTC_CNTL_ANA_CLK_RTC_SEL						RTC_CNTL_FAST_CLK_RTC_SEL						RTC_CNTL_XTAL_GLOBAL_FORCE_NOGATING						RTC_CNTL_XTAL_GLOBAL_FORCE_GATING						RTC_CNTL_CK8M_FORCE_PU						RTC_CNTL_CK8M_FORCE_PD						RTC_CNTL_CK8M_DFREQ						RTC_CNTL_CK8M_FORCE_NOGATING						RTC_CNTL_XTAL_FORCE_NOGATING						RTC_CNTL_CK8M_DIV_SEL						(reserved)						RTC_CNTL_DIG_CLK8M_EN						RTC_CNTL_DIG_CLK8M_D256_EN						RTC_CNTL_DIG_XTAL32K_EN						RTC_CNTL_ENB_CK8M_DIV						RTC_CNTL_ENB_CK8M						RTC_CNTL_CK8M_DIV						RTC_CNTL_CK8M_DIV_SEL_VLD						RTC_CNTL_EFUSE_CLK_FORCE_NOGATING						RTC_CNTL_EFUSE_CLK_FORCE_GATING						(reserved)					
31	30	29	28	27	26	25	24									17	16	15	14					12	11	10	9	8	7	6	5	4	3	2	1	0	Reset																																																																																								
0	0	1	0	0	0	172								0	0	3				0	0	1	0	0	0	0	1	1	1	0	0																																																																																														

RTC_CNTL_EFUSE_CLK_FORCE_GATING Set this bit to force eFuse gating. (R/W)

RTC_CNTL_EFUSE_CLK_FORCE_NOGATING Set this bit to force no eFuse gating. (R/W)

RTC_CNTL_CK8M_DIV_SEL_VLD Synchronizes the reg_ck8m_div_sel. Not that you have to invalidate the bus before switching clock, and validate the new clock. (R/W)

RTC_CNTL_CK8M_DIV Set the CK8M_D256_OUT divider. 00: divided by 128 01: divided by 256 10: divided by 512 11: divided by 1024. (R/W)

RTC_CNTL_ENB_CK8M Set this bit to disable CK8M and CK8M_D256_OUT. (R/W)

RTC_CNTL_ENB_CK8M_DIV Selects the CK8M_D256_OUT. 1: CK8M 0: CK8M divided by 256. (R/W)

RTC_CNTL_DIG_XTAL32K_EN Set this bit to enable CK_XTAL_32K clock for the digital core. (R/W)

RTC_CNTL_DIG_CLK8M_D256_EN Set this bit to enable CK8M_D256_OUT clock for the digital core. (R/W)

RTC_CNTL_DIG_CLK8M_EN Set this bit to enable 8 MHz clock for the digital core. (R/W)

RTC_CNTL_CK8M_DIV_SEL Stores the 8 MHz divider, which is reg_ck8m_div_sel + 1 (R/W)

RTC_CNTL_XTAL_FORCE_NOGATING Set this bit to force no gating to crystal during sleep (R/W)

RTC_CNTL_CK8M_FORCE_NOGATING Set this bit to disable force gating to 8 MHz crystal during sleep. (R/W)

Continued on the next page...

Register 10.25. RTC_CNTL_RTC_CLK_CONF_REG (0x0074)

Continued from the previous page...

RTC_CNTL_CK8M_DFREQ CK8M_DFREQ (R/W)

RTC_CNTL_CK8M_FORCE_PD Set this bit to FPD the RC_FAST_CLK clock. (R/W)

RTC_CNTL_CK8M_FORCE_PU Set this bit to FPU the RC_FAST_CLK clock. (R/W)

RTC_CNTL_XTAL_GLOBAL_FORCE_GATING Set this bit to force gating xtal. (R/W)

RTC_CNTL_XTAL_GLOBAL_FORCE_NOGATING Set this bit to force no gating xtal. (R/W)

RTC_CNTL_FAST_CLK_RTC_SEL Set this bit to select the RTC fast clock. 0: XTAL_DIV_CLK, 1: RC_FAST_CLK div n. (R/W)

RTC_CNTL_ANA_CLK_RTC_SEL Set this bit to select the RTC slow clock. 0: RC_SLOW_CLK 1: XTAL32K_CLK 2: RC_FAST_DIV_CLK. (R/W)

Register 10.26. RTC_CNTL_RTC_SLOW_CLK_CONF_REG (0x0078)

(reserved)		<i>RTC_CNTL_RTC_ANA_CLK_DIV</i>						<i>RTC_CNTL_RTC_ANA_CLK_DIV_VLD</i>						(reserved)					
31	30							23	22	21							0		
0	0						1	0 0						0	Reset				

RTC_CNTL_RTC_ANA_CLK_DIV_VLD Synchronizes the reg_rtc_ana_clk_div bus. Note that you have to invalidate the bus before switching clock, and validate the new clock. (R/W)

RTC_CNTL_RTC_ANA_CLK_DIV Set the RC_SLOW_CLK divider. (R/W)

Register 10.29. RTC_CNTL_RTC_PWC_REG (0x0088)

(reserved)										RTC_CNTL_RTC_PAD_FORCE_HOLD				RTC_CNTL_RTC_PD_EN				RTC_CNTL_RTC_FORCE_PU				RTC_CNTL_RTC_FORCE_PD				(reserved)										RTC_CNTL_RTC_SLOWMEM_FORCE_LPU				RTC_CNTL_RTC_SLOWMEM_FORCE_LPD				RTC_CNTL_RTC_SLOWMEM_FOLW_CPU				RTC_CNTL_RTC_FASTMEM_FORCE_LPU				RTC_CNTL_RTC_FASTMEM_FORCE_LPD				RTC_CNTL_RTC_FORCE_NOISO				RTC_CNTL_RTC_FORCE_ISO				(reserved)									
31	30	29	28	27	26	25	24	23	22	21	20	19	18	17	16	15	14	13	12	11	10	9	8	7	6	5	4	3	2	1	0	Reset																																									
0	0	0	0	0	0	0	0	0	0	0	0	0	0	0	0	0	0	0	0	1	0	0	1	0	0	1	0	0	1	0	1	0	1	1																																							

RTC_CNTL_RTC_FORCE_ISO Set this bit to force isolate the RTC peripherals. (R/W)

RTC_CNTL_RTC_FORCE_NOISO Set this bit to disable the force isolation to the RTC peripherals. (R/W)

RTC_CNTL_RTC_FASTMEM_FOLW_CPU Set 1 to FPD the RTC slow memory when the CPU is powered down. Set 0 to FPD the RTC slow memory when the RTC main state machine is powered down. (R/W)

RTC_CNTL_RTC_FASTMEM_FORCE_LPD Set this bit to force not retain the RTC fast memory. (R/W)

RTC_CNTL_RTC_FASTMEM_FORCE_LPU Set this bit to force retain the RTC fast memory. (R/W)

RTC_CNTL_RTC_SLOWMEM_FOLW_CPU 1: RTC memory PD following CPU, 0: RTC memory PD following RTC state machine (R/W)

Continued on the next page...

Register 10.29. RTC_CNTL_RTC_PWC_REG (0x0088)

Continued from the previous page...

RTC_CNTL_RTC_SLOWMEM_FORCE_LPD Set this bit to force not retain the RTC slow memory. (R/W)

RTC_CNTL_RTC_SLOWMEM_FORCE_LPU Set this bit to force retain the RTC slow memory. (R/W)

RTC_CNTL_RTC_FORCE_PD Set this bit to FPD the RTC peripherals. (R/W)

RTC_CNTL_RTC_FORCE_PU Set this bit to FPU the RTC peripherals. (R/W)

RTC_CNTL_RTC_PD_EN Set this bit to enable PD for the RTC peripherals in sleep. (R/W)

RTC_CNTL_RTC_PAD_FORCE_HOLD Set this bit the force hold the RTC GPIOs. (R/W)

Register 10.30. RTC_CNTL_DIG_PWC_REG (0x0090)

<i>RTC_CNTL_DG_WRAP_PD_EN</i>					<i>RTC_CNTL_CPU_TOP_FORCE_PU</i>					<i>RTC_CNTL_DG_PERI_FORCE_PU</i>					<i>RTC_CNTL_LSLP_MEM_FORCE_PU</i>																
<i>RTC_CNTL_WIFI_PD_EN</i>					<i>RTC_CNTL_CPU_TOP_FORCE_PD</i>					<i>RTC_CNTL_DG_WRAP_FORCE_PD</i>					<i>RTC_CNTL_LSLP_MEM_FORCE_PU</i>																
<i>RTC_CNTL_CPU_TOP_PD_EN</i>					<i>RTC_CNTL_DG_WRAP_FORCE_PU</i>					<i>RTC_CNTL_WIFI_FORCE_PU</i>					<i>RTC_CNTL_LSLP_MEM_FORCE_PD</i>																
<i>RTC_CNTL_DG_PERI_PD_EN</i>					<i>(reserved)</i>					<i>RTC_CNTL_DG_PERI_FORCE_PD</i>					<i>(reserved)</i>																
<i>(reserved)</i>					<i>(reserved)</i>					<i>(reserved)</i>					<i>(reserved)</i>																
31	30	29	28	27	23	22	21	20	19	18	17	16	15	14	13	12	5	4	3	2	0										
0	0	0	0	0	0	0	0	0	1	0	1	0	1	0	0	0	1	0	0	0	0	0	0	0	0	0	1	0	0	0	0

Reset

RTC_CNTL_LSLP_MEM_FORCE_PD Set this bit to FPD the memories in the digital system in sleep. (R/W)

RTC_CNTL_LSLP_MEM_FORCE_PU Set this bit to FPU the memories in the digital system. (R/W)

RTC_CNTL_DG_PERI_FORCE_PD Set this bit to FPD PD peripherals. (R/W)

RTC_CNTL_DG_PERI_FORCE_PU Set this bit to FPU PD peripherals. (R/W)

RTC_CNTL_WIFI_FORCE_PD Set this bit to FPD Wi-Fi. (R/W)

RTC_CNTL_WIFI_FORCE_PU Set this bit to FPU Wi-Fi. (R/W)

RTC_CNTL_DG_WRAP_FORCE_PD Set this bit to FPD the digital core. (R/W)

RTC_CNTL_DG_WRAP_FORCE_PU Set this bit to FPU the digital core. (R/W)

RTC_CNTL_CPU_TOP_FORCE_PD Set this bit to FPD the CPU. (R/W)

RTC_CNTL_CPU_TOP_FORCE_PU Set this bit to FPU the CPU. (R/W)

RTC_CNTL_DG_PERI_PD_EN Set this bit to enable PD for the PD peripherals in sleep. (R/W)

RTC_CNTL_CPU_TOP_PD_EN Set this bit to enable PD for the CPU in sleep. (R/W)

RTC_CNTL_WIFI_PD_EN Set this bit to enable PD for the Wi-Fi circuit in sleep. (R/W)

RTC_CNTL_DG_WRAP_PD_EN Set this bit to enable PD for the digital system in sleep. (R/W)

Register 10.31. RTC_CNTL_DIG_ISO_REG (0x0094)

RTC_CNTL_DG_WRAP_FORCE_NOISO	RTC_CNTL_DG_WRAP_FORCE_ISO	RTC_CNTL_WIFI_FORCE_NOISO	RTC_CNTL_WIFI_FORCE_ISO	RTC_CNTL_CPU_TOP_FORCE_NOISO	RTC_CNTL_CPU_TOP_FORCE_ISO	RTC_CNTL_DG_PERI_FORCE_NOISO	RTC_CNTL_DG_PERI_FORCE_ISO	(reserved)	RTC_CNTL_DG_PAD_FORCE_HOLD	RTC_CNTL_DG_PAD_FORCE_UNHOLD	RTC_CNTL_DG_PAD_FORCE_ISO	RTC_CNTL_DG_PAD_AUTOHOLD_EN	RTC_CNTL_DG_PAD_AUTOHOLD	(reserved)					
31	30	29	28	27	26	25	24	23	16	15	14	13	12	11	10	9	8	0	
1	0	1	0	1	0	1	0	0	0	0	0	0	0	0	0	0	0	0	0

Reset

RTC_CNTL_DG_PAD_AUTOHOLD Indicates the auto-hold status of the digital GPIOs. (RO)

RTC_CNTL_CLR_DG_PAD_AUTOHOLD Ste this bit to clear the auto-hold enabler for the digital GPIOs. (WO)

RTC_CNTL_DG_PAD_AUTOHOLD_EN Set this bit to allow the digital GPIOs to enter the autohold status. (R/W)

RTC_CNTL_DG_PAD_FORCE_NOISO Set this bit to disable the force isolation to the digital GPIOs. (R/W)

RTC_CNTL_DG_PAD_FORCE_ISO Set this bit to force isolate the digital GPIOs. (R/W)

RTC_CNTL_DG_PAD_FORCE_UNHOLD Set this bit the force unhold the digital GPIOs. (R/W)

RTC_CNTL_DG_PAD_FORCE_HOLD Set this bit the force hold the digital GPIOs. (R/W)

RTC_CNTL_DG_PERI_FORCE_ISO Set this bit to force isolate the digital peripherals. (R/W)

RTC_CNTL_DG_PERI_FORCE_NOISO Set this bit to disable the force isolation to the digital peripherals. (R/W)

RTC_CNTL_CPU_TOP_FORCE_ISO Set this bit to force isolate the CPU. (R/W)

RTC_CNTL_CPU_TOP_FORCE_NOISO Set this bit to disable the force isolation to the CPU. (R/W)

RTC_CNTL_WIFI_FORCE_ISO Set this bit to force isolate the Wi-Fi circuits. (R/W)

RTC_CNTL_WIFI_FORCE_NOISO Set this bit to disable the force isolation to the Wi-Fi circuits. (R/W)

RTC_CNTL_DG_WRAP_FORCE_ISO Set this bit to force isolate the digital system. (R/W)

RTC_CNTL_DG_WRAP_FORCE_NOISO Set this bit to disable the force isolation to the digital system. (R/W)

Register 10.32. RTC_CNTL_RTC_WDTCONFIG0_REG (0x0098)

RTC_CNTL_WDT_EN		RTC_CNTL_WDT_STG0		RTC_CNTL_WDT_STG1		RTC_CNTL_WDT_STG2		RTC_CNTL_WDT_STG3		RTC_CNTL_WDT_CPU_RESET_LENGTH		RTC_CNTL_WDT_SYS_RESET_LENGTH		RTC_CNTL_WDT_FLASHBOOT_MOD_EN		RTC_CNTL_WDT_PROCPU_RESET_EN		RTC_CNTL_WDT_APPCPU_RESET_EN		RTC_CNTL_WDT_PAUSE_IN_SLP		(reserved)		
31	30	28	27	25	24	22	21	19	18	16	15	13	12	11	10	9	8						0	
0	0x0	0x0	0x0	0x0	0x0	0x1	0x1	1	0	0	1	0	0	0	0	0	0	0	0	0	0	0	0	0

RTC_CNTL_WDT_PAUSE_IN_SLP Set this bit to pause the watchdog in sleep. (R/W)

RTC_CNTL_WDT_APPCPU_RESET_EN enable WDT reset APP CPU (R/W)

RTC_CNTL_WDT_PROCPU_RESET_EN Set this bit to allow the watchdog to be able to reset CPU. (R/W)

RTC_CNTL_WDT_FLASHBOOT_MOD_EN Set this bit to enable watchdog when the chip boots from flash. (R/W)

RTC_CNTL_WDT_SYS_RESET_LENGTH Sets the length of the system reset counter. (R/W)

RTC_CNTL_WDT_CPU_RESET_LENGTH Sets the length of the CPU reset counter. (R/W)

RTC_CNTL_WDT_STG3 1: enable at the interrupt stage 2: enable at the CPU stage 3: enable at the system stage 4: enable at the system and RTC stage. (R/W)

RTC_CNTL_WDT_STG2 1: enable at the interrupt stage 2: enable at the CPU stage 3: enable at the system stage 4: enable at the system and RTC stage. (R/W)

RTC_CNTL_WDT_STG1 1: enable at the interrupt stage 2: enable at the CPU stage 3: enable at the system stage 4: enable at the system and RTC stage. (R/W)

RTC_CNTL_WDT_STG0 1: enable at the interrupt stage 2: enable at the CPU stage 3: enable at the system stage 4: enable at the system and RTC stage. (R/W)

RTC_CNTL_WDT_EN Set this bit to enable the RTC watchdog. (R/W)

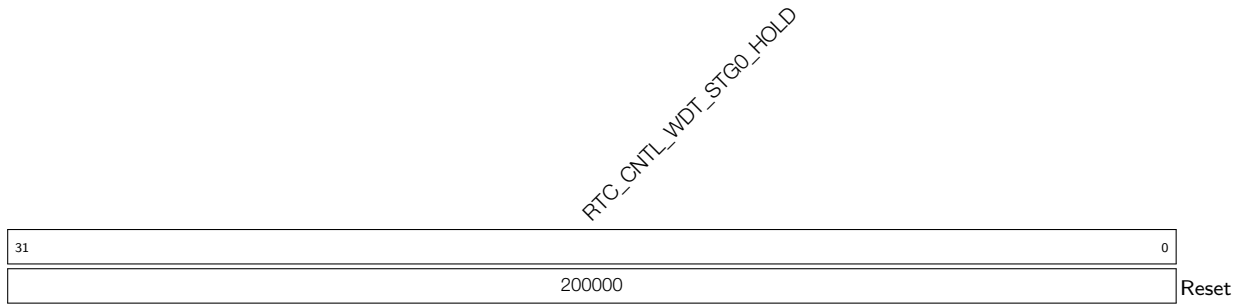
Register 10.33. RTC_CNTL_RTC_WDTCONFIG1_REG (0x009C)

RTC_CNTL_WDT_STG0_HOLD Configures the hold time of RTC watchdog at level 1. (R/W)

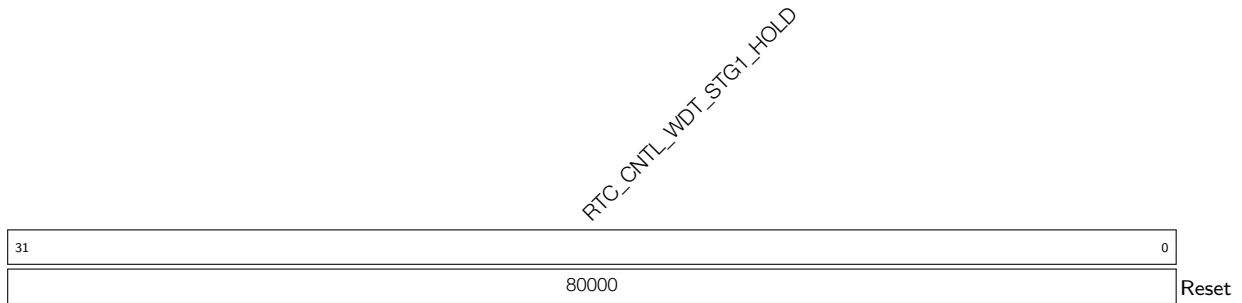
Register 10.34. RTC_CNTL_RTC_WDTCONFIG2_REG (0x00A0)

RTC_CNTL_WDT_STG1_HOLD Configures the hold time of RTC watchdog at level 2. (R/W)

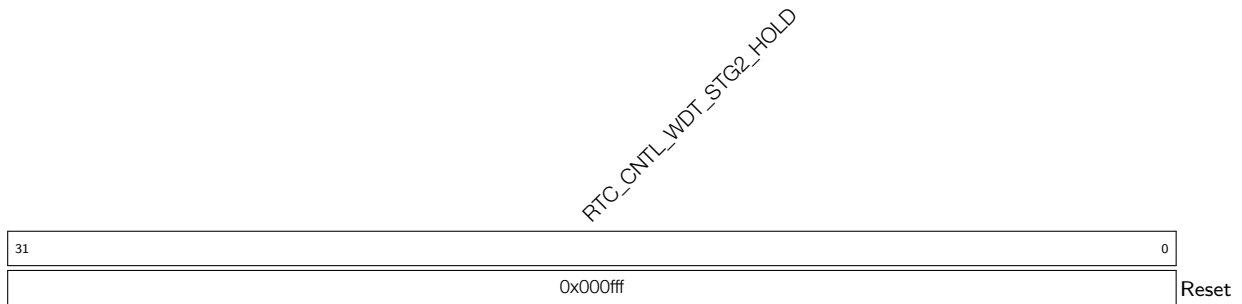
Register 10.35. RTC_CNTL_RTC_WDTCONFIG3_REG (0x00A4)

RTC_CNTL_WDT_STG2_HOLD Configures the hold time of RTC watchdog at level 3. (R/W)

Register 10.36. RTC_CNTL_RTC_WDTCONFIG4_REG (0x00A8)

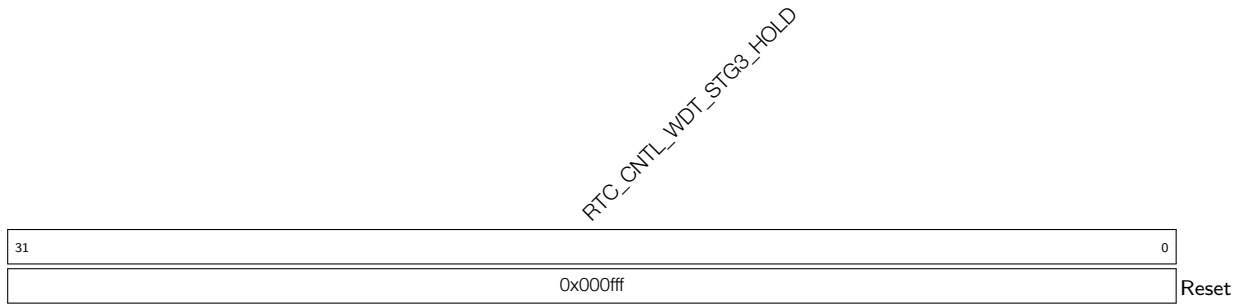

RTC_CNTL_WDT_STG3_HOLD Configures the hold time of RTC watchdog at level 4. (R/W)

Register 10.37. RTC_CNTL_RTC_WDTFEED_REG (0x00AC)

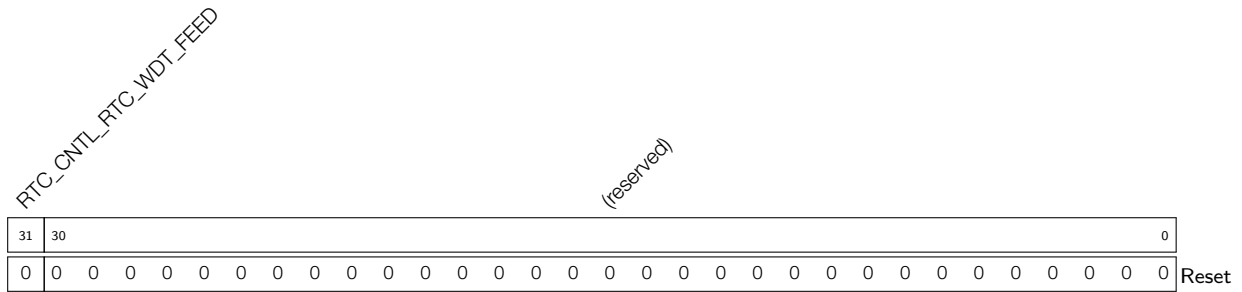

RTC_CNTL_RTC_WDT_FEED Set 1 to feed the RTC watchdog. (WO)

Register 10.38. RTC_CNTL_RTC_WDTWPROTECT_REG (0x00B0)



RTC_CNTL_WDT_WKEY Sets the write protection key of the watchdog. (R/W)

Register 10.39. RTC_CNTL_RTC_SWD_CONF_REG (0x00B4)

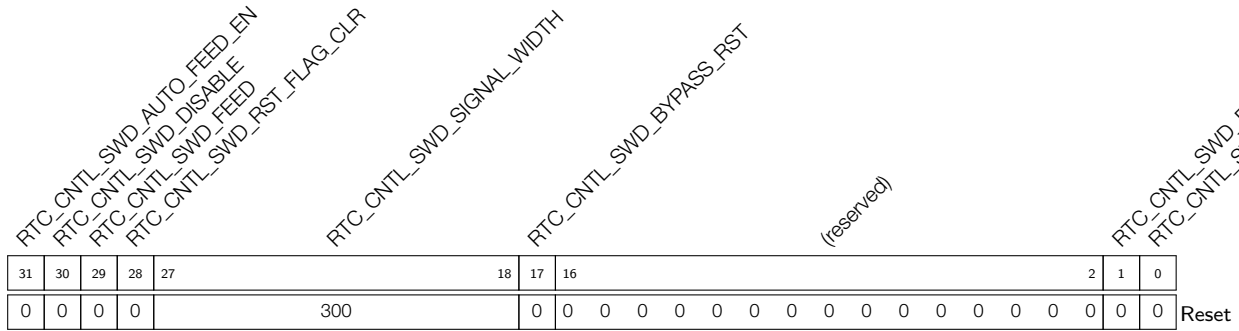

- RTC_CNTL_SWD_RESET_FLAG** Indicates the super watchdog reset flag. (RO)
- RTC_CNTL_SWD_FEED_INT** Receiving this interrupt leads to feeding the super watchdog via SW. (RO)
- RTC_CNTL_SWD_BYPASS_RST** Set this bit to enable super watchdog reset. (R/W)
- RTC_CNTL_SWD_SIGNAL_WIDTH** Adjusts the signal width sent to the super watchdog. (R/W)
- RTC_CNTL_SWD_RST_FLAG_CLR** Set to reset the super watchdog reset flag. (WO)
- RTC_CNTL_SWD_FEED** Set to feed the super watchdog via SW. (WO)
- RTC_CNTL_SWD_DISABLE** Set this bit to disable super watchdog. (R/W)
- RTC_CNTL_SWD_AUTO_FEED_EN** Set this bit to enable automatic watchdog feeding upon interrupts. (R/W)

Register 10.40. RTC_CNTL_RTC_SWD_WPROTECT_REG (0x00B8)

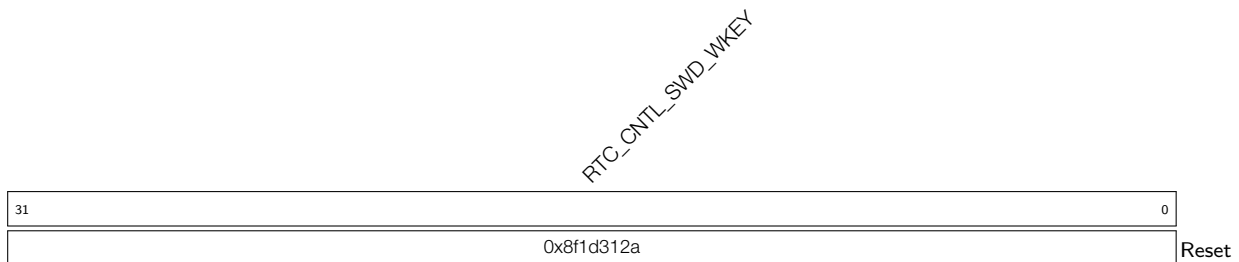

- RTC_CNTL_SWD_WKEY** Sets the write protection key of the super watchdog. (R/W)

Register 10.41. RTC_CNTL_RTC_SW_CPU_STALL_REG (0x00BC)

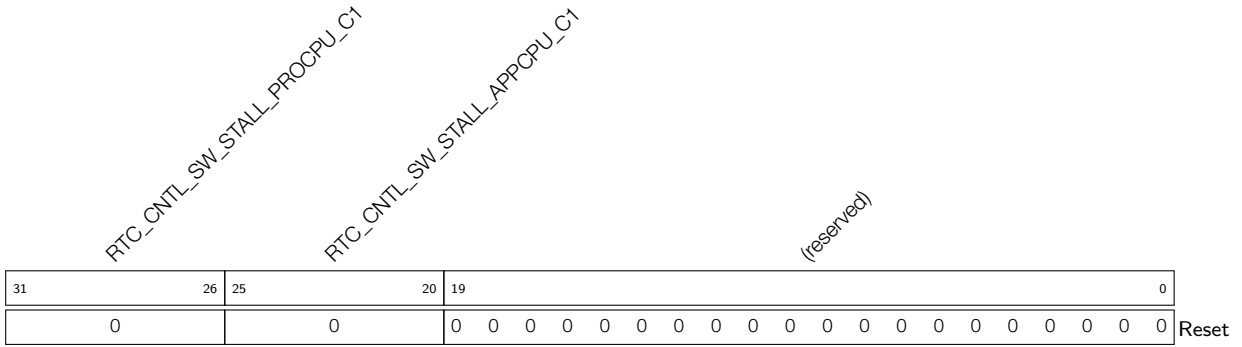

RTC_CNTL_SW_STALL_APPCPU_C1 Set this bit to allow the SW to be able to send the CPU0 into stalling. (R/W)

RTC_CNTL_SW_STALL_PROCPU_C1 Set this bit to allow the SW to be able to send the CPU1 into stalling. (R/W)

Register 10.42. RTC_CNTL_RTC_STORE4_REG (0x00C0)

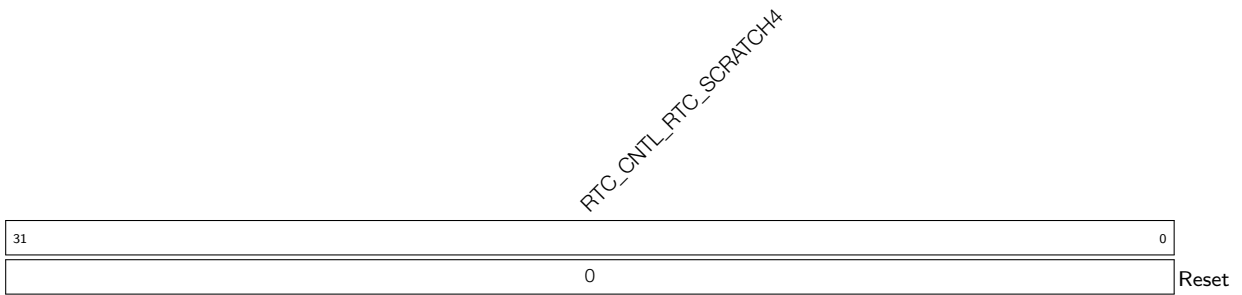

RTC_CNTL_RTC_SCRATCH4 Retention register 4. (R/W)

Register 10.43. RTC_CNTL_RTC_STORE5_REG (0x00C4)

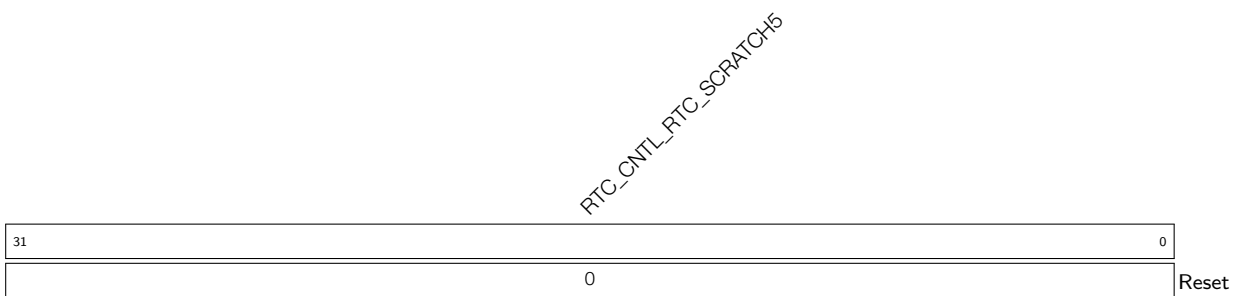

RTC_CNTL_RTC_SCRATCH5 Retention register 5. (R/W)

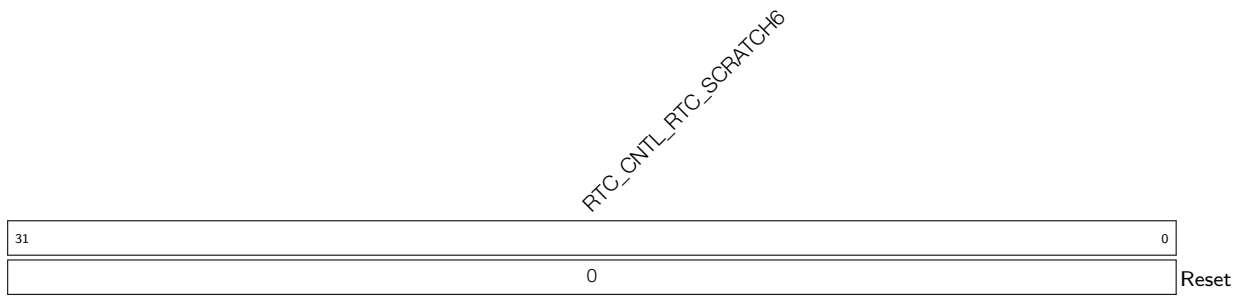
Register 10.44. RTC_CNTL_RTC_STORE6_REG (0x00C8)

RTC_CNTL_RTC_SCRATCH6 Retention register 6. (R/W)

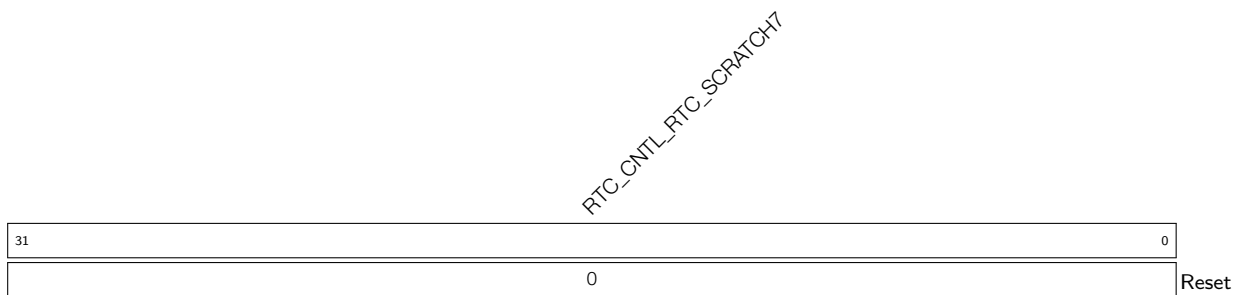
Register 10.45. RTC_CNTL_RTC_STORE7_REG (0x00CC)

RTC_CNTL_RTC_SCRATCH7 Retention register 7. (R/W)

Register 10.46. RTC_CNTL_RTC_LOW_POWER_ST_REG (0x00D0)

(reserved)				RTC_CNTL_MAIN_STATE_IN_IDLE				(reserved)				RTC_CNTL_RTC_RDY_FOR_WAKEUP				(reserved)													
31	28	27	26	25	24	23	22	21	20	19	18	17	16	15	14	13	12	11	10	9	8	7	6	5	4	3	2	1	0
0	0	0	0	0	0	0	0	0	0	0	0	0	0	0	0	0	0	0	0	0	0	0	0	0	0	0	0	0	0

Reset

RTC_CNTL_RTC_RDY_FOR_WAKEUP Indicates the RTC is ready to be triggered by any wakeup source. (RO)

RTC_CNTL_MAIN_STATE_IN_IDLE Indicates the RTC state.

- 0: the chip can be either
 - in sleep modes.
 - entering sleep modes. In this case, wait until [RTC_CNTL_RTC_RDY_FOR_WAKEUP](#) bit is set, then you can wake up the chip.
 - exiting sleep mode. In this case, [RTC_CNTL_MAIN_STATE_IN_IDLE](#) will eventually become 1.
- 1: the chip is not in sleep modes (i.e. running normally).

Register 10.47. RTC_CNTL_RTC_PAD_HOLD_REG (0x00D8)

(reserved)										RTC_CNTL_RTC_PAD21_HOLD RTC_CNTL_RTC_PAD20_HOLD RTC_CNTL_RTC_PAD19_HOLD RTC_CNTL_PDAC2_HOLD RTC_CNTL_PDAC1_HOLD RTC_CNTL_X32N_HOLD RTC_CNTL_X32P_HOLD RTC_CNTL_TOUCH_PAD14_HOLD RTC_CNTL_TOUCH_PAD13_HOLD RTC_CNTL_TOUCH_PAD12_HOLD RTC_CNTL_TOUCH_PAD11_HOLD RTC_CNTL_TOUCH_PAD10_HOLD RTC_CNTL_TOUCH_PAD9_HOLD RTC_CNTL_TOUCH_PAD8_HOLD RTC_CNTL_TOUCH_PAD7_HOLD RTC_CNTL_TOUCH_PAD6_HOLD RTC_CNTL_TOUCH_PAD5_HOLD RTC_CNTL_TOUCH_PAD4_HOLD RTC_CNTL_TOUCH_PAD3_HOLD RTC_CNTL_TOUCH_PAD2_HOLD RTC_CNTL_TOUCH_PAD0_HOLD															
31	22	21	20	19	18	17	16	15	14	13	12	11	10	9	8	7	6	5	4	3	2	1	0	Reset	
0	0	0	0	0	0	0	0	0	0	0	0	0	0	0	0	0	0	0	0	0	0	0	0	0	0

- RTC_CNTL_TOUCH_PAD0_HOLD** Sets the touch GPIO 0 to hold. (R/W)
- RTC_CNTL_TOUCH_PAD1_HOLD** Sets the touch GPIO 1 to hold. (R/W)
- RTC_CNTL_TOUCH_PAD2_HOLD** Sets the touch GPIO 2 to hold. (R/W)
- RTC_CNTL_TOUCH_PAD3_HOLD** Sets the touch GPIO 3 to hold. (R/W)
- RTC_CNTL_TOUCH_PAD4_HOLD** Sets the touch GPIO 4 to hold. (R/W)
- RTC_CNTL_TOUCH_PAD5_HOLD** Sets the touch GPIO 5 to hold. (R/W)
- RTC_CNTL_TOUCH_PAD6_HOLD** Sets the touch GPIO 6 to hold. (R/W)
- RTC_CNTL_TOUCH_PAD7_HOLD** Sets the touch GPIO 7 to hold. (R/W)
- RTC_CNTL_TOUCH_PAD8_HOLD** Sets the touch GPIO 8 to hold. (R/W)
- RTC_CNTL_TOUCH_PAD9_HOLD** Sets the touch GPIO 9 to hold. (R/W)
- RTC_CNTL_TOUCH_PAD10_HOLD** Sets the touch GPIO 10 to hold. (R/W)
- RTC_CNTL_TOUCH_PAD11_HOLD** Sets the touch GPIO 11 to hold. (R/W)
- RTC_CNTL_TOUCH_PAD12_HOLD** Sets the touch GPIO 12 to hold. (R/W)

Continued on the next page...

Register 10.47. RTC_CNTL_RTC_PAD_HOLD_REG (0x00D8)

Continued from the previous page...

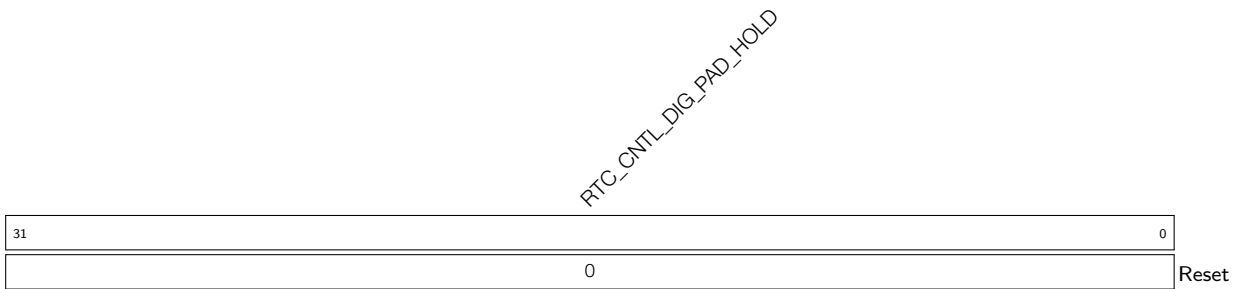
RTC_CNTL_TOUCH_PAD13_HOLD Sets the touch GPIO 13 to hold. (R/W)**RTC_CNTL_TOUCH_PAD14_HOLD** Sets the touch GPIO 14 to hold. (R/W)**RTC_CNTL_X32P_HOLD** Sets the x32p to hold. (R/W)**RTC_CNTL_X32N_HOLD** Sets the x32n to hold. (R/W)**RTC_CNTL_PDAC1_HOLD** Sets the pdac1 to hold. (R/W)**RTC_CNTL_PDAC2_HOLD** Sets the pdac2 to hold. (R/W)**RTC_CNTL_RTC_PAD19_HOLD** Sets the RTG GPIO 19 to hold. (R/W)**RTC_CNTL_RTC_PAD20_HOLD** Sets the RTG GPIO 20 to hold. (R/W)**RTC_CNTL_RTC_PAD21_HOLD** Sets the RTG GPIO 21 to hold. (R/W)**Register 10.48. RTC_CNTL_DIG_PAD_HOLD_REG (0x00DC)**

RTC_CNTL_DIG_PAD_HOLD Set GPIO 21 to GPIO 45 to hold. (See bitmap to locate any GPIO).
(R/W)

Register 10.49. RTC_CNTL_RTC_EXT_WAKEUP1_REG (0x00E0)

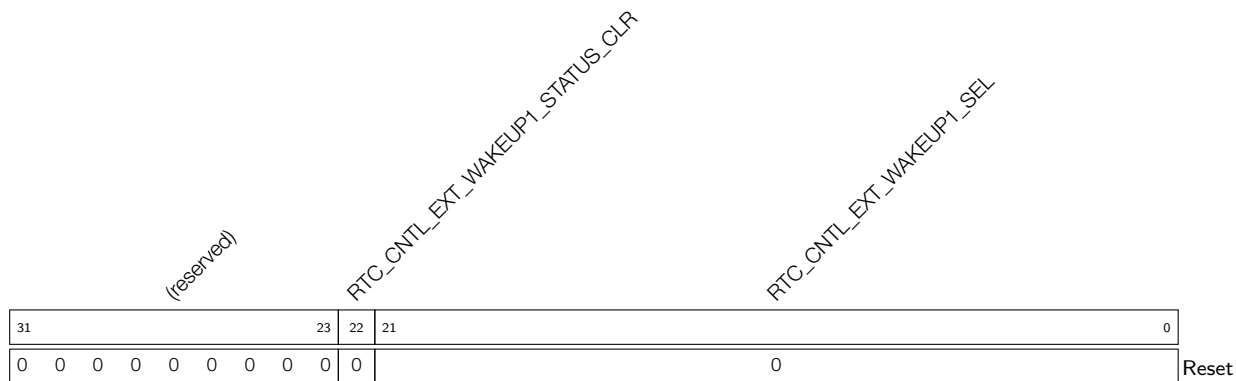

RTC_CNTL_EXT_WAKEUP1_SEL Selects a RTC GPIO to be the EXT1 wakeup source. (R/W)

RTC_CNTL_EXT_WAKEUP1_STATUS_CLR Clears the EXT1 wakeup status. (WO)

Register 10.50. RTC_CNTL_RTC_EXT_WAKEUP1_STATUS_REG (0x00E4)

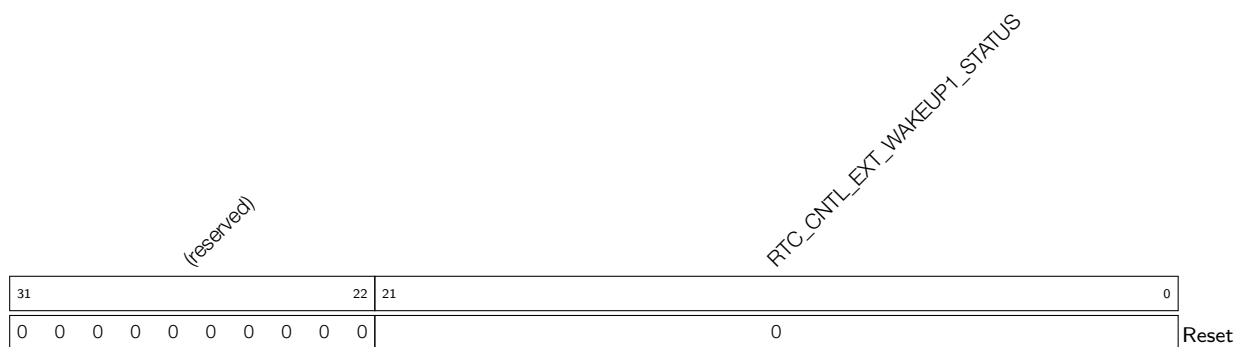

RTC_CNTL_EXT_WAKEUP1_STATUS Indicates the EXT1 wakeup status. (RO)

Register 10.51. RTC_CNTL_RTC_BROWN_OUT_REG (0x00E8)

RTC_CNTL_RTC_BROWN_OUT_DET						RTC_CNTL_BROWN_OUT_RST_WAIT						RTC_CNTL_BROWN_OUT_PD_RF_ENA						RTC_CNTL_BROWN_OUT_INT_WAIT						(reserved)											
RTC_CNTL_BROWN_OUT_ENA						RTC_CNTL_BROWN_OUT_RST_SEL						RTC_CNTL_BROWN_OUT_CLOSE_FLASH_ENA						RTC_CNTL_BROWN_OUT_RST_ENA						RTC_CNTL_BROWN_OUT_ANA_RST_EN						RTC_CNTL_BROWN_OUT_CNT_CLR					
31	30	29	28	27	26	25							16	15	14	13							4	3							0				
0	1	0	0	0	0	0x3ff						0	0	0x1						0	0	0	0	Reset											

RTC_CNTL_BROWN_OUT_INT_WAIT Configures the waiting cycle before sending an interrupt. (R/W)

RTC_CNTL_BROWN_OUT_CLOSE_FLASH_ENA Set this bit to enable PD the flash when a brown-out happens. (R/W)

RTC_CNTL_BROWN_OUT_PD_RF_ENA Set this bit to enable PD the RF circuits when a brown-out happens. (R/W)

RTC_CNTL_BROWN_OUT_RST_WAIT Configures the waiting cycle before the reset after a brown-out. (R/W)

RTC_CNTL_BROWN_OUT_RST_ENA Enables to reset brown-out. (R/W)

RTC_CNTL_BROWN_OUT_RST_SEL Selects the reset type when a brown-out happens. 1: Chip reset 0: System reset. (R/W)

RTC_CNTL_BROWN_OUT_ANA_RST_EN Enables brown-out detector reset. (R/W)

RTC_CNTL_BROWN_OUT_CNT_CLR Clears the brown-out counter. (WO)

RTC_CNTL_BROWN_OUT_ENA Set this bit to enable brown-out detection. (R/W)

RTC_CNTL_RTC_BROWN_OUT_DET Indicates the status of the brown-out signal. (RO)

Register 10.52. RTC_CNTL_RTC_TIME_LOW1_REG (0x00EC)

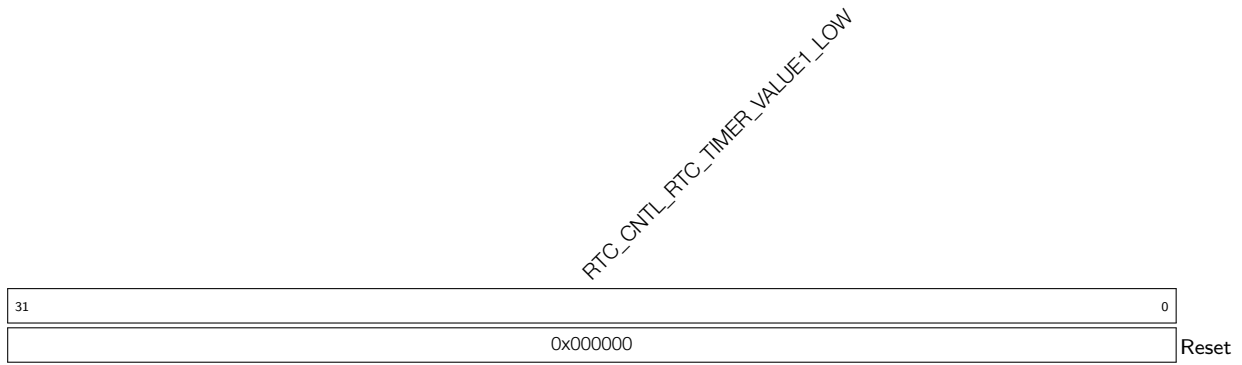

RTC_CNTL_RTC_TIMER_VALUE1_LOW Stores the lower 32 bits of RTC timer 1. (RO)

Register 10.53. RTC_CNTL_RTC_TIME_HIGH1_REG (0x00F0)

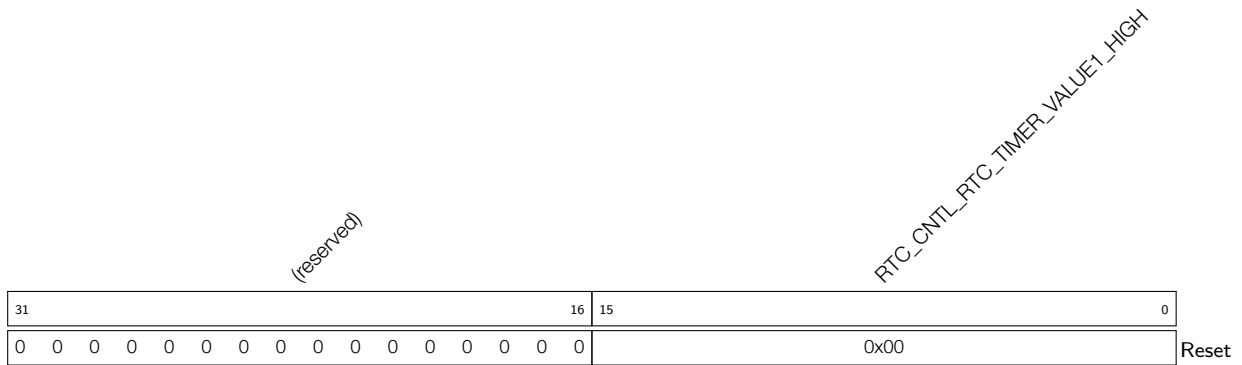

RTC_CNTL_RTC_TIMER_VALUE1_HIGH Stores the higher 16 bits of RTC timer 1. (RO)

Register 10.54. RTC_CNTL_RTC_XTAL32K_CLK_FACTOR_REG (0x00F4)

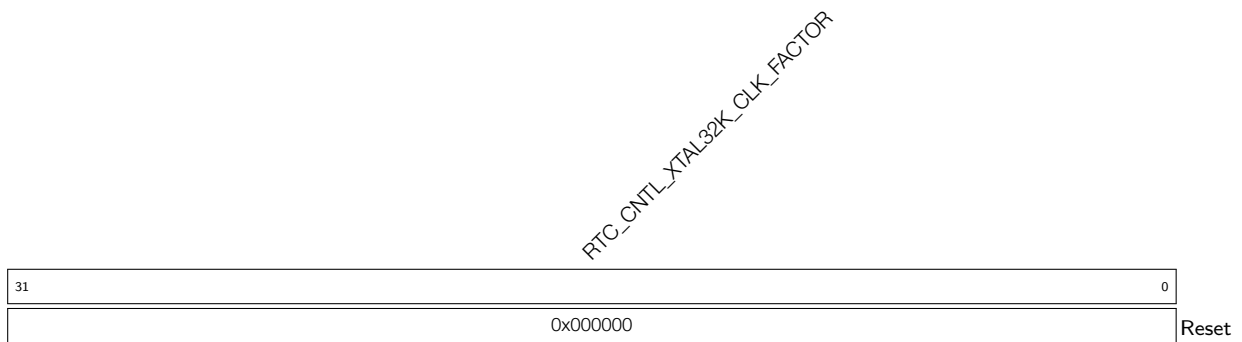

RTC_CNTL_XTAL32K_CLK_FACTOR Configures the divider factor for the 32 kHz crystal oscillator. (R/W)

Register 10.55. RTC_CNTL_RTC_XTAL32K_CONF_REG (0x00F8)

RTC_CNTL_XTAL32K_STABLE_THRES		RTC_CNTL_XTAL32K_WDT_TIMEOUT				RTC_CNTL_XTAL32K_RESTART_WAIT				RTC_CNTL_XTAL32K_RETURN_WAIT				
31	28	27	20	19	4	3	0							
0x0		0xff				0x00				0x0				Reset

RTC_CNTL_XTAL32K_RETURN_WAIT Defines the waiting cycles before returning to the normal 32 kHz crystal oscillator. (R/W)

RTC_CNTL_XTAL32K_RESTART_WAIT Defines the maximum waiting cycle before restarting the 32 kHz crystal oscillator. (R/W)

RTC_CNTL_XTAL32K_WDT_TIMEOUT Defines the maximum waiting period for clock detection. If no clock is detected after this period, the 32 kHz crystal oscillator can be regarded as dead. (R/W)

RTC_CNTL_XTAL32K_STABLE_THRES Defines the maximum allowed restarting period, within which the 32 kHz crystal oscillator can be regarded as stable. (R/W)

Register 10.56. RTC_CNTL_RTC_USB_CONF_REG (0x0120)

(reserved)											<div style="display: flex; justify-content: space-between;"> <div style="writing-mode: vertical-rl; transform: rotate(180deg);">RTC_CNTL_SW_HW_USB_PHY_SEL</div> <div style="writing-mode: vertical-rl; transform: rotate(180deg);">RTC_CNTL_SW_USB_PHY_SEL</div> <div style="writing-mode: vertical-rl; transform: rotate(180deg);">RTC_CNTL_IO_MUX_RESET_DISABLE</div> <div style="writing-mode: vertical-rl; transform: rotate(180deg);">RTC_CNTL_USB_RESET_DISABLE</div> <div style="writing-mode: vertical-rl; transform: rotate(180deg);">RTC_CNTL_USB_TX_EN_OVERRIDE</div> <div style="writing-mode: vertical-rl; transform: rotate(180deg);">RTC_CNTL_USB_TX_EN</div> <div style="writing-mode: vertical-rl; transform: rotate(180deg);">RTC_CNTL_USB_TXP</div> <div style="writing-mode: vertical-rl; transform: rotate(180deg);">RTC_CNTL_USB_TXM</div> <div style="writing-mode: vertical-rl; transform: rotate(180deg);">RTC_CNTL_USB_PAD_ENABLE</div> <div style="writing-mode: vertical-rl; transform: rotate(180deg);">RTC_CNTL_USB_PAD_PULLUP_OVERRIDE</div> <div style="writing-mode: vertical-rl; transform: rotate(180deg);">RTC_CNTL_USB_DM_PULLUP_OVERRIDE</div> <div style="writing-mode: vertical-rl; transform: rotate(180deg);">RTC_CNTL_USB_DM_PULLDOWN</div> <div style="writing-mode: vertical-rl; transform: rotate(180deg);">RTC_CNTL_USB_DP_PULLUP</div> <div style="writing-mode: vertical-rl; transform: rotate(180deg);">RTC_CNTL_USB_DP_PULLDOWN</div> <div style="writing-mode: vertical-rl; transform: rotate(180deg);">RTC_CNTL_USB_PAD_PULL_OVERRIDE</div> <div style="writing-mode: vertical-rl; transform: rotate(180deg);">RTC_CNTL_USB_VREF_OVERRIDE</div> </div>																					
31											21	20	19	18	17	16	15	14	13	12	11	10	9	8	7	6	5	4	3	2	1	0
0																	0										Reset					

RTC_CNTL_USB_VREFH Controls the internal USB transceiver single-end input high threshold (1.76 V to 2 V, step 80 mV). This field is valid when [RTC_CNTL_USB_VREF_OVERRIDE](#) is set. (R/W)

RTC_CNTL_USB_VREFL Controls the internal USB transceiver single-end input low threshold (0.8 V to 1.04 V, step 80 mV). This field is valid when [RTC_CNTL_USB_VREF_OVERRIDE](#) is set. (R/W)

RTC_CNTL_USB_VREF_OVERRIDE Set this bit to enable controlling the internal USB transceiver’s input voltage threshold via software. (R/W)

RTC_CNTL_USB_PAD_PULL_OVERRIDE Set this bit to enable software controlling the internal USB transceiver’s USB D+/D- pull-up and pull-down resistor via software. (R/W)

RTC_CNTL_USB_DP_PULLUP Set this bit to enable USB+ pull-up resistor. This field is valid when [RTC_CNTL_USB_PAD_PULL_OVERRIDE](#) is set. (R/W)

RTC_CNTL_USB_DP_PULLDOWN Set this bit to enable USB+ pull-down resistor. This field is valid when [RTC_CNTL_USB_PAD_PULL_OVERRIDE](#) is set. (R/W)

RTC_CNTL_USB_DM_PULLUP Set this bit to enable USB- pull-up resistor. This field is valid when [RTC_CNTL_USB_PAD_PULL_OVERRIDE](#) is set. (R/W)

RTC_CNTL_USB_DM_PULLDOWN Set this bit to enable USB- pull-down resistor. This field is valid when [RTC_CNTL_USB_PAD_PULL_OVERRIDE](#) is set. (R/W)

RTC_CNTL_USB_PULLUP_VALUE Controls the pull-up value. 0: typical value is 2.4K; 1: typical value is 1.2K. This field is valid when [RTC_CNTL_USB_PAD_PULL_OVERRIDE](#) is set. (R/W)

Continued on the next page...

Register 10.56. RTC_CNTL_RTC_USB_CONF_REG (0x0120)

Continued from the previous page...

RTC_CNTL_USB_PAD_ENABLE_OVERRIDE Set this bit to enable controlling the internal USB transceiver's function via software. (R/W)

RTC_CNTL_USB_PAD_ENABLE Set this bit to enable the USB transceiver function. This field is valid when [RTC_CNTL_USB_PAD_ENABLE_OVERRIDE](#) is set. (R/W)

RTC_CNTL_USB_TXM Configures the USB D- tx value in test mode. This field is valid when [RTC_CNTL_USB_TX_EN_OVERRIDE](#) is set.(R/W)

RTC_CNTL_USB_TXP Configures the USB D+ tx value in test mode. This field is valid when [RTC_CNTL_USB_TX_EN_OVERRIDE](#) is set.(R/W)

RTC_CNTL_USB_TX_EN Configures the USB pad oen in test mode. This field is valid when [RTC_CNTL_USB_TX_EN_OVERRIDE](#) is set. (R/W)

RTC_CNTL_USB_TX_EN_OVERRIDE Set this bit to enable controlling the internal USB transceiver Tx in test mode via software. (R/W)

RTC_CNTL_USB_RESET_DISABLE Set this bit to disable reset USB OTG. (R/W)

RTC_CNTL_IO_MUX_RESET_DISABLE Set this bit to disable reset IO MUX and GPIO Matrix. (R/W)

RTC_CNTL_SW_USB_PHY_SEL Set this bit to allow USB OTG to use the internal USB transceiver. Clear this bit to allow USB-Serial-JTAG to use the internal USB transceiver. This field is valid when [RTC_CNTL_SW_HW_USB_PHY_SEL](#) is set. (R/W)

RTC_CNTL_SW_HW_USB_PHY_SEL Set this bit to control the internal USB transceiver selection via software ([RTC_CNTL_SW_USB_PHY_SEL](#)). Clear this bit to control the the internal USB transceiver selection via hardware(efuse). (R/W)

Register 10.57. RTC_CNTL_RTC_SLP_REJECT_CAUSE_REG (0x0128)

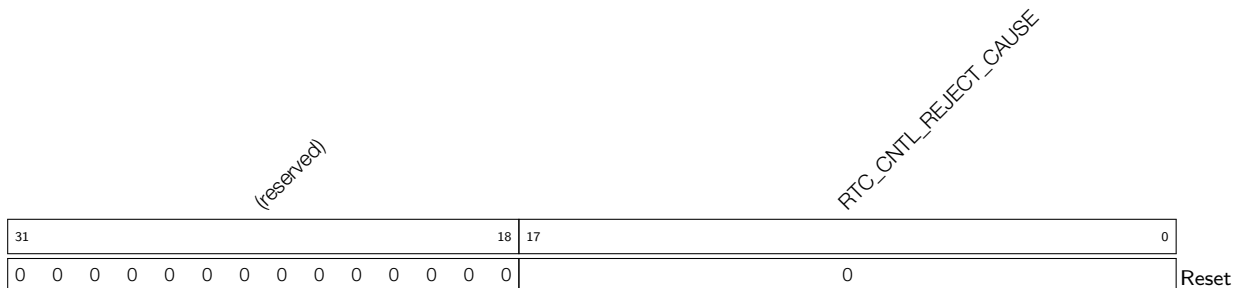

RTC_CNTL_REJECT_CAUSE Stores the reject-to-sleep cause. (RO)

Register 10.58. RTC_CNTL_RTC_OPTION1_REG (0x012C)

(reserved)																RTC_CNTL_FORCE_DOWNLOAD_BOOT															
31																												1	0		
0 0																0															Reset

RTC_CNTL_FORCE_DOWNLOAD_BOOT Set this bit to force chip enters download boot by sw. (R/W)

Register 10.59. RTC_CNTL_RTC_SLP_WAKEUP_CAUSE_REG (0x0130)

(reserved)																RTC_CNTL_WAKEUP_CAUSE																	
31																17	16																0
0 0 0 0 0 0 0 0 0 0 0 0 0 0 0 0																0															Reset		

RTC_CNTL_WAKEUP_CAUSE Stores the wakeup cause. (RO)

Register 10.60. RTC_CNTL_INT_ENA_RTC_W1TS_REG (0x0138)

(reserved)																					RTC_CNTL_RTC_TOUCH_APPROACH_LOOP_DONE_INT_ENA_W1TS RTC_CNTL_RTC_TOUCH_GLITCH_DET_INT_ENA_W1TS RTC_CNTL_RTC_TOUCH_TRAP_INT_ENA_W1TS RTC_CNTL_RTC_COOPU_TRAP_INT_ENA_W1TS RTC_CNTL_RTC_XTAL32K_INT_ENA_W1TS RTC_CNTL_RTC_SWD_DEAD_INT_ENA_W1TS RTC_CNTL_RTC_SARADC2_INT_ENA_W1TS RTC_CNTL_RTC_TSENS_INT_ENA_W1TS RTC_CNTL_RTC_SARADC1_INT_ENA_W1TS RTC_CNTL_RTC_MAIN_TIMER_OUT_INT_ENA_W1TS RTC_CNTL_RTC_TOUCH_INACTIVE_INT_ENA_W1TS RTC_CNTL_RTC_TOUCH_ACTIVE_INT_ENA_W1TS RTC_CNTL_RTC_ULP_CP_INT_ENA_W1TS RTC_CNTL_RTC_TOUCH_SCAN_DONE_INT_ENA_W1TS RTC_CNTL_SDIO_IDLE_INT_ENA_W1TS RTC_CNTL_SLP_REJECT_INT_ENA_W1TS RTC_CNTL_SLP_WAKEUP_INT_ENA_W1TS																				
31	21	20	19	18	17	16	15	14	13	12	11	10	9	8	7	6	5	4	3	2	1	0																			
0	0	0	0	0	0	0	0	0	0	0	0	0	0	0	0	0	0	0	0	0	0	0																			

Reset

RTC_CNTL_SLP_WAKEUP_INT_ENA_W1TS Enables interrupt when the chip wakes up from sleep. If the value 1 is written to this bit, the [RTC_CNTL_SLP_WAKEUP_INT_ENA](#) field will be set to 1. (WO)

RTC_CNTL_SLP_REJECT_INT_ENA_W1TS Enables interrupt when the chip rejects to go to sleep. If the value 1 is written to this bit, the [RTC_CNTL_SLP_REJECT_INT_ENA](#) field will be set to 1. (WO)

RTC_CNTL_SDIO_IDLE_INT_ENA_W1TS Enables interrupt when the SDIO idles. If the value 1 is written to this bit, the [RTC_CNTL_SDIO_IDLE_INT_ENA](#) field will be set to 1. (WO)

RTC_CNTL_RTC_WDT_INT_ENA_W1TS Enables the RTC watchdog interrupt. If the value 1 is written to this bit, the [RTC_CNTL_RTC_WDT_INT_ENA](#) field will be set to 1. (WO)

RTC_CNTL_RTC_TOUCH_SCAN_DONE_INT_ENA_W1TS Enables interrupt upon the completion of a touch scanning. If the value 1 is written to this bit, the [RTC_CNTL_RTC_TOUCH_SCAN_DONE_INT_ENA](#) field will be set to 1. (WO)

RTC_CNTL_RTC_ULP_CP_INT_ENA_W1TS Enables the ULP co-processor interrupt. If the value 1 is written to this bit, the [RTC_CNTL_RTC_ULP_CP_INT_ENA](#) field will be set to 1. (WO)

RTC_CNTL_RTC_TOUCH_DONE_INT_ENA_W1TS Enables interrupt upon the completion of a single touch. If the value 1 is written to this bit, the [RTC_CNTL_RTC_TOUCH_DONE_INT_ENA](#) field will be set to 1. (WO)

RTC_CNTL_RTC_TOUCH_ACTIVE_INT_ENA_W1TS Enables interrupt when a touch is detected. If the value 1 is written to this bit, the [RTC_CNTL_RTC_TOUCH_ACTIVE_INT_ENA](#) field will be set to 1. (WO)

RTC_CNTL_RTC_TOUCH_INACTIVE_INT_ENA_W1TS Enables interrupt when a touch is released. If the value 1 is written to this bit, the [RTC_CNTL_RTC_TOUCH_ACTIVE_INT_ENA](#) field will be set to 1. (WO)

Continued on the next page...

Register 10.60. RTC_CNTL_INT_ENA_RTC_W1TS_REG (0x0138)

Continued from the previous page...

RTC_CNTL_RTC_BROWN_OUT_INT_ENA_W1TS Enables the brown out interrupt. If the value 1 is written to this bit, the [RTC_CNTL_RTC_BROWN_OUT_INT_ENA](#) field will be set to 1. (WO)

RTC_CNTL_RTC_MAIN_TIMER_INT_ENA_W1TS Enables the RTC main timer interrupt. If the value 1 is written to this bit, the [RTC_CNTL_RTC_MAIN_TIMER_INT_ENA](#) field will be set to 1. (WO)

RTC_CNTL_RTC_SARADC1_INT_ENA_W1TS Enables the SAR ADC1 interrupt. If the value 1 is written to this bit, the [RTC_CNTL_RTC_SARADC1_INT_ENA](#) field will be set to 1. (WO)

RTC_CNTL_RTC_TSENS_INT_ENA_W1TS Enables the temperature sensor interrupt. If the value 1 is written to this bit, the [RTC_CNTL_RTC_TSENS_INT_ENA](#) field will be set to 1. (WO)

RTC_CNTL_RTC_COCPU_INT_ENA_W1TS Enables the ULP-RISCV interrupt. If the value 1 is written to this bit, the [RTC_CNTL_RTC_COCPU_INT_ENA](#) field will be set to 1. (WO)

RTC_CNTL_RTC_SARADC2_INT_ENA_W1TS Enables the SAR ADC2 interrupt. If the value 1 is written to this bit, the [RTC_CNTL_RTC_SARADC2_INT_ENA](#) field will be set to 1. (WO)

RTC_CNTL_RTC_SWD_INT_ENA_W1TS Enables the super watchdog interrupt. If the value 1 is written to this bit, the [RTC_CNTL_RTC_SWD_INT_ENA](#) field will be set to 1. (WO)

RTC_CNTL_RTC_XTAL32K_DEAD_INT_ENA_W1TS Enables interrupt when the 32 kHz crystal is dead. If the value 1 is written to this bit, the [RTC_CNTL_RTC_XTAL32K_DEAD_INT_ENA](#) field will be set to 1. (WO)

RTC_CNTL_RTC_COCPU_TRAP_INT_ENA_W1TS Enables interrupt when the ULP-RISCV is trapped. If the value 1 is written to this bit, the [RTC_CNTL_RTC_COCPU_TRAP_INT_ENA](#) field will be set to 1. (WO)

RTC_CNTL_RTC_TOUCH_TIMEOUT_INT_ENA_W1TS Enables interrupt when touch sensor times out. If the value 1 is written to this bit, the [RTC_CNTL_RTC_TOUCH_TIMEOUT_INT_ENA](#) field will be set to 1. (WO)

RTC_CNTL_RTC_GLITCH_DET_INT_ENA_W1TS Enables interrupt when a glitch is detected. If the value 1 is written to this bit, the [RTC_CNTL_RTC_GLITCH_DET_INT_ENA](#) field will be set to 1. (WO)

RTC_CNTL_RTC_TOUCH_APPROACH_LOOP_DONE_INT_ENA_W1TS Enables interrupt upon the completion of a touch approach loop. If the value 1 is written to this bit, the [RTC_CNTL_RTC_TOUCH_APPROACH_LOOP_DONE_INT_ENA](#) field will be set to 1. (WO)

Register 10.61. RTC_CNTL_INT_ENA_RTC_W1TC_REG (0x013C)

(reserved)											RTC_CNTL_RTC_TOUCH_APPROACH_LOOP_DONE_INT_ENA_W1TC RTC_CNTL_RTC_TOUCH_GLITCH_DET_INT_ENA_W1TC RTC_CNTL_RTC_TOUCH_TRAP_INT_ENA_W1TC RTC_CNTL_RTC_XTAL32K_DEAD_INT_ENA_W1TC RTC_CNTL_RTC_SWD_INT_ENA_W1TC RTC_CNTL_RTC_SAPADC2_INT_ENA_W1TC RTC_CNTL_RTC_TSENS_INT_ENA_W1TC RTC_CNTL_RTC_SAPADC1_INT_ENA_W1TC RTC_CNTL_RTC_MAIN_TIMER_INT_ENA_W1TC RTC_CNTL_RTC_TOUCH_INACTIVE_INT_ENA_W1TC RTC_CNTL_RTC_ULP_CP_INT_ENA_W1TC RTC_CNTL_RTC_TOUCH_SCAN_DONE_INT_ENA_W1TC RTC_CNTL_SDIO_IDLE_INT_ENA_W1TC RTC_CNTL_SLP_REJECT_INT_ENA_W1TC RTC_CNTL_SLP_WAKEUP_INT_ENA_W1TC																			
31	21	20	19	18	17	16	15	14	13	12	11	10	9	8	7	6	5	4	3	2	1	0	Reset							
0	0	0	0	0	0	0	0	0	0	0	0	0	0	0	0	0	0	0	0	0	0	0	0	Reset						

RTC_CNTL_SLP_WAKEUP_INT_ENA_W1TC Clears the interrupt triggered when the chip wakes up from sleep. If the value 1 is written to this bit, the [RTC_CNTL_SLP_WAKEUP_INT_CLR](#) field will be cleared. (WO)

RTC_CNTL_SLP_REJECT_INT_ENA_W1TC Clears the interrupt triggered when the chip rejects to go to sleep. If the value 1 is written to this bit, the [RTC_CNTL_SLP_REJECT_INT_CLR](#) field will be cleared. (WO)

RTC_CNTL_SDIO_IDLE_INT_ENA_W1TC Clears the interrupt triggered when the SDIO idles. If the value 1 is written to this bit, the [RTC_CNTL_SDIO_IDLE_INT_CLR](#) field will be cleared. (WO)

RTC_CNTL_RTC_WDT_INT_ENA_W1TC Clears the RTC watchdog interrupt. If the value 1 is written to this bit, the [RTC_CNTL_RTC_WDT_INT_CLR](#) field will be cleared. (WO)

RTC_CNTL_RTC_TOUCH_SCAN_DONE_INT_ENA_W1TC Clears the interrupt triggered upon the completion of a touch scanning. If the value 1 is written to this bit, the [RTC_CNTL_RTC_TOUCH_SCAN_DONE_INT_CLR](#) field will be cleared. (WO)

RTC_CNTL_RTC_ULP_CP_INT_ENA_W1TC Clears the ULP co-processor interrupt. If the value 1 is written to this bit, the [RTC_CNTL_RTC_ULP_CP_INT_CLR](#) field will be cleared. (WO)

RTC_CNTL_RTC_TOUCH_DONE_INT_ENA_W1TC Clears the interrupt triggered upon the completion of a single touch. If the value 1 is written to this bit, the [RTC_CNTL_RTC_TOUCH_DONE_INT_CLR](#) field will be cleared. (WO)

RTC_CNTL_RTC_TOUCH_ACTIVE_INT_ENA_W1TC Clears the interrupt triggered when a touch is detected. If the value 1 is written to this bit, the [RTC_CNTL_RTC_TOUCH_ACTIVE_INT_CLR](#) field will be cleared. (WO)

Continued on the next page...

Register 10.61. RTC_CNTL_INT_ENA_RTC_W1TC_REG (0x013C)

Continued from the previous page...

RTC_CNTL_RTC_TOUCH_INACTIVE_INT_ENA_W1TC Clears the interrupt triggered when a touch is released. If the value 1 is written to this bit, the [RTC_CNTL_RTC_TOUCH_INACTIVE_INT_CLR](#) field will be cleared. (WO)

RTC_CNTL_RTC_BROWN_OUT_INT_ENA_W1TC Clears the brown out interrupt. If the value 1 is written to this bit, the [RTC_CNTL_RTC_BROWN_OUT_INT_CLR](#) field will be cleared. (WO)

RTC_CNTL_RTC_MAIN_TIMER_INT_ENA_W1TC Clears the RTC main timer interrupt. If the value 1 is written to this bit, the [RTC_CNTL_RTC_MAIN_TIMER_INT_CLR](#) field will be cleared. (WO)

RTC_CNTL_RTC_SARADC1_INT_ENA_W1TC Clears the SAR ADC1 interrupt. If the value 1 is written to this bit, the [RTC_CNTL_RTC_SARADC1_INT_ENA_CLR](#) field will be cleared. (WO)

RTC_CNTL_RTC_TSENS_INT_ENA_W1TC Clears the temperature sensor interrupt. If the value 1 is written to this bit, the [RTC_CNTL_RTC_TSENS_INT_CLR](#) field will be cleared. (WO)

RTC_CNTL_RTC_COCPU_INT_ENA_W1TC Clears the ULP-RISCV interrupt. If the value 1 is written to this bit, the [RTC_CNTL_RTC_COCPU_INT_CLR](#) field will be cleared. (WO)

RTC_CNTL_RTC_SARADC2_INT_ENA_W1TC Clears the SAR ADC2 interrupt. If the value 1 is written to this bit, the [RTC_CNTL_RTC_SARADC2_INT_CLR](#) field will be cleared. (WO)

RTC_CNTL_RTC_SWD_INT_ENA_W1TC Clears the super watchdog interrupt. If the value 1 is written to this bit, the [RTC_CNTL_RTC_SWD_INT_CLR](#) field will be cleared. (WO)

RTC_CNTL_RTC_XTAL32K_DEAD_INT_ENA_W1TC Clears the interrupt triggered when the 32 kHz crystal is dead. If the value 1 is written to this bit, the [RTC_CNTL_RTC_XTAL32K_DEAD_INT_CLR](#) field will be cleared. (WO)

RTC_CNTL_RTC_COCPU_TRAP_INT_ENA_W1TC Clears the interrupt triggered when the ULP-RISCV is trapped. If the value 1 is written to this bit, the [RTC_CNTL_RTC_COCPU_TRAP_INT_CLR](#) field will be cleared. (WO)

RTC_CNTL_RTC_TOUCH_TIMEOUT_INT_ENA_W1TC Clears the interrupt triggered when touch sensor times out. If the value 1 is written to this bit, the [RTC_CNTL_RTC_TOUCH_TIMEOUT_INT_CLR](#) field will be cleared. (WO)

RTC_CNTL_RTC_GLITCH_DET_INT_ENA_W1TC Clears the interrupt triggered when a glitch is detected. If the value 1 is written to this bit, the [RTC_CNTL_RTC_GLITCH_DET_INT_CLR](#) field will be cleared. (WO)

RTC_CNTL_RTC_TOUCH_APPROACH_LOOP_DONE_INT_ENA_W1TC Clears the interrupt triggered upon the completion of a touch approach loop. If the value 1 is written to this bit, the [RTC_CNTL_RTC_TOUCH_APPROACH_LOOP_DONE_INT_CLR](#) field will be cleared. (WO)

Register 10.62. RTC_CNTL_RETENTION_CTRL_REG (0x0140)

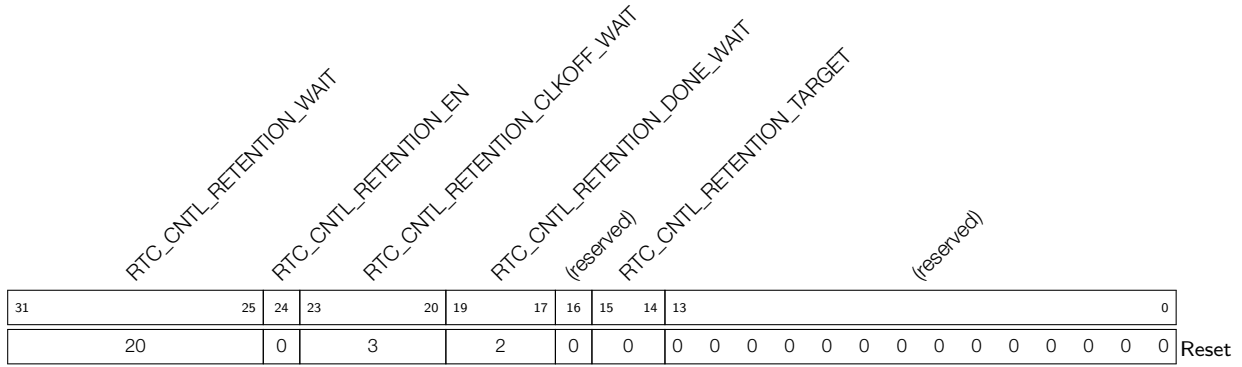

- RTC_CNTL_RETENTION_TARGET** Configures retention target: cpu and/or tag (R/W)
- RTC_CNTL_RETENTION_DONE_WAIT** Configures the waiting cycle before retention done (R/W)
- RTC_CNTL_RETENTION_CLKOFF_WAIT** Configures the waiting cycle before clk_off. (R/W)
- RTC_CNTL_RETENTION_EN** Set this bit to enable retention. (R/W)
- RTC_CNTL_RETENTION_WAIT** Configures the waiting cycles for retention operation. (R/W)

Register 10.63. RTC_CNTL_RTC_FIB_SEL_REG (0x0148)

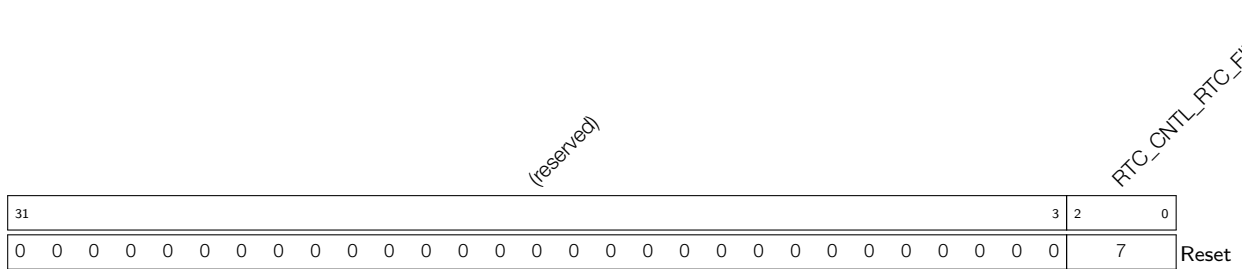

- RTC_CNTL_RTC_FIB_SEL** Configures the brownout detector. (R/W)

11 System Timer (SYSTIMER)

11.1 Overview

ESP32-S3 provides a 52-bit timer, which can be used to generate tick interrupts for operating system, or be used as a general timer to generate periodic interrupts or one-time interrupts. With the help of RTC timer, system timer can account for the period of the ESP32-S3 being in Light-sleep or Deep-sleep.

The timer consists of two counters UNIT0 and UNIT1. The counter values can be monitored by three comparators COMP0, COMP1 and COMP2. See the timer block diagram on Figure 11-1.

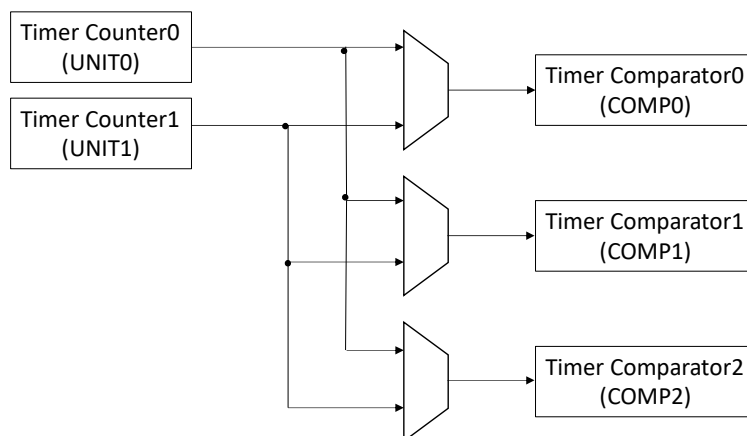

Figure 11-1. System Timer Structure

11.2 Features

- Consist of two 52-bit counters and three 52-bit comparators
- Software accessing registers is clocked by APB_CLK
- Use CNT_CLK for counting, with an average frequency of 16 MHz in two counting cycles
- Use 40 MHz XTAL_CLK as the clock source of CNT_CLK
- Support for 52-bit alarm values (t) and 26-bit alarm periods (δt)
- Provide two modes to generate alarms:
 - Target mode: only a one-time alarm is generated based on the alarm value (t)
 - Period mode: periodic alarms are generated based on the alarm period (δt)
- Three comparators can generate three independent interrupts based on configured alarm value (t) or alarm period (δt)
- Load back sleep time recorded by RTC timer via software after Deep-sleep or Light-sleep
- Can be configured to stall or continue running when CPU stalls or enters on-chip-debugging mode

11.3 Clock Source Selection

The counters and comparators are driven using XTAL_CLK. After scaled by a fractional divider, a $f_{XTAL_CLK}/3$ clock is generated in one count cycle and a $f_{XTAL_CLK}/2$ clock in another count cycle. The average clock frequency is $f_{XTAL_CLK}/2.5$, which is 16 MHz, i.e. the CNT_CLK in Figure 11-2. The timer counting is incremented by $1/16 \mu s$ on each CNT_CLK cycle.

Software operation such as configuring registers is clocked by APB_CLK. For more information about APB_CLK, see Chapter 7 *Reset and Clock*.

The following two bits of system registers are also used to control the system timer:

- SYSTEM_SYSTIMER_CLK_EN in register SYSTEM_PERIP_CLK_EN0_REG: enable APB_CLK signal to system timer.
- SYSTEM_SYSTIMER_RST in register SYSTEM_PERIP_RST_EN0_REG: reset system timer.

Note that if the timer is reset, its registers will be restored to their default values. For more information, please refer to Table Peripheral Clock Gating and Reset in Chapter 17 *System Registers (SYSTEM)*.

11.4 Functional Description

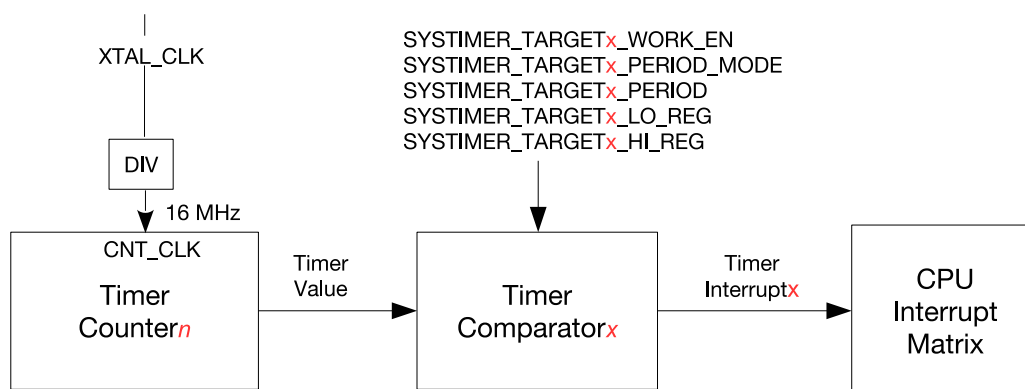

Figure 11-2. System Timer Alarms

Figure 11-2 shows the procedure to generate alarm/interrupt in system timer. In this process, one timer counter and one timer comparator are used. An alarm interrupt will be generated accordingly based on the comparison result in comparator.

11.4.1 Counter

The system timer has two 52-bit timer counters, shown as UNIT n ($n = 0$ or 1). Their counting clock source is a 16 MHz clock, i.e. CNT_CLK. Whether UNIT n works or not is controlled by three bits in register SYSTIMER_CONF_REG:

- SYSTIMER_TIMER_UNIT n _WORK_EN: set this bit to enable the counter UNIT n in system timer.
- SYSTIMER_TIMER_UNIT n _CORE0_STALL_EN: if this bit is set, the counter UNIT n stops counting when CPU0 is stalled. The counter continues its counting after the CPU0 resumes.
- SYSTIMER_TIMER_UNIT n _CORE1_STALL_EN: if this bit is set, the counter UNIT n stops counting when CPU1 is stalled. The counter continues its counting after the CPU1 resumes.

The configuration of the three bits to control the counter $UNIT_n$ is shown below, assuming that CPU0 and CPU1 both are stalled.

Table 11-1. $UNIT_n$ Configuration Bits

SYSTIMER_TIMER_ $UNIT_n$ _WORK_EN	SYSTIMER_TIMER_ $UNIT_n$ _CORE0_STALL_EN	SYSTIMER_TIMER_ $UNIT_n$ _CORE1_STALL_EN	Counter $UNIT_n$
0	x*	x	Not at work
1	x	1	Stop counting, but will continue its counting after CPU1 resumes.
1	1	x	Stop counting, but will continue its counting after CPU0 resumes.
1	0	0	Keep counting

* x: Don't-care.

When the counter $UNIT_n$ is at work, the count value is incremented on each counting cycle. When the counter $UNIT_n$ is stopped or stalled, the count value stops increasing and keeps unchanged.

The low 32 bits and high 20 bits of initial count value are loaded from `SYSTIMER_TIMER_ $UNIT_n$ _LOAD_LO` and `SYSTIMER_TIMER_ $UNIT_n$ _LOAD_HI`. Writing 1 to the bit `SYSTIMER_TIMER_ $UNIT_n$ _LOAD` will trigger a reload event, and the current count value will be changed immediately. If $UNIT_n$ is at work, the counter will continue to count up from the new reloaded value.

Writing 1 to `SYSTIMER_TIMER_ $UNIT_n$ _UPDATE` will trigger an update event. The low 32 bits and high 20 bits of current count value will be locked into `SYSTIMER_TIMER_ $UNIT_n$ _VALUE_LO` and `SYSTIMER_TIMER_ $UNIT_n$ _VALUE_HI`, and then `SYSTIMER_TIMER_ $UNIT_n$ _VALUE_VALID` is asserted. Before the next update event, the values of `SYSTIMER_TIMER_ $UNIT_n$ _VALUE_LO` and `SYSTIMER_TIMER_ $UNIT_n$ _VALUE_HI` remain unchanged.

11.4.2 Comparator and Alarm

The system timer has three 52-bit comparators, shown as $COMP_x$ ($x = 0, 1, \text{ or } 2$). The comparators can generate independent interrupts based on different alarm values (t) or alarm periods (δt).

Configure `SYSTIMER_TARGET_x_PERIOD_MODE` to choose from the two alarm modes for each $COMP_x$:

- 1: select period mode
- 0: select target mode

In period mode, the alarm period (δt) is provided by the register `SYSTIMER_TARGET_x_PERIOD`. Assuming that current count value is t_1 , when it reaches $(t_1 + \delta t)$, an alarm interrupt will be generated. Another alarm interrupt also will be generated when the counter value reaches $(t_1 + 2 * \delta t)$. By such way, periodic alarms are generated.

In target mode, the low 32 bits and high 20 bits of the alarm value (t) are provided by `SYSTIMER_TIMER_TARGET_x_LO` and `SYSTIMER_TIMER_TARGET_x_HI`. Assuming that current count value is t_2 ($t_2 \leq t$), an alarm interrupt will be generated when the count value reaches the alarm value (t). Unlike in period mode, only one alarm interrupt is generated in target mode.

`SYSTIMER_TARGETxTIMER_UNIT_SEL` is used to choose the count value from which timer counter to be compared for alarm:

- 1: use the count value from UNIT₁
- 0: use the count value from UNIT₀

Finally, set `SYSTIMER_TARGETxWORK_EN` and `COMPx` starts to compare the count value with the alarm value (t) in target mode or with the alarm period ($t_1 + n \cdot \delta t$) in period mode.

An alarm is generated when the count value equals to the alarm value (t) in target mode or to the start value(t_1) + $n \cdot$ alarm period δt ($n = 1, 2, 3, \dots$) in period mode. But if the alarm value (t) set in registers is less than current count value, i.e. the target has already passed, or current count value is larger than the real target value within a range ($0 \sim 2^{51} - 1$), an alarm interrupt also is generated immediately. The relationship between current count value t_c , the alarm value t_t and alarm trigger point is shown below. No matter in target mode or period mode, the low 32 bits and high 20 bits of the real target value can always be read from `SYSTIMER_TARGETxLO_RO` and `SYSTIMER_TARGETxHI_RO`.

Table 11-2. Trigger Point

Relationship Between t_c and t_t	Trigger Point
$t_c - t_t \leq 0$	$t_c = t_t$, an alarm is triggered.
$0 \leq t_c - t_t < 2^{51} - 1$ ($t_c < 2^{51}$ and $t_t < 2^{51}$, or $t_c \geq 2^{51}$ and $t_t \geq 2^{51}$)	An alarm is triggered immediately.
$t_c - t_t \geq 2^{51} - 1$	t_c overflows after counting to its maximum value $52'h\text{ffffffffffff}$, and then starts counting up from 0. When its value reaches t_t , an alarm is triggered.

11.4.3 Synchronization Operation

The clock APB_CLK is used in software operation, while timer counters and comparators are working on CNT_CLK. Synchronization is needed for some configuration registers. A complete synchronization action takes two steps:

1. Software writes suitable values to configuration fields, see the first column in Table 11-3.
2. Software writes 1 to corresponding bits to start synchronization, see the second column in Table 11-3.

Table 11-3. Synchronization Operation

Configuration Fields	Synchronization Enable Bit
<code>SYSTIMER_TIMER_UNIT_nLOAD_LO</code> <code>SYSTIMER_TIMER_UNIT_nLOAD_HI</code>	<code>SYSTIMER_TIMER_UNIT_nLOAD</code>
<code>SYSTIMER_TARGET_xPERIOD</code> <code>SYSTIMER_TIMER_TARGET_xHI</code> <code>SYSTIMER_TIMER_TARGET_xLO</code>	<code>SYSTIMER_TIMER_COMP_xLOAD</code>

11.4.4 Interrupt

Each comparator has one level-triggered alarm interrupt, named as SYSTIMER_TARGET x _INT. Interrupt signal is asserted high when the comparator starts to alarm. Until the interrupt is cleared by software, it remains high. To enable interrupts, set the bit SYSTIMER_TARGET x _INT_ENA.

11.5 Programming Procedure

11.5.1 Read Current Count Value

1. Set SYSTIMER_TIMER_UNIT n _UPDATE to update the current count value into SYSTIMER_TIMER_UNIT n _VALUE_HI and SYSTIMER_TIMER_UNIT n _VALUE_LO.
2. Poll the reading of SYSTIMER_TIMER_UNIT n _VALUE_VALID, till it's 1, which means user now can read the count values from SYSTIMER_TIMER_UNIT n _VALUE_HI and SYSTIMER_TIMER_UNIT n _VALUE_LO.
3. Read the low 32 bits and high 20 bits from SYSTIMER_TIMER_UNIT n _VALUE_LO and SYSTIMER_TIMER_UNIT n _VALUE_HI.

11.5.2 Configure One-Time Alarm in Target Mode

1. Set SYSTIMER_TARGET x _TIMER_UNIT_SEL to select the counter (UNIT0 or UNIT1) used for COMP x .
2. Read current count value, see Section 11.5.1. This value will be used to calculate the alarm value (t) in Step 4.
3. Clear SYSTIMER_TARGET x _PERIOD_MODE to enable target mode.
4. Set an alarm value (t), and fill its low 32 bits to SYSTIMER_TIMER_TARGET x _LO, and the high 20 bits to SYSTIMER_TIMER_TARGET x _HI.
5. Set SYSTIMER_TIMER_COMP x _LOAD to synchronize the alarm value to COMP x , i.e. load the alarm value (t) to the COMP x .
6. Set SYSTIMER_TARGET x _WORK_EN to enable the selected COMP x . COMP x starts comparing the count value with the alarm value (t).
7. Set SYSTIMER_TARGET x _INT_ENA to enable timer interrupt. When Unit n counts to the alarm value (t), a SYSTIMER_TARGET x _INT interrupt is triggered.

11.5.3 Configure Periodic Alarms in Period Mode

1. Set SYSTIMER_TARGET x _TIMER_UNIT_SEL to select the counter (UNIT0 or UNIT1) used for COMP x .
2. Set a alarm period (δt), and fill it to SYSTIMER_TARGET x _PERIOD.
3. Set SYSTIMER_TIMER_COMP x _LOAD to synchronize the alarm period (δt) to COMP x , i.e. load the alarm period (δt) to COMP x .
4. Set SYSTIMER_TARGET x _PERIOD_MODE to configure COMP x into period mode.
5. Set SYSTIMER_TARGET x _WORK_EN to enable the selected COMP x . COMP x starts comparing the count value with the sum of start value + $n * \delta t$ ($n = 1, 2, 3 \dots$).
6. Set SYSTIMER_TARGET x _INT_ENA to enable timer interrupt. A SYSTIMER_TARGET x _INT interrupt is triggered when Unit n counts to start value + $n * \delta t$ ($n = 1, 2, 3 \dots$) set in step 2.

11.5.4 Update After Deep-sleep and Light-sleep

1. Configure RTC timer before the chip goes to Deep-sleep or Light-sleep, to record the exact sleep time. For more information, see Chapter 10 *Low-power Management (RTC_CNTL)*.
2. Read the sleep time from RTC timer when the chip is woken up from Deep-sleep or Light-sleep.
3. Read current count value of system timer, see Section 11.5.1.
4. Convert the time value recorded by RTC timer from the clock cycles based on RTC_SLOW_CLK to that based on 16 MHz CNT_CLK. For example, if the frequency of RTC_SLOW_CLK is 32 KHz, the recorded RTC timer value should be converted by multiplying by 500.
5. Add the converted RTC value to current count value of system timer:
 - Fill the new value into SYSTIMER_TIMER_UNIT n _LOAD_LO (low 32 bits) and SYSTIMER_TIMER_UNIT n _LOAD_HI (high 20 bits).
 - Set SYSTIMER_TIMER_UNIT n _LOAD to load new timer value into system timer. By such way, the system timer is updated.

11.6 Register Summary

The addresses in this section are relative to system timer base address provided in Table 4-3 in Chapter 4 *System and Memory*.

The abbreviations given in Column **Access** are explained in Section *Access Types for Registers*.

Name	Description	Address	Access
Clock Control Register			
SYSTIMER_CONF_REG	Configure system timer clock	0x0000	R/W
UNIT0 Control and Configuration Registers			
SYSTIMER_UNIT0_OP_REG	Read UNIT0 value to registers	0x0004	varies
SYSTIMER_UNIT0_LOAD_HI_REG	High 20 bits to be loaded to UNIT0	0x000C	R/W
SYSTIMER_UNIT0_LOAD_LO_REG	Low 32 bits to be loaded to UNIT0	0x0010	R/W
SYSTIMER_UNIT0_VALUE_HI_REG	UNIT0 value, high 20 bits	0x0040	RO
SYSTIMER_UNIT0_VALUE_LO_REG	UNIT0 value, low 32 bits	0x0044	RO
SYSTIMER_UNIT0_LOAD_REG	UNIT0 synchronization register	0x005C	WT
UNIT1 Control and Configuration Registers			
SYSTIMER_UNIT1_OP_REG	Read UNIT1 value to registers	0x0008	varies
SYSTIMER_UNIT1_LOAD_HI_REG	High 20 bits to be loaded to UNIT1	0x0014	R/W
SYSTIMER_UNIT1_LOAD_LO_REG	Low 32 bits to be loaded to UNIT1	0x0018	R/W
SYSTIMER_UNIT1_VALUE_HI_REG	UNIT1 value, high 20 bits	0x0048	RO
SYSTIMER_UNIT1_VALUE_LO_REG	UNIT1 value, low 32 bits	0x004C	RO
SYSTIMER_UNIT1_LOAD_REG	UNIT1 synchronization register	0x0060	WT
Comparator0 Control and Configuration Registers			
SYSTIMER_TARGET0_HI_REG	Alarm value to be loaded to COMP0, high 20 bits	0x001C	R/W
SYSTIMER_TARGET0_LO_REG	Alarm value to be loaded to COMP0, low 32 bits	0x0020	R/W
SYSTIMER_TARGET0_CONF_REG	Configure COMP0 alarm mode	0x0034	R/W
SYSTIMER_COMP0_LOAD_REG	COMP0 synchronization register	0x0050	WT

Name	Description	Address	Access
Comparator¹ Control and Configuration Registers			
SYSTIMER_TARGET1_HI_REG	Alarm value to be loaded to COMP1, high 20 bits	0x0024	R/W
SYSTIMER_TARGET1_LO_REG	Alarm value to be loaded to COMP1, low 32 bits	0x0028	R/W
SYSTIMER_TARGET1_CONF_REG	Configure COMP1 alarm mode	0x0038	R/W
SYSTIMER_COMP1_LOAD_REG	COMP1 synchronization register	0x0054	WT
Comparator² Control and Configuration Registers			
SYSTIMER_TARGET2_HI_REG	Alarm value to be loaded to COMP2, high 20 bits	0x002C	R/W
SYSTIMER_TARGET2_LO_REG	Alarm value to be loaded to COMP2, low 32 bits	0x0030	R/W
SYSTIMER_TARGET2_CONF_REG	Configure COMP2 alarm mode	0x003C	R/W
SYSTIMER_COMP2_LOAD_REG	COMP2 synchronization register	0x0058	WT
Interrupt Registers			
SYSTIMER_INT_ENA_REG	Interrupt enable register of system timer	0x0064	R/W
SYSTIMER_INT_RAW_REG	Interrupt raw register of system timer	0x0068	R/WTC/SS
SYSTIMER_INT_CLR_REG	Interrupt clear register of system timer	0x006C	WT
SYSTIMER_INT_ST_REG	Interrupt status register of system timer	0x0070	RO
COMP⁰ Status Registers			
SYSTIMER_REAL_TARGET0_LO_REG	Actual target value of COMP0, low 32 bits	0x0074	RO
SYSTIMER_REAL_TARGET0_HI_REG	Actual target value of COMP0, high 20 bits	0x0078	RO
COMP¹ Status Registers			
SYSTIMER_REAL_TARGET1_LO_REG	Actual target value of COMP1, low 32 bits	0x007C	RO
SYSTIMER_REAL_TARGET1_HI_REG	Actual target value of COMP1, high 20 bits	0x0080	RO
COMP² Status Registers			
SYSTIMER_REAL_TARGET2_LO_REG	Actual target value of COMP2, low 32 bits	0x0084	RO
SYSTIMER_REAL_TARGET2_HI_REG	Actual target value of COMP2, high 20 bits	0x0088	RO
Version Register			
SYSTIMER_DATE_REG	Version control register	0x00FC	R/W

Register 11.2. SYSTIMER_UNIT0_OP_REG (0x0004)

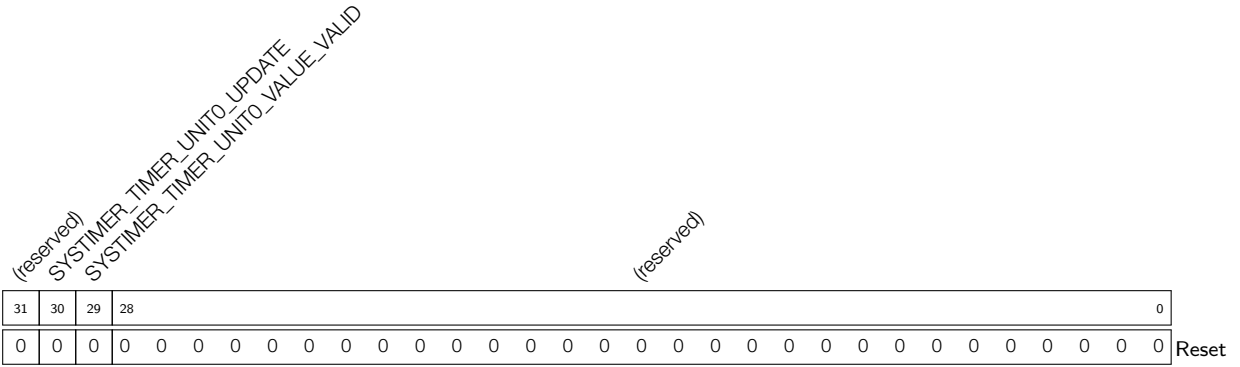

SYSTIMER_TIMER_UNIT0_VALUE_VALID UNIT0 value is synchronized and valid. (R/SS/WTC)

SYSTIMER_TIMER_UNIT0_UPDATE Update timer UNIT0, i.e. read the UNIT0 count value to SYSTIMER_TIMER_UNIT0_VALUE_HI and SYSTIMER_TIMER_UNIT0_VALUE_LO. (WT)

Register 11.3. SYSTIMER_UNIT0_LOAD_HI_REG (0x000C)

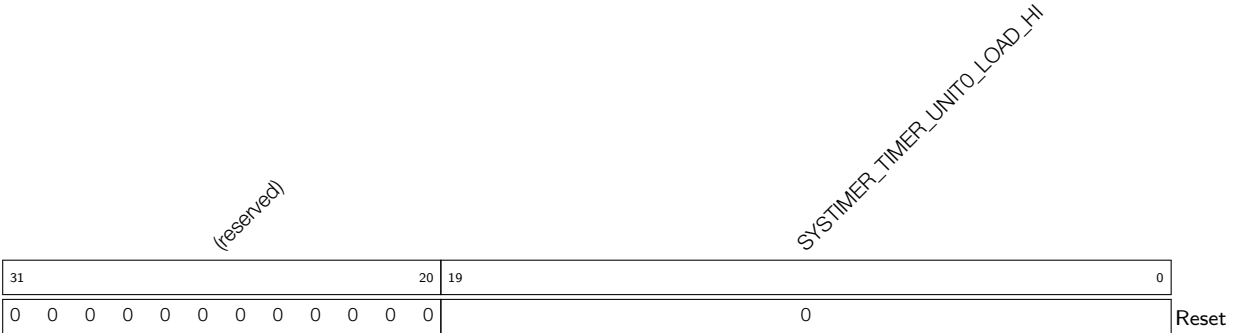

SYSTIMER_TIMER_UNIT0_LOAD_HI The value to be loaded to UNIT0, high 20 bits. (R/W)

Register 11.4. SYSTIMER_UNIT0_LOAD_LO_REG (0x0010)

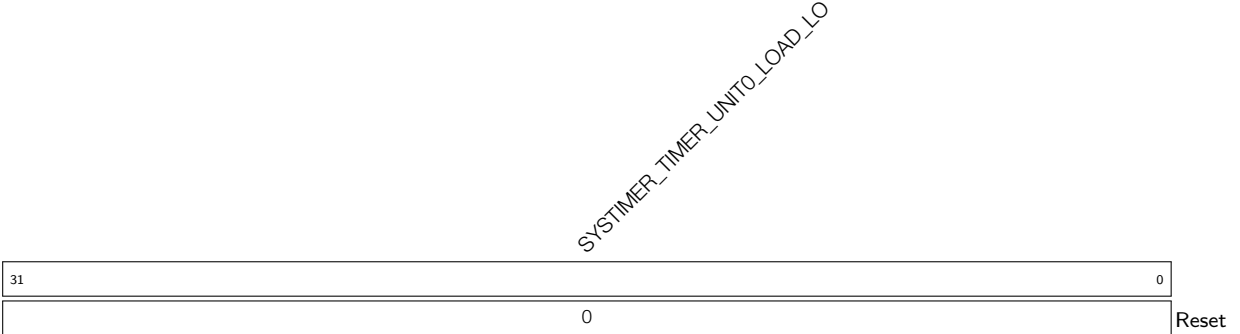

SYSTIMER_TIMER_UNIT0_LOAD_LO The value to be loaded to UNIT0, low 32 bits. (R/W)

Register 11.5. SYSTIMER_UNIT0_VALUE_HI_REG (0x0040)

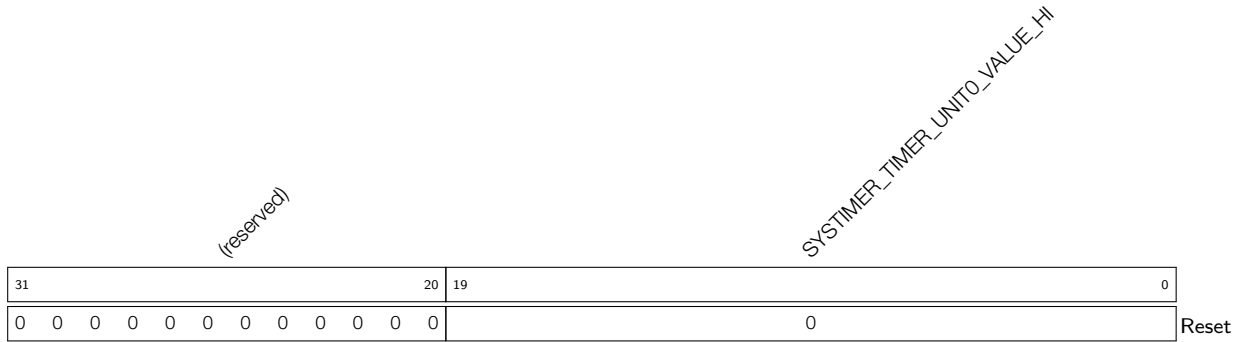

SYSTIMER_TIMER_UNIT0_VALUE_HI UNIT0 read value, high 20 bits. (RO)

Register 11.6. SYSTIMER_UNIT0_VALUE_LO_REG (0x0044)

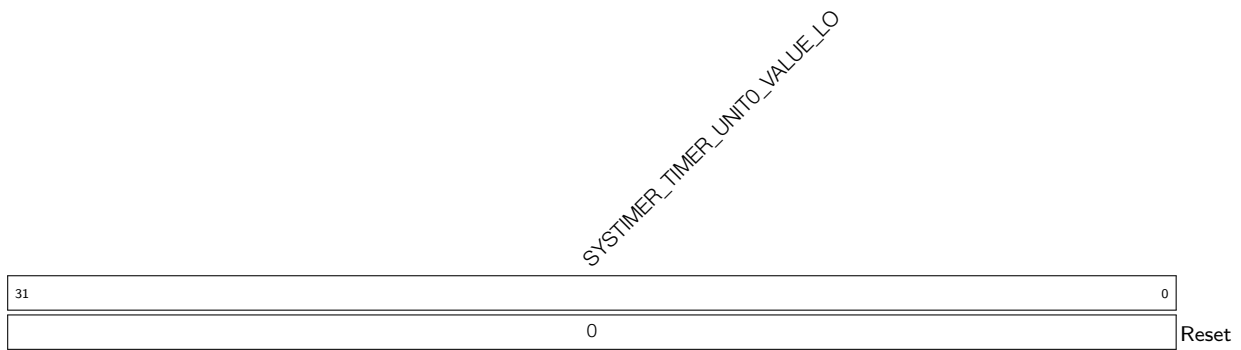

SYSTIMER_TIMER_UNIT0_VALUE_LO UNIT0 read value, low 32 bits. (RO)

Register 11.7. SYSTIMER_UNIT0_LOAD_REG (0x005C)

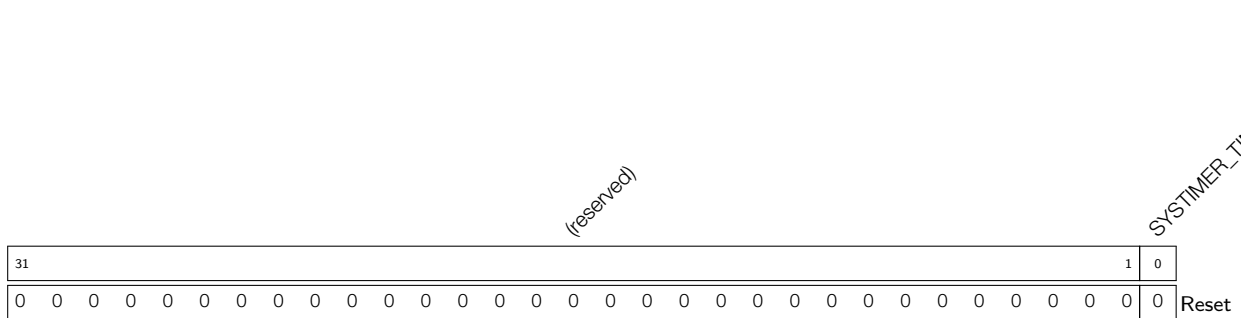

SYSTIMER_TIMER_UNIT0_LOAD UNIT0 synchronization enable signal. Set this bit to reload the values of SYSTIMER_TIMER_UNIT0_LOAD_HI and SYSTIMER_TIMER_UNIT0_LOAD_LO to UNIT0. (WT)

Register 11.8. SYSTIMER_UNIT1_OP_REG (0x0008)

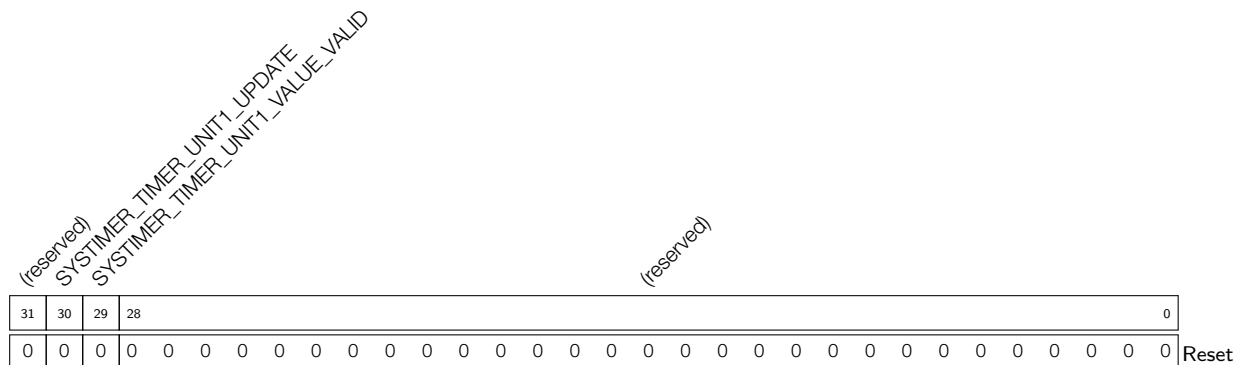

SYSTIMER_TIMER_UNIT1_VALUE_VALID UNIT1 value is synchronized and valid. (R/SS/WTC)

SYSTIMER_TIMER_UNIT1_UPDATE Update timer UNIT1, i.e. read the UNIT1 count value to SYSTIMER_TIMER_UNIT1_VALUE_HI and SYSTIMER_TIMER_UNIT1_VALUE_LO. (WT)

Register 11.9. SYSTIMER_UNIT1_LOAD_HI_REG (0x0014)

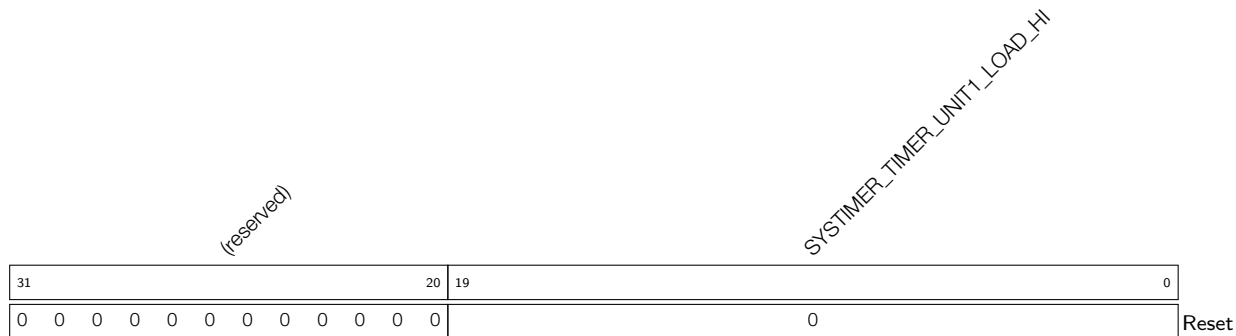

SYSTIMER_TIMER_UNIT1_LOAD_HI The value to be loaded to UNIT1, high 20 bits. (R/W)

Register 11.10. SYSTIMER_UNIT1_LOAD_LO_REG (0x0018)

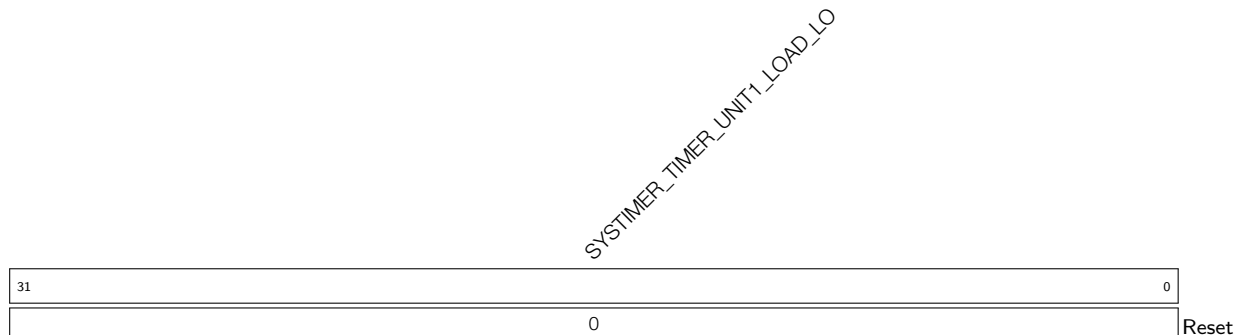

SYSTIMER_TIMER_UNIT1_LOAD_LO The value to be loaded to UNIT1, low 32 bits. (R/W)

Register 11.11. SYSTIMER_UNIT1_VALUE_HI_REG (0x0048)

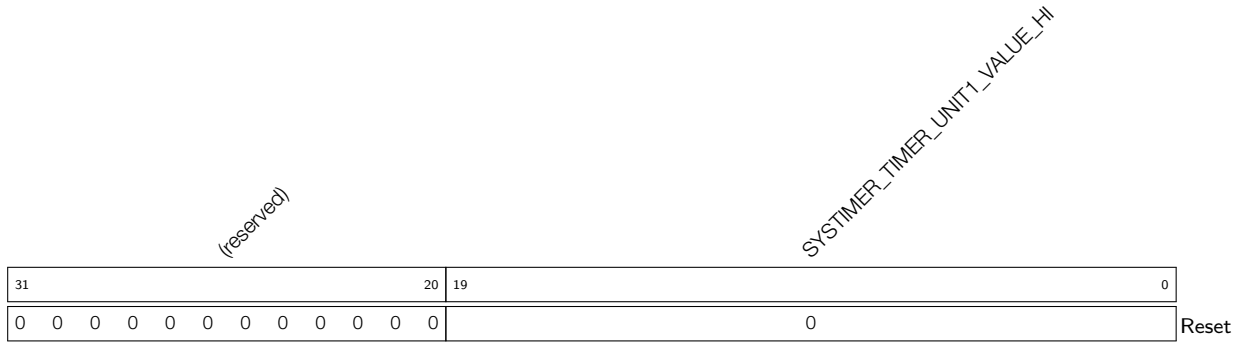

SYSTIMER_TIMER_UNIT1_VALUE_HI UNIT1 read value, high 20 bits. (RO)

Register 11.12. SYSTIMER_UNIT1_VALUE_LO_REG (0x004C)

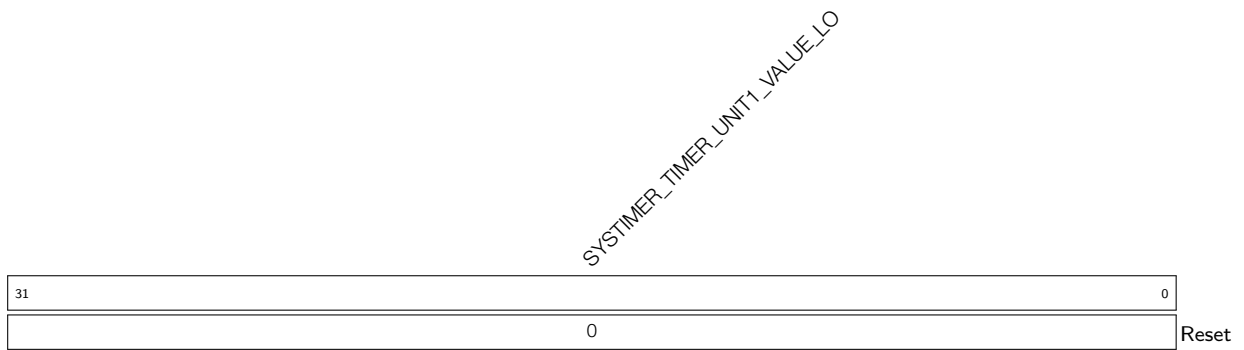

SYSTIMER_TIMER_UNIT1_VALUE_LO UNIT1 read value, low 32 bits. (RO)

Register 11.13. SYSTIMER_UNIT1_LOAD_REG (0x0060)

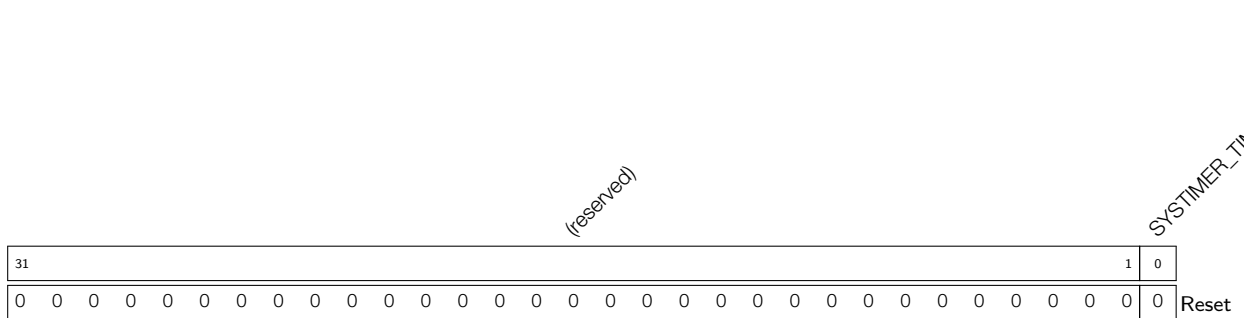

SYSTIMER_TIMER_UNIT1_LOAD UNIT1 synchronization enable signal. Set this bit to reload the values of SYSTIMER_TIMER_UNIT1_LOAD_HI and SYSTIMER_TIMER_UNIT1_LOAD_LO to UNIT1. (WT)

Register 11.14. SYSTIMER_TARGET0_HI_REG (0x001C)

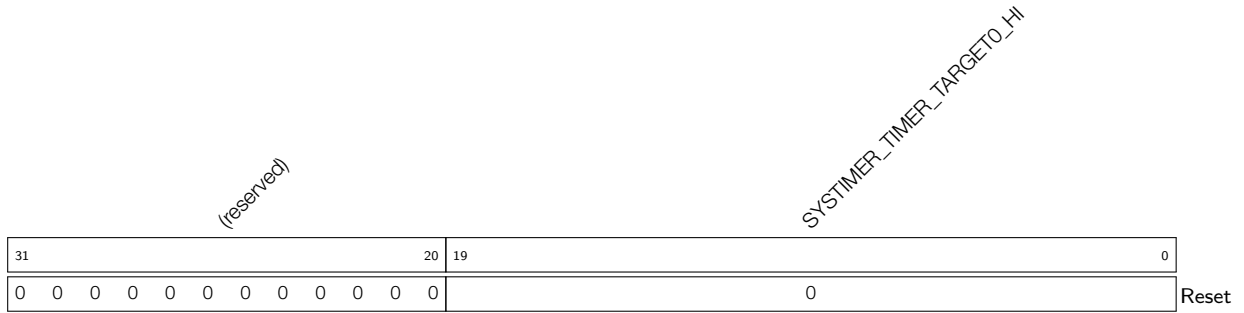

SYSTIMER_TIMER_TARGET0_HI The alarm value to be loaded to COMP0, high 20 bits. (R/W)

Register 11.15. SYSTIMER_TARGET0_LO_REG (0x0020)

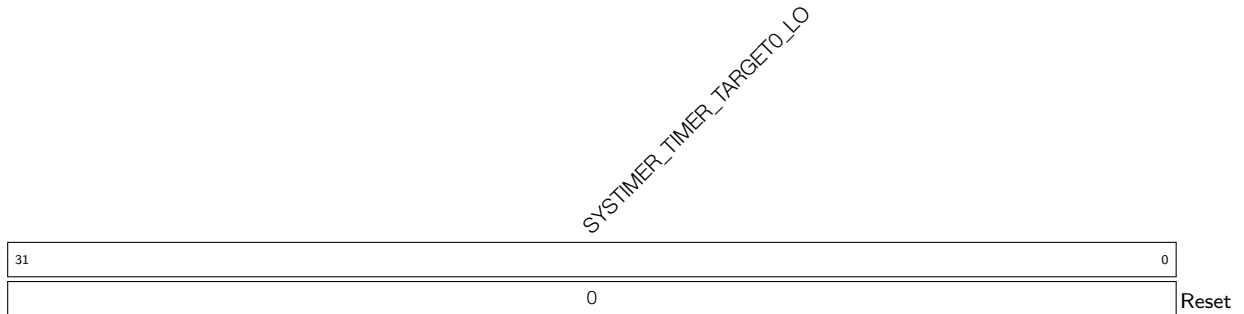

SYSTIMER_TIMER_TARGET0_LO The alarm value to be loaded to COMP0, low 32 bits. (R/W)

Register 11.16. SYSTIMER_TARGET0_CONF_REG (0x0034)

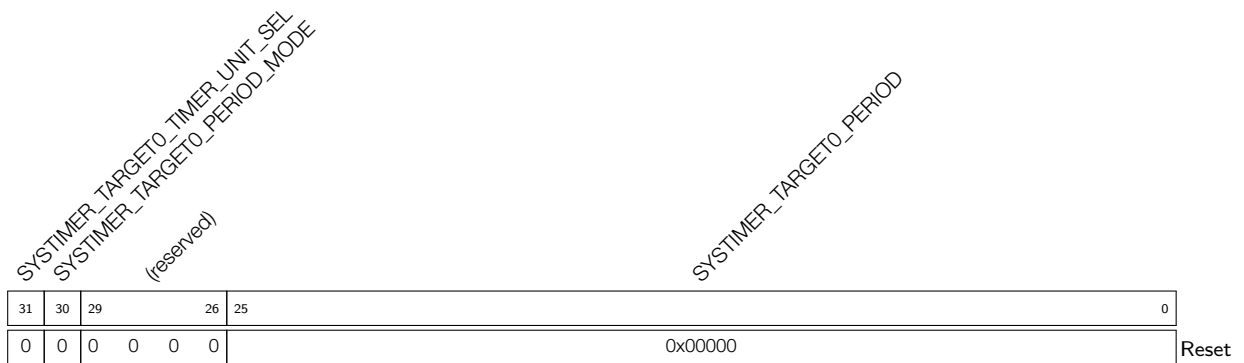

SYSTIMER_TARGET0_PERIOD COMP0 alarm period. (R/W)

SYSTIMER_TARGET0_PERIOD_MODE Set COMP0 to period mode. (R/W)

SYSTIMER_TARGET0_TIMER_UNIT_SEL Select which counter unit to compare for COMP0. (R/W)

Register 11.17. SYSTIMER_COMP0_LOAD_REG (0x0050)

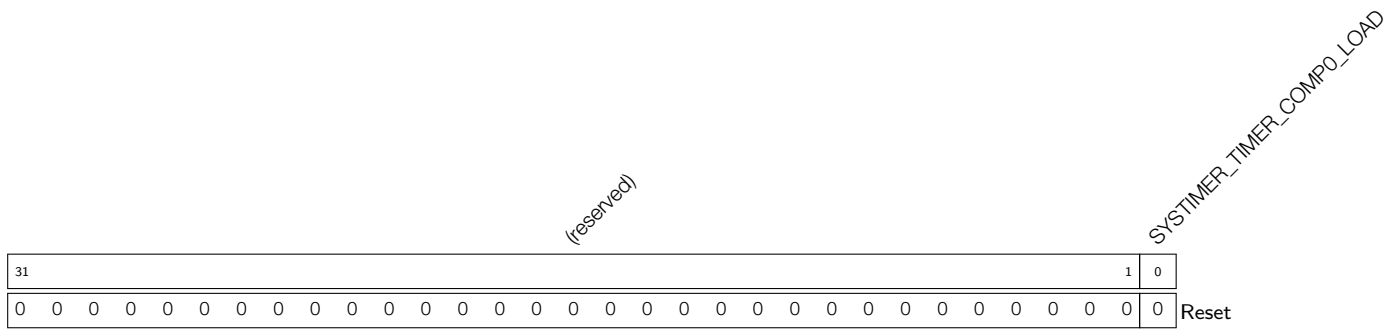

SYSTIMER_TIMER_COMP0_LOAD COMP0 synchronization enable signal. Set this bit to reload the alarm value/period to COMP0. (WT)

Register 11.18. SYSTIMER_TARGET1_HI_REG (0x0024)

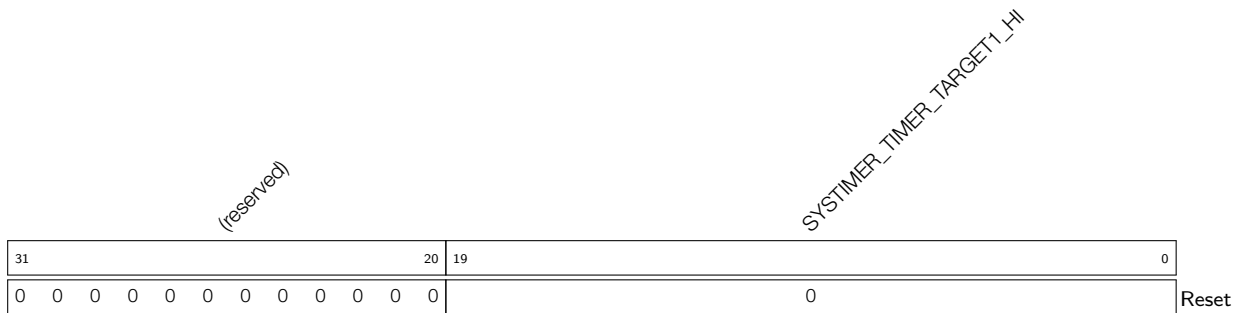

SYSTIMER_TIMER_TARGET1_HI The alarm value to be loaded to COMP1, high 20 bits. (R/W)

Register 11.19. SYSTIMER_TARGET1_LO_REG (0x0028)

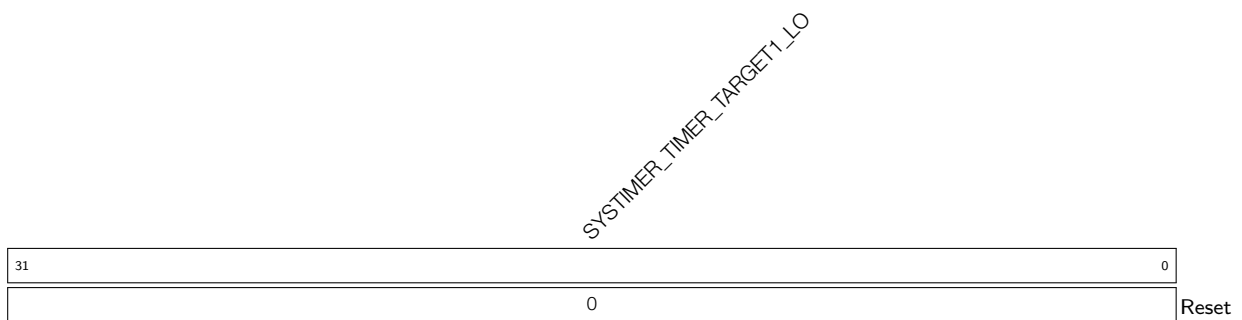

SYSTIMER_TIMER_TARGET1_LO The alarm value to be loaded to COMP1, low 32 bits. (R/W)

Register 11.20. SYSTIMER_TARGET1_CONF_REG (0x0038)

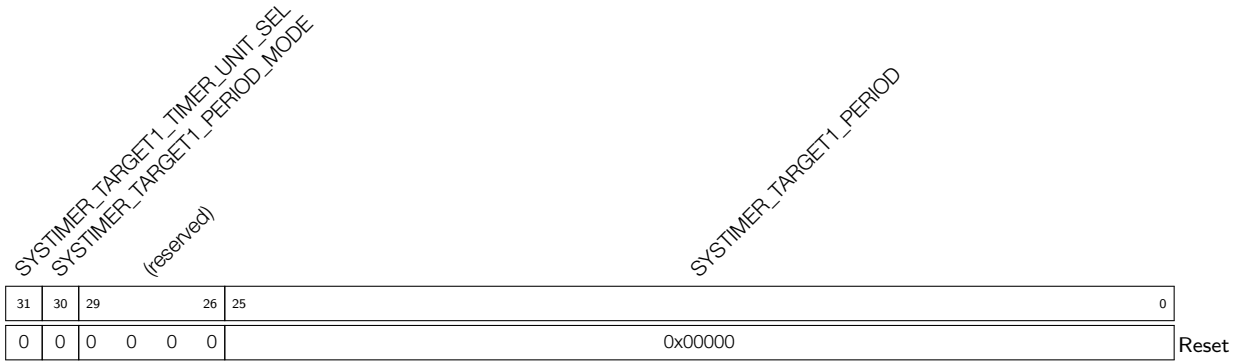

SYSTIMER_TARGET1_PERIOD COMP1 alarm period. (R/W)

SYSTIMER_TARGET1_PERIOD_MODE Set COMP1 to period mode. (R/W)

SYSTIMER_TARGET1_TIMER_UNIT_SEL Select which counter unit to compare for COMP1. (R/W)

Register 11.21. SYSTIMER_COMP1_LOAD_REG (0x0054)

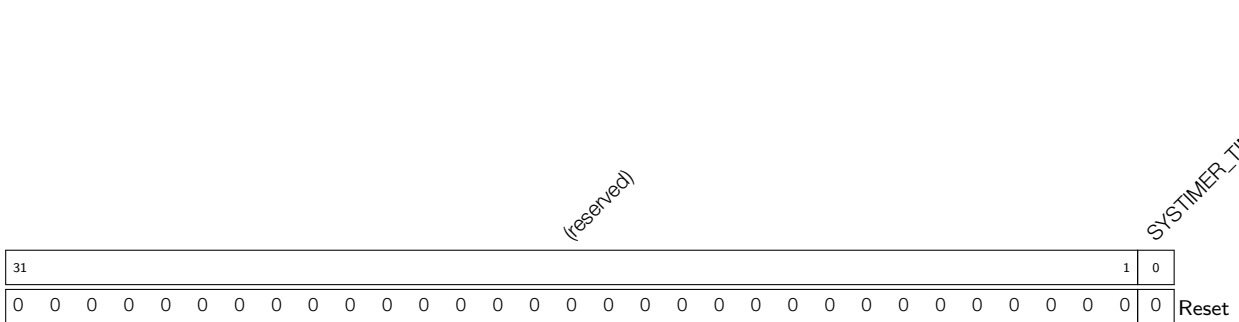

SYSTIMER_TIMER_COMP1_LOAD COMP1 synchronization enable signal. Set this bit to reload the alarm value/period to COMP1. (WT)

Register 11.22. SYSTIMER_TARGET2_HI_REG (0x002C)



SYSTIMER_TIMER_TARGET2_HI The alarm value to be loaded to COMP2, high 20 bits. (R/W)

Register 11.23. SYSTIMER_TARGET2_LO_REG (0x0030)

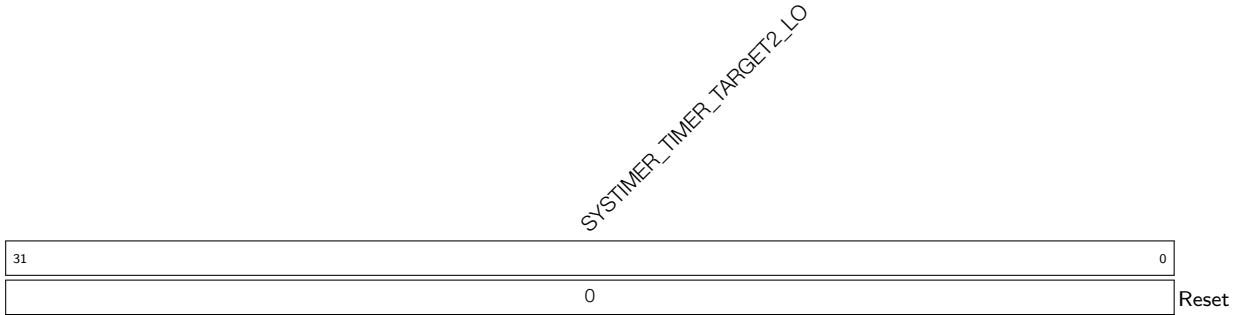

SYSTIMER_TIMER_TARGET2_LO The alarm value to be loaded to COMP2, low 32 bits. (R/W)

Register 11.24. SYSTIMER_TARGET2_CONF_REG (0x003C)

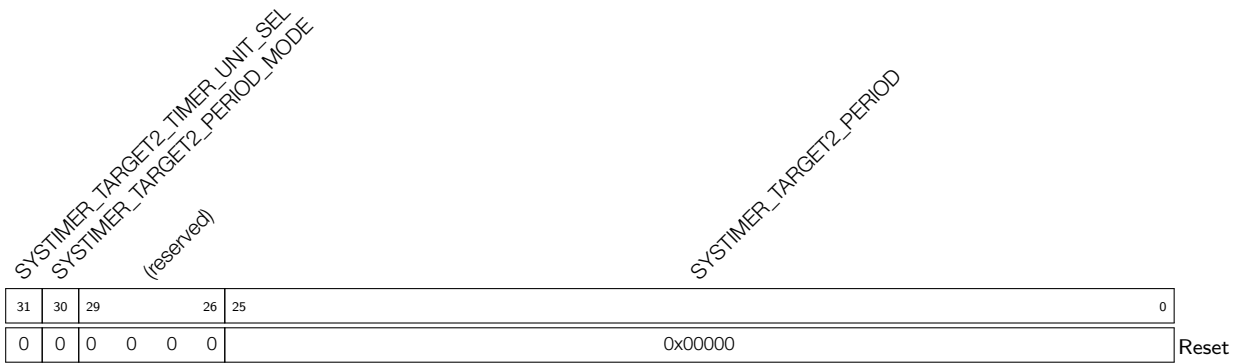

SYSTIMER_TARGET2_PERIOD COMP2 alarm period. (R/W)

SYSTIMER_TARGET2_PERIOD_MODE Set COMP2 to period mode. (R/W)

SYSTIMER_TARGET2_TIMER_UNIT_SEL Select which counter unit to compare for COMP2. (R/W)

Register 11.25. SYSTIMER_COMP2_LOAD_REG (0x0058)

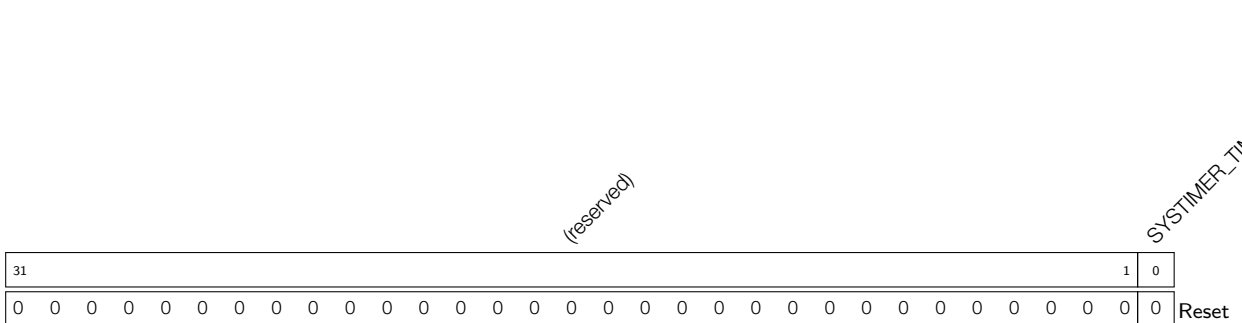

SYSTIMER_TIMER_COMP2_LOAD COMP2 synchronization enable signal. Set this bit to reload the alarm value/period to COMP2. (WT)

Register 11.28. SYSTIMER_INT_CLR_REG (0x006C)

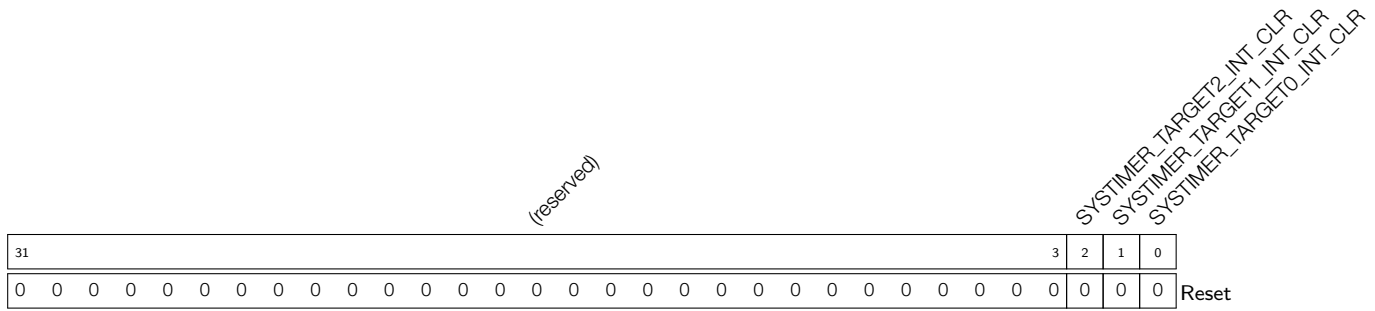

SYSTIMER_TARGET0_INT_CLR SYSTIMER_TARGET0_INT clear bit. (WT)

SYSTIMER_TARGET1_INT_CLR SYSTIMER_TARGET1_INT clear bit. (WT)

SYSTIMER_TARGET2_INT_CLR SYSTIMER_TARGET2_INT clear bit. (WT)

Register 11.29. SYSTIMER_INT_ST_REG (0x0070)

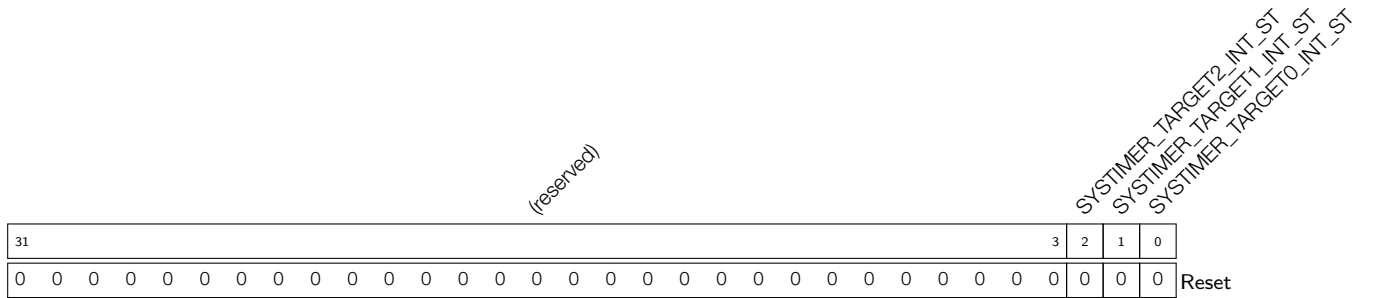

SYSTIMER_TARGET0_INT_ST SYSTIMER_TARGET0_INT status bit. (RO)

SYSTIMER_TARGET1_INT_ST SYSTIMER_TARGET1_INT status bit. (RO)

SYSTIMER_TARGET2_INT_ST SYSTIMER_TARGET2_INT status bit. (RO)

Register 11.30. SYSTIMER_REAL_TARGET0_LO_REG (0x0074)

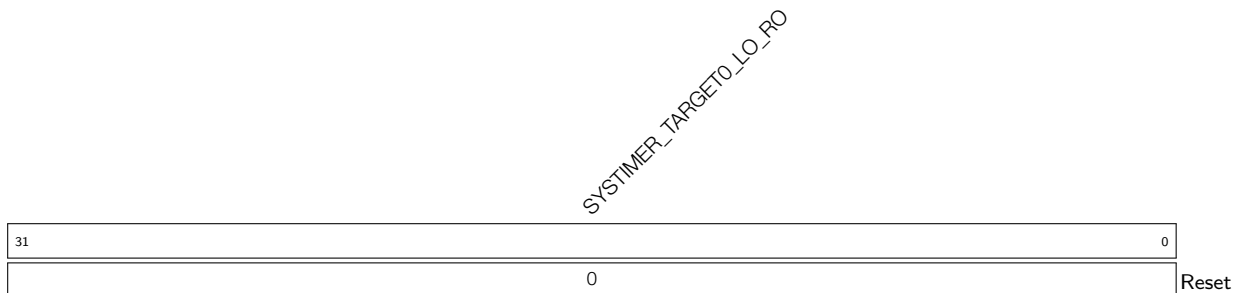

SYSTIMER_TARGET0_LO_RO Actual target value of COMP0, low 32 bits. (RO)

Register 11.31. SYSTIMER_REAL_TARGET0_HI_REG (0x0078)



SYSTIMER_TARGET0_HI_RO Actual target value of COMP0, high 20 bits. (RO)

Register 11.32. SYSTIMER_REAL_TARGET1_LO_REG (0x007C)

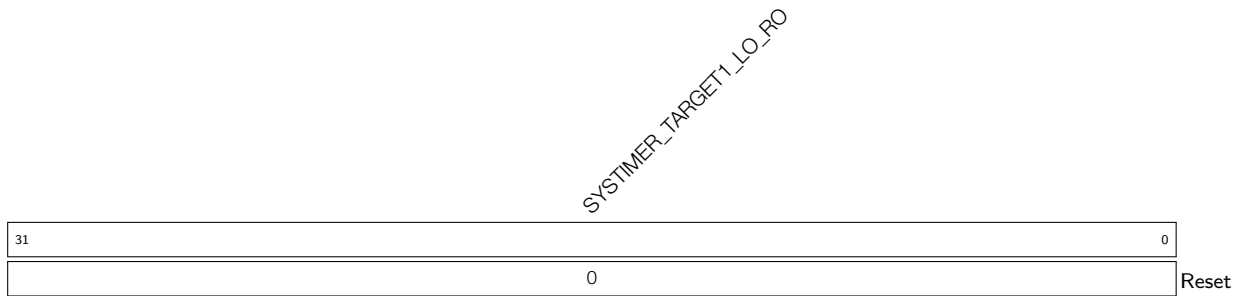

SYSTIMER_TARGET1_LO_RO Actual target value of COMP1, low 32 bits. (RO)

Register 11.33. SYSTIMER_REAL_TARGET1_HI_REG (0x0080)



SYSTIMER_TARGET1_HI_RO Actual target value of COMP1, high 20 bits. (RO)

Register 11.34. SYSTIMER_REAL_TARGET2_LO_REG (0x0084)

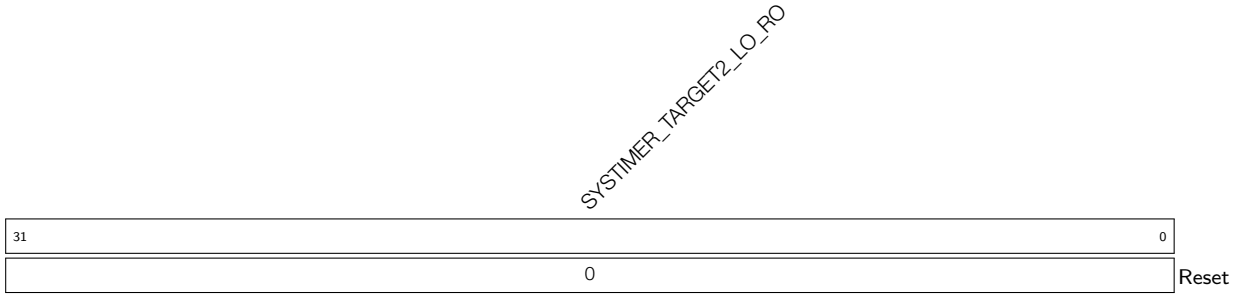

SYSTIMER_TARGET2_LO_RO Actual target value of COMP2, low 32 bits. (RO)

Register 11.35. SYSTIMER_REAL_TARGET2_HI_REG (0x0088)



SYSTIMER_TARGET2_HI_RO Actual target value of COMP2, high 20 bits. (RO)

Register 11.36. SYSTIMER_DATE_REG (0x00FC)

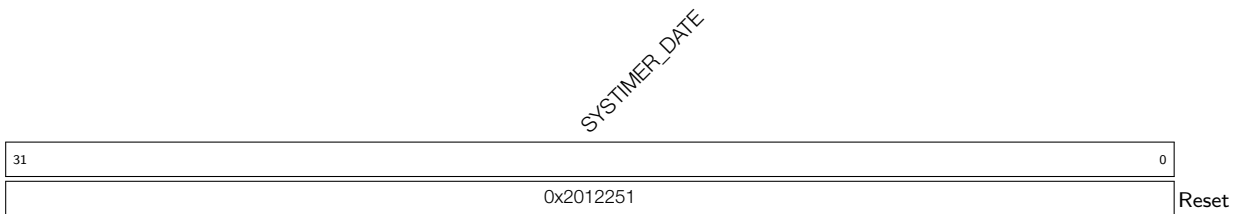

SYSTIMER_DATE Version control register. (R/W)

12 Timer Group (TIMG)

12.1 Overview

General purpose timers can be used to precisely time an interval, trigger an interrupt after a particular interval (periodically and aperiodically), or act as a hardware clock. As shown in Figure 12-1, the ESP32-S3 chip contains two timer groups, namely timer group 0 and timer group 1. Each timer group consists of two general purpose timers referred to as T_x (where x is 0 or 1) and one Main System Watchdog Timer. All general purpose timers are based on 16-bit prescalers and 54-bit auto-reload-capable up-down counters.

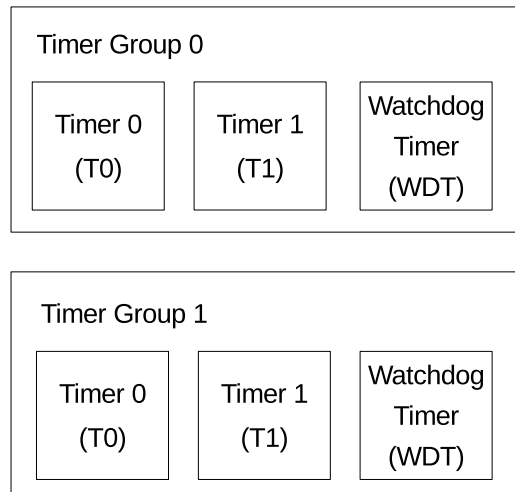

Figure 12-1. Timer Units within Groups

Note that while the Main System Watchdog Timer registers are described in this chapter, their functional description is included in the Chapter 13 *Watchdog Timers (WDT)*. Therefore, the term ‘timers’ within this chapter refers to the general purpose timers.

The timers’ features are summarized as follows:

- A 16-bit clock prescaler, from 2 to 65536
- A 54-bit time-base counter programmable to incrementing or decrementing
- Able to read real-time value of the time-base counter
- Halting and resuming the time-base counter
- Programmable alarm generation
- Timer value reload (Auto-reload at alarm or software-controlled instant reload)
- Level interrupt generation

12.2 Functional Description

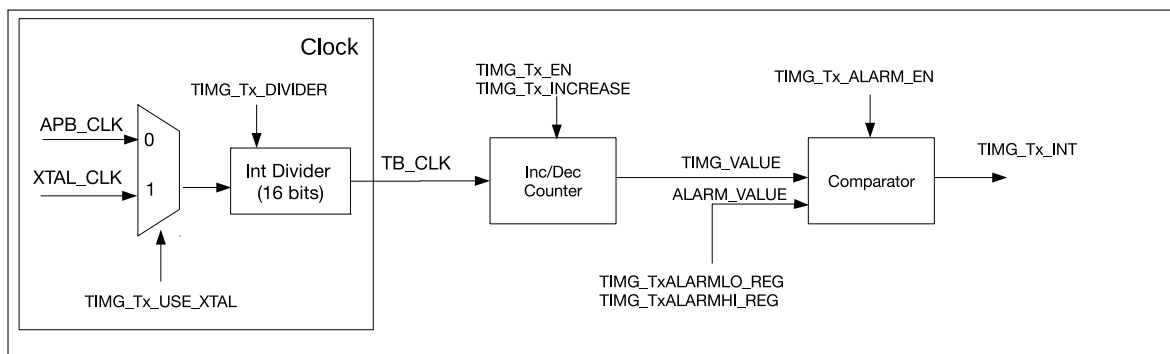

Figure 12-2. Timer Group Architecture

Figure 12-2 is a diagram of timer Tx in a timer group. Tx contains a clock selector, a 16-bit integer divider as a prescaler, a timer-based counter and a comparator for alarm generation.

12.2.1 16-bit Prescaler and Clock Selection

Each timer can select between the APB clock (APB_CLK) or external clock (XTAL_CLK) as its clock source by setting the `TIMG_Tx_USE_XTAL` field of the `TIMG_TxCONFIG_REG` register. The clock is then divided by a 16-bit prescaler to generate the time-base counter clock (TB_CLK) used by the time-base counter. When the `TIMG_Tx_DIVIDER` field is configured as 2 ~ 65536, the divisor of the prescaler would be 2 ~ 65536. Note that programming value 0 to `TIMG_Tx_DIVIDER` will result in the divisor being 65536. When the prescaler is set to 1, the actual divisor is 2, so the timer counter value represents the half of real time.

Before you modify the 16-bit prescaler, the timer must be disabled (i.e. `TIMG_Tx_EN` should be cleared). Otherwise, the result can be unpredictable.

12.2.2 54-bit Time-base Counter

The 54-bit time-base counters are based on TB_CLK and can be configured to increment or decrement via the `TIMG_Tx_INCREASE` field. The time-base counter can be enabled or disabled by setting or clearing the `TIMG_Tx_EN` field, respectively. When enabled, the time-base counter increments or decrements on each cycle of TB_CLK. When disabled, the time-base counter is essentially frozen. Note that the `TIMG_Tx_INCREASE` field can be changed while `TIMG_Tx_EN` is set and this will cause the time-base counter to change direction instantly.

To read the 54-bit value of the time-base counter, the timer value must be latched to two registers before being read by the CPU (due to the CPU being 32-bit). By writing any value to the `TIMG_TxUPDATE_REG`, the current value of the 54-bit timer starts to be latched into the `TIMG_TxLO_REG` and `TIMG_TxHI_REG` registers containing the lower 32-bits and higher 22-bits, respectively. When `TIMG_TxUPDATE_REG` is cleared by hardware, it indicates the latch operation has been completed and current timer value can be read from the `TIMG_TxLO_REG` and `TIMG_TxHI_REG` registers. `TIMG_TxLO_REG` and `TIMG_TxHI_REG` registers will remain unchanged for the CPU to read in its own time until `TIMG_TxUPDATE_REG` is written to again.

12.2.3 Alarm Generation

A timer can be configured to trigger an alarm when the timer's current value matches the alarm value. An alarm will cause an interrupt to occur and (optionally) an automatic reload of the timer's current value (see Section

12.2.4). The 54-bit alarm value is configured using [TIMG_TxALARMLO_REG](#) and [TIMG_TxALARMHI_REG](#), which represent the lower 32-bits and higher 22-bits of the alarm value, respectively. However, the configured alarm value is ineffective until the alarm is enabled by setting the [TIMG_Tx_ALARM_EN](#) field. To avoid alarm being enabled 'too late' (i.e. the timer value has already passed the alarm value when the alarm is enabled), the hardware will trigger the alarm immediately if the current timer value is higher than the alarm value (within a defined range) when the up-down counter increments, or lower than the alarm value (within a defined range) of when the up-down counter decrements. Table 12-1 and Table 12-2 show the relationship between the current value of the timer, the alarm value, and when an alarm is triggered. The current time value and the alarm value are defined as follows:

- $TIMG_VALUE = \{TIMG_TxHI_REG, TIMG_TxLO_REG\}$
- $ALARM_VALUE = \{TIMG_TxALARMHI_REG, TIMG_TxALARMLO_REG\}$

Table 12-1. Alarm Generation When Up-Down Counter Increments

Scenario	Range	Alarm
1	$ALARM_VALUE - TIMG_VALUE > 2^{53}$	Triggered
2	$0 < ALARM_VALUE - TIMG_VALUE \leq 2^{53}$	Triggered when the up-down counter counts $TIMG_VALUE$ up to $ALARM_VALUE$
3	$0 \leq TIMG_VALUE - ALARM_VALUE < 2^{53}$	Triggered
4	$TIMG_VALUE - ALARM_VALUE \geq 2^{53}$	Triggered when the up-down counter restarts counting up from 0 after reaching the timer's maximum value and counts $TIMG_VALUE$ up to $ALARM_VALUE$

Table 12-2. Alarm Generation When Up-Down Counter Decrements

Scenario	Range	Alarm
5	$TIMG_VALUE - ALARM_VALUE > 2^{53}$	Triggered
6	$0 < TIMG_VALUE - ALARM_VALUE \leq 2^{53}$	Triggered when the up-down counter counts $TIMG_VALUE$ down to $ALARM_VALUE$
7	$0 \leq ALARM_VALUE - TIMG_VALUE < 2^{53}$	Triggered
8	$ALARM_VALUE - TIMG_VALUE \geq 2^{53}$	Triggered when the up-down counter restarts counting down from the timer's maximum value after reaching the minimum value and counts $TIMG_VALUE$ down to $ALARM_VALUE$

When an alarm occurs, the [TIMG_Tx_ALARM_EN](#) field is automatically cleared and no alarm will occur again until the [TIMG_Tx_ALARM_EN](#) is set next time.

12.2.4 Timer Reload

A timer is reloaded when a timer's current value is overwritten with a reload value stored in the [TIMG_Tx_LOAD_LO](#) and [TIMG_Tx_LOAD_HI](#) fields that correspond to the lower 32-bits and higher 22-bits of the timer's new value, respectively. However, writing a reload value to [TIMG_Tx_LOAD_LO](#) and [TIMG_Tx_LOAD_HI](#) will not cause the timer's current value to change. Instead, the reload value is ignored by the timer until a reload

event occurs. A reload event can be triggered either by a software instant reload or an auto-reload at alarm.

A software instant reload is triggered by the CPU writing any value to `TIMG_TxLOAD_REG`, which causes the timer's current value to be instantly reloaded. If `TIMG_Tx_EN` is set, the timer will continue incrementing or decrementing from the new value. If `TIMG_Tx_EN` is cleared, the timer will remain frozen at the new value until counting is re-enabled.

An auto-reload at alarm will cause a timer reload when an alarm occurs, thus allowing the timer to continue incrementing or decrementing from the reload value. This is generally useful for resetting the timer's value when using periodic alarms. To enable auto-reload at alarm, the `TIMG_Tx_AUTORELOAD` field should be set. If not enabled, the timer's value will continue to increment or decrement past the alarm value after an alarm.

12.2.5 RTC_SLOW_CLK Frequency Calculation

Via `XTAL_CLK`, a timer could calculate the frequency of clock sources for `RTC_SLOW_CLK` (i.e. `RC_SLOW_CLK`, `RC_FAST_DIV_CLK`, and `XTAL32K_CLK`) as follows:

1. Start periodic or one-shot frequency calculation;
2. Once receiving the signal to start calculation, the counter of `XTAL_CLK` and the counter of `RTC_SLOW_CLK` begin to work at the same time. When the counter of `RTC_SLOW_CLK` counts to `C0`, the two counters stop counting simultaneously;
3. Assume the value of `XTAL_CLK`'s counter is `C1`, and the frequency of `RTC_SLOW_CLK` would be calculated as: $f_{rtc} = \frac{C0 \times f_{XTAL_CLK}}{C1}$

12.2.6 Interrupts

Each timer has its own interrupt line that can be routed to the CPU, and thus each timer group has a total of three interrupt lines. Timers generate level interrupts that must be explicitly cleared by the CPU on each triggering.

Interrupts are triggered after an alarm (or stage timeout for watchdog timers) occurs. Level interrupts will be held high after an alarm (or stage timeout) occurs, and will remain so until manually cleared. To enable a timer's interrupt, the `TIMG_Tx_INT_ENA` bit should be set.

The interrupts of each timer group are governed by a set of registers. Each timer within the group has a corresponding bit in each of these registers:

- `TIMG_Tx_INT_RAW` : An alarm event sets it to 1. The bit will remain set until the timer's corresponding bit in `TIMG_Tx_INT_CLR` is written.
- `TIMG_WDT_INT_RAW` : A stage time out will set the timer's bit to 1. The bit will remain set until the timer's corresponding bit in `TIMG_WDT_INT_CLR` is written.
- `TIMG_Tx_INT_ST` : Reflects the status of each timer's interrupt and is generated by masking the bits of `TIMG_Tx_INT_RAW` with `TIMG_Tx_INT_ENA`.
- `TIMG_WDT_INT_ST` : Reflects the status of each watchdog timer's interrupt and is generated by masking the bits of `TIMG_WDT_INT_RAW` with `TIMG_WDT_INT_ENA`.
- `TIMG_Tx_INT_ENA` : Used to enable or mask the interrupt status bits of timers within the group.
- `TIMG_WDT_INT_ENA` : Used to enable or mask the interrupt status bits of watchdog timer within the group.

- [TIMG_Tx_INT_CLR](#) : Used to clear a timer's interrupt by setting its corresponding bit to 1. The timer's corresponding bit in [TIMG_Tx_INT_RAW](#) and [TIMG_Tx_INT_ST](#) will be cleared as a result. Note that a timer's interrupt must be cleared before the next interrupt occurs.
- [TIMG_WDT_INT_CLR](#) : Used to clear a timer's interrupt by setting its corresponding bit to 1. The watchdog timer's corresponding bit in [TIMG_WDT_INT_RAW](#) and [TIMG_WDT_INT_ST](#) will be cleared as a result. Note that a watchdog timer's interrupt must be cleared before the next interrupt occurs.

12.3 Configuration and Usage

12.3.1 Timer as a Simple Clock

1. Configure the time-base counter
 - Select clock source by setting or clearing [TIMG_Tx_USE_XTAL](#) field.
 - Configure the 16-bit prescaler by setting [TIMG_Tx_DIVIDER](#).
 - Configure the timer direction by setting or clearing [TIMG_Tx_INCREASE](#).
 - Set the timer's starting value by writing the starting value to [TIMG_Tx_LOAD_LO](#) and [TIMG_Tx_LOAD_HI](#), then reloading it into the timer by writing any value to [TIMG_TxLOAD_REG](#).
2. Start the timer by setting [TIMG_Tx_EN](#).
3. Get the timer's current value.
 - Write any value to [TIMG_TxUPDATE_REG](#) to latch the timer's current value.
 - Wait until [TIMG_TxUPDATE_REG](#) is cleared by hardware.
 - Read the latched timer value from [TIMG_TxLO_REG](#) and [TIMG_TxHI_REG](#).

12.3.2 Timer as One-shot Alarm

1. Configure the time-base counter following step 1 of Section 12.3.1.
2. Configure the alarm.
 - Configure the alarm value by setting [TIMG_TxALARMLO_REG](#) and [TIMG_TxALARMHI_REG](#).
 - Enable interrupt by setting [TIMG_Tx_INT_ENA](#).
3. Disable auto reload by clearing [TIMG_Tx_AUTORELOAD](#).
4. Start the alarm by setting [TIMG_Tx_ALARM_EN](#).
5. Handle the alarm interrupt.
 - Clear the interrupt by setting the timer's corresponding bit in [TIMG_Tx_INT_CLR](#).
 - Disable the timer by clearing [TIMG_Tx_EN](#).

12.3.3 Timer as Periodic Alarm

1. Configure the time-base counter following step 1 in Section 12.3.1.
2. Configure the alarm following step 2 in Section 12.3.2.

3. Enable auto reload by setting `TIMG_Tx_AUTORELOAD` and configure the reload value via `TIMG_Tx_LOAD_LO` and `TIMG_Tx_LOAD_HI`.
4. Start the alarm by setting `TIMG_Tx_ALARM_EN`.
5. Handle the alarm interrupt (repeat on each alarm iteration).
 - Clear the interrupt by setting the timer's corresponding bit in `TIMG_Tx_INT_CLR`.
 - If the next alarm requires a new alarm value and reload value (i.e. different alarm interval per iteration), then `TIMG_TxALARMLO_REG`, `TIMG_TxALARMHI_REG`, `TIMG_Tx_LOAD_LO`, and `TIMG_Tx_LOAD_HI` should be reconfigured as needed. Otherwise, the aforementioned registers should remain unchanged.
 - Re-enable the alarm by setting `TIMG_Tx_ALARM_EN`.
6. Stop the timer (on final alarm iteration).
 - Clear the interrupt by setting the timer's corresponding bit in `TIMG_Tx_INT_CLR`.
 - Disable the timer by clearing `TIMG_Tx_EN`.

12.3.4 RTC_SLOW_CLK Frequency Calculation

1. One-shot frequency calculation
 - Select the clock whose frequency is to be calculated (clock source of `RTC_SLOW_CLK`) via `TIMG_RTC_CALI_CLK_SEL`, and configure the time of calculation via `TIMG_RTC_CALI_MAX`.
 - Select one-shot frequency calculation by clearing `TIMG_RTC_CALI_START_CYCLING`, and enable the two counters via `TIMG_RTC_CALI_START`.
 - Once `TIMG_RTC_CALI_RDY` becomes 1, read `TIMG_RTC_CALI_VALUE` to get the value of `XTAL_CLK`'s counter, and calculate the frequency of `RTC_SLOW_CLK`.
2. Periodic frequency calculation
 - Select the clock whose frequency is to be calculated (clock source of `RTC_SLOW_CLK`) via `TIMG_RTC_CALI_CLK_SEL`, and configure the time of calculation via `TIMG_RTC_CALI_MAX`.
 - Select periodic frequency calculation by enabling `TIMG_RTC_CALI_START_CYCLING`.
 - When `TIMG_RTC_CALI_CYCLING_DATA_VLD` is 1, `TIMG_RTC_CALI_VALUE` is valid.
3. Timeout

If the counter of `RTC_SLOW_CLK` cannot finish counting in `TIMG_RTC_CALI_TIMEOUT_RST_CNT` cycles, `TIMG_RTC_CALI_TIMEOUT` will be set to indicate a timeout.

12.4 Register Summary

The addresses in this section are relative to **Timer Group** base address provided in Table 4-3 in Chapter 4 *System and Memory*.

The abbreviations given in Column **Access** are explained in Section [Access Types for Registers](#).

Name	Description	Address	Access
Timer 0 configuration and control registers			
TIMG_T0CONFIG_REG	Timer 0 configuration register	0x0000	varies
TIMG_T0LO_REG	Timer 0 current value, low 32 bits	0x0004	RO
TIMG_T0HI_REG	Timer 0 current value, high 22 bits	0x0008	RO
TIMG_T0UPDATE_REG	Write to copy current timer value to TIMG_T0LO_REG or TIMG_T0HI_REG	0x000C	R/W/SC
TIMG_T0ALARMLO_REG	Timer 0 alarm value, low 32 bits	0x0010	R/W
TIMG_T0ALARMHI_REG	Timer 0 alarm value, high bits	0x0014	R/W
TIMG_T0LOADLO_REG	Timer 0 reload value, low 32 bits	0x0018	R/W
TIMG_T0LOADHI_REG	Timer 0 reload value, high 22 bits	0x001C	R/W
TIMG_T0LOAD_REG	Write to reload timer from TIMG_T0LOADLO_REG or TIMG_T0LOADHI_REG	0x0020	WT
Timer 1 configuration and control registers			
TIMG_T1CONFIG_REG	Timer 1 configuration register	0x0024	varies
TIMG_T1LO_REG	Timer 1 current value, low 32 bits	0x0028	RO
TIMG_T1HI_REG	Timer 1 current value, high 22 bits	0x002C	RO
TIMG_T1UPDATE_REG	Write to copy current timer value to TIMG_T1LO_REG or TIMG_T1HI_REG	0x0030	R/W/SC
TIMG_T1ALARMLO_REG	Timer 1 alarm value, low 32 bits	0x0034	R/W
TIMG_T1ALARMHI_REG	Timer 1 alarm value, high bits	0x0038	R/W
TIMG_T1LOADLO_REG	Timer 1 reload value, low 32 bits	0x003C	R/W
TIMG_T1LOADHI_REG	Timer 1 reload value, high 22 bits	0x0040	R/W
TIMG_T1LOAD_REG	Write to reload timer from TIMG_T1LOADLO_REG or TIMG_T1LOADHI_REG	0x0044	WT
Configuration and control registers for WDT			
TIMG_WDTCONFIG0_REG	Watchdog timer configuration register	0x0048	R/W
TIMG_WDTCONFIG1_REG	Watchdog timer prescaler register	0x004C	R/W
TIMG_WDTCONFIG2_REG	Watchdog timer stage 0 timeout value	0x0050	R/W
TIMG_WDTCONFIG3_REG	Watchdog timer stage 1 timeout value	0x0054	R/W
TIMG_WDTCONFIG4_REG	Watchdog timer stage 2 timeout value	0x0058	R/W
TIMG_WDTCONFIG5_REG	Watchdog timer stage 3 timeout value	0x005C	R/W
TIMG_WDTFEED_REG	Write to feed the watchdog timer	0x0060	WT
TIMG_WDTWPROTECT_REG	Watchdog write protect register	0x0064	R/W
Configuration and control registers for RTC frequency calculation			
TIMG_RTCCALICFG_REG	RTC frequency calculation configuration register 0	0x0068	varies

Name	Description	Address	Access
TIMG_RTCCALICFG1_REG	RTC frequency calculation configuration register 1	0x006C	RO
TIMG_RTCCALICFG2_REG	RTC frequency calculation calibration register 2	0x0080	varies
Interrupt registers			
TIMG_INT_ENA_TIMERS_REG	Interrupt enable bits	0x0070	R/W
TIMG_INT_RAW_TIMERS_REG	Raw interrupt status	0x0074	R/WTC/SS
TIMG_INT_ST_TIMERS_REG	Masked interrupt status	0x0078	RO
TIMG_INT_CLR_TIMERS_REG	Interrupt clear bits	0x007C	WT
Version register			
TIMG_NTIMERS_DATE_REG	Timer version control register	0x00F8	R/W
Timer group configuration registers			
TIMG_REGCLK_REG	Timer group clock gate register	0x00FC	R/W

12.5 Registers

The addresses in this section are relative to **Timer Group** base address provided in Table 4-3 in Chapter 4 *System and Memory*.

Register 12.1. TIMG_T_xCONFIG_REG (x: 0-1) (0x0000+0x24*x)

TIMG_T _x _EN TIMG_T _x _INCREASE TIMG_T _x _AUTORELOAD				TIMG_T _x _DIVIDER								(reserved) TIMG_T _x _ALARM_EN TIMG_T _x _USE_XTAL (reserved)				0			
31	30	29	28	13	12	11	10	9	8	7	6	5	4	3	2	1	0		
0	1	1	0x01								0	0	0	0	0	0	0	0	0

TIMG_T_x_USE_XTAL 0: Use APB_CLK as the source clock of timer group; 1: Use XTAL_CLK as the source clock of timer group. (R/W)

TIMG_T_x_ALARM_EN When set, the alarm is enabled. This bit is automatically cleared once an alarm occurs. (R/W/SC)

TIMG_T_x_DIVIDER Timer *x* clock (Tx_clk) prescaler value. (R/W)

TIMG_T_x_AUTORELOAD When set, timer *x* auto-reload at alarm is enabled. (R/W)

TIMG_T_x_INCREASE When set, the timer *x* time-base counter will increment every clock tick. When cleared, the timer *x* time-base counter will decrement. (R/W)

TIMG_T_x_EN When set, the timer *x* time-base counter is enabled. (R/W)

Register 12.2. TIMG_T_xLO_REG (x: 0-1) (0x0004+0x24*x)

TIMG_T _x _LO																															
31																															0
0x000000																															

TIMG_T_x_LO After writing to TIMG_T_xUPDATE_REG, the low 32 bits of the time-base counter of timer *x* can be read here. (RO)

Register 12.3. TIMG_TxHI_REG (x: 0-1) (0x0008+0x24*x)

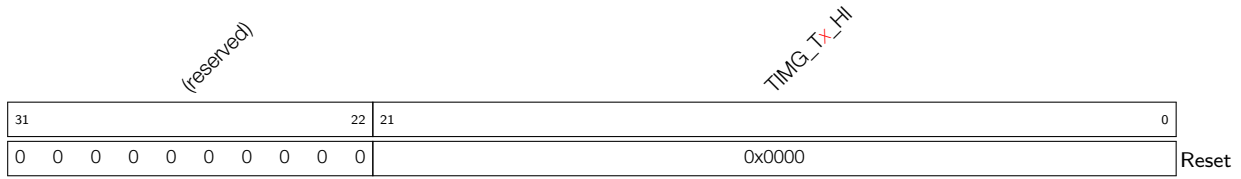

TIMG_Tx_HI After writing to TIMG_TxUPDATE_REG, the high 22 bits of the time-base counter of timer *x* can be read here. (RO)

Register 12.4. TIMG_TxUPDATE_REG (x: 0-1) (0x000C+0x24*x)

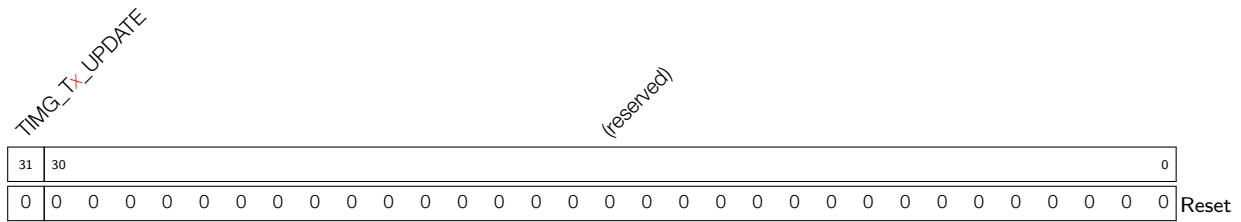

TIMG_Tx_UPDATE After writing 0 or 1 to TIMG_TxUPDATE_REG, the counter value is latched. (R/W/SC)

Register 12.5. TIMG_TxALARMLO_REG (x: 0-1) (0x0010+0x24*x)

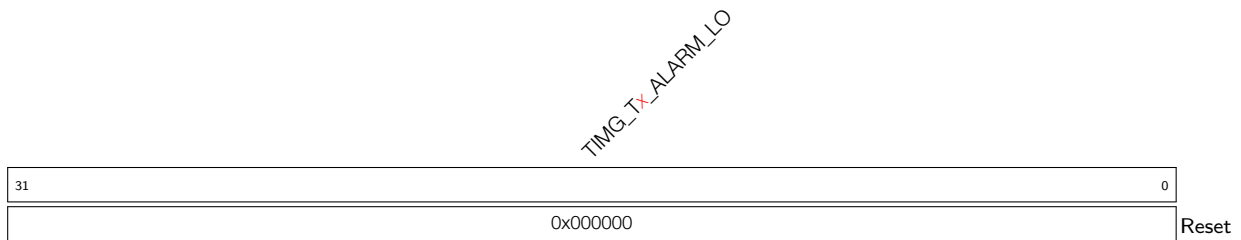

TIMG_Tx_ALARM_LO Timer *x* alarm trigger time-base counter value, low 32 bits. (R/W)

Register 12.6. TIMG_TxALARMHI_REG (x: 0-1) (0x0014+0x24*x)



TIMG_Tx_ALARM_HI Timer *x* alarm trigger time-base counter value, high 22 bits. (R/W)

Register 12.7. TIMG_TxLOADLO_REG (x: 0-1) (0x0018+0x24*x)

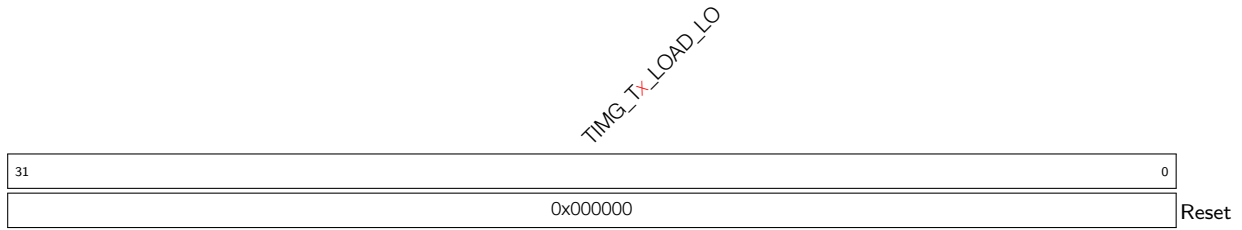

TIMG_Tx_LOAD_LO Low 32 bits of the value that a reload will load onto timer x time-base counter.
(R/W)

Register 12.8. TIMG_TxLOADHI_REG (x: 0-1) (0x001C+0x24*x)

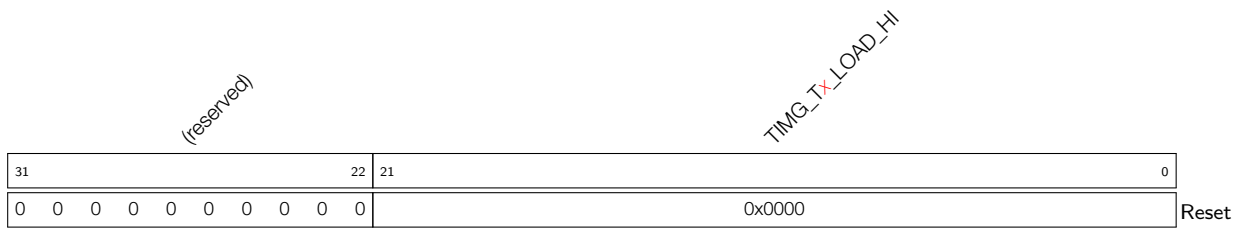

TIMG_Tx_LOAD_HI High 22 bits of the value that a reload will load onto timer x time-base counter.
(R/W)

Register 12.9. TIMG_TxLOAD_REG (x: 0-1) (0x0020+0x24*x)

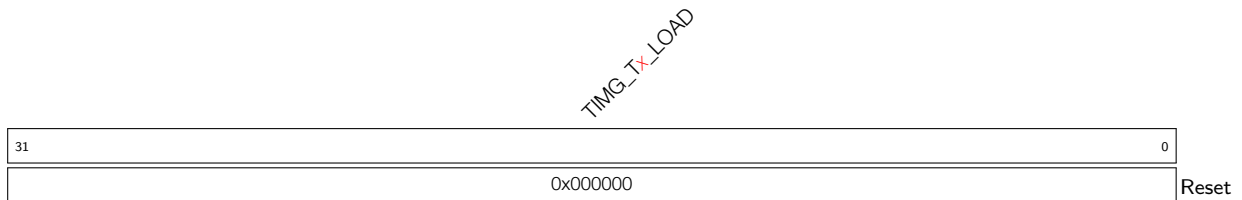

TIMG_Tx_LOAD Write any value to trigger a timer x time-base counter reload. (WT)

Register 12.10. TIMG_WDTCONFIG0_REG (0x0048)

TIMG_WDT_EN		TIMG_WDT_STG0		TIMG_WDT_STG1		TIMG_WDT_STG2		TIMG_WDT_STG3 (reserved)		TIMG_WDT_CPU_RESET_LENGTH		TIMG_WDT_SYS_RESET_LENGTH		TIMG_WDT_FLASHBOOT_MOD_EN		TIMG_WDT_PROCPU_RESET_EN		TIMG_WDT_APPCPU_RESET_EN (reserved)				
31	30	29	28	27	26	25	24	23	22	21	20	18	17	15	14	13	12	11			0	
0	0	0	0	0	0	0	0	0	0	0	0x1	0x1	1	0	0	0	0	0	0	0	0	0

Reset

- TIMG_WDT_APPCPU_RESET_EN** Reserved. (R/W)
- TIMG_WDT_PROCPU_RESET_EN** WDT reset CPU enable. (R/W)
- TIMG_WDT_FLASHBOOT_MOD_EN** When set, Flash boot protection is enabled. (R/W)
- TIMG_WDT_SYS_RESET_LENGTH** System reset signal length selection. 0: 100 ns; 1: 200 ns; 2: 300 ns; 3: 400 ns; 4: 500 ns; 5: 800 ns; 6: 1.6 μs; 7: 3.2 μs. (R/W)
- TIMG_WDT_CPU_RESET_LENGTH** CPU reset signal length selection. 0: 100 ns; 1: 200 ns; 2: 300 ns; 3: 400 ns; 4: 500 ns; 5: 800 ns; 6: 1.6 μs; 7: 3.2 μs. (R/W)
- TIMG_WDT_STG3** Stage 3 configuration. 0: off; 1: interrupt; 2: reset CPU; 3: reset system. (R/W)
- TIMG_WDT_STG2** Stage 2 configuration. 0: off; 1: interrupt; 2: reset CPU; 3: reset system. (R/W)
- TIMG_WDT_STG1** Stage 1 configuration. 0: off; 1: interrupt; 2: reset CPU; 3: reset system. (R/W)
- TIMG_WDT_STG0** Stage 0 configuration. 0: off; 1: interrupt; 2: reset CPU; 3: reset system. (R/W)
- TIMG_WDT_EN** When set, MWDT is enabled. (R/W)

Register 12.11. TIMG_WDTCONFIG1_REG (0x004C)

TIMG_WDT_CLK_PRESCALE																(reserved)															
31															16	15															0
0x01																0						0						0			

Reset

- TIMG_WDT_CLK_PRESCALE** MWDT clock prescaler value. MWDT clock period = 12.5 ns * TIMG_WDT_CLK_PRESCALE. (R/W)

Register 12.12. TIMG_WDTCONFIG2_REG (0x0050)

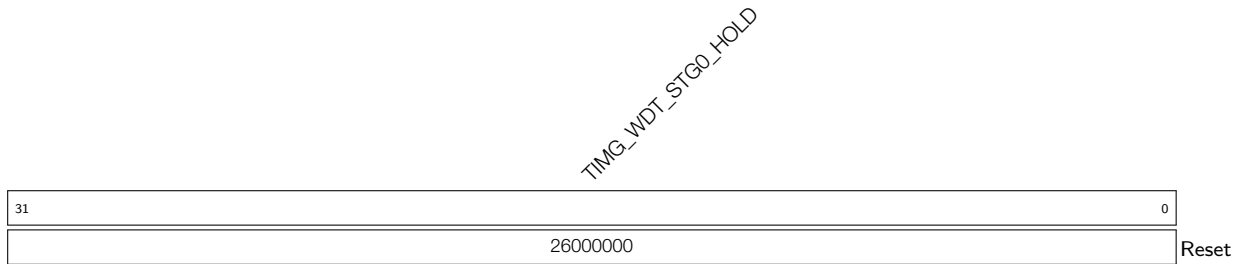

TIMG_WDT_STG0_HOLD Stage 0 timeout value, in MWDT clock cycles. (R/W)

Register 12.13. TIMG_WDTCONFIG3_REG (0x0054)

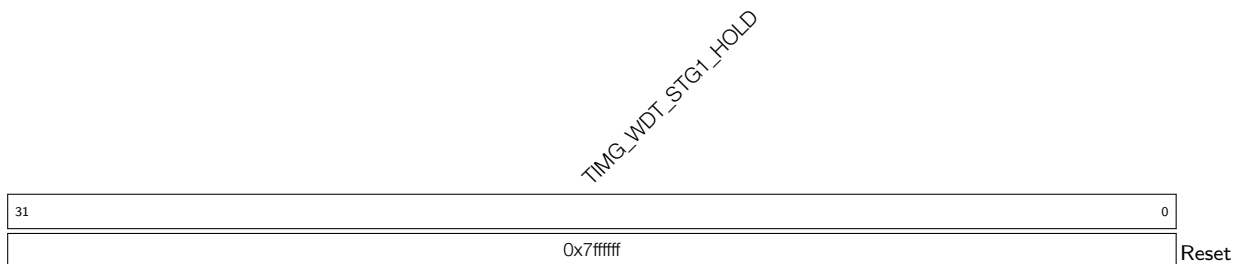

TIMG_WDT_STG1_HOLD Stage 1 timeout value, in MWDT clock cycles. (R/W)

Register 12.14. TIMG_WDTCONFIG4_REG (0x0058)

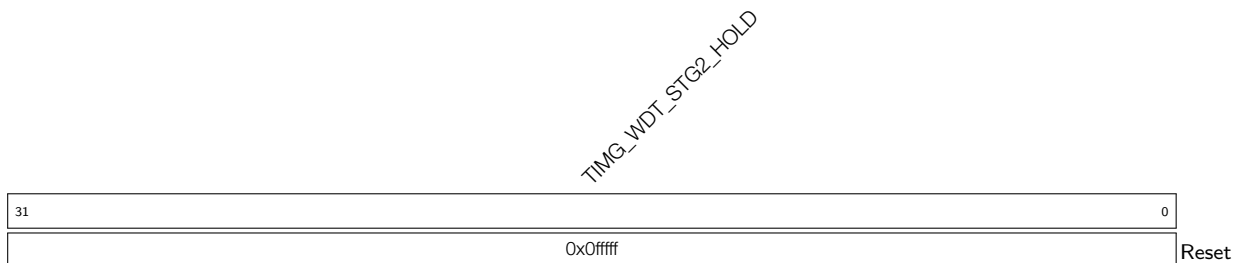

TIMG_WDT_STG2_HOLD Stage 2 timeout value, in MWDT clock cycles. (R/W)

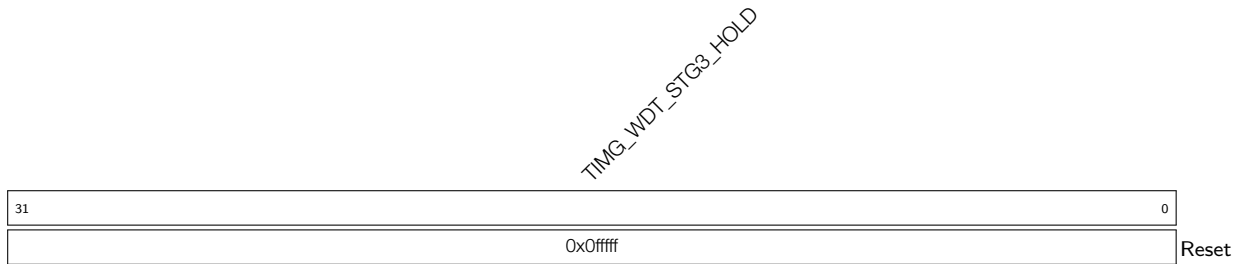
Register 12.15. TIMG_WDTCONFIG5_REG (0x005C)

TIMG_WDT_STG3_HOLD Stage 3 timeout value, in MWDT clock cycles. (R/W)

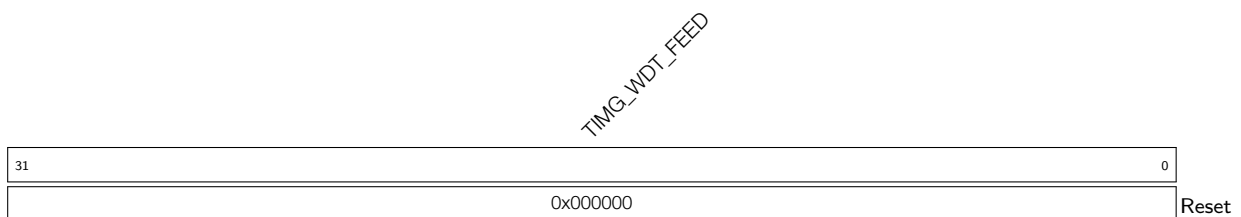
Register 12.16. TIMG_WDTFEED_REG (0x0060)

TIMG_WDT_FEED Write any value to feed the MWDT. (WT)

Register 12.17. TIMG_WDTWPROTECT_REG (0x0064)

TIMG_WDT_WKEY If the register contains a different value than its reset value, write protection is enabled. (R/W)

Register 12.18. TIMG_RTCCALICFG_REG (0x0068)

TIMG_RTC_CALI_START		TIMG_RTC_CALI_MAX				TIMG_RTC_CALI_RDY				TIMG_RTC_CALI_CLK_SEL				TIMG_RTC_CALI_START_CYCLING				(reserved)				
31	30					16	15	14	13	12	11									0		
0		0x01				0				0x1				1				0 0 0 0 0 0 0 0 0 0 0 0 0 0 0 0				Reset

TIMG_RTC_CALI_START_CYCLING Enables periodic frequency calculation. (R/W)

TIMG_RTC_CALI_CLK_SEL Used to select the clock to be calibrated. 0: RC_SLOW_CLK; 1: RC_FAST_DIV_CLK; 2: XTAL32K_CLK. (R/W)

TIMG_RTC_CALI_RDY Marks the completion of one-shot frequency calculation. (RO)

TIMG_RTC_CALI_MAX Configures the time to calculate the frequency of RTC slow clock RTC_SLOW_CLK. Measurement unit: RTC_SLOW_CLK cycle. (R/W)

TIMG_RTC_CALI_START Enables one-shot frequency calculation. (R/W)

Register 12.19. TIMG_RTCCALICFG1_REG (0x006C)

TIMG_RTC_CALI_VALUE							(reserved)				TIMG_RTC_CALI_CYCLING_DATA_VLD				
31						7	6					1	0		
0x00000							0 0 0 0 0 0				0				Reset

TIMG_RTC_CALI_CYCLING_DATA_VLD Marks the completion of periodic frequency calculation. (RO)

TIMG_RTC_CALI_VALUE When one-shot or periodic frequency calculation completes, read this value to calculate the frequency of RTC slow clock RTC_SLOW_CLK. Measurement unit: XTAL_CLK cycle. (RO)

Register 12.20. TIMG_RTC_CALICFG2_REG (0x0080)

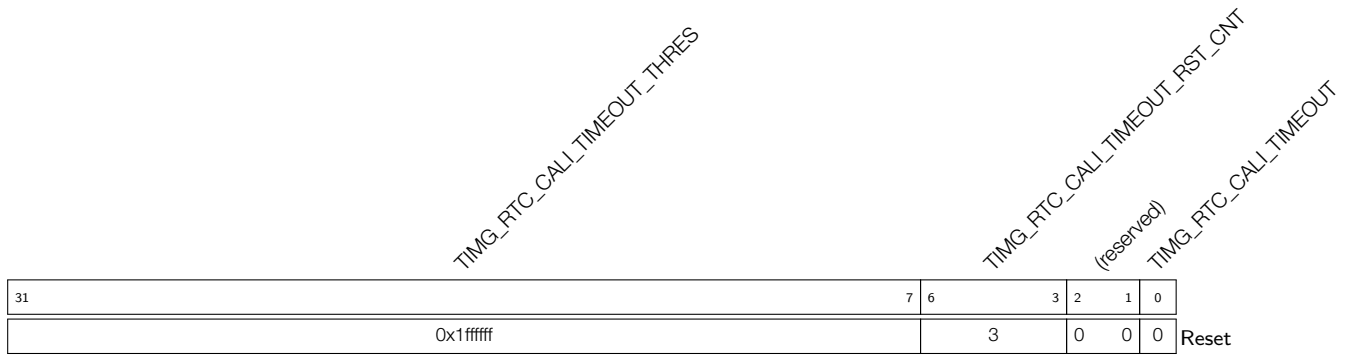

TIMG_RTC_CALI_TIMEOUT Indicates frequency calculation timeout. (RO)

TIMG_RTC_CALI_TIMEOUT_RST_CNT Cycles to reset frequency calculation timeout. (R/W)

TIMG_RTC_CALI_TIMEOUT_THRES Threshold value for the frequency calculation timer. If the timer's value exceeds this threshold, a timeout is triggered. (R/W)

Register 12.21. TIMG_INT_ENA_TIMERS_REG (0x0070)

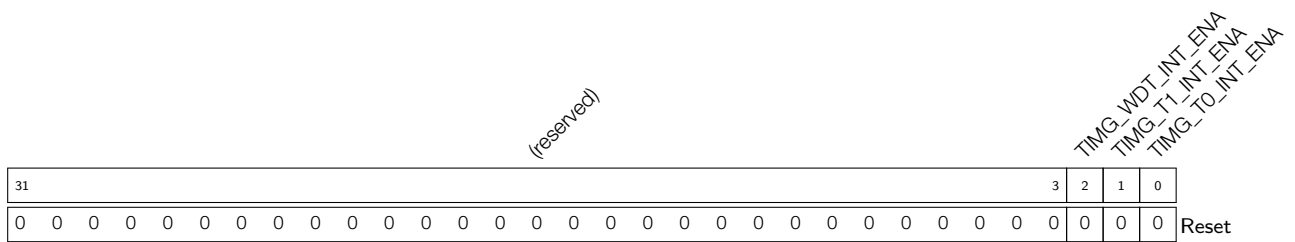

TIMG_Tx_INT_ENA The interrupt enable bit for the TIMG_Tx_INT interrupt. (R/W)

TIMG_WDT_INT_ENA The interrupt enable bit for the TIMG_WDT_INT interrupt. (R/W)

Register 12.22. TIMG_INT_RAW_TIMERS_REG (0x0074)

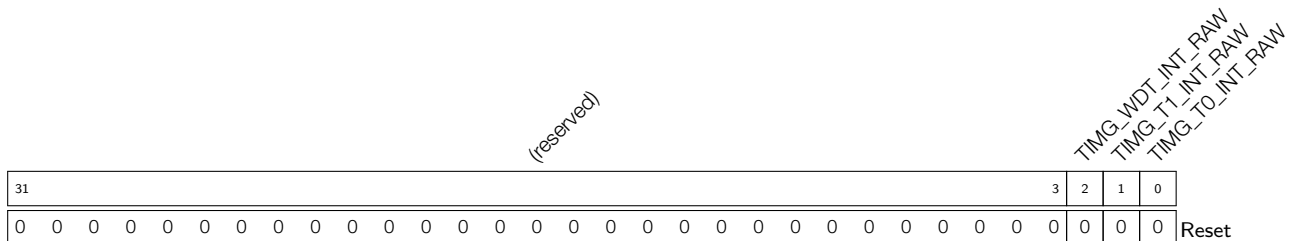

TIMG_Tx_INT_RAW The raw interrupt status bit for the TIMG_Tx_INT interrupt. (R/WTC/SS)

TIMG_WDT_INT_RAW The raw interrupt status bit for the TIMG_WDT_INT interrupt. (R/WTC/SS)

Register 12.23. TIMG_INT_ST_TIMERS_REG (0x0078)

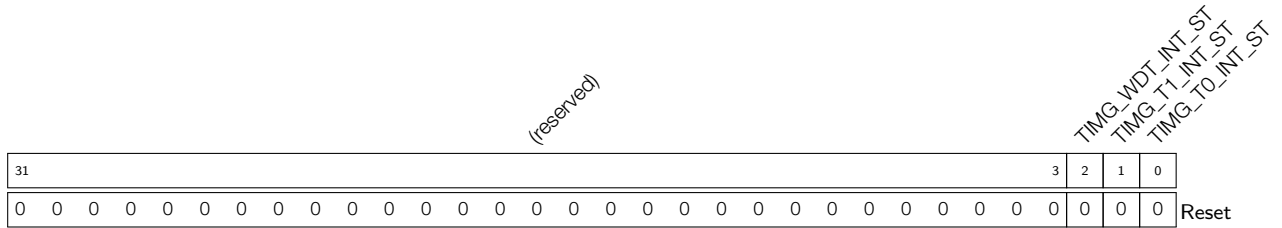

TIMG_T_x_INT_ST The masked interrupt status bit for the TIMG_T_x_INT interrupt. (RO)

TIMG_WDT_INT_ST The masked interrupt status bit for the TIMG_WDT_INT interrupt. (RO)

Register 12.24. TIMG_INT_CLR_TIMERS_REG (0x007C)

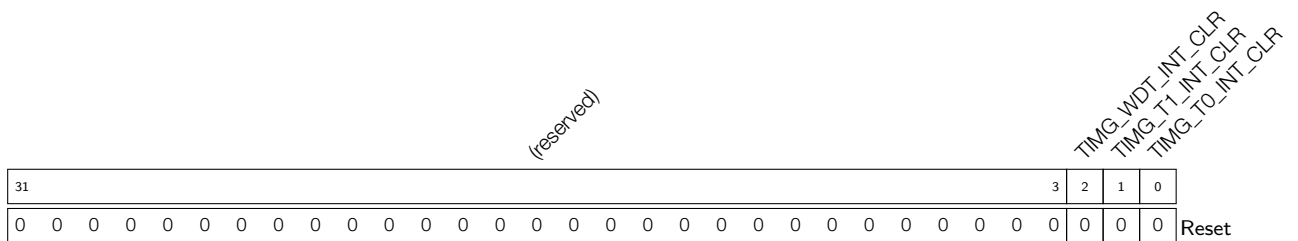

TIMG_T_x_INT_CLR Set this bit to clear the TIMG_T_x_INT interrupt. (WT)

TIMG_WDT_INT_CLR Set this bit to clear the TIMG_WDT_INT interrupt. (WT)

Register 12.25. TIMG_NTIMERS_DATE_REG (0x00F8)

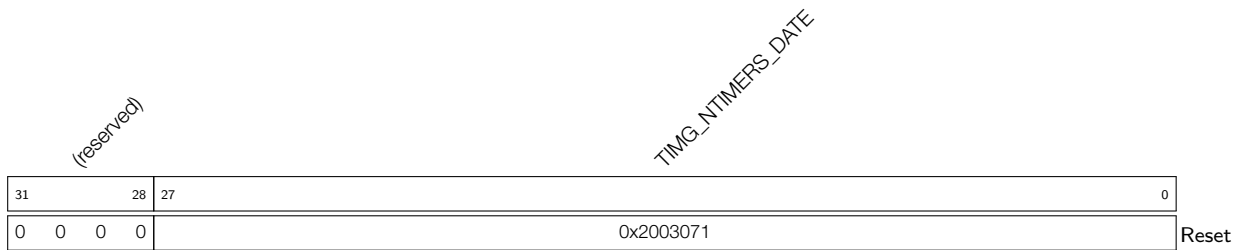

TIMG_NTIMERS_DATE Timer version control register. (R/W)

Register 12.26. TIMG_REGCLK_REG (0x00FC)

TIMG_CLK_EN

(reserved)

31	30		0	
0	0	0	0	0
				Reset

TIMG_CLK_EN Register clock gate signal. 0: The clock used by software to read and write registers is on only when there is software operation. 1: The clock used by software to read and write registers is always on. (R/W)

13 Watchdog Timers (WDT)

13.1 Overview

Watchdog timers are hardware timers used to detect and recover from malfunctions. They must be periodically fed (reset) to prevent a timeout. A system/software that is behaving unexpectedly (e.g. is stuck in a software loop or in overdue events) will fail to feed the watchdog thus trigger a watchdog timeout. Therefore, watchdog timers are useful for detecting and handling erroneous system/software behavior.

As shown in Figure 13-1, ESP32-S3 contains three digital watchdog timers: one in each of the two timer groups in Chapter 12 *Timer Group (TIMG)* (called Main System Watchdog Timers, or MWDT) and one in the RTC Module (called the RTC Watchdog Timer, or RWDT). Each digital watchdog timer allows for four separately configurable stages and each stage can be programmed to take one action upon expiry, unless the watchdog is fed or disabled. MWDT supports three timeout actions: interrupt, CPU reset, and core reset, while RWDT supports four timeout actions: interrupt, CPU reset, core reset, and system reset (see details in Section 13.2.2.2 *Stages and Timeout Actions*). A timeout value can be set for each stage individually.

During the flash boot process, RWDT and the first MWDT in timergroup 0 are enabled automatically in order to detect and recover from booting errors.

ESP32-S3 also has one analog watchdog timer: Super watchdog (SWD). It is an ultra-low-power circuit in analog domain that helps to prevent the system from operating in a sub-optimal state and resets the system if required.

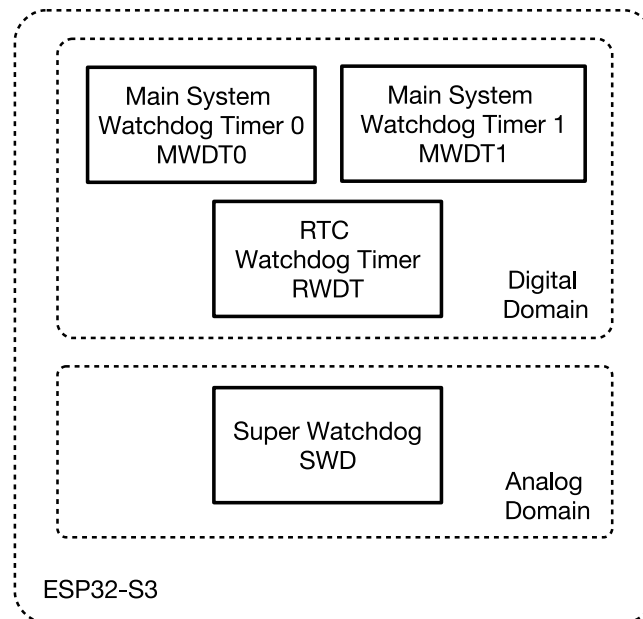

Figure 13-1. Watchdog Timers Overview

Note that while this chapter provides the functional descriptions of the watchdog timer's, their register descriptions are provided in Chapter 12 *Timer Group (TIMG)* and Chapter 10 *Low-power Management (RTC_CNTL)*.

13.2 Digital Watchdog Timers

13.2.1 Features

Watchdog timers have the following features:

- Four stages, each with a programmable timeout value. Each stage can be configured and enabled/disabled separately
- Three timeout actions (interrupt, CPU reset, or core reset) for MWDT and four timeout actions (interrupt, CPU reset, core reset, or system reset) for RWDT upon expiry of each stage
- 32-bit expiry counter
- Write protection, to prevent RWDT and MWDT configuration from being altered inadvertently
- Flash boot protection
If the boot process from an SPI flash does not complete within a predetermined period of time, the watchdog will reboot the entire main system.

13.2.2 Functional Description

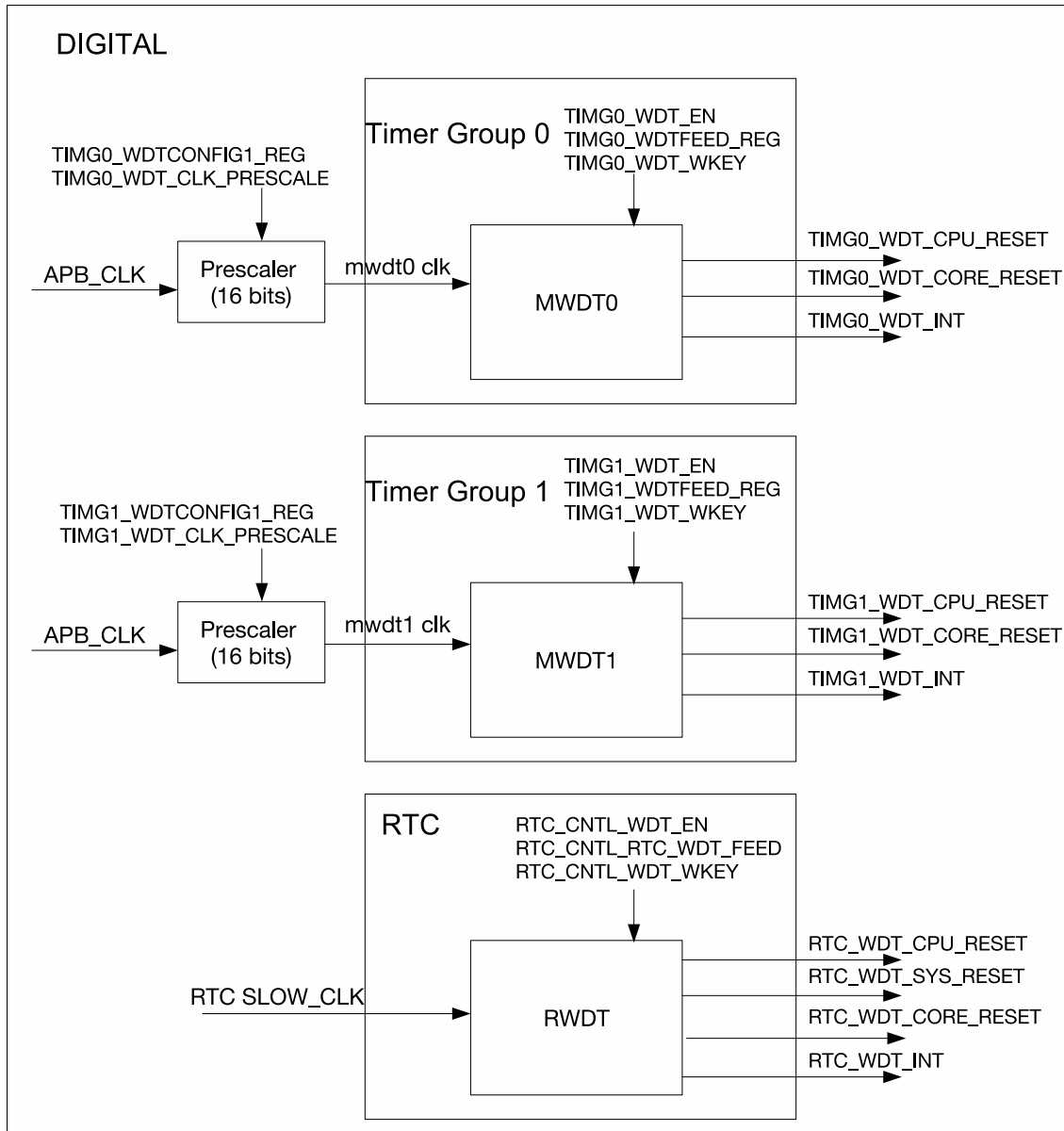

Figure 13-2. Watchdog Timers in ESP32-S3

Figure 13-2 shows the three watchdog timers in ESP32-S3 digital systems.

13.2.2.1 Clock Source and 32-Bit Counter

At the core of each watchdog timer is a 32-bit counter. The clock source of MWDTs is derived from the APB clock via a pre-MWDT 16-bit configurable prescaler. In contrast, the clock source of RWDT is derived directly from an RTC slow clock (the RTC slow clock source shown in Chapter 7 *Reset and Clock*). The 16-bit prescaler for MWDTs is configured via the `TIMG_WDT_CLK_PRESCALE` field of `TIMG_WDTCONFIG1_REG`.

MWDTs and RWDT are enabled by setting the `TIMG_WDT_EN` and `RTC_CNTL_WDT_EN` fields respectively. When enabled, the 32-bit counters of each watchdog will increment on each source clock cycle until the timeout value of the current stage is reached (i.e. expiry of the current stage). When this occurs, the current counter value is reset to zero and the next stage will become active. If a watchdog timer is fed by software, the timer will return

to stage 0 and reset its counter value to zero. Software can feed a watchdog timer by writing any value to [TIMG_WDTFEED_REG](#) for MDWTs and [RTC_CNTL_RTC_WDT_FEED](#) for RWDT.

13.2.2.2 Stages and Timeout Actions

Timer stages allow for a timer to have a series of different timeout values and corresponding expiry action. When one stage expires, the expiry action is triggered, the counter value is reset to zero, and the next stage becomes active. MWDTs/ RWDT provide four stages (called stages 0 to 3). The watchdog timers will progress through each stage in a loop (i.e. from stage 0 to 3, then back to stage 0).

Timeout values of each stage for MWDTs are configured in [TIMG_WDTCONFIG \$i\$ _REG](#) (where i ranges from 2 to 5), whilst timeout values for RWDT are configured using [RTC_CNTL_WDT_STG \$j\$ _HOLD](#) field (where j ranges from 0 to 3).

Please note that the timeout value of stage 0 for RWDT (T_{hold0}) is determined by the combination of the [EFUSE_WDT_DELAY_SEL](#) field of eFuse register [EFUSE_RD_REPEAT_DATA1_REG](#) and [RTC_CNTL_WDT_STG0_HOLD](#). The relationship is as follows:

$$T_{hold0} = \text{RTC_CNTL_WDT_STG0_HOLD} \ll (\text{EFUSE_WDT_DELAY_SEL} + 1)$$

where \ll is a left-shift operator.

Upon the expiry of each stage, one of the following expiry actions will be executed:

- Trigger an interrupt
When the stage expires, an interrupt is triggered.
- CPU reset – Reset a CPU core
When the stage expires, the CPU core will be reset.
- Core reset – Reset the main system
When the stage expires, the main system (which includes MWDTs, CPU, and all peripherals) will be reset. The power management unit and RTC peripheral will not be reset.
- System reset – Reset the main system, power management unit and RTC peripheral
When the stage expires the main system, power management unit and RTC peripheral (see details in Chapter 10 *Low-power Management (RTC_CNTL)*) will all be reset. This action is only available in RWDT.
- Disabled
This stage will have no effects on the system.

Timeout values of each stage for MWDTs are configured in [TIMG_WDTCONFIG \$i\$ _REG](#) (where i ranges from 2 to 5), whilst timeout values for RWDT are configured using [RTC_CNTL_WDT_STG \$j\$ _HOLD](#) field (where j ranges from 0 to 3).

13.2.2.3 Write Protection

Watchdog timers are critical to detecting and handling erroneous system/software behavior, thus should not be disabled easily (e.g. due to a misplaced register write). Therefore, MWDTs and RWDT incorporate a write protection mechanism that prevent the watchdogs from being disabled or tampered with due to an accidental write.

The write protection mechanism is implemented using a write-key field for each timer (`TIMG_WDT_WKEY` for MWDT, `RTC_CNTL_WDT_WKEY` for RWDT). The value `0x50D83AA1` must be written to the watchdog timer's write-key field before any other register of the same watchdog timer can be changed. Any attempts to write to a watchdog timer's registers (other than the write-key field itself) whilst the write-key field's value is not `0x50D83AA1` will be ignored. The recommended procedure for accessing a watchdog timer is as follows:

1. Disable the write protection by writing the value `0x50D83AA1` to the timer's write-key field.
2. Make the required modification of the watchdog such as feeding or changing its configuration.
3. Re-enable write protection by writing any value other than `0x50D83AA1` to the timer's write-key field.

13.2.2.4 Flash Boot Protection

During flash booting process, MWDT in timer group 0 (see Figure 12-1 *Timer Units within Groups*), as well as RWDT, are automatically enabled. Stage 0 for the enabled MWDT is automatically configured to reset the system upon expiry, known as core reset. Likewise, stage 0 for RWDT is configured to system reset, which resets the main system and RTC when it expires. After booting, `TIMG_WDT_FLASHBOOT_MOD_EN` and `RTC_CNTL_WDT_FLASHBOOT_MOD_EN` should be cleared to stop the flash boot protection procedure for both MWDT and RWDT respectively. After this, MWDT and RWDT can be configured by software.

13.3 Super Watchdog

Super watchdog (SWD) is an ultra-low-power circuit in analog domain that helps to prevent the system from operating in a sub-optimal state and resets the system if required. SWD contains a watchdog circuit that needs to be fed for at least once during its timeout period, which is slightly less than one second. About 100 ms before watchdog timeout, it will also send out a `WD_INTR` signal as a request to remind the system to feed the watchdog.

If the system doesn't respond to SWD feed request and watchdog finally times out, SWD will generate a system level signal `SWD_RSTB` to reset whole digital circuits on the chip.

13.3.1 Features

SWD has the following features:

- Ultra-low power
- Interrupt to indicate that the SWD timeout period is close to expiring
- Various dedicated methods for software to feed SWD, which enables SWD to monitor the working state of the whole operating system

13.3.2 Super Watchdog Controller

13.3.2.1 Structure

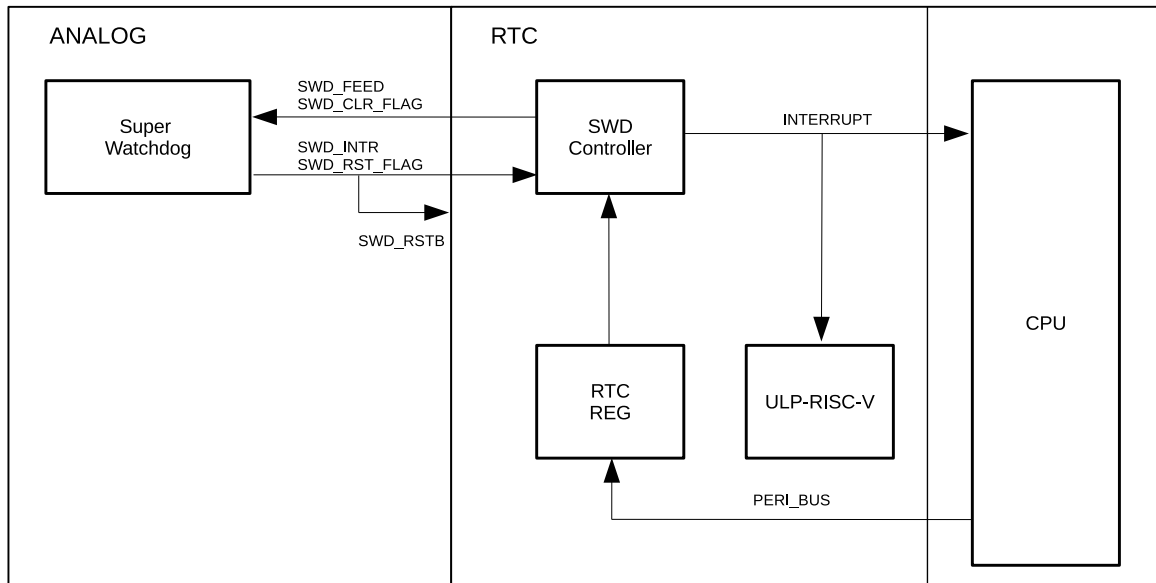

Figure 13-3. Super Watchdog Controller Structure

13.3.2.2 Workflow

In normal state:

- SWD controller receives feed request from SWD.
- SWD controller can send an interrupt to main CPU or ULP-RISC-V.
- Main CPU can decide whether to feed SWD directly by setting `RTC_CNTL_SWD_FEED`, or send an interrupt to ULP-RISC-V and ask ULP-RISC-V to feed SWD by setting `RTC_CNTL_SWD_FEED`.
- When trying to feed SWD, CPU or ULP-RISC-V needs to disable SWD controller's write protection by writing `0x8F1D312A` to `RTC_CNTL_SWD_WKEY`. This prevents SWD from being fed by mistake when the system is operating in sub-optimal state.
- If setting `RTC_CNTL_SWD_AUTO_FEED_EN` to 1, SWD controller can also feed SWD itself without any interaction with CPU or ULP-RISC-V.

After reset:

- Check `RTC_CNTL_RESET_CAUSE_PROCPU[5:0]` for the cause of CPU reset.
If `RTC_CNTL_RESET_CAUSE_PROCPU[5:0] == 0x12`, it indicates that the cause is SWD reset.
- Set `RTC_CNTL_SWD_RST_FLAG_CLR` to clear the SWD reset flag.

13.4 Interrupts

For watchdog timer interrupts, please refer to Section [12.2.6 Interrupts](#) in Chapter [12 Timer Group \(TIMG\)](#).

13.5 Registers

MWDT registers are part of the timer submodule and are described in Section [12.4 Register Summary](#) in Chapter [12 Timer Group \(TIMG\)](#). RWDT and SWD registers are part of the RTC submodule and are described in Section [10.7 Register Summary](#) in Chapter [10 Low-power Management \(RTC_CNTL\)](#).

14 XTAL32K Watchdog Timers (XTWDT)

14.1 Overview

The XTAL32K watchdog timer on ESP32-S3 is used to monitor the status of external crystal XTAL32K_CLK. This watchdog timer can detect the oscillation failure of XTAL32K_CLK, change the clock source of RTC, etc. When XTAL32K_CLK works as the clock source of RTC_SLOW_CLK (for clock description, see Chapter 7 *Reset and Clock*) and stops oscillating, the XTAL32K watchdog timer first switches to BACKUP32K_CLK derived from RC_SLOW_CLK and generates an interrupt (if the chip is in Light-sleep or Deep-sleep mode, the CPU will be woken up), and then switches back to XTAL32K_CLK after it is restarted by software.

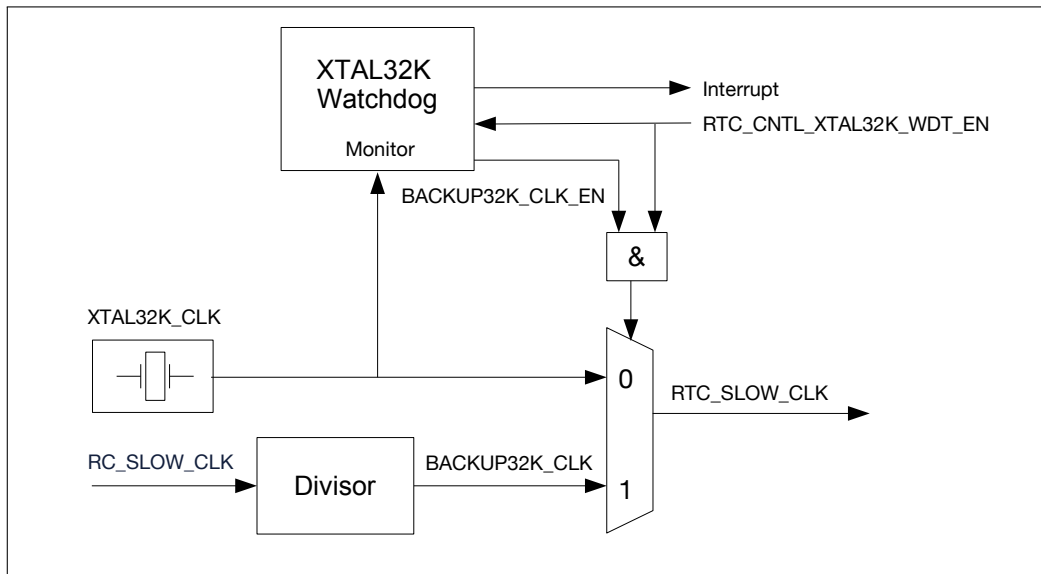

Figure 14-1. XTAL32K Watchdog Timer

14.2 Features

14.2.1 Interrupt and Wake-Up

When the XTAL32K watchdog timer detects the oscillation failure of XTAL32K_CLK, an oscillation failure interrupt `RTC_XTAL32K_DEAD_INT` (for interrupt description, please refer to Chapter 10 *Low-power Management (RTC_CNTL)*) is generated. At this point, the CPU will be woken up if in Light-sleep mode or Deep-sleep mode.

14.2.2 BACKUP32K_CLK

Once the XTAL32K watchdog timer detects the oscillation failure of XTAL32K_CLK, it replaces XTAL32K_CLK with BACKUP32K_CLK (with a frequency of 32 kHz or so) derived from RC_SLOW_CLK as RTC_SLOW_CLK, so as to ensure proper functioning of the system.

14.3 Functional Description

14.3.1 Workflow

1. The XTAL32K watchdog timer starts counting when `RTC_CNTL_XTAL32K_WDT_EN` is enabled. The counter based on `RC_SLOW_CLK` keeps counting until it detects the positive edge of `XTAL_32K` and is then cleared. When the counter reaches `RTC_CNTL_XTAL32K_WDT_TIMEOUT`, it generates an interrupt or a wake-up signal and is then reset.
2. If `RTC_CNTL_XTAL32K_AUTO_BACKUP` is set and step 1 is finished, the XTAL32K watchdog timer will automatically enable `BACKUP32K_CLK` as the alternative clock source of `RTC_SLOW_CLK`, to ensure the system's proper functioning and the accuracy of timers running on `RTC_SLOW_CLK` (e.g. `RTC_TIMER`). For information about clock frequency configuration, please refer to Section 14.3.2.
3. To restore the XTAL32K watchdog timer, software restarts `XTAL32K_CLK` by turning its XPD (meaning no power-down) signal off and on again via `RTC_CNTL_XPD_XTAL_32K` bit. Then, the XTAL32K watchdog timer switches back to `XTAL32K_CLK` as the clock source of `RTC_SLOW_CLK` by clearing `RTC_CNTL_XTAL32K_WDT_EN` (`BACKUP32K_CLK_EN` is also automatically cleared). If the chip is in Light-sleep or Deep-sleep mode, the XTAL32K watchdog timer will wake up the CPU to finish the above steps.

14.3.2 BACKUP32K_CLK Working Principle

Chips have different `RC_SLOW_CLK` frequencies due to production process variations. To ensure the accuracy of `RTC_TIMER` and other timers running on `RTC_SLOW_CLK` when `BACKUP32K_CLK` is at work, the divisor of `BACKUP32K_CLK` should be configured according to the actual frequency of `RC_SLOW_CLK` (see details in Chapter 10 *Low-power Management (RTC_CNTL)*) via `RTC_CNTL_XTAL32K_CLK_FACTOR_REG` register. Each byte in this register corresponds to a divisor component ($x_0 \sim x_7$). `BACKUP32K_CLK` is divided by a fraction where the denominator is always 4, as calculated below.

$$f_{back_clk}/4 = f_{rc_slow_clk}/S$$

$$S = x_0 + x_1 + \dots + x_7$$

f_{back_clk} is the desired frequency of `BACKUP32K_CLK`; $f_{rc_slow_clk}$ is the actual frequency of `RC_SLOW_CLK`; $x_0 \sim x_7$ correspond to the pulse width in high and low state of four `BACKUP32K_CLK` clock signals (unit: `RC_SLOW_CLK` clock cycle).

14.3.3 Configuring the Divisor Component of BACKUP32K_CLK

Based on principles described in Section 14.3.2, you can configure the divisor component as follows:

- Calculate the sum of divisor components S according to the frequency of `RC_SLOW_CLK` and the desired frequency of `BACKUP32K_CLK`;
- Calculate the integer part of divisor $N = f_{rc_slow_clk}/f_{back_clk}$;
- Calculate the integer part of divisor component $M = N/2$. The integer part of divisor N are separated into two parts because a divisor component corresponds to a pulse width in high or low state;
- Calculate the number of divisor components that equal M ($x_n = M$) and the number of divisor components that equal $M + 1$ ($x_n = M + 1$) according to the value of M and S . ($M + 1$) is the fractional part of divisor component.

For example, if the frequency of RC_SLOW_CLK is 163 kHz, then $f_{rc_slow_clk} = 163000$, $f_{back_clk} = 32768$, $S = 20$, $M = 2$, and $\{x_0, x_1, x_2, x_3, x_4, x_5, x_6, x_7\} = \{2, 3, 2, 3, 2, 3, 2, 3\}$. As a result, the frequency of BACKUP32K_CLK is 32.6 kHz.

15 Permission Control (PMS)

15.1 Overview

ESP32-S3 is specially designed for flexible access management to internal memory, external memory, and all peripherals. Once configured, CPU can only access a particular slave device according to the configured permission, thus protecting the slave device from unauthorized access (read, write, or instruction execution).

In addition, ESP32-S3 has integrated a World Controller, which when enabled can be used along with Permission Controller to allocate the chip's hardware and software resource into Secure World (World0) and Non-secure World (World1), and can switch the CPU between running from the Secure World or Non-secure World. For details, please refer to [16 World Controller \(WCL\)](#).

This chapter mainly describes the access management to different internal memory, external memory and peripherals.

15.2 Features

ESP32-S3's Permission Control module supports:

- Independent access management for the Secure World and Non-secure World.
- Independent access management to internal memory, including
 - CPU access to internal memory
 - Allocate internal memory as CPU Trace
 - GDMA access to internal memory
- Independent access management to external memory, including
 - SPI1 access to external memory
 - GDMA access to external memory
 - CACHE access to external memory
- Independent access management to peripheral regions, including
 - CPU access to peripheral regions
 - Interrupt upon unsupported access alignment
- Address splitting for more flexible access management
- Interrupt upon unauthorized access
- Register locks to secure the integrity of Permission Control related registers
- Protection to secure the integrity of CPU's VECBASE registers

15.3 Internal Memory

ESP32-S3 has the following types of internal memory:

- ROM: 384 KB in total, including 256 KB Internal ROM0 and 128 KB Internal ROM1

- SRAM: 512 KB in total, including 32 KB Internal SRAM0, 416 KB Internal SRAM1, and 64 KB Internal SRAM2
- RTC FAST Memory: 8 KB in total, which can be split into two regions with independent permission configuration
- RTC SLOW Memory: 8 KB in total, which can be further split into two regions each with independent permission configuration

This section describes how to configure the permission to each types of ESP32-S3's internal memory.

15.3.1 ROM

ESP32-S3's ROM can be accessed by CPU's instruction bus (IBUS) and data bus (DBUS) when configured.

Note:

- Permission for Secure World and Non-secure World can be configured independently.
- Once configured, the permission applies for both CPU0 and CPU1.

15.3.1.1 Address

ESP32-S3's ROM address and the address ranges accessible for IBUS and DBUS respectively are listed in Table 15-1.

Table 15-1. ROM Address

ROM	IBUS Address		DBUS Address	
	Starting Address	Ending Address	Starting Address	Ending Address
Internal ROM0	0x4000_0000	0x4003_FFFF	-	-
Internal ROM1	0x4004_0000	0x4005_FFFF	0x3FF0_0000	0x3FF1_FFFF

15.3.1.2 Access Configuration

ESP32-S3 uses the registers listed in Table 15-2 to configure the instruction execution (X), write (W) and read (R) accesses of CPU's IBUS and DBUS, from the Secure World and Non-secure World, to ROM:

Table 15-2. Access Configuration to ROM

Bus	From World	Configuration Registers ^A	Access
IBUS	Secure World	PMS_CORE_X_IRAM0_PMS_CONSTRIN_2_REG [20:18]^B	X/W/R
	Non-secure World	PMS_CORE_X_IRAM0_PMS_CONSTRIN_1_REG [20:18]	X/W/R
DBUS	Secure World	PMS_CORE_X_DRAM0_PMS_CONSTRIN_1_REG [25:24]^C	W/R
	Non-secure World	PMS_CORE_X_DRAM0_PMS_CONSTRIN_1_REG [27:26]	W/R

^A 1: with access; 0: without access

^B For example, configuring this field to 0b101 indicates CPU's IBUS is granted with instruction execution and read accesses but not write access to ROM from the Secure World.

^C For example, configuring this field to 0b01 indicates CPU's DBUS is granted with read access but not write access to ROM from the Secure World.

15.3.2 SRAM

ESP32-S3's SRAM can be accessed by CPU's instruction bus (IBUS) and data bus (DBUS) when configured.

Note:

- Permission for Secure World and Non-secure World can be configured independently.
- Once configured, the configuration applies for both CPU0 and CPU1.

15.3.2.1 Address

ESP32-S3's SRAM address and the address ranges accessible for IBUS and DBUS respectively are listed in Table 15-3.

Table 15-3. SRAM Address

SRAM	Block	IBUS Address		DBUS Address	
		Starting Address	Ending Address	Starting Address	Ending Address
Internal SRAM0	Block0	0x4037_0000	0x4037_3FFF	-	-
	Block1	0x4037_4000	0x4037_7FFF	-	-
Internal SRAM1	Block2	0x4037_8000	0x4037_FFFF	0x3FC8_8000	0x3FC8_FFFF
	Block3	0x4038_0000	0x4038_FFFF	0x3FC9_0000	0x3FC9_FFFF
	Block4	0x4039_0000	0x4039_FFFF	0x3FCA_0000	0x3FCA_FFFF
	Block5	0x403A_0000	0x403A_FFFF	0x3FCB_0000	0x3FCB_FFFF
	Block6	0x403B_0000	0x403B_FFFF	0x3FCC_0000	0x3FCC_FFFF
	Block7	0x403C_0000	0x403C_FFFF	0x3FCD_0000	0x3FCD_FFFF
Internal SRAM 2	Block8	0x403D_0000	0x403D_FFFF	0x3FCE_0000	0x3FCE_FFFF
	Block9	-	-	0x3FCF_0000	0x3FCF_7FFF
	Block10	-	-	0x3FCF_8000	0x3FCF_FFFF

Here, we will first introduce how to configure the permission to Internal SRAM0, Internal SRAM1, and Internal SRAM2, and also how to configure the Internal SRAM1 as CPU Trace memory.

15.3.2.2 Internal SRAM0 Access Configuration

ESP32-S3's Internal SRAM0 includes Block0 and Block1 (see details in Table 15-3) and can be allocated to either CPU or ICACHE.

Note that once configured, the configuration applies for both CPU0 and CPU1.

ESP32-S3 uses the register described in Table 15-4 to allocate the SRAM0 to either CPU or ICACHE:

Table 15-4. Internal SRAM0 Usage Configuration

	Block	PMS_INTERNAL_SRAM_USAGE_1_REG ^A
SRAM	Block0	[0] ^B
	Block1	[1]

^A Set this bit to allocate a certain block to CPU. Clear this bit to allocate a certain block to ICACHE.

^B For example, setting this bit indicates Block0 is allocated to CPU.

When a certain block is allocated to CPU, ESP32-S3 uses the registers listed in Table 15-5 to configure the instruction execution (X), write (W) and read (R) accesses of CPU's IBUS, from the Secure World and Non-secure World, to this block:

Table 15-5. Access Configuration to Internal SRAM0

Bus ^A	From World	Configuration Registers ^B	SRAM0		Access
			Block0	Block1	
IBUS	Secure World	PMS_CORE_X_IRAM0_PMS_CONSTRAIN_2_REG	[14:12] ^C	[17:15]	X/W/R
	Non-secure World	PMS_CORE_X_IRAM0_PMS_CONSTRAIN_1_REG	[14:12]	[17:15]	X/W/R

^A To access the Internal SRAM0, CPU must be configured with both the [usage](#) permission and respective access permission.

^B 1: with access; 0: without access

^C For example, configuring this field to 0b101 indicates CPU's IBUS is granted with instruction execution and read accesses but not write access to SRAM Block0 from the Non-secure World.

15.3.2.3 Internal SRAM1 Access Configuration

ESP32-S3's Internal SRAM1 includes Block2 ~ Block8 (see details in Table 15-3) and can be:

- Accessed by CPU's DBUS, IBUS and GDMA at the same time
- Can be configured to be used as Trace memory
- Further split into up to 6 regions with independent access management for more flexible permission control.

ESP32-S3's Internal SRAM1 can be further split into up to 6 regions with 5 split lines. Users can configure different access to each region independently.

To be more specific, the Internal SRAM1 can be first split into Instruction Region and Data Region by IRam0_DRam0_split_line:

- Instruction Region:
 - Then the Instruction Region should be only configured to be accessed by IBUS;
 - And can be further split into three split regions by IRam0_split_line_0 and IRam0_split_line_1.
- Data Region:
 - The Data Region should be only configured to be accessed by DBUS;
 - And can be further split into three split regions by DRam0_split_line_0 and DRam0_split_line_1.

See illustration in Figure 15-1 and Table 15-6 below.

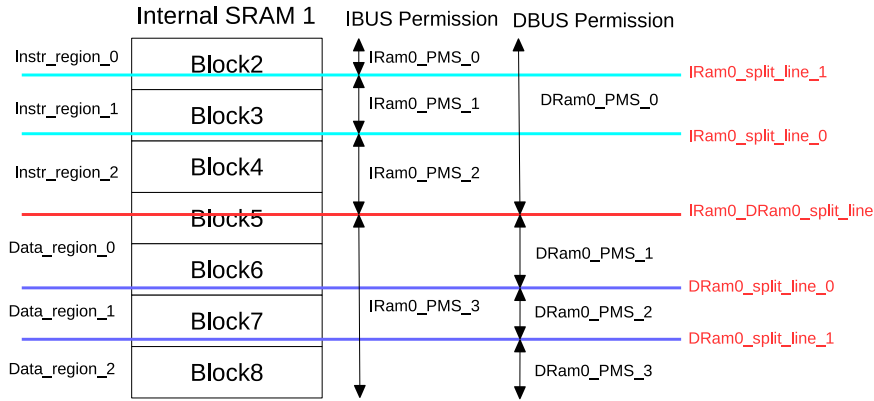

Figure 15-1. Split Lines for Internal SRAM1

Table 15-6. Internal SRAM1 Split Regions

Internal Memory ^A	Instruction / Data Regions	Split Regions ^B
SRAM1	Instruction Region	Instr_Region_0
		Instr_Region_1
		Instr_Region_2
	Data Region	Data_Region_0
		Data_Region_1
		Data_Region_2

^A See description below on how to configure the split lines.

^B Access to each split region can be configured independently. See details in Table 15-7 and 15-8.

Internal SRAM1 Split Regions

ESP32-S3 allows users to configure the split lines to their needs with registers below:

- Split line to split the Instruction and Data regions (IRam0_DRam0_split_line):
 - [PMS_CORE_X_IRAM0_DRAM0_DMA_SPLIT_LINE_CONSTRAN_1_REG](#)
- The first split line to further split the Instruction Region (IRam0_split_line_0):
 - [PMS_CORE_X_IRAM0_DRAM0_DMA_SPLIT_LINE_CONSTRAN_2_REG](#)
- The second split line to further split the Instruction Region (IRam0_split_line_1):
 - [PMS_CORE_X_IRAM0_DRAM0_DMA_SPLIT_LINE_CONSTRAN_3_REG](#)
- The first split line to further split the data Region (DRam0_split_line_0):
 - [PMS_CORE_X_IRAM0_DRAM0_DMA_SPLIT_LINE_CONSTRAN_4_REG](#)
- The second split line to further split the data Region (DRam0_split_line_1):
 - [PMS_CORE_X_IRAM0_DRAM0_DMA_SPLIT_LINE_CONSTRAN_5_REG](#)

When configuring the split lines,

1. First configure the block in which the split line is by:

- Configuring the Category_x field for the block in which the split line is to 0x1 or 0x2 (no difference)
- Configuring the Category₀ ~ Category_{x-1} fields for all the preceding blocks to 0x0
- Configuring the Category_{x+1} ~ Category₆ fields for all blocks afterwards to 0x3

For example, assuming you want to configure the split line in Block5, then first configure the Category₃ field for Block5 to 0x1 or 0x2; configure the Category₀ ~ Category₂ fields for Block2 ~ Block4 to 0x0; and configure the Category₄ ~ Category₆ fields for Block6 ~ Block8 to 0x3 (see illustration in Figure 15-2). On the other hand, when reading 0x1 or 0x2 from Category₃, then you know the split line is in Block5.

2. Configure the position of the split line inside of the configured block by:

- Writing the [15:8] bits of the actual address at which you want to split the memory to the `SPLITADDR` field for the block in which the split line is.
- Note that the split address must be aligned to 256 bytes, meaning you can only write the integral multiples of 0x100 to the `SPLITADDR` field.

For example, if you want to split the instruction region at 0x3fc88000, then write the [15:8] bits of this address, which is 0b10000000, to `SPLITADDR`.

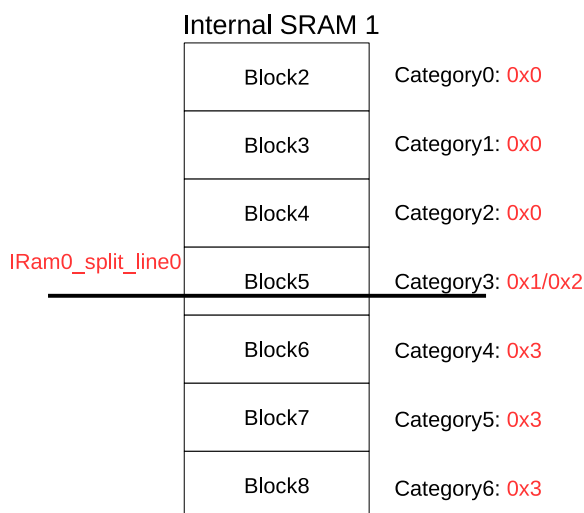

Figure 15-2. An illustration of Configuring the Category fields

Note the following points when configuring the split lines:

- Position:
 - The split line that splitting the Instruction Region and Data Region can be configured anywhere inside Internal SRAM1.
 - The two split lines further splitting the Instruction Region into 3 split regions must stay inside the Instruction Region.
 - The two split lines further splitting the Data Region into 3 split regions must stay inside the Data Region.
- Split lines can overlap with each other. For example,
 - When the two split lines inside the Data Region are not overlapping with each other, then the Data Region is split into 3 split regions

- When the two split lines inside the Data Region are overlapping with each other, then the Data Region is only split into 2 split regions
- When the two split lines inside the Data Region are not only overlapping with each other but also with the split line that splits the Data Region and the Instruction Region, then the Data Region is not split at all and only has one region.

Access Configuration

After configuring the split lines, users can then use the registers described in the Table 15-7 and Table 15-8 below to configure the access of CPU's IBUS, DBUS and GDMA peripherals, from the Secure World and Non-secure World, to these split regions independently.

Table 15-7. Access Configuration to the Instruction Region of Internal SRAM1

Buses	From World	Configuration Registers	Instruction Region			Access
			instr_region_0	instr_region_1	instr_region_2	
IBUS	Secure World	PMS_CORE_X_IRAM0_PMS_CONSTRAIN_2_REG	[2:0]	[5:3]	[8:6]	X/W/R
	Non-secure World	PMS_Core_X_IRAM0_PMS_CONSTRAIN_1_REG	[2:0]	[5:3]	[8:6]	X/W/R
DBUS	Secure World	PMS_Core_X_DRAM0_PMS_CONSTRAIN_1_REG	[1:0] ^A			W/R
	Non-secure World		[13:12] ^A			W/R
GDMA	XX Peripherals ^C	PMS_DMA_APBPERI_XX_PMS_CONSTRAIN_1_REG	[1:0] ^B			W/R

^A Configure DBUS' access to the Instruction Region. However, it's recommended to configure these bits to 0.

^B Configure GDMA's access to the Instruction Region. However, it's recommended to configure these bits to 0.

^C ESP32-S3 has 9 peripherals, including SPI2, SPI3, UCHI0, I2S0, I2S1, AES, SHA, ADC, LCD_CAM, USB, SDIO_HOST, and RMT, which can access Internal SRAM1 via GDMA. Each peripherals can be configured with different access to the Internal SRAM1 independently.

Table 15-8. Access Configuration to the Data Region of Internal SRAM1

Buses	From World	Configuration Registers	Data Region			Access
			data_region_0	data_region_1	data_region_2	
IBUS	Secure World	PMS_CORE_X_IRAM0_PMS_CONSTRAIN_2_REG	[11:9] ^A			X/W/R
	Non-secure World	PMS_CORE_X_IRAM0_PMS_CONSTRAIN_1_REG	[11:9] ^A			X/W/R
DBUS	Secure World	PMS_Core_X_DRAM0_PMS_CONSTRAIN_1_REG	[3:2]	[5:4]	[7:6]	W/R
	Non-secure World		[15:14]	[17:16]	[19:18]	W/R
GDMA	XX ^B	PMS_DMA_APBPERI_XX_PMS_CONSTRAIN_1_REG	[3:2]	[5:4]	[7:6]	W/R

^A Configure IBUS' access to the Data Region. However, it's recommended to configure these bits to 0.

^B ESP32-S3 has 9 peripherals, including SPI2, SPI3, UCHI0, I2S0, I2S1, AES, SHA, ADC, LCD_CAM, USB, SDIO_HOST, and RMT, which can access Internal SRAM1 via GDMA. Each peripherals can be configured with different access to the Internal SRAM1 independently.

For details on how to configure the split lines, see Section 15.3.2.3.

Trace Memory

ESP32-S3 has a low-power Xtensa® dual-core 32-bit LX7 microprocessor, which integrates a TRAX (Real-time Trace) module for easier debugging. For the TRAX module to work, users need to allocate 16 KB from the Internal SRAM1 as Trace memory. Note that, the Trace memories for CPU0 and CPU1 can be configured independently.

Users can allocate 16 KB from Internal SRAM1 as Trace memory by configuring the [PMS_INTERNAL_SRAM_USAGE_2_REG](#) register.

Detailed steps are provided below:

1. First choose a block from Block2 ~ Block8 by writing 1 to the respective bit in the [PMS_INTERNAL_SRAM_CORE \$m\$ _TRACE_USAGE](#) field
 - Block2: 0b00000001
 - Block3: 0b00000010
 - Block4: 0b00000100
 - Block5: 0b00001000
 - Block6: 0b00010000
 - Block7: 0b00100000
 - Block8: 0b01000000
2. Then choose 16 KB from this block as the Trace memory by configuring the [PMS_INTERNAL_SRAM_CORE \$m\$ _TRACE_ALLOC](#) field
 - 2'b00: the first 16 KB
 - 2'b01: the second 16 KB
 - 2'b10: the third 16 KB
 - 2'b11: the fourth 16 KB

Note that Block2 is only 32 KB, so you can only configure this field to 2'b00 or 2'b0 when Block2 is selected in the first step.

For example, if you want to choose the first 16 KB of Internal SRAM1 Block3's as CPU0's trace memory, then you need to:

- Write 0b0000010 to the [PMS_INTERNAL_SRAM_CORE0_TRACE_USAGE](#) field to select Block3
- Write 2'b00 to the [PMS_INTERNAL_SRAM_CORE0_TRACE_ALLOC](#) field to select the first 16 KB.

15.3.2.4 Internal SRAM2 Access Configuration

ESP32-S3's Internal SRAM2 includes Block9 and Block10 (see details in Table 15-3), which can be allocated to either CPU/GDMA or DCACHE. Note that once configured, the configuration applies to both CPU0 and CPU1.

ESP32-S3 uses registers described in Table 15-9 to configure the Internal SRAM2 for CPU/GDMA or DCACHE.

Table 15-9. Internal SRAM2 Usage Configuration

	Block	PMS_INTERNAL_SRAM_USAGE_1_REG ^A
SRAM	Block9 ^B	[3]
	Block10	[2]

^A Set this bit to allocate a certain block to CPU/GDMA. Clear this bit to allocate a certain block to DCACHE.

^B For example, setting this bit indicates Block9 is allocated to CPU/GDMA.

When a certain block is allocated to CPU/GDMA, ESP32-S3 uses the registers listed in Table 15-10 to configure the write (W) and read (R) accesses of CPU's DBUS, from the Secure World and Non-secure World, to this block:

Table 15-10. Access Configuration to Internal SRAM2

Bus ^A	From World	Configuration Registers	SRAM2		Access ^B
			Block9	Block10	
DBUS	Secure World	PMS_CORE_X_DRAM0_PMS_CONSTRAN_1_REG	[9:8] ^C	[11:10]	W/R
	Non-secure World	PMS_CORE_X_DRAM0_PMS_CONSTRAN_1_REG	[21:20]	[23:22]	W/R
GDMA	XX Peripherals ^B	PMS_DMA_APBPERI_XX_PMS_CONSTRAN_1_REG	[9:8]	[11:10]	W/R

^A To access the Internal SRAM2, the CPU / GDMA must be configured with both the [usage](#) permission and respective access permission.

^B 1: with access; 0: without access

^C For example, configuring this field to 0b10 indicates CPU's DBUS is granted with write access but not read access from the Secure World to the Block9 of Internal SRAM2.

15.3.3 RTC FAST Memory

15.3.3.1 Address

ESP32-S3's RTC FAST Memory is 8 KB. See the address of RTC FAST Memory below:

Table 15-11. RTC FAST Memory Address

Memory	Starting Address	Ending Address
RTC FAST Memory	0x600F_E000	0x600F_FFFF

15.3.3.2 Access Configuration

ESP32-S3's RTC FAST Memory can be further split into 2 regions. Each split region can be configured independently with different access by configuring respective registers ([PMS_CORE_m_PIF_PMS_CONSTRAN_n_REG](#)).

Note that split regions can be configured independently for CPU0 and CPU1 and for the Secure World and Non-secure World.

The Register for configuring the split line is described below:

Table 15-12. Split RTC FAST Memory into the Higher Region and the Lower Region

Memory	Split Regions	Configuration Register ¹	
		Secure World	Non-secure World
RTC FAST Memory	Higher Region	PIF_PMS_CONSTRAN_9_REG [10:0]	PIF_PMS_CONSTRAN_9_REG [21:11]
	Lower Region		

¹ The offset from the RTC FAST Memory base address should be used when configuring the split address. For example, if you want to split the RTC FAST Memory at 0x600F_F000, then write 0x1000 to this register.

Access configuration for the higher and lower regions of the RTC FAST Memory is described below:

Table 15-13. Access Configuration to the RTC FAST Memory

Bus	RTC FAST Memory	Configuration Registers		Access ^A
		Secure World	Non-secure World	
Peri Bus (PIF)	Higher Region	PIF_PMS_CONSTRAN_10_REG [5:3] ^B	PIF_PMS_CONSTRAN_10_REG [11:9]	X/W/R
	Lower Region	PIF_PMS_CONSTRAN_10_REG [2:0]	PIF_PMS_CONSTRAN_10_REG [8:6]	

^A 1: with access; 0: without access

^B For example, configuring this field to 0b101 indicates CPU's peripheral (PIF) bus is granted with the instruction execution and read accesses but not the read access from the Secure WORLD to the higher region of RTC FAST Memory.

15.3.4 RTC SLOW Memory

15.3.4.1 Address

ESP32-S3's RTC SLOW Memory is 8 KB. This memory can be accessed using two addresses, i.e, RTCSlow_0 and RTCSlow_1. See details in Table 15-14 below:

Table 15-14. RTC SLOW Memory Address

RTC SLOW Memory	Starting Address	Ending Address
RTCSlow_0	0x5000_0000	0x5000_1FFF
RTCSlow_1	0x6002_1000	0x6002_2FFF

15.3.4.2 Access Configuration

Both ESP32-S3's RTCSlow_0 and RTCSlow_1 can be further split into 2 regions. Each split region can be configured independently with different access by configuring respective registers ([PMS_CORE_m_PIF_PMS_CONSTRAN_n_REG](#)).

Note that split regions can be configured independently for CPU0 and CPU1 and for the Secure World and Non-secure World.

The registers for splitting RTC SLOW Memory into 4 split regions are described below:

Table 15-15. Split RTCSlow_0 and RTCSlow_1 into Split Regions

Memory	Split Regions	Configuration Registers ¹	
		Secure World	Non-secure World
RTCSlow_0	Higher Region	PIF_PMS_CONSTRAN_11_REG [10:0]	PIF_PMS_CONSTRAN_9_REG [21:11]
	Lower Region		
RTCSlow_1	Higher Region	PIF_PMS_CONSTRAN_13_REG [10:0]	PIF_PMS_CONSTRAN_13_REG [21:11]
	Lower Region		

¹ The offset from the RTC SLOW Memory base address should be used when configuring the split address. For example, if you want to split the RTC SLOW Memory at 0x6002_2000, then write 0x1000 to this register.

Access configuration to the split regions of RTC SLOW Memory is described below:

Table 15-16. Access Configuration to the RTC SLOW Memory

Bus	Mem	Split Regions	Configuration Registers		Access
			Secure World	Non-secure World	
Peri	RTC Slow_0	Higher ^A	PIF_PMS_CONSTRAN_12_REG [5:3] ^C	PIF_PMS_CONSTRAN_12_REG [11:9]	X/W/R
		Lower ^B	PIF_PMS_CONSTRAN_12_REG [2:0]	PIF_PMS_CONSTRAN_12_REG [8:6]	
Bus (PIF)	RTC Slow_1	Higher ^A	PIF_PMS_CONSTRAN_14_REG [5:3]	PIF_PMS_CONSTRAN_14_REG [11:9]	
		Lower ^B	PIF_PMS_CONSTRAN_14_REG [2:0]	PIF_PMS_CONSTRAN_14_REG [8:6]	

^A Higher is short for Higher Region.

^B Lower is short for Lower Region.

^C For example, configuring this field to 0b100 indicates CPU's peripheral (PIF) bus is granted with the instruction execution access but not the write or read accesses from the Secure WORLD to the higher region of RTCSLOW_0.

15.4 Peripherals

15.4.1 Access Configuration

ESP32-S3's CPU can be configured with different read (R) and write (W) accesses to most of its modules and peripherals independently, from the Secure World and the Non-secure World, by configuring respective registers ([PMS_CORE_m_PIF_PMS_CONSTRAN_n_REG](#)).

Note that permission to modules and peripherals can be configured independently for CPU0 and CPU1 and for the Secure World and Non-secure World.

Notes on [PMS_CORE_m_PIF_PMS_CONSTRAN_n_REG](#):

- *m* can be 0 or 1 for CPU0 and CPU1 respectively.
- *n* can be 1~8, in which 1~4 are for Secure World and 5~8 are for Non-secure World.

For example, users can configure [PMS_CORE_0_PIF_PMS_CONSTRAN_1_REG \[1:0\]](#) to 0x2, meaning CPU0 is granted with read access but not write access from the Secure World to UART0. In this case, CPU0 won't be able to modify the UART0's internal registers when in Secure World.

Table 15-17. Access Configuration of the Peripherals

Peripherals	Secure World	Non-secure World	Bit ³
GDMA	PIF_PMS_CONSTRAN_4_REG	PIF_PMS_CONSTRAN_8_REG	[7:6]
eFuse Controller & PMU ²	PIF_PMS_CONSTRAN_1_REG	PIF_PMS_CONSTRAN_5_REG	[15:14]
IO_MUX	PIF_PMS_CONSTRAN_1_REG	PIF_PMS_CONSTRAN_5_REG	[17:16]
GPIO	PIF_PMS_CONSTRAN_1_REG	PIF_PMS_CONSTRAN_5_REG	[7:6]
Interrupt Matrix	PIF_PMS_CONSTRAN_4_REG	PIF_PMS_CONSTRAN_8_REG	[21:20]
System Timer	PIF_PMS_CONSTRAN_2_REG	PIF_PMS_CONSTRAN_6_REG	[31:30]
Timer Group 0	PIF_PMS_CONSTRAN_2_REG	PIF_PMS_CONSTRAN_6_REG	[27:26]
Timer Group 1	PIF_PMS_CONSTRAN_2_REG	PIF_PMS_CONSTRAN_6_REG	[29:28]
World Controller	PIF_PMS_CONSTRAN_4_REG	PIF_PMS_CONSTRAN_8_REG	[31:30]
System Registers	PIF_PMS_CONSTRAN_4_REG	PIF_PMS_CONSTRAN_8_REG	[17:16]
Sensitive Registers	PIF_PMS_CONSTRAN_4_REG	PIF_PMS_CONSTRAN_8_REG	[19:18]
Debug Assist	PIF_PMS_CONSTRAN_4_REG	PIF_PMS_CONSTRAN_8_REG	[27:26]
Accelerators ¹	PIF_PMS_CONSTRAN_4_REG	PIF_PMS_CONSTRAN_8_REG	[5:4]
CACHE & XTS_AES ²	PIF_PMS_CONSTRAN_4_REG	PIF_PMS_CONSTRAN_8_REG	[25:25]
UART 0	PIF_PMS_CONSTRAN_1_REG	PIF_PMS_CONSTRAN_5_REG	[1:0]
UART 1	PIF_PMS_CONSTRAN_1_REG	PIF_PMS_CONSTRAN_5_REG	[31:30]
UART 2	PIF_PMS_CONSTRAN_3_REG	PIF_PMS_CONSTRAN_7_REG	[17:16]
SPI 0	PIF_PMS_CONSTRAN_1_REG	PIF_PMS_CONSTRAN_5_REG	[5:4]
SPI 1	PIF_PMS_CONSTRAN_1_REG	PIF_PMS_CONSTRAN_5_REG	[3:2]
SPI 2	PIF_PMS_CONSTRAN_3_REG	PIF_PMS_CONSTRAN_7_REG	[1:0]
SPI 3	PIF_PMS_CONSTRAN_3_REG	PIF_PMS_CONSTRAN_7_REG	[3:2]
I2C 0	PIF_PMS_CONSTRAN_2_REG	PIF_PMS_CONSTRAN_6_REG	[5:4]
I2C 1	PIF_PMS_CONSTRAN_3_REG	PIF_PMS_CONSTRAN_7_REG	[7:6]
I2S 0	PIF_PMS_CONSTRAN_1_REG	PIF_PMS_CONSTRAN_5_REG	[29:28]
I2S 1	PIF_PMS_CONSTRAN_3_REG	PIF_PMS_CONSTRAN_7_REG	[15:14]
Pulse Count Controller	PIF_PMS_CONSTRAN_2_REG	PIF_PMS_CONSTRAN_6_REG	[13:12]
USB Serial/JTAG Controller	PIF_PMS_CONSTRAN_4_REG	PIF_PMS_CONSTRAN_8_REG	[1:0]
USB OTG Core	PIF_PMS_CONSTRAN_4_REG	PIF_PMS_CONSTRAN_8_REG	[15:14]
USB OTG External	PIF_PMS_CONSTRAN_4_REG	PIF_PMS_CONSTRAN_8_REG	[3:2]
Two-wire Automotive Interface	PIF_PMS_CONSTRAN_3_REG	PIF_PMS_CONSTRAN_7_REG	[11:10]
UHCI 0	PIF_PMS_CONSTRAN_2_REG	PIF_PMS_CONSTRAN_6_REG	[7:6]
SD/MMC Host Controller	PIF_PMS_CONSTRAN_3_REG	PIF_PMS_CONSTRAN_7_REG	[9:8]
LED PWM Controller	PIF_PMS_CONSTRAN_2_REG	PIF_PMS_CONSTRAN_6_REG	[17:16]
Motor Control PWM 0	PIF_PMS_CONSTRAN_2_REG	PIF_PMS_CONSTRAN_6_REG	[25:24]
Motor Control PWM 1	PIF_PMS_CONSTRAN_3_REG	PIF_PMS_CONSTRAN_7_REG	[13:12]
Remote Control Peripheral	PIF_PMS_CONSTRAN_2_REG	PIF_PMS_CONSTRAN_6_REG	[11:10]
Camera-LCD Controller	PIF_PMS_CONSTRAN_4_REG	PIF_PMS_CONSTRAN_8_REG	[11:10]
APB Controller	PIF_PMS_CONSTRAN_3_REG	PIF_PMS_CONSTRAN_7_REG	[5:4]
ADC Controller	PIF_PMS_CONSTRAN_4_REG	PIF_PMS_CONSTRAN_8_REG	[9:8]

¹ : Accelerators: AES, SHA, RSA, Digital Signatures, HMAC

² : This is shared by more than one peripherals.

³ : Access: R/W

15.4.2 Split Peripheral Regions into Split Regions

Each of ESP32-S3's peripheral region can be further split into 11 regions (from Peri Region0 ~ Peri Region10) for more flexible permission control.

For example, the registers for ESP32-S3's GDMA controller are allocated as:

- 5 sets of registers for 5 of each RX channel
- 5 sets of registers for 5 of each TX channel
- 1 set of registers for configuration

As seen above, GDMA's peripheral region is divided into 11 split regions (implemented in hardware), which can be configured with different permission independently, thus achieving independent permission control to each GDMA channel.

Users can configure CPU's read (R) and write (W) accesses to a specific split region (Peri Region n) from the Secure World and the Non-secure World by configuring `PMS_CORE_m_Region_PMS_CONSTRAN_n_REG`. Note that permission can be configured independently for CPU0 and CPU1.

Notes on `PMS_CORE_m_Region_PMS_CONSTRAN_n_REG`:

- m can be 0 or 1 for CPU0 and CPU1 respectively.
- n can be 1~14, in which
 - `Region_PMS_CONSTRAN_1_REG` is for configuring CPU's permission from the Secure World.
 - `Region_PMS_CONSTRAN_2_REG` is for configuring CPU's permission from the Non-secure World.
 - `Region_PMS_CONSTRAN_n_REG` $n = 3\sim 14$ are used to configuring the starting addresses for each Peri Regions. Note the starting address of each Peri Region is also the ending address of the previous Peri Region.

Table 15-18. Access Configuration of Peri Regions

Peri Regions	Starting Address Configuration	Access Configuration	
		Secure World	NON-secure World
Peri Region0	<code>Region_PMS_CONSTRAN_3_REG</code>	<code>Region_PMS_CONSTRAN_1_REG</code> [1:0]	<code>Region_PMS_CONSTRAN_2_REG</code> [1:0]
Peri Region1	<code>Region_PMS_CONSTRAN_4_REG</code>	<code>Region_PMS_CONSTRAN_1_REG</code> [3:2]	<code>Region_PMS_CONSTRAN_2_REG</code> [3:2]
Peri Region2	<code>Region_PMS_CONSTRAN_5_REG</code>	<code>Region_PMS_CONSTRAN_1_REG</code> [5:4]	<code>Region_PMS_CONSTRAN_2_REG</code> [5:4]
Peri Region3	<code>Region_PMS_CONSTRAN_6_REG</code>	<code>Region_PMS_CONSTRAN_1_REG</code> [7:6]	<code>Region_PMS_CONSTRAN_2_REG</code> [7:6]
Peri Region4	<code>Region_PMS_CONSTRAN_7_REG</code>	<code>Region_PMS_CONSTRAN_1_REG</code> [9:8]	<code>Region_PMS_CONSTRAN_2_REG</code> [9:8]
Peri Region5	<code>Region_PMS_CONSTRAN_8_REG</code>	<code>Region_PMS_CONSTRAN_1_REG</code> [11:10]	<code>Region_PMS_CONSTRAN_2_REG</code> [11:10]
Peri Region6	<code>Region_PMS_CONSTRAN_9_REG</code>	<code>Region_PMS_CONSTRAN_1_REG</code> [13:12]	<code>Region_PMS_CONSTRAN_2_REG</code> [13:12]
Peri Region7	<code>Region_PMS_CONSTRAN_10_REG</code>	<code>Region_PMS_CONSTRAN_1_REG</code> [15:14]	<code>Region_PMS_CONSTRAN_2_REG</code> [15:14]
Peri Region8	<code>Region_PMS_CONSTRAN_11_REG</code>	<code>Region_PMS_CONSTRAN_1_REG</code> [17:16]	<code>Region_PMS_CONSTRAN_2_REG</code> [17:16]
Peri Region9	<code>Region_PMS_CONSTRAN_12_REG</code>	<code>Region_PMS_CONSTRAN_1_REG</code> [19:18]	<code>Region_PMS_CONSTRAN_2_REG</code> [19:18]
Peri Region10	<code>Region_PMS_CONSTRAN_13_REG</code>	<code>Region_PMS_CONSTRAN_1_REG</code> [21:20]	<code>Region_PMS_CONSTRAN_2_REG</code> [21:20]

15.5 External Memory

ESP32-S3 can access the external memory via one of the three ways illustrated in Figure 15-3 below.

- CPU via SPI1
- CPU via CACHE
- GDMA

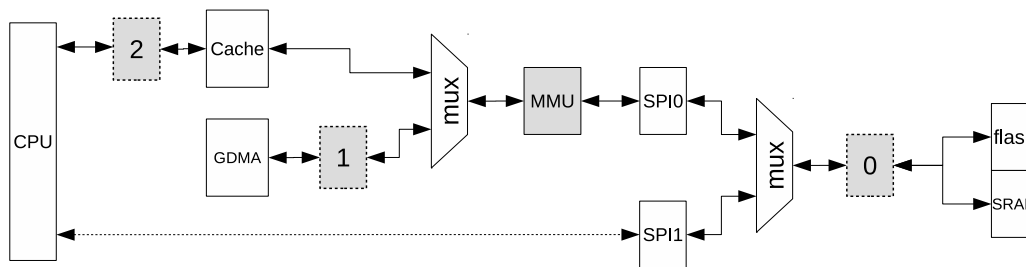

Figure 15-3. Three Ways to Access External Memory

SPI1, CACHE or GDMA must be configured with specific permission before accessing external memory. see illustration in Figure 15-3:

- Box 0 checks the CPU's access to external flash and SRAM
- Box 1 checks GDMA's access to external SRAM
- Box 2 checks CPU's access to external flash and SRAM via CACHE

15.5.1 Address

Both ESP32-S3's flash and SRAM can be further split to achieve more flexible permission control. Each split region can be configured with different access independently.

- Flash can be split into 4 regions, the length of each should be the integral multiples of 64 KB.
- SRAM can be split into 4 regions, the length of each should be the integral multiples of 64 KB.
- Also, the starting address of each region should also be aligned to 64 KB.

The following registers can be used to configure how the flash or SRAM are split.

Table 15-19. Split the External Memory into Split Regions

Split Regions	Split Region Configuration ³	
	Starting Address ¹	Length ²
Flash Region n (n : 0~3)	APB_CTRL_FLASH_ACE_ n _ADDR_REG	APB_CTRL_FLASH_ACE_ n _SIZE_REG
SRAM Region n (n : 0~3)	APB_CTRL_SRAM_ACE_ n _ADDR_REG	APB_CTRL_SRAM_ACE_ n _SIZE_REG

¹ Configuring this field with the actual address, which should be aligned to 64 KB.

² When configuring the length of Region n , note the total length of all flash or SRAM regions should be less than 1 GB, respectively.

³ Each region cannot overlap with others.

15.5.2 Access Configuration

Each split regions for flash and SRAM can be configured with different permission independently via Registers [APB_CTRL_SRAM_ACE \$n\$ _ATTR_REG](#) and [APB_CTRL_FLASH_ACE \$n\$ _ATTR](#).

Table 15-20. Access Configuration of External Memory Regions

Split Regions	Access Configuration			
	Configuration Registers	Secure World ^A	Non-secure World ^A	SPI1 Access ^B
Flash Region n (n : 0 ~ 3)	APB_CTRL_FLASH_ACE n _ATTR	[2:0] ^C	[5:3]	[7:6] ^D
SRAM Region n (n : 0 ~ 3)	APB_CTRL_SRAM_ACE n _ATTR_REG	[2:0]	[5:3]	[7:6]

^A These bits are configured in order W/R/X

^B These bits are configured in order W/R

^C For example, configuring this field to 0b010 indicates CACHE is granted with the read access but not the write or instruction execution accesses from the Secure WORLD to the Flash Region n .

^D For example, configuring this field to 0b01 indicates SPI is granted with the read access but not the write access to the Flash Region n .

15.5.3 GDMA

ESP32-S3's 32 MB External SRAM can be independently split into four regions, of which the Region1 and Region2 are accessible to GDMA.

Table 15-21. Split the External SRAM into Four Split Regions for GDMA

Split Regions	Starting Address (included)	Ending Address (not included) ²
Region0 ³	0x3C000000	PMS_EDMA_BOUNDARY_0_REG ^{1,2}
Region1 ⁴	PMS_EDMA_BOUNDARY_0_REG ¹	PMS_EDMA_BOUNDARY_1_REG ^{1,2}
Region2 ⁴	PMS_EDMA_BOUNDARY_1_REG ¹	PMS_EDMA_BOUNDARY_2_REG ^{1,2}
Region3 ³	PMS_EDMA_BOUNDARY_2_REG ¹	0x3E000000 ²

¹ When configuring this register, note that you need to write an offset to 0x3C000000 and the unit is 4 KB. For example, configuring the register to 0x80 means that the address is 0x3C000000 + 0x80 * 4KB = 0x3C080000.

² The address value filled here is the Ending address plus one. For example, 0x3E000000 means that the end address is 0x3DFFFFFF.

³ This region cannot be accessed by peripherals via GDMA.

⁴ This region can be accessed by some peripherals via GDMA, including SPI2, SPI3, UHCI0, I2S0, I2S1, Camera-LCD Controller, AES, SHA, ADC Controller, and Remote Control Peripheral. See details below.

Users can use the registers below to configure peripherals' access to the second and third External SRAM regions via GDMA.

Table 15-22. Access Configuration of External SRAM via GDMA

Peripherals	Access Configuration		
	Region1	Region2	Access
SPI2	PMS_EDMA_PMS_SPI2_ATTR1	PMS_EDMA_PMS_SPI2_ATTR2	W/R
SPI3	PMS_EDMA_PMS_SPI3_ATTR1	PMS_EDMA_PMS_SPI3_ATTR2	
UHCI0	PMS_EDMA_PMS_UHCI0_ATTR1	PMS_EDMA_PMS_UHCI0_ATTR2	
I2S0	PMS_EDMA_PMS_I2S0_ATTR1	PMS_EDMA_PMS_I2S0_ATTR2	
I2S1	PMS_EDMA_PMS_I2S1_ATTR1	PMS_EDMA_PMS_I2S1_ATTR2	
Camera-LCD Controller	PMS_EDMA_PMS_LCD_CAM_ATTR1	PMS_EDMA_PMS_LCD_CAM_ATTR2	
AES	PMS_EDMA_PMS_AES_ATTR1	PMS_EDMA_PMS_AES_ATTR2	
SHA	PMS_EDMA_PMS_SHA_ATTR1 ^A	PMS_EDMA_PMS_SHA_ATTR2	
ADC Controller	PMS_EDMA_PMS_ADC_DAC_ATTR1	PMS_EDMA_PMS_ADC_DAC_ATTR2	
Remote Control Peripheral	PMS_EDMA_PMS_RMT_ATTR1	PMS_EDMA_PMS_RMT_ATTR2	

^A For example, configuring this field to 0b10 indicates SHA is granted with the write access but not the read access via GDMA to SRAM Region1.

15.6 Unauthorized Access and Interrupts

Any attempt to access ESP32-S3's slave device without configured permission is considered an **unauthorized access** and will be handled as described below:

- This attempt will only be responded with default values, in particular,
 - All instruction execution or read attempts will be responded with 0 (for internal memory) or 0xdeadbeaf (for external memory)
 - All write attempts will fail
- An interrupt will be triggered (when enabled). See details below.

Note that:

- All permission control related interrupts described in this section can be independently configured for CPU0 and CPU1.
- Only the information of the first interrupt is logged. Therefore, it's advised to handle interrupt signals and clear interrupts in-time, so the information of next interrupt can be logged correctly.

15.6.1 Interrupt upon Unauthorized IBUS Access

ESP32-S3 can be configured to trigger interrupts when IBUS attempts to access internal ROM and SRAM without configured permission, and log the information about this unauthorized access. Note that, once this interrupt is enabled, it's enabled for all internal ROM and SRAM memory, and cannot be only enabled for a certain address field. This interrupt corresponds to the CORE_m_IRAM0_PMS_MONITOR_VIOLATE_INTR interrupt source described in Table 9-1 from Chapter 9 *Interrupt Matrix (INTERRUPT)*.

Table 15-23. Interrupt Registers for Unauthorized IBUS Access

Registers	Bit	Description
PMS_CORE_m_IRAM0_PMS_MONITOR_1_REG	[0]	Clears interrupt signal
	[1]	Enables interrupt
PMS_CORE_m_IRAM0_PMS_MONITOR_2_REG	[0]	Stores interrupt status of unauthorized IBUS access
	[1]	Stores the access direction. 1: write; 0: read.
	[2]	Stores the instruction direction. 1: load/store; 0: instruction execution.
	[4:3]	Stores the world the CPU was in when the unauthorized IBUS access happened. 0b01: Secure World; 0b10: Non-secure World
	[28:5]	Stores the address that CPU's IBUS was trying to access unauthorized.

15.6.2 Interrupt upon Unauthorized DBUS Access

ESP32-S3 can be configured to trigger interrupts when DBUS attempts to access internal ROM and SRAM without configured permission, and log the information about this unauthorized access. Note that, once this interrupt is enabled, it's enabled for all internal ROM and SRAM memory, and cannot be only enabled for a certain address field. This interrupt corresponds to the CORE_m_DRAM0_PMS_MONITOR_VIOLATE_INTR interrupt source described in Table 9-1 from Chapter 9 *Interrupt Matrix (INTERRUPT)*.

Table 15-24. Interrupt Registers for Unauthorized DBUS Access

Registers	Bit	Description
PMS_CORE_m_DRAM0_PMS_MONITOR_1_REG	[0]	Clears interrupt signal
	[1]	Enables interrupt
PMS_CORE_m_DRAM0_PMS_MONITOR_2_REG	[0]	Stores interrupt status of unauthorized DBUS access
	[1]	Flags atomic access. 1: atomic access; 0: not atomic access.
	[3:2]	Stores the world the CPU was in when the unauthorized DBUS access happened. 0b01: Secure World; 0b10: Non-secure World
	[25:4]	Stores the address that CPU's DBUS was trying to access unauthorized.
PMS_CORE_m_DRAM0_PMS_MONITOR_3_REG	[0]	Stores the access direction. 1: write; 0: read.
	[25:4]	Stores the byte information of the unauthorized DBUS access.

15.6.3 Interrupt upon Unauthorized Access to External Memory

ESP32-S3 can be configured to trigger Interrupt upon unauthorized access to external memory, and log the information about this unauthorized access. This interrupt corresponds to the SPI_MEM_REJECT_INTR interrupt source described in Table 9-1 from Chapter 9 *Interrupt Matrix (INTERRUPT)*.

Table 15-25. Interrupt Registers for Unauthorized Access to External Memory

Registers	Bit	Description
APB_CTRL_SPI_MEM_PMS_CTRL_REG	[0]	Stores exception signal
	[1]	Clears exception signal and logged information
	[2]	Indicates unauthorized instruction execution
	[3]	Indicates unauthorized read
	[4]	Indicates unauthorized write
	[5]	Indicates overlapping split regions
	[6]	Indicates invalid address

15.6.4 Interrupt upon Unauthorized Access to Internal Memory via GDMA

ESP32-S3 can be configured to trigger Interrupt upon unauthorized access to internal memory via GDMA, and log the information about this unauthorized access. This interrupt corresponds to the DMA_APB_PMS_MONITOR_VIOLATE_INTR interrupt source described in Table 9-1 from Chapter 9 *Interrupt Matrix (INTERRUPT)*.

Table 15-26. Interrupt Registers for Unauthorized Access to Internal Memory via GDMA

Registers	Bit	Description
PMS_DMA_APBPERI_PMS_MONITOR_1_REG	[0]	Clears interrupt signal
	[1]	Enables interrupt
PMS_DMA_APBPERI_PMS_MONITOR_2_REG	[0]	Stores interrupt signal
	[2:1]	Stores the world the CPU was in when the unauthorized access happened. 0b01: Secure World; 0b10: Non-secure World
	[24:3]	Stores the address that GDMA was trying to access unauthorized
PMS_DMA_APBPERI_PMS_MONITOR_3_REG	[0]	Stores the access direction. 1: write; 0: read
	[16:1]	Stores the byte information of unauthorized access

For information about Interrupt upon unauthorized access to external memory via GDMA, please refer to Chapter 3 *GDMA Controller (GDMA)*

15.6.5 Interrupt upon Unauthorized peripheral bus (PIF) Access

ESP32-S3 can be configured to trigger interrupts when PIF attempts to access RTC FAST memory, RTC SLOW memory, and peripheral regions without configured permission, and log the information about this unauthorized access. Note that, once this interrupt is enabled, it's enabled for all RTC FAST memory, RTC SLOW memory, and peripheral regions, and cannot be only enabled for a certain address field. This interrupt corresponds to the CORE_m_PIF_PMS_MONITOR_VIOLATE_INTR interrupt source described in Table 9-1 from Chapter 9 *Interrupt Matrix (INTERRUPT)*.

Table 15-27. Interrupt Registers for Unauthorized PIF Access

Registers	Bit	Description
PMS_CORE_m_PIF_PMS_MONITOR_1_REG	[1]	Enables interrupt
	[0]	Clears interrupt signal and logged information
PMS_CORE_m_PIF_PMS_MONITOR_2_REG	[7:6]	Stores the world the CPU was in when the unauthorized PIF access happened. 0b01: Secure World; 0b10: Non-secure World
	[5]	Stores the access direction. 1: write; 0: read
	[4:2]	Stores the data type of unauthorized access. 0: byte; 1: half-word; 2: word
	[1]	Stores the access type. 0: instruction; 1: data
	[0]	Stores the interrupt signal
PMS_CORE_m_PIF_PMS_MONITOR_3_REG	[31:0]	Stores the address of unauthorized access

In particular, ESP32-S3 can also be configured to check the access alignment when PIF attempts to access the peripheral regions, and trigger Interrupt upon unauthorized alignment. See detailed description in the following section.

15.6.6 Interrupt upon Unauthorized PIF Access Alignment

Access to all of ESP32-S3's modules / peripherals (excluding RTC FAST memory and SLOW memory) is **word aligned**.

ESP32-S3 can be configured to check the access alignment to all modules / peripherals, and trigger Interrupt upon **non-word aligned access**.

This interrupt corresponds to the CORE_m_PIF_PMS_MONITOR_VIOLATE_SIZE_INTR interrupt source described in Table 9-1 from Chapter 9 *Interrupt Matrix (INTERRUPT)*.

Note that CPU can convert some non-word aligned access to word aligned access, thus avoiding triggering alignment interrupt.

Table 15-28 below lists all the possible access alignments and their results (when interrupt is enabled), in which:

- **INTR**: interrupt
- ✓: access succeeds and no interrupt.

Table 15-28. All Possible Access Alignment and their Results

Accessed Address	Access Alignment	Read	Write
0x0	Byte aligned	INTR	INTR
	Half-word aligned	INTR	INTR
	Word aligned	✓	✓
0x1	Byte aligned	INTR	INTR
	Half-word aligned	✓	INTR
	Word aligned	✓	INTR
0x2	Byte aligned	INTR	INTR
	Half-word aligned	INTR	INTR

Accessed Address	Access Alignment	Read	Write
	Word aligned	✓	INTR
0x3	Byte aligned	INTR	INTR
	Half-word aligned	✓	INTR
	Word aligned	✓	INTR

Table 15-29. Interrupt Registers for Unauthorized Access Alignment

Registers	Bit	Description
PMS_CORE_m_PIF_PMS_MONITOR_4_REG	[1]	Enables interrupt
	[0]	Clears interrupt signal and logged information
PMS_CORE_m_PIF_PMS_MONITOR_5_REG	[4:3]	Stores the world the CPU was in when the unauthorized access happened. 0b01: Secure World; 0b10: Non-secure World
	[2:1]	Stores the unauthorized access type. 0: byte aligned; 1: half-word aligned; 2: word aligned
	[0]	Stores the interrupt status. 0: no interrupt; 1: interrupt
PMS_CORE_m_PIF_PMS_MONITOR_6_REG	[31:0]	Stores the address of the unauthorized access

15.7 Protection of CPU VECBASE Registers

CPU's VECBASE registers store the base addresses of interrupts and exceptions table. To protect these registers from unauthorized modification, ESP32-S3 has implemented a special mechanism.

Users can first configure values stored in VECBASE registers to the `PMS_CORE_m_VECBASE_OVERRIDE_WORLD n _VALUE` field of the `PMS_CORE_m_VECBASE_OVERRIDE_ n _REG` register, and then use the configured `PMS_CORE_m_VECBASE_OVERRIDE_WORLD n _VALUE` values, instead of VECBASE values. Then by only allowing modification to the `PMS_CORE_m_VECBASE_OVERRIDE_ n _REG` register values from the Secure World, the integrity of values stored in VECBASE registers are protected.

The detailed steps are described below:

- Write the CPU m 's VECBASE value in Secure World to the `PMS_CORE_m_VECBASE_OVERRIDE_WORLD0_VALUE` field.
- Write the CPU m 's VECBASE value in Non-secure World to the `PMS_CORE_m_VECBASE_OVERRIDE_WORLD1_VALUE` field.
- Configure the `PMS_CORE_m_VECBASE_OVERRIDE_SEL` field of the `PMS_CORE_m_VECBASE_OVERRIDE_1_REG` register by setting it to:
 - 2'b00: just use CPU m 's VECBASE register directly.
 - 2'b11: use the value configured in `PMS_CORE_m_VECBASE_OVERRIDE_WORLD n _VALUE`, instead of the value in CPU m 's VECBASE register
 - Do not configuring this field to other values.
- Configure the `PMS_CORE_m_VECBASE_WORLD_MASK` field of the `PMS_CORE_m_VECBASE_OVERRIDE_0_REG` register by setting it to:

- 1: CPU m uses WORLD0_VALUE in both the Secure World and the Non-secure World.
- 0: CPU m uses WORLD0_VALUE in the Secure World, and WORLD1_VALUE in the Non-secure World.

15.8 Register Locks

All ESP32-S3's permission control related registers can be locked by respective lock registers. When the lock registers are configured to 1, these registers themselves and their related permission control registers are all protected from modification until the next CPU reset.

Note that there isn't one-to-one correspondence between the lock registers and permission control registers. See details in Table 15-30.

Table 15-30. Lock Registers and Related Permission Control Registers

Lock Registers	Related Permission Control Registers
VECBASE Configuration	
PMS_CORE m _VECBASE_OVERRIDE_LOCK_REG	PMS_CORE m _VECBASE_OVERRIDE_LOCK_REG
	PMS_CORE m _VECBASE_OVERRIDE_0_REG
	PMS_CORE m _VECBASE_OVERRIDE_1_REG
	PMS_CORE m _VECBASE_OVERRIDE_2_REG
Lock Internal SRAM's Usage and Access Configuration	
PMS_INTERNAL_SRAM_USAGE_0_REG	PMS_INTERNAL_SRAM_USAGE_0_REG
	PMS_INTERNAL_SRAM_USAGE_1_REG
	PMS_INTERNAL_SRAM_USAGE_2_REG
PMS_CORE_X_IRAM0_PMS_CONSTRAIN_0_REG	PMS_CORE_X_IRAM0_PMS_CONSTRAIN_0_REG
	PMS_CORE_X_IRAM0_PMS_CONSTRAIN_1_REG
	PMS_CORE_X_IRAM0_PMS_CONSTRAIN_2_REG
PMS_CORE m _IRAM0_PMS_MONITOR_0_REG	PMS_CORE m _IRAM0_PMS_MONITOR_0_REG
	PMS_CORE m _IRAM0_PMS_MONITOR_1_REG
PMS_CORE_X_DRAM0_PMS_CONSTRAIN_0_REG	PMS_CORE_X_DRAM0_PMS_CONSTRAIN_0_REG
	PMS_CORE_X_DRAM0_PMS_CONSTRAIN_1_REG
PMS_CORE m _DRAM0_PMS_MONITOR_0_REG	PMS_CORE m _DRAM0_PMS_MONITOR_0_REG
	PMS_CORE m _DRAM0_PMS_MONITOR_1_REG
Lock Internal SRAM's Split Lines Configuration	
PMS_CORE_X_IRAM0_DRAM0_DMA_SPLIT_LINE_CONSTRAIN_0_REG	PMS_CORE_X_IRAM0_DRAM0_DMA_SPLIT_LINE_CONSTRAIN_0_REG
	PMS_CORE_X_IRAM0_DRAM0_DMA_SPLIT_LINE_CONSTRAIN n _REG (n : 1 - 5)
Lock CPU's Permission to Different Peripheral	
PMS_CORE m _PIF_PMS_CONSTRAIN_0_REG	PMS_CORE m _PIF_PMS_CONSTRAIN_0_REG
	PMS_CORE m _PIF_PMS_CONSTRAIN n _REG (n : 1 - 14)
PMS_CORE m _REGION_PMS_CONSTRAIN_0_REG	PMS_CORE m _REGION_PMS_CONSTRAIN_0_REG
	PMS_CORE m _REGION_PMS_CONSTRAIN n _REG (n : 1 - 14)
PMS_CORE m _PIF_PMS_MONITOR_0_REG	PMS_CORE m _PIF_PMS_MONITOR_0_REG
	PMS_CORE m _PIF_PMS_MONITOR_1_REG (n : 1 - 6)
Lock Peripherals' GDMA Access to Internal SRAM	

Lock Registers	Related Permission Control Registers
PMS_DMA_APBPERI_SPI2_PMS_CONSTRAIN_0_REG	PMS_DMA_APBPERI_SPI2_PMS_CONSTRAIN_0_REG
	PMS_DMA_APBPERI_SPI2_PMS_CONSTRAIN_1_REG
PMS_DMA_APBPERI_SPI3_PMS_CONSTRAIN_0_REG	PMS_DMA_APBPERI_SPI3_PMS_CONSTRAIN_0_REG
	PMS_DMA_APBPERI_SPI3_PMS_CONSTRAIN_1_REG
PMS_DMA_APBPERI_UHCI0_PMS_CONSTRAIN_0_REG	PMS_DMA_APBPERI_UHCI0_PMS_CONSTRAIN_0_REG
	PMS_DMA_APBPERI_UHCI0_PMS_CONSTRAIN_1_REG
PMS_DMA_APBPERI_I2S0_PMS_CONSTRAIN_0_REG	PMS_DMA_APBPERI_I2S0_PMS_CONSTRAIN_0_REG
	PMS_DMA_APBPERI_I2S0_PMS_CONSTRAIN_1_REG
PMS_DMA_APBPERI_I2S0_PMS_CONSTRAIN_1_REG	PMS_DMA_APBPERI_I2S1_PMS_CONSTRAIN_0_REG
	PMS_DMA_APBPERI_I2S1_PMS_CONSTRAIN_1_REG
PMS_DMA_APBPERI_AES_PMS_CONSTRAIN_0_REG	PMS_DMA_APBPERI_AES_PMS_CONSTRAIN_0_REG
	PMS_DMA_APBPERI_AES_PMS_CONSTRAIN_1_REG
PMS_DMA_APBPERI_SHA_PMS_CONSTRAIN_0_REG	PMS_DMA_APBPERI_SHA_PMS_CONSTRAIN_0_REG
	PMS_DMA_APBPERI_SHA_PMS_CONSTRAIN_1_REG
PMS_DMA_APBPERI_ADC_DAC_PMS_CONSTRAIN_0_REG	PMS_DMA_APBPERI_ADC_DAC_PMS_CONSTRAIN_0_REG
	PMS_DMA_APBPERI_ADC_DAC_PMS_CONSTRAIN_1_REG
PMS_DMA_APBPERI_RMT_PMS_CONSTRAIN_0_REG	PMS_DMA_APBPERI_RMT_PMS_CONSTRAIN_0_REG
	PMS_DMA_APBPERI_RMT_PMS_CONSTRAIN_1_REG
PMS_DMA_APBPERI_LCD_CAM_PMS_CONSTRAIN_0_REG	PMS_DMA_APBPERI_LCD_CAM_PMS_CONSTRAIN_0_REG
	PMS_DMA_APBPERI_LCD_CAM_PMS_CONSTRAIN_1_REG
PMS_DMA_APBPERI_USB_PMS_CONSTRAIN_0_REG	PMS_DMA_APBPERI_USB_PMS_CONSTRAIN_0_REG
	PMS_DMA_APBPERI_USB_PMS_CONSTRAIN_1_REG
PMS_DMA_APBPERI_SDIO_PMS_CONSTRAIN_0_REG	PMS_DMA_APBPERI_SDIO_PMS_CONSTRAIN_0_REG
	PMS_DMA_APBPERI_SDIO_PMS_CONSTRAIN_1_REG
PMS_DMA_APBPERI_PMS_MONITOR_0_REG	PMS_DMA_APBPERI_PMS_MONITOR_0_REG
	PMS_DMA_APBPERI_PMS_MONITOR_1_REG
	PMS_DMA_APBPERI_PMS_MONITOR_2_REG
	PMS_DMA_APBPERI_PMS_MONITOR_3_REG
Lock Peripherals' Access to External SRAM	
PMS_EDMA_BOUNDARY_LOCK_REG	PMS_EDMA_BOUNDARY_LOCK_REG
	PMS_EDMA_BOUNDARY_0_REG
	PMS_EDMA_BOUNDARY_1_REG
	PMS_EDMA_BOUNDARY_2_REG
PMS_EDMA_PMS_SPI2_LOCK_REG	PMS_EDMA_PMS_SPI2_LOCK_REG
	PMS_EDMA_PMS_SPI2_REG
PMS_EDMA_PMS_SPI3_LOCK_REG	PMS_EDMA_PMS_SPI3_LOCK_REG
	PMS_EDMA_PMS_SPI3_REG
PMS_EDMA_PMS_UHCI0_LOCK_REG	PMS_EDMA_PMS_UHCI0_LOCK_REG
	PMS_EDMA_PMS_UHCI0_REG

Lock Registers	Related Permission Control Registers
PMS_EDMA_PMS_I2S0_LOCK_REG	PMS_EDMA_PMS_I2S0_LOCK_REG
	PMS_EDMA_PMS_I2S0_REG
PMS_EDMA_PMS_I2S1_LOCK_REG	PMS_EDMA_PMS_I2S1_LOCK_REG
	PMS_EDMA_PMS_I2S1_REG
PMS_EDMA_PMS_LCD_CAM_LOCK_REG	PMS_EDMA_PMS_LCD_CAM_LOCK_REG
	PMS_EDMA_PMS_LCD_CAM_REG
PMS_EDMA_PMS_AES_LOCK_REG	PMS_EDMA_PMS_AES_LOCK_REG
	PMS_EDMA_PMS_AES_REG
PMS_EDMA_PMS_AES_LOCK_REG	PMS_EDMA_PMS_AES_LOCK_REG
	PMS_EDMA_PMS_AES_REG
PMS_EDMA_PMS_SHA_LOCK_REG	PMS_EDMA_PMS_SHA_LOCK_REG
	PMS_EDMA_PMS_SHA_REG
PMS_EDMA_PMS_ADC_DAC_LOCK_REG	PMS_EDMA_PMS_ADC_DAC_LOCK_REG
	PMS_EDMA_PMS_ADC_DAC_REG
PMS_EDMA_PMS_RMT_LOCK_REG	PMS_EDMA_PMS_RMT_LOCK_REG
	PMS_EDMA_PMS_RMT_REG

15.9 Register Summary

The addresses of registers starting from PMS in this section are relative to the Permission Control base address, and the addresses of registers starting from APB in this section are relative to the ABP Controller base address. Both base address are provided in Table 4-3 in Chapter 4 *System and Memory*.

Note that, all registers with CORE_X in this section apply to both CPUs. The list of registers below is for CPU0 only. CPU1 shares exactly the same set of registers. Adding 0x0400 to the offset of the equivalent of CPU0 register gives you address for CPU1 registers.

For example, the offset for CPU0 register [PMS_CORE_0_IRAM0_PMS_MONITOR_0_REG](#) is 0x00E4, the offset for CPU1 equivalent [PMS_CORE_1_IRAM0_PMS_MONITOR_0_REG](#) should be 0x00E4 + 0x0400, which is 0x04E4.

The abbreviations given in Column **Access** are explained in Section [Access Types for Registers](#).

Name	Description	Address	Access
Configuration Register			
PMS_APB_PERIPHERAL_ACCESS_0_REG	APB peripheral configuration register 0	0x0008	R/W
PMS_APB_PERIPHERAL_ACCESS_1_REG	APB peripheral configuration register 1	0x000C	R/W
PMS_INTERNAL_SRAM_USAGE_0_REG	Internal SRAM configuration register 0	0x0010	R/W
PMS_INTERNAL_SRAM_USAGE_1_REG	Internal SRAM configuration register 1	0x0014	R/W
PMS_INTERNAL_SRAM_USAGE_2_REG	Internal SRAM configuration register 2	0x0018	R/W
PMS_DMA_APBPERI_SPI2_PMS_CONSTRRAIN_0_REG	SPI2 GDMA Permission Config Register 0	0x0038	R/W
PMS_DMA_APBPERI_SPI2_PMS_CONSTRRAIN_1_REG	SPI2 GDMA Permission Config Register 1	0x003C	R/W
PMS_DMA_APBPERI_SPI3_PMS_CONSTRRAIN_0_REG	SPI3 GDMA Permission Config Register 0	0x0040	R/W
PMS_DMA_APBPERI_SPI3_PMS_CONSTRRAIN_1_REG	SPI3 GDMA Permission Config Register 1	0x0044	R/W
PMS_DMA_APBPERI_UHCI0_PMS_CONSTRRAIN_0_REG	UHCI0 GDMA Permission Config Register 0	0x0048	R/W
PMS_DMA_APBPERI_UHCI0_PMS_CONSTRRAIN_1_REG	UHCI0 GDMA Permission Config Register 1	0x004C	R/W
PMS_DMA_APBPERI_I2S0_PMS_CONSTRRAIN_0_REG	I2S0 GDMA Permission Config Register 0	0x0050	R/W
PMS_DMA_APBPERI_I2S0_PMS_CONSTRRAIN_1_REG	I2S0 GDMA Permission Config Register 1	0x0054	R/W
PMS_DMA_APBPERI_I2S1_PMS_CONSTRRAIN_0_REG	I2S1 GDMA Permission Config Register 0	0x0058	R/W
PMS_DMA_APBPERI_I2S1_PMS_CONSTRRAIN_1_REG	I2S1 GDMA Permission Config Register 1	0x005C	R/W
PMS_DMA_APBPERI_AES_PMS_CONSTRRAIN_0_REG	AES GDMA Permission Config Register 0	0x0070	R/W
PMS_DMA_APBPERI_AES_PMS_CONSTRRAIN_1_REG	AES GDMA Permission Config Register 1	0x0074	R/W
PMS_DMA_APBPERI_SHA_PMS_CONSTRRAIN_0_REG	SHA GDMA Permission Config Register 0	0x0078	R/W

Name	Description	Address	Access
PMS_DMA_APBPERI_SHA_PMS_CONSTRRAIN_1_REG	SHA GDMA Permission Config Register 1	0x007C	R/W
PMS_DMA_APBPERI_ADC_DAC_PMS_CONSTRRAIN_0_REG	ADC_DAC GDMA Permission Config Register 0	0x0080	R/W
PMS_DMA_APBPERI_ADC_DAC_PMS_CONSTRRAIN_1_REG	ADC_DAC GDMA Permission Config Register 1	0x0084	R/W
PMS_DMA_APBPERI_RMT_PMS_CONSTRRAIN_0_REG	RMT GDMA Permission Config Register 0	0x0088	R/W
PMS_DMA_APBPERI_RMT_PMS_CONSTRRAIN_1_REG	RMT GDMA Permission Config Register 1	0x008C	R/W
PMS_DMA_APBPERI_LCD_CAM_PMS_CONSTRRAIN_0_REG	LCD_CAM GDMA Permission Config Register 0	0x0090	R/W
PMS_DMA_APBPERI_LCD_CAM_PMS_CONSTRRAIN_1_REG	LCD_CAM GDMA Permission Config Register 1	0x0094	R/W
PMS_DMA_APBPERI_USB_PMS_CONSTRRAIN_0_REG	USB GDMA Permission Config Register 0	0x0098	R/W
PMS_DMA_APBPERI_USB_PMS_CONSTRRAIN_1_REG	USB GDMA Permission Config Register 0	0x009C	R/W
PMS_DMA_APBPERI_SDIO_PMS_CONSTRRAIN_0_REG	SDIO GDMA Permission Config Register 0	0x00A8	R/W
PMS_DMA_APBPERI_SDIO_PMS_CONSTRRAIN_1_REG	SDIO GDMA Permission Config Register 1	0x00AC	R/W
PMS_DMA_APBPERI_PMS_MONITOR_0_REG	GDMA Permission Interrupt Register 0	0x00B0	R/W
PMS_DMA_APBPERI_PMS_MONITOR_1_REG	GDMA Permission Interrupt Register 1	0x00B4	R/W
PMS_DMA_APBPERI_PMS_MONITOR_2_REG	GDMA Permission Interrupt Register 2	0x00B8	RO
PMS_DMA_APBPERI_PMS_MONITOR_3_REG	GDMA Permission Interrupt Register 3	0x00BC	RO
PMS_CORE_X_IRAM0_DRAM0_DMA_SPLIT_LINE_CONSTRRAIN_0_REG	SRAM Split Line Config Register 0	0x00C0	R/W
PMS_CORE_X_IRAM0_DRAM0_DMA_SPLIT_LINE_CONSTRRAIN_1_REG	SRAM Split Line Config Register 1	0x00C4	R/W
PMS_CORE_X_IRAM0_DRAM0_DMA_SPLIT_LINE_CONSTRRAIN_2_REG	SRAM Split Line Config Register 2	0x00C8	R/W
PMS_CORE_X_IRAM0_DRAM0_DMA_SPLIT_LINE_CONSTRRAIN_3_REG	SRAM Split Line Config Register 3	0x00CC	R/W
PMS_CORE_X_IRAM0_DRAM0_DMA_SPLIT_LINE_CONSTRRAIN_4_REG	SRAM Split Line Config Register 4	0x00D0	R/W
PMS_CORE_X_IRAM0_DRAM0_DMA_SPLIT_LINE_CONSTRRAIN_5_REG	SRAM Split Line Config Register 5	0x00D4	R/W
PMS_CORE_X_IRAM0_PMS_CONSTRRAIN_0_REG	IBUS Permission Config Register 0	0x00D8	R/W
PMS_CORE_X_IRAM0_PMS_CONSTRRAIN_1_REG	IBUS Permission Config Register 1	0x00DC	R/W

Name	Description	Address	Access
PMS_CORE_X_IRAM0_PMS_CONSTRAIN_2_REG	IBUS Permission Config Register 2	0x00E0	R/W
PMS_CORE_0_IRAM0_PMS_MONITOR_0_REG	CPU0 IBUS Permission Interrupt Register 0	0x00E4	R/W
PMS_CORE_0_IRAM0_PMS_MONITOR_1_REG	CPU0 IBUS Permission Interrupt Register 1	0x00E8	R/W
PMS_CORE_X_DRAM0_PMS_CONSTRAIN_0_REG	DBUS Permission Config Register 0	0x00FC	R/W
PMS_CORE_X_DRAM0_PMS_CONSTRAIN_1_REG	DBUS Permission Config Register 1	0x0100	R/W
PMS_CORE_0_DRAM0_PMS_MONITOR_0_REG	CPU0 dBUS Permission Interrupt Register 0	0x0104	R/W
PMS_CORE_0_DRAM0_PMS_MONITOR_1_REG	CPU0 dBUS Permission Interrupt Register 1	0x0108	R/W
PMS_CORE_0_PIF_PMS_CONSTRAIN_n_REG (n: 0 -14)	Peripheral Permission Configuration Registers	0x0124 + 4*n	R/W
PMS_CORE_0_REGION_PMS_CONSTRAIN_0_REG	CPU0 Split_Region Permission Register 0	0x0160	R/W
PMS_CORE_0_REGION_PMS_CONSTRAIN_1_REG	CPU0 Split_Region Permission Register 1	0x0164	R/W
PMS_CORE_0_REGION_PMS_CONSTRAIN_2_REG	CPU0 Split_Region Permission Register 2	0x0168	R/W
PMS_CORE_0_REGION_PMS_CONSTRAIN_3_REG	CPU0 Split_Region Permission Register 3	0x016C	R/W
PMS_CORE_0_PIF_PMS_MONITOR_0_REG	CPU0 PIF Permission Interrupt Register 0	0x019C	R/W
PMS_CORE_0_PIF_PMS_MONITOR_1_REG	CPU0 PIF Permission Interrupt Register 1	0x01A0	R/W
PMS_CORE_0_PIF_PMS_MONITOR_4_REG	CPU0 PIF Permission Interrupt Register 4	0x01AC	R/W
PMS_CORE_0_VECBASE_OVERRIDE_LOCK_REG	CPU0 vecbase override configuration register 0	0x01B8	R/W
PMS_CORE_0_VECBASE_OVERRIDE_0_REG	CPU0 vecbase override configuration register 0	0x01BC	R/W
PMS_CORE_0_VECBASE_OVERRIDE_1_REG	CPU0 vecbase override configuration register 1	0x01C0	R/W
PMS_CORE_0_VECBASE_OVERRIDE_2_REG	CPU0 vecbase override configuration register 1	0x01C4	R/W
PMS_EDMA_BOUNDARY_LOCK_REG	EDMA Boundary Lock Register	0x02A8	R/W
PMS_EDMA_BOUNDARY_0_REG	EDMA Boundary 0 Config Register	0x02AC	R/W
PMS_EDMA_BOUNDARY_1_REG	EDMA Boundary 1 Config Register	0x02B0	R/W
PMS_EDMA_BOUNDARY_2_REG	EDMA Boundary 2 Config Register 0	0x02B4	R/W
PMS_EDMA_PMS_SPI2_LOCK_REG	SPI2 External Memory Permission Lock Register	0x02B8	R/W
PMS_EDMA_PMS_SPI2_REG	SPI2 External Memory Permission Config Register	0x02BC	R/W
PMS_EDMA_PMS_SPI3_LOCK_REG	SPI3 External Memory Permission Lock Register	0x02C0	R/W
PMS_EDMA_PMS_SPI3_REG	SPI3 External Memory Permission Config Register	0x02C4	R/W

Name	Description	Address	Access
PMS_EDMA_PMS_UHCI0_LOCK_REG	UHCI0 External Memory Permission Lock Register	0x02C8	R/W
PMS_EDMA_PMS_UHCI0_REG	UHCI0 External Memory Permission Config Register	0x02CC	R/W
PMS_EDMA_PMS_I2S0_LOCK_REG	I2S0 External Memory Permission Lock Register	0x02D0	R/W
PMS_EDMA_PMS_I2S0_REG	I2S0 External Memory Permission Config Register	0x02D4	R/W
PMS_EDMA_PMS_I2S1_LOCK_REG	I2S1 External Memory Permission Lock Register	0x02D8	R/W
PMS_EDMA_PMS_I2S1_REG	I2S1 External Memory Permission Config Register	0x02DC	R/W
PMS_EDMA_PMS_LCD_CAM_LOCK_REG	LCD/CAM External Memory Permission Lock Register	0x02E0	R/W
PMS_EDMA_PMS_LCD_CAM_REG	LCD/CAM External Memory Permission Config Register	0x02E4	R/W
PMS_EDMA_PMS_AES_LOCK_REG	AES External Memory Permission Lock Register	0x02E8	R/W
PMS_EDMA_PMS_AES_REG	AES External Memory Permission Config Register	0x02EC	R/W
PMS_EDMA_PMS_SHA_LOCK_REG	SHA External Memory Permission Lock Register	0x02F0	R/W
PMS_EDMA_PMS_SHA_REG	SHA External Memory Permission Config Register	0x02F4	R/W
PMS_EDMA_PMS_ADC_DAC_LOCK_REG	ADC/DAC External Memory Permission Lock Register	0x02F8	R/W
PMS_EDMA_PMS_ADC_DAC_REG	ADC/DAC External Memory Permission Config Register	0x02FC	R/W
PMS_EDMA_PMS_RMT_LOCK_REG	RMT External Memory Permission Lock Register	0x0300	R/W
PMS_EDMA_PMS_RMT_REG	RMT Permission Config Register	0x0304	R/W
PMS_CLOCK_GATE_REG_REG	Clock Gate Config Register	0x0308	R/W
Status Register			
PMS_CORE_0_IRAM0_PMS_MONITOR_2_REG	CPU0 IBUS Permission Interrupt Register 2	0x00EC	RO
PMS_CORE_0_DRAM0_PMS_MONITOR_2_REG	CPU0 dBUS Permission Interrupt Register 2	0x010C	RO
PMS_CORE_0_DRAM0_PMS_MONITOR_3_REG	CPU0 dBUS Permission Interrupt Register 3	0x0110	RO
PMS_CORE_0_PIF_PMS_MONITOR_2_REG	CPU0 PIF Permission Interrupt Register 2	0x01A4	RO
PMS_CORE_0_PIF_PMS_MONITOR_3_REG	CPU0 PIF Permission Interrupt Register 3	0x01A8	RO

Name	Description	Address	Access
PMS_CORE_0_PIF_PMS_MONITOR_5_REG	CPU0 PIF Permission Interrupt Register 5	0x01B0	RO
PMS_CORE_0_PIF_PMS_MONITOR_6_REG	CPU0 PIF Permission Interrupt Register 6	0x01B4	RO
Version Register			
PMS_DATE_REG	Sensitive Version Register	0x0FFC	R/W

Name	Description	Address	Access
Configuration Registers			
APB_CTRL_EXT_MEM_PMS_LOCK_REG	External Memory Permission Lock Register	0x0020	R/W
APB_CTRL_FLASH_ACE n _ATTR_REG (n : 0 - 3)	Flash Area n Permission Config Register	0x0028 + 4* n	R/W
APB_CTRL_SRAM_ACE n _ADDR_S (n : 0 - 3)	Flash Area n Starting Address Config Register	0x0038 + 4* n	R/W
APB_CTRL_FLASH_ACE n _SIZE_REG (n : 0 - 3)	Flash Area n Length Config Register	0x0048 + 4* n	R/W
APB_CTRL_SRAM_ACE n _ATTR_REG (n : 0 - 3)	External SRAM Area n Permission Config Register	0x0058 + 4* n	R/W
APB_CTRL_SRAM_ACE n _ADDR_REG (n : 0 - 3)	External SRAM Area n Starting Address Config Register	0x0068 + 4* n	R/W
APB_CTRL_SRAM_ACE n _SIZE_REG (n : 0 - 3)	External SRAM Area n Length Config Register	0x0078 + 4* n	R/W
APB_CTRL_SPI_MEM_PMS_CTRL_REG	External Memory Unauthorized Access Interrupt Register	0x0088	varies
APB_CTRL_SPI_MEM_REJECT_ADDR_REG	External Memory Unauthorized Access Address Register	0x008C	RO

15.10 Registers

The addresses of registers starting from PMS in this section are relative to the Permission Control base address, and the addresses of registers starting from APB in this section are relative to the ABP Controller base address. Both base address are provided in Table 4-3 in Chapter 4 *System and Memory*.

Register 15.1. PMS_APB_PERIPHERAL_ACCESS_0_REG (0x0008)

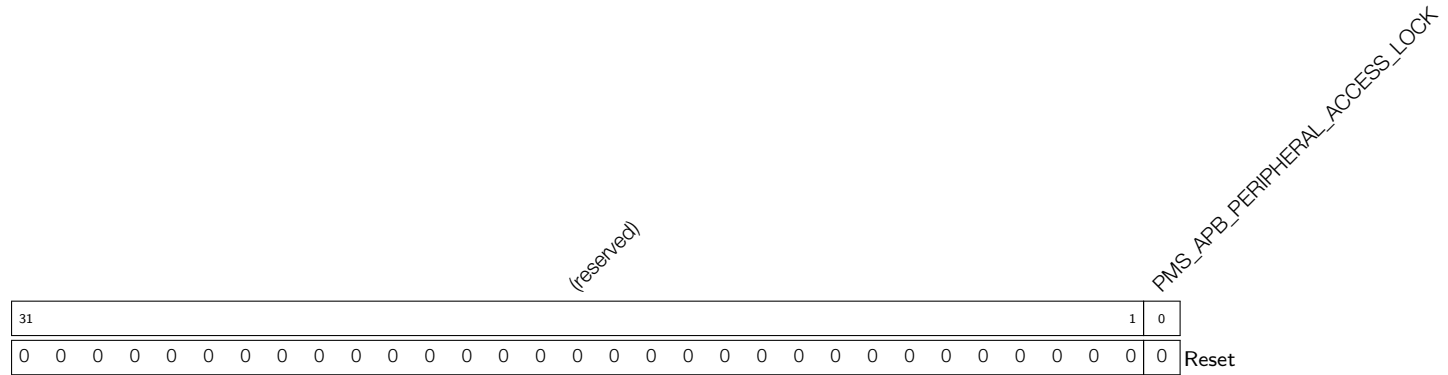

PMS_APB_PERIPHERAL_ACCESS_LOCK Set this bit to lock APB peripheral configuration register. (R/W)

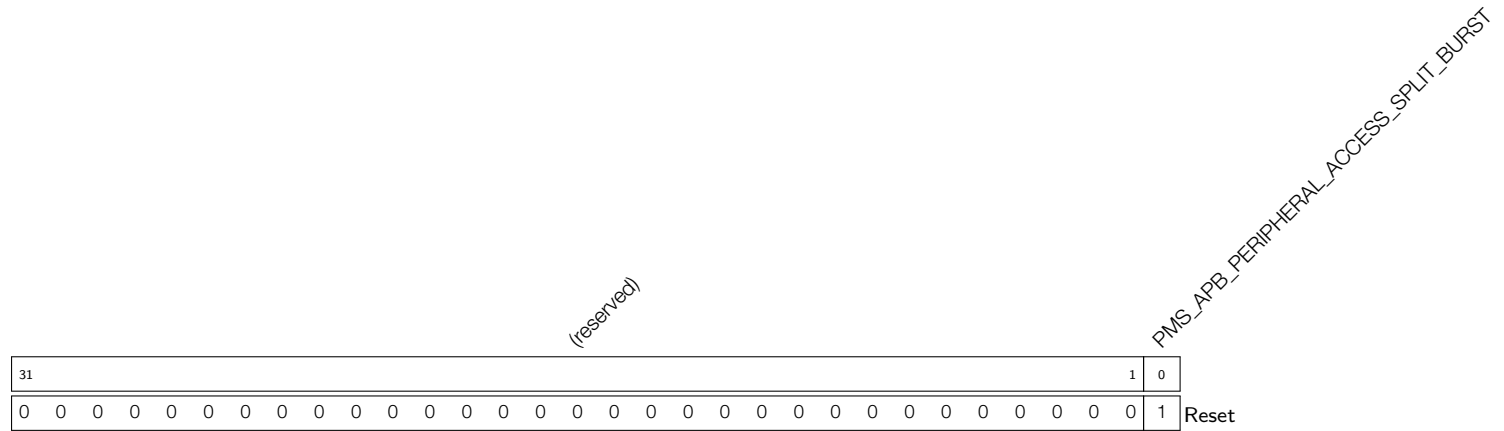
Register 15.2. PMS_APB_PERIPHERAL_ACCESS_1_REG (0x000C)

PMS_APB_PERIPHERAL_ACCESS_SPLIT_BURST Set this bit to allow the PIF bus to initiate back to back access to peripheral regions. (R/W)

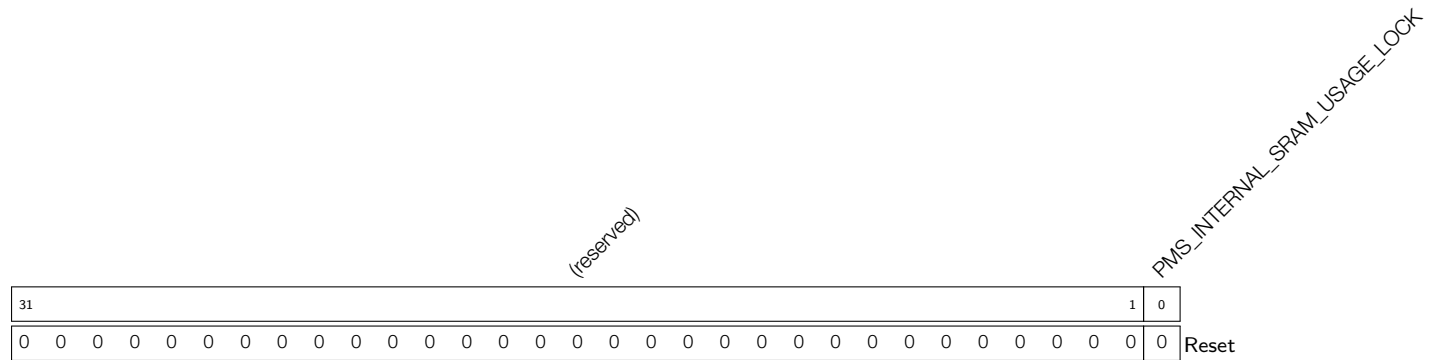
Register 15.3. PMS_INTERNAL_SRAM_USAGE_0_REG (0x0010)

PMS_INTERNAL_SRAM_USAGE_LOCK Set this bit to lock internal SRAM Configuration Register. (R/W)

Register 15.4. PMS_INTERNAL_SRAM_USAGE_1_REG (0x0014)

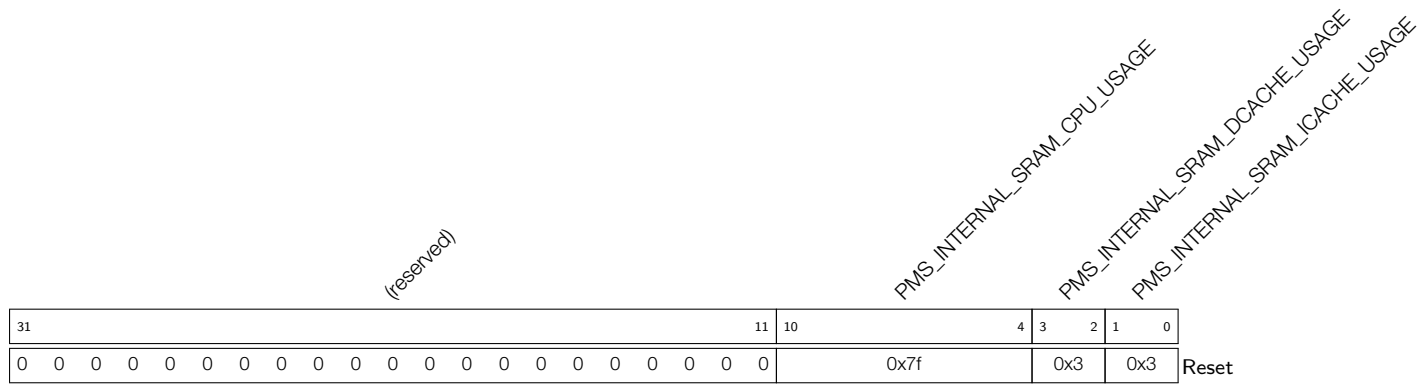

PMS_INTERNAL_SRAM_ICACHE_USAGE Configures certain blocks of SRAM0 are allocated for CPU or ICACHE. (R/W)

PMS_INTERNAL_SRAM_DCACHE_USAGE Configures certain blocks of SRAM2 are allocated for CPU or DCACHE. (R/W)

PMS_INTERNAL_SRAM_CPU_USAGE Configures this field to allow CPU to use certain blocks of SRAM1. (R/W)

Register 15.5. PMS_INTERNAL_SRAM_USAGE_2_REG (0x0018)

(reserved)										PMS_INTERNAL_SRAM_CORE1_TRACE_ALLOC		PMS_INTERNAL_SRAM_CORE0_TRACE_ALLOC		PMS_INTERNAL_SRAM_CORE1_TRACE_USAGE		PMS_INTERNAL_SRAM_CORE0_TRACE_USAGE			
31									18	17	16	15	14	13			7	6	0
0 0 0 0 0 0 0 0 0 0										0	0	0		0					
Reset																			

PMS_INTERNAL_SRAM_CORE0_TRACE_USAGE Configure this field to choose a certain block in SRAM1 as the trace memory block for CPU0. (R/W)

PMS_INTERNAL_SRAM_CORE1_TRACE_USAGE Configure this field to choose a certain block in SRAM1 as the trace memory block for CPU1. (R/W)

PMS_INTERNAL_SRAM_CORE0_TRACE_ALLOC Configure this field to choose a certain 16 KB in the selected trace memory block as trace memory for CPU0. (R/W)

PMS_INTERNAL_SRAM_CORE1_TRACE_ALLOC Configure this field to choose a certain 16 KB in the selected trace memory block as trace memory for CPU1. (R/W)

Register 15.6. PMS_DMA_APBPERI_SPI2_PMS_CONSTRAIN_0_REG (0x0038)

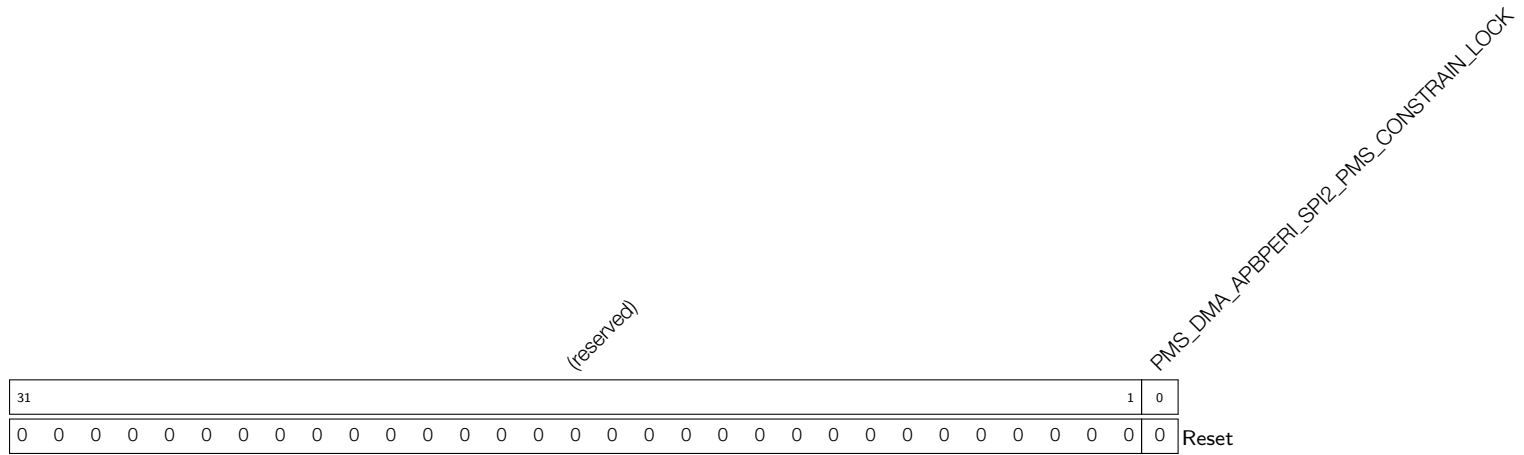

PMS_DMA_APBPERI_SPI2_PMS_CONSTRAIN_LOCK Set this bit to lock SPI2's GDMA permission configuration register. (R/W)

Register 15.7. PMS_DMA_APBPERI_SPI2_PMS_CONSTRAIN_1_REG (0x003C)

(reserved)												PMS_DMA_APBPERI_SPI2_PMS_CONSTRAIN_SRAM_CACHEDATAARRAY_PMS_1		PMS_DMA_APBPERI_SPI2_PMS_CONSTRAIN_SRAM_CACHEDATAARRAY_PMS_0									
(reserved)												PMS_DMA_APBPERI_SPI2_PMS_CONSTRAIN_SRAM_PMS_3		PMS_DMA_APBPERI_SPI2_PMS_CONSTRAIN_SRAM_PMS_2		PMS_DMA_APBPERI_SPI2_PMS_CONSTRAIN_SRAM_PMS_1		PMS_DMA_APBPERI_SPI2_PMS_CONSTRAIN_SRAM_PMS_0					
31											12	11	10	9	8	7	6	5	4	3	2	1	0
0	0	0	0	0	0	0	0	0	0	0	0	0x3	0x3	0x3	0x3	0x3	0x3	0x3	0x3	0x3	0x3	0x3	Reset

PMS_DMA_APBPERI_SPI2_PMS_CONSTRAIN_SRAM_PMS_0 Configure SPI2's permission to the instruction region. (R/W)

PMS_DMA_APBPERI_SPI2_PMS_CONSTRAIN_SRAM_PMS_1 Configure SPI2's permission to data region0 of SRAM. (R/W)

PMS_DMA_APBPERI_SPI2_PMS_CONSTRAIN_SRAM_PMS_2 Configure SPI2's permission to data region1 of SRAM. (R/W)

PMS_DMA_APBPERI_SPI2_PMS_CONSTRAIN_SRAM_PMS_3 Configure SPI2's permission to data region2 of SRAM. (R/W)

PMS_DMA_APBPERI_SPI2_PMS_CONSTRAIN_SRAM_CACHEDATAARRAY_PMS_0 Configure SPI2's permission to SRAM block9. (R/W)

PMS_DMA_APBPERI_SPI2_PMS_CONSTRAIN_SRAM_CACHEDATAARRAY_PMS_1 Configure SPI2's permission to SRAM block10. (R/W)

Register 15.8. PMS_DMA_APBPERI_SPI3_PMS_CONSTRAIN_0_REG (0x0040)

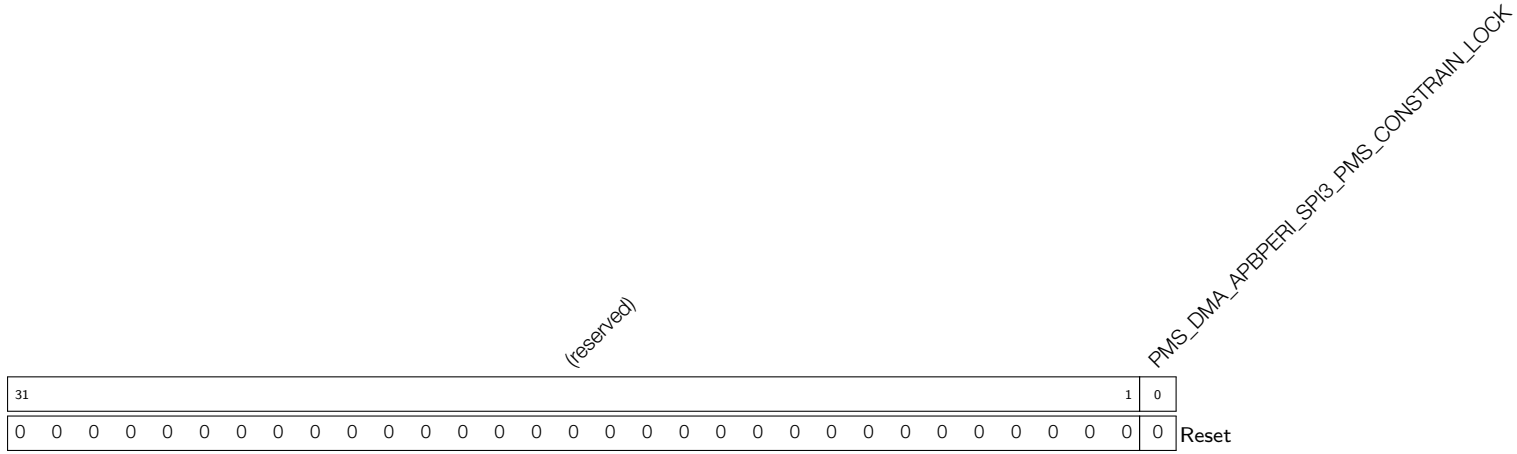

PMS_DMA_APBPERI_SPI3_PMS_CONSTRAIN_LOCK Set this bit to lock SPI3's GDMA permission configuration register. (R/W)

Register 15.9. PMS_DMA_APBPERI_SPI3_PMS_CONSTRAIN_1_REG (0x0044)

(reserved)												PMS_DMA_APBPERI_SPI3_PMS_CONSTRAIN_SRAM_CACHEDATAARRAY_PMS_1		PMS_DMA_APBPERI_SPI3_PMS_CONSTRAIN_SRAM_CACHEDATAARRAY_PMS_0									
(reserved)												PMS_DMA_APBPERI_SPI3_PMS_CONSTRAIN_SRAM_PMS_3		PMS_DMA_APBPERI_SPI3_PMS_CONSTRAIN_SRAM_PMS_2		PMS_DMA_APBPERI_SPI3_PMS_CONSTRAIN_SRAM_PMS_1		PMS_DMA_APBPERI_SPI3_PMS_CONSTRAIN_SRAM_PMS_0					
31											12	11	10	9	8	7	6	5	4	3	2	1	0
0	0	0	0	0	0	0	0	0	0	0	0	0x3	0x3	0x3	0x3	0x3	0x3	Reset					

PMS_DMA_APBPERI_SPI3_PMS_CONSTRAIN_SRAM_PMS_0 Configure SPI3's permission to the instruction region. (R/W)

PMS_DMA_APBPERI_SPI3_PMS_CONSTRAIN_SRAM_PMS_1 Configure SPI3's permission to the data region0. (R/W)

PMS_DMA_APBPERI_SPI3_PMS_CONSTRAIN_SRAM_PMS_2 Configure SPI3's permission to the data region1. (R/W)

PMS_DMA_APBPERI_SPI3_PMS_CONSTRAIN_SRAM_PMS_3 Configure SPI3's permission to the data region2. (R/W)

PMS_DMA_APBPERI_SPI3_PMS_CONSTRAIN_SRAM_CACHEDATAARRAY_PMS_0 Configure SPI3's permission to SRAM block9. (R/W)

PMS_DMA_APBPERI_SPI3_PMS_CONSTRAIN_SRAM_CACHEDATAARRAY_PMS_1 Configure SPI3's permission to SRAM block10. (R/W)

Register 15.11. PMS_DMA_APBPERI_UHCI0_PMS_CONSTRAIN_1_REG (0x004C)

(reserved)												PMS_DMA_APBPERI_UHCI0_PMS_CONSTRAIN_SRAM_CACHEDATAARRAY_PMS_1	PMS_DMA_APBPERI_UHCI0_PMS_CONSTRAIN_SRAM_CACHEDATAARRAY_PMS_0																			
(reserved)												PMS_DMA_APBPERI_UHCI0_PMS_CONSTRAIN_SRAM_PMS_3	PMS_DMA_APBPERI_UHCI0_PMS_CONSTRAIN_SRAM_PMS_2																			
(reserved)												PMS_DMA_APBPERI_UHCI0_PMS_CONSTRAIN_SRAM_PMS_1	PMS_DMA_APBPERI_UHCI0_PMS_CONSTRAIN_SRAM_PMS_0																			
31											12	11	10	9	8	7	6	5	4	3	2	1	0									
0	0	0	0	0	0	0	0	0	0	0	0	0	0	0	0	0	0	0	0	0	0	0	0	0	0	0x3	0x3	0x3	0x3	0x3	0x3	Reset

- PMS_DMA_APBPERI_UHCI0_PMS_CONSTRAIN_SRAM_PMS_0** Configure UHCI0's permission to the instruction region. (R/W)
- PMS_DMA_APBPERI_UHCI0_PMS_CONSTRAIN_SRAM_PMS_1** Configure UHCI0's permission to data region0 of SRAM. (R/W)
- PMS_DMA_APBPERI_UHCI0_PMS_CONSTRAIN_SRAM_PMS_2** Configure UHCI0's permission to data region1 of SRAM. (R/W)
- PMS_DMA_APBPERI_UHCI0_PMS_CONSTRAIN_SRAM_PMS_3** Configure UHCI0's permission to data region2 of SRAM. (R/W)
- PMS_DMA_APBPERI_UHCI0_PMS_CONSTRAIN_SRAM_CACHEDATAARRAY_PMS_0** Configure UHCI0's permission to SRAM block9. (R/W)
- PMS_DMA_APBPERI_UHCI0_PMS_CONSTRAIN_SRAM_CACHEDATAARRAY_PMS_1** Configure UHCI0's permission to SRAM block10. (R/W)

Register 15.12. PMS_DMA_APBPERI_I2S0_PMS_CONSTRAIN_0_REG (0x0050)

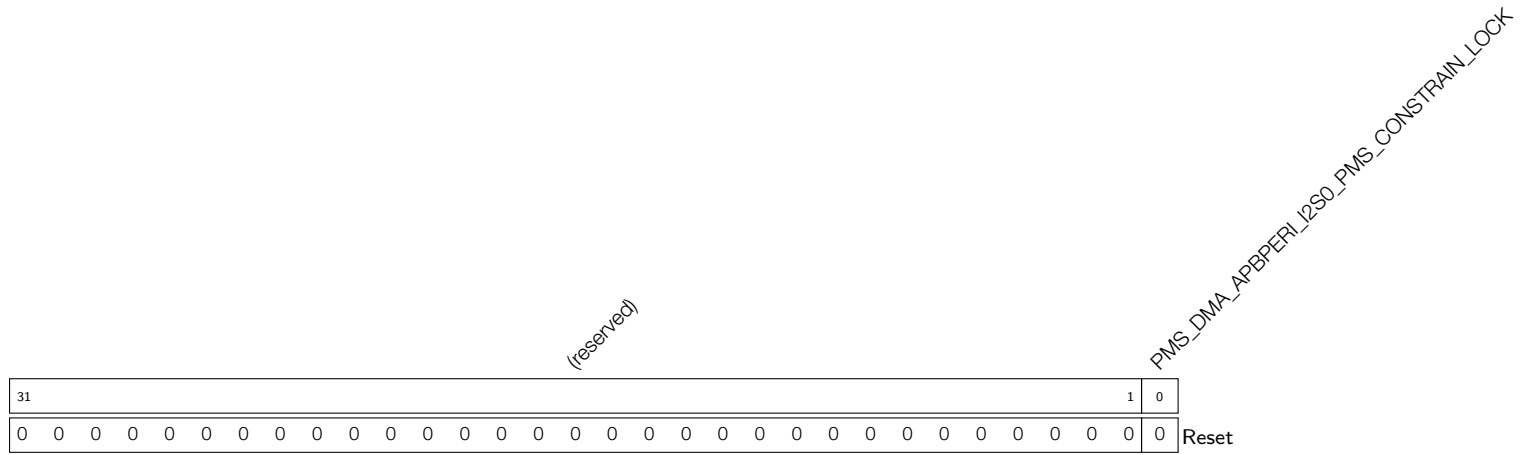

PMS_DMA_APBPERI_I2S0_PMS_CONSTRAIN_LOCK Set this bit to lock I2S0's GDMA permission configuration register. (R/W)

Register 15.13. PMS_DMA_APBPERI_I2S0_PMS_CONSTRIN_1_REG (0x0054)

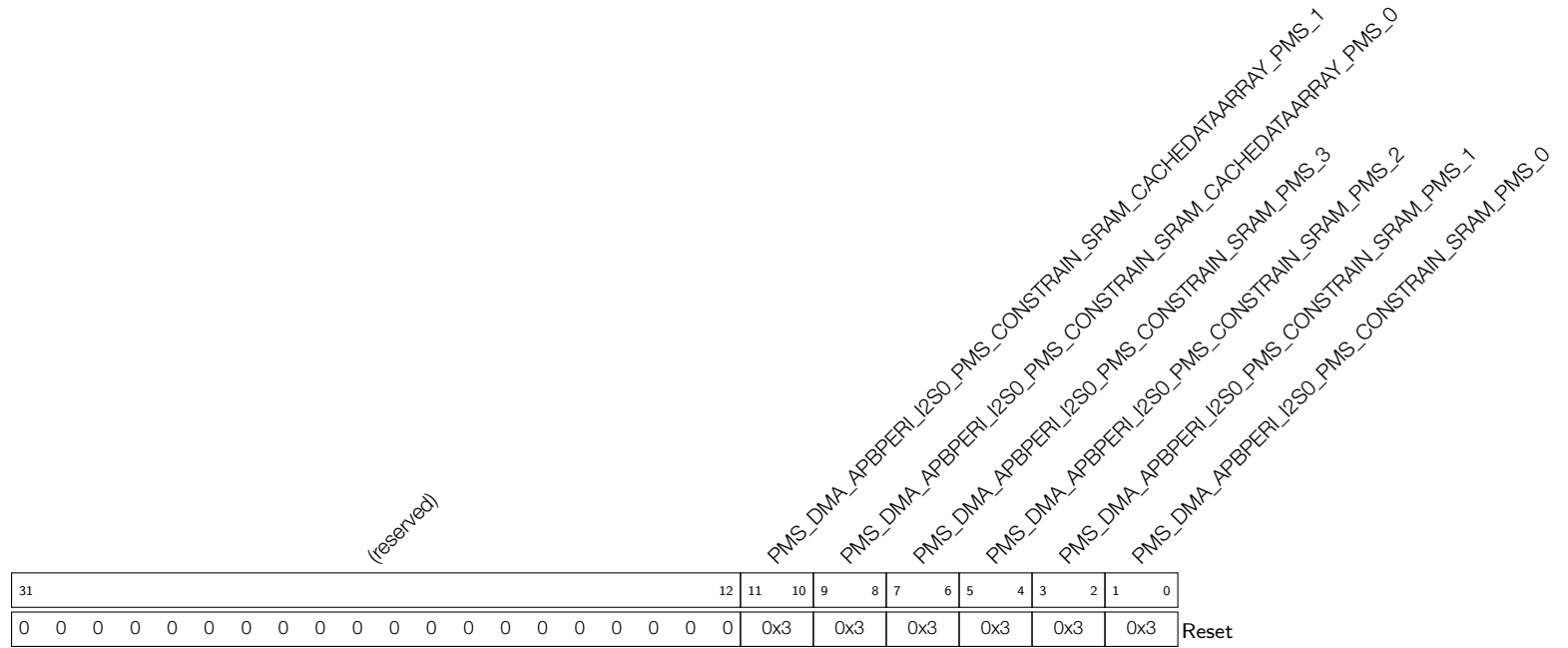

- PMS_DMA_APBPERI_I2S0_PMS_CONSTRIN_SRAM_PMS_0** Configure I2S0's permission to the instruction region. (R/W)
- PMS_DMA_APBPERI_I2S0_PMS_CONSTRIN_SRAM_PMS_1** Configure I2S0's permission to data region0 of SRAM. (R/W)
- PMS_DMA_APBPERI_I2S0_PMS_CONSTRIN_SRAM_PMS_2** Configure I2S0's permission to data region1 of SRAM. (R/W)
- PMS_DMA_APBPERI_I2S0_PMS_CONSTRIN_SRAM_PMS_3** Configure I2S0's permission to data region2 of SRAM. (R/W)
- PMS_DMA_APBPERI_I2S0_PMS_CONSTRIN_SRAM_CACHEDATAARRAY_PMS_0** Configure I2S0's permission to SRAM block9. (R/W)
- PMS_DMA_APBPERI_I2S0_PMS_CONSTRIN_SRAM_CACHEDATAARRAY_PMS_1** Configure I2S0's permission to SRAM block10. (R/W)

Register 15.15. PMS_DMA_APBPERI_I2S1_PMS_CONSTRAIN_1_REG (0x005C)

(reserved)													PMS_DMA_APBPERI_I2S1_PMS_CONSTRAIN_SRAM_CACHEDATAARRAY_PMS_1	PMS_DMA_APBPERI_I2S1_PMS_CONSTRAIN_SRAM_CACHEDATAARRAY_PMS_0	PMS_DMA_APBPERI_I2S1_PMS_CONSTRAIN_SRAM_PMS_3	PMS_DMA_APBPERI_I2S1_PMS_CONSTRAIN_SRAM_PMS_2	PMS_DMA_APBPERI_I2S1_PMS_CONSTRAIN_SRAM_PMS_1	PMS_DMA_APBPERI_I2S1_PMS_CONSTRAIN_SRAM_PMS_0								
31													12	11	10	9	8	7	6	5	4	3	2	1	0	
0													0	0	0	0	0	0	0x3	0x3	0x3	0x3	0x3	0x3	0x3	Reset

PMS_DMA_APBPERI_I2S1_PMS_CONSTRAIN_SRAM_PMS_0 Configure I2S1's permission to the instruction region. (R/W)

PMS_DMA_APBPERI_I2S1_PMS_CONSTRAIN_SRAM_PMS_1 Configure I2S1's permission to data region0 of SRAM. (R/W)

PMS_DMA_APBPERI_I2S1_PMS_CONSTRAIN_SRAM_PMS_2 Configure I2S1's permission to data region1 of SRAM. (R/W)

PMS_DMA_APBPERI_I2S1_PMS_CONSTRAIN_SRAM_PMS_3 Configure I2S1's permission to data region2 of SRAM.(R/W)

PMS_DMA_APBPERI_I2S1_PMS_CONSTRAIN_SRAM_CACHEDATAARRAY_PMS_0 Configure I2S1's permission to SRAM block9. (R/W)

PMS_DMA_APBPERI_I2S1_PMS_CONSTRAIN_SRAM_CACHEDATAARRAY_PMS_1 Configure I2S1's permission to SRAM block10. (R/W)

Register 15.16. PMS_DMA_APBPERI_AES_PMS_CONSTRAIN_0_REG (0x0070)

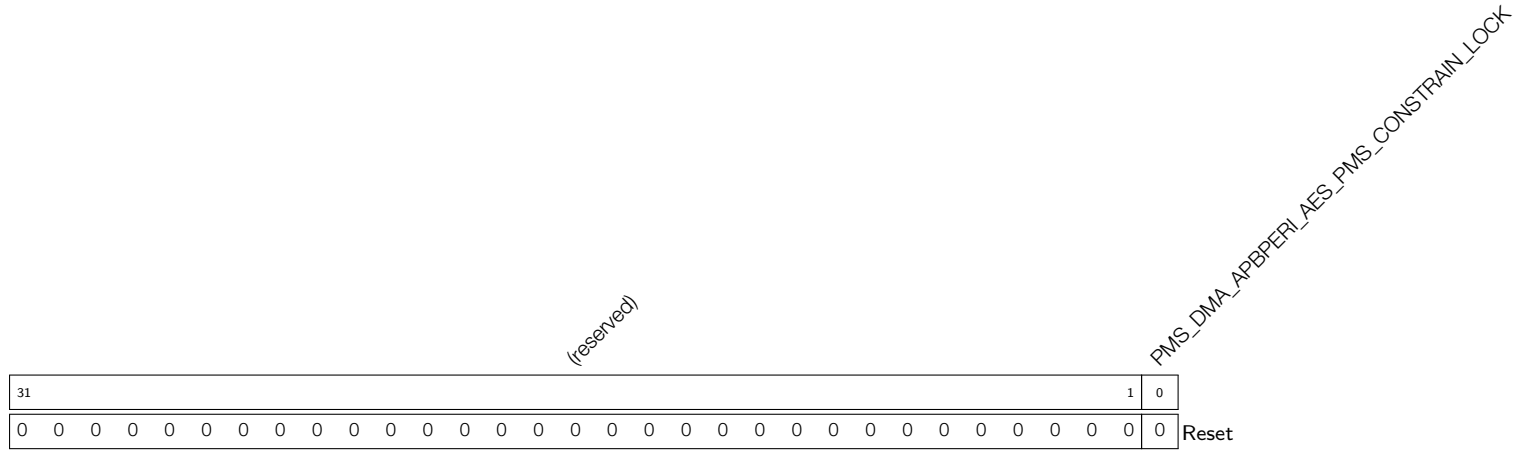

PMS_DMA_APBPERI_AES_PMS_CONSTRAIN_LOCK Set this bit to lock AES's GDMA permission configuration register. (R/W)

Register 15.18. PMS_DMA_APBPERI_SHA_PMS_CONSTRAIN_0_REG (0x0078)

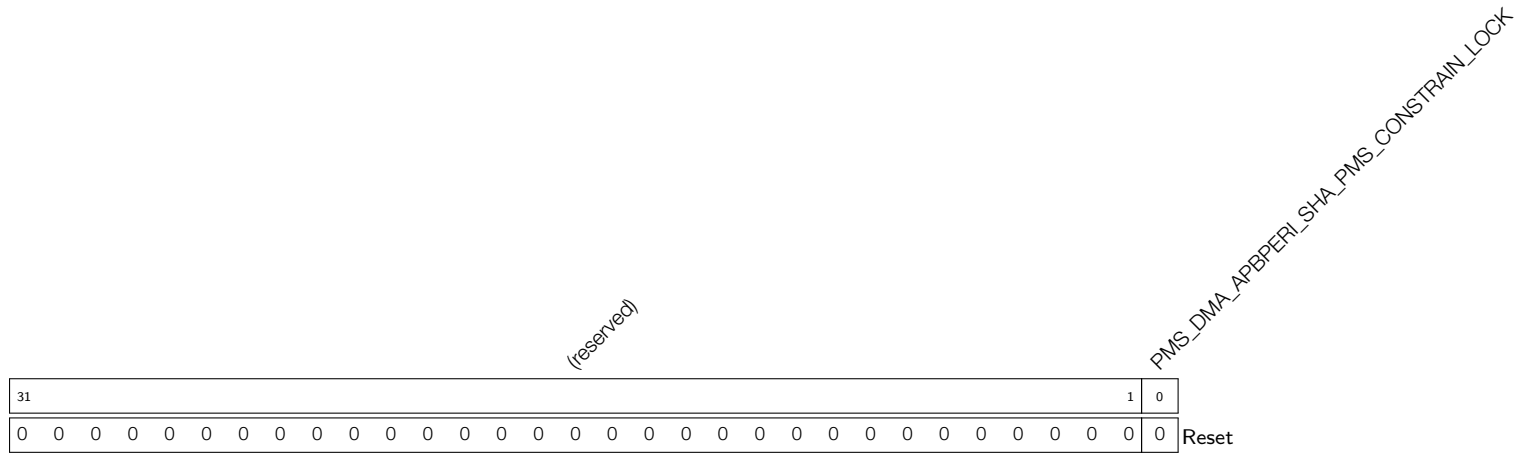

PMS_DMA_APBPERI_SHA_PMS_CONSTRAIN_LOCK Set this bit to lock SHA's GDMA permission configuration register. (R/W)

Register 15.19. PMS_DMA_APBPERI_SHA_PMS_CONSTRAIN_1_REG (0x007C)

(reserved)												PMS_DMA_APBPERI_SHA_PMS_CONSTRAIN_SRAM_CACHEDATAARRAY_PMS_1		PMS_DMA_APBPERI_SHA_PMS_CONSTRAIN_SRAM_CACHEDATAARRAY_PMS_0		PMS_DMA_APBPERI_SHA_PMS_CONSTRAIN_SRAM_PMS_3		PMS_DMA_APBPERI_SHA_PMS_CONSTRAIN_SRAM_PMS_2		PMS_DMA_APBPERI_SHA_PMS_CONSTRAIN_SRAM_PMS_1		PMS_DMA_APBPERI_SHA_PMS_CONSTRAIN_SRAM_PMS_0	
31											12	11	10	9	8	7	6	5	4	3	2	1	0
0	0	0	0	0	0	0	0	0	0	0	0	0x3	0x3	0x3	0x3	0x3	0x3	0x3	0x3	0x3	0x3	0x3	Reset

PMS_DMA_APBPERI_SHA_PMS_CONSTRAIN_SRAM_PMS_0 Configure SHA's permission to the instruction region. (R/W)

PMS_DMA_APBPERI_SHA_PMS_CONSTRAIN_SRAM_PMS_1 Configure SHA's permission to data region0 of SRAM. (R/W)

PMS_DMA_APBPERI_SHA_PMS_CONSTRAIN_SRAM_PMS_2 Configure SHA's permission to data region1 of SRAM. (R/W)

PMS_DMA_APBPERI_SHA_PMS_CONSTRAIN_SRAM_PMS_3 Configure SHA's permission to data region2 of SRAM. (R/W)

PMS_DMA_APBPERI_SHA_PMS_CONSTRAIN_SRAM_CACHEDATAARRAY_PMS_0 Configure SHA's permission to SRAM block9. (R/W)

PMS_DMA_APBPERI_SHA_PMS_CONSTRAIN_SRAM_CACHEDATAARRAY_PMS_1 Configure SHA's permission to SRAM block10. (R/W)

Register 15.20. PMS_DMA_APBPERI_ADC_DAC_PMS_CONSTRAIN_0_REG (0x0080)

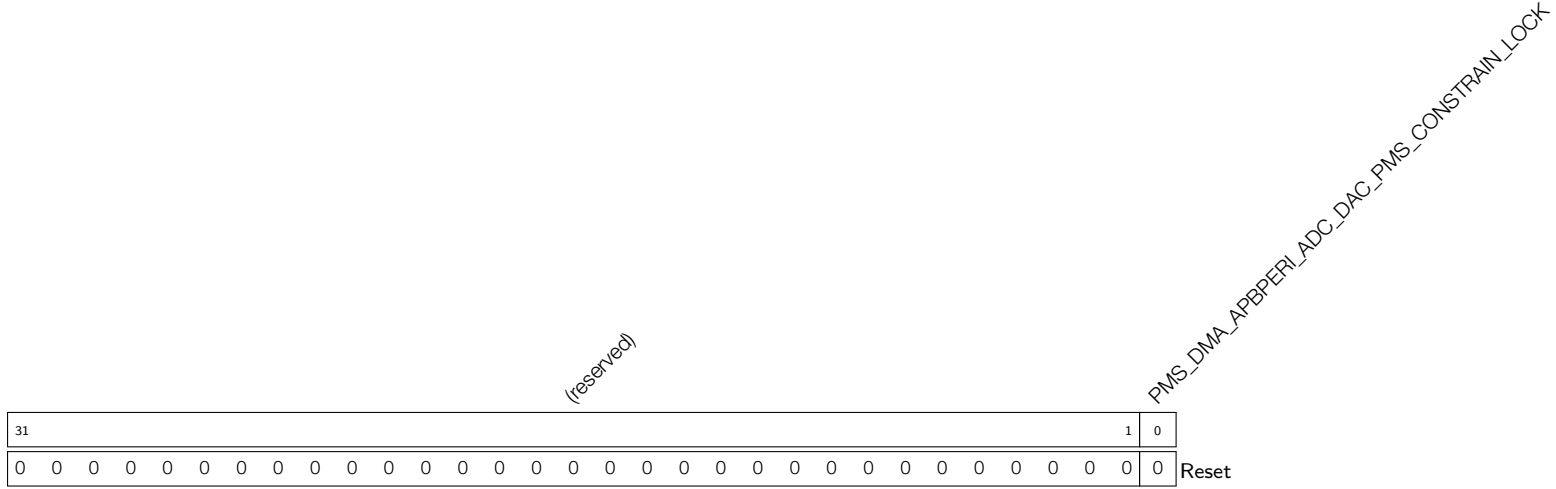

PMS_DMA_APBPERI_ADC_DAC_PMS_CONSTRAIN_LOCK Set this bit to lock ADC_DAC's GDMA permission configuration register. (R/W)

Register 15.21. PMS_DMA_APBPERI_ADC_DAC_PMS_CONSTRAIN_1_REG (0x0084)

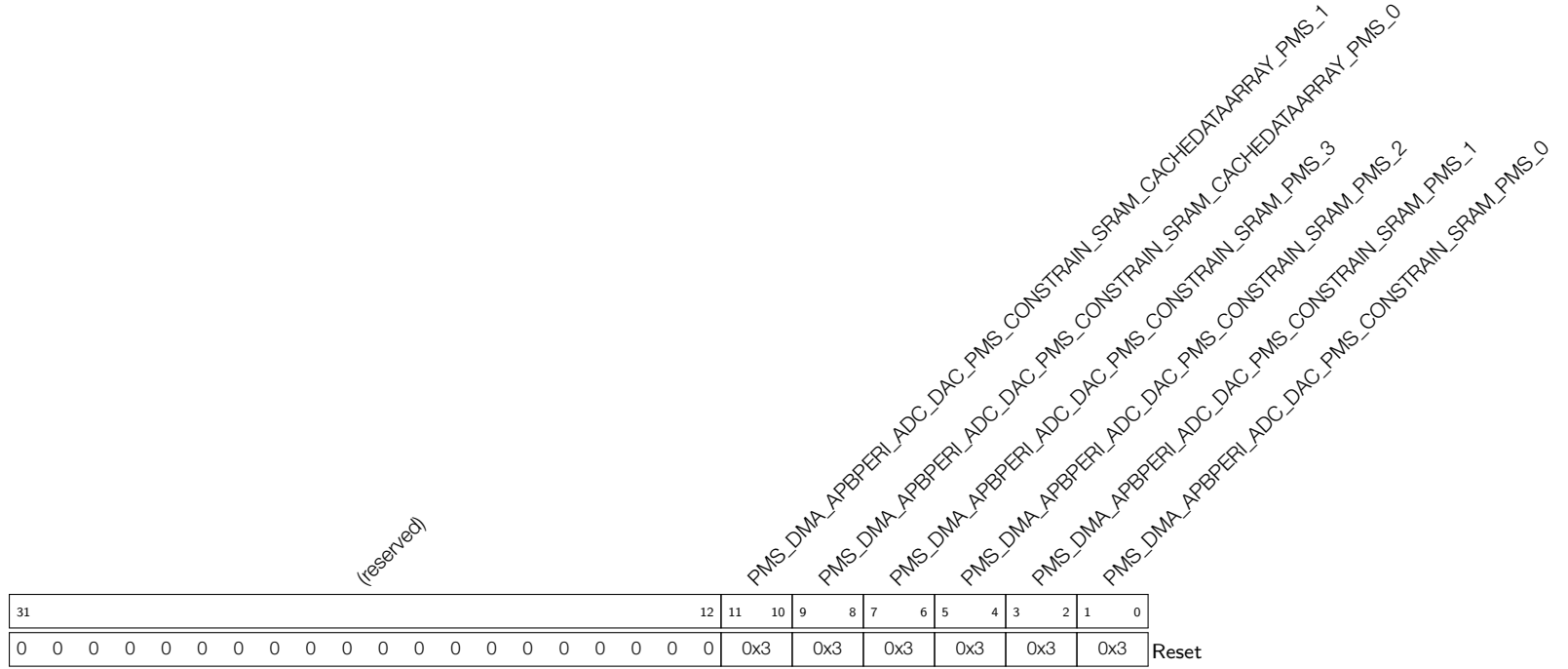

- PMS_DMA_APBPERI_ADC_DAC_PMS_CONSTRAIN_SRAM_PMS_0** Configure ADC_DAC's permission to the instruction region. (R/W)
- PMS_DMA_APBPERI_ADC_DAC_PMS_CONSTRAIN_SRAM_PMS_1** Configure ADC_DAC's permission to data region0 of SRAM. (R/W)
- PMS_DMA_APBPERI_ADC_DAC_PMS_CONSTRAIN_SRAM_PMS_2** Configure ADC_DAC's permission to data region1 of SRAM. (R/W)
- PMS_DMA_APBPERI_ADC_DAC_PMS_CONSTRAIN_SRAM_PMS_3** Configure ADC_DAC's permission to data region2 of SRAM. (R/W)
- PMS_DMA_APBPERI_ADC_DAC_PMS_CONSTRAIN_SRAM_CACHEDATAARRAY_PMS_0** Configure ADC_DAC's permission to SRAM block9. (R/W)
- PMS_DMA_APBPERI_ADC_DAC_PMS_CONSTRAIN_SRAM_CACHEDATAARRAY_PMS_1** Configure ADC_DAC's permission to SRAM block10. (R/W)

Register 15.22. PMS_DMA_APBPERI_RMT_PMS_CONSTRAIN_0_REG (0x0088)

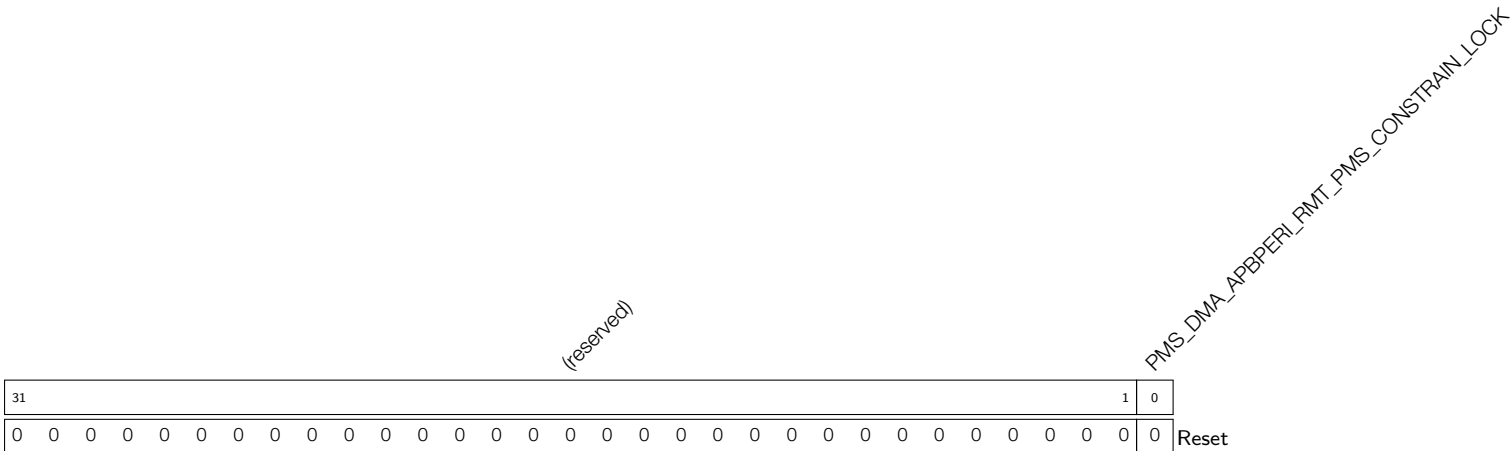

PMS_DMA_APBPERI_RMT_PMS_CONSTRAIN_LOCK Set this bit to lock RMT's GDMA permission configuration register. (R/W)

Register 15.23. PMS_DMA_APBPERI_RMT_PMS_CONSTRRAIN_1_REG (0x008C)

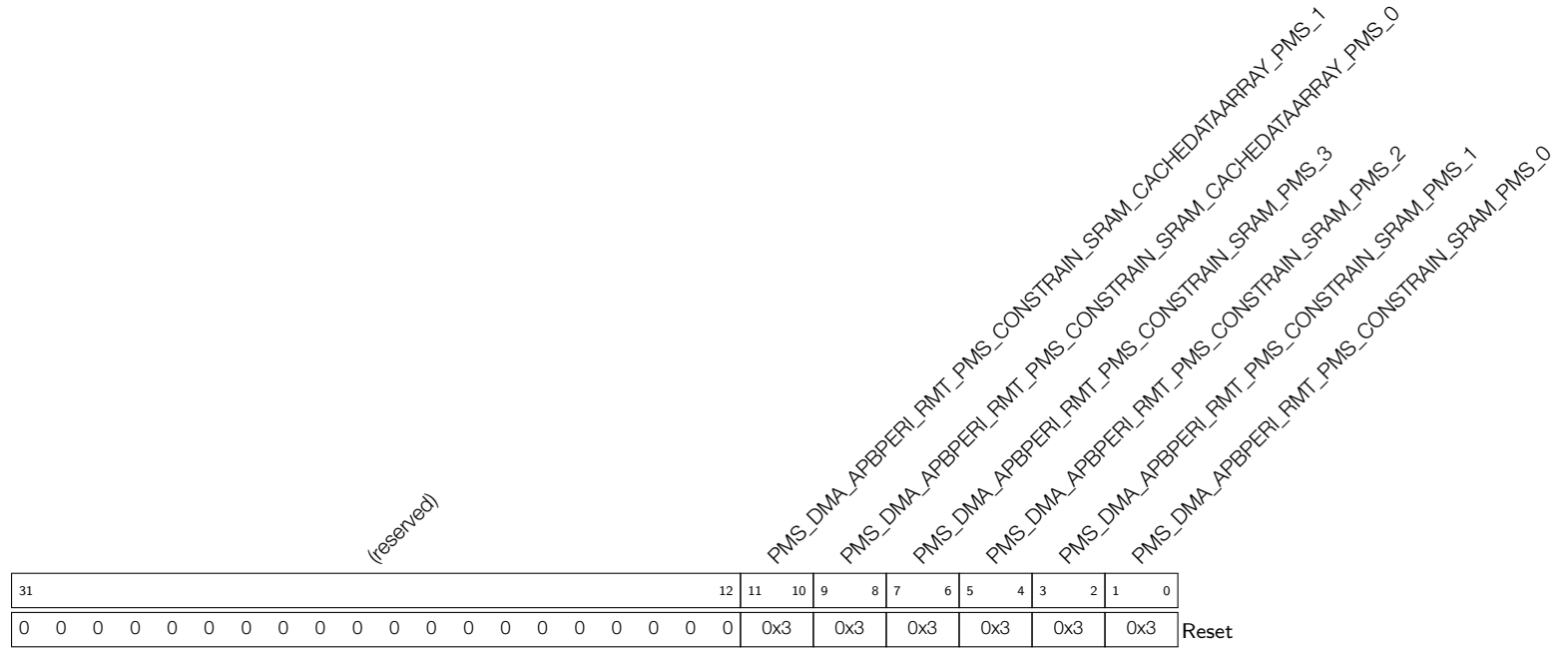

- PMS_DMA_APBPERI_RMT_PMS_CONSTRRAIN_SRAM_PMS_0** Configure RMT's permission to the instruction region. (R/W)
- PMS_DMA_APBPERI_RMT_PMS_CONSTRRAIN_SRAM_PMS_1** Configure RMT's permission to data region0 of SRAM. (R/W)
- PMS_DMA_APBPERI_RMT_PMS_CONSTRRAIN_SRAM_PMS_2** Configure RMT's permission to data region1 of SRAM. (R/W)
- PMS_DMA_APBPERI_RMT_PMS_CONSTRRAIN_SRAM_PMS_3** Configure RMT's permission to data region2 of SRAM. (R/W)
- PMS_DMA_APBPERI_RMT_PMS_CONSTRRAIN_SRAM_CACHEDATAARRAY_PMS_0** Configure RMT's permission to SRAM block9. (R/W)
- PMS_DMA_APBPERI_RMT_PMS_CONSTRRAIN_SRAM_CACHEDATAARRAY_PMS_1** Configure RMT's permission to SRAM block10. (R/W)

Register 15.24. PMS_DMA_APBPERI_LCD_CAM_PMS_CONSTRAIN_0_REG (0x0090)

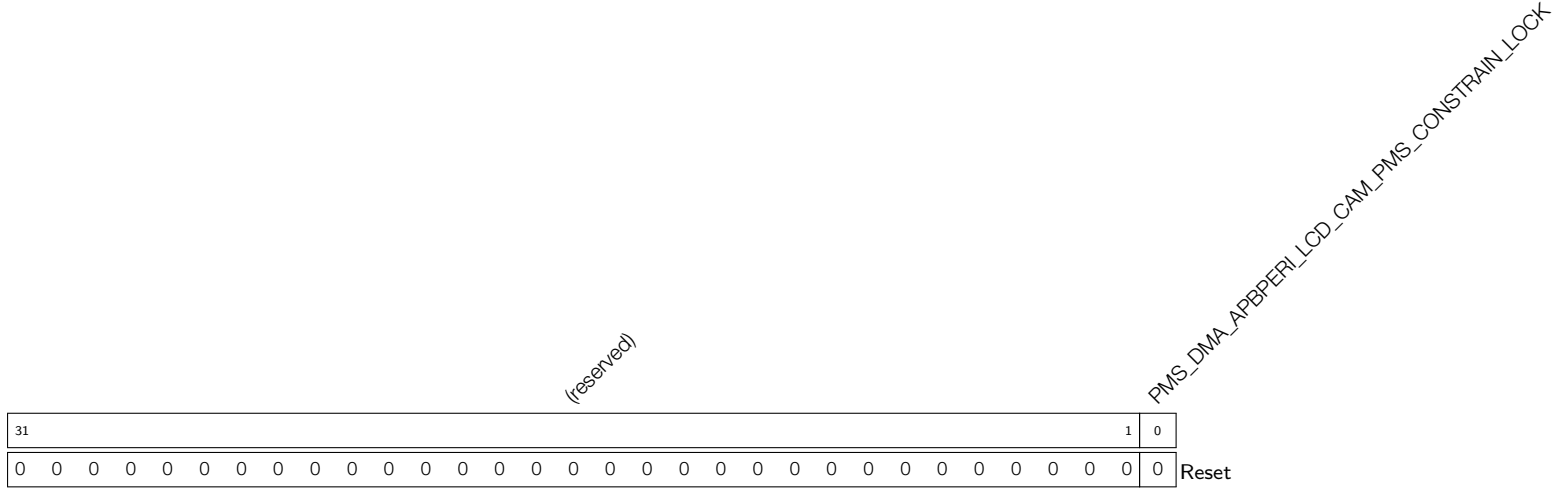

PMS_DMA_APBPERI_LCD_CAM_PMS_CONSTRAIN_LOCK Set this bit to lock LCD_CAM's GDMA permission configuration register. (R/W)

Register 15.25. PMS_DMA_APBPERI_LCD_CAM_PMS_CONSTRIN_1_REG (0x0094)

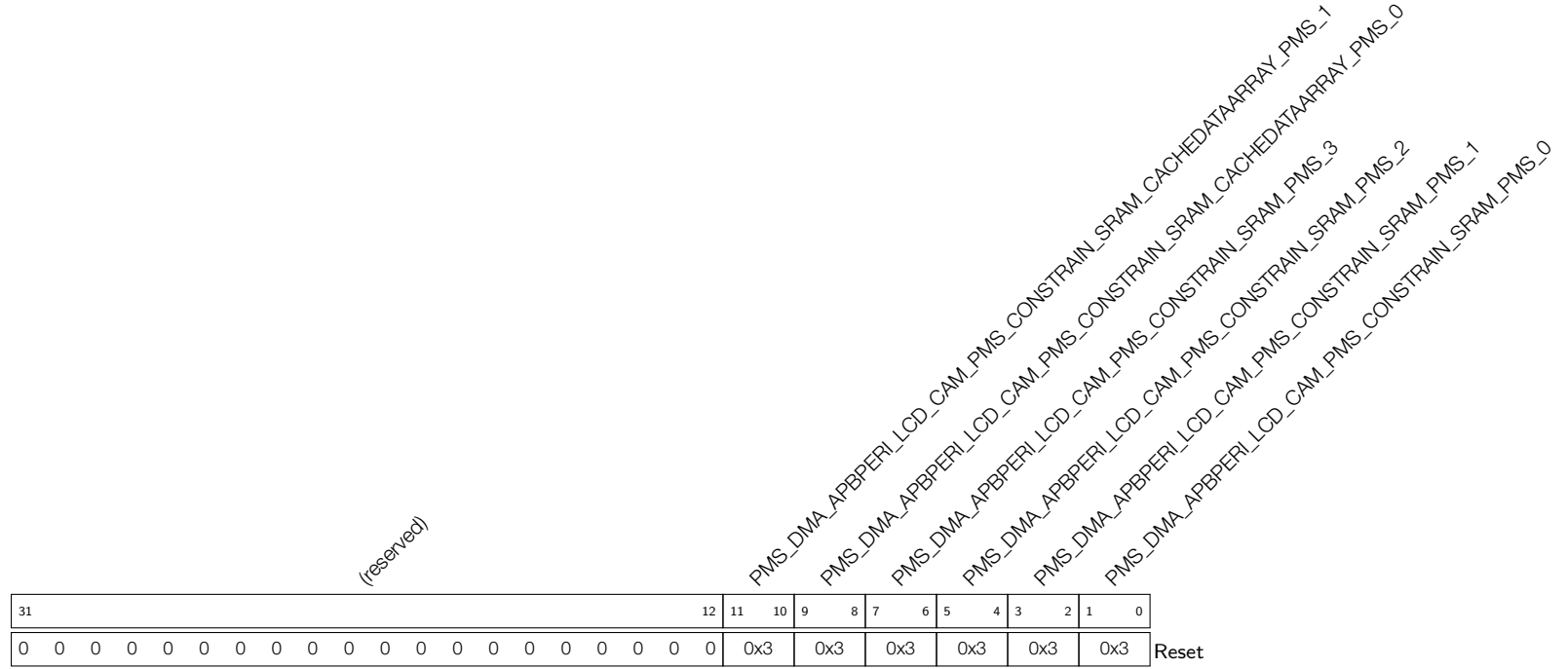

- PMS_DMA_APBPERI_LCD_CAM_PMS_CONSTRIN_SRAM_PMS_0** Configure LCD_CAM's permission to the instruction region. (R/W)
- PMS_DMA_APBPERI_LCD_CAM_PMS_CONSTRIN_SRAM_PMS_1** Configure LCD_CAM's permission to data region0 of SRAM. (R/W)
- PMS_DMA_APBPERI_LCD_CAM_PMS_CONSTRIN_SRAM_PMS_2** Configure LCD_CAM's permission to data region1 of SRAM. (R/W)
- PMS_DMA_APBPERI_LCD_CAM_PMS_CONSTRIN_SRAM_PMS_3** Configure LCD_CAM's permission to data region2 of SRAM. (R/W)
- PMS_DMA_APBPERI_LCD_CAM_PMS_CONSTRIN_SRAM_CACHEDATAARRAY_PMS_0** Configure LCD_CAM's permission to SRAM block9. (R/W)
- PMS_DMA_APBPERI_LCD_CAM_PMS_CONSTRIN_SRAM_CACHEDATAARRAY_PMS_1** Configure LCD_CAM's permission to SRAM block10. (R/W)

Register 15.26. PMS_DMA_APBPERI_USB_PMS_CONSTRAIN_0_REG (0x0098)

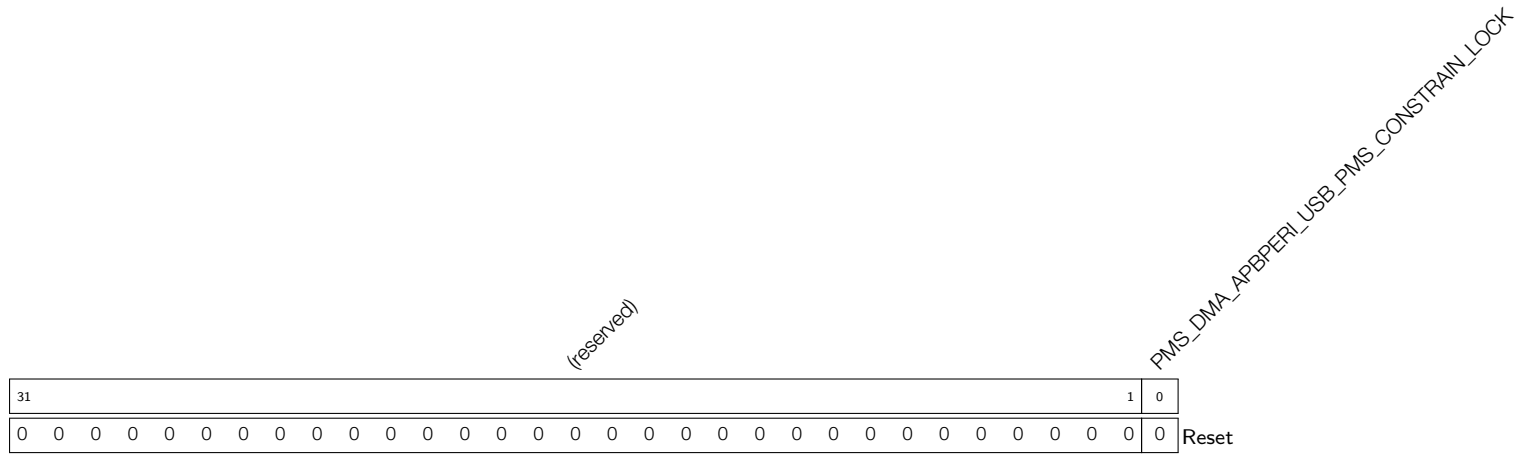

PMS_DMA_APBPERI_USB_PMS_CONSTRAIN_LOCK Set this bit to lock USB's GDMA permission configuration register. (R/W)

Register 15.27. PMS_DMA_APBPERI_USB_PMS_CONSTRAN_1_REG (0x009C)

(reserved)																PMS_DMA_APBPERI_USB_PMS_CONSTRAN_SRAM_CACHEDATAARRAY_PMS_1 PMS_DMA_APBPERI_USB_PMS_CONSTRAN_SRAM_CACHEDATAARRAY_PMS_0 PMS_DMA_APBPERI_USB_PMS_CONSTRAN_SRAM_PMS_3 PMS_DMA_APBPERI_USB_PMS_CONSTRAN_SRAM_PMS_2 PMS_DMA_APBPERI_USB_PMS_CONSTRAN_SRAM_PMS_1 PMS_DMA_APBPERI_USB_PMS_CONSTRAN_SRAM_PMS_0								
31												12	11	10	9	8	7	6	5	4	3	2	1	0
0	0	0	0	0	0	0	0	0	0	0	0	0	0	0	0	0	0x3	0x3	0x3	0x3	0x3	0x3	0x3	Reset

PMS_DMA_APBPERI_USB_PMS_CONSTRAN_SRAM_PMS_0 Configure USB's permission to the instruction region. (R/W)

PMS_DMA_APBPERI_USB_PMS_CONSTRAN_SRAM_PMS_1 Configure USB's permission to data region0 of SRAM. (R/W)

PMS_DMA_APBPERI_USB_PMS_CONSTRAN_SRAM_PMS_2 Configure USB's permission to data region1 of SRAM. (R/W)

PMS_DMA_APBPERI_USB_PMS_CONSTRAN_SRAM_PMS_3 Configure USB's permission to data region2 of SRAM. (R/W)

PMS_DMA_APBPERI_USB_PMS_CONSTRAN_SRAM_CACHEDATAARRAY_PMS_0 Configure USB's permission to SRAM block9. (R/W)

PMS_DMA_APBPERI_USB_PMS_CONSTRAN_SRAM_CACHEDATAARRAY_PMS_1 Configure USB's permission to SRAM block10. (R/W)

Register 15.29. PMS_DMA_APBPERI_SDIO_PMS_CONSTRRAIN_1_REG (0x00AC)

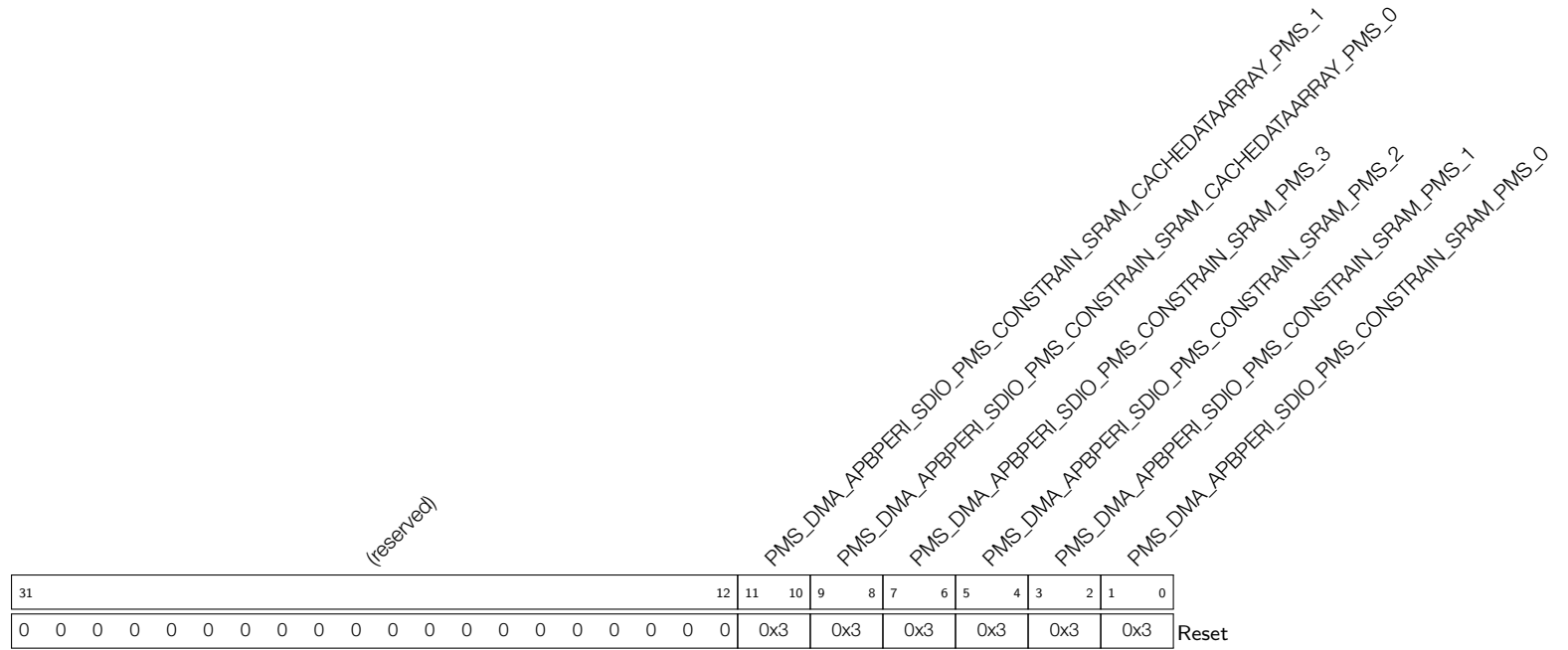

PMS_DMA_APBPERI_SDIO_PMS_CONSTRRAIN_SRAM_PMS_0 Configure SDIO's permission to the instruction region. (R/W)

PMS_DMA_APBPERI_SDIO_PMS_CONSTRRAIN_SRAM_PMS_1 Configure SDIO's permission to data region0 of SRAM. (R/W)

PMS_DMA_APBPERI_SDIO_PMS_CONSTRRAIN_SRAM_PMS_2 Configure SDIO's permission to data region1 of SRAM. (R/W)

PMS_DMA_APBPERI_SDIO_PMS_CONSTRRAIN_SRAM_PMS_3 Configure SDIO's permission to data region2 of SRAM. (R/W)

PMS_DMA_APBPERI_SDIO_PMS_CONSTRRAIN_SRAM_CACHEDATAARRAY_PMS_0 Configure SDIO's permission to SRAM block9 (R/W)

PMS_DMA_APBPERI_SDIO_PMS_CONSTRRAIN_SRAM_CACHEDATAARRAY_PMS_1 Configure SDIO's permission to SRAM block10 (R/W)

Register 15.30. PMS_DMA_APBPERI_PMS_MONITOR_0_REG (0x00B0)

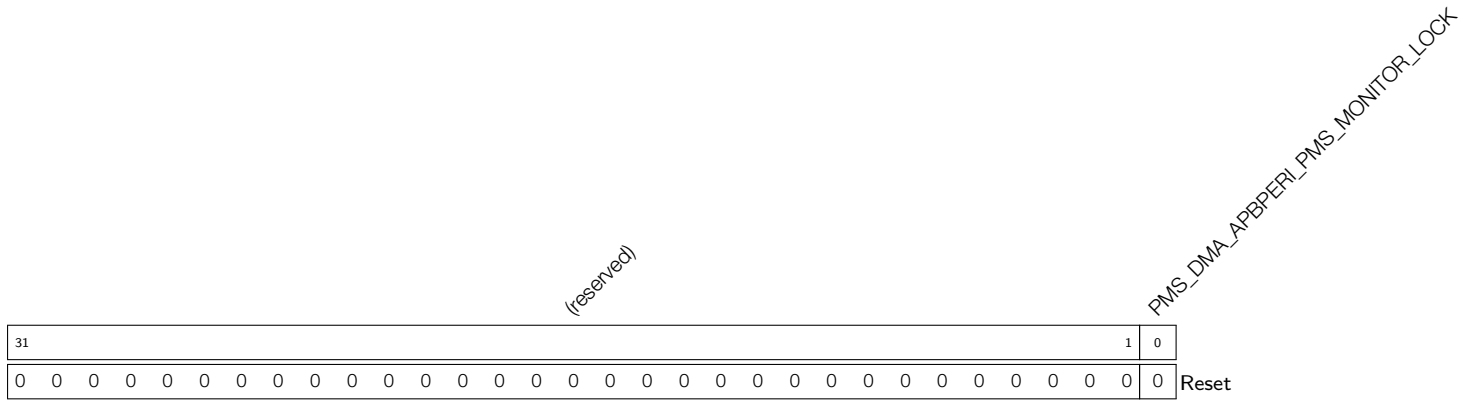

PMS_DMA_APBPERI_PMS_MONITOR_LOCK Set this bit to lock GDMA access interrupt configuration register. (R/W)

Register 15.32. PMS_DMA_APBPERI_PMS_MONITOR_2_REG (0x00B8)

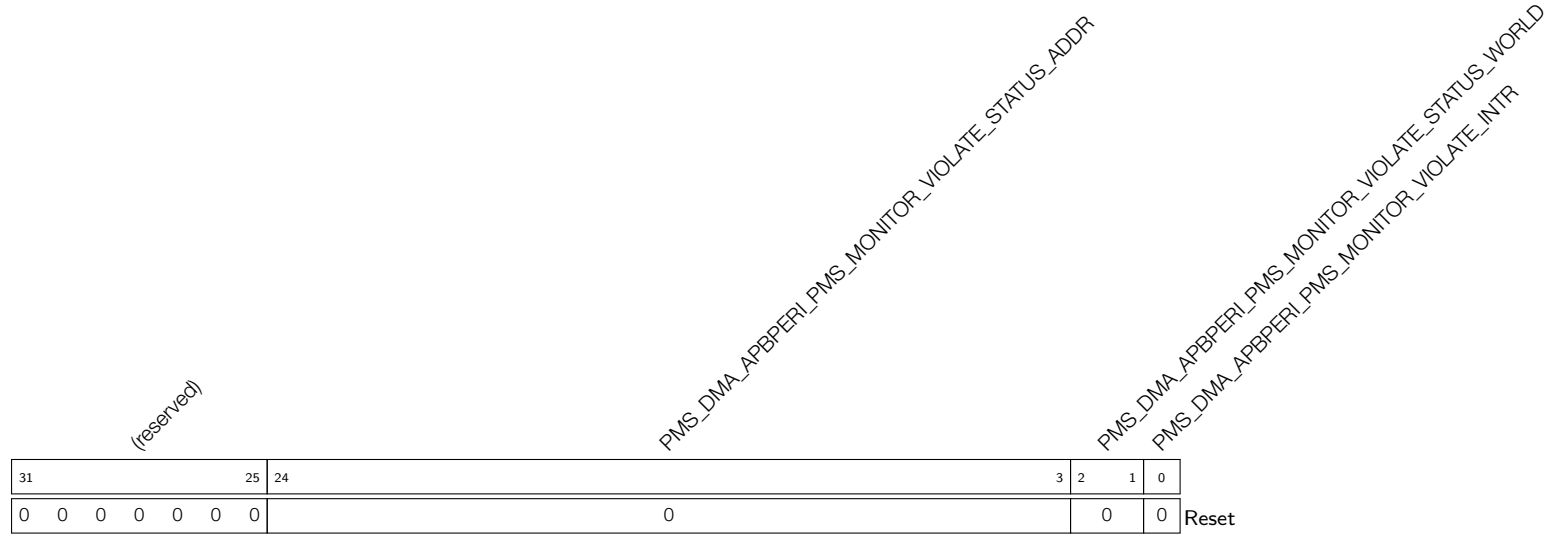

PMS_DMA_APBPERI_PMS_MONITOR_VIOLATE_INTR Stores unauthorized GDMA access interrupt status. (RO)

PMS_DMA_APBPERI_PMS_MONITOR_VIOLATE_STATUS_WORLD Stores the world the CPU was in when the unauthorized GDMA access happened.
0b01: Secure World; 0b10: Non-secure World. (RO)

PMS_DMA_APBPERI_PMS_MONITOR_VIOLATE_STATUS_ADDR Stores the address that triggered the unauthorized GDMA address. Note that this is an offset to 0x3c000000 and the unit is 16, which means the actual address should be 0x3c000000 + [PMS_DMA_APBPERI_PMS_MONITOR_VIOLATE_STATUS_ADDR](#) * 16. (RO)

Register 15.33. PMS_DMA_APBPERI_PMS_MONITOR_3_REG (0x00BC)

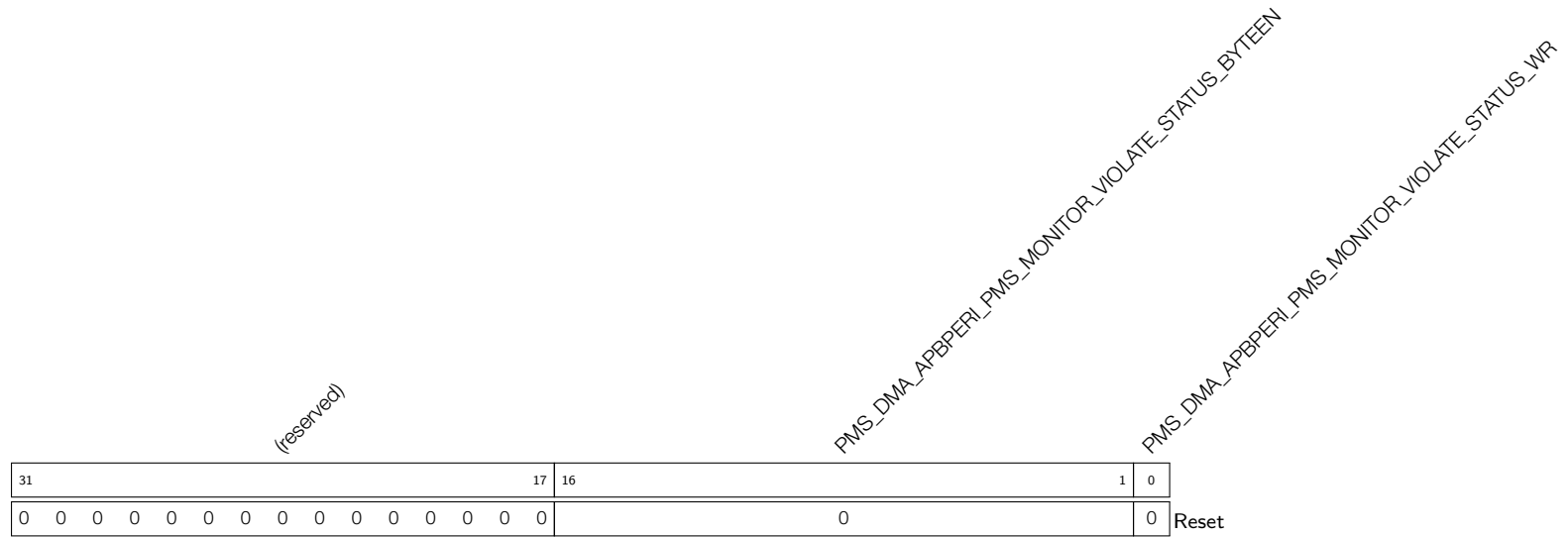

PMS_DMA_APBPERI_PMS_MONITOR_VIOLATE_STATUS_WR Store the direction of unauthorized GDMA access. 1: write; 0: read. (RO)

PMS_DMA_APBPERI_PMS_MONITOR_VIOLATE_STATUS_BYTEEN Stores the byte information of unauthorized GDMA access. (RO)

Register 15.34. PMS_CORE_X_IRAM0_DRAM0_DMA_SPLIT_LINE_CONSTRAIN_0_REG (0x00C0)

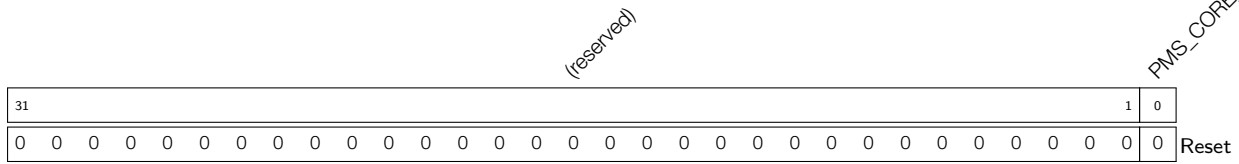

PMS_CORE_X_IRAM0_DRAM0_DMA_SPLIT_LINE_CONSTRAIN_LOCK Set this bit to lock internal SRAM's split lines configuration. (R/W)

Register 15.35. PMS_CORE_X_IRAM0_DRAM0_DMA_SPLIT_LINE_CONSTRAIN_1_REG (0x00C4)

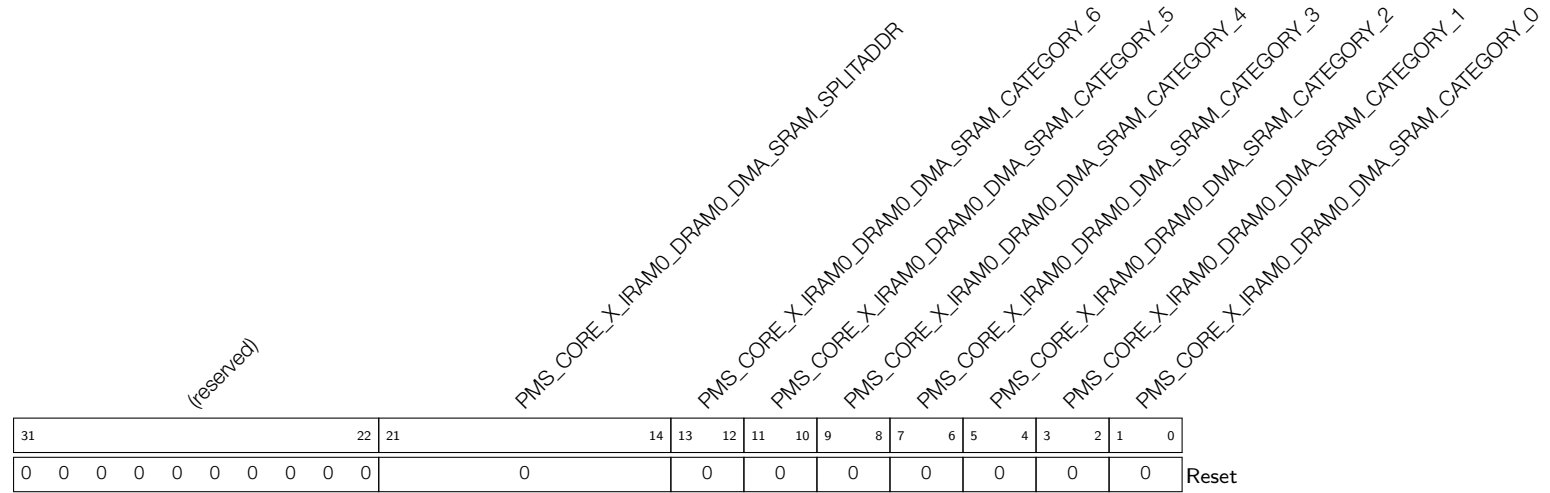

- PMS_CORE_X_IRAM0_DRAM0_DMA_SRAM_CATEGORY_0** Configures Block2's category field for the instruction and data split line IRAM0_DRAM0_Split_Line. (R/W)
- PMS_CORE_X_IRAM0_DRAM0_DMA_SRAM_CATEGORY_1** Configures Block3's category field for the instruction and data split line IRAM0_DRAM0_Split_Line. (R/W)
- PMS_CORE_X_IRAM0_DRAM0_DMA_SRAM_CATEGORY_2** Configures Block4's category field for the instruction and data split line IRAM0_DRAM0_Split_Line. (R/W)
- PMS_CORE_X_IRAM0_DRAM0_DMA_SRAM_CATEGORY_3** Configures Block5's category field for the instruction and data split line IRAM0_DRAM0_Split_Line. (R/W)
- PMS_CORE_X_IRAM0_DRAM0_DMA_SRAM_CATEGORY_4** Configures Block6's category field for the instruction and data split line IRAM0_DRAM0_Split_Line. (R/W)
- PMS_CORE_X_IRAM0_DRAM0_DMA_SRAM_CATEGORY_5** Configures Block7's category field for the instruction and data split line IRAM0_DRAM0_Split_Line. (R/W)
- PMS_CORE_X_IRAM0_DRAM0_DMA_SRAM_CATEGORY_6** Configures Block8's category field for the instruction and data split line IRAM0_DRAM0_Split_Line. (R/W)
- PMS_CORE_X_IRAM0_DRAM0_DMA_SRAM_SPLITADDR** Configures the split address of the instruction and data split line IRAM0_DRAM0_Split_Line. (R/W)

Register 15.36. PMS_CORE_X_IRAM0_DRAM0_DMA_SPLIT_LINE_CONSTRIN_2_REG (0x00C8)

(reserved)										PMS_CORE_X_IRAM0_SRAM_LINE_0_SPLITADDR										PMS_CORE_X_IRAM0_SRAM_LINE_0_CATEGORY_6										PMS_CORE_X_IRAM0_SRAM_LINE_0_CATEGORY_5										PMS_CORE_X_IRAM0_SRAM_LINE_0_CATEGORY_4										PMS_CORE_X_IRAM0_SRAM_LINE_0_CATEGORY_3										PMS_CORE_X_IRAM0_SRAM_LINE_0_CATEGORY_2										PMS_CORE_X_IRAM0_SRAM_LINE_0_CATEGORY_1										PMS_CORE_X_IRAM0_SRAM_LINE_0_CATEGORY_0									
31	30	29	28	27	26	25	24	23	22	21	20	19	18	17	16	15	14	13	12	11	10	9	8	7	6	5	4	3	2	1	0	Reset																																																									
0 0 0 0 0 0 0 0 0 0										0										0										0										0										0										0																													

- PMS_CORE_X_IRAM0_SRAM_LINE_0_CATEGORY_0** Configures Block2's category field for the instruction internal split line IRAM0_Split_Line_0. (R/W)
- PMS_CORE_X_IRAM0_SRAM_LINE_0_CATEGORY_1** Configures Block3's category field for the instruction internal split line IRAM0_Split_Line_0. (R/W)
- PMS_CORE_X_IRAM0_SRAM_LINE_0_CATEGORY_2** Configures Block4's category field for the instruction internal split line IRAM0_Split_Line_0. (R/W)
- PMS_CORE_X_IRAM0_SRAM_LINE_0_CATEGORY_3** Configures Block5's category field for the instruction internal split line IRAM0_Split_Line_0. (R/W)
- PMS_CORE_X_IRAM0_SRAM_LINE_0_CATEGORY_4** Configures Block6's category field for the instruction internal split line IRAM0_Split_Line_0. (R/W)
- PMS_CORE_X_IRAM0_SRAM_LINE_0_CATEGORY_5** Configures Block7's category field for the instruction internal split line IRAM0_Split_Line_0. (R/W)
- PMS_CORE_X_IRAM0_SRAM_LINE_0_CATEGORY_6** Configures Block8's category field for the instruction internal split line IRAM0_Split_Line_0. (R/W)
- PMS_CORE_X_IRAM0_SRAM_LINE_0_SPLITADDR** Configures the split address of the instruction internal split line IRAM0_Split_Line_0. (R/W)

Register 15.37. PMS_CORE_X_IRAM0_DRAM0_DMA_SPLIT_LINE_CONSTRAIN_3_REG (0x00CC)

(reserved)										PMS_CORE_X_IRAM0_DRAM0_DMA_SPLIT_LINE_1_SPLITADDR																								
										PMS_CORE_X_IRAM0_DRAM0_DMA_SPLIT_LINE_1_CATEGORY_6																								
										PMS_CORE_X_IRAM0_DRAM0_DMA_SPLIT_LINE_1_CATEGORY_5																								
										PMS_CORE_X_IRAM0_DRAM0_DMA_SPLIT_LINE_1_CATEGORY_4																								
										PMS_CORE_X_IRAM0_DRAM0_DMA_SPLIT_LINE_1_CATEGORY_3																								
										PMS_CORE_X_IRAM0_DRAM0_DMA_SPLIT_LINE_1_CATEGORY_2																								
										PMS_CORE_X_IRAM0_DRAM0_DMA_SPLIT_LINE_1_CATEGORY_1																								
										PMS_CORE_X_IRAM0_DRAM0_DMA_SPLIT_LINE_1_CATEGORY_0																								
31										22	21									14	13	12	11	10	9	8	7	6	5	4	3	2	1	0
0	0	0	0	0	0	0	0	0	0	0	0	0	0	0	0	0	0	0	0	0	0	0	0	0	0	0	0	0	0	0	0	0	0	0

Reset

- PMS_CORE_X_IRAM0_DRAM0_DMA_SPLIT_LINE_1_CATEGORY_0** Configures Block2's category field for the instruction internal split line IRAM0_Split_Line_1. (R/W)
- PMS_CORE_X_IRAM0_DRAM0_DMA_SPLIT_LINE_1_CATEGORY_1** Configures Block3's category field for the instruction internal split line IRAM0_Split_Line_1. (R/W)
- PMS_CORE_X_IRAM0_DRAM0_DMA_SPLIT_LINE_1_CATEGORY_2** Configures Block4's category field for the instruction internal split line IRAM0_Split_Line_1. (R/W)
- PMS_CORE_X_IRAM0_DRAM0_DMA_SPLIT_LINE_1_CATEGORY_3** Configures Block5's category field for the instruction internal split line IRAM0_Split_Line_1. (R/W)
- PMS_CORE_X_IRAM0_DRAM0_DMA_SPLIT_LINE_1_CATEGORY_4** Configures Block6's category field for the instruction internal split line IRAM0_Split_Line_1. (R/W)
- PMS_CORE_X_IRAM0_DRAM0_DMA_SPLIT_LINE_1_CATEGORY_5** Configures Block7's category field for the instruction internal split line IRAM0_Split_Line_1. (R/W)
- PMS_CORE_X_IRAM0_DRAM0_DMA_SPLIT_LINE_1_CATEGORY_6** Configures Block8's category field for the instruction internal split line IRAM0_Split_Line_1. (R/W)
- PMS_CORE_X_IRAM0_DRAM0_DMA_SPLIT_LINE_1_SPLITADDR** Configures the split address of the instruction internal split line IRAM0_Split_Line_1. (R/W)

Register 15.38. PMS_CORE_X_IRAM0_DRAM0_DMA_SPLIT_LINE_CONSTRAN_4_REG (0x00D0)

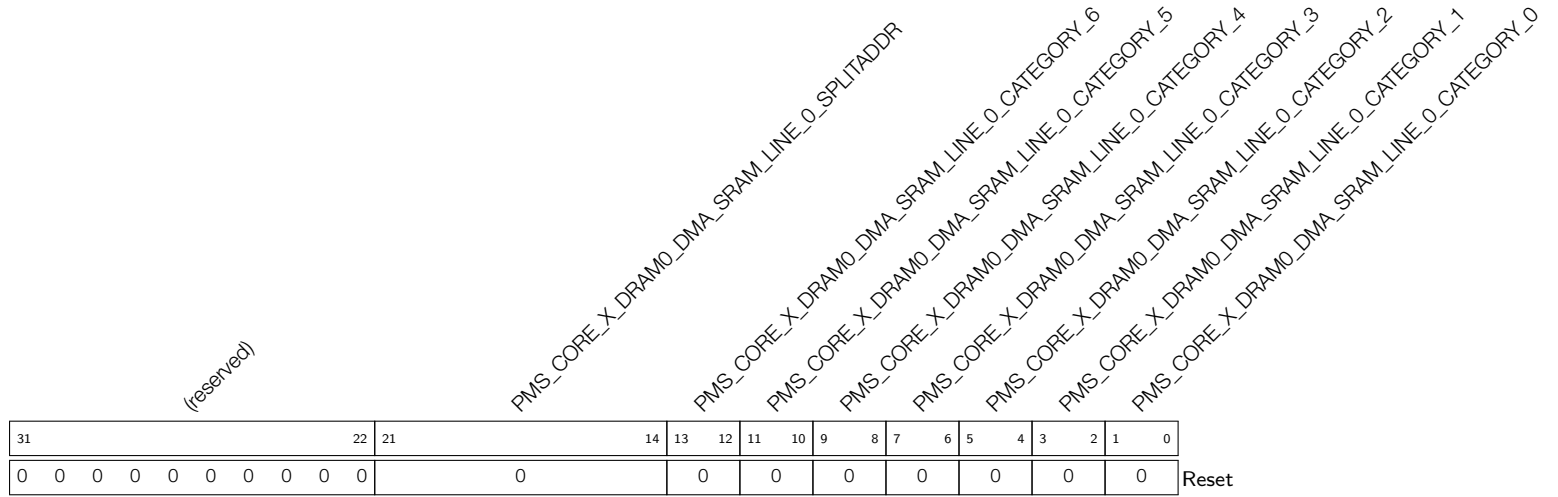

- PMS_CORE_X_DRAM0_DMA_SRAM_LINE_0_CATEGORY_0** Configures Block2's category field for data internal split line DRAM0_Split_Line_0. (R/W)
- PMS_CORE_X_DRAM0_DMA_SRAM_LINE_0_CATEGORY_1** Configures Block3's category field for data internal split line DRAM0_Split_Line_0. (R/W)
- PMS_CORE_X_DRAM0_DMA_SRAM_LINE_0_CATEGORY_2** Configures Block4's category field for data internal split line DRAM0_Split_Line_0. (R/W)
- PMS_CORE_X_DRAM0_DMA_SRAM_LINE_0_CATEGORY_3** Configures Block5's category field for data internal split line DRAM0_Split_Line_0. (R/W)
- PMS_CORE_X_DRAM0_DMA_SRAM_LINE_0_CATEGORY_4** Configures Block6's category field for data internal split line DRAM0_Split_Line_0. (R/W)
- PMS_CORE_X_DRAM0_DMA_SRAM_LINE_0_CATEGORY_5** Configures Block7's category field for data internal split line DRAM0_Split_Line_0. (R/W)
- PMS_CORE_X_DRAM0_DMA_SRAM_LINE_0_CATEGORY_6** Configures Block8's category field for data internal split line DRAM0_Split_Line_0. (R/W)
- PMS_CORE_X_DRAM0_DMA_SRAM_LINE_0_SPLITADDR** Configures the split address of data internal split line DRAM0_Split_Line_0. (R/W)

Register 15.39. PMS_CORE_X_IRAM0_DRAM0_DMA_SPLIT_LINE_CONSTRAIN_5_REG (0x00D4)

(reserved)											<i>PMS_CORE_X_DRAM0_DMA_SPLITADDR</i>															
<i>PMS_CORE_X_DRAM0_DMA_SRAM_LINE_1_CATEGORY_6</i>											<i>PMS_CORE_X_DRAM0_DMA_SRAM_LINE_1_CATEGORY_5</i>															
<i>PMS_CORE_X_DRAM0_DMA_SRAM_LINE_1_CATEGORY_4</i>											<i>PMS_CORE_X_DRAM0_DMA_SRAM_LINE_1_CATEGORY_3</i>															
<i>PMS_CORE_X_DRAM0_DMA_SRAM_LINE_1_CATEGORY_2</i>											<i>PMS_CORE_X_DRAM0_DMA_SRAM_LINE_1_CATEGORY_1</i>															
<i>PMS_CORE_X_DRAM0_DMA_SRAM_LINE_1_CATEGORY_0</i>											Reset															
31						22	21				14	13	12	11	10	9	8	7	6	5	4	3	2	1	0	
0	0	0	0	0	0	0	0	0	0	0	0	0	0	0	0	0	0	0	0	0	0	0	0	0	0	0

- PMS_CORE_X_DRAM0_DMA_SRAM_LINE_1_CATEGORY_0** Configures Block2's category field for data internal split line DRAM0_Split_Line_1. (R/W)
- PMS_CORE_X_DRAM0_DMA_SRAM_LINE_1_CATEGORY_1** Configures Block3's category field for data internal split line DRAM0_Split_Line_1. (R/W)
- PMS_CORE_X_DRAM0_DMA_SRAM_LINE_1_CATEGORY_2** Configures Block4's category field for data internal split line DRAM0_Split_Line_1. (R/W)
- PMS_CORE_X_DRAM0_DMA_SRAM_LINE_1_CATEGORY_3** Configures Block5's category field for data internal split line DRAM0_Split_Line_1. (R/W)
- PMS_CORE_X_DRAM0_DMA_SRAM_LINE_1_CATEGORY_4** Configures Block6's category field for data internal split line DRAM0_Split_Line_1. (R/W)
- PMS_CORE_X_DRAM0_DMA_SRAM_LINE_1_CATEGORY_5** Configures Block7's category field for data internal split line DRAM0_Split_Line_1. (R/W)
- PMS_CORE_X_DRAM0_DMA_SRAM_LINE_1_CATEGORY_6** Configures Block8's category field for data internal split line DRAM0_Split_Line_1. (R/W)
- PMS_CORE_X_DRAM0_DMA_SRAM_LINE_1_SPLITADDR** Configures the split address of data internal split line DRAM0_Split_Line_1. (R/W)

Register 15.40. PMS_CORE_X_IRAM0_PMS_CONSTRIN_0_REG (0x00D8)

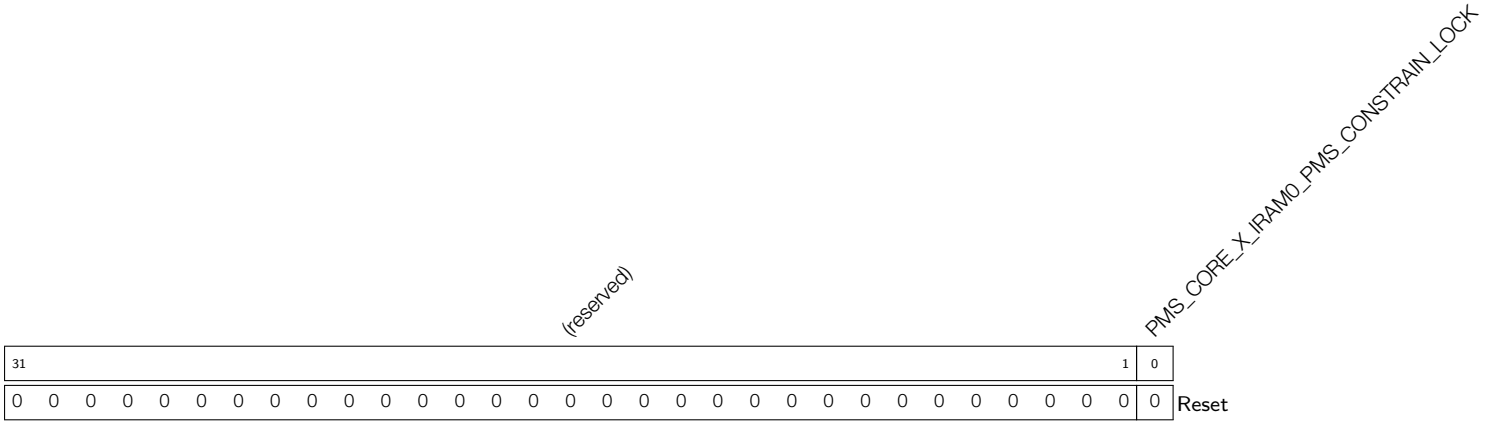

PMS_CORE_X_IRAM0_PMS_CONSTRIN_LOCK Set this bit to lock the permission of CPU IBUS to internal SRAM. (R/W)

Register 15.41. PMS_CORE_X_IRAM0_PMS_CONSTRIN_1_REG (0x00DC)

(reserved)										PMS_CORE_X_IRAM0_PMS_CONSTRIN_ROM_WORLD_1_PMS		PMS_CORE_X_IRAM0_PMS_CONSTRIN_SRAM_WORLD_1_CACHEDATAARRAY_PMS_1				
										PMS_CORE_X_IRAM0_PMS_CONSTRIN_SRAM_WORLD_1_PMS		PMS_CORE_X_IRAM0_PMS_CONSTRIN_SRAM_WORLD_1_PMS_3				
										PMS_CORE_X_IRAM0_PMS_CONSTRIN_SRAM_WORLD_1_PMS_2		PMS_CORE_X_IRAM0_PMS_CONSTRIN_SRAM_WORLD_1_PMS_1				
										PMS_CORE_X_IRAM0_PMS_CONSTRIN_SRAM_WORLD_1_PMS_0						
31	21	20	18	17	15	14	12	11	9	8	6	5	3	2	0	Reset
0	0	0	0	0	0	0	0	0	0	0	0	0	0	0	0	0

PMS_CORE_X_IRAM0_PMS_CONSTRIN_SRAM_WORLD_1_PMS_0 Configures the permission of CPU's IBUS to instruction region0 of SRAM from the Non-secure World. (R/W)

PMS_CORE_X_IRAM0_PMS_CONSTRIN_SRAM_WORLD_1_PMS_1 Configures the permission of CPU's IBUS to instruction region1 of SRAM from the Non-secure World. (R/W)

PMS_CORE_X_IRAM0_PMS_CONSTRIN_SRAM_WORLD_1_PMS_2 Configures the permission of CPU's IBUS to instruction region2 of SRAM from the Non-secure World. (R/W)

PMS_CORE_X_IRAM0_PMS_CONSTRIN_SRAM_WORLD_1_PMS_3 Configures the permission of CPU's IBUS to data region of SRAM from the Non-secure World. It's advised to configure this field to 0. (R/W)

Continued on the next page...

Register 15.41. PMS_CORE_X_IRAM0_PMS_CONSTRAIN_1_REG (0x00DC)

Continued from the previous page...

PMS_CORE_X_IRAM0_PMS_CONSTRAIN_SRAM_WORLD_1_CACHEDATAARRAY_PMS_0 Configure the permission of CPU's IBUS to Block0 of SRAM0 from the Non-secure World. (R/W)

PMS_CORE_X_IRAM0_PMS_CONSTRAIN_SRAM_WORLD_1_CACHEDATAARRAY_PMS_1 Configure the permission of CPU's IBUS to Block1 of SRAM0 from the Non-secure World. (R/W)

PMS_CORE_X_IRAM0_PMS_CONSTRAIN_ROM_WORLD_1_PMS Configures the permission of CPU's IBUS to ROM from the Non-secure World. (R/W)

Register 15.42. PMS_CORE_X_IRAM0_PMS_CONSTRRAIN_2_REG (0x00E0)

(reserved)										PMS_CORE_X_IRAM0_PMS_CONSTRRAIN_ROM_WORLD_0_PMS							PMS_CORE_X_IRAM0_PMS_CONSTRRAIN_SRAM_WORLD_0_CACHEDATAARRAY_PMS_1				
(reserved)										PMS_CORE_X_IRAM0_PMS_CONSTRRAIN_ROM_WORLD_0_PMS							PMS_CORE_X_IRAM0_PMS_CONSTRRAIN_SRAM_WORLD_0_CACHEDATAARRAY_PMS_0				
(reserved)										PMS_CORE_X_IRAM0_PMS_CONSTRRAIN_SRAM_WORLD_0_PMS_3							PMS_CORE_X_IRAM0_PMS_CONSTRRAIN_SRAM_WORLD_0_PMS_2				
(reserved)										PMS_CORE_X_IRAM0_PMS_CONSTRRAIN_SRAM_WORLD_0_PMS_1							PMS_CORE_X_IRAM0_PMS_CONSTRRAIN_SRAM_WORLD_0_PMS_0				
31					21	20	18	17	15	14	12	11	9	8	6	5	3	2	0		
0	0	0	0	0	0	0	0	0	0	0	0	0	0	0	0	0	0	0	0	0	Reset

PMS_CORE_X_IRAM0_PMS_CONSTRRAIN_SRAM_WORLD_0_PMS_0 Configures the permission of CPU's IBUS to instruction region0 of SRAM from the Secure World. (R/W)

PMS_CORE_X_IRAM0_PMS_CONSTRRAIN_SRAM_WORLD_0_PMS_1 Configures the permission of CPU's IBUS to instruction region1 of SRAM from the Secure World. (R/W)

PMS_CORE_X_IRAM0_PMS_CONSTRRAIN_SRAM_WORLD_0_PMS_2 Configures the permission of CPU's IBUS to instruction region2 of SRAM from the Secure World. (R/W)

PMS_CORE_X_IRAM0_PMS_CONSTRRAIN_SRAM_WORLD_0_PMS_3 Configures the permission of CPU's IBUS to data region of SRAM from the Secure World. It's advised to configure this field to 0. (R/W)

Continued on the next page...

Register 15.42. PMS_CORE_X_IRAM0_PMS_CONSTRRAIN_2_REG (0x00E0)

Continued from the previous page...

PMS_CORE_X_IRAM0_PMS_CONSTRRAIN_SRAM_WORLD_0_CACHEDATAARRAY_PMS_0 Configure the permission of CPU's IBUS to Block0 of SRAM0 from the Secure World. (R/W)

PMS_CORE_X_IRAM0_PMS_CONSTRRAIN_SRAM_WORLD_0_CACHEDATAARRAY_PMS_1 Configure the permission of CPU's IBUS to Block1 of SRAM0 from the Secure World. (R/W)

PMS_CORE_X_IRAM0_PMS_CONSTRRAIN_ROM_WORLD_0_PMS Configures the permission of CPU's IBUS to ROM from the Secure World. (R/W)

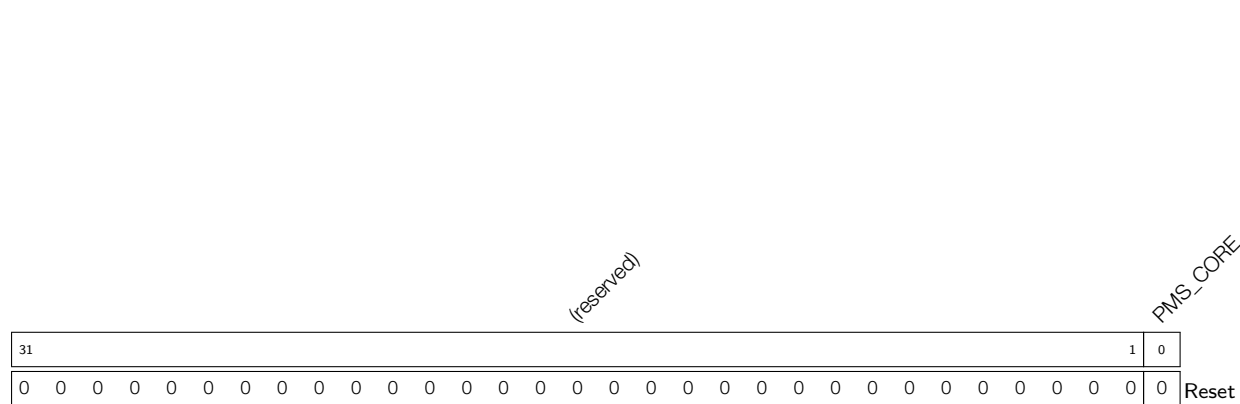
Register 15.43. PMS_CORE_0_IRAM0_PMS_MONITOR_0_REG (0x00E4)

PMS_CORE_0_IRAM0_PMS_MONITOR_LOCK Set this bit to lock CPU0's IBUS interrupt configuration. (R/W)

Register 15.45. PMS_CORE_X_DRAM0_PMS_CONSTRAIN_0_REG (0x00FC)

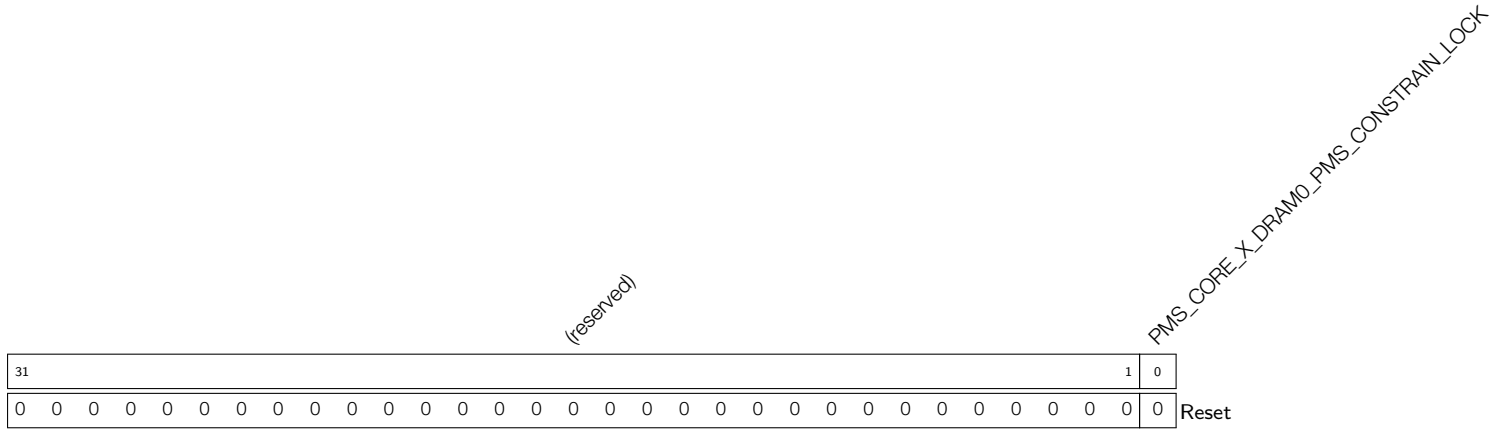

PMS_CORE_X_DRAM0_PMS_CONSTRAIN_LOCK Set this bit to lock the permission of CPU DBUS to internal SRAM. (R/W)

Register 15.46. PMS_CORE_X_DRAM0_PMS_CONSTRIN_1_REG (0x0100)

(reserved)	PMS_CORE_X_DRAM0_PMS_CONSTRIN_ROM_WORLD_1_PMS	PMS_CORE_X_DRAM0_PMS_CONSTRIN_ROM_WORLD_0_PMS	PMS_CORE_X_DRAM0_PMS_CONSTRIN_SRAM_WORLD_1_CACHEDATAARRAY_PMS_1	PMS_CORE_X_DRAM0_PMS_CONSTRIN_SRAM_WORLD_1_CACHEDATAARRAY_PMS_0	PMS_CORE_X_DRAM0_PMS_CONSTRIN_SRAM_WORLD_1_PMS_3	PMS_CORE_X_DRAM0_PMS_CONSTRIN_SRAM_WORLD_1_PMS_2	PMS_CORE_X_DRAM0_PMS_CONSTRIN_SRAM_WORLD_1_PMS_1	PMS_CORE_X_DRAM0_PMS_CONSTRIN_SRAM_WORLD_0_CACHEDATAARRAY_PMS_1	PMS_CORE_X_DRAM0_PMS_CONSTRIN_SRAM_WORLD_0_CACHEDATAARRAY_PMS_0	PMS_CORE_X_DRAM0_PMS_CONSTRIN_SRAM_WORLD_0_PMS_3	PMS_CORE_X_DRAM0_PMS_CONSTRIN_SRAM_WORLD_0_PMS_2	PMS_CORE_X_DRAM0_PMS_CONSTRIN_SRAM_WORLD_0_PMS_1	PMS_CORE_X_DRAM0_PMS_CONSTRIN_SRAM_WORLD_0_PMS_0																	
31	28	27	26	25	24	23	22	21	20	19	18	17	16	15	14	13	12	11	10	9	8	7	6	5	4	3	2	1	0	Reset
0	0	0	0	0x3	0x3	0x3	0x3	0x3	0x3	0x3	0x3	0x3	0x3	0x3	0x3	0x3	0x3	0x3	0x3	0x3	0x3	0x3	0x3	0x3	0x3	0x3	0x3	0x3	0x3	

PMS_CORE_X_DRAM0_PMS_CONSTRIN_SRAM_WORLD_0_PMS_0 Configures the permission of CPU's DBUS to instruction region of SRAM from the Secure World. It's advised to configure this field to 0. (R/W)

PMS_CORE_X_DRAM0_PMS_CONSTRIN_SRAM_WORLD_0_PMS_1 Configures the permission of CPU's DBUS to data region0 of SRAM from the Secure World. (R/W)

PMS_CORE_X_DRAM0_PMS_CONSTRIN_SRAM_WORLD_0_PMS_2 Configures the permission of CPU's DBUS to data region1 of SRAM from the Secure World. (R/W)

Continued on the next page...

Register 15.46. PMS_CORE_X_DRAM0_PMS_CONSTRAIN_1_REG (0x0100)

Continued from the previous page...

PMS_CORE_X_DRAM0_PMS_CONSTRAIN_SRAM_WORLD_0_PMS_3 Configures the permission of CPU's DBUS to data region2 of SRAM from the Secure World. (R/W)

PMS_CORE_X_DRAM0_PMS_CONSTRAIN_SRAM_WORLD_0_CACHEDATAARRAY_PMS_0 Configures the permission of CPU's DBUS to block9 of SRAM2 from the Secure World. (R/W)

PMS_CORE_X_DRAM0_PMS_CONSTRAIN_SRAM_WORLD_0_CACHEDATAARRAY_PMS_1 Configures the permission of CPU's DBUS to block10 of SRAM2 from the Secure World. (R/W)

PMS_CORE_X_DRAM0_PMS_CONSTRAIN_SRAM_WORLD_1_PMS_0 Configures the permission of CPU's DBUS to instruction region of SRAM from the Non-secure World. (R/W)

PMS_CORE_X_DRAM0_PMS_CONSTRAIN_SRAM_WORLD_1_PMS_1 Configures the permission of CPU's DBUS to data region0 of SRAM from the Non-secure World. (R/W)

PMS_CORE_X_DRAM0_PMS_CONSTRAIN_SRAM_WORLD_1_PMS_2 Configures the permission of CPU's DBUS to data region1 of SRAM from the Non-secure World. (R/W)

PMS_CORE_X_DRAM0_PMS_CONSTRAIN_SRAM_WORLD_1_PMS_3 Configures the permission of CPU's DBUS to data region2 of SRAM from the Non-secure World. (R/W)

PMS_CORE_X_DRAM0_PMS_CONSTRAIN_SRAM_WORLD_1_CACHEDATAARRAY_PMS_0 Configures the permission of CPU's DBUS to block9 of SRAM2 from the Non-secure World. (R/W)

PMS_CORE_X_DRAM0_PMS_CONSTRAIN_SRAM_WORLD_1_CACHEDATAARRAY_PMS_1 Configures the permission of CPU's DBUS to block10 of SRAM2 from the Non-secure World. (R/W)

PMS_CORE_X_DRAM0_PMS_CONSTRAIN_ROM_WORLD_0_PMS Configures the permission of CPU's DBUS to ROM from the Secure World. (R/W)

PMS_CORE_X_DRAM0_PMS_CONSTRAIN_ROM_WORLD_1_PMS Configures the permission of CPU's DBUS to ROM from the Non-secure World. (R/W)

Register 15.48. PMS_CORE_0_DRAM0_PMS_MONITOR_1_REG (0x0108)

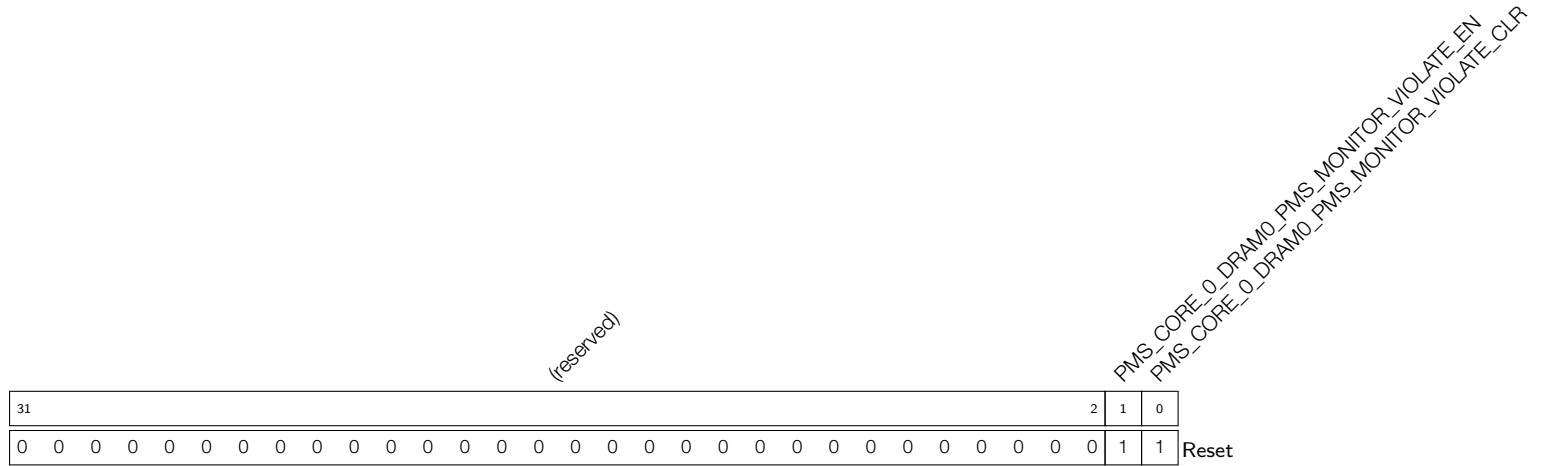

PMS_CORE_0_DRAM0_PMS_MONITOR_VIOLATE_CLR Set this bit to clear the interrupt triggered when CPU0's dBUS tries to access SRAM or ROM unauthorized. (R/W)

PMS_CORE_0_DRAM0_PMS_MONITOR_VIOLATE_EN Set this bit to enable interrupt when CPU0's dBUS tries to access SRAM or ROM unauthorized. (R/W)

Register 15.49. PMS_CORE_0_PIF_PMS_CONSTRAIN_0_REG (0x0124)

(reserved)														1	0	Reset	
0	0	0	0	0	0	0	0	0	0	0	0	0	0	0	0		0

PMS_CORE_0_PIF_PMS_CONSTRAIN_LOCK Set this bit to lock Core0's permission to different peripherals. (R/W)

Register 15.50. PMS_CORE_0_PIF_PMS_CONSTRRAIN_n_REG (n: 1 - 8) (0x0128 + 4*n)

PMS_CORE_0_PIF_PMS_CONSTRRAIN_WORLD_0_UART1					(reserved)					PMS_CORE_0_PIF_PMS_CONSTRRAIN_WORLD_0_IO_MUX					(reserved)					PMS_CORE_0_PIF_PMS_CONSTRRAIN_WORLD_0_GPIO					PMS_CORE_0_PIF_PMS_CONSTRRAIN_WORLD_0_G0SPI_0					PMS_CORE_0_PIF_PMS_CONSTRRAIN_WORLD_0_G0SPI_1					PMS_CORE_0_PIF_PMS_CONSTRRAIN_WORLD_0_UART				
31	30	29	28	27								18	17	16	15	14	13								8	7	6	5	4	3	2	1	0						
0x3		0x3		0	0	0	0	0	0	0	0	0	0x3		0x3		0	0	0	0	0	0	0	0	0x3		0x3		0x3		0x3		Reset						

PMS_CORE_0_PIF_PMS_CONSTRRAIN_WORLD_0_UART Configures CPU0's permission to access UART0 from the Secure World. (R/W)

PMS_CORE_0_PIF_PMS_CONSTRRAIN_WORLD_0_G0SPI_1 Configures CPU0's permission to access SPI1 from the Secure World. (R/W)

PMS_CORE_0_PIF_PMS_CONSTRRAIN_WORLD_0_G0SPI_0 Configures CPU0's permission to access SPI0 from the Secure World. (R/W)

PMS_CORE_0_PIF_PMS_CONSTRRAIN_WORLD_0_GPIO Configures CPU0's permission to access GPIO from the Secure World. (R/W)

PMS_CORE_0_PIF_PMS_CONSTRRAIN_WORLD_0_RTC Configures CPU0's permission to access eFuse Controller & PMU from the Secure World. (R/W)

PMS_CORE_0_PIF_PMS_CONSTRRAIN_WORLD_0_IO_MUX Configures CPU0's permission to access IO_MUX from the Secure World. (R/W)

PMS_CORE_0_PIF_PMS_CONSTRRAIN_WORLD_0_I2S0 Configures CPU0's permission to access I2S0 from the Secure World. (R/W)

PMS_CORE_0_PIF_PMS_CONSTRRAIN_WORLD_0_UART1 Configures CPU0's permission to access UART1 from the Secure World. (R/W)

Note:

- Registers `PMS_CORE_0_PIF_PMS_CONSTRRAIN_n_REG` (n : 1 - 4) are for configuring the CPU0's permission to different peripherals from the Secure World.
- Registers `PMS_CORE_0_PIF_PMS_CONSTRRAIN_n_REG` (n : 5 - 8) are for configuring the CPU0's permission to different peripherals from the Non-secure World.
- Detailed information are already provided in Table 15-17. For brevity, these registers are not described separately in this section.

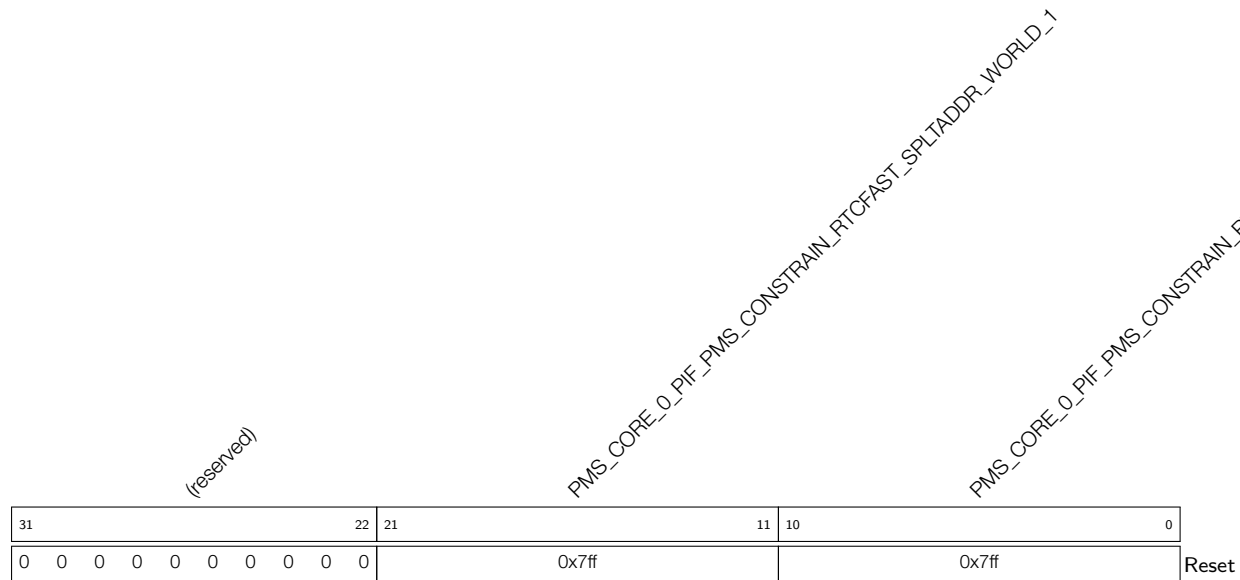
Register 15.51. PMS_CORE_0_PIF_PMS_CONSTRRAIN_9_REG (0x0148)

PMS_CORE_0_PIF_PMS_CONSTRRAIN_RTCFAST_SPLTADDR_WORLD_0 Configures the address to split RTC Fast Memory into two regions in Non-secure World for CPU0. Note you should use address offset, instead of absolute address. (R/W)

PMS_CORE_0_PIF_PMS_CONSTRRAIN_RTCFAST_SPLTADDR_WORLD_1 Configures the address to split RTC Fast Memory into two regions in Secure World for CPU0. Note you should use address offset, instead of absolute address. (R/W)

Register 15.52. PMS_CORE_0_PIF_PMS_CONSTRRAIN_10_REG (0x014C)

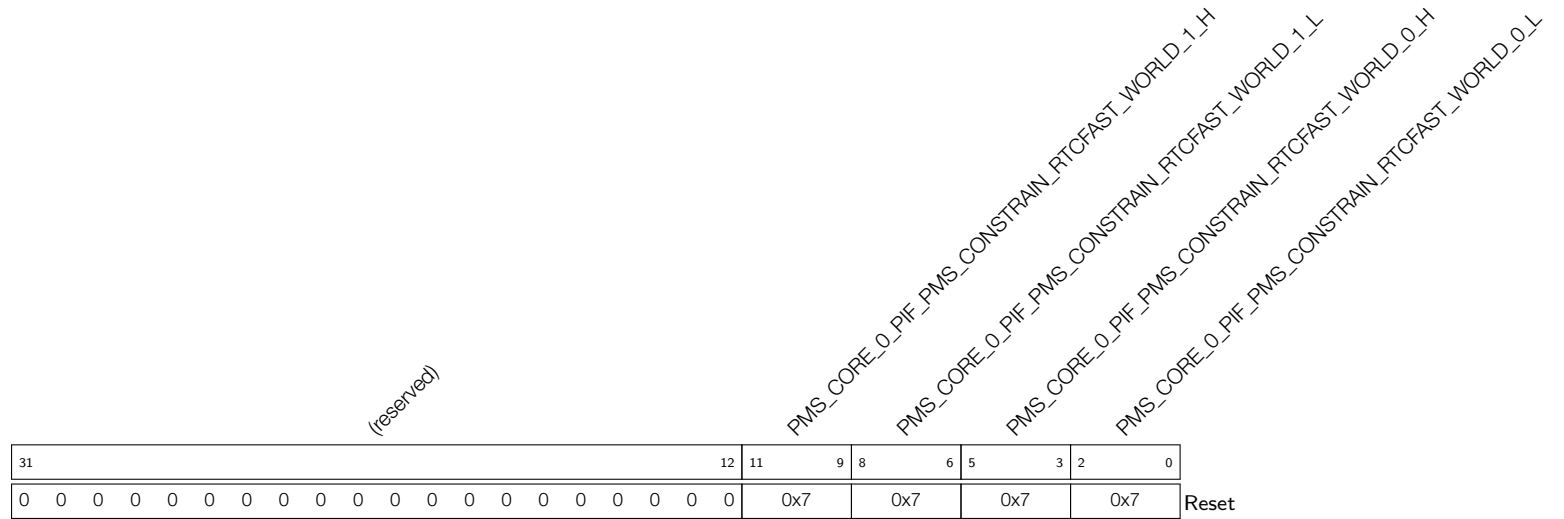

PMS_CORE_0_PIF_PMS_CONSTRRAIN_RTCFAST_WORLD_0_L Configures the permission of CPU0 from Non-secure World to the lower region of RTC Fast Memory. (R/W)

PMS_CORE_0_PIF_PMS_CONSTRRAIN_RTCFAST_WORLD_0_H Configures the permission of CPU0 from Non-secure World to the higher region of RTC Fast Memory. (R/W)

PMS_CORE_0_PIF_PMS_CONSTRRAIN_RTCFAST_WORLD_1_L Configures the permission of CPU0 from Secure World to the lower region of RTC Fast Memory. (R/W)

PMS_CORE_0_PIF_PMS_CONSTRRAIN_RTCFAST_WORLD_1_H Configures the permission of CPU0 from Secure World to the higher region of RTC Fast Memory. (R/W)

Register 15.53. PMS_CORE_0_PIF_PMS_CONSTRRAIN_11_REG (0x0150)

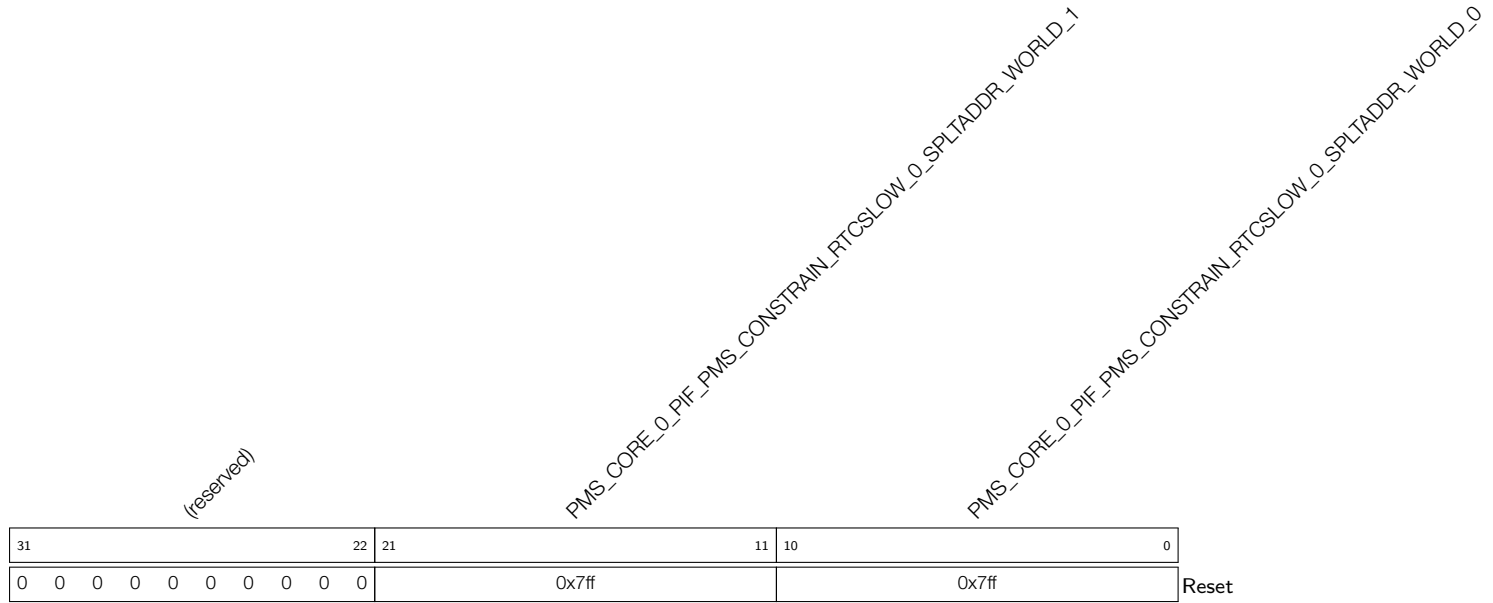

PMS_CORE_0_PIF_PMS_CONSTRRAIN_RTCLOW_0_SPLADDR_WORLD_0 Configures the address to split RTC Slow Memory 0 into two regions in Secure World for CPU0. Note you should use address offset, instead of absolute address. (R/W)

PMS_CORE_0_PIF_PMS_CONSTRRAIN_RTCLOW_0_SPLADDR_WORLD_1 Configures the address to split RTC Slow Memory 0 into two regions in Non-secure World for CPU0. Note you should use address offset, instead of absolute address. (R/W)

Register 15.54. PMS_CORE_0_PIF_PMS_CONSTRRAIN_12_REG (0x0154)

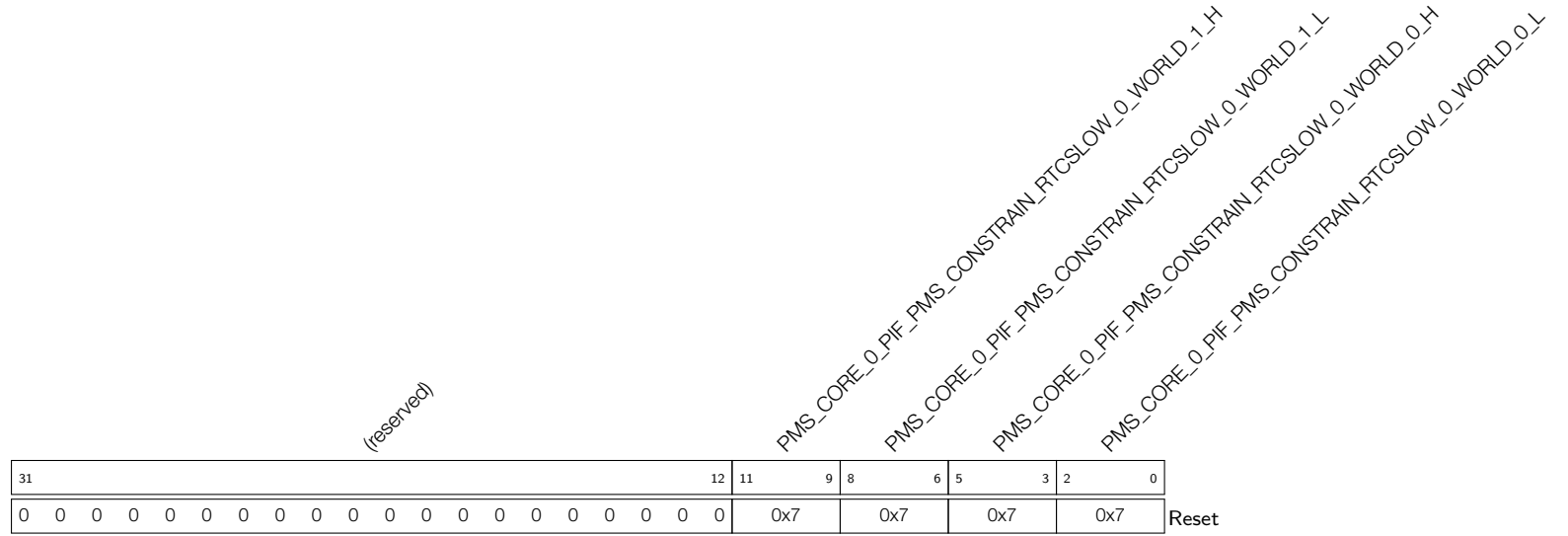

- PMS_CORE_0_PIF_PMS_CONSTRRAIN_RTCSSLOW_0_WORLD_0_L** Configures the permission of CPU0 from Secure World to the lower region of RTC Slow Memory 0. (R/W)
- PMS_CORE_0_PIF_PMS_CONSTRRAIN_RTCSSLOW_0_WORLD_0_H** Configures the permission of CPU0 from Secure World to the higher region of RTC Slow Memory 0. (R/W)
- PMS_CORE_0_PIF_PMS_CONSTRRAIN_RTCSSLOW_0_WORLD_1_L** Configures the permission of CPU0 from Non-secure World to the lower region of RTC Slow Memory 0. (R/W)
- PMS_CORE_0_PIF_PMS_CONSTRRAIN_RTCSSLOW_0_WORLD_1_H** Configures the permission of CPU0 from Non-secure World to the higher region of RTC Slow Memory 0. (R/W)

Register 15.55. PMS_CORE_0_PIF_PMS_CONSTRIN_13_REG (0x0158)

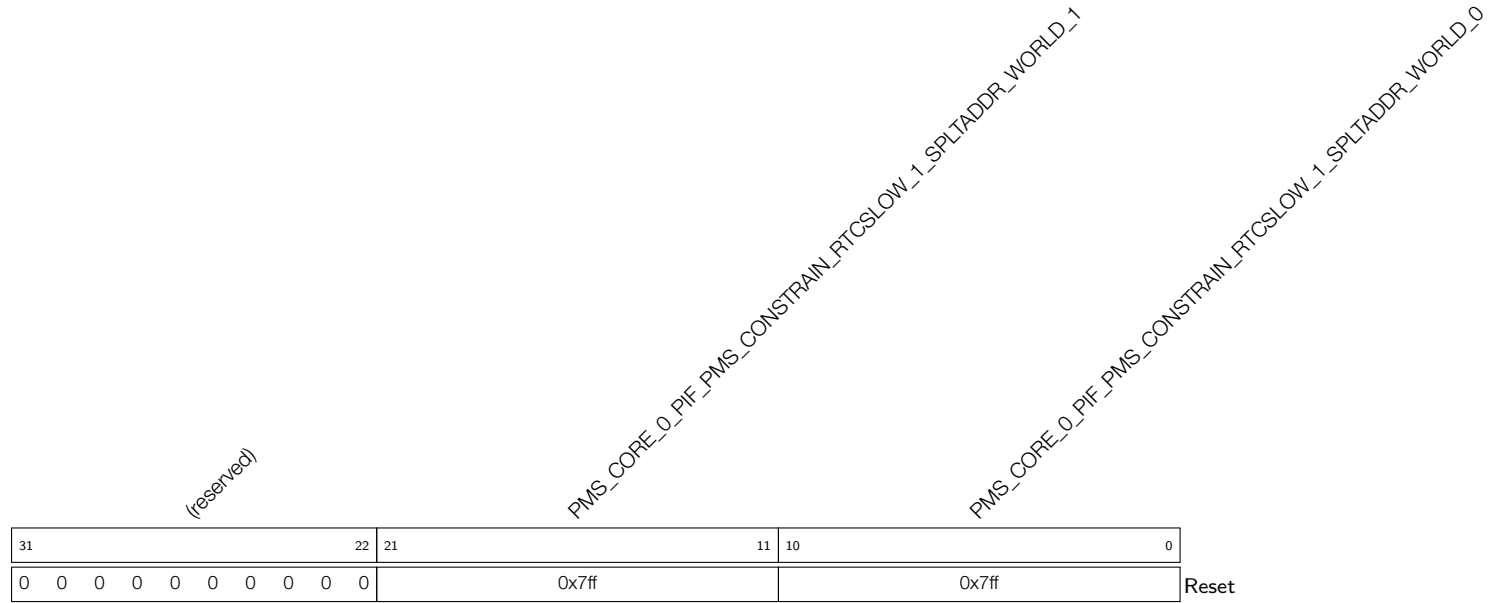

PMS_CORE_0_PIF_PMS_CONSTRIN_RTCLOW_1_SPLADDR_WORLD_0 Configures the address to split RTC Slow Memory 1 into two regions in Secure World for CPU0. Note you should use address offset, instead of absolute address. (R/W)

PMS_CORE_0_PIF_PMS_CONSTRIN_RTCLOW_1_SPLADDR_WORLD_1 Configures the address to split RTC Slow Memory 1 into two regions in Non-secure World for CPU0. Note you should use address offset, instead of absolute address. (R/W)

Register 15.56. PMS_CORE_0_PIF_PMS_CONSTRRAIN_14_REG (0x015C)

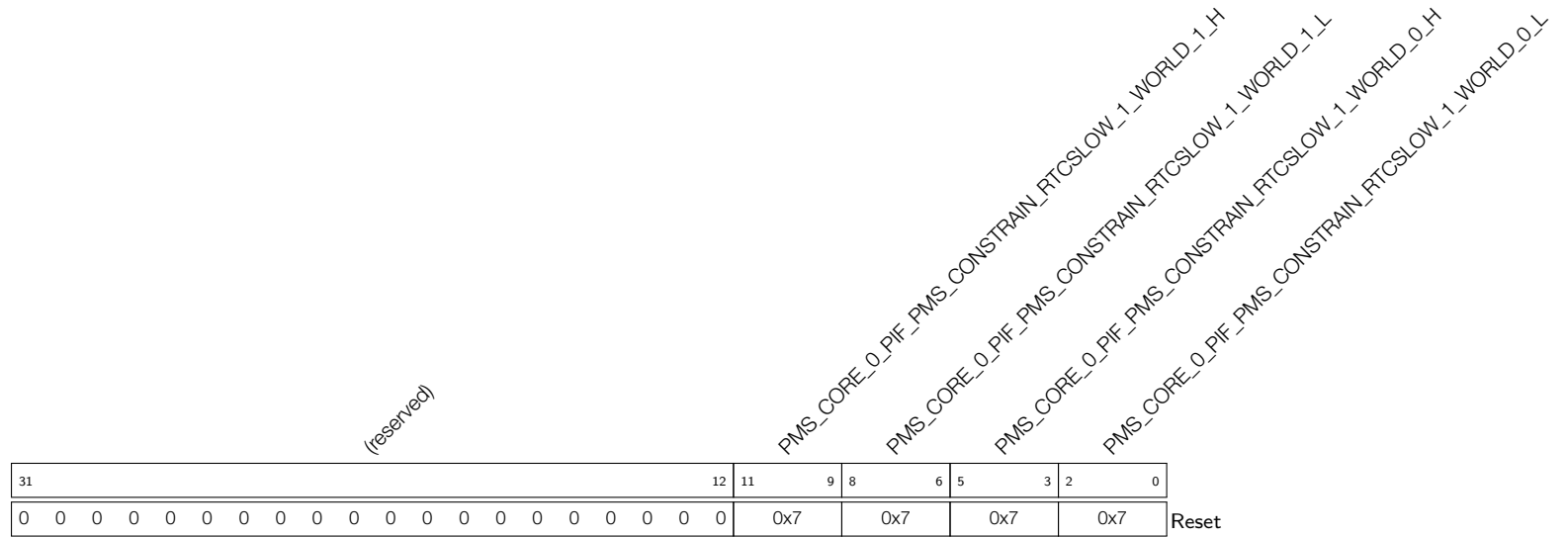

PMS_CORE_0_PIF_PMS_CONSTRRAIN_RTCSSLOW_1_WORLD_0_L Configures the permission of CPU0 from Non-secure World to the lower region of RTC Slow Memory 1. (R/W)

PMS_CORE_0_PIF_PMS_CONSTRRAIN_RTCSSLOW_1_WORLD_0_H Configures the permission of CPU0 from Non-secure World to the higher region of RTC Slow Memory 1. (R/W)

PMS_CORE_0_PIF_PMS_CONSTRRAIN_RTCSSLOW_1_WORLD_1_L Configures the permission of CPU0 from Secure World to the lower region of RTC Slow Memory 1. (R/W)

PMS_CORE_0_PIF_PMS_CONSTRRAIN_RTCSSLOW_1_WORLD_1_H Configures the permission of CPU0 from Secure World to the higher region of RTC Slow Memory 1. (R/W)

Register 15.57. PMS_CORE_0_REGION_PMS_CONSTRAIN_0_REG (0x0160)

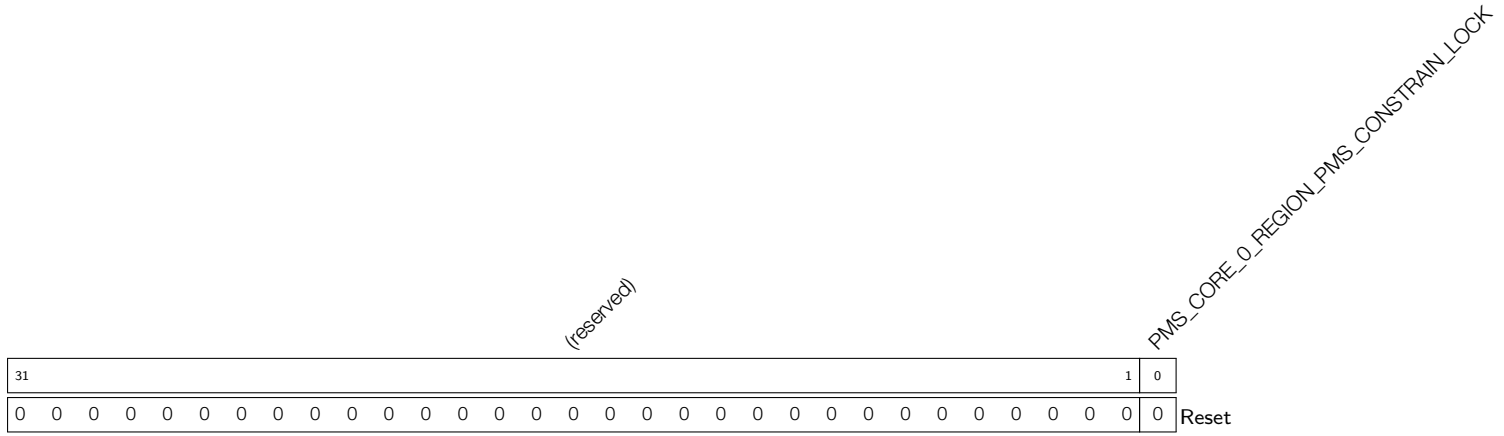

PMS_CORE_0_REGION_PMS_CONSTRAIN_LOCK Set this bit to lock Core0's permission to peripheral regions. (R/W)

Register 15.58. PMS_CORE_0_REGION_PMS_CONSTRAIN_1_REG (0x0164)

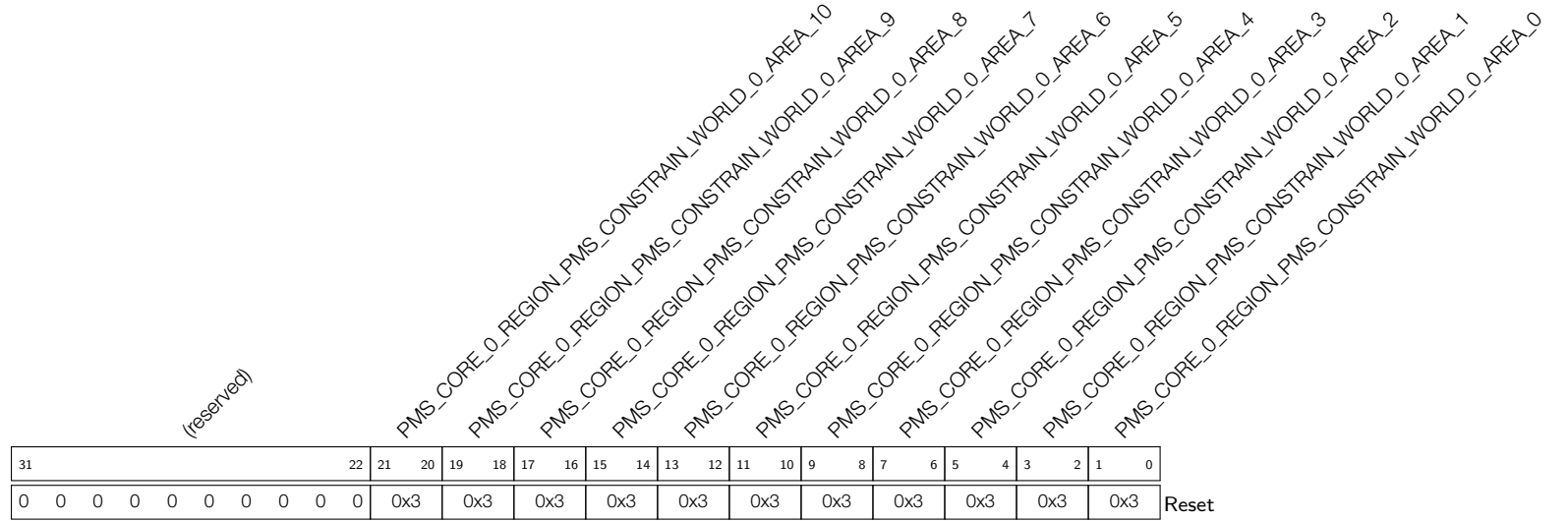

- PMS_CORE_0_REGION_PMS_CONSTRAIN_WORLD_0_AREA_0** Configures CPU0's permission to Peri Region0 from the Secure World. (R/W)
- PMS_CORE_0_REGION_PMS_CONSTRAIN_WORLD_0_AREA_1** Configures CPU0's permission to Peri Region1 from the Secure World. (R/W)
- PMS_CORE_0_REGION_PMS_CONSTRAIN_WORLD_0_AREA_2** Configures CPU0's permission to Peri Region2 from the Secure World. (R/W)
- PMS_CORE_0_REGION_PMS_CONSTRAIN_WORLD_0_AREA_3** Configures CPU0's permission to Peri Region3 from the Secure World. (R/W)
- PMS_CORE_0_REGION_PMS_CONSTRAIN_WORLD_0_AREA_4** Configures CPU0's permission to Peri Region4 from the Secure World (R/W)
- PMS_CORE_0_REGION_PMS_CONSTRAIN_WORLD_0_AREA_5** Configures CPU0's permission to Peri Region5 from the Secure World. (R/W)
- PMS_CORE_0_REGION_PMS_CONSTRAIN_WORLD_0_AREA_6** Configures CPU0's permission to Peri Region6 from the Secure World. (R/W)
- PMS_CORE_0_REGION_PMS_CONSTRAIN_WORLD_0_AREA_7** Configures CPU0's permission to Peri Region7 from the Secure World. (R/W)
- PMS_CORE_0_REGION_PMS_CONSTRAIN_WORLD_0_AREA_8** Configures CPU0's permission to Peri Region8 from the Secure World. (R/W)
- PMS_CORE_0_REGION_PMS_CONSTRAIN_WORLD_0_AREA_9** Configures CPU0's permission to Peri Region9 from the Secure World. (R/W)
- PMS_CORE_0_REGION_PMS_CONSTRAIN_WORLD_0_AREA_10** Configures CPU0's permission to Peri Region10 from the Secure World. (R/W)

Register 15.59. PMS_CORE_0_REGION_PMS_CONSTRAIN_2_REG (0x0168)

(reserved)										PMS_CORE_0_REGION_PMS_CONSTRAIN_WORLD_1_AREA_10										PMS_CORE_0_REGION_PMS_CONSTRAIN_WORLD_1_AREA_9										PMS_CORE_0_REGION_PMS_CONSTRAIN_WORLD_1_AREA_8										PMS_CORE_0_REGION_PMS_CONSTRAIN_WORLD_1_AREA_7										PMS_CORE_0_REGION_PMS_CONSTRAIN_WORLD_1_AREA_6										PMS_CORE_0_REGION_PMS_CONSTRAIN_WORLD_1_AREA_5										PMS_CORE_0_REGION_PMS_CONSTRAIN_WORLD_1_AREA_4										PMS_CORE_0_REGION_PMS_CONSTRAIN_WORLD_1_AREA_3										PMS_CORE_0_REGION_PMS_CONSTRAIN_WORLD_1_AREA_2										PMS_CORE_0_REGION_PMS_CONSTRAIN_WORLD_1_AREA_1										PMS_CORE_0_REGION_PMS_CONSTRAIN_WORLD_1_AREA_0									
31	30	29	28	27	26	25	24	23	22	21	20	19	18	17	16	15	14	13	12	11	10	9	8	7	6	5	4	3	2	1	0																																																																																								
0	0	0	0	0	0	0	0	0	0	0x3	0x3	0x3	0x3	0x3	0x3	0x3	0x3	0x3	0x3	0x3	0x3	0x3	0x3	0x3	0x3	0x3	0x3	0x3	0x3	0x3	0x3	0x3	Reset																																																																																						

- PMS_CORE_0_REGION_PMS_CONSTRAIN_WORLD_1_AREA_0** Configures CPU0's permission to Peri Region0 from the Non-secure World. (R/W)
- PMS_CORE_0_REGION_PMS_CONSTRAIN_WORLD_1_AREA_1** Configures CPU0's permission to Peri Region1 from the Non-secure World. (R/W)
- PMS_CORE_0_REGION_PMS_CONSTRAIN_WORLD_1_AREA_2** Configures CPU0's permission to Peri Region2 from the Non-secure World. (R/W)
- PMS_CORE_0_REGION_PMS_CONSTRAIN_WORLD_1_AREA_3** Configures CPU0's permission to Peri Region3 from the Non-secure World. (R/W)
- PMS_CORE_0_REGION_PMS_CONSTRAIN_WORLD_1_AREA_4** Configures CPU0's permission to Peri Region4 from the Non-secure World. (R/W)
- PMS_CORE_0_REGION_PMS_CONSTRAIN_WORLD_1_AREA_5** Configures CPU0's permission to Peri Region5 from the Non-secure World. (R/W)
- PMS_CORE_0_REGION_PMS_CONSTRAIN_WORLD_1_AREA_6** Configures CPU0's permission to Peri Region6 from the Non-secure World. (R/W)
- PMS_CORE_0_REGION_PMS_CONSTRAIN_WORLD_1_AREA_7** Configures CPU0's permission to Peri Region7 from the Non-secure World. (R/W)
- PMS_CORE_0_REGION_PMS_CONSTRAIN_WORLD_1_AREA_8** Configures CPU0's permission to Peri Region8 from the Non-secure World. (R/W)
- PMS_CORE_0_REGION_PMS_CONSTRAIN_WORLD_1_AREA_9** Configures CPU0's permission to Peri Region9 from the Non-secure World. (R/W)
- PMS_CORE_0_REGION_PMS_CONSTRAIN_WORLD_1_AREA_10** Configures CPU0's permission to Peri Region10 from the Non-secure World. (R/W)

Register 15.60. PMS_CORE_0_REGION_PMS_CONSTRAIN_n_REG ($n: 3 - 14$) ($0x016C + 4*n$)

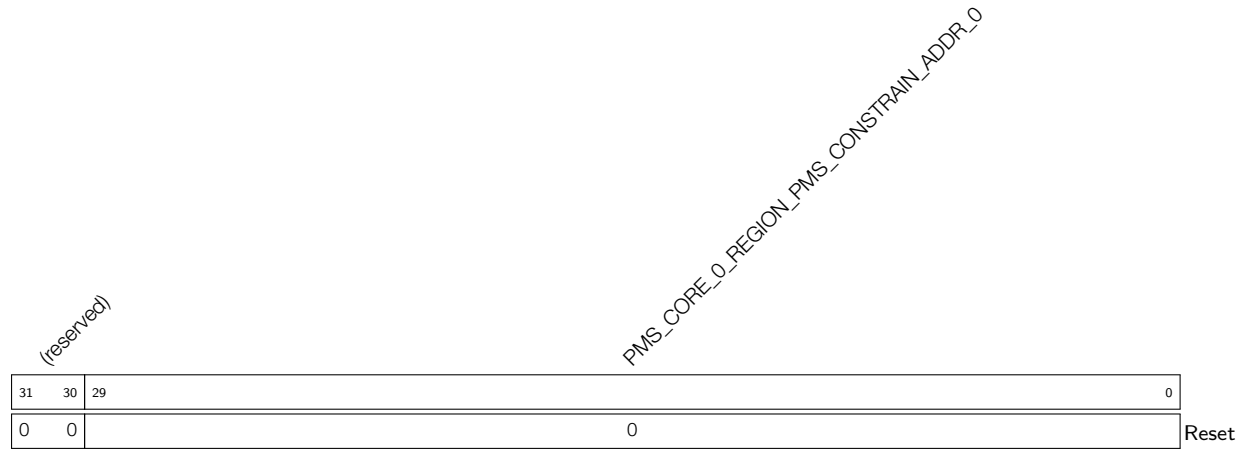

PMS_CORE_0_REGION_PMS_CONSTRAIN_ADDR_0 Configures the starting address of Region 0 for CPU0. (R/W)

Register 15.61. PMS_CORE_0_PIF_PMS_MONITOR_0_REG (0x019C)

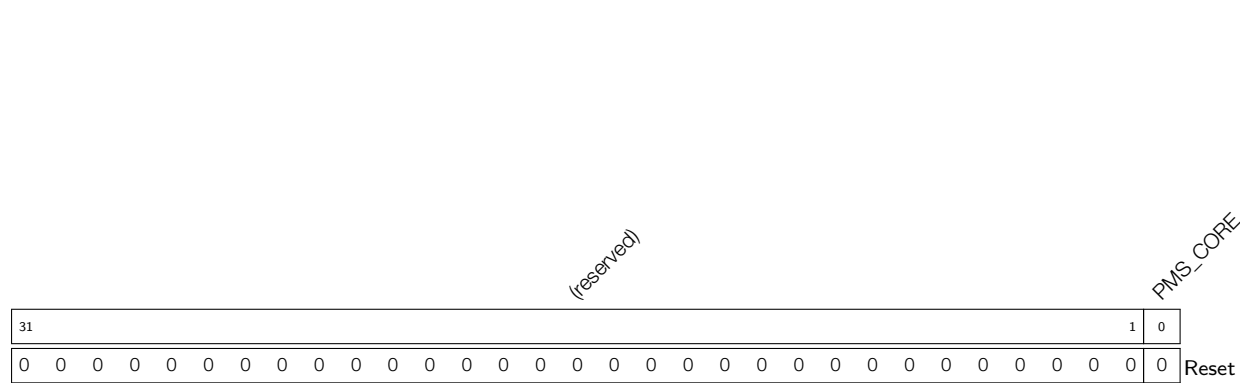

PMS_CORE_0_PIF_PMS_MONITOR_LOCK Set this bit to lock CPU0's PIF interrupt configuration. (R/W)

Register 15.62. PMS_CORE_0_PIF_PMS_MONITOR_1_REG (0x01A0)

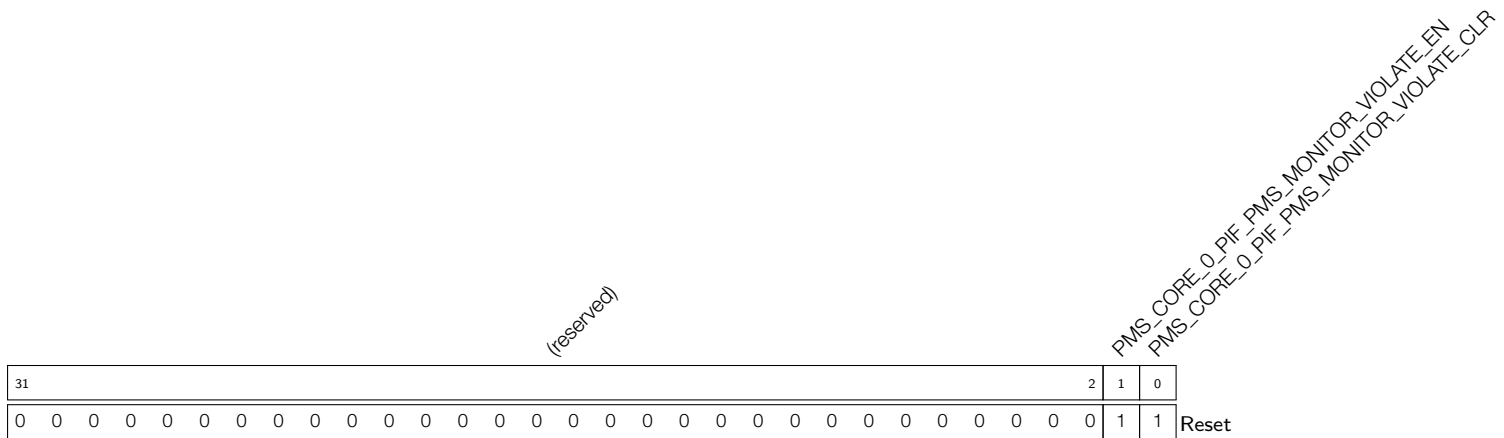

PMS_CORE_0_PIF_PMS_MONITOR_VIOLATE_CLR Set this bit to clear the interrupt triggered when CPU0's PIF bus tries to access RTC memory or peripherals unauthorized. (R/W)

PMS_CORE_0_PIF_PMS_MONITOR_VIOLATE_EN Set this bit to enable interrupt when CPU0's PIF bus tries to access RTC memory or peripherals unauthorized. (R/W)

Register 15.63. PMS_CORE_0_PIF_PMS_MONITOR_4_REG (0x01AC)

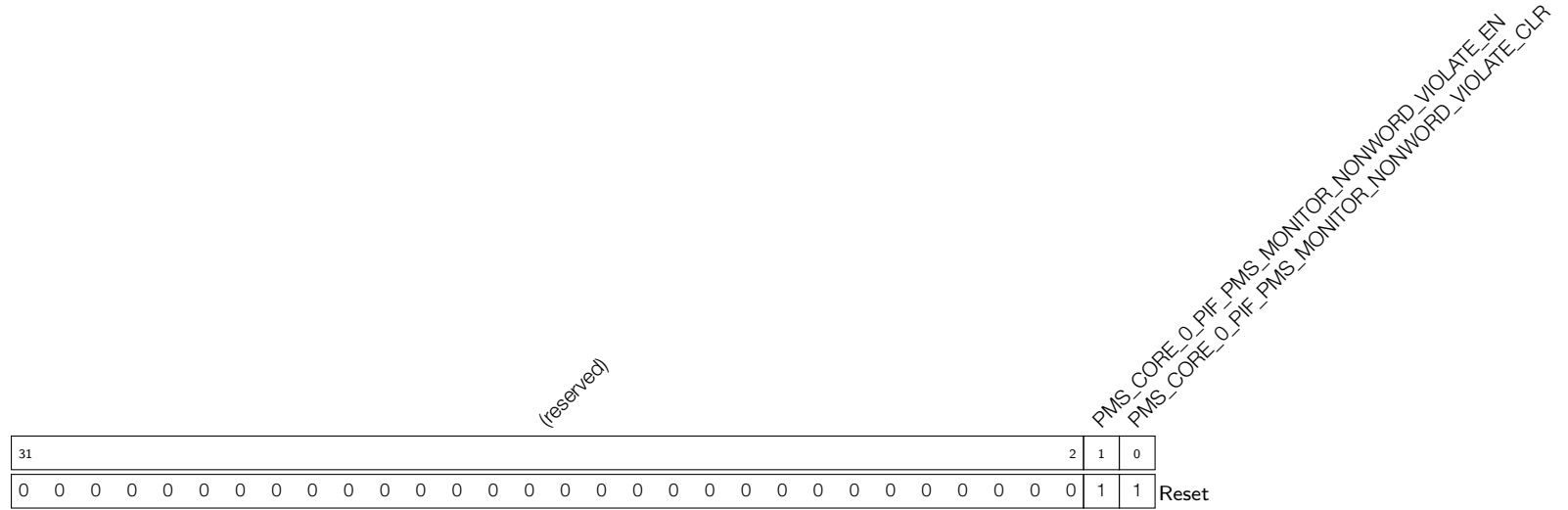

PMS_CORE_0_PIF_PMS_MONITOR_NONWORD_VIOLATE_CLR Set this bit to clear the interrupt triggered when CPU0's PIF bus tries to access RTC memory or peripherals using unsupported data type. (R/W)

PMS_CORE_0_PIF_PMS_MONITOR_NONWORD_VIOLATE_EN Set this bit to enable interrupt when CPU0's PIF bus tries to access RTC memory or peripherals using unsupported data type. (R/W)

Register 15.64. PMS_CORE_0_VECBASE_OVERRIDE_LOCK_REG (0x01B8)

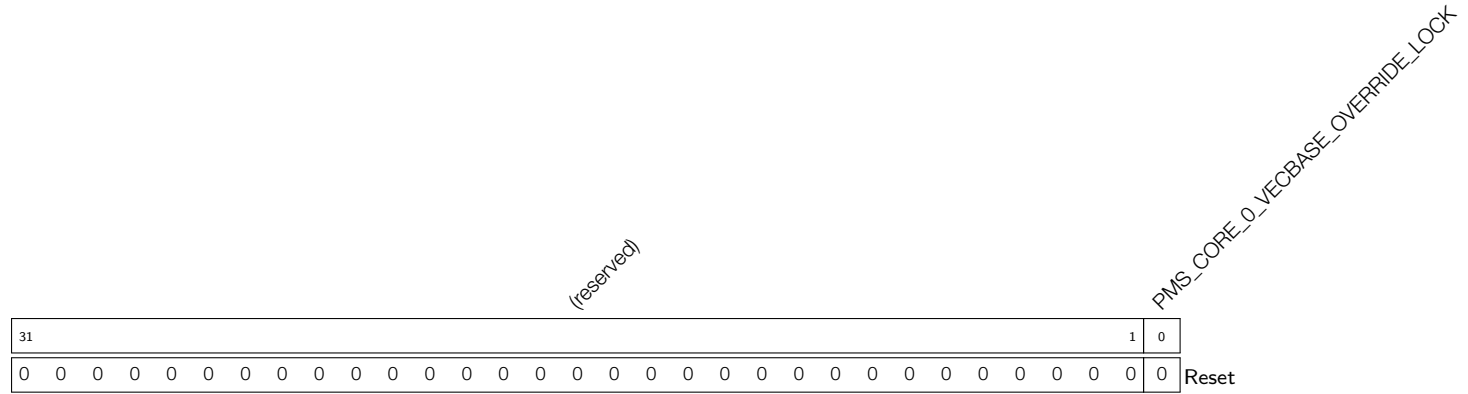

PMS_CORE_0_VECBASE_OVERRIDE_LOCK Set this bit to lock CPU0 VECBASE configuration register. (R/W)

Register 15.65. PMS_CORE_0_VECBASE_OVERRIDE_0_REG (0x01BC)

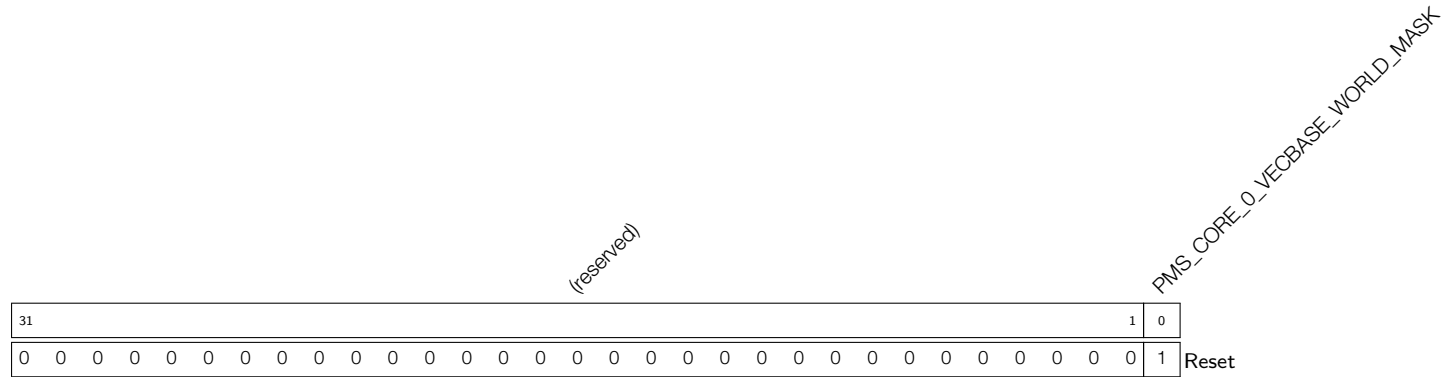

PMS_CORE_0_VECBASE_OVERRIDE_0_WORLD_MASK Set this bit so CPU uses WORLD0_VALUE in Secure World and Non-secure World. Clear this bit so CPU uses WORLD0_VALUE in Secure World and WORLD1_VALUE in Non-secure World. (R/W)

Register 15.66. PMS_CORE_0_VECBASE_OVERRIDE_1_REG (0x01C0)

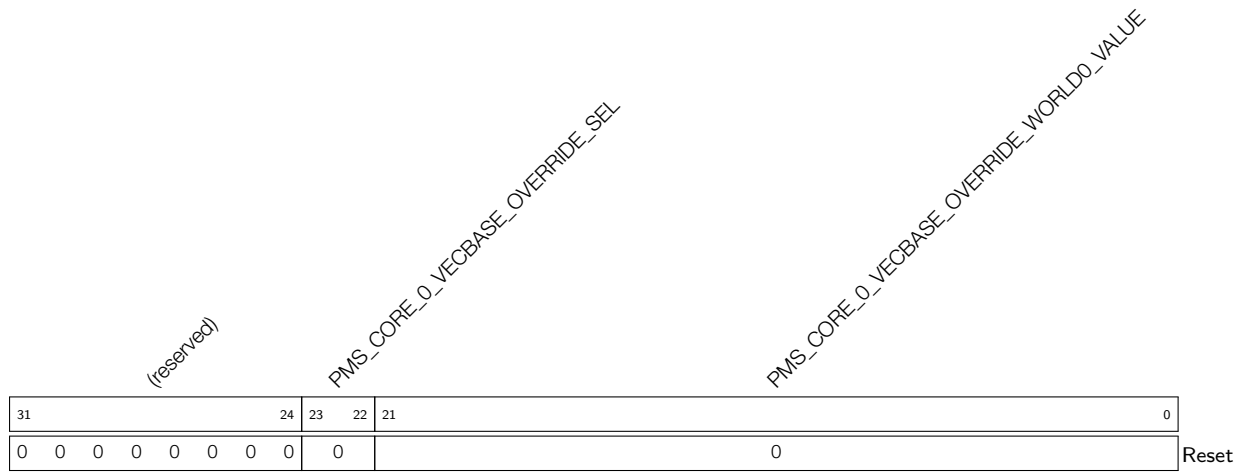

PMS_CORE_0_VECBASE_OVERRIDE_WORLD0_VALUE Configures the VECBASE value for the Secure World. (R/W)

PMS_CORE_0_VECBASE_OVERRIDE_SEL Configures VECBASE override. Set to 00 to select VECBASE; Set to 11 to select [PMS_CORE_0_VECBASE_OVERRIDE_WORLD \$n\$ _VALUE](#). (R/W)

Register 15.67. PMS_CORE_0_VECBASE_OVERRIDE_2_REG (0x01C4)

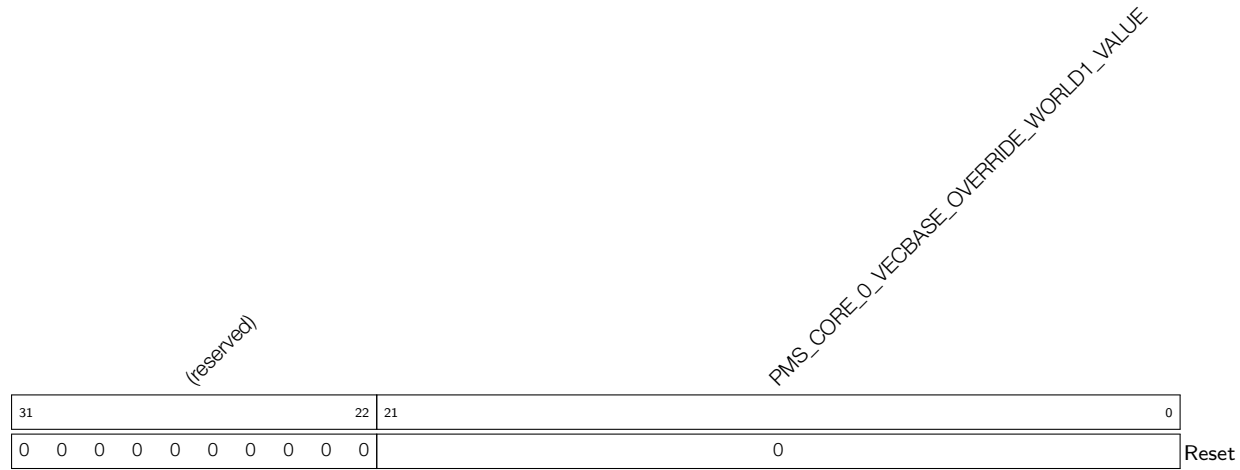

PMS_CORE_0_VECBASE_OVERRIDE_WORLD1_VALUE Configures the VECBASE value for the Non-secure World. (R/W)

Register 15.68. PMS_EDMA_BOUNDARY_LOCK_REG (0x02A8)

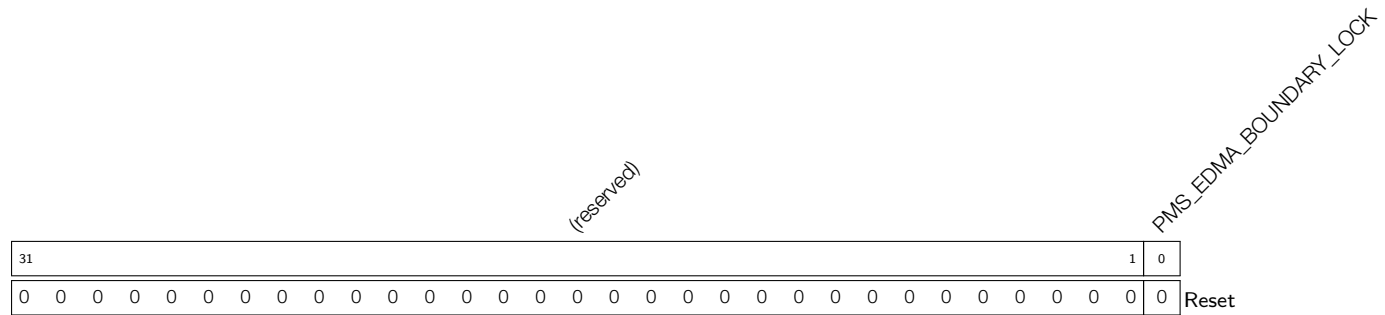

PMS_EDMA_BOUNDARY_LOCK Set this bit to lock EDMA boundary registers. (R/W)

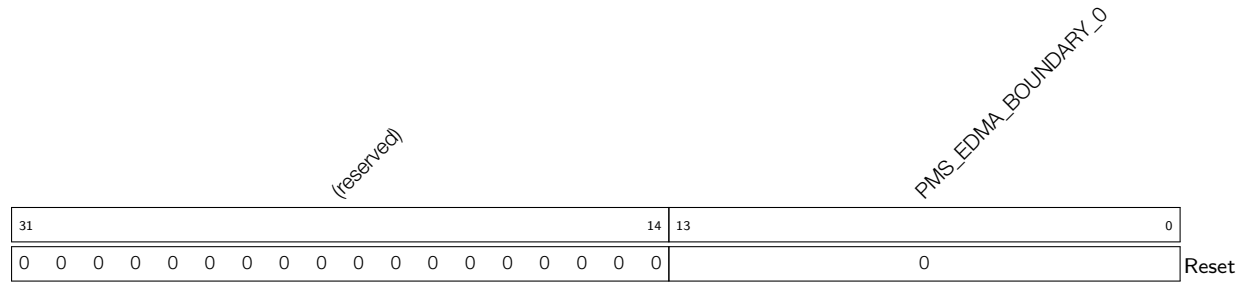
Register 15.69. PMS_EDMA_BOUNDARY_0_REG (0x02AC)

PMS_EDMA_BOUNDARY_0 Configures the ending address of external SRAM area0. For details, see Table 15-21. (R/W)

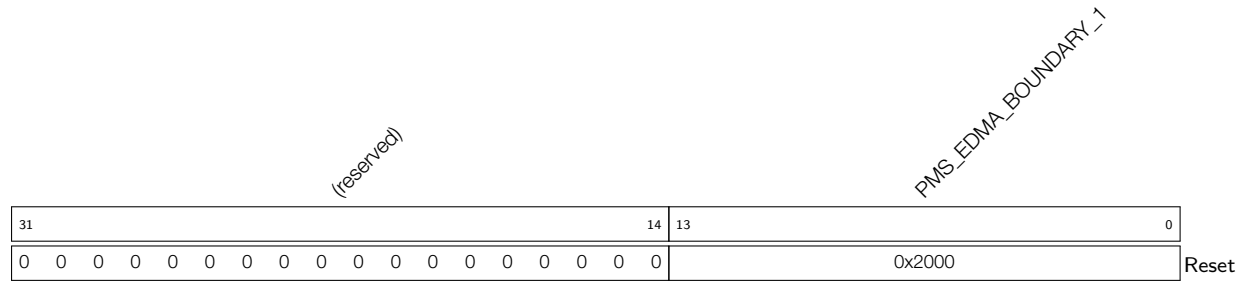
Register 15.70. PMS_EDMA_BOUNDARY_1_REG (0x02B0)

PMS_EDMA_BOUNDARY_1 Configures the ending address of external SRAM area1. For details, see Table 15-21. (R/W)

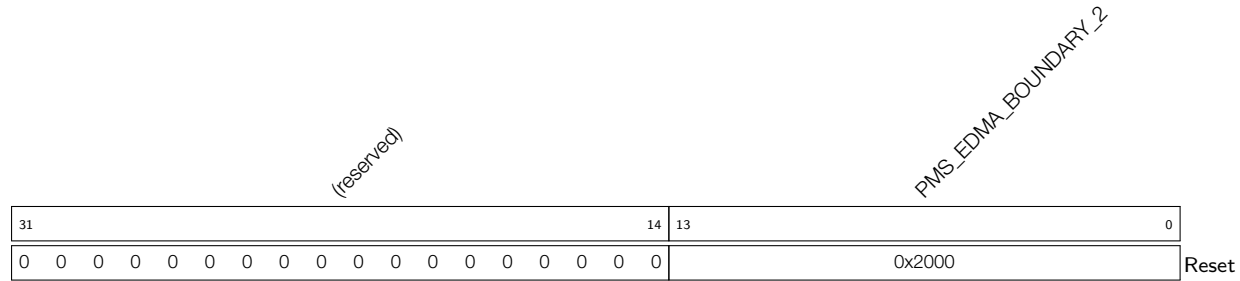
Register 15.71. PMS_EDMA_BOUNDARY_2_REG (0x02B4)

PMS_EDMA_BOUNDARY_2 Configures the ending address of external SRAM area2. For details, see Table 15-21. (R/W)

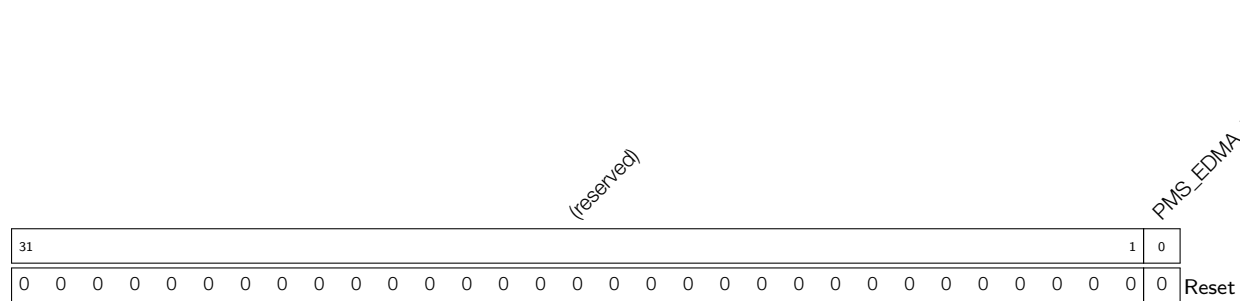
Register 15.72. PMS_EDMA_PMS_SPI2_LOCK_REG (0x02B8)

PMS_EDMA_PMS_SPI2_LOCK Set this bit to lock the register that configures SPI2's access to external SRAM. (R/W)

Register 15.73. PMS_EDMA_PMS_SPI2_REG (0x02BC)

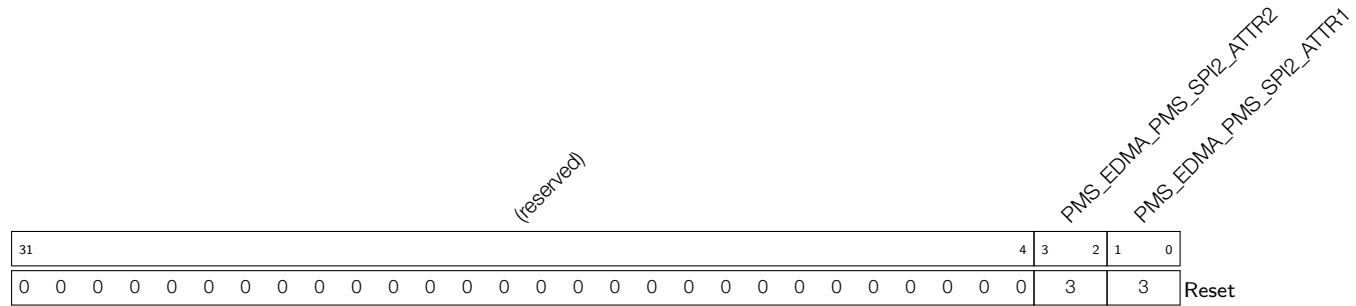

PMS_EDMA_PMS_SPI2_ATTR1 Configures SPI2's access to external SRAM Area0. For details, see Table 15-22. (R/W)

PMS_EDMA_PMS_SPI2_ATTR2 Configures SPI2's access to external SRAM Area1. For details, see Table 15-22. (R/W)

Register 15.74. PMS_EDMA_PMS_SPI3_LOCK_REG (0x02C0)

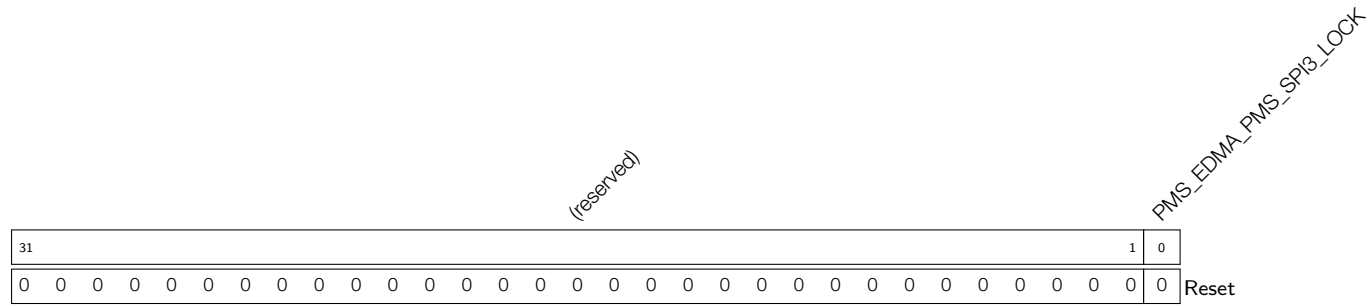

PMS_EDMA_PMS_SPI3_LOCK Set this bit to lock the register that configures SPI3's access to external SRAM. (R/W)

Register 15.75. PMS_EDMA_PMS_SPI3_REG (0x02C4)

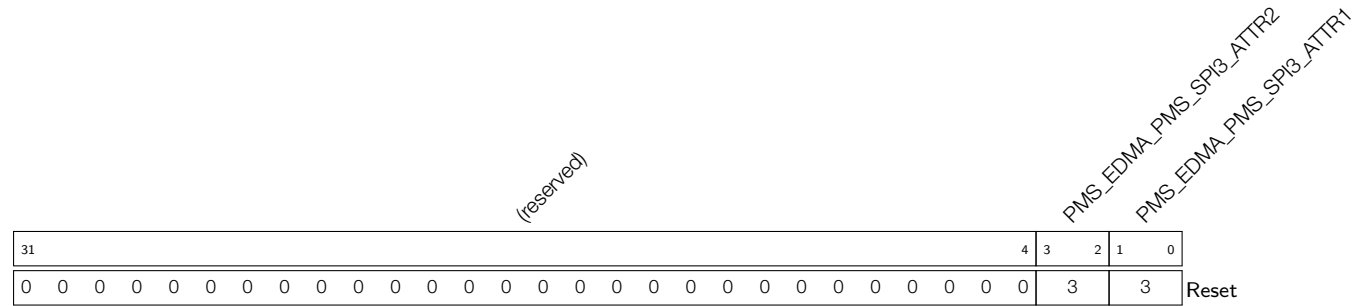

PMS_EDMA_PMS_SPI3_ATTR1 Configures SPI3's access to external SRAM Area0. For details, see Table 15-22. (R/W)

PMS_EDMA_PMS_SPI3_ATTR2 Configures SPI3's access to external SRAM Area1. For details, see Table 15-22. (R/W)

Register 15.76. PMS_EDMA_PMS_UHCI0_LOCK_REG (0x02C8)

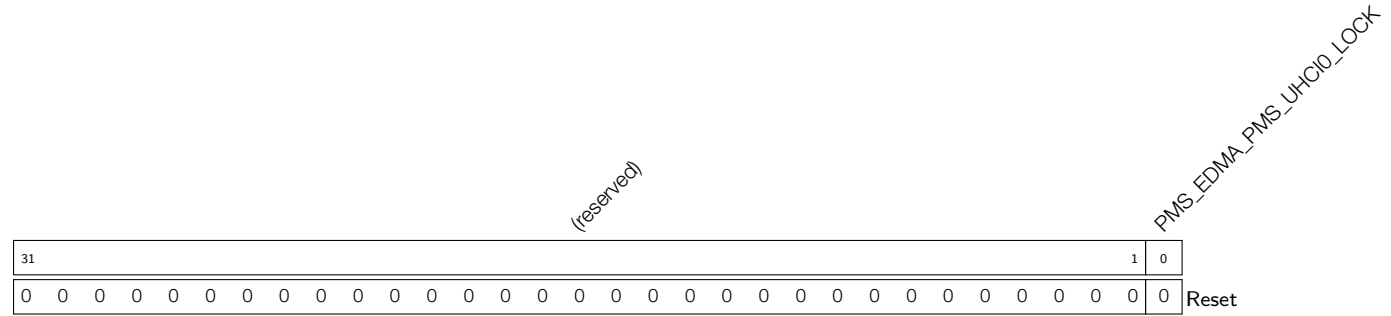

PMS_EDMA_PMS_UHCI0_LOCK Set this bit to lock the register that configures UHCI0's access to external SRAM. (R/W)

Register 15.77. PMS_EDMA_PMS_UHCI0_REG (0x02CC)

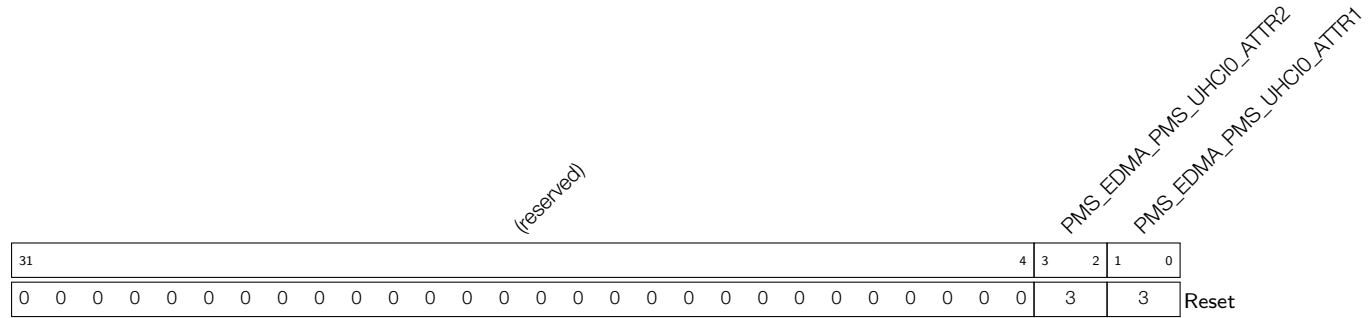

PMS_EDMA_PMS_UHCI0_ATTR1 Configures UHCI0's access to external SRAM Area0. For details, see Table 15-22. (R/W)

PMS_EDMA_PMS_UHCI0_ATTR2 Configures UHCI0's access to external SRAM Area1. For details, see Table 15-22. (R/W)

Register 15.78. PMS_EDMA_PMS_I2S0_LOCK_REG (0x02D0)

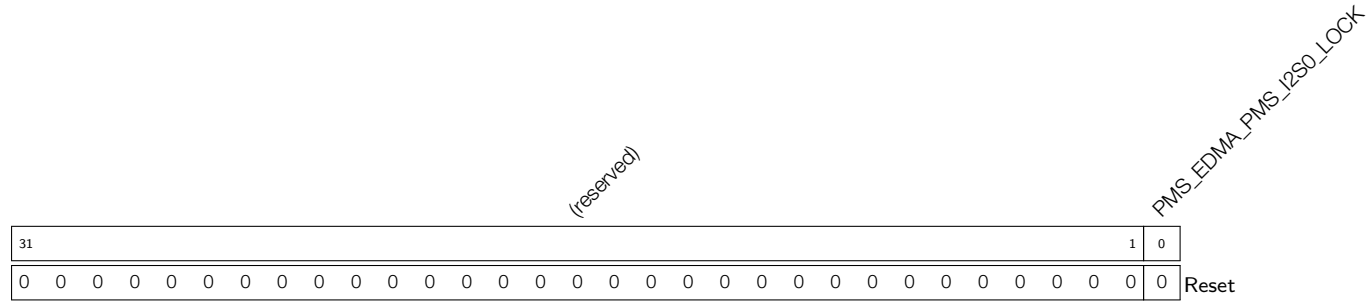

PMS_EDMA_PMS_I2S0_LOCK Set this bit to lock the register that configures I2S0's access to external SRAM. (R/W)

Register 15.79. PMS_EDMA_PMS_I2S0_REG (0x02D4)

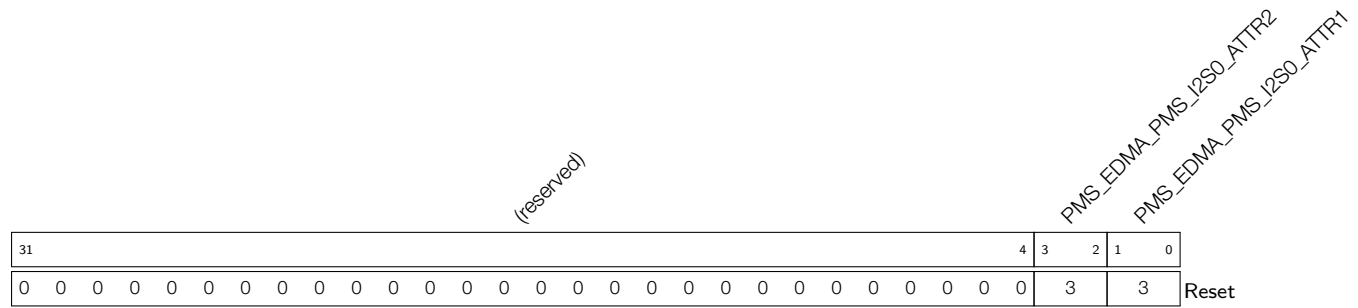

PMS_EDMA_PMS_I2S0_ATTR1 Configures I2S0's access to external SRAM Area0. For details, see Table 15-22. (R/W)

PMS_EDMA_PMS_I2S0_ATTR2 Configures I2S0's access to external SRAM Area1. For details, see Table 15-22. (R/W)

Register 15.80. PMS_EDMA_PMS_I2S1_LOCK_REG (0x02D8)

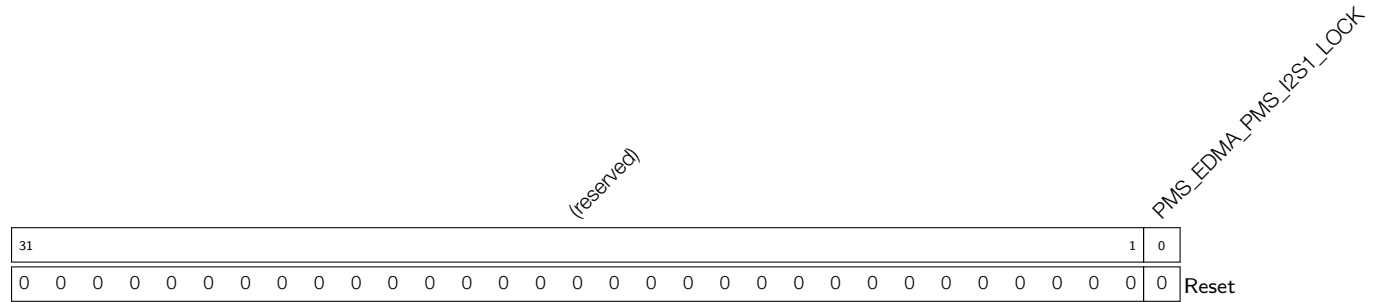

PMS_EDMA_PMS_I2S1_LOCK Set this bit to lock the register that configures I2S1's access to external SRAM. (R/W)

Register 15.81. PMS_EDMA_PMS_I2S1_REG (0x02DC)

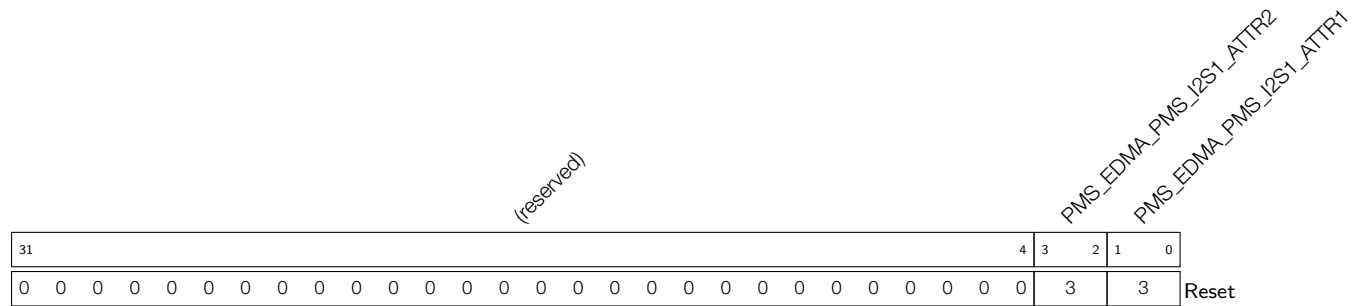

PMS_EDMA_PMS_I2S1_ATTR1 Configures I2S1's access to external SRAM Area0. For details, see Table 15-22. (R/W)

PMS_EDMA_PMS_I2S1_ATTR2 Configures I2S1's access to external SRAM Area0. For details, see Table 15-22. (R/W)

Register 15.82. PMS_EDMA_PMS_LCD_CAM_LOCK_REG (0x02E0)

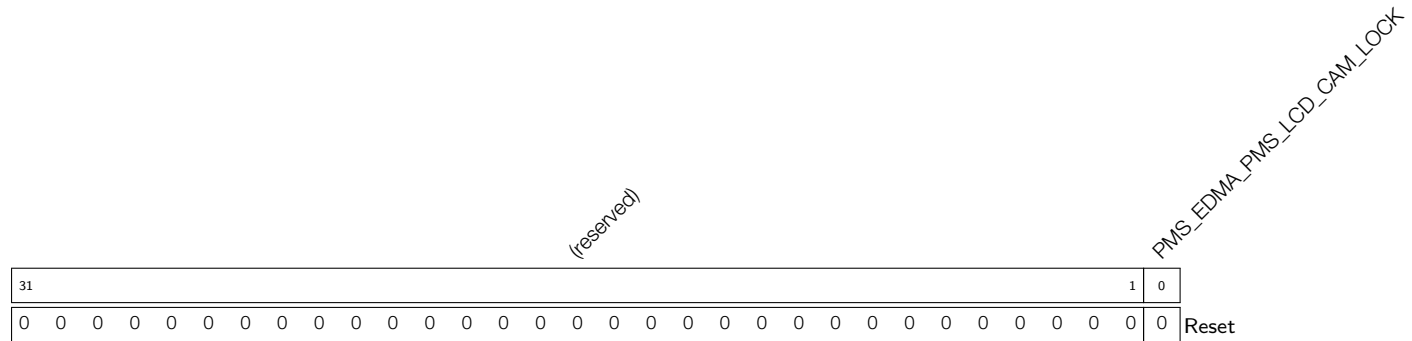

PMS_EDMA_PMS_LCD_CAM_LOCK Set this bit to lock the register that configures Camera-LCD Controller's access to external SRAM. (R/W)

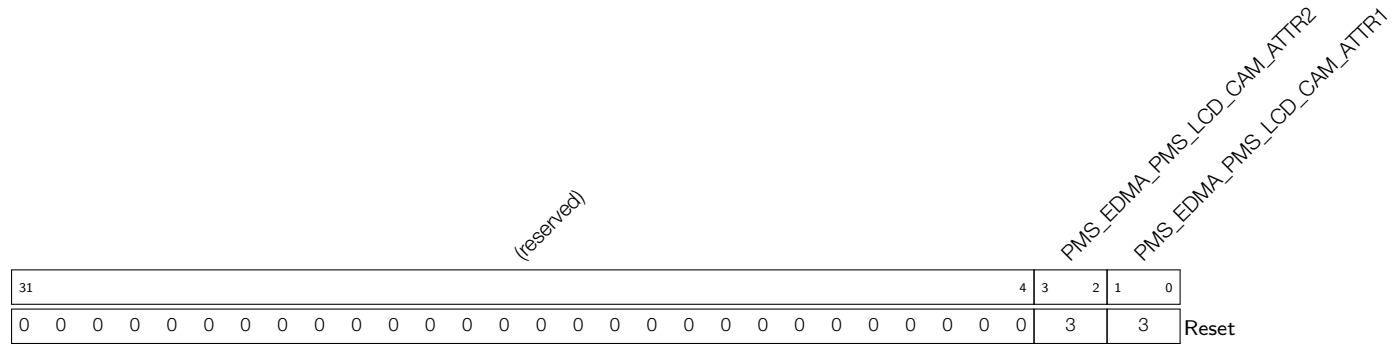
Register 15.83. PMS_EDMA_PMS_LCD_CAM_REG (0x02E4)

PMS_EDMA_PMS_LCD_CAM_ATTR1 Configures Camera-LCD Controller's access to external SRAM Area0. For details, see Table 15-22. (R/W)

PMS_EDMA_PMS_LCD_CAM_ATTR2 Configures Camera-LCD Controller's access to external SRAM Area1. For details, see Table 15-22. (R/W)

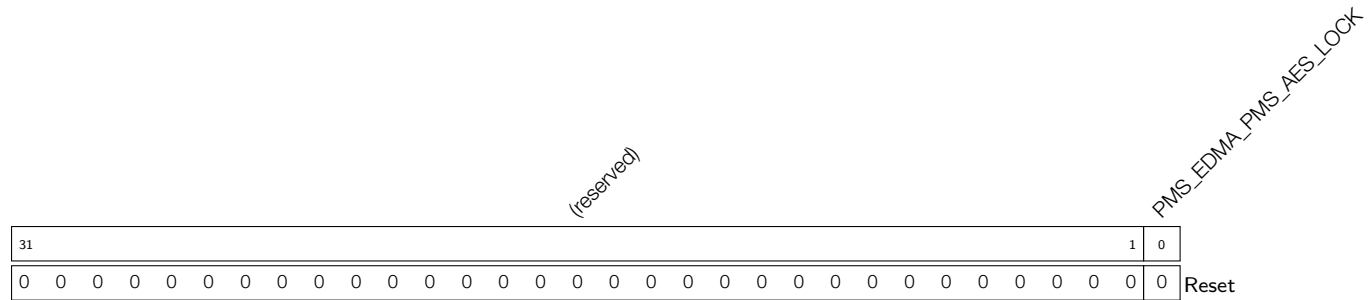
Register 15.84. PMS_EDMA_PMS_AES_LOCK_REG (0x02E8)

PMS_EDMA_PMS_AES_LOCK Set this bit to lock the register that configures AES's access to external SRAM. (R/W)

Register 15.85. PMS_EDMA_PMS_AES_REG (0x02EC)

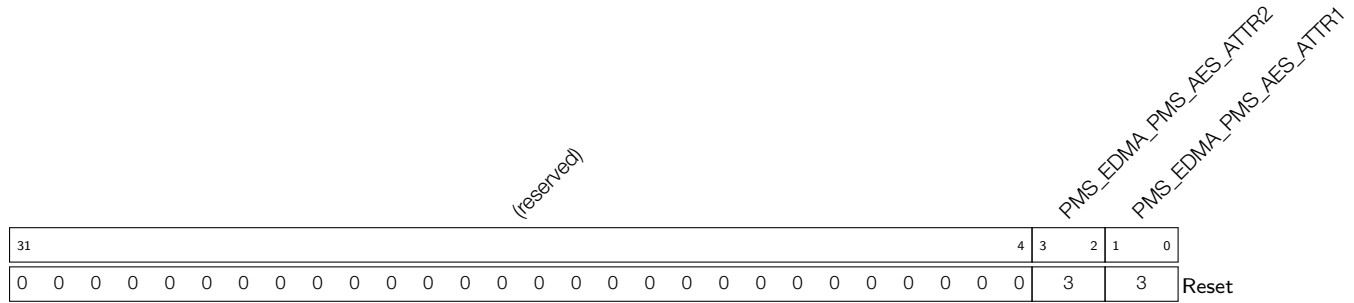

PMS_EDMA_PMS_AES_ATTR1 Configures AES's access to external SRAM Area0. For details, see Table 15-22. (R/W)

PMS_EDMA_PMS_AES_ATTR2 Configures AES's access to external SRAM Area1. For details, see Table 15-22. (R/W)

Register 15.86. PMS_EDMA_PMS_SHA_LOCK_REG (0x02F0)

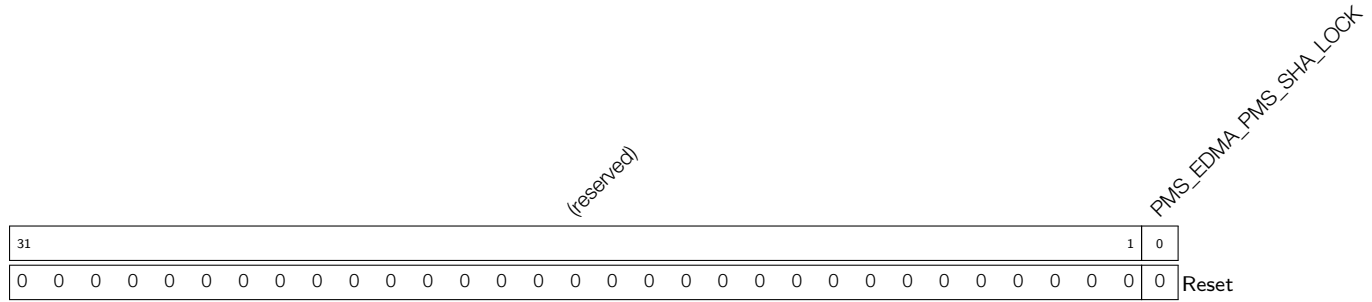

PMS_EDMA_PMS_SHA_LOCK Set this bit to lock the register that configures SHA's access to external SRAM. (R/W)

Register 15.87. PMS_EDMA_PMS_SHA_REG (0x02F4)

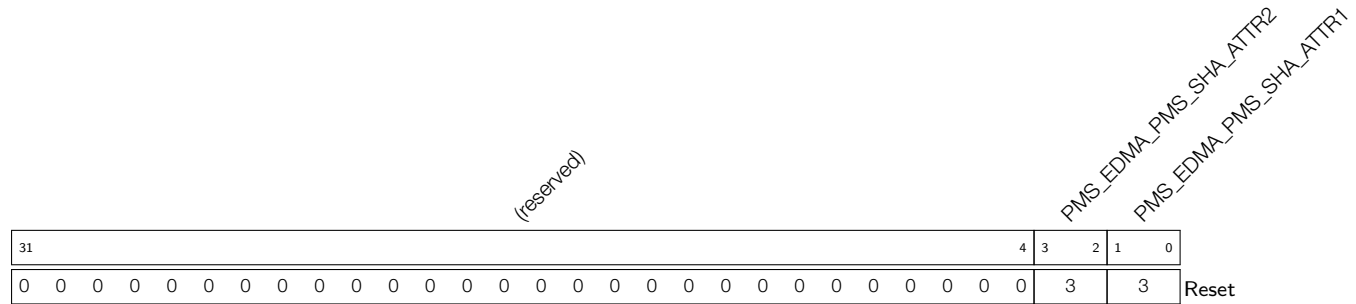

PMS_EDMA_PMS_SHA_ATTR1 Configures SHA's access to external SRAM Area0. For details, see Table 15-22. (R/W)

PMS_EDMA_PMS_SHA_ATTR2 Configures SHA's access to external SRAM Area1. For details, see Table 15-22. (R/W)

Register 15.88. PMS_EDMA_PMS_ADC_DAC_LOCK_REG (0x02F8)

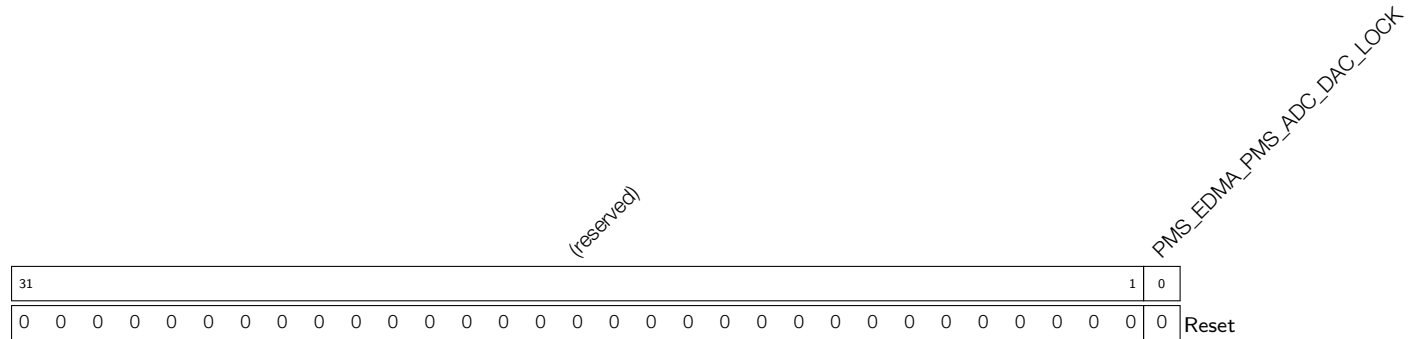

PMS_EDMA_PMS_ADC_DAC_LOCK Set this bit to lock the register that configures ADC Controller's access to external SRAM. (R/W)

Register 15.89. PMS_EDMA_PMS_ADC_DAC_REG (0x02FC)

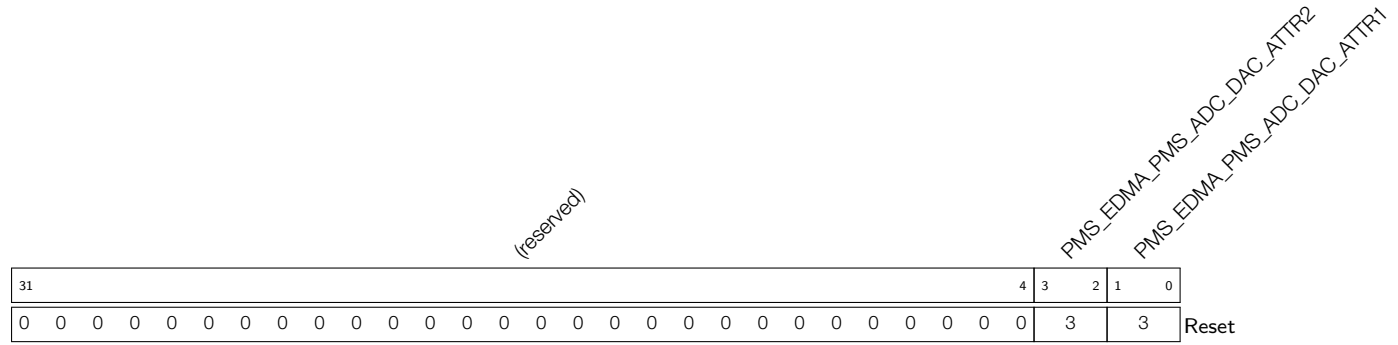

PMS_EDMA_PMS_ADC_DAC_ATTR1 Configures ADC Controller’s access to external SRAM Area0. For details, see Table 15-22. (R/W)

PMS_EDMA_PMS_ADC_DAC_ATTR2 Configures ADC Controller’s access to external SRAM Area1. For details, see Table 15-22. (R/W)

Register 15.90. PMS_EDMA_PMS_RMT_LOCK_REG (0x0300)

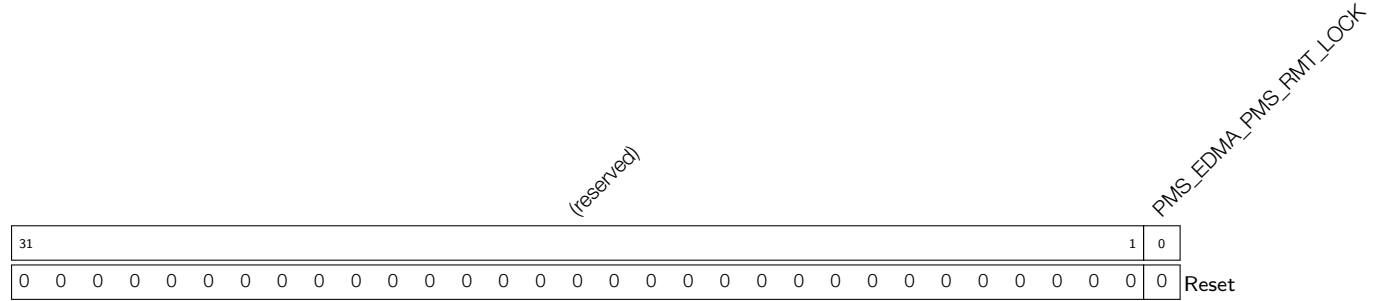

PMS_EDMA_PMS_RMT_LOCK Set this bit to lock the register that configures Remote Control Peripheral’s access to external SRAM. (R/W)

Register 15.91. PMS_EDMA_PMS_RMT_REG (0x0304)

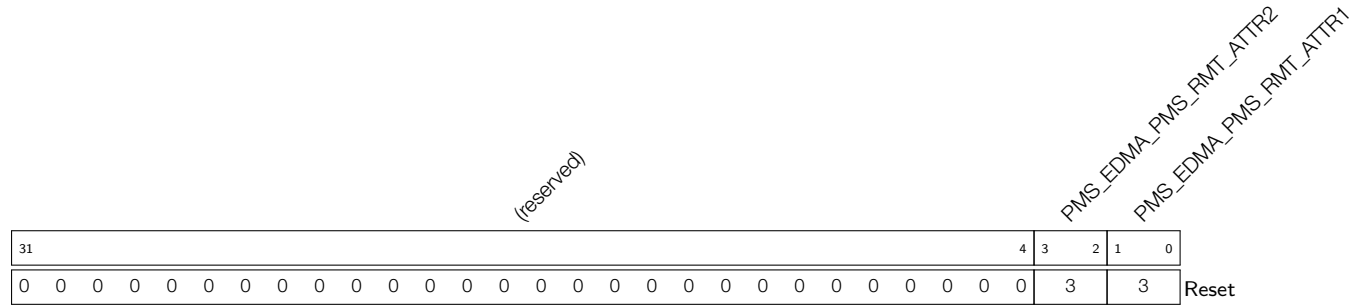

PMS_EDMA_PMS_RMT_ATTR1 Configures Remote Control Peripheral’s access to external SRAM Area0. For details, see Table 15-22. (R/W)

PMS_EDMA_PMS_RMT_ATTR2 Configures Remote Control Peripheral’s access to external SRAM Area1. For details, see Table 15-22. (R/W)

Register 15.92. PMS_CLOCK_GATE_REG_REG (0x0308)

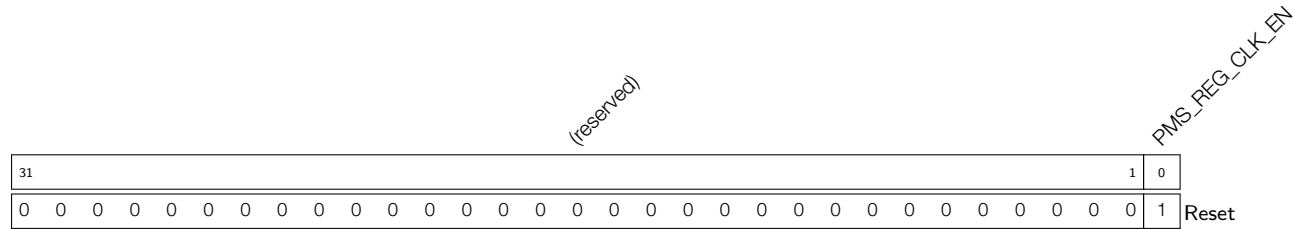

PMS_REG_CLK_EN Set this bit to enable the clock gating function. (R/W)

Register 15.93. PMS_CORE_0_IRAM0_PMS_MONITOR_2_REG (0x00EC)

(reserved)			<i>PMS_CORE_0_IRAM0_PMS_MONITOR_VIOLATE_STATUS_ADDR</i>					<i>PMS_CORE_0_IRAM0_PMS_MONITOR_VIOLATE_STATUS_WORLD</i> <i>PMS_CORE_0_IRAM0_PMS_MONITOR_VIOLATE_STATUS_LOADSTORE</i> <i>PMS_CORE_0_IRAM0_PMS_MONITOR_VIOLATE_STATUS_INTR</i>						
31	29	28						5	4	3	2	1	0	
0	0	0	0					0	0	0	0	0	0	Reset

PMS_CORE_0_IRAM0_PMS_MONITOR_VIOLATE_INTR Stores the interrupt status of CPU0's unauthorized IBUS access. (RO)

PMS_CORE_0_IRAM0_PMS_MONITOR_VIOLATE_STATUS_WR Indicates the access direction. 1: write; 0: read. Note that this field is only valid when [PMS_CORE_0_IRAM0_PMS_MONITOR_VIOLATE_STATUS_LOADSTORE](#) is 1. (RO)

PMS_CORE_0_IRAM0_PMS_MONITOR_VIOLATE_STATUS_LOADSTORE Indicates the instruction direction. 1: load/store; 0: instruction execution. (RO)

PMS_CORE_0_IRAM0_PMS_MONITOR_VIOLATE_STATUS_WORLD Stores the world the CPU0 was in when the illegal access happened. 0b01: Secure World; 0b10: Non-secure World. (RO)

PMS_CORE_0_IRAM0_PMS_MONITOR_VIOLATE_STATUS_ADDR Stores the address that CPU0's IBUS was trying to access unauthorized. Note that this is an offset to 0x40000000 and the unit is 4, which means the actual address should be $0x40000000 + \text{PMS_CORE_0_IRAM0_PMS_MONITOR_VIOLATE_STATUS_ADDR} * 4$. (RO)

Register 15.94. PMS_CORE_0_DRAM0_PMS_MONITOR_2_REG (0x010C)

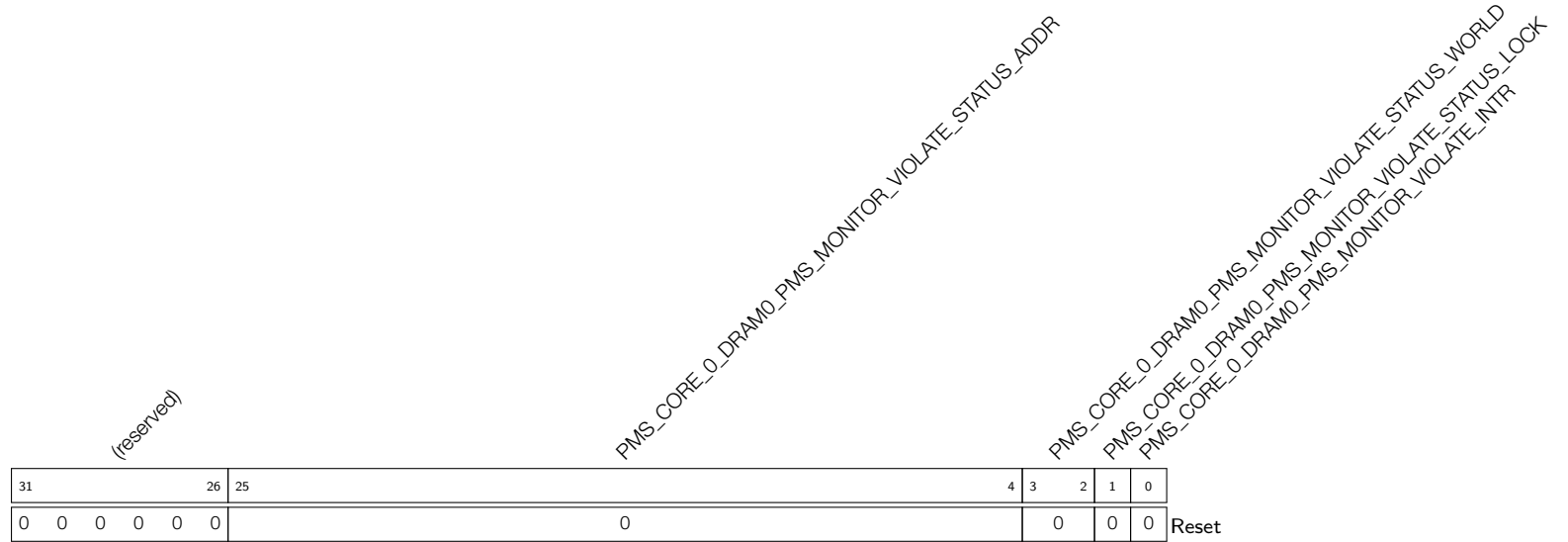

PMS_CORE_0_DRAM0_PMS_MONITOR_VIOLATE_INTR Stores the interrupt status of dBUS unauthorized access. (RO)

PMS_CORE_0_DRAM0_PMS_MONITOR_VIOLATE_STATUS_LOCK Flags atomic access. 1: atomic access; 0: not atomic access. (RO)

PMS_CORE_0_DRAM0_PMS_MONITOR_VIOLATE_STATUS_WORLD Stores the world the CPU was in when the unauthorized access happened. 0b01: Secure World; 0b10: Non-secure World. (RO)

PMS_CORE_0_DRAM0_PMS_MONITOR_VIOLATE_STATUS_ADDR Stores the address that CPU0's dBUS was trying to access unauthorized. Note that this is an offset to 0x3c000000 and the unit is 16, which means the actual address should be 0x3c000000 + [PMS_CORE_0_DRAM0_PMS_MONITOR_VIOLATE_STATUS_ADDR](#) * 16. (RO)

Register 15.95. PMS_CORE_0_DRAM0_PMS_MONITOR_3_REG (0x0110)

(reserved)

PMS_CORE_0_DRAM0_PMS_MONITOR_VIOLATE_STATUS_BYTEEN

PMS_CORE_0_DRAM0_PMS_MONITOR_VIOLATE_STATUS_WR

31		17	16		1	0
0	0	0	0	0	0	0
0						0
						Reset

PMS_CORE_0_DRAM0_PMS_MONITOR_VIOLATE_STATUS_WR Stores the direction of unauthorized access. 0: read; 1: write. (RO)

PMS_CORE_0_DRAM0_PMS_MONITOR_VIOLATE_STATUS_BYTEEN Stores the byte information of illegal access. (RO)

Register 15.97. PMS_CORE_0_PIF_PMS_MONITOR_3_REG (0x01A8)

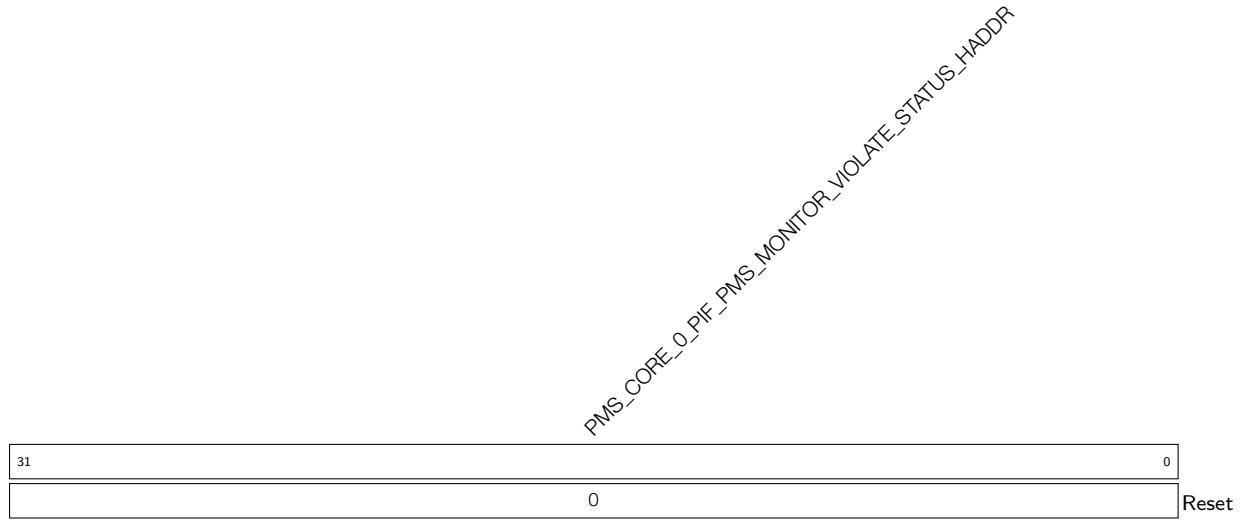

PMS_CORE_0_PIF_PMS_MONITOR_VIOLATE_STATUS_HADDR Stores the address that CPU0's PIF bus was trying to access unauthorized. (RO)

Register 15.98. PMS_CORE_0_PIF_PMS_MONITOR_5_REG (0x01B0)

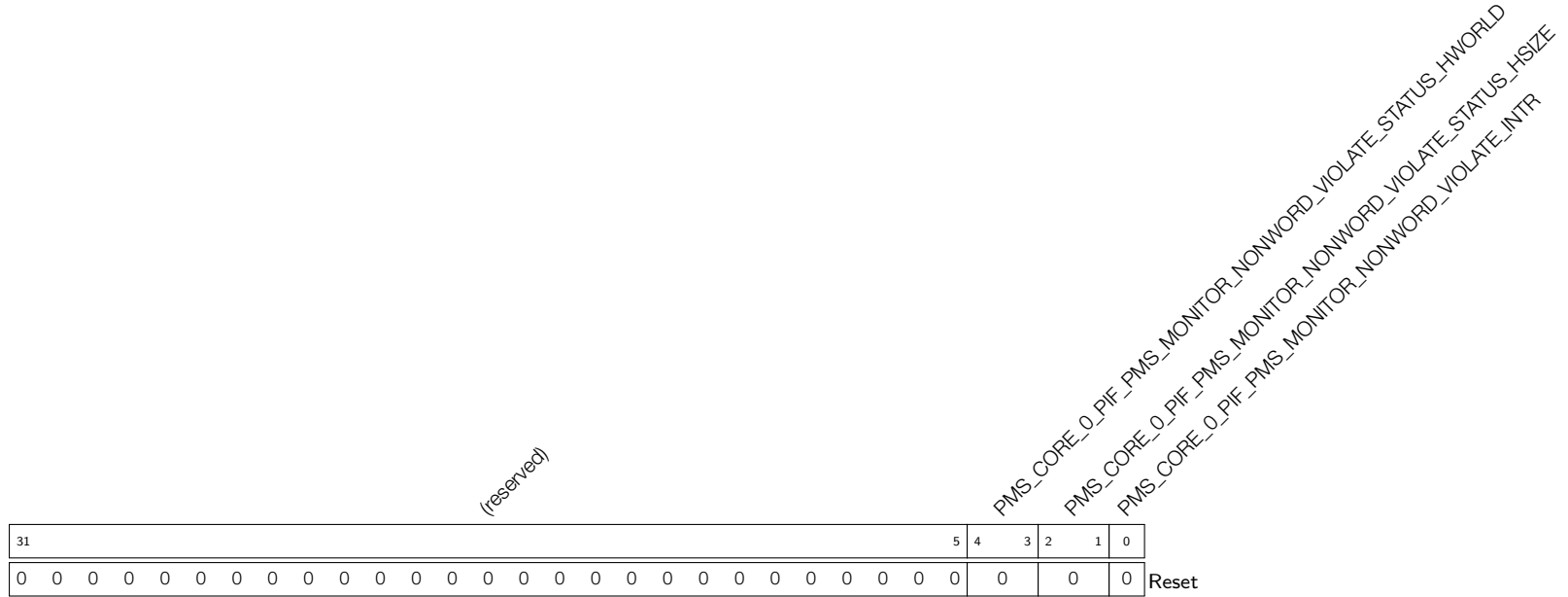

PMS_CORE_0_PIF_PMS_MONITOR_NONWORD_VIOLATE_INTR Stores the interrupt status of PIF unsupported data type. (RO)

PMS_CORE_0_PIF_PMS_MONITOR_NONWORD_VIOLATE_STATUS_HSIZE Stores the data type when the unauthorized access happened. (RO)

PMS_CORE_0_PIF_PMS_MONITOR_NONWORD_VIOLATE_STATUS_HWORLD Stores the world the CPU was in when the unauthorized access happened. 01: Secure World; 10: Non-secure World. (RO)

Register 15.99. PMS_CORE_0_PIF_PMS_MONITOR_6_REG (0x01B4)



PMS_CORE_0_PIF_PMS_MONITOR_NONWORD_VIOLATE_STATUS_HADDR Stores the address that CPU0's PIF bus was trying to access using unsupported data type. (RO)

Register 15.100. PMS_DATE_REG (0x0FFC)

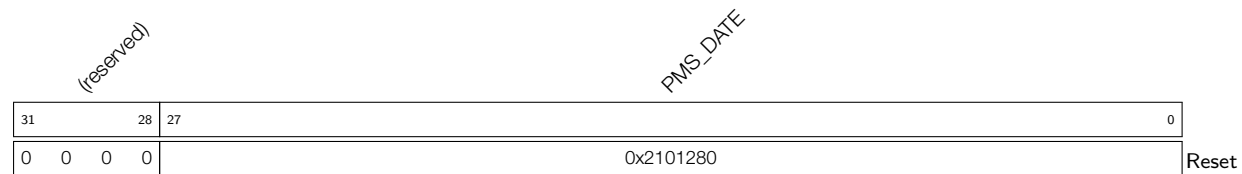

PMS_DATE Sensitive Date register. (R/W)

Register 15.101. APB_CTRL_EXT_MEM_PMS_LOCK_REG (0x0020)

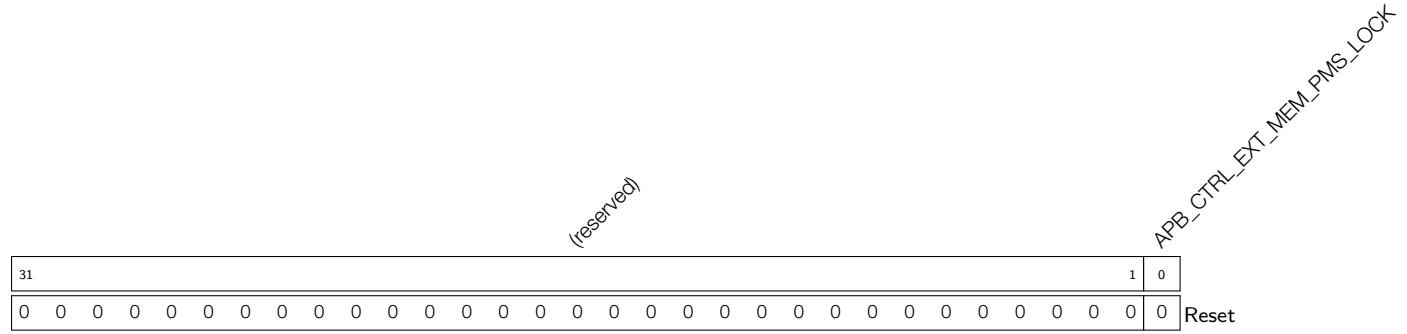

APB_CTRL_EXT_MEM_PMS_LOCK Set this bit to lock the permission configuration related to external memory. (R/W)

Register 15.102. APB_CTRL_FLASH_ACE_n_ATTR_REG (*n*: 0 - 3) (0x0028 + 4**n*)

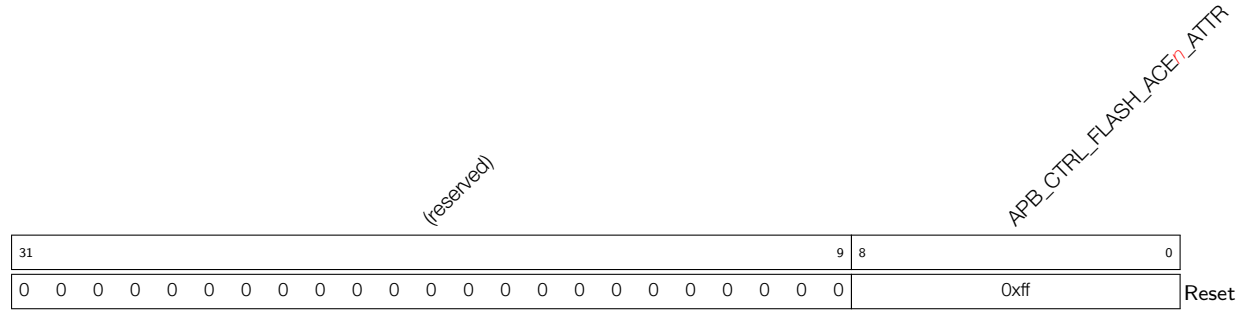

APB_CTRL_FLASH_ACE_n_ATTR Configures the permission to Region *n* of Flash. (R/W)

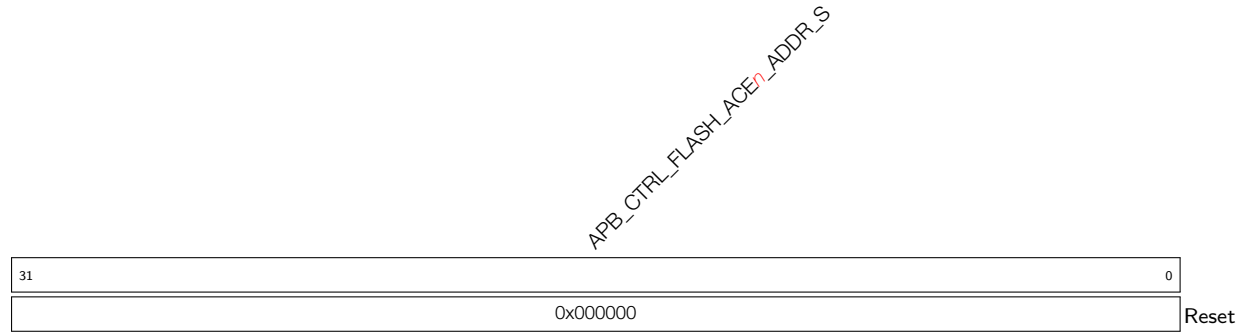
Register 15.103. APB_CTRL_FLASH_ACE n _ADDR_REG (n : 0-3) ($0x0038 + 4*n$)

APB_CTRL_FLASH_ACE0_ADDR_S Configure the starting address of Flash Region n . The size of each region should be aligned to 64 KB. (R/W)

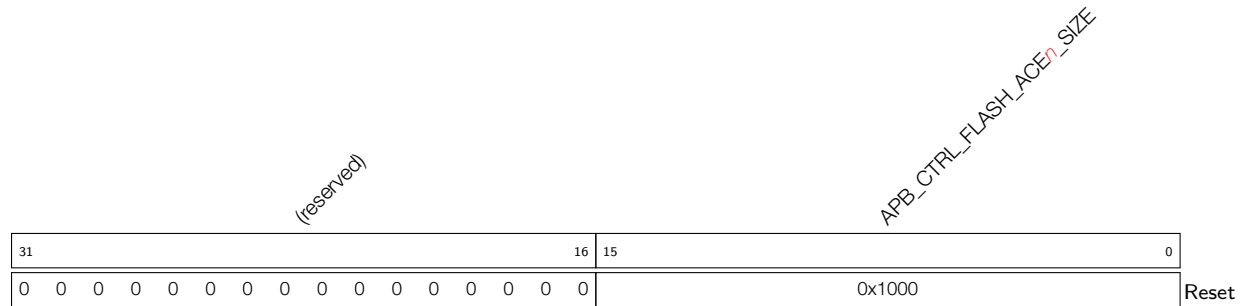
Register 15.104. APB_CTRL_FLASH_ACE n _SIZE_REG (n : 0-3) ($0x0048 + 4*n$)

APB_CTRL_FLASH_ACE n _SIZE Configure the length of Flash Region n . The size of each region should be aligned to 64 KB. (R/W)

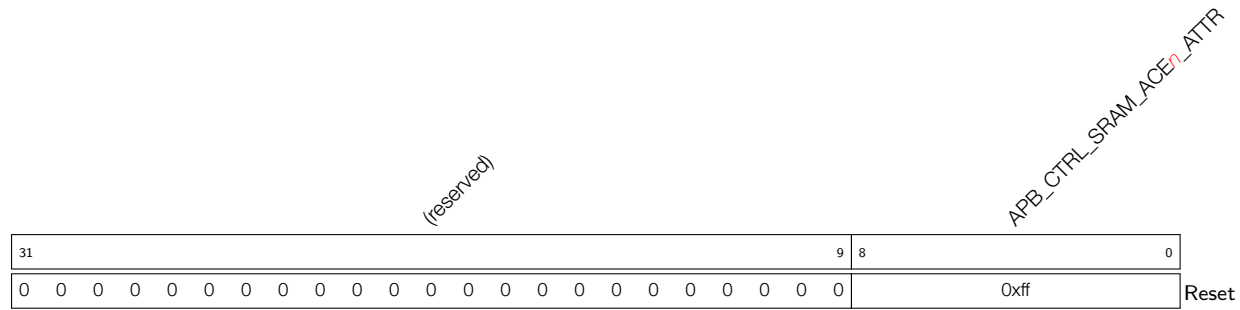
Register 15.105. APB_CTRL_SRAM_ACE n _ATTR_REG (0x0058)

APB_CTRL_SRAM_ACE n _ATTR Configures the permission to Region n of SRAM. (R/W)

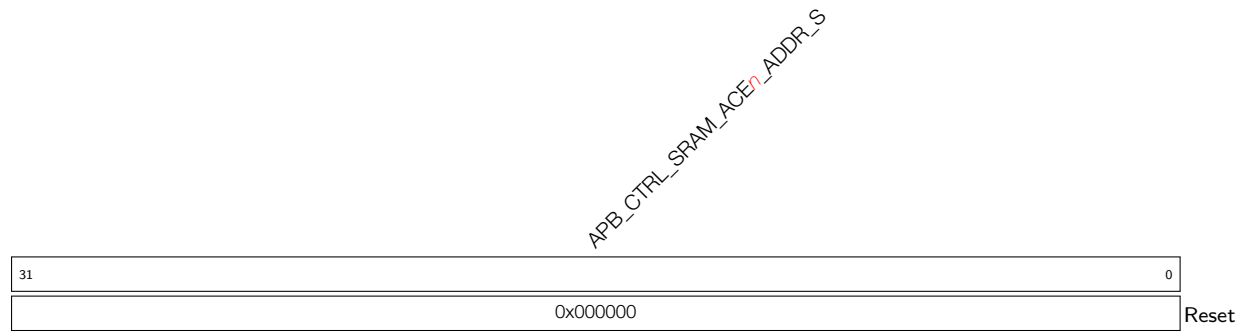
Register 15.106. APB_CTRL_SRAM_ACE n _ADDR_REG (n : 0-3) (0x0068 + 4* n)

APB_CTRL_SRAM_ACE n _ADDR_S Configure the starting address of SRAM Region n . The size of each region should be aligned to 64 KB. (R/W)

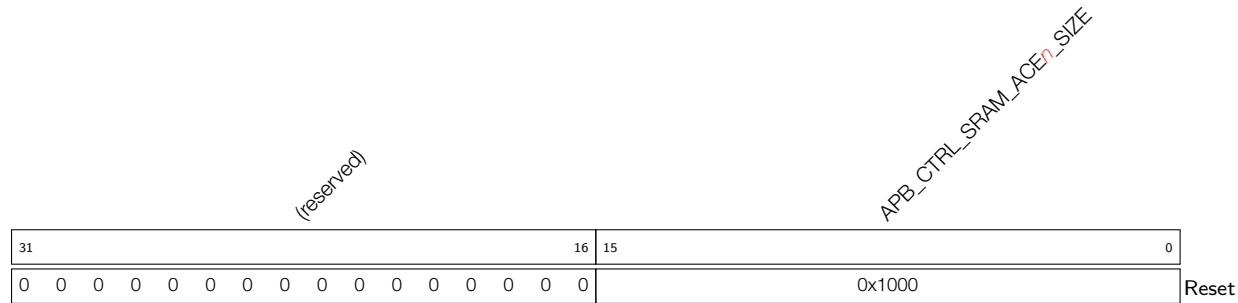
Register 15.107. APB_CTRL_SRAM_ACE n _SIZE_REG (n : 0-3) (0x0078 + 4* n)

APB_CTRL_SRAM_ACE n _SIZE Configure the length of SRAM Region n . The size of each region should be aligned to 64 KB. (R/W)

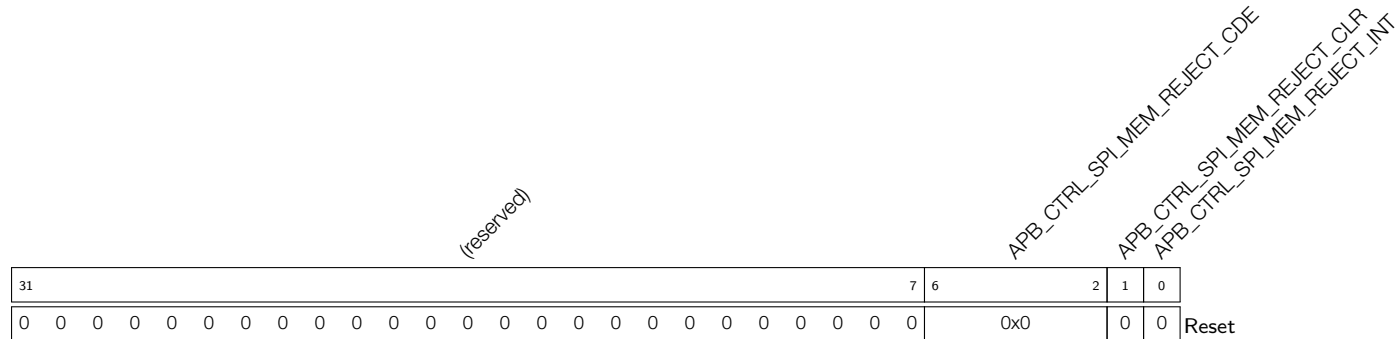
Register 15.108. APB_CTRL_SPI_MEM_PMS_CTRL_REG (0x0088)

APB_CTRL_SPI_MEM_REJECT_INT Indicates exception accessing external memory and triggers an interrupt. (RO)

APB_CTRL_SPI_MEM_REJECT_CLR Set this bit to clear the exception status. (WOD)

APB_CTRL_SPI_MEM_REJECT_CDE Stores the exception cause: invalid region, overlapping regions, illegal write, illegal read and illegal instruction execution. (RO)

Register 15.109. APB_CTRL_SPI_MEM_REJECT_ADDR_REG (0x008C)

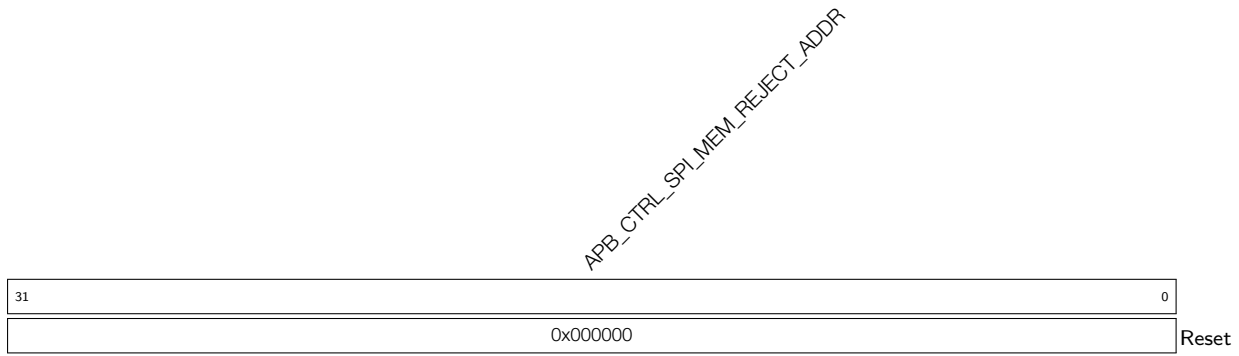

APB_CTRL_SPI_MEM_REJECT_ADDR Store the exception address.(RO)

16 World Controller (WCL)

16.1 Introduction

ESP32-S3 allows users to allocate its hardware and software resource into Secure World (World0) and Non-secure World (World1), thus protecting resource from unauthorized access (read or write), and from malicious attacks such as malware, hardware-based monitoring, hardware-level intervention, and so on. CPUs can switch between Secure World and Non-secure World with the help of the World Controller.

By default, all resource in ESP32-S3 are shareable. Users can allocate the resource into two worlds by managing respective permission (For details, please refer to Chapter [15 Permission Control \(PMS\)](#)). This chapter only introduces the World Controller and how CPUs can switch between worlds with the help of World Controller.

16.2 Features

ESP32-S3's World Controller:

- Controls the CPUs to switch between the Secure World and Non-secure World
- Logs CPU's world switches
- Allows NMI masking
- Allows independent world switches of CPUs (CORE_*m*: CPU0 and CPU1)

16.3 Functional Description

With the help of World Controller, we can allocate different resources to the Secure World and the Non-secure World:

- Secure World (World0):
 - Can access all peripherals and memories;
 - Performs all confidential operations, such as fingerprint identification, password processing, data encryption and decryption, security authentication, etc.
- Non-secure World (World1):
 - Can access some peripherals and memories;
 - Performs other operations, such as user operation and different applications, etc.

ESP32-S3's CPU and slave devices are both configurable with permission to either Secure World and/or Non-Secure World:

- CPU can be in either world at a particular time:
 - In Secure World: performs confidential operations;
 - In Non-secure World: performs non-confidential operations;
 - By default, CPU runs in Secure World after power-up, then can be programmed to switch between two worlds.

- All slave devices (including peripherals* and memories) can be configured to be accessible from the Secure World and/or the Non-secure World:
 - Secure World Access: this slave can be called from Secure World only, meaning it can be accessed only when CPU is in Secure World;
 - Non-secure World Access: this slave can be called from Non-secure World only, meaning it can be accessed only when CPU is in Non-secure World.
 - Note that a slave can be configured to be accessible from both Secure World and Non-secure World simultaneously.

For details, please refer to Chapter [15 Permission Control \(PMS\)](#).

Note:

* World Controller itself is a peripheral, meaning it also can be granted with Secure World access and/or Non-secure World access, just like all other peripherals. However, to secure the world switch mechanism, World Controller should not be accessible from Non-secure world. Therefore, world controller **should not be granted with** Non-secure World access, preventing any modification to world controller from the Non-secure World.

When CPU accesses any slaves:

1. First, CPU notifies the slave about its own world information;
2. Second, slave decides if it can be accessed by CPU based on the CPU's world information and its own world permission configuration.
 - if allowed, then this slave responds to CPU;
 - if not allowed, then this slave will not respond to CPU and trigger an interrupt.

In this way, the resources in the Secure World will not be illegally accessible by the Non-secure World in an unauthorized way.

16.4 CPU's World Switch

CPU can switch from Secure World to Non-secure World, and from Non-secure World to Secure World.

16.4.1 From Secure World to Non-secure World

```

void main ( void ){
    ...
    ...
    WORLD_PREPARE=1<<1
    WORLD_TRIGGER_ADDR } configuration
    WORLD_UPDATA
    ...
    ...
    ...
    asm("memw")
    Function A → Entry Non-secure World
}

```

Figure 16-1. Switching From Secure World to Non-secure World

ESP32-S3's CPU only needs to complete the following steps to switch from Secure World to Non-secure World:

1. Configure the World Controller, as described below.
2. Clear the data stored in `write_buffer`, as described in Section 16.4.3.

After that, CPU can switch to the Non-secure World.

However, it's worth noting that you cannot call the application in Non-secure world immediately after configuring the World Controller. For reasons such as CPU pre-indexed addressing and pipeline, it is possible that the CPU have already executed the application in Non-secure World before the World Controller configuration is effective, meaning the CPU runs unsecured application in the Secure World.

Therefore, you need to make sure the CPU only calls applications in the Non-secure world after the World Controller configuration takes effect. This can be guaranteed by **declaring the applications in the Non-secure World as "noinline"**.

Configuring the World Controller

The steps to configure the World Controller to switch the CPU from the Secure World to the Non-secure World are described below:

1. Write 0x2 to Register `WCL_CORE_m_WORLD_PERPARE_REG`, indicating the CPU needs to switch to the Non-secure World.
2. Configure Register `WCL_CORE_m_World_TRIGGER_ADDR_REG` as the entry address to the Non-secure World, i.e., the address of the application in the Non-secure World that needs to be executed.
3. Write any value to Register `WCL_CORE_m_World_UPDATE_REG`, indicating the configuration is done.

Note:

- Register `WCL_CORE_m_World_UPDATE_REG` must be configured at last.
- Registers `WCL_CORE_m_WORLD_PERPARE_REG` and `WCL_CORE_m_World_TRIGGER_ADDR_REG` can be configured in any order.
- After the configuration, you also need to use assembly instruction `memw` (memory wait) to clear `write_buffer`. For details, see Section 16.4.3.

Afterwards, the World Controller keeps monitoring if CPU is executing the configured address of the application in Non-secure World. CPU switches to the Non-secure World once it executes the configured address, and executes the applications in the Non-secure World.

After configuration, the World Controller:

- Keeps monitoring until the CPU executes the configured address and switches to the Non-secure World.
 - Write any value to Register `WCL_CORE_m_World_Cancel_REG` to cancel the World Controller configuration. After the cancellation, CPU will not switch to the Non-secure World even it executes to the configured address. Note that you also need to use assembly instruction `memw` (memory wait) to clear `write_buffer`. For details, see Section 16.4.3.
- The World Controller can only switch from the Secure World to Non-secure World once per configuration. Therefore, the World Controller needs to be configured again after each world switch to prepare it for the next world switch.

16.4.2 From Non-secure World to Secure World

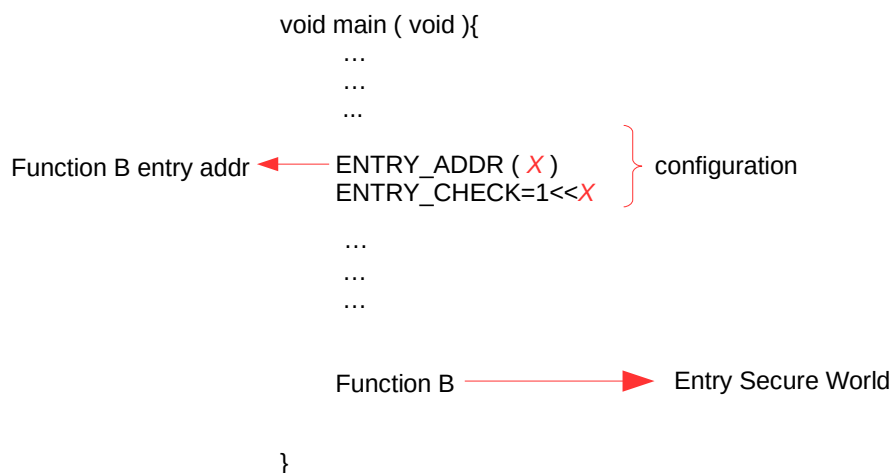

Figure 16-2. Switching From Non-secure World to Secure World

CPU can only switch from Non-secure World to Secure World via **Interrupts (or Exceptions)**. After configuring the World Controller, the CPU can switch back Non-secure World to Secure World upon the configured Interrupt trigger.

See details below:

1. Configure Registers [WCL_CORE_m_MESSAGE_ADDR_REG](#) and [WCL_CORE_m_MESSAGE_MAX_REG](#) to clear `write_buffer`, as described in Section 16.4.3.
2. Configure Registers [WCL_CORE_m_ENTRY_n_ADDR_REG](#) (n : 1-13) as the entry address of interrupts (or exceptions).
 - Note that all of ESP32-S3's interrupts and exceptions are using `VecBase + offset` as its address. Therefore, you need to configure [WCL_CORE_m_ENTRY_n_ADDR_REG](#) (n : 1-13) whenever you modify the `VecBase`.
3. Configure Register [WCL_CORE_m_ENTRY_CHECK_REG](#) to enable the monitor of a certain entry. In this way, the CPU switches to the Secure World immediately when it executes the address monitored at this particular entry.
 - Bit x controls the entry monitoring of Entry x ([WCL_CORE_m_ENTRY_x_ADDR_REG](#)). You can enable monitoring for more than one entry.
 - 0: Disable monitoring
 - 1: Enable monitoring
 - Register [WCL_CORE_m_ENTRY_CHECK_REG](#) is effective after configuration all the time till it's disabled, meaning you don't need to configure this register every time after each world switch.

16.4.3 Clearing the write_buffer

ESP32-S3 has implemented [write_buffer](#), which means the CPU buses can still hold some data from or execute instructions from the other world after world switches. To improve data security, we need to clear the `write_buffer` before world switching:

- **Switching from Secure World to Non-secure World**

- Use assembly instruction `memw` (memory wait).

- **Switching from Non-secure World to Secure World**

- Switch CPU data bus:

1. Pre-configure the following registers:

- * Configures Register [WCL_CORE_m_MESSAGE_ADDR_REG](#) to an address in the Non-secure World;
- * Configure Register [WCL_CORE_m_MESSAGE_MAX_REG](#) to Z ($Z \in \{3, 4, \dots, 16\}$)

2. Write sequences of 0, 1, ..., $Z-1$, Z to the address configured in Register [WCL_CORE_m_MESSAGE_ADDR_REG](#) before world switching. For example, if Z is configured to 3, then you need to write sequences of 0, 1, 2, 3 into the configured address; if Z is 5, then write 0, 1, 2, 3, 4, 5.
3. Afterwards, the CPU will switch its data bus to the other world once it detects the agreed sequences configured in [WCL_CORE_m_MESSAGE_MAX_REG](#) are being written to the agreed address configured in [WCL_CORE_m_MESSAGE_ADDR_REG](#).

16.5 World Switch Log

In actual use cases, CPU is switching between two worlds quite frequently and has to deal with nested interrupts. To be able to restore to the previous world, World Controller keeps a world switching log in a series of registers, which is called “World Switch Log Table”.

16.5.1 Structure of World Switch Log Register

ESP32-S3's World Switch Log Table consists of 13 `WCL_CORE_m_STATUSTABLEn_REG(n: 1-13)` registers (see Figure 16-3). The world switching of address configured in `WCL_CORE_m_ENTRY_x_ADDR_REG`, which is monitored at Entry x , is logged in `WCL_CORE_m_STATUSTABLEx_REG`.

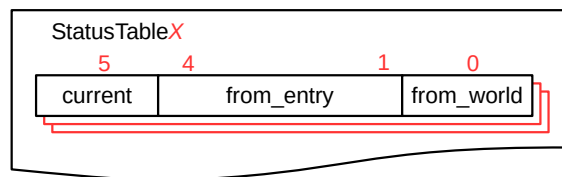

Figure 16-3. World Switch Log Register

- `WCL_CORE_m_FROM_WORLD_n`: logs the world information before the world switch.
 - 0: CPU was in Secure World
 - 1: CPU was in Non-secure World
- `WCL_CORE_m_FROM_ENTRY_n`: logs the entry information before the world switch.
 - 0: CPU was not at any interrupts monitored at any entry.
 - 1 - 13: CPU was at the interrupt monitored at a certain entry.
- `WCL_CORE_m_CURRENT_n`: indicates if CPU is at the interrupt monitored at the current entry. When CPU is at the interrupt monitored at Entry x ,
 - `WCL_CORE_m_CURRENT_x` is updated to 1,
 - and the same fields of all other entries are updated to 0.

16.5.2 How World Switch Log Registers are Updated

To explain this process, assuming:

1. At the beginning:
 - CPU is running in the Non-secure World;
 - Registers `WCL_CORE_m_STATUSTABLEn_REG(n: 1-13)` are all empty.
2. Then an interrupt occurs at Entry 9;
3. Then another interrupt with higher priority occurs at Entry 1;
4. Then the last interrupt with highest priority occurs at Entry 4.

The World Switch Log Table is updated as described below:

1. First, an interrupt occurs at Entry 9. At this time, CPU executes to the entry address of this interrupt. The World Switch Log Table is updated as described in Figure 16-4:

entry	current	from_entry	from_world
1	0	0	0
2	0	0	0
3	0	0	0
4	0	0	0
5	0	0	0
6	0	0	0
7	0	0	0
8	0	0	0
9	1	0	1
10	0	0	0
11	0	0	0
12	0	0	0
13	0	0	0

Figure 16-4. Nested Interrupts Handling - Entry 9

- `WCL_CORE_m_STATUSTABLE9_REG`
 - Field `WCL_CORE_m_FROM_WORLD_9` is updated to 1, indicating CPU was in Non-secure World before the interrupt.
 - Field `WCL_CORE_m_FROM_ENTRY_9` is updated to 0, indicating there was not any interrupt before this one.
 - Field `WCL_CORE_m_CURRENT_9` is updated to 1, indicating the CPU is currently at the interrupt monitored at Entry 9.
- Other `WCL_CORE_m_STATUSTABLEn_REG` registers are not updated.

2. Then another interrupt with higher priority occurs at Entry 1. At this time, CPU executes to the entry address of this interrupt. The World Switch Log Table is updated again as described in Figure 16-5:

entry	current	from_entry	from_world
1	1	9	0
2	0	0	0
3	0	0	0
4	0	0	0
5	0	0	0
6	0	0	0
7	0	0	0
8	0	0	0
9	0	0	1
10	0	0	0
11	0	0	0
12	0	0	0
13	0	0	0

Figure 16-5. Nested Interrupts Handling - Entry 1

- `WCL_CORE_m_STATUSTABLE1_REG`
 - Field `WCL_CORE_m_FROM_WORLD_1` is updated to 0, indicating the CPU was in Secure World before this interrupt.
 - Field `WCL_CORE_m_FROM_ENTRY_1` is updated to 9, indicating the CPU was executing the interrupt at Entry 9.
 - Field `WCL_CORE_m_CURRENT_1` is updated to 1, indicating CPU is currently at the interrupt monitored at Entry 1.

- `WCL_CORE_m_STATUSTABLE9_REG`
 - Field `WCL_CORE_m_CURRENT_9` is updated to 0, indicating CPU is no longer at the interrupt monitored at Entry 9 (Instead, CPU is at the interrupt monitored at Entry 1 already).
 - Fields `WCL_CORE_m_FROM_WORLD_9` and `WCL_CORE_m_FROM_ENTRY_9` stay the same.
 - Other `WCL_CORE_m_STATUSTABLEn_REG` registers are not updated.
3. Then the last interrupt with highest priority occurs at Entry 4. At this time, CPU executes to the entry address of interrupt 4. The World Switch Log Table is updated again as described in Figure 16-6:

	current	from_entry	from_world
1	0	9	0
2	0	0	0
3	0	0	0
4	1	1	0
5	0	0	0
6	0	0	0
7	0	0	0
8	0	0	0
9	0	0	1
10	0	0	0
11	0	0	0
12	0	0	0
13	0	0	0

Figure 16-6. Nested Interrupts Handling - Entry 4

- `WCL_CORE_m_STATUSTABLE4_REG`
 - Field `WCL_CORE_m_FROM_WORLD_4` is updated to 0, indicating the CPU was in Secure World before this interrupt.
 - Field `WCL_CORE_m_FROM_ENTRY_4` is updated to 1, indicating the CPU was the interrupt at Entry 1.
 - Field `WCL_CORE_m_CURRENT_4` is updated to 1, indicating the CPU is currently at the interrupt monitored an Entry 4.
- `WCL_CORE_m_STATUSTABLE1_REG`
 - Field `WCL_CORE_m_CURRENT_1` is updated to 0, indicating the CPU is no longer at the interrupt monitored at Entry 1 (Instead CPU is at the interrupt monitored at Entry 4 already).
 - Fields `WCL_CORE_m_FROM_WORLD_1` and `WCL_CORE_m_FROM_ENTRY_1` are not updated.
- Other `WCL_CORE_m_STATUSTABLEn_REG` registers are not updated.

16.5.3 How to Read World Switch Log Registers

By reading World Switch Log Registers, we get to understand the information of previous world switches and nested interrupts, thus being able to restore to previous world.

Steps are described below: (See Figure 16-6 as an example):

1. Read Register `WCL_CORE_m_STATUSTABLE_CURRENT_REG`, and understand CPU is now at the interrupt monitored at Entry 4.
2. Read 1 from Field `WCL_CORE_m_FROM_ENTRY_4`, and understand the CPU was at an interrupt monitored at Entry 1.

3. Read 9 from Field `WCL_CORE_m_FROM_ENTRY_1`, and understand the CPU was at an interrupt monitored at Entry 9.
4. Read 0 from `WCL_CORE_m_FROM_ENTRY_9`, and understand CPU wasn't at any interrupt. Then read 1 from `WCL_CORE_m_FROM_WORLD_9`, and understand CPU was in Non-secure World at the beginning.

16.5.4 Nested Interrupts

ESP32-S3 supports nested interrupts, for example:

1. An interrupt A occurs. CPU jumps to interrupt A entry, which triggers world switches.
2. When CPU is handling interrupt A, an interrupt B with higher priority occurs.
3. Then the CPU drops the current interrupt A and switches to the higher priority interrupt B first.
4. After returning from interrupt B, CPU resumes executing the instruction at interrupt A entry, which triggers world switches again.

In this way, CPU executes the entry address of the first interrupt twice (one time when the interrupt occurs and another time when CPU returns to this interrupt), and thus triggering the world switches twice, which inevitably leads to multiple records tracked for the same interrupt in [World Switch Log](#) and prevents the CPU from restoring to the previous world correctly.

16.5.4.1 How to Handle Nested Interrupts

To avoid multiple records being logged incorrectly in the [World Switch Log](#), the following actions must be completed:

- During the design stage, add two assembly instruction NOP.N (No Operation) to the vector entrance of all interrupts and exceptions.
- During the execution, update the address where the interrupts return to following the instructions described in [16.5.4.2](#).

In this way, when returning to the interrupt at Entry *B*, the interrupt monitored at Entry *A* will not return to the entry address of Entry *B*, but the address after the NOP instructions, thus preventing to trigger the world controller unexpectedly. Also, the NOP instruction doesn't do anything, so nothing is changed even when the NOP instructions are skipped.

16.5.4.2 Programming Procedure

Handling the interrupt at Entry *A*:

1. Clear the write_buffer by writing the agreed sequences configured in Register `WCL_CORE_m_MESSAGE_MAX_REG` to the address configured in `WCL_CORE_m_MESSAGE_ADDR_REG`. For details, see Section [16.4.3](#).
2. Execute the interrupt programs.
3. Disable all interrupts.
4. Update the address where the interrupt at Entry *A* returns to:
 - Read Field `WCL_CORE_m_FROM_ENTRY_A` for Entry *A*:

- 0: indicates all interrupts are handled, and returns to a normal program:
 - (a) Update Field `WCL_CORE_m_CURRENT_A` of Entry *A* to 0, indicating the CPU is no longer at the interrupt monitored at Entry *A*.
 - (b) Go to Step 5.
 - 1 - 13: indicates the CPU returns to another interrupt monitored at Entry *B*,
 - (a) First, check the return address of the interrupt at Entry *A*:
 - * If it points to the first NOP.N instruction of the interrupt at Entry *B*, then add 4 to the return address of the interrupt at Entry *A*.
 - * If it points to the second NOP.N instruction of the interrupt at Entry *B*, then add 2 to the return address of the interrupt at Entry *A*.
 - * If it points to other address, then no need to update the return address.
 - (b) Update the [How to Read World Switch Log Registers](#):
 - * Update the world switch register of Entry *A*:
 - Update Field `WCL_CORE_m_CURRENT_A` to 0, indicating the CPU is no longer at the interrupt monitored at Entry *A*.
 - Fields `WCL_CORE_m_FROM_WORLD_A` and `WCL_CORE_m_FROM_ENTRY_A` stay the same.
 - * Update the world switch register of Entry *B*:
 - Update Field `WCL_CORE_m_CURRENT_B` to 1, indicating the CPU will return to Entry *B*.
5. Prepare to exit interrupt.
- (a) Check if CPU needs to switch to the other world:
 - If world switch not required, then go to Step 6.
 - If world switch required, then switch the CPU to the other world following instructions described in Section 16.4, then go to Step 6.
6. Enable interrupts, and exit.

Note:

Steps 4 and 5 should not be interrupted by any interrupts. Therefore, users need to disable all the interrupts before these steps, and enable interrupts once done.

16.6 NMI Interrupt Masking

Some software process of ESP32-S3 should not be interrupted. For example, the configuration of World Controller should not be interrupted by any interrupts, including the NMI interrupts.

Normally, we can configure some CPU registers to mask different kinds of interrupts, but NMI interrupt is not one of them. To mask an NMI interrupt, you need to configure the interrupt sources, which is more complicated. For details, see Chapter 9 [Interrupt Matrix \(INTERRUPT\)](#).

World Controller has implemented some hardware mechanism to simplify the process to mask NMI interrupts for:

- **All** applications:
 - Configure [WCL_CORE_m_NMI_MASK](#):
 - * 1: Enable
 - * 0: Disable
- **Some** applications:
 1. Configures [WCL_CORE_m_NMI_MASK_TRIGGER_ADDR](#) to the address at which the NMI interrupt masking ends, meaning the CPU stops masking NMI interrupts after this address.
 2. Write any value to [WCL_CORE_m_NMI_MASK_DISABLE](#), indicating the completion of [WCL_CORE_m_NMI_MASK_TRIGGER_ADDR](#) configuration.
 3. Write any value to [WCL_CORE_m_NMI_MASK_ENABLE](#) to start masking NMI interrupts till the address configured in [WCL_CORE_m_NMI_MASK_TRIGGER_ADDR](#).

Note:

- Only one of the above two methods should be used at the same time.
- The configuration to mask NMI interrupts is effective all the time until trigger address executes. Therefore, you need to configure the world controller to mask NMI interrupts again once trigger address executes.

16.7 Register Summary

The addresses in this section are relative to the World Controller base address provided in Table 4-3 in Chapter 4 *System and Memory*.

Note that, the table below only lists the registers for CPU0. CPU1 shares exactly the same set of registers. Adding 0x0400 to the offset of the equivalent of CPU0 register gives you address for CPU1 registers.

For example, the offset for CPU0 register `WCL_CORE_0_ENTRY_CHECK_REG` is 0x007C, the offset for CPU1 equivalent `WCL_CORE_1_ENTRY_CHECK_REG` should be 0x007C + 0x0400, which is 0x047C.

The abbreviations given in Column **Access** are explained in Section [Access Types for Registers](#).

Name	Description	Address	Access
Non-secure World to Secure World Configuration Registers			
<code>WCL_CORE_0_ENTRY_n_ADDR_REG (n: 1-13)</code>	CPU0 Entry <i>n</i> Address Configuration Register	0x0000 + 4*(<i>n</i> -1)	R/W
<code>WCL_CORE_0_ENTRY_CHECK_REG</code>	CPU0 Entry Check Enable Register	0x007C	R/W
<code>WCL_CORE_0_MESSAGE_ADDR_REG</code>	CPU0 Clear Writer_buffer Configuration Register - Configures Address	0x0100	R/W
<code>WCL_CORE_0_MESSAGE_MAX_REG</code>	CPU0 Clear Writer_buffer Configuration Register - Configures sequence	0x0104	R/W
<code>WCL_CORE_0_MESSAGE_PHASE_REG</code>	CPU0 Clear Writer_buffer Configuration Register - Checks Status	0x0108	RO
Status Table Registers			
<code>WCL_CORE_0_STATUSTABLEn_REG(n: 1-13)</code>	CPU0 World Switch Status Register for Entry <i>n</i>	0x0080 + 4*(<i>n</i> -1)	R/W
<code>WCL_CORE_0_STATUSTABLE_CURRENT_REG</code>	CPU0 Status Register of Statustable Current Field	0x00FC	R/W
Secure World to Non-secure World Configuration Registers			
<code>WCL_CORE_0_World_TRIGGER_ADDR_REG</code>	CPU0 Trigger Address Configuration Register	0x0140	RW
<code>WCL_CORE_0_World_PREPARE_REG</code>	CPU0 World Configuration Register - Configures Entry Address	0x0144	R/W
<code>WCL_CORE_0_World_UPDATE_REG</code>	CPU0 World Configuration Register - Confirms Configuration Done	0x0148	WO
<code>WCL_CORE_0_World_Cancel_REG</code>	CPU0 World Configuration Register - Cancels Configuration	0x014C	WO
<code>WCL_CORE_0_World_IRam0_REG</code>	CPU0 IRAM0 World Status Register	0x0150	R/W
<code>WCL_CORE_0_World_DRam0_PIF_REG</code>	CPU0 Dram0 and PIF World Status Register	0x0154	R/W
<code>WCL_CORE_0_World_Phase_REG</code>	CPU0 World Status Register	0x0158	RO
NMI Mask Configuration Registers			
<code>WCL_CORE_0_NMI_MASK_ENABLE_REG</code>	CPU0 NMI Mask Enable Register	0x0180	WO
<code>WCL_CORE_0_NMI_MASK_TRIGGER_ADDR_REG</code>	CPU0 NMI Mask Trigger Address Register	0x0184	R/W
<code>WCL_CORE_0_NMI_MASK_DISABLE_REG</code>	CPU0 NMI Mask Disable Register	0x0188	WO
<code>WCL_CORE_0_NMI_MASK_CANCEL_REG</code>	CPU0 NMI Mask Cancel Register	0x018C	WO
<code>WCL_CORE_0_NMI_MASK_REG</code>	CPU0 NMI Mask Register	0x0190	R/W
<code>WCL_CORE_0_NMI_MASK_PHASE_REG</code>	CPU0 NMI Mask Status Register	0x0194	RO

16.8 Registers

The addresses in this section are relative to the World Controller base address provided in Table 4-3 in Chapter 4 *System and Memory*.

Note that, the section below only lists the registers for CPU0. CPU1 shares exactly the same set of registers. Adding 0x0400 to the offset of the equivalent of CPU0 register gives you address for CPU1 registers.

For example, the offset for CPU0 register `WCL_CORE_0_ENTRY_CHECK_REG` is 0x007C, the offset for CPU1 equivalent `WCL_CORE_1_ENTRY_CHECK_REG` should be 0x007C + 0x0400, which is 0x047C.

Register 16.1. `WCL_CORE_0_ENTRY_n_ADDR_REG` ($n: 1-13$) (0x0000+4*($n-1$))

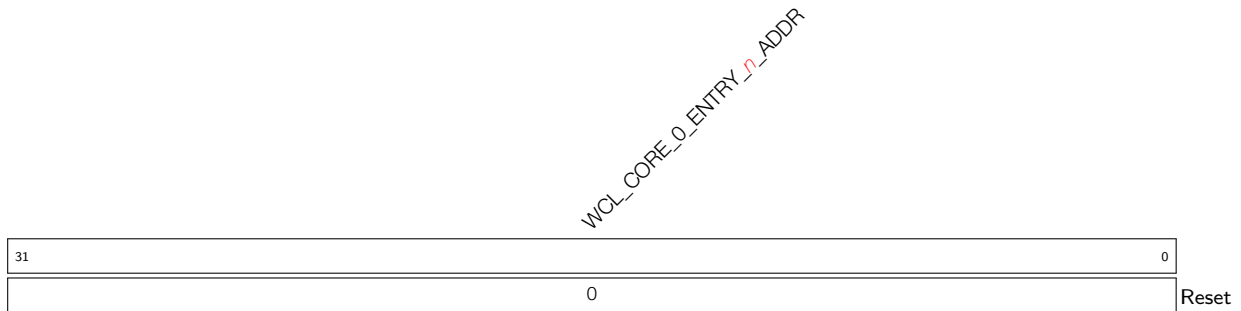

`WCL_CORE_0_ENTRY_n_ADDR` Configures the CPU0 Entry n address from Non-secure World to Secure World. (R/W)

Register 16.2. `WCL_CORE_0_ENTRY_CHECK_REG` (0x007C)

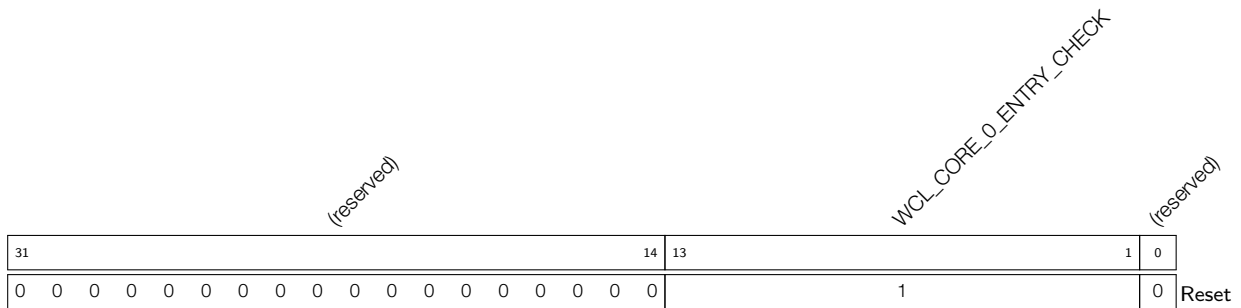

`WCL_CORE_0_ENTRY_CHECK` Set this bit to enable CPU0 switching from Non-secure World to Secure world upon the monitored address. (R/W)

Register 16.3. WCL_CORE_0_MESSAGE_ADDR_REG (0x0100)

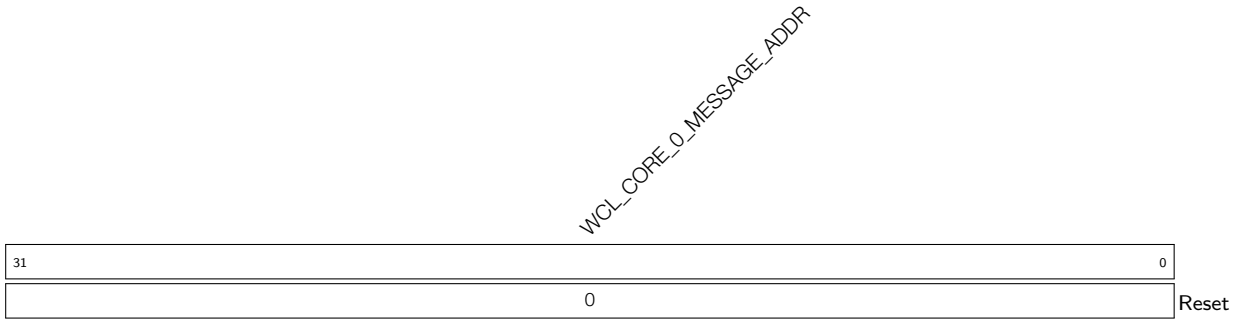

WCL_CORE_0_MESSAGE_ADDR Configures the address to write agreed sequence to clear write_buffer for CPU0. (R/W)

Register 16.4. WCL_CORE_0_MESSAGE_MAX_REG (0x0104)

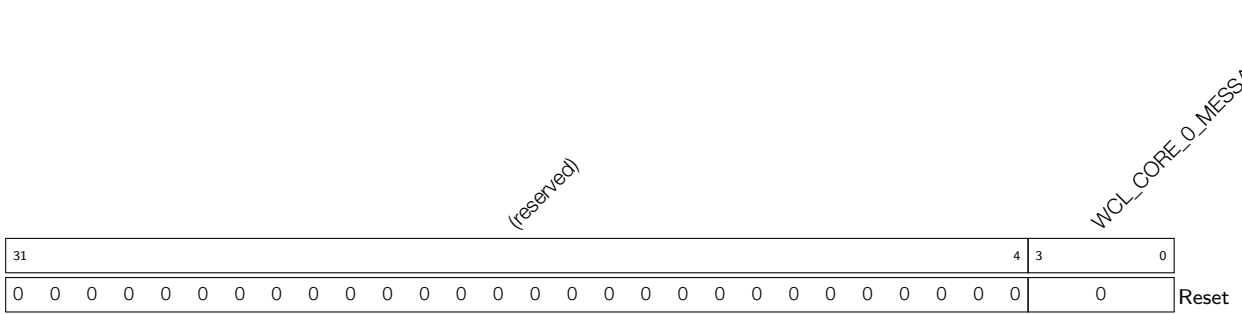

WCL_CORE_0_MESSAGE_MAX Configures the agreed sequence to write to clear write_buffer for CPU0. It's advised to set this field to no less than 3. (R/W)

Register 16.5. WCL_CORE_0_MESSAGE_PHASE_REG (0x0108)

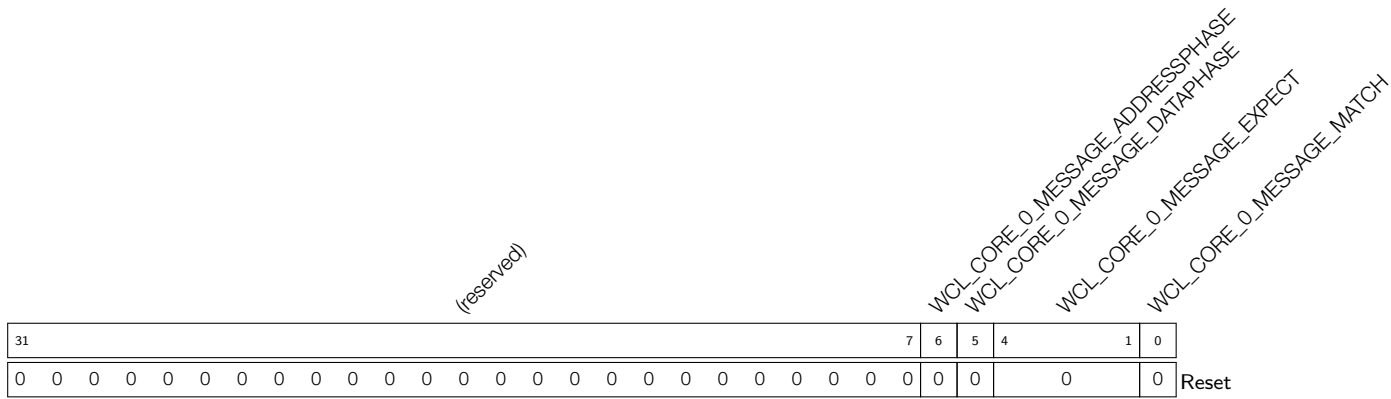

WCL_CORE_0_MESSAGE_MATCH Indicates if CPU0's world switch is successful. This field is only used for debugging. (RO)

WCL_CORE_0_MESSAGE_EXPECT Indicates the number to be written next for CPU0. This field is only used for debugging. (RO)

WCL_CORE_0_MESSAGE_DATAPHASE When 1, indicates CPU0 is checking if the agreed sequence is written to clear write_buffer. This field is only used for debugging. (RO)

WCL_CORE_0_MESSAGE_ADDRESSPHASE When 1, indicates CPU0 is checking if any sequence is written to the agreed address to clear write_buffer. This field is only used for debugging. (RO)

Register 16.6. WCL_CORE_0_STATUSTABLE_n_REG (*n*: 1-13) (0x0080+4*(*n*-1))

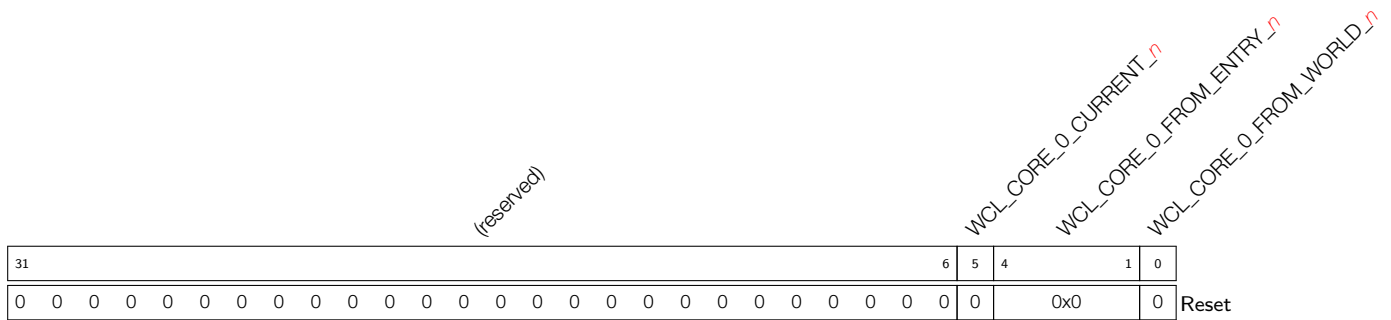

WCL_CORE_0_FROM_WORLD_n Stores the world info for CPU0 before entering entry *n*. (R/W)

WCL_CORE_0_FROM_ENTRY_n Stores the previous entry info for CPU0 before entering entry *n*. (R/W)

WCL_CORE_0_CURRENT_n Indicates if the interrupt is at entry *n* for CPU0. (R/W)

Register 16.7. WCL_CORE_0_STATUSTABLE_CURRENT_REG (0x00FC)

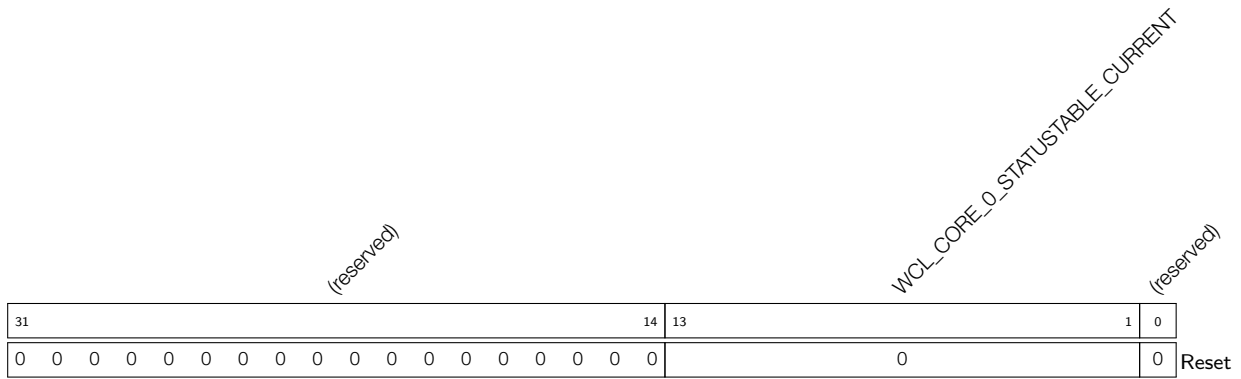

WCL_CORE_0_STATUSTABLE_CURRENT Indicates the entry where the interrupt is currently at for CPU0. (R/W)

Register 16.8. WCL_CORE_0_World_TRIGGER_ADDR_REG (0x0140)

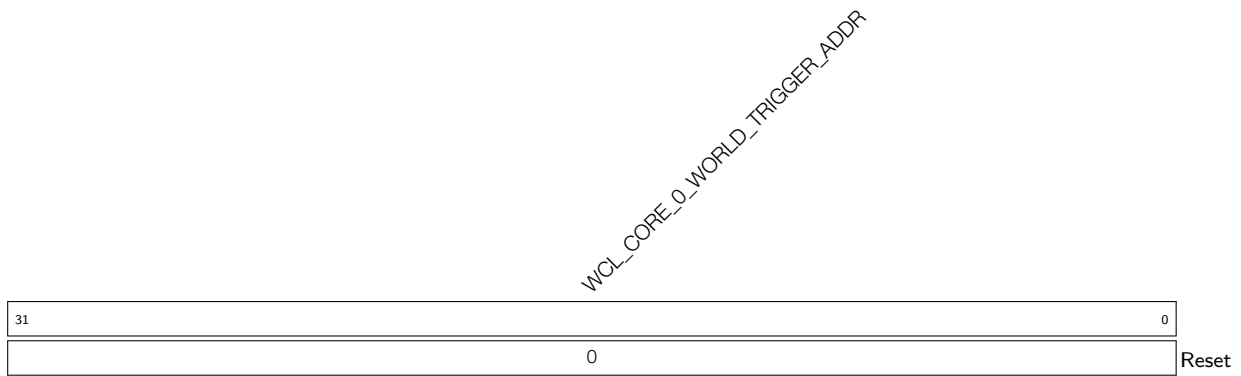

WCL_CORE_0_WORLD_TRIGGER_ADDR Configures the entry address at which CPU0 switches from Secure World to Non-secure World. (RW)

Register 16.9. WCL_CORE_0_World_PREPARE_REG (0x0144)

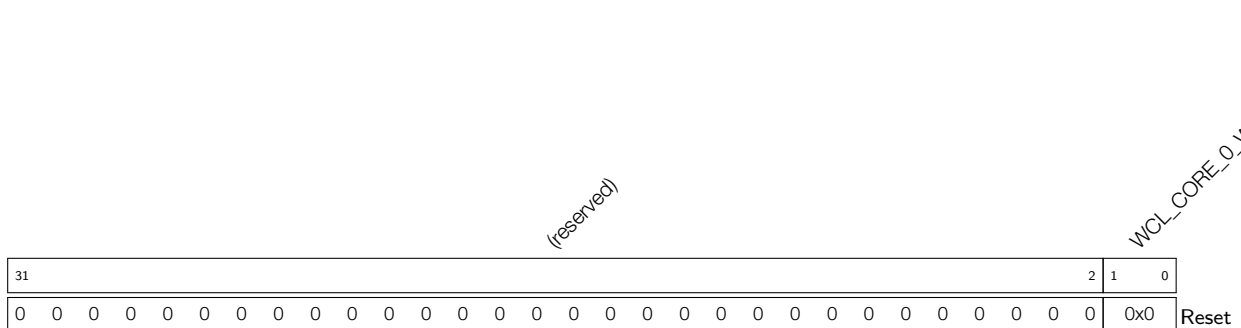

WCL_CORE_0_WORLD_PREPARE Write 0x2 to this field to ready CPU0 for world switch from Secure World to Non-secure World. This field is only used for debugging.(R/W)

Register 16.10. WCL_CORE_0_World_UPDATE_REG (0x0148)

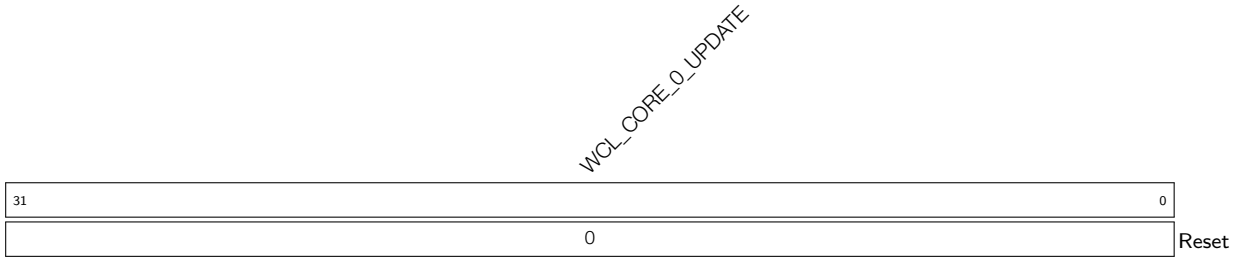

WCL_CORE_0_UPDATE Write any value to this field to indicate the completion of CPU0 configuration for switching from Secure World to Non-Secure World. (WO)

Register 16.11. WCL_CORE_0_World_Cancel_REG (0x014C)

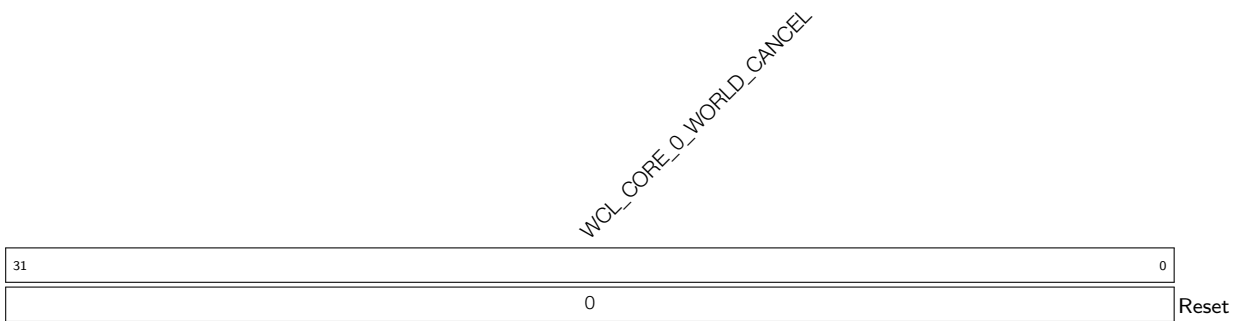

WCL_CORE_0_WORLD_CANCEL Write any value to this field to cancel the CPU0 configuration for switching from Secure World to Non-Secure World. (WO)

Register 16.12. WCL_CORE_0_World_IRam0_REG (0x0150)

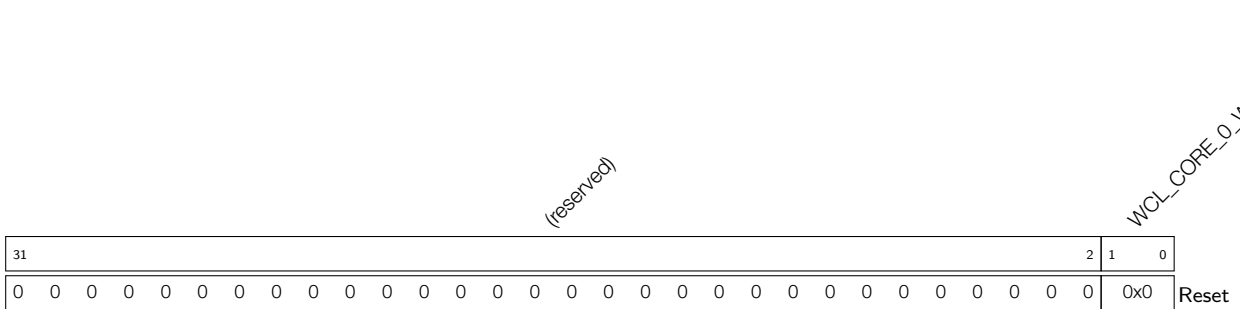

WCL_CORE_0_WORLD_IRAM0 Stores the world info of CPU0's instruction bus. This field is only used for debugging. (R/W)

Register 16.13. WCL_CORE_0_World_DRam0_PIF_REG (0x0154)

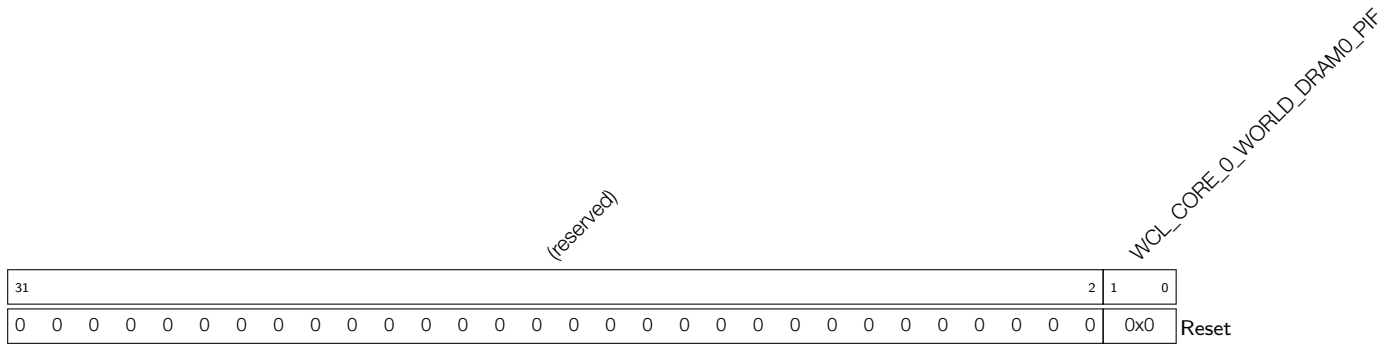

WCL_CORE_0_WORLD_DRAM0_PIF Stores the world info of CPU0's data bus and peripheral bus. This field is only used for debugging. (R/W)

Register 16.14. WCL_CORE_0_World_Phase_REG (0x0158)

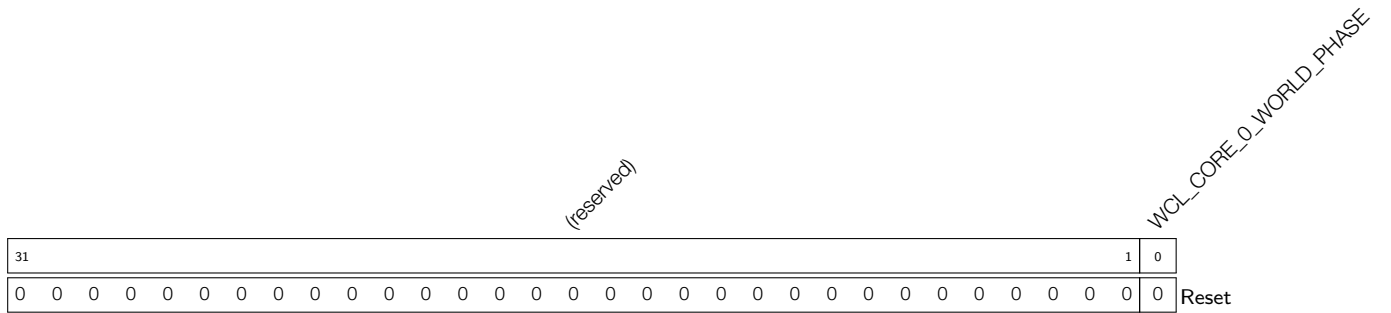

WCL_CORE_0_WORLD_PHASE Indicates if the CPU0 is ready to switch from Non-secure World to Secure World. 1: ready; 2: not ready. (RO)

Register 16.15. WCL_CORE_0_NMI_MASK_ENABLE_REG (0x0180)

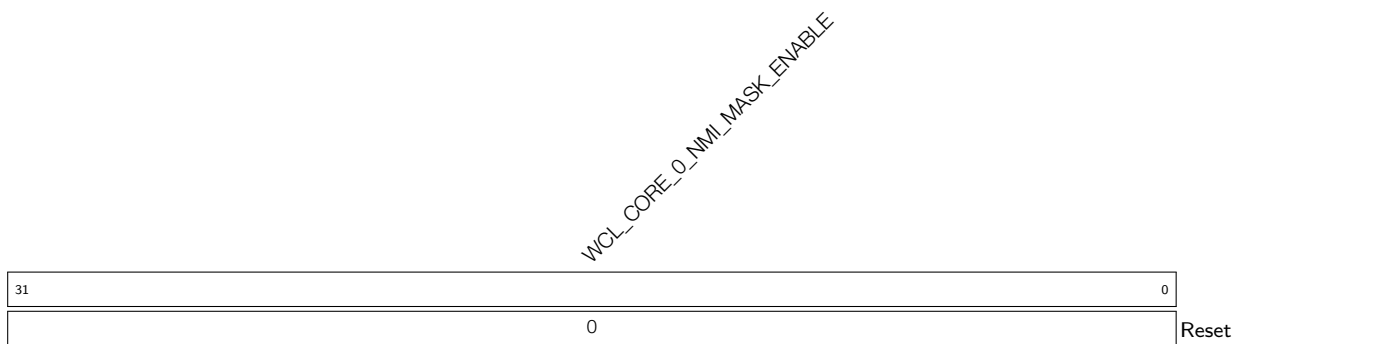

WCL_CORE_0_NMI_MASK_ENABLE Write any value to this field to start CPU0 masking any NMI interrupt. (WO)

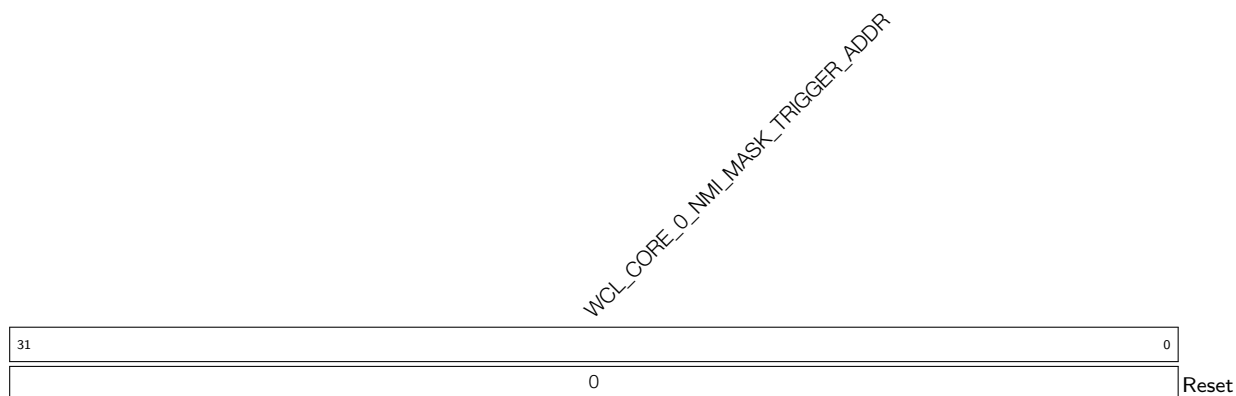
Register 16.16. WCL_CORE_0_NMI_MASK_TRIGGER_ADDR_REG (0x0184)

WCL_CORE_0_NMI_MASK_TRIGGER_ADDR Configures the address at which the NMI masking stops for CPU0. (R/W)

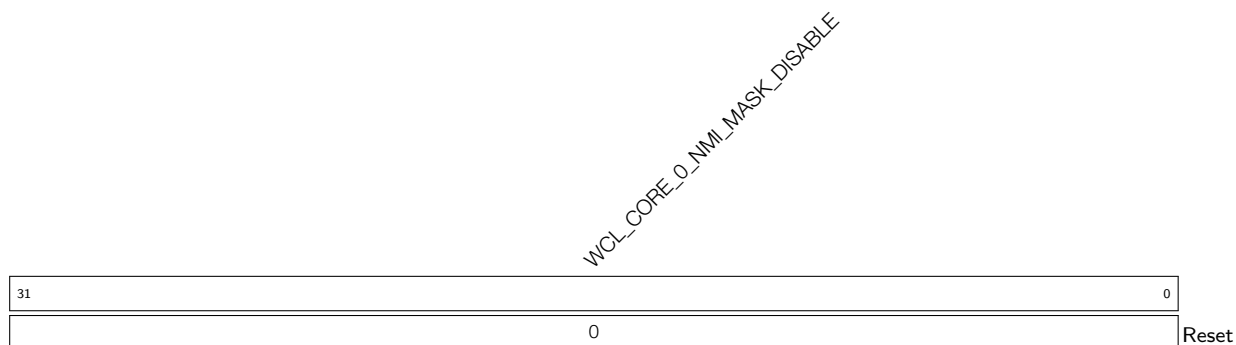
Register 16.17. WCL_CORE_0_NMI_MASK_DISABLE_REG (0x0188)

WCL_CORE_0_NMI_MASK_DISABLE Write any value to this field so CPU0 checks NMI masking. (WO)

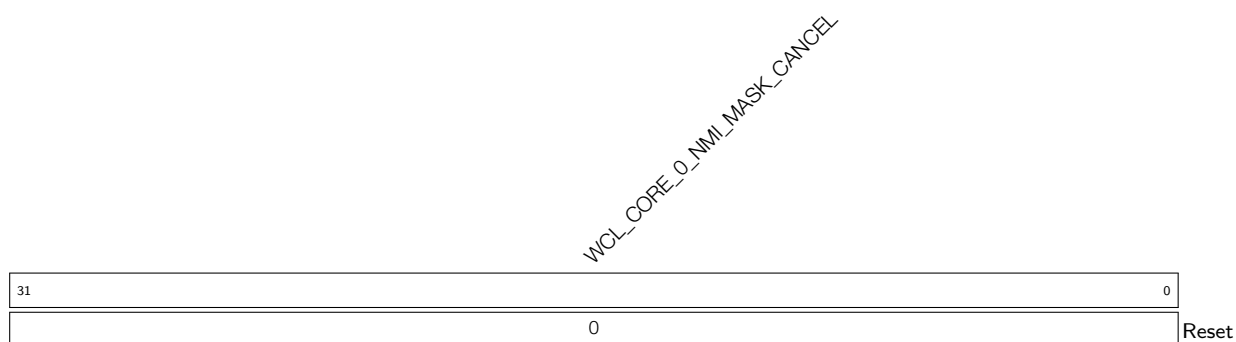
Register 16.18. WCL_CORE_0_NMI_MASK_CANCEL_REG (0x018C)

WCL_CORE_0_NMI_MASK_CANCEL Write any value to this field to cancel CPU0's NMI masking. (WO)

Register 16.19. WCL_CORE_0_NMI_MASK_REG (0x0190)

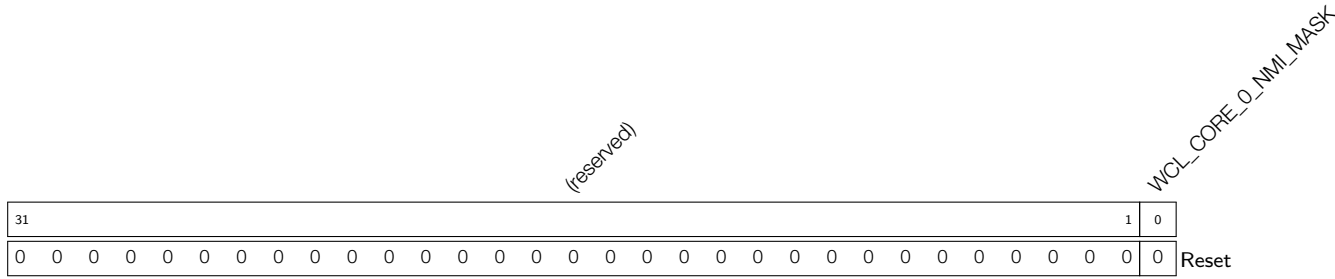

WCL_CORE_0_NMI_MASK Set this bit to mask all the NMI interrupts in CPU0. (R/W)

Register 16.20. WCL_CORE_0_NMI_MASK_PHASE_REG (0x0194)

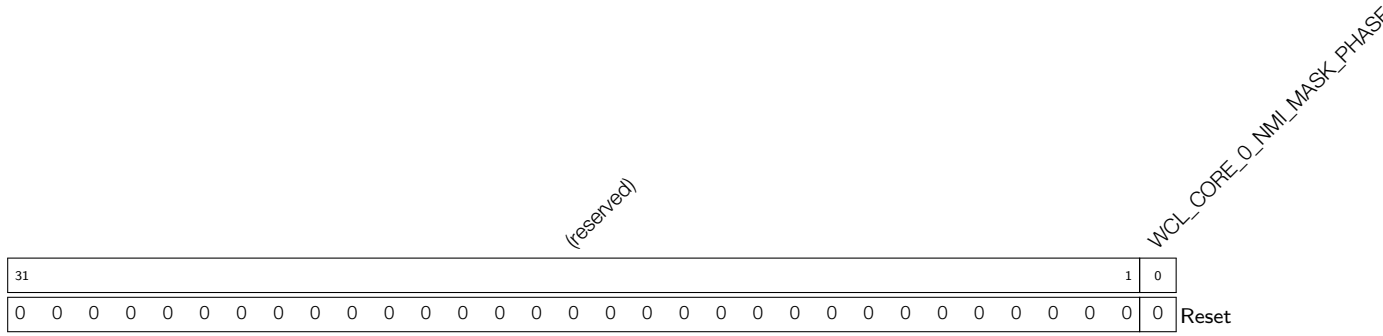

WCL_CORE_0_NMI_MASK_PHASE Indicates if the NMI interrupt is being masked in CPU0. 1: masked; 0: not masked. (RO)

17 System Registers (SYSTEM)

17.1 Overview

The ESP32-S3 integrates a large number of peripherals, and enables the control of individual peripherals to achieve optimal characteristics in performance-vs-power-consumption scenarios. Specifically, ESP32-S3 has a various of system configuration registers that can be used for the chip's clock management (clock gating), power management, and the configuration of peripherals and core-system modules. This chapter lists all these system registers and their functions.

17.2 Features

ESP32-S3 system registers can be used to control the following peripheral blocks and core modules:

- System and memory
- Clock
- Software Interrupt
- Low-power management
- Peripheral clock gating and reset
- CPU Control

17.3 Function Description

17.3.1 System and Memory Registers

17.3.1.1 Internal Memory

The following registers can be used to control ESP32-S3's internal memory:

- In register [APB_CTRL_CLKGATE_FORCE_ON_REG](#):
 - Setting different bits of the [APB_CTRL_ROM_CLKGATE_FORCE_ON](#) field forces on the clock gates of different blocks of Internal ROM 0 and Internal ROM 1.
 - Setting different bits of the [APB_CTRL_SRAM_CLKGATE_FORCE_ON](#) field forces on the clock gates of different blocks of Internal SRAM.
 - This means when the respective bits of this register are set to 1, the clock gate of the corresponding ROM or SRAM blocks will always be on. Otherwise, the clock gate will turn on automatically when the corresponding ROM or SRAM blocks are accessed and turn off automatically when the corresponding ROM or SRAM blocks are not accessed. Therefore, it's recommended to configure these bits to 0 to lower power consumption.
- In register [APB_CTRL_MEM_POWER_DOWN_REG](#):
 - Setting different bits of the [APB_CTRL_ROM_POWER_DOWN](#) field sends different blocks of Internal ROM 0 and Internal ROM 1 into retention state.

- Setting different bits of the [APB_CTRL_SRAM_POWER_DOWN](#) field sends different blocks of Internal SRAM into retention state.
- The “Retention” state is a low-power state of a memory block. In this state, the memory block still holds all the data stored but cannot be accessed, thus reducing the power consumption. Therefore, you can send a certain block of memory into the retention state to reduce power consumption if you know you are not going to use such memory block for some time.
- In register [APB_CTRL_MEM_POWER_UP_REG](#):
 - By default, all memory enters low-power state when the chip enters the Light-sleep mode.
 - Setting different bits of the [APB_CTRL_ROM_POWER_UP](#) field forces different blocks of Internal ROM 0 and Internal ROM 1 to work as normal (do not enter the retention state) when the chip enters Light-sleep.
 - Setting different bits of the [APB_CTRL_SRAM_POWER_UP](#) field forces different blocks of Internal SRAM to work as normal (do not enter the retention state) when the chip enters Light-sleep.

For detailed information about the controlling bits of different blocks, please see Table 17-1 below.

Table 17-1. Internal Memory Controlling Bit

Internal Memory	Lowest Address1	Highest Address1	Lowest Address2	Highest Address2	Controlling Bit
Internal ROM 0	0x4000_0000	0x4003_FFFF	-	-	Bit0
Internal ROM 1	0x4004_0000	0x4004_FFFF	-	-	Bit1
Internal ROM 2	0x4005_0000	0x4005_FFFF	0x3FF0_0000	0x3FF0_FFFF	Bit2
SRAM Block0	0x4037_0000	0x4037_3FFF	-	-	Bit0
SRAM Block1	0x4037_4000	0x4037_7FFF	-	-	Bit1
SRAM Block2	0x4037_8000	0x4037_FFFF	0x3FC8_8000	0x3FC8_FFFF	Bit2
SRAM Block3	0x4038_0000	0x4038_FFFF	0x3FC9_0000	0x3FC9_FFFF	Bit3
SRAM Block4	0x4039_8000	0x4039_FFFF	0x3FCA_0000	0x3FCA_FFFF	Bit4
SRAM Block5	0x403A_C000	0x403A_FFFF	0x3FCB_C000	0x3FCB_FFFF	Bit5
SRAM Block6	0x403B_0000	0x403B_FFFF	0x3FCC_0000	0x3FCC_FFFF	Bit6
SRAM Block7	0x403C_0000	0x403C_FFFF	0x3FCD_4000	0x3FCD_FFFF	Bit7
SRAM Block8	0x403D_0000	0x403D_BFFF	0x3FCE_8000	0x3FCE_FFFF	Bit8
SRAM Block9	-	-	0x3FCF_0000	0x3FCF_7FFF	Bit9
SRAM Block10	-	-	0x3FCF_8000	0x3FCF_FFFF	Bit10

For detailed information about the controlling bits of different blocks, please see Table 17-1 below.

17.3.1.2 External Memory

[SYSTEM_EXTERNAL_DEVICE_ENCRYPT_DECRYPT_CONTROL_REG](#) configures encryption and decryption options of the external memory. For details, please refer to Chapter 23 *External Memory Encryption and Decryption (XTS_AES)*.

17.3.1.3 RSA Memory

[SYSTEM_RSA_PD_CTRL_REG](#) controls the SRAM memory in the RSA accelerator.

- Setting the [SYSTEM_RSA_MEM_PD](#) bit to send the RSA memory into retention state. This bit has the lowest priority, meaning it can be masked by the [SYSTEM_RSA_MEM_FORCE_PU](#) field. This bit is invalid when the *Digital Signature (DS)* occupies the RSA.
- Setting the [SYSTEM_RSA_MEM_FORCE_PU](#) bit to force the RSA memory to work as normal when the chip enters light sleep. This bit has the second highest priority, meaning it overrides the [SYSTEM_RSA_MEM_PD](#) field.
- Setting the [SYSTEM_RSA_MEM_FORCE_PD](#) bit to send the RSA memory into retention state. This bit has the highest priority, meaning it sends the RSA memory into retention state regardless of the [SYSTEM_RSA_MEM_FORCE_PU](#) field.

17.3.2 Clock Registers

The following registers are used to set clock sources and frequency. For more information, please refer to Chapter 7 *Reset and Clock*.

- [SYSTEM_CPU_PER_CONF_REG](#)
- [SYSTEM_SYSCLK_CONF_REG](#)
- [SYSTEM_BT_LPCK_DIV_FRAC_REG](#)

17.3.3 Interrupt Signal Registers

The following registers are used for generating the interrupt signals, which then can be routed to the CPU peripheral interrupts via the interrupt matrix. To be more specific, writing 1 to any of the following registers generates an interrupt signal. Therefore, these registers can be used by software to control interrupts. For more information, please refer to Chapter 9 *Interrupt Matrix (INTERRUPT)*.

- [SYSTEM_CPU_INTR_FROM_CPU_0_REG](#)
- [SYSTEM_CPU_INTR_FROM_CPU_1_REG](#)
- [SYSTEM_CPU_INTR_FROM_CPU_2_REG](#)
- [SYSTEM_CPU_INTR_FROM_CPU_3_REG](#)

17.3.4 Low-power Management Registers

The following registers are used for low-power management. For more information, please refer to Chapter 10 *Low-power Management (RTC_CNTL)*.

- [SYSTEM_RTC_FASTMEM_CONFIG_REG](#): configures the RTC CRC check.
- [SYSTEM_RTC_FASTMEM_CRC_REG](#): configures the CRC check value.

17.3.5 Peripheral Clock Gating and Reset Registers

The following registers are used for controlling the clock gating and reset of different peripherals. Details can be seen in Table 17-2.

- [SYSTEM_CACHE_CONTROL_REG](#)
- [SYSTEM_EDMA_CTRL_REG](#)
- [SYSTEM_PERIP_CLK_EN0_REG](#)

- [SYSTEM_PERIP_RST_EN0_REG](#)
- [SYSTEM_PERIP_CLK_EN1_REG](#)
- [SYSTEM_PERIP_RST_EN1_REG](#)

Table 17-2. Peripheral Clock Gating and Reset Bits

Peripheral	Clock Enabling Bit ¹	Reset Controlling Bit ^{2,3}
EDMA Ctrl	SYSTEM_EDMA_CTRL_REG	
EDMA	SYSTEM_EDMA_CLK_ON	SYSTEM_EDMA_RESET
CACHE Ctrl	SYSTEM_CACHE_CONTROL_REG	
DCACHE	SYSTEM_DCACHE_CLK_ON	SYSTEM_DCACHE_RESET
ICACHE	SYSTEM_ICACHE_CLK_ON	SYSTEM_ICACHE_RESET
Peripheral	SYSTEM_PERIP_CLK_EN0_REG	SYSTEM_PERIP_RST_EN0_REG
Timer Group0	SYSTEM_TIMERGROUP_CLK_EN	SYSTEM_TIMERGROUP_RST
Timer Group1	SYSTEM_TIMERGROUP1_CLK_EN	SYSTEM_TIMERGROUP1_RST
System Timer	SYSTEM_SYSTIMER_CLK_EN	SYSTEM_SYSTIMER_RST
UART0	SYSTEM_UART_CLK_EN	SYSTEM_UART_RST
UART1	SYSTEM_UART1_CLK_EN	SYSTEM_UART1_RST
UART MEM	SYSTEM_UART_MEM_CLK_EN ⁴	SYSTEM_UART_MEM_RST
SPI0 SPI1	SYSTEM_SPI01_CLK_EN	SYSTEM_SPI01_RST
SPI2	SYSTEM_SPI2_CLK_EN	SYSTEM_SPI2_RST
SPI3	SYSTEM_SPI3_CLK_EN	SYSTEM_SPI3_RST
I2C0	SYSTEM_I2C_EXT0_CLK_EN	SYSTEM_I2C_EXT0_RST
I2C1	SYSTEM_I2C_EXT1_CLK_EN	SYSTEM_I2C_EXT1_RST
I2S0	SYSTEM_I2S0_CLK_EN	SYSTEM_I2S0_RST
I2S1	SYSTEM_I2S1_CLK_EN	SYSTEM_I2S1_RST
TWAI Controller	SYSTEM_CAN_CLK_EN	SYSTEM_CAN_RST
UHCIO	SYSTEM_UHCIO_CLK_EN	SYSTEM_UHCIO_RST
USB	SYSTEM_USB_CLK_EN	SYSTEM_USB_RST
RMT	SYSTEM_RMT_CLK_EN	SYSTEM_RMT_RST
PCNT	SYSTEM_PCNT_CLK_EN	SYSTEM_PCNT_RST
PWM0	SYSTEM_PWM0_CLK_EN	SYSTEM_PWM0_RST
PWM1	SYSTEM_PWM1_CLK_EN	SYSTEM_PWM1_RST
LED_PWM Controller	SYSTEM_LEDC_CLK_EN	SYSTEM_LEDC_RST
ADC Arbiter	SYSTEM_ADC2_ARB_CLK_EN	SYSTEM_ADC2_ARB_RST
ADC Controller	SYSTEM_APB_SARADC_CLK_EN	SYSTEM_APB_SARADC_RST
Accelerators	SYSTEM_PERIP_CLK_EN1_REG	SYSTEM_PERIP_RST_EN1_REG
USB_DEVICE	SYSTEM_USB_DEVICE_CLK_EN	SYSTEM_USB_DEVICE_RST
UART2	SYSTEM_UART2_CLK_EN	SYSTEM_UART2_RST
LCD_CAM	SYSTEM_LCD_CAM_CLK_EN	SYSTEM_LCD_CAM_RST
SDIO_HOST	SYSTEM_SDIO_HOST_CLK_EN	SYSTEM_SDIO_HOST_RST
DMA	SYSTEM_DMA_CLK_EN	SYSTEM_DMA_RST ⁵
HMAC	SYSTEM_CRYPT0_HMAC_CLK_EN	SYSTEM_CRYPT0_HMAC_RST ⁶
Digital Signature	SYSTEM_CRYPT0_DS_CLK_EN	SYSTEM_CRYPT0_DS_RST ⁷
RSA Accelerator	SYSTEM_CRYPT0_RSA_CLK_EN	SYSTEM_CRYPT0_RSA_RST

SHA Accelerator	SYSTEM_CRYPT_SHA_CLK_EN	SYSTEM_CRYPT_SHA_RST
AES Accelerator	SYSTEM_CRYPT_AES_CLK_EN	SYSTEM_CRYPT_AES_RST
peri backup	SYSTEM_PERI_BACKUP_CLK_EN	SYSTEM_PERI_BACKUP_RST

Note:

1. Setting the clock enable register to 1 enables the clock, and to 0 disables the clock;
2. Setting the reset enabling register to 1 resets a peripheral, and to 0 disables the reset.
3. Reset registers cannot be cleared by hardware. Therefore, SW reset clear is required after setting the reset registers.
4. UART memory is shared by all UART peripherals, meaning having any active UART peripherals will prevent the UART memory from entering the clock-gated state.
5. When DMA is required for peripheral communications, for example, UCHI0, SPI, I2S, LCD_CAM, AES, SHA and ADC, DMA clock should also be enabled.
6. Resetting this bit also resets the SHA accelerator.
7. Resetting this bit also resets the AES, SHA, and RSA accelerators.

17.3.6 CPU Control Registers

These registers control CPU0 and CPU1 of ESP32-S3. Note that, by default, only CPU0 is started when the SoC powers up. During this time, the clock of CPU1 is disabled. Therefore, users need to enable CPU1 clock manually to use both CPU0 and CPU1.

- [SYSTEM_CORE_1_CONTROL_0_REG](#)
 - Setting the [SYSTEM_CONTROL_CORE_1_RESETTING](#) bit resets CPU1.
 - [SYSTEM_CONTROL_CORE_1_CLKGATE_EN](#) controls the CPU1 clock.
 - Setting the [SYSTEM_CONTROL_CORE_1_RUNSTALL](#) bit stalls CPU1. When this bit is set, CPU1 will finish the on-going task and stalls.
- Register [SYSTEM_CORE_1_CONTROL_1_REG](#) is used to facilitate the communication between CPU0 and CPU1. To be more specific, one CPU can write this register, using the agreed-on formats, which will then be read by the other CPU, thus achieving communication between these two CPUs. Note that the value in this register will not affect any hardware configuration, which allows CPU communication solely controlled by software.

17.4 Register Summary

In this section, the addresses of all the registers starting with SYSTEM are relative to the base address of system registers provided in Table 4-3 in Chapter 4 *System and Memory*; and those starting with APB are relative to the base address of APB control also provided in Table 4-3 in Chapter 4 *System and Memory*.

The abbreviations given in Column **Access** are explained in Section [Access Types for Registers](#).

Name	Description	Address	Access
SYSTEM_CORE_1_CONTROL_0_REG	Core1 control register 0	0x0000	R/W
SYSTEM_CORE_1_CONTROL_1_REG	Core1 control register 1	0x0004	R/W
SYSTEM_CPU_PER_CONF_REG	CPU peripheral clock configuration register	0x0010	R/W
SYSTEM_PERIP_CLK_EN0_REG	System peripheral clock enable register 0	0x0018	R/W
SYSTEM_PERIP_CLK_EN1_REG	System peripheral clock enable register 1	0x001C	R/W
SYSTEM_PERIP_RST_EN0_REG	System peripheral reset register 0	0x0020	R/W
SYSTEM_PERIP_RST_EN1_REG	System peripheral reset register 1	0x0024	R/W
SYSTEM_BT_LPCK_DIV_FRAC_REG	Low-power clock configuration register 1	0x002C	R/W
SYSTEM_CPU_INTR_FROM_CPU_0_REG	Software interrupt source register 0	0x0030	R/W
SYSTEM_CPU_INTR_FROM_CPU_1_REG	Software interrupt source register 1	0x0034	R/W
SYSTEM_CPU_INTR_FROM_CPU_2_REG	Software interrupt source register 2	0x0038	R/W
SYSTEM_CPU_INTR_FROM_CPU_3_REG	Software interrupt source register 3	0x003C	R/W
SYSTEM_RSA_PD_CTRL_REG	RSA memory power control register	0x0040	R/W
SYSTEM_EDMA_CTRL_REG	EDMA control register	0x0044	R/W
SYSTEM_CACHE_CONTROL_REG	Cache control register	0x0048	R/W
SYSTEM_EXTERNAL_DEVICE_ENCRYPT_DECRYPT_CONTROL_REG	External memory encryption and decryption control register	0x004C	R/W
SYSTEM_RTC_FASTMEM_CONFIG_REG	Fast memory CRC configuration register	0x0050	varies
SYSTEM_RTC_FASTMEM_CRC_REG	Fast memory CRC result register	0x0054	RO
SYSTEM_CLOCK_GATE_REG	System clock control register	0x005C	R/W
SYSTEM_SYSCLK_CONF_REG	System clock configuration register	0x0060	varies
SYSTEM_DATE_REG	Version register	0x0FFC	R/W

Name	Description	Address	Access
APB_CTRL_CLKGATE_FORCE_ON_REG	Internal memory clock gate enable register	0x00A8	R/W
APB_CTRL_MEM_POWER_DOWN_REG	Internal memory control register	0x00AC	R/W
APB_CTRL_MEM_POWER_UP_REG	Internal memory control register	0x00B0	R/W

Register 17.3. SYSTEM_CPU_PER_CONF_REG (0x0010)

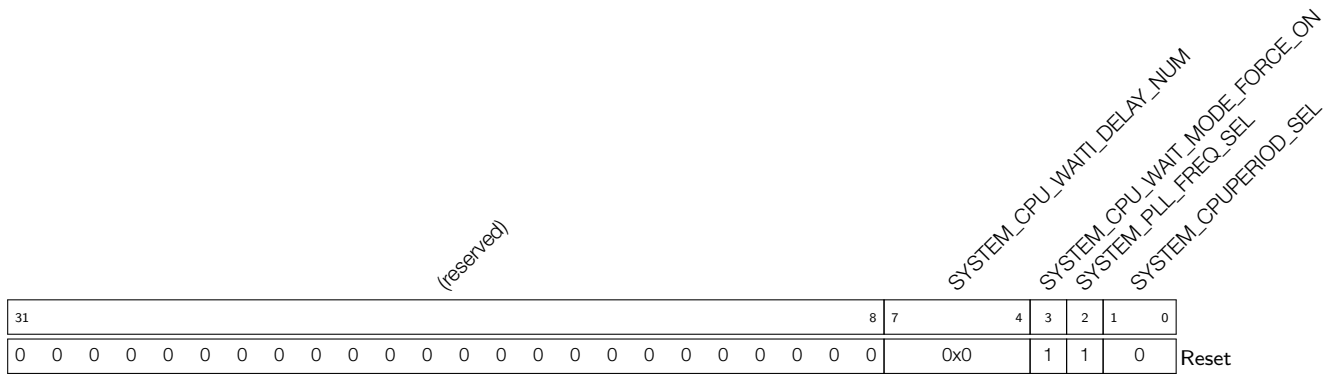

SYSTEM_CPUPERIOD_SEL Set this field to select the CPU clock frequency. (R/W)

SYSTEM_PLL_FREQ_SEL Set this bit to select the PLL clock frequency. (R/W)

SYSTEM_CPU_WAIT_MODE_FORCE_ON Set this bit to force on the clock gate of CPU wait mode. Usually, after executing the WAITI instruction, CPU enters the wait mode, during which the clock gate of CPU is turned off until any interrupts occur. In this way, power consumption is reduced. However, if this bit is set, the clock gate of CPU is always on and will not be turned off by the WAITI instruction. (R/W)

SYSTEM_CPU_WAITI_DELAY_NUM Sets the number of delay cycles to turn off the CPU clock gate after the CPU enters the wait mode because of a WAITI instruction. (R/W)

Register 17.4. SYSTEM_PERIP_CLK_EN0_REG (0x0018)

31	30	29	28	27	25	24	23	22	21	20	19	18	17	16	15	14	13	12	11	10	9	8	7	6	5	4	3	2	1	0	
0	1	1	0	0	0	0	1	1	0	0	0	0	0	0	1	1	0	1	0	0	0	0	0	0	1	1	0	0	1	1	0

Reset

SYSTEM_SPI01_CLK_EN Set this bit to enable SPI01 clock. (R/W)

SYSTEM_UART_CLK_EN Set this bit to enable UART clock. (R/W)

SYSTEM_I2S0_CLK_EN Set this bit to enable I2S0 clock. (R/W)

SYSTEM_UART1_CLK_EN Set this bit to enable UART1 clock. (R/W)

SYSTEM_SPI2_CLK_EN Set this bit to enable SPI2 clock. (R/W)

SYSTEM_I2C_EXT0_CLK_EN Set this bit to enable I2C_EXT0 clock. (R/W)

SYSTEM_UHCI0_CLK_EN Set this bit to enable UHCI0 clock. (R/W)

SYSTEM_RMT_CLK_EN Set this bit to enable RMT clock. (R/W)

SYSTEM_PCNT_CLK_EN Set this bit to enable PCNT clock. (R/W)

SYSTEM_LEDC_CLK_EN Set this bit to enable LEDC clock. (R/W)

SYSTEM_TIMERGROUP_CLK_EN Set this bit to enable TIMERGROUP0 clock. (R/W)

SYSTEM_TIMERGROUP1_CLK_EN Set this bit to enable TIMERGROUP1 clock. (R/W)

SYSTEM_SPI3_CLK_EN Set this bit to enable SPI3 clock. (R/W)

SYSTEM_PWM0_CLK_EN Set this bit to enable PWM0 clock. (R/W)

SYSTEM_I2C_EXT1_CLK_EN Set this bit to enable I2C_EXT1 clock. (R/W)

SYSTEM_CAN_CLK_EN Set this bit to enable CAN clock. (R/W)

SYSTEM_PWM1_CLK_EN Set this bit to enable PWM1 clock. (R/W)

SYSTEM_I2S1_CLK_EN Set this bit to enable I2S1 clock. (R/W)

SYSTEM_USB_CLK_EN Set this bit to enable USB clock. (R/W)

SYSTEM_UART_MEM_CLK_EN Set this bit to enable UART_MEM clock. (R/W)

SYSTEM_APB_SARADC_CLK_EN Set this bit to enable ADC controller clock. (R/W)

SYSTEM_SYSTIMER_CLK_EN Set this bit to enable SYSTEM TIMER clock. (R/W)

SYSTEM_ADC2_ARB_CLK_EN Set this bit to enable ADC2_ARB clock. (R/W)

Register 17.5. SYSTEM_PERIP_CLK_EN1_REG (0x001C)

(reserved)											SYSTEM_USB_DEVICE_CLK_EN SYSTEM_UART2_CLK_EN SYSTEM_LCD_CAM_CLK_EN SYSTEM_SDIO_HOST_CLK_EN SYSTEM_DMA_CLK_EN SYSTEM_CRYPT0_CLK_EN SYSTEM_CRYPT0_HMAC_CLK_EN SYSTEM_CRYPT0_DS_CLK_EN SYSTEM_CRYPT0_RSA_CLK_EN SYSTEM_CRYPT0_SHA_CLK_EN SYSTEM_PERI_BACKUP_CLK_EN														
31											11	10	9	8	7	6	5	4	3	2	1	0			
0											0	0	0	0	0	0	0	0	0	0	0	0	0	0	Reset

- SYSTEM_PERI_BACKUP_CLK_EN** Set this bit to enable peri backup clock. (R/W)
- SYSTEM_CRYPT0_AES_CLK_EN** Set this bit to enable AES clock. (R/W)
- SYSTEM_CRYPT0_SHA_CLK_EN** Set this bit to enable SHA clock. (R/W)
- SYSTEM_CRYPT0_RSA_CLK_EN** Set this bit to enable RSA clock. (R/W)
- SYSTEM_CRYPT0_DS_CLK_EN** Set this bit to enable DS clock. (R/W)
- SYSTEM_CRYPT0_HMAC_CLK_EN** Set this bit to enable HMAC clock. (R/W)
- SYSTEM_DMA_CLK_EN** Set this bit to enable DMA clock. (R/W)
- SYSTEM_SDIO_HOST_CLK_EN** Set this bit to enable SDIO_HOST clock. (R/W)
- SYSTEM_LCD_CAM_CLK_EN** Set this bit to enable LCD_CAM clock. (R/W)
- SYSTEM_UART2_CLK_EN** Set this bit to enable UART2 clock. (R/W)
- SYSTEM_USB_DEVICE_CLK_EN** Set this bit to enable USB_DEVICE clock. (R/W)

Register 17.6. SYSTEM_PERIP_RST_EN0_REG (0x0020)

31	30	29	28	27	25	24	23	22	21	20	19	18	17	16	15	14	13	12	11	10	9	8	7	6	5	4	3	2	1	0		
0	0	0	0	0	0	0	0	0	0	0	0	0	0	0	0	0	0	0	0	0	0	0	0	0	0	0	0	0	0	0	0	Reset

SYSTEM_SPI01_RST Set this bit to reset SPI01. (R/W)

SYSTEM_UART_RST Set this bit to reset UART. (R/W)

SYSTEM_I2S0_RST Set this bit to reset I2S0. (R/W)

SYSTEM_UART1_RST Set this bit to reset UART1. (R/W)

SYSTEM_SPI2_RST Set this bit to reset SPI2. (R/W)

SYSTEM_I2C_EXT0_RST Set this bit to reset I2C_EXT0. (R/W)

SYSTEM_UHCI0_RST Set this bit to reset UHCI0. (R/W)

SYSTEM_RMT_RST Set this bit to reset RMT. (R/W)

SYSTEM_PCNT_RST Set this bit to reset PCNT. (R/W)

SYSTEM_LEDC_RST Set this bit to reset LEDC. (R/W)

SYSTEM_TIMERGROUP_RST Set this bit to reset TIMERGROUP0. (R/W)

SYSTEM_TIMERGROUP1_RST Set this bit to reset TIMERGROUP1. (R/W)

SYSTEM_SPI3_RST Set this bit to reset SPI3. (R/W)

SYSTEM_PWM0_RST Set this bit to reset PWM0. (R/W)

SYSTEM_I2C_EXT1_RST Set this bit to reset I2C_EXT1. (R/W)

SYSTEM_CAN_RST Set this bit to reset CAN. (R/W)

SYSTEM_PWM1_RST Set this bit to reset PWM1. (R/W)

SYSTEM_I2S1_RST Set this bit to reset I2S1. (R/W)

SYSTEM_USB_RST Set this bit to reset USB. (R/W)

SYSTEM_UART_MEM_RST Set this bit to reset UART_MEM. (R/W)

SYSTEM_APB_SARADC_RST Set this bit to reset ADC controller. (R/W)

SYSTEM_SYSTIMER_RST Set this bit to reset SYSTIMER. (R/W)

SYSTEM_ADC2_ARB_RST Set this bit to reset ADC2_ARB. (R/W)

Register 17.7. SYSTEM_PERIP_RST_EN1_REG (0x0024)

(reserved)											SYSTEM_USB_DEVICE_RST SYSTEM_UART2_RST SYSTEM_LCD_CAM_RST SYSTEM_SDIO_HOST_RST SYSTEM_DMA_RST SYSTEM_CRYPTO_HMAC_RST SYSTEM_CRYPTO_DS_RST SYSTEM_CRYPTO_RSA_RST SYSTEM_CRYPTO_SHA_RST SYSTEM_PERI_BACKUP_RST											
31											11	10	9	8	7	6	5	4	3	2	1	0
0	0	0	0	0	0	0	0	0	0	0	0	0	0	1	1	1	1	1	1	1	1	0

SYSTEM_PERI_BACKUP_RST Set this bit to reset BACKUP. (R/W)

SYSTEM_CRYPTO_AES_RST Set this bit to reset CRYPTO_AES. (R/W)

SYSTEM_CRYPTO_SHA_RST Set this bit to reset CRYPTO_SHA. (R/W)

SYSTEM_CRYPTO_RSA_RST Set this bit to reset CRYPTO_RSA. (R/W)

SYSTEM_CRYPTO_DS_RST Set this bit to reset CRYPTO_DS. (R/W)

SYSTEM_CRYPTO_HMAC_RST Set this bit to reset CRYPTO_HMAC. (R/W)

SYSTEM_DMA_RST Set this bit to reset DMA. (R/W)

SYSTEM_SDIO_HOST_RST Set this bit to reset SDIO_HOST. (R/W)

SYSTEM_LCD_CAM_RST Set this bit to reset LCD_CAM. (R/W)

SYSTEM_UART2_RST Set this bit to reset UART2. (R/W)

SYSTEM_USB_DEVICE_RST Set this bit to reset USB_DEVICE. (R/W)

Register 17.10. SYSTEM_CPU_INTR_FROM_CPU_1_REG (0x0034)

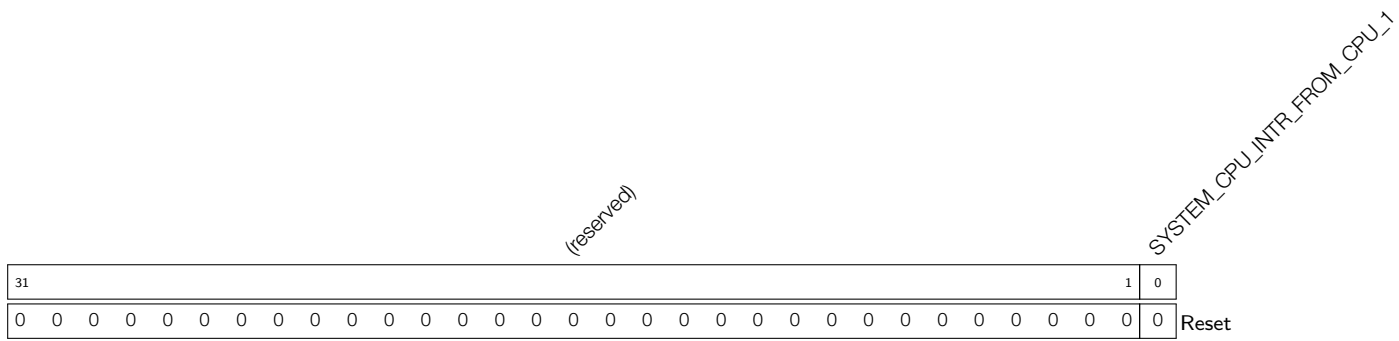

SYSTEM_CPU_INTR_FROM_CPU_1 Set this bit to generate CPU interrupt 1. This bit needs to be reset by software in the ISR process. (R/W)

Register 17.11. SYSTEM_CPU_INTR_FROM_CPU_2_REG (0x0038)

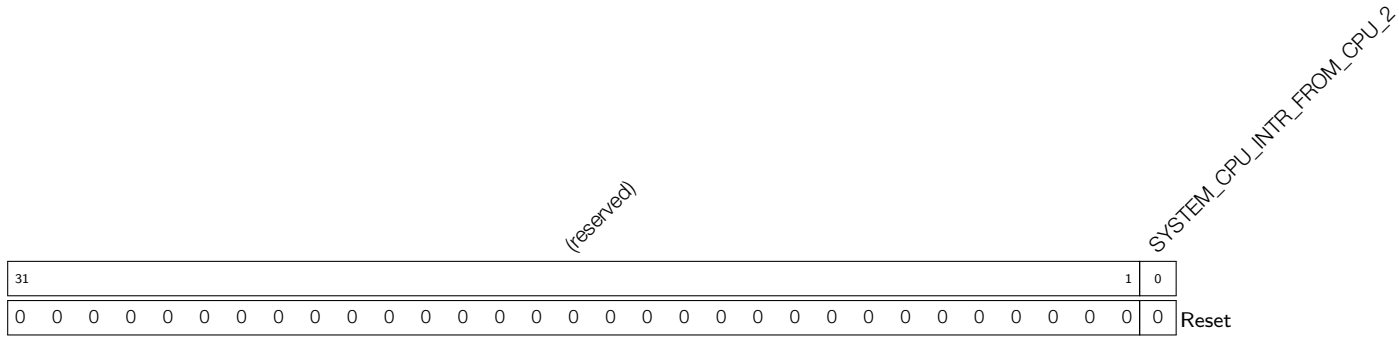

SYSTEM_CPU_INTR_FROM_CPU_2 Set this bit to generate CPU interrupt 2. This bit needs to be reset by software in the ISR process. (R/W)

Register 17.12. SYSTEM_CPU_INTR_FROM_CPU_3_REG (0x003C)

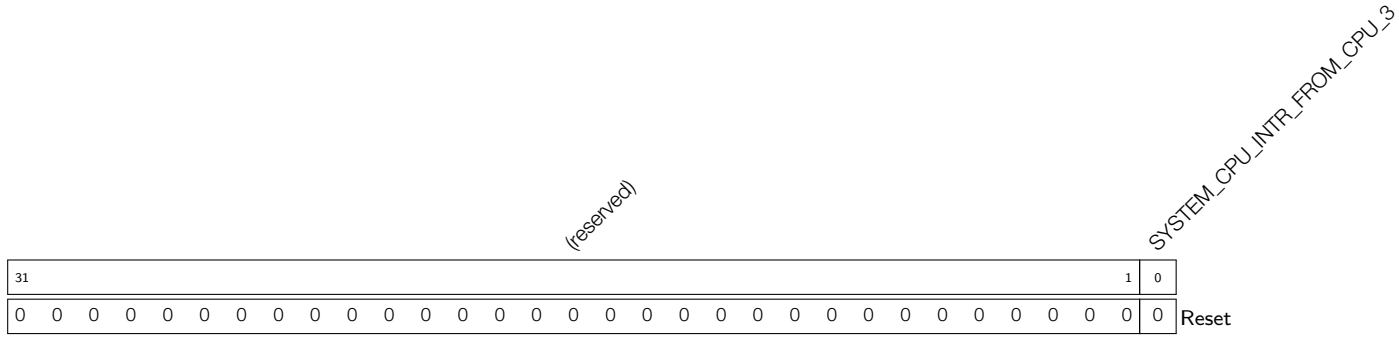

SYSTEM_CPU_INTR_FROM_CPU_3 Set this bit to generate CPU interrupt 3. This bit needs to be reset by software in the ISR process. (R/W)

Register 17.13. SYSTEM_RSA_PD_CTRL_REG (0x0040)

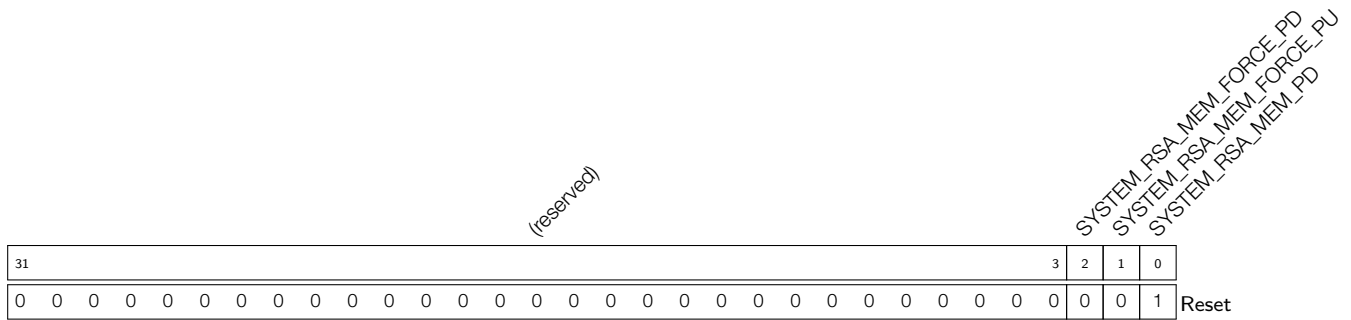

SYSTEM_RSA_MEM_PD Set this bit to send the RSA memory into retention state. This bit has the lowest priority, meaning it can be masked by the [SYSTEM_RSA_MEM_FORCE_PU](#) field. When Digital Signature occupies the RSA, this bit is invalid. (R/W)

SYSTEM_RSA_MEM_FORCE_PU Set this bit to force the RSA memory to work as normal when the chip enters light sleep. This bit has the second highest priority, meaning it overrides the [SYSTEM_RSA_MEM_PD](#) field. (R/W)

SYSTEM_RSA_MEM_FORCE_PD Set this bit to send the RSA memory into retention state. This bit has the highest priority, meaning it sends the RSA memory into retention state regardless of the [SYSTEM_RSA_MEM_FORCE_PU](#) field. (R/W)

Register 17.14. SYSTEM_EDMA_CTRL_REG (0x0044)

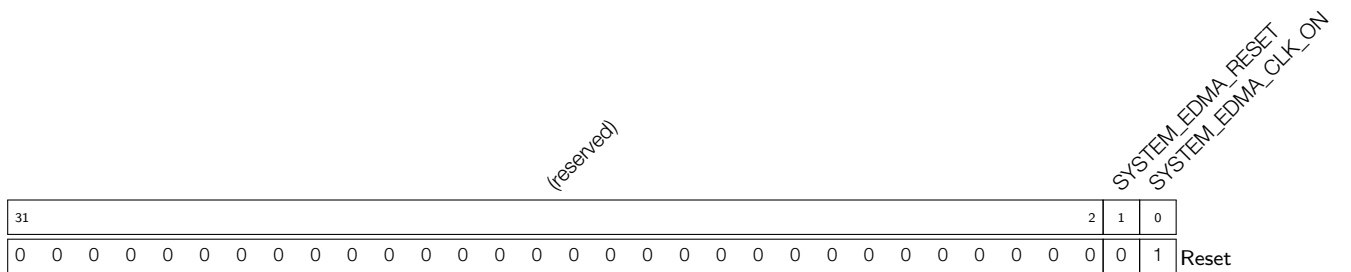

SYSTEM_EDMA_CLK_ON Set this bit to enable EDMA clock. (R/W)

SYSTEM_EDMA_RESET Set this bit to reset EDMA. (R/W)

Register 17.15. SYSTEM_CACHE_CONTROL_REG (0x0048)

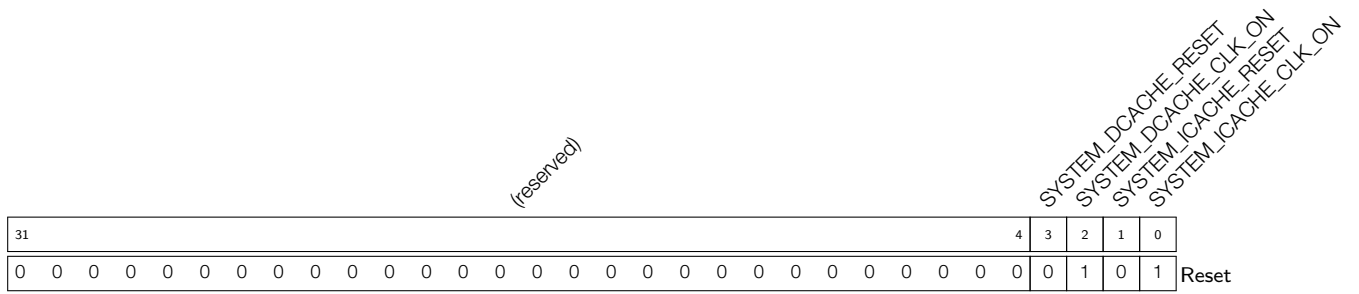

SYSTEM_ICACHE_CLK_ON Set this bit to enable i-cache clock. (R/W)

SYSTEM_ICACHE_RESET Set this bit to reset i-cache. (R/W)

SYSTEM_DCACHE_CLK_ON Set this bit to enable d-cache clock. (R/W)

SYSTEM_DCACHE_RESET Set this bit to reset d-cache. (R/W)

Register 17.16. SYSTEM_EXTERNAL_DEVICE_ENCRYPT_DECRYPT_CONTROL_REG (0x004C)

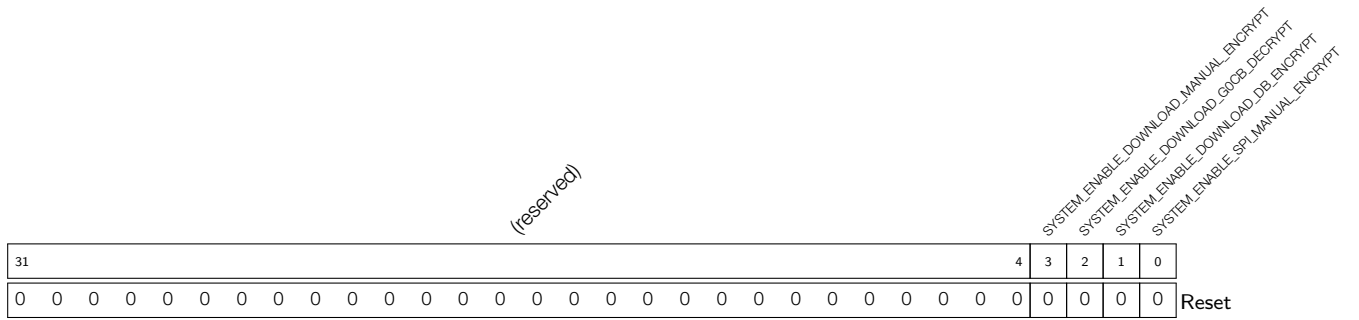

SYSTEM_ENABLE_SPI_MANUAL_ENCRYPT Set this bit to enable Manual Encryption under SPI Boot mode. (R/W)

SYSTEM_ENABLE_DOWNLOAD_DB_ENCRYPT Set this bit to enable Auto Encryption under Download Boot mode. (R/W)

SYSTEM_ENABLE_DOWNLOAD_G0CB_DECRYPT Set this bit to enable Auto Decryption under Download Boot mode. (R/W)

SYSTEM_ENABLE_DOWNLOAD_MANUAL_ENCRYPT Set this bit to enable Manual Encryption under Download Boot mode. (R/W)

Register 17.17. SYSTEM_RTC_FASTMEM_CONFIG_REG (0x0050)

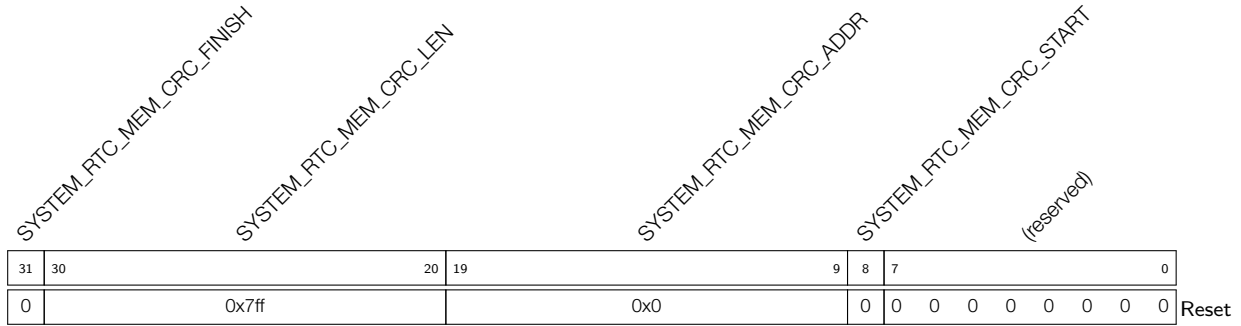

- SYSTEM_RTC_MEM_CRC_START** Set this bit to start the CRC of RTC memory (R/W)
- SYSTEM_RTC_MEM_CRC_ADDR** This field is used to set address of RTC memory for CRC. (R/W)
- SYSTEM_RTC_MEM_CRC_LEN** This field is used to set length of RTC memory for CRC based on start address. (R/W)
- SYSTEM_RTC_MEM_CRC_FINISH** This bit stores the status of RTC memory CRC. High level means finished while low level means not finished. (RO)

Register 17.18. SYSTEM_RTC_FASTMEM_CRC_REG (0x0054)

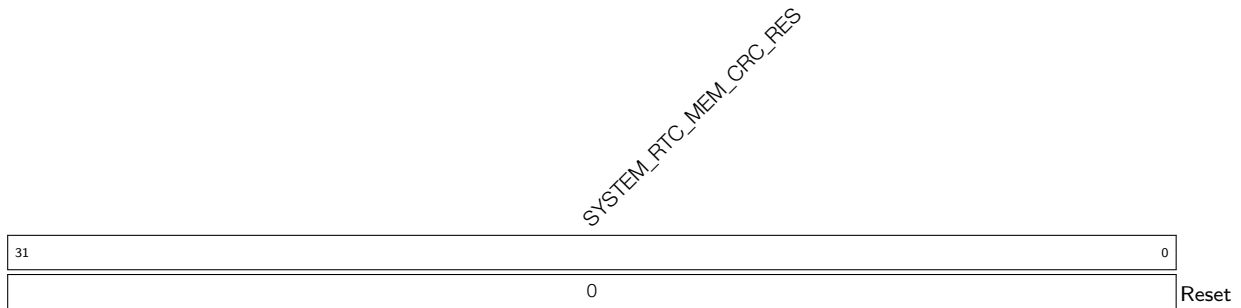

- SYSTEM_RTC_MEM_CRC_RES** This field stores the CRC result of RTC memory. (RO)

Register 17.19. SYSTEM_CLOCK_GATE_REG (0x005C)

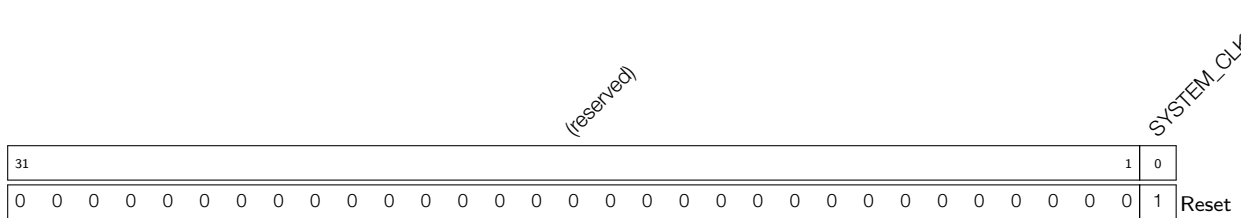

- SYSTEM_CLK_EN** Set this bit to enable the system clock. (R/W)

Register 17.20. SYSTEM_SYSCLK_CONF_REG (0x0060)

(reserved)										SYSTEM_CLK_XTAL_FREQ			SYSTEM_SOC_CLK_SEL		SYSTEM_PRE_DIV_CNT				
31									19	18			12	11	10	9			0
0 0 0 0 0 0 0 0 0 0										0			0		0x1				Reset

SYSTEM_PRE_DIV_CNT This field is used to set the count of prescaler of XTAL_CLK. For details, please refer to Table 7-4 in Chapter 7 *Reset and Clock*. (R/W)

SYSTEM_SOC_CLK_SEL This field is used to select SOC clock. For details, please refer to Table 7-2 in Chapter 7 *Reset and Clock*. (R/W)

SYSTEM_CLK_XTAL_FREQ This field is used to read XTAL frequency in MHz. (RO)

Register 17.21. SYSTEM_DATE_REG (0x0FFC)

(reserved)				SYSTEM_DATE													
31				28	27												0
0 0 0 0				0x2101220												Reset	

SYSTEM_DATE Version control register. (R/W)

Register 17.22. APB_CTRL_CLKGATE_FORCE_ON_REG (0x00A8)

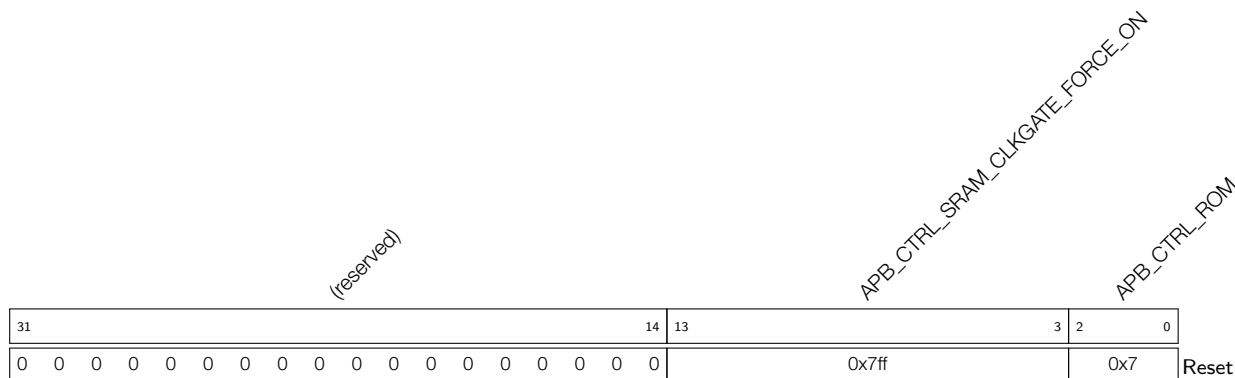

APB_CTRL_ROM_CLKGATE_FORCE_ON Set 1 to configure the ROM clock gate to be always on; Set 0 to configure the clock gate to turn on automatically when ROM is accessed and turn off automatically when ROM is not accessed. (R/W)

APB_CTRL_SRAM_CLKGATE_FORCE_ON Set 1 to configure the SRAM clock gate to be always on; Set 0 to configure the clock gate to turn on automatically when SRAM is accessed and turn off automatically when SRAM is not accessed. (R/W)

Register 17.23. APB_CTRL_MEM_POWER_DOWN_REG (0x00AC)

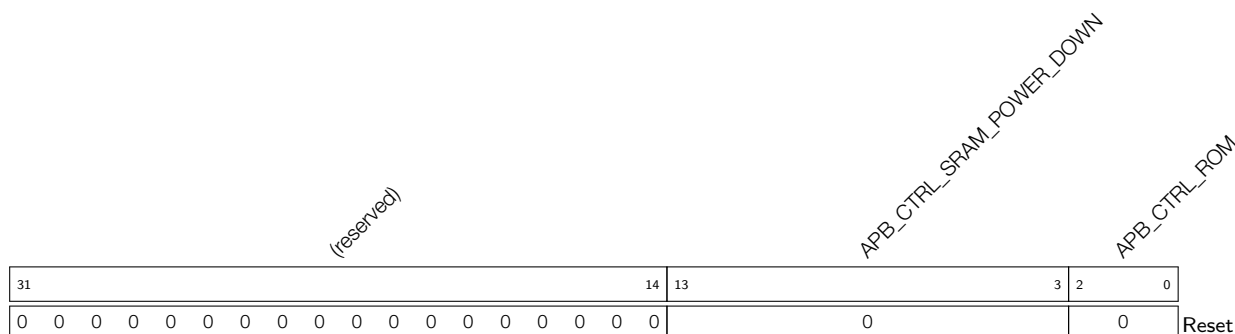

APB_CTRL_ROM_POWER_DOWN Set this field to send the internal ROM into retention state. (R/W)

APB_CTRL_SRAM_POWER_DOWN Set this field to send the internal SRAM into retention state. (R/W)

Register 17.24. APB_CTRL_MEM_POWER_UP_REG (0x00B0)

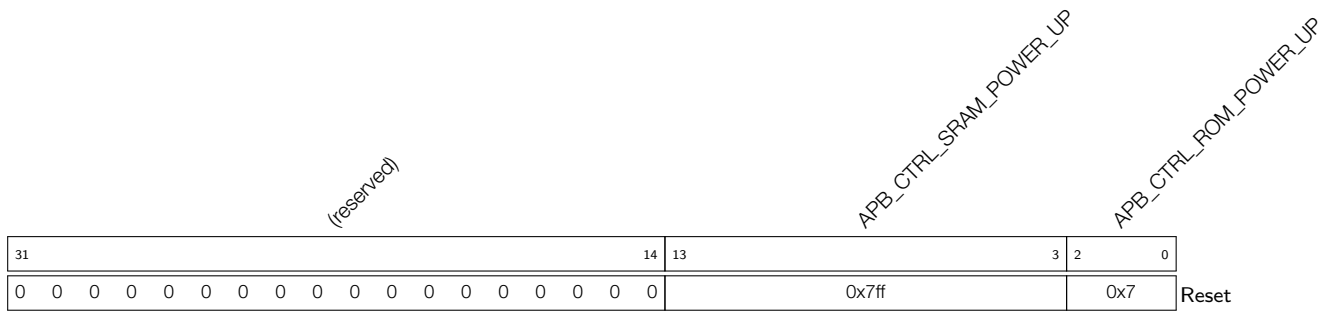

APB_CTRL_ROM_POWER_UP Set this field to force the internal ROM to work as normal (do not enter the retention state) when the chip enters light sleep. (R/W)

APB_CTRL_SRAM_POWER_UP Set this field to force the internal SRAM to work as normal (do not enter the retention state) when the chip enters light sleep. (R/W)

18 SHA Accelerator (SHA)

18.1 Introduction

ESP32-S3 integrates an SHA accelerator, which is a hardware device that speeds up SHA algorithm significantly, compared to SHA algorithm implemented solely in software. The SHA accelerator integrated in ESP32-S3 has two working modes, which are [Typical SHA](#) and [DMA-SHA](#).

18.2 Features

The following functionality is supported:

- All the hash algorithms introduced in [FIPS PUB 180-4 Spec](#).
 - SHA-1
 - SHA-224
 - SHA-256
 - SHA-384
 - SHA-512
 - SHA-512/224
 - SHA-512/256
 - SHA-512/*t*
- Two working modes
 - Typical SHA
 - DMA-SHA
- interleaved function when working in Typical SHA working mode
- Interrupt function when working in DMA-SHA working mode

18.3 Working Modes

The SHA accelerator integrated in ESP32-S3 has two working modes.

- [Typical SHA Working Mode](#): all the data is written and read via CPU directly.
- [DMA-SHA Working Mode](#): all the data is read via DMA. That is, users can configure the DMA controller to read all the data needed for hash operation, thus releasing CPU for completing other tasks.

Users can start the SHA accelerator with different working modes by configuring registers [SHA_START_REG](#) and [SHA_DMA_START_REG](#). For details, please see [Table 18-1](#).

Table 18-1. SHA Accelerator Working Mode

Working Mode	Configuration Method
Typical SHA	Set <code>SHA_START_REG</code> to 1
DMA-SHA	Set <code>SHA_DMA_START_REG</code> to 1

Users can choose hash algorithms by configuring the `SHA_MODE_REG` register. For details, please see Table 18-2.

Table 18-2. SHA Hash Algorithm Selection

Hash Algorithm	<code>SHA_MODE_REG</code> Configuration
SHA-1	0
SHA-224	1
SHA-256	2
SHA-384	3
SHA-512	4
SHA-512/224	5
SHA-512/256	6
SHA-512/ <i>t</i>	7

Notice:

ESP32-S3's [Digital Signature \(DS\)](#) and [HMAC Accelerator \(HMAC\)](#) modules also call the SHA accelerator. Therefore, users cannot access the SHA accelerator when these modules are working.

18.4 Function Description

SHA accelerator can generate the message digest via two steps: [Preprocessing](#) and [Hash operation](#).

18.4.1 Preprocessing

Preprocessing consists of three steps: [padding the message](#), [parsing the message into message blocks](#) and [setting the initial hash value](#).

18.4.1.1 Padding the Message

The SHA accelerator can only process message blocks of 512 or 1024 bits, depending on the algorithm. Thus, all the messages should be padded to a multiple of 512 or 1024 bits before the hash task.

Suppose that the length of the message M is m bits. Then M shall be padded as introduced below:

- **SHA-1, SHA-224 and SHA-256**

1. First, append the bit "1" to the end of the message;
2. Second, append k zero bits, where k is the smallest, non-negative solution to the equation $m + 1 + k \equiv 448 \pmod{512}$;
3. Last, append the 64-bit block of value equal to the number m expressed using a binary representation.

- **SHA-384, SHA-512, SHA-512/224, SHA-512/256 and SHA-512/t**
 1. First, append the bit “1” to the end of the message;
 2. Second, append k zero bits, where k is the smallest, non-negative solution to the equation $m + 1 + k \equiv 896 \pmod{1024}$;
 3. Last, append the 128-bit block of value equal to the number m expressed using a binary representation.

For more details, please refer to Section “5.1 Padding the Message” in [FIPS PUB 180-4 Spec](#).

18.4.1.2 Parsing the Message

The message and its padding must be parsed into N 512-bit or 1024-bit blocks.

- For **SHA-1, SHA-224 and SHA-256**: the message and its padding are parsed into N 512-bit blocks, $M^{(1)}$, $M^{(2)}$, ..., $M^{(N)}$. Since the 512 bits of the input block may be expressed as sixteen 32-bit words, the first 32 bits of message block i are denoted $M_0^{(i)}$, the next 32 bits are $M_1^{(i)}$, and so on up to $M_{15}^{(i)}$.
- For **SHA-384, SHA-512, SHA-512/224, SHA-512/256 and SHA-512/t**: the message and its padding are parsed into N 1024-bit blocks. Since the 1024 bits of the input block may be expressed as sixteen 64-bit words, the first 64 bits of message block i are denoted $M_0^{(i)}$, the next 64 bits are $M_1^{(i)}$, and so on up to $M_{15}^{(i)}$.

During the task, all the message blocks are written into the `SHA_M_n_REG`, following the rules below:

- For **SHA-1, SHA-224 and SHA-256**: $M_0^{(i)}$ is stored in `SHA_M_0_REG`, $M_1^{(i)}$ stored in `SHA_M_1_REG`, ..., and $M_{15}^{(i)}$ stored in `SHA_M_15_REG`.
- For **SHA-384, SHA-512, SHA-512/224 and SHA-512/256**: the most significant 32 bits and the least significant 32 bits of $M_0^{(i)}$ are stored in `SHA_M_0_REG` and `SHA_M_1_REG`, respectively, ..., the most significant 32 bits and the least significant 32 bits of $M_{15}^{(i)}$ are stored in `SHA_M_30_REG` and `SHA_M_31_REG`, respectively.

Note:

For more information about “message block”, please refer to Section “2.1 Glossary of Terms and Acronyms” in [FIPS PUB 180-4 Spec](#).

18.4.1.3 Initial Hash Value

Before hash task begins for each of the secure hash algorithms, the initial Hash value $H^{(0)}$ must be set based on different algorithms, among which the SHA-1, SHA-224, SHA-256, SHA-384, SHA-512, SHA-512/224, and SHA-512/256 algorithms use the initial Hash values (constant C) stored in the hardware.

However, SHA-512/t requires a distinct initial hash value for each operation for a given value of t . Simply put, SHA-512/t is the generic name for a t -bit hash function based on SHA-512 whose output is truncated to t bits. t is any positive integer without a leading zero such that $t < 512$, and t is not 384. The initial hash value for SHA-512/t for a given value of t can be calculated by performing SHA-512 from hexadecimal representation of the string “SHA-512/t”. It’s not hard to observe that when determining the initial hash values for SHA-512/t algorithms with different t , the only difference lies in the value of t .

Therefore, we have specially developed the following simplified method to calculate the initial hash value for SHA-512/t:

1. **Generate `t_string` and `t_length`:** `t_string` is a 32-bit data that stores the input message of t . `t_length` is a 7-bit data that stores the length of the input message. The `t_string` and `t_length` are generated in methods described below, depending on the value of t :

- If $1 \leq t \leq 9$, then $t_length = 7'h48$ and t_string is padded in the following format:

$8'h30 + 8'ht_0$	$1'b1$	$23'b0$
------------------	--------	---------

where $t_0 = t$.

For example, if $t = 8$, then $t_0 = 8$ and $t_string = 32'h38800000$.

- If $10 \leq t \leq 99$, then $t_length = 7'h50$ and t_string is padded in the following format:

$8'h30 + 8'ht_1$	$8'h30 + 8'ht_0$	$1'b1$	$15'b0$
------------------	------------------	--------	---------

where, $t_0 = t\%10$ and $t_1 = t/10$.

For example, if $t = 56$, then $t_0 = 6$, $t_1 = 5$, and $t_string = 32'h35368000$.

- If $100 \leq t < 512$, then $t_length = 7'h58$ and t_string is padded in the following format:

$8'h30 + 8'ht_2$	$8'h30 + 8'ht_1$	$8'h30 + 8'ht_0$	$1'b1$	$7'b0$
------------------	------------------	------------------	--------	--------

where, $t_0 = t\%10$, $t_1 = (t/10)\%10$, and $t_2 = t/100$.

For example, if $t = 231$, then $t_0 = 1$, $t_1 = 3$, $t_2 = 2$, and $t_string = 32'h32333180$.

2. **Initialize relevant registers:** Initialize `SHA_T_STRING_REG` and `SHA_T_LENGTH_REG` with the generated `t_string` and `t_length` in the previous step.
3. **Obtain initial hash value:** Set the `SHA_MODE_REG` register to 7. Set the `SHA_START_REG` register to 1 to start the SHA accelerator. Then poll register `SHA_BUSY_REG` until the content of this register becomes 0, indicating the calculation of initial hash value is completed.

Please note that the initial value for SHA-512/ t can be also calculated according to the Section “5.3.6 SHA-512/ t ” in [FIPS PUB 180-4 Spec](#), that is performing SHA-512 operation (with its initial hash value set to the result of 8-bitwise XOR operation of C and 0xa5) from the hexadecimal representation of the string “SHA-512/ t ”.

18.4.2 Hash task Process

After the preprocessing, the ESP32-S3 SHA accelerator starts to hash a message M and generates message digest of different lengths, depending on different hash algorithms. As described above, the ESP32-S3 SHA accelerator supports two working modes, which are [Typical SHA](#) and [DMA-SHA](#). The operation process for the SHA accelerator under two working modes is described in the following subsections.

18.4.2.1 Typical SHA Mode Process

Usually, the SHA accelerator will process all blocks of a message and produce a message digest before starting the next message digest.

However, ESP32-S3 SHA working in Typical SHA mode also supports optional “interleaved” message digest calculation. Users can insert new calculation (both Typical SHA and DMA-SHA) each time the SHA accelerator completes one message block. To be more specific, users can store the message digest in registers

[SHA_H_n_REG](#) after completing each message block, and assign the accelerator with other higher priority tasks. After the inserted calculation completes, users can put the message digest stored back to registers [SHA_H_n_REG](#), and resume the accelerator with the previously paused calculation.

Typical SHA Process (except for SHA-512/t)

1. Select a hash algorithm.
 - Configure the [SHA_MODE_REG](#) register based on Table 18-2.
2. Process the current message block ¹.
 - Write the message block in registers [SHA_M_n_REG](#).
3. Start the SHA accelerator.
 - If this is the first time to execute this step, set the [SHA_START_REG](#) register to 1 to start the SHA accelerator. In this case, the accelerator uses the initial hash value stored in hardware for a given algorithm configured in Step 1 to start the calculation;
 - If this is not the first time to execute this step², set the [SHA_CONTINUE_REG](#) register to 1 to start the SHA accelerator. In this case, the accelerator uses the hash value stored in the [SHA_H_n_REG](#) register to start calculation.
4. Check the progress of the current message block.
 - Poll register [SHA_BUSY_REG](#) until the content of this register becomes 0, indicating the accelerator has completed the calculation for the current message block and now is in the “idle” status ³.
5. Decide if you have more message blocks to process:
 - If yes, please go back to Step 2.
 - Otherwise, please continue.
6. Obtain the message digest.
 - Read the message digest from registers [SHA_H_n_REG](#).

Typical SHA Process (SHA-512/t)

1. Select a hash algorithm.
 - Configure the [SHA_MODE_REG](#) register to 7 for SHA-512/t.
2. Calculate the initial hash value.
 - (a) Calculate `t_string` and `t_length` and initialize [SHA_T_STRING_REG](#) and [SHA_T_LENGTH_REG](#) with the generated `t_string` and `t_length`. For details, please refer to Section 18.4.1.3.
 - (b) Set the [SHA_START_REG](#) register to 1 to start the SHA accelerator.
 - (c) Poll register [SHA_BUSY_REG](#) until the content of this register becomes 0, indicating the calculation of initial hash value is completed.
3. Process the current message block¹.
 - Write the message block in registers [SHA_M_n_REG](#).
4. Start the SHA accelerator

- Set the [SHA_CONTINUE_REG](#) register to 1. In this case, the accelerator uses the hash value stored in the [SHA_H_n_REG](#) register to start calculation.
5. Check the progress of the calculation.
 - Poll register [SHA_BUSY_REG](#) until the content of this register becomes 0, indicating the accelerator has completed the calculation for the current message block and now is in the “idle” status³.
 6. Decide if you have more message blocks to process:
 - If yes, please go back to Step 3.
 - Otherwise, please continue.
 7. Obtain the message digest.
 - Read the message digest from registers [SHA_H_n_REG](#).

Note:

1. In this step, the software can also write the next message block (to be processed) in registers [SHA_M_n_REG](#), if any, while the hardware starts SHA calculation, to save time.
2. You are resuming the SHA accelerator with the previously paused calculation.
3. Here you can decide if you want to insert other calculations. If yes, please go to the [process for interleaved calculations](#) for details.

As mentioned above, ESP32-S3 SHA accelerator supports “interleaving” calculation under the **Typical SHA working mode**.

The process to implement interleaved calculation is described below.

1. Prepare to hand the SHA accelerator over for an interleaved calculation by saving the following data of the previous calculation.
 - The selected hash algorithm stored in the [SHA_MODE_REG](#) register.
 - The message digest stored in registers [SHA_H_n_REG](#).
2. Perform the interleaved calculation. For the detailed process of the interleaved calculation, please refer to [Typical SHA process](#) or [DMA-SHA process](#), depending on the working mode of your interleaved calculation.
3. Prepare to hand the SHA accelerator back to the previously paused calculation by restoring the following data of the previous calculation.
 - Write the previously stored hash algorithm back to register [SHA_MODE_REG](#)
 - Write the previously stored message digest back to registers [SHA_H_n_REG](#)
4. Write the next message block from the previous paused calculation in registers [SHA_M_n_REG](#), and set the [SHA_CONTINUE_REG](#) register to 1 to restart the SHA accelerator with the previously paused calculation.

18.4.2.2 DMA-SHA Mode Process

ESP32-S3 SHA accelerator does not support “interleaving” message digest calculation when using the DMA, which means you cannot insert new calculation before the whole DMA-SHA process completes. In this case,

users who need inserted calculation are recommended to divide your message blocks and perform several DMA-SHA calculation, instead of trying to compute all the messages in one go.

In contrast to the Typical SHA working mode, when the SHA accelerator is working under the DMA-SHA mode, all data read are completed via DMA.

Therefore, users are required to configure the DMA controller following the description in Chapter 3 [GDMA Controller \(GDMA\)](#).

DMA-SHA process (except SHA-512/t)

1. Select a hash algorithm.
 - Select a hash algorithm by configuring the [SHA_MODE_REG](#) register. For details, please refer to Table 18-2.
2. Configure the [SHA_INT_ENA_REG](#) register to enable or disable interrupt (Set 1 to enable).
3. Configure the number of message blocks.
 - Write the number of message blocks M to the [SHA_DMA_BLOCK_NUM_REG](#) register.
4. Start the DMA-SHA calculation.
 - If the current DMA-SHA calculation follows a previous calculation, firstly write the message digest from the previous calculation to registers [SHA_H_n_REG](#), then write 1 to register [SHA_DMA_CONTINUE_REG](#) to start SHA accelerator;
 - Otherwise, write 1 to register [SHA_DMA_START_REG](#) to start the accelerator.
5. Wait till the completion of the DMA-SHA calculation, which happens when:
 - The content of [SHA_BUSY_REG](#) register becomes 0, or
 - An SHA interrupt occurs. In this case, please clear interrupt by writing 1 to the [SHA_INT_CLEAR_REG](#) register.
6. Obtain the message digest:
 - Read the message digest from registers [SHA_H_n_REG](#).

DMA-SHA process for SHA-512/t

1. Select a hash algorithm.
 - Select SHA-512/t algorithm by configuring the [SHA_MODE_REG](#) register to 7.
2. Configure the [SHA_INT_ENA_REG](#) register to enable or disable interrupt (Set 1 to enable).
3. Calculate the initial hash value.
 - (a) Calculate t_string and t_length and initialize [SHA_T_STRING_REG](#) and [SHA_T_LENGTH_REG](#) with the generated t_string and t_length . For details, please refer to Section 18.4.1.3.
 - (b) Set the [SHA_START_REG](#) register to 1 to start the SHA accelerator.
 - (c) Poll register [SHA_BUSY_REG](#) until the content of this register becomes 0, indicating the calculation of initial hash value is completed.
4. Configure the number of message blocks.

- Write the number of message blocks M to the [SHA_DMA_BLOCK_NUM_REG](#) register.
5. Start the DMA-SHA calculation.
 - Write 1 to register [SHA_DMA_CONTINUE_REG](#) to start the accelerator.
 6. Wait till the completion of the DMA-SHA calculation, which happens when:
 - The content of [SHA_BUSY_REG](#) register becomes 0, or
 - An SHA interrupt occurs. In this case, please clear interrupt by writing 1 to the [SHA_INT_CLEAR_REG](#) register.
 7. Obtain the message digest:
 - Read the message digest from registers [SHA_H_n_REG](#).

18.4.3 Message Digest

After the hash task completes, the SHA accelerator writes the message digest from the task to registers [SHA_H_n_REG](#) (n : 0~15). The lengths of the generated message digest are different depending on different hash algorithms. For details, see Table 18-6 below:

Table 18-6. The Storage and Length of Message digest from Different Algorithms

Hash Algorithm	Length of Message Digest (in bits)	Storage ¹
SHA-1	160	SHA_H_0_REG ~ SHA_H_4_REG
SHA-224	224	SHA_H_0_REG ~ SHA_H_6_REG
SHA-256	256	SHA_H_0_REG ~ SHA_H_7_REG
SHA-384	384	SHA_H_0_REG ~ SHA_H_11_REG
SHA-512	512	SHA_H_0_REG ~ SHA_H_15_REG
SHA-512/224	224	SHA_H_0_REG ~ SHA_H_6_REG
SHA-512/256	256	SHA_H_0_REG ~ SHA_H_7_REG
SHA-512/ t^2	t	SHA_H_0_REG ~ SHA_H_x_REG

¹ The message digest are stored in registers from most significant bits to the least significant bits, with the first word stored in register [SHA_H_0_REG](#) and the second word stored in register [SHA_H_1_REG](#)... For details, please see subsection 18.4.1.2.

² The registers used for SHA-512/ t algorithm depend on the value of t . $x+1$ indicates the number of 32-bit registers used to store t bits of message digest, so that $x = \text{roundup}(t/32) - 1$. For example:

- When $t = 8$, then $x = 0$, indicating that the 8-bit long message digest is stored in the most significant 8 bits of register [SHA_H_0_REG](#);
- When $t = 32$, then $x = 0$, indicating that the 32-bit long message digest is stored in register [SHA_H_0_REG](#);
- When $t = 132$, then $x = 4$, indicating that the 132-bit long message digest is stored in registers [SHA_H_0_REG](#), [SHA_H_1_REG](#), [SHA_H_2_REG](#), [SHA_H_3_REG](#), and [SHA_H_4_REG](#).

18.4.4 Interrupt

SHA accelerator supports interrupt on the completion of message digest calculation when working in the DMA-SHA mode. To enable this function, write 1 to register [SHA_INT_ENA_REG](#). Note that the interrupt should be cleared by software after use via setting the [SHA_INT_CLEAR_REG](#) register to 1.

18.5 Register Summary

The addresses in this section are relative to the SHA accelerator base address provided in Table 4-3 in Chapter 4 *System and Memory*.

The abbreviations given in Column **Access** are explained in Section [Access Types for Registers](#).

Name	Description	Address	Access
Control/Status registers			
SHA_CONTINUE_REG	Continues SHA operation (only effective in Typical SHA mode)	0x0014	WO
SHA_BUSY_REG	Indicates if SHA Accelerator is busy or not	0x0018	RO
SHA_DMA_START_REG	Starts the SHA accelerator for DMA-SHA operation	0x001C	WO
SHA_START_REG	Starts the SHA accelerator for Typical SHA operation	0x0010	WO
SHA_DMA_CONTINUE_REG	Continues SHA operation (only effective in DMA-SHA mode)	0x0020	WO
SHA_INT_CLEAR_REG	DMA-SHA interrupt clear register	0x0024	WO
SHA_INT_ENA_REG	DMA-SHA interrupt enable register	0x0028	R/W
Version Register			
SHA_DATE_REG	Version control register	0x002C	R/W
Configuration Registers			
SHA_MODE_REG	Defines the algorithm of SHA accelerator	0x0000	R/W
SHA_T_STRING_REG	String content register for calculating initial Hash Value (only effective for SHA-512/t)	0x0004	R/W
SHA_T_LENGTH_REG	String length register for calculating initial Hash Value (only effective for SHA-512/t)	0x0008	R/W
Memories			
SHA_DMA_BLOCK_NUM_REG	Block number register (only effective for DMA-SHA)	0x000C	R/W
SHA_H_0_REG	Hash value	0x0040	R/W
SHA_H_1_REG	Hash value	0x0044	R/W
SHA_H_2_REG	Hash value	0x0048	R/W
SHA_H_3_REG	Hash value	0x004C	R/W
SHA_H_4_REG	Hash value	0x0050	R/W
SHA_H_5_REG	Hash value	0x0054	R/W
SHA_H_6_REG	Hash value	0x0058	R/W
SHA_H_7_REG	Hash value	0x005C	R/W
SHA_H_8_REG	Hash value	0x0060	R/W
SHA_H_9_REG	Hash value	0x0064	R/W

Name	Description	Address	Access
SHA_H_10_REG	Hash value	0x0068	R/W
SHA_H_11_REG	Hash value	0x006C	R/W
SHA_H_12_REG	Hash value	0x0070	R/W
SHA_H_13_REG	Hash value	0x0074	R/W
SHA_H_14_REG	Hash value	0x0078	R/W
SHA_H_15_REG	Hash value	0x007C	R/W
SHA_M_0_REG	Message	0x0080	R/W
SHA_M_1_REG	Message	0x0084	R/W
SHA_M_2_REG	Message	0x0088	R/W
SHA_M_3_REG	Message	0x008C	R/W
SHA_M_4_REG	Message	0x0090	R/W
SHA_M_5_REG	Message	0x0094	R/W
SHA_M_6_REG	Message	0x0098	R/W
SHA_M_7_REG	Message	0x009C	R/W
SHA_M_8_REG	Message	0x00A0	R/W
SHA_M_9_REG	Message	0x00A4	R/W
SHA_M_10_REG	Message	0x00A8	R/W
SHA_M_11_REG	Message	0x00AC	R/W
SHA_M_12_REG	Message	0x00B0	R/W
SHA_M_13_REG	Message	0x00B4	R/W
SHA_M_14_REG	Message	0x00B8	R/W
SHA_M_15_REG	Message	0x00BC	R/W
SHA_M_16_REG	Message	0x00C0	R/W
SHA_M_17_REG	Message	0x00C4	R/W
SHA_M_18_REG	Message	0x00C8	R/W
SHA_M_19_REG	Message	0x00CC	R/W
SHA_M_20_REG	Message	0x00D0	R/W
SHA_M_21_REG	Message	0x00D4	R/W
SHA_M_22_REG	Message	0x00D8	R/W
SHA_M_23_REG	Message	0x00DC	R/W
SHA_M_24_REG	Message	0x00E0	R/W
SHA_M_25_REG	Message	0x00E4	R/W
SHA_M_26_REG	Message	0x00E8	R/W
SHA_M_27_REG	Message	0x00EC	R/W
SHA_M_28_REG	Message	0x00F0	R/W
SHA_M_29_REG	Message	0x00F4	R/W
SHA_M_30_REG	Message	0x00F8	R/W
SHA_M_31_REG	Message	0x00FC	R/W

18.6 Registers

The addresses in this section are relative to the SHA accelerator base address provided in Table 4-3 in Chapter 4 *System and Memory*.

Register 18.1. SHA_START_REG (0x0010)

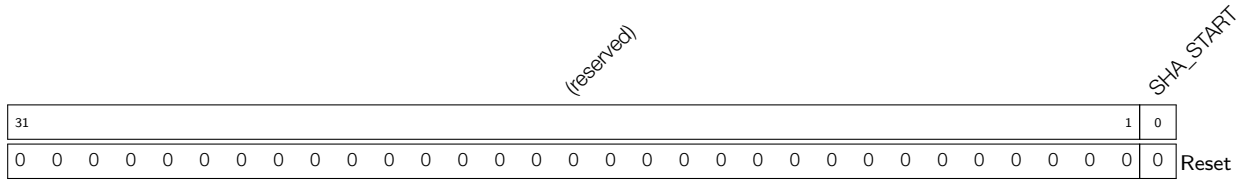

SHA_START Write 1 to start Typical SHA calculation. (WO)

Register 18.2. SHA_CONTINUE_REG (0x0014)

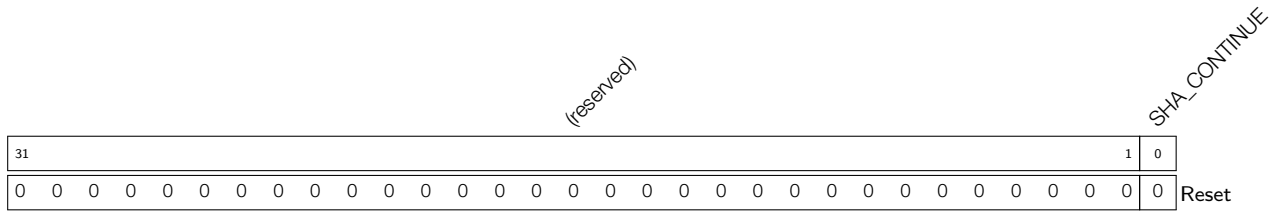

SHA_CONTINUE Write 1 to continue Typical SHA calculation. (WO)

Register 18.3. SHA_BUSY_REG (0x0018)

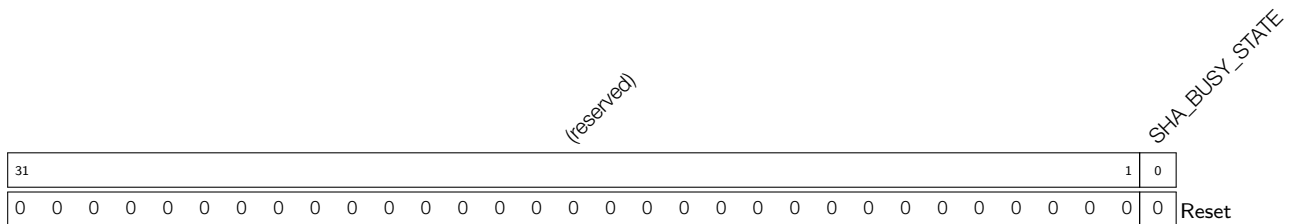

SHA_BUSY_STATE Indicates the states of SHA accelerator. (RO) 1'h0: idle 1'h1: busy

Register 18.4. SHA_DMA_START_REG (0x001C)

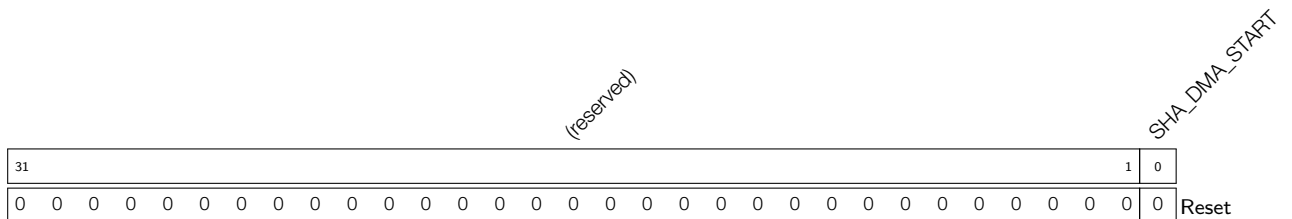

SHA_DMA_START Write 1 to start DMA-SHA calculation. (WO)

Register 18.5. SHA_DMA_CONTINUE_REG (0x0020)

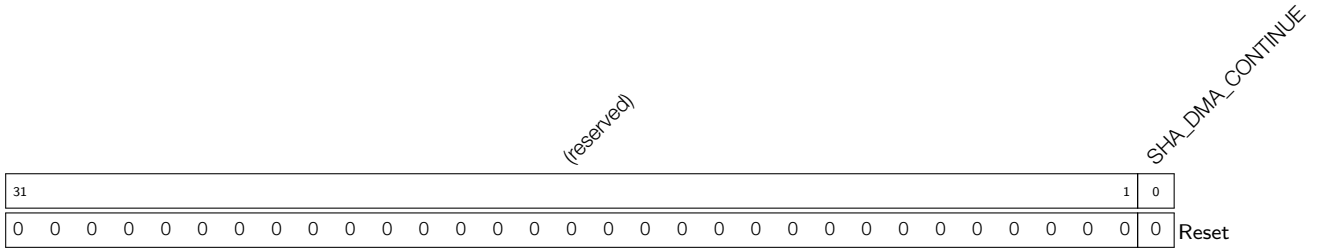

SHA_DMA_CONTINUE Write 1 to continue DMA-SHA calculation. (WO)

Register 18.6. SHA_INT_CLEAR_REG (0x0024)

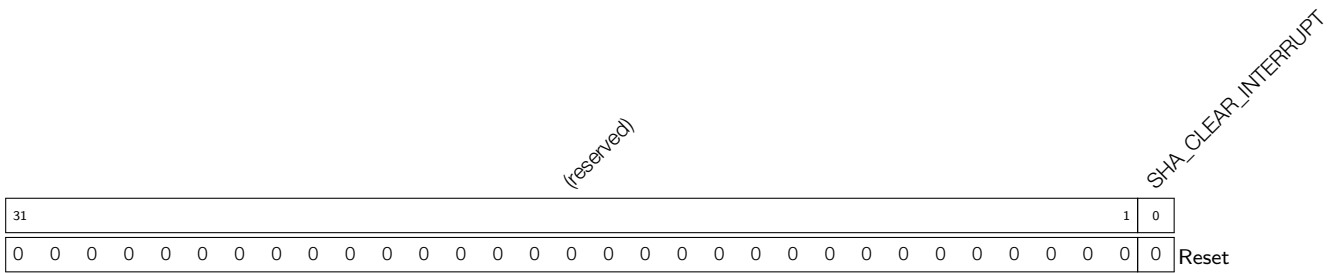

SHA_CLEAR_INTERRUPT Clears DMA-SHA interrupt. (WO)

Register 18.7. SHA_INT_ENA_REG (0x0028)

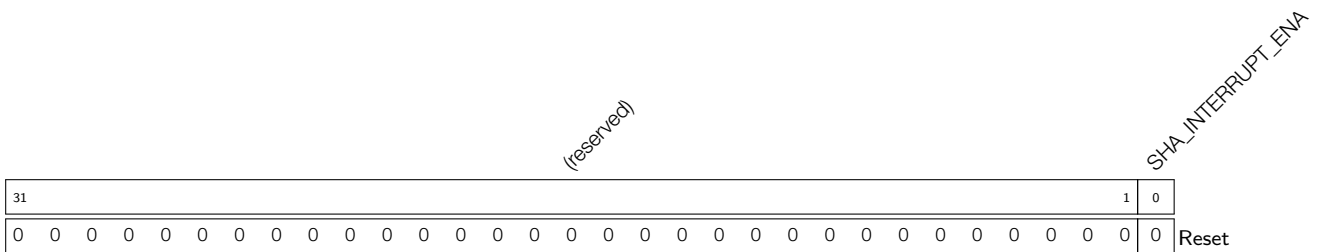

SHA_INTERRUPT_ENA Enables DMA-SHA interrupt. (R/W)

Register 18.8. SHA_DATE_REG (0x002C)

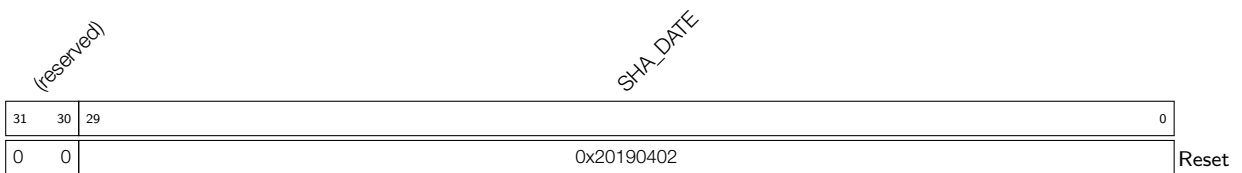

SHA_DATE Version control register. (R/W)

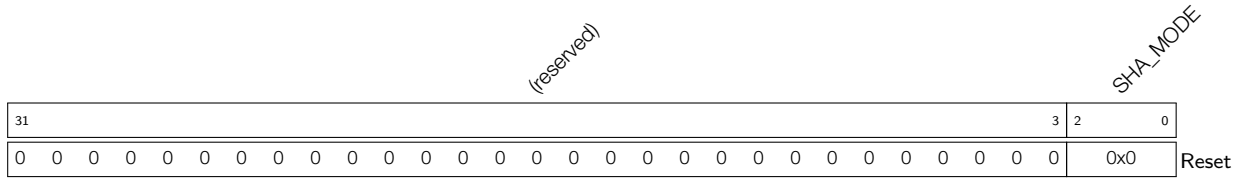
Register 18.9. SHA_MODE_REG (0x0000)

SHA_MODE Defines the SHA algorithm. For details, please see Table 18-2. (R/W)

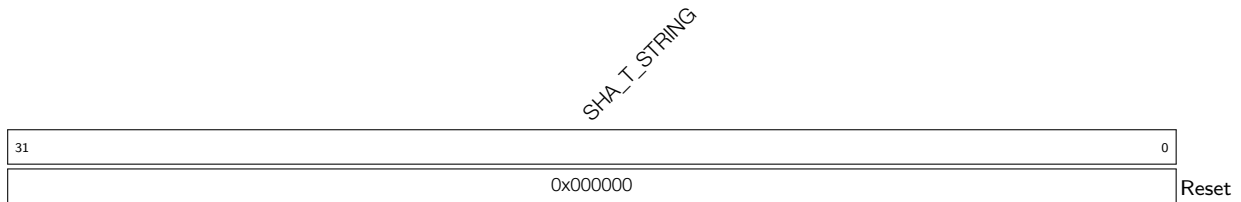
Register 18.10. SHA_T_STRING_REG (0x0004)

SHA_T_STRING Defines t_string for calculating the initial Hash value for SHA-512/t. (R/W)

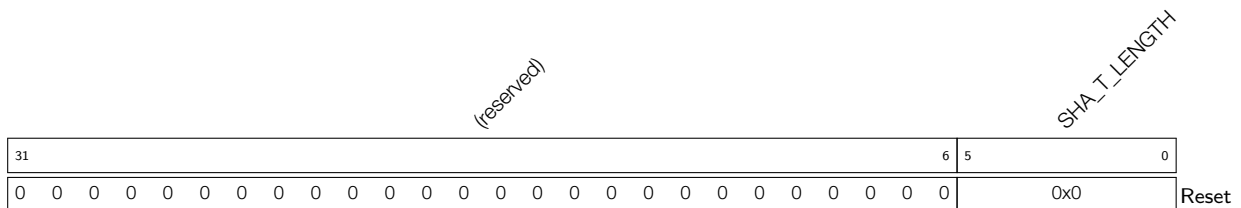
Register 18.11. SHA_T_LENGTH_REG (0x0008)

SHA_T_LENGTH Defines t_length for calculating the initial Hash value for SHA-512/t. (R/W)

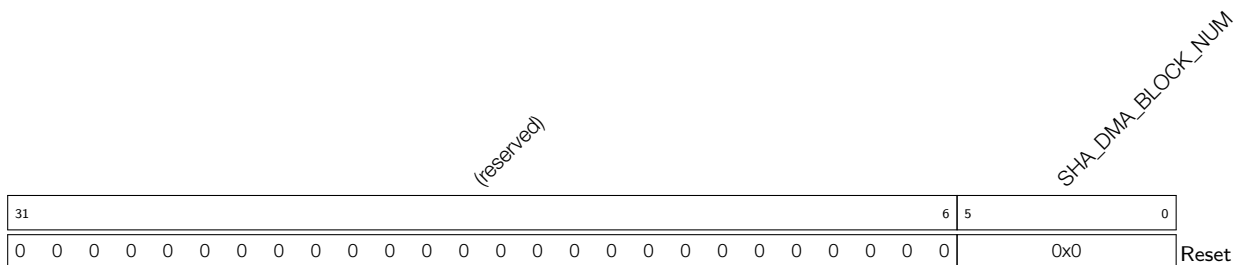
Register 18.12. SHA_DMA_BLOCK_NUM_REG (0x000C)

SHA_DMA_BLOCK_NUM Defines the DMA-SHA block number. (R/W)

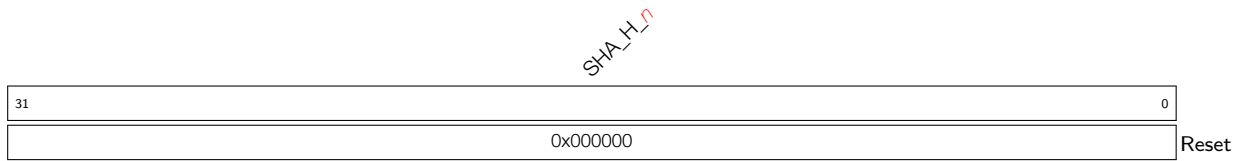
Register 18.13. SHA_H_n_REG (n: 0-15) (0x0040+4*n)

SHA_H_n Stores the *n*th 32-bit piece of the Hash value. (R/W)

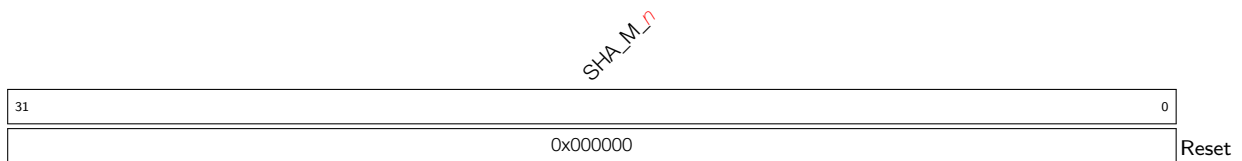
Register 18.14. SHA_M_n_REG (n: 0-31) (0x0080+4*n)

SHA_M_n Stores the *n*th 32-bit piece of the message. (R/W)

19 AES Accelerator (AES)

19.1 Introduction

ESP32-S3 integrates an Advanced Encryption Standard (AES) Accelerator, which is a hardware device that speeds up AES Algorithm significantly, compared to AES algorithms implemented solely in software. The AES Accelerator integrated in ESP32-S3 has two working modes, which are [Typical AES](#) and [DMA-AES](#).

19.2 Features

The following functionality is supported:

- Typical AES working mode
 - AES-128/AES-256 encryption and decryption
- DMA-AES working mode
 - AES-128/AES-256 encryption and decryption
 - Block cipher mode
 - * ECB (Electronic Codebook)
 - * CBC (Cipher Block Chaining)
 - * OFB (Output Feedback)
 - * CTR (Counter)
 - * CFB8 (8-bit Cipher Feedback)
 - * CFB128 (128-bit Cipher Feedback)
 - Interrupt on completion of computation

19.3 AES Working Modes

The AES Accelerator integrated in ESP32-S3 has two working modes, which are [Typical AES](#) and [DMA-AES](#).

- Typical AES Working Mode:
 - Supports encryption and decryption using cryptographic keys of 128 and 256 bits, specified in [NIST FIPS 197](#).

In this working mode, the plaintext and ciphertext is written and read via CPU directly.

- DMA-AES Working Mode:
 - Supports encryption and decryption using cryptographic keys of 128 and 256 bits, specified in [NIST FIPS 197](#);
 - Supports block cipher modes ECB/CBC/OFB/CTR/CFB8/CFB128 under [NIST SP 800-38A](#).

In this working mode, the plaintext and ciphertext is written and read via DMA. An interrupt will be generated when operation completes.

Users can choose the working mode for AES accelerator by configuring the [AES_DMA_ENABLE_REG](#) register according to Table 19-1 below.

Table 19-1. AES Accelerator Working Mode

AES_DMA_ENABLE_REG	Working Mode
0	Typical AES
1	DMA-AES

Users can choose the length of cryptographic keys and encryption / decryption by configuring the [AES_MODE_REG](#) register according to Table 19-2 below.

Table 19-2. Key Length and Encryption / Decryption

AES_MODE_REG [2:0]	Key Length and Encryption / Decryption
0	AES-128 encryption
1	reserved
2	AES-256 encryption
3	reserved
4	AES-128 decryption
5	reserved
6	AES-256 decryption
7	reserved

For detailed introduction on these two working modes, please refer to Section 19.4 and Section 19.5 below.

Notice: ESP32-S3's [Digital Signature \(DS\)](#) module will call the AES accelerator. Therefore, users cannot access the AES accelerator when [Digital Signature \(DS\)](#) module is working.

19.4 Typical AES Working Mode

In the Typical AES working mode, users can check the working status of the AES accelerator by inquiring the [AES_STATE_REG](#) register and comparing the return value against the Table 19-3 below.

Table 19-3. Working Status under Typical AES Working Mode

AES_STATE_REG	Status	Description
0	IDLE	The AES accelerator is idle or completed operation.
1	WORK	The AES accelerator is in the middle of an operation.

19.4.1 Key, Plaintext, and Ciphertext

The encryption or decryption key is stored in [AES_KEY_n_REG](#), which is a set of eight 32-bit registers.

- For AES-128 encryption/decryption, the 128-bit key is stored in [AES_KEY_0_REG](#) ~ [AES_KEY_3_REG](#).
- For AES-256 encryption/decryption, the 256-bit key is stored in [AES_KEY_0_REG](#) ~ [AES_KEY_7_REG](#).

The plaintext and ciphertext are stored in [AES_TEXT_IN_m_REG](#) and [AES_TEXT_OUT_m_REG](#), which are two sets of four 32-bit registers.

- For AES-128/AES-256 encryption, the [AES_TEXT_IN_m_REG](#) registers are initialized with plaintext. Then, the AES Accelerator stores the ciphertext into [AES_TEXT_OUT_m_REG](#) after operation.
- For AES-128/AES-256 decryption, the [AES_TEXT_IN_m_REG](#) registers are initialized with ciphertext. Then, the AES Accelerator stores the plaintext into [AES_TEXT_OUT_m_REG](#) after operation.

19.4.2 Endianness

Text Endianness

In Typical AES working mode, the AES Accelerator uses cryptographic keys to encrypt and decrypt data in blocks of 128 bits. When filling data into [AES_TEXT_IN_m_REG](#) register or reading result from [AES_TEXT_OUT_m_REG](#) registers, users should follow the text endianness type specified in Table 19-4.

Table 19-4. Text Endianness Type for Typical AES

		Plaintext/Ciphertext			
State ¹		c ²			
		0	1	2	3
r	0	AES_TEXT_x_0_REG[7:0]	AES_TEXT_x_1_REG[7:0]	AES_TEXT_x_2_REG[7:0]	AES_TEXT_x_3_REG[7:0]
	1	AES_TEXT_x_0_REG[15:8]	AES_TEXT_x_1_REG[15:8]	AES_TEXT_x_2_REG[15:8]	AES_TEXT_x_3_REG[15:8]
	2	AES_TEXT_x_0_REG[23:16]	AES_TEXT_x_1_REG[23:16]	AES_TEXT_x_2_REG[23:16]	AES_TEXT_x_3_REG[23:16]
	3	AES_TEXT_x_0_REG[31:24]	AES_TEXT_x_1_REG[31:24]	AES_TEXT_x_2_REG[31:24]	AES_TEXT_x_3_REG[31:24]

¹ The definition of “State (including c and r)” is described in Section 3.4 The State in [NIST FIPS 197](#).

² Where $x = \text{IN or OUT}$.

Key Endianness

In Typical AES working mode, When filling key into [AES_KEY_m_REG](#) registers, users should follow the key endianness type specified in Table 19-5 and Table 19-6.

Table 19-5. Key Endianness Type for AES-128 Encryption and Decryption

Bit ¹	w[0]	w[1]	w[2]	w[3] ²
[31:24]	AES_KEY_0_REG[7:0]	AES_KEY_1_REG[7:0]	AES_KEY_2_REG[7:0]	AES_KEY_3_REG[7:0]
[23:16]	AES_KEY_0_REG[15:8]	AES_KEY_1_REG[15:8]	AES_KEY_2_REG[15:8]	AES_KEY_3_REG[15:8]
[15:8]	AES_KEY_0_REG[23:16]	AES_KEY_1_REG[23:16]	AES_KEY_2_REG[23:16]	AES_KEY_3_REG[23:16]
[7:0]	AES_KEY_0_REG[31:24]	AES_KEY_1_REG[31:24]	AES_KEY_2_REG[31:24]	AES_KEY_3_REG[31:24]

¹ Column “Bit” specifies the bytes of each word stored in w[0] ~ w[3].

² w[0] ~ w[3] are “the first Nk words of the expanded key” as specified in Section 5.2 Key Expansion in [NIST FIPS 197](#).

Table 19-6. Key Endianness Type for AES-256 Encryption and Decryption

Bit ¹	w[0]	w[1]	w[2]	w[3]	w[4]	w[5]	w[6]	w[7] ²
[31:24]	AES_KEY_0_REG[7:0]	AES_KEY_1_REG[7:0]	AES_KEY_2_REG[7:0]	AES_KEY_3_REG[7:0]	AES_KEY_4_REG[7:0]	AES_KEY_5_REG[7:0]	AES_KEY_6_REG[7:0]	AES_KEY_7_REG[7:0]
[23:16]	AES_KEY_0_REG[15:8]	AES_KEY_1_REG[15:8]	AES_KEY_2_REG[15:8]	AES_KEY_3_REG[15:8]	AES_KEY_4_REG[15:8]	AES_KEY_5_REG[15:8]	AES_KEY_6_REG[15:8]	AES_KEY_7_REG[15:8]
[15:8]	AES_KEY_0_REG[23:16]	AES_KEY_1_REG[23:16]	AES_KEY_2_REG[23:16]	AES_KEY_3_REG[23:16]	AES_KEY_4_REG[23:16]	AES_KEY_5_REG[23:16]	AES_KEY_6_REG[23:16]	AES_KEY_7_REG[23:16]
[7:0]	AES_KEY_0_REG[31:24]	AES_KEY_1_REG[31:24]	AES_KEY_2_REG[31:24]	AES_KEY_3_REG[31:24]	AES_KEY_4_REG[31:24]	AES_KEY_5_REG[31:24]	AES_KEY_6_REG[31:24]	AES_KEY_7_REG[31:24]

¹ Column “Bit” specifies the bytes of each word stored in w[0] ~ w[7].

² w[0] ~ w[7] are “the first Nk words of the expanded key” as specified in Chapter 5.2 Key Expansion in [NIST FIPS 197](#).

19.4.3 Operation Process

Single Operation

1. Write 0 to the [AES_DMA_ENABLE_REG](#) register.
2. Initialize registers [AES_MODE_REG](#), [AES_KEY_n_REG](#), [AES_TEXT_IN_m_REG](#).
3. Start operation by writing 1 to the [AES_TRIGGER_REG](#) register.
4. Wait till the content of the [AES_STATE_REG](#) register becomes 0, which indicates the operation is completed.
5. Read results from the [AES_TEXT_OUT_m_REG](#) register.

Consecutive Operations

In consecutive operations, primarily the input [AES_TEXT_IN_m_REG](#) and output [AES_TEXT_OUT_m_REG](#) registers are being written and read, while the content of [AES_DMA_ENABLE_REG](#), [AES_MODE_REG](#), [AES_KEY_n_REG](#) is kept unchanged. Therefore, the initialization can be simplified during the consecutive operation.

1. Write 0 to the [AES_DMA_ENABLE_REG](#) register before starting the first operation.
2. Initialize registers [AES_MODE_REG](#) and [AES_KEY_n_REG](#) before starting the first operation.
3. Update the content of [AES_TEXT_IN_m_REG](#).
4. Start operation by writing 1 to the [AES_TRIGGER_REG](#) register.
5. Wait till the content of the [AES_STATE_REG](#) register becomes 0, which indicates the operation completes.
6. Read results from the [AES_TEXT_OUT_m_REG](#) register, and return to Step 3 to continue the next operation.

19.5 DMA-AES Working Mode

In the DMA-AES working mode, the AES accelerator supports six block cipher modes including ECB/CBC/OFB/CTR/CFB8/CFB128. Users can choose the block cipher mode by configuring the [AES_BLOCK_MODE_REG](#) register according to Table 19-7 below.

Table 19-7. Block Cipher Mode

AES_BLOCK_MODE_REG [2:0]	Block Cipher Mode
0	ECB (Electronic Codebook)
1	CBC (Cipher Block Chaining)
2	OFB (Output Feedback)
3	CTR (Counter)
4	CFB8 (8-bit Cipher Feedback)
5	CFB128 (128-bit Cipher Feedback)
6	reserved
7	reserved

Users can check the working status of the AES accelerator by inquiring the [AES_STATE_REG](#) register and comparing the return value against the Table 19-8 below.

Table 19-8. Working Status under DMA-AES Working mode

AES_STATE_REG[1:0]	Status	Description
0	IDLE	The AES accelerator is idle.
1	WORK	The AES accelerator is in the middle of an operation.
2	DONE	The AES accelerator completed operations.

When working in the DMA-AES working mode, the AES accelerator supports interrupt on the completion of computation. To enable this function, write 1 to the [AES_INT_ENA_REG](#) register. By default, the interrupt function is disabled. Also, note that the interrupt should be cleared by software after use.

19.5.1 Key, Plaintext, and Ciphertext

Block Operation

During the block operations, the AES Accelerator reads source data from DMA, and write result data to DMA after the computation.

- For encryption, DMA reads plaintext from memory, then passes it to AES as source data. After computation, AES passes ciphertext as result data back to DMA to write into memory.
- For decryption, DMA reads ciphertext from memory, then passes it to AES as source data. After computation, AES passes plaintext as result data back to DMA to write into memory.

During block operations, the lengths of the source data and result data are the same. The total computation time is reduced because the DMA data operation and AES computation can happen concurrently.

The length of source data for AES Accelerator under DMA-AES working mode must be 128 bits or the integral multiples of 128 bits. Otherwise, trailing zeros will be added to the original source data, so the length of source data equals to the nearest integral multiples of 128 bits. Please see details in [Table 19-9](#) below.

Table 19-9. TEXT-PADDING

Function : TEXT-PADDING()	
Input	: X , bit string.
Output	: $Y = \text{TEXT-PADDING}(X)$, whose length is the nearest integral multiples of 128 bits.
Steps	
Let us assume that X is a data-stream that can be split into n parts as following:	
$X = X_1 X_2 \dots X_{n-1} X_n$	
Here, the lengths of X_1, X_2, \dots, X_{n-1} all equal to 128 bits, and the length of X_n is t ($0 \leq t \leq 127$).	
If $t = 0$, then	
$\text{TEXT-PADDING}(X) = X;$	
If $0 < t \leq 127$, define a 128-bit block, X_n^* , and let $X_n^* = X_n 0^{128-t}$, then	
$\text{TEXT-PADDING}(X) = X_1 X_2 \dots X_{n-1} X_n^* = X 0^{128-t}$	

19.5.2 Endianness

Under the DMA-AES working mode, the transmission of source data and result data for AES Accelerator is solely controlled by DMA. Therefore, the AES Accelerator cannot control the Endianness of the source data and result

data, but does have requirement on how these data should be stored in memory and on the length of the data.

For example, let us assume DMA needs to write the following data into memory at address 0x0280.

- Data represented in hexadecimal:
 - 0102030405060708090A0B0C0D0E0F101112131415161718191A1B1C1D1E1F20
- Data Length:
 - Equals to 2 blocks.

Then, this data will be stored in memory as shown in Table 19-10 below.

Table 19-10. Text Endianness for DMA-AES

Address	Byte	Address	Byte	Address	Byte	Address	Byte
0x0280	0x01	0x0281	0x02	0x0282	0x03	0x0283	0x04
0x0284	0x05	0x0285	0x06	0x0286	0x07	0x0287	0x08
0x0288	0x09	0x0289	0x0A	0x028A	0x0B	0x028B	0x0C
0x028C	0x0D	0x028D	0x0E	0x028E	0x0F	0x028F	0x10
0x0290	0x11	0x0291	0x12	0x0292	0x13	0x0293	0x14
0x0294	0x15	0x0295	0x16	0x0296	0x17	0x0297	0x18
0x0298	0x19	0x0299	0x1A	0x029A	0x1B	0x029B	0x1C
0x029C	0x1D	0x029D	0x1E	0x029E	0x1F	0x029F	0x20

DMA can access both internal memory and PSRAM outside ESP32-S3. When you use DMA to access external PSRAM, please use base addresses that meet the requirements for DMA. When you use DMA to access internal memory, base addresses do not have such requirements. Details can be found in Chapter 3 *GDMA Controller (GDMA)*.

19.5.3 Standard Incrementing Function

AES accelerator provides two Standard Incrementing Functions for the CTR block operation, which are INC_{32} and INC_{128} Standard Incrementing Functions. By setting the `AES_INC_SEL_REG` register to 0 or 1, users can choose the INC_{32} or INC_{128} functions respectively. For details on the Standard Incrementing Function, please see Chapter B.1 The Standard Incrementing Function in [NIST SP 800-38A](#).

19.5.4 Block Number

Register `AES_BLOCK_NUM_REG` stores the Block Number of plaintext P or ciphertext C . The length of this register equals to $\text{length}(\text{TEXT-PADDING}(P))/128$ or $\text{length}(\text{TEXT-PADDING}(C))/128$. The AES Accelerator only uses this register when working in the DMA-AES mode.

19.5.5 Initialization Vector

`AES_IV_MEM` is a 16-byte memory, which is only available for AES Accelerator working in block operations. For CBC/OFB/CFB8/CFB128 operations, the `AES_IV_MEM` memory stores the Initialization Vector (IV). For the CTR operation, the `AES_IV_MEM` memory stores the Initial Counter Block (ICB).

Both IV and ICB are 128-bit strings, which can be divided into Byte0, Byte1, Byte2 . . . Byte15 (from left to right). [AES_IV_MEM](#) stores data following the Endianness pattern presented in Table 19-10, i.e. the most significant (i.e., left-most) byte Byte0 is stored at the lowest address while the least significant (i.e., right-most) byte Byte15 at the highest address.

For more details on IV and ICB, please refer to [NIST SP 800-38A](#).

19.5.6 Block Operation Process

1. Select one of DMA channels to connect with AES, configure the DMA chained list, and then start DMA. For details, please refer to Chapter 3 *GDMA Controller (GDMA)*.
2. Initialize the AES accelerator-related registers:
 - Write 1 to the [AES_DMA_ENABLE_REG](#) register.
 - Configure the [AES_INT_ENA_REG](#) register to enable or disable the interrupt function.
 - Initialize registers [AES_MODE_REG](#) and [AES_KEY_n_REG](#).
 - Select block cipher mode by configuring the [AES_BLOCK_MODE_REG](#) register. For details, see Table 19-7.
 - Initialize the [AES_BLOCK_NUM_REG](#) register. For details, see Section 19.5.4.
 - Initialize the [AES_INC_SEL_REG](#) register (only needed when AES Accelerator is working under CTR block operation).
 - Initialize the [AES_IV_MEM](#) memory (This is always needed except for ECB block operation).
3. Start operation by writing 1 to the [AES_TRIGGER_REG](#) register.
4. Wait for the completion of computation, which happens when the content of [AES_STATE_REG](#) becomes 2 or the AES interrupt occurs.
5. Check if DMA completes data transmission from AES to memory. At this time, DMA had already written the result data in memory, which can be accessed directly. For details on DMA, please refer to Chapter 3 *GDMA Controller (GDMA)*.
6. Clear interrupt by writing 1 to the [AES_INT_CLR_REG](#) register, if any AES interrupt occurred during the computation.
7. Release the AES Accelerator by writing 0 to the [AES_DMA_EXIT_REG](#) register. After this, the content of the [AES_STATE_REG](#) register becomes 0. Note that, you can release DMA earlier, but only after Step 4 is completed.

19.6 Memory Summary

The addresses in this section are relative to the AES accelerator base address provided in Table 4-3 in Chapter 4 *System and Memory*.

The abbreviations given in Column **Access** are explained in Section [Access Types for Registers](#).

Name	Description	Size (byte)	Starting Address	Ending Address	Access
AES_IV_MEM	Memory IV	16 bytes	0x0050	0x005F	R/W

19.7 Register Summary

The addresses in this section are relative to the AES accelerator base address provided in Table 4-3 in Chapter 4 *System and Memory*.

The abbreviations given in Column **Access** are explained in Section [Access Types for Registers](#).

Name	Description	Address	Access
Key Registers			
AES_KEY_0_REG	AES key register 0	0x0000	R/W
AES_KEY_1_REG	AES key register 1	0x0004	R/W
AES_KEY_2_REG	AES key register 2	0x0008	R/W
AES_KEY_3_REG	AES key register 3	0x000C	R/W
AES_KEY_4_REG	AES key register 4	0x0010	R/W
AES_KEY_5_REG	AES key register 5	0x0014	R/W
AES_KEY_6_REG	AES key register 6	0x0018	R/W
AES_KEY_7_REG	AES key register 7	0x001C	R/W
TEXT_IN Registers			
AES_TEXT_IN_0_REG	Source data register 0	0x0020	R/W
AES_TEXT_IN_1_REG	Source data register 1	0x0024	R/W
AES_TEXT_IN_2_REG	Source data register 2	0x0028	R/W
AES_TEXT_IN_3_REG	Source data register 3	0x002C	R/W
TEXT_OUT Registers			
AES_TEXT_OUT_0_REG	Result data register 0	0x0030	RO
AES_TEXT_OUT_1_REG	Result data register 1	0x0034	RO
AES_TEXT_OUT_2_REG	Result data register 2	0x0038	RO
AES_TEXT_OUT_3_REG	Result data register 3	0x003C	RO
Configuration Registers			
AES_MODE_REG	Defines key length and encryption / decryption	0x0040	R/W
AES_DMA_ENABLE_REG	Selects the working mode of the AES accelerator	0x0090	R/W
AES_BLOCK_MODE_REG	Defines the block cipher mode	0x0094	R/W
AES_BLOCK_NUM_REG	Block number configuration register	0x0098	R/W
AES_INC_SEL_REG	Standard incrementing function register	0x009C	R/W
Controlling / Status Registers			
AES_TRIGGER_REG	Operation start controlling register	0x0048	WO
AES_STATE_REG	Operation status register	0x004C	RO
AES_DMA_EXIT_REG	Operation exit controlling register	0x00B8	WO
Interrupt Registers			
AES_INT_CLR_REG	DMA-AES interrupt clear register	0x00AC	WO
AES_INT_ENA_REG	DMA-AES interrupt enable register	0x00B0	R/W

19.8 Registers

The addresses in this section are relative to the AES accelerator base address provided in Table 4-3 in Chapter 4 *System and Memory*.

Register 19.1. AES_KEY_n_REG ($n: 0-7$) ($0x0000+4*n$)

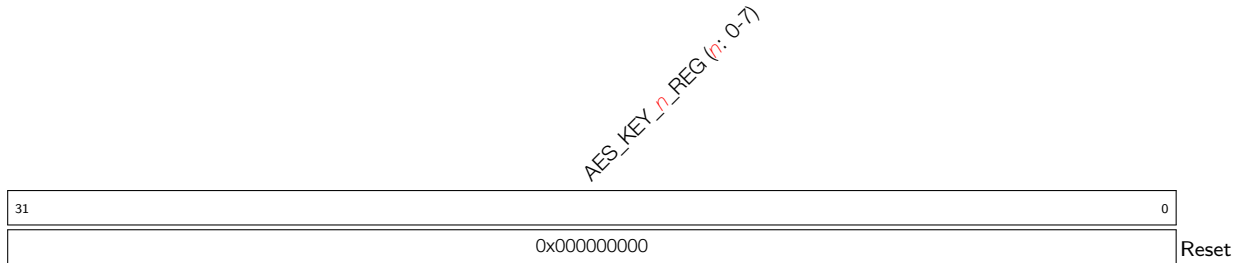

AES_KEY_n_REG ($n: 0-7$) Stores AES keys. (R/W)

Register 19.2. AES_TEXT_IN_m_REG ($m: 0-3$) ($0x0020+4*m$)

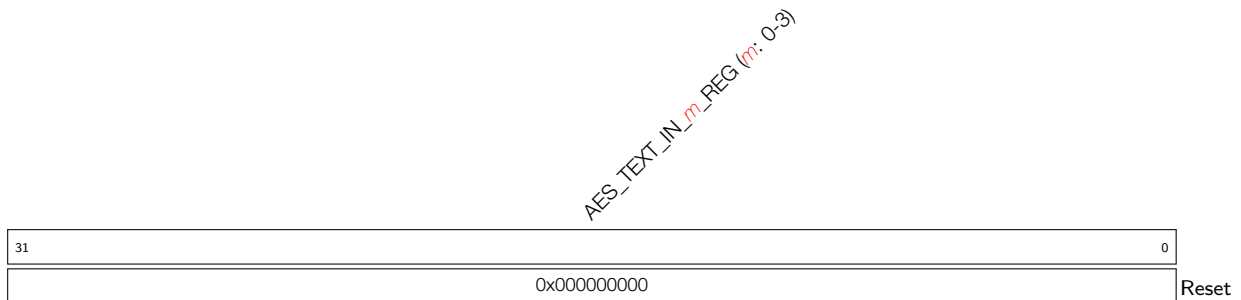

AES_TEXT_IN_m_REG ($m: 0-3$) Stores the source data when the AES Accelerator operates in the Typical AES working mode. (R/W)

Register 19.3. AES_TEXT_OUT_m_REG ($m: 0-3$) ($0x0030+4*m$)

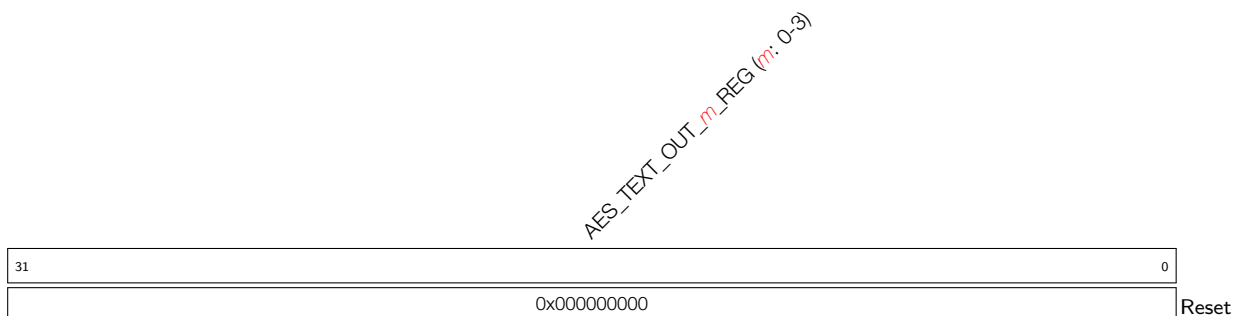

AES_TEXT_OUT_m_REG ($m: 0-3$) Stores the result data when the AES Accelerator operates in the Typical AES working mode. (RO)

Register 19.4. AES_MODE_REG (0x0040)

31	(reserved)	3	2	0	
0x00000000				0	Reset

AES_MODE Defines the key length and encryption / decryption of the AES Accelerator. For details, see Table 19-2. (R/W)

Register 19.5. AES_DMA_ENABLE_REG (0x0090)

31	(reserved)	1	0		
0x00000000				0	Reset

AES_DMA_ENABLE Defines the working mode of the AES Accelerator. 0: Typical AES, 1: DMA-AES. For details, see Table 19-1. (R/W)

Register 19.6. AES_BLOCK_MODE_REG (0x0094)

31	(reserved)	3	2	0	
0x00000000				0	Reset

AES_BLOCK_MODE Defines the block cipher mode of the AES Accelerator operating under the DMA-AES working mode. For details, see Table 19-7. (R/W)

Register 19.7. AES_BLOCK_NUM_REG (0x0098)

31	(reserved)	0	
0x00000000			Reset

AES_BLOCK_NUM Stores the Block Number of plaintext or ciphertext when the AES Accelerator operates under the DMA-AES working mode. For details, see Section 19.5.4. (R/W)

Register 19.8. AES_INC_SEL_REG (0x009C)

31	(reserved)	1	0	AES_INC_SEL
0x00000000				
				Reset

AES_INC_SEL Defines the Standard Incrementing Function for CTR block operation. Set this bit to 0 or 1 to choose INC₃₂ or INC₁₂₈. (R/W)

Register 19.9. AES_TRIGGER_REG (0x0048)

31	(reserved)	1	0	AES_TRIGGER
0x00000000				
				Reset

AES_TRIGGER Set this bit to 1 to start AES operation. (WO)

Register 19.10. AES_STATE_REG (0x004C)

31	(reserved)	2	1	0	AES_STATE
0x00000000				0x0	
				Reset	

AES_STATE Stores the working status of the AES Accelerator. For details, see Table 19-3 for Typical AES working mode and Table 19-8 for DMA AES working mode. (RO)

Register 19.11. AES_DMA_EXIT_REG (0x00B8)

31	(reserved)	1	0	AES_DMA_EXIT
0x00000000				
				Reset

AES_DMA_EXIT Set this bit to 1 to exit AES operation. This register is only effective for DMA-AES operation. (WO)

Register 19.12. AES_INT_CLR_REG (0x00AC)

31	<i>(reserved)</i>	1	0	<i>AES_INT_CLR</i>
0x00000000			x	

AES_INT_CLR Set this bit to 1 to clear AES interrupt. (WO)

Register 19.13. AES_INT_ENA_REG (0x00B0)

31	<i>(reserved)</i>	1	0	<i>AES_INT_ENA</i>
0x00000000			0	

AES_INT_ENA Set this bit to 1 to enable AES interrupt and 0 to disable interrupt. (R/W)

20 RSA Accelerator (RSA)

20.1 Introduction

The RSA Accelerator provides hardware support for high precision computation used in various RSA asymmetric cipher algorithms by significantly reducing their software complexity. Compared with RSA algorithms implemented solely in software, this hardware accelerator can speed up RSA algorithms significantly. Besides, the RSA Accelerator also supports operands of different lengths, which provides more flexibility during the computation.

20.2 Features

The following functionality is supported:

- Large-number modular exponentiation with two optional acceleration options
- Large-number modular multiplication
- Large-number multiplication
- Operands of different lengths
- Interrupt on completion of computation

20.3 Functional Description

The RSA Accelerator is activated by setting the `SYSTEM_CRYPTO_RSA_CLK_EN` bit in the `SYSTEM_PERIP_CLK_EN1_REG` register and clearing the `SYSTEM_RSA_MEM_PD` bit in the `SYSTEM_RSA_PD_CTRL_REG` register. This releases the RSA Accelerator from reset.

The RSA Accelerator is only available after the [RSA-related memories](#) are initialized. The content of the `RSA_CLEAN_REG` register is 0 during initialization and will become 1 after the initialization is done. Therefore, it is advised to wait until `RSA_CLEAN_REG` becomes 1 before using the RSA Accelerator.

The `RSA_INTERRUPT_ENA_REG` register is used to control the interrupt triggered on completion of computation. Write 1 or 0 to this register to enable or disable interrupt. By default, the interrupt function of the RSA Accelerator is enabled.

Notice:

ESP32-S3's [Digital Signature \(DS\)](#) module also calls the RSA accelerator. Therefore, users cannot access the RSA accelerator when [Digital Signature \(DS\)](#) is working.

20.3.1 Large Number Modular Exponentiation

Large-number modular exponentiation performs $Z = X^Y \bmod M$. The computation is based on Montgomery multiplication. Therefore, aside from the X , Y , and M arguments, two additional ones are needed — \bar{r} and M' , which need to be calculated in advance by software.

RSA Accelerator supports operands of length $N = 32 \times x$, where $x \in \{1, 2, 3, \dots, 128\}$. The bit lengths of arguments Z , X , Y , M , and \bar{r} can be arbitrary N , but all numbers in a calculation must be of the same length.

The bit length of M' must be 32.

To represent the numbers used as operands, let us define a base- b positional notation, as follows:

$$b = 2^{32}$$

Using this notation, each number is represented by a sequence of base- b digits:

$$n = \frac{N}{32}$$

$$Z = (Z_{n-1}Z_{n-2} \cdots Z_0)_b$$

$$X = (X_{n-1}X_{n-2} \cdots X_0)_b$$

$$Y = (Y_{n-1}Y_{n-2} \cdots Y_0)_b$$

$$M = (M_{n-1}M_{n-2} \cdots M_0)_b$$

$$\bar{r} = (\bar{r}_{n-1}\bar{r}_{n-2} \cdots \bar{r}_0)_b$$

Each of the n values in $Z_{n-1} \cdots Z_0$, $X_{n-1} \cdots X_0$, $Y_{n-1} \cdots Y_0$, $M_{n-1} \cdots M_0$, $\bar{r}_{n-1} \cdots \bar{r}_0$ represents one base- b digit (a 32-bit word).

Z_{n-1} , X_{n-1} , Y_{n-1} , M_{n-1} and \bar{r}_{n-1} are the most significant bits of Z , X , Y , M , while Z_0 , X_0 , Y_0 , M_0 and \bar{r}_0 are the least significant bits.

If we define $R = b^n$, the additional arguments can be calculated as $\bar{r} = R^2 \bmod M$.

The following equation in the form compatible with the extended binary GCD algorithm can be written as

$$M^{-1} \times M + 1 = R \times R^{-1}$$

$$M' = M^{-1} \bmod b$$

Large-number modular exponentiation can be implemented as follows:

1. Write 1 or 0 to the [RSA_INTERRUPT_ENA_REG](#) register to enable or disable the interrupt function.
2. Configure relevant registers:
 - (a) Write $(\frac{N}{32} - 1)$ to the [RSA_MODE_REG](#) register.
 - (b) Write M' to the [RSA_M_PRIME_REG](#) register.
 - (c) Configure registers related to the acceleration options, which are described later in Section 20.3.4.
3. Write X_i , Y_i , M_i and \bar{r}_i for $i \in \{0, 1, \dots, n - 1\}$ to memory blocks [RSA_X_MEM](#), [RSA_Y_MEM](#), [RSA_M_MEM](#) and [RSA_Z_MEM](#). The capacity of each memory block is 128 words. Each word of each memory block can store one base- b digit. The memory blocks use the little endian format for storage, i.e. the least significant digit of each number is in the lowest address.

Users need to write data to each memory block only according to the length of the number; data beyond this length are ignored.

4. Write 1 to the [RSA_MODEXP_START_REG](#) register to start computation.
5. Wait for the completion of computation, which happens when the content of [RSA_IDLE_REG](#) becomes 1 or the RSA interrupt occurs.

6. Read the result Z_i for $i \in \{0, 1, \dots, n - 1\}$ from [RSA_Z_MEM](#).
7. Write 1 to [RSA_CLEAR_INTERRUPT_REG](#) to clear the interrupt, if you have enabled the interrupt function.

After the computation, the [RSA_MODE_REG](#) register, memory blocks [RSA_Y_MEM](#) and [RSA_M_MEM](#), as well as the [RSA_M_PRIME_REG](#) remain unchanged. However, X_i in [RSA_X_MEM](#) and \bar{r}_i in [RSA_Z_MEM](#) computation are overwritten, and only these overwritten memory blocks need to be re-initialized before starting another computation.

20.3.2 Large Number Modular Multiplication

Large-number modular multiplication performs $Z = X \times Y \bmod M$. This computation is based on Montgomery multiplication. Therefore, similar to the large number modular exponentiation, two additional arguments are needed – \bar{r} and M' , which need to be calculated in advance by software.

The RSA Accelerator supports large-number modular multiplication with operands of 128 different lengths.

The computation can be executed as follows:

1. Write 1 or 0 to the [RSA_INTERRUPT_ENA_REG](#) register to enable or disable the interrupt function.
2. Configure relevant registers:
 - (a) Write $(\frac{N}{32} - 1)$ to the [RSA_MODE_REG](#) register.
 - (b) Write M' to the [RSA_M_PRIME_REG](#) register.
3. Write X_i , Y_i , M_i , and \bar{r}_i for $i \in \{0, 1, \dots, n - 1\}$ to memory blocks [RSA_X_MEM](#), [RSA_Y_MEM](#), [RSA_M_MEM](#) and [RSA_Z_MEM](#). The capacity of each memory block is 128 words. Each word of each memory block can store one base- b digit. The memory blocks use the little endian format for storage, i.e. the least significant digit of each number is in the lowest address.

Users need to write data to each memory block only according to the length of the number; data beyond this length are ignored.
4. Write 1 to the [RSA_MODMULT_START_REG](#) register.
5. Wait for the completion of computation, which happens when the content of [RSA_IDLE_REG](#) becomes 1 or the RSA interrupt occurs.
6. Read the result Z_i for $i \in \{0, 1, \dots, n - 1\}$ from [RSA_Z_MEM](#).
7. Write 1 to [RSA_CLEAR_INTERRUPT_REG](#) to clear the interrupt, if you have enabled the interrupt function.

After the computation, the length of operands in [RSA_MODE_REG](#), the X_i in memory [RSA_X_MEM](#), the Y_i in memory [RSA_Y_MEM](#), the M_i in memory [RSA_M_MEM](#), and the M' in memory [RSA_M_PRIME_REG](#) remain unchanged. However, the \bar{r}_i in memory [RSA_Z_MEM](#) has already been overwritten, and only this overwritten memory block needs to be re-initialized before starting another computation.

20.3.3 Large Number Multiplication

Large-number multiplication performs $Z = X \times Y$. The length of result Z is twice that of operand X and operand Y . Therefore, the RSA Accelerator only supports Large Number Multiplication with operand length $N = 32 \times x$, where $x \in \{1, 2, 3, \dots, 64\}$. The length \hat{N} of result Z is $2 \times N$.

The computation can be executed as follows:

1. Write 1 or 0 to the [RSA_INTERRUPT_ENA_REG](#) register to enable or disable the interrupt function.
2. Write $(\frac{\hat{N}}{32} - 1)$, i.e. $(\frac{N}{16} - 1)$ to the [RSA_MODE_REG](#) register.
3. Write X_i and Y_i for $i \in \{0, 1, \dots, n - 1\}$ to memory blocks [RSA_X_MEM](#) and [RSA_Z_MEM](#). The capacity of each memory block is 64 words. Each word of each memory block can store one base- b digit. The memory blocks use the little endian format for storage, i.e. the least significant digit of each number is in the lowest address. n is $\frac{N}{32}$.

Write X_i for $i \in \{0, 1, \dots, n - 1\}$ to the address of the i words of the [RSA_X_MEM](#) memory block. Note that Y_i for $i \in \{0, 1, \dots, n - 1\}$ will not be written to the address of the i words of the [RSA_Z_MEM](#) register, but the address of the $n + i$ words, i.e. the base address of the [RSA_Z_MEM](#) memory plus the address offset $4 \times (n + i)$.

Users need to write data to each memory block only according to the length of the number; data beyond this length are ignored.

4. Write 1 to the [RSA_MULT_START_REG](#) register.
5. Wait for the completion of computation, which happens when the content of [RSA_IDLE_REG](#) becomes 1 or the RSA interrupt occurs.
6. Read the result Z_i for $i \in \{0, 1, \dots, \hat{n} - 1\}$ from the [RSA_Z_MEM](#) register. \hat{n} is $2 \times n$.
7. Write 1 to [RSA_CLEAR_INTERRUPT_REG](#) to clear the interrupt, if you have enabled the interrupt function.

After the computation, the length of operands in [RSA_MODE_REG](#) and the X_i in memory [RSA_X_MEM](#) remain unchanged. However, the Y_i in memory [RSA_Z_MEM](#) has already been overwritten, and only this overwritten memory block needs to be re-initialized before starting another computation.

20.3.4 Options for Acceleration

The ESP32-S3 RSA accelerator also provides [SEARCH](#) and [CONSTANT_TIME](#) options that can be configured to accelerate the large-number modular exponentiation. By default, both options are configured for no acceleration. Users can choose to use one or two of these options to accelerate the computation.

To be more specific, when neither of these two options are configured for acceleration, the time required to calculate $Z = X^Y \bmod M$ is solely determined by the lengths of operands. When either or both of these two options are configured for acceleration, the time required is also correlated with the 0/1 distribution of Y .

To better illustrate how these two options work, first assume Y is represented in binaries as

$$Y = (\tilde{Y}_{N-1}\tilde{Y}_{N-2}\cdots\tilde{Y}_{t+1}\tilde{Y}_t\tilde{Y}_{t-1}\cdots\tilde{Y}_0)_2$$

where,

- N is the length of Y ,
- \tilde{Y}_t is 1,
- $\tilde{Y}_{N-1}, \tilde{Y}_{N-2}, \dots, \tilde{Y}_{t+1}$ are all equal to 0,
- and $\tilde{Y}_{t-1}, \tilde{Y}_{t-2}, \dots, \tilde{Y}_0$ are either 0 or 1 but exactly m bits should be equal to 0 and $t-m$ bits 1, i.e. the Hamming weight of $\tilde{Y}_{t-1}\tilde{Y}_{t-2}, \dots, \tilde{Y}_0$ is $t - m$.

When either of these two options is configured for acceleration:

- SEARCH Option (Configuring [RSA_SEARCH_ENABLE](#) to 1 for acceleration)
 - The accelerator ignores the bit positions of \tilde{Y}_i , where $i > \alpha$. Search position α is set by configuring the [RSA_SEARCH_POS_REG](#) register. The maximum value of α is $N-1$, which leads to the same result when this option is not used for acceleration. The best acceleration performance can be achieved by setting α to t , in which case, all the $\tilde{Y}_{N-1}, \tilde{Y}_{N-2}, \dots, \tilde{Y}_{t+1}$ of 0s are ignored during the calculation. Note that if you set α to be less than t , then the result of the modular exponentiation $Z = X^Y \bmod M$ will be incorrect.
- CONSTANT_TIME Option (Configuring [RSA_CONSTANT_TIME_REG](#) to 0 for acceleration)
 - The accelerator speeds up the calculation by simplifying the calculation concerning the 0 bits of Y . Therefore, the higher the proportion of bits 0 against bits 1, the better the acceleration performance is.

We provide an example to demonstrate the performance of the RSA Accelerator under different combinations of [SEARCH](#) and [CONSTANT_TIME](#) configuration. Here we perform $Z = X^Y \bmod M$ with $N = 3072$ and $Y = 65537$. Table 20-1 below demonstrates the time costs under different combinations of [SEARCH](#) and [CONSTANT_TIME](#) configuration. Here, we should also mention that, α is set to 16 when the SEARCH option is enabled.

Table 20-1. Acceleration Performance

SEARCH Option	CONSTANT_TIME Option	Time Cost (ms)
No acceleration	No acceleration	752.81
Accelerated	No acceleration	4.52
No acceleration	Acceleration	2.406
Acceleration	Acceleration	2.33

It's obvious that:

- The time cost is the biggest when none of these two options is configured for acceleration.
- The time cost is the smallest when both of these two options are configured for acceleration.
- The time cost can be dramatically reduced when either or both option(s) are configured for acceleration.

20.4 Memory Summary

The addresses in this section are relative to the RSA accelerator base address provided in Table 4-3 in Chapter 4 *System and Memory*.

The abbreviations given in Column **Access** are explained in Section [Access Types for Registers](#).

Table 20-2. RSA Accelerator Memory Blocks

Name	Description	Size (byte)	Starting Address	Ending Address	Access
RSA_M_MEM	Memory M	512	0x0000	0x01FF	WO
RSA_Z_MEM	Memory Z	512	0x0200	0x03FF	R/W
RSA_Y_MEM	Memory Y	512	0x0400	0x05FF	WO
RSA_X_MEM	Memory X	512	0x0600	0x07FF	WO

20.5 Register Summary

The addresses in this section are relative to the RSA accelerator base address provided in Table 4-3 in Chapter 4 *System and Memory*.

The abbreviations given in Column **Access** are explained in Section [Access Types for Registers](#).

Name	Description	Address	Access
Configuration Registers			
RSA_M_PRIME_REG	Register to store M'	0x0800	R/W
RSA_MODE_REG	RSA length mode	0x0804	R/W
RSA_CONSTANT_TIME_REG	The constant_time option	0x0820	R/W
RSA_SEARCH_ENABLE_REG	The search option	0x0824	R/W
RSA_SEARCH_POS_REG	The search position	0x0828	R/W
Status/Control Registers			
RSA_CLEAN_REG	RSA clean register	0x0808	RO
RSA_MODEXP_START_REG	Modular exponentiation starting bit	0x080C	WO
RSA_MODMULT_START_REG	Modular multiplication starting bit	0x0810	WO
RSA_MULT_START_REG	Normal multiplication starting bit	0x0814	WO
RSA_IDLE_REG	RSA idle register	0x0818	RO
Interrupt Registers			
RSA_CLEAR_INTERRUPT_REG	RSA clear interrupt register	0x081C	WO
RSA_INTERRUPT_ENA_REG	RSA interrupt enable register	0x082C	R/W
Version Register			
RSA_DATE_REG	Version control register	0x0830	R/W

20.6 Registers

The addresses in this section are relative to the RSA accelerator base address provided in Table 4-3 in Chapter 4 *System and Memory*.

Register 20.1. RSA_M_PRIME_REG (0x0800)

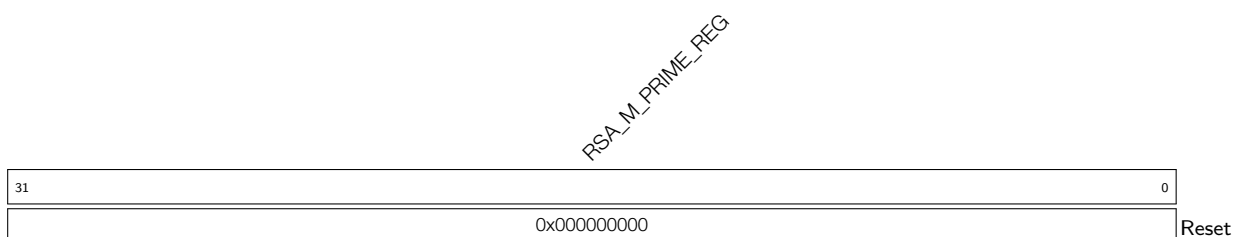

RSA_M_PRIME_REG Stores M'.(R/W)

Register 20.2. RSA_MODE_REG (0x0804)

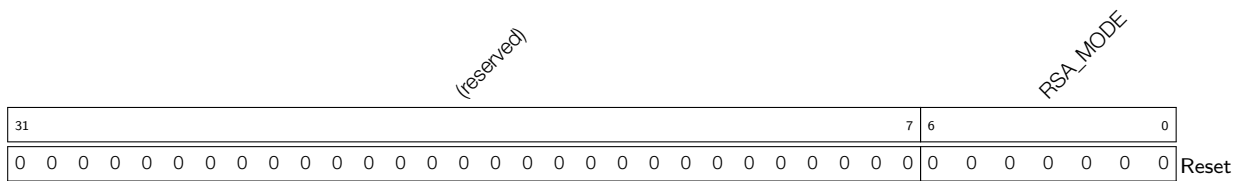

RSA_MODE Stores the mode of modular exponentiation. (R/W)

Register 20.3. RSA_CLEAN_REG (0x0808)

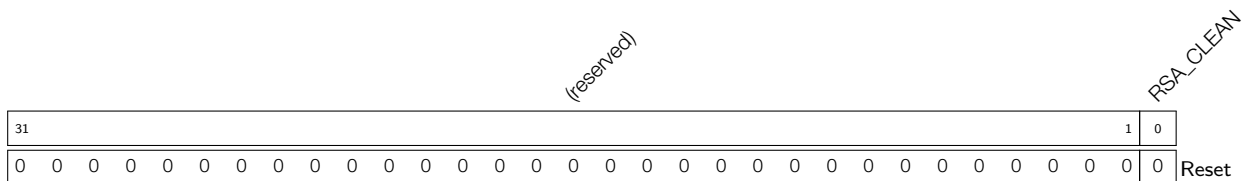

RSA_CLEAN The content of this bit is 1 when memories complete initialization. (RO)

Register 20.4. RSA_MODEXP_START_REG (0x080C)

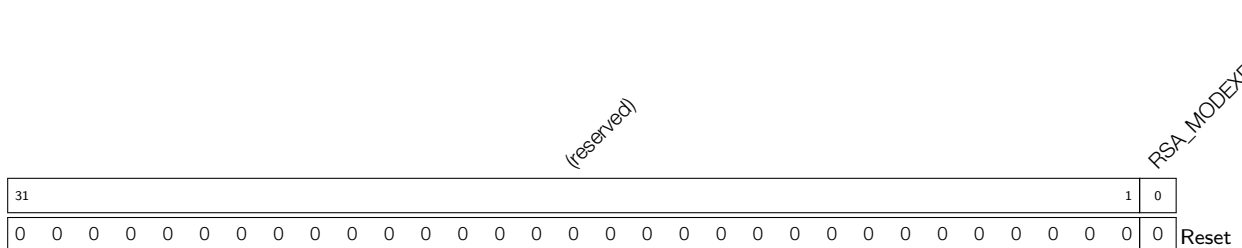

RSA_MODEXP_START Set this bit to 1 to start the modular exponentiation. (WO)

Register 20.5. RSA_MODMULT_START_REG (0x0810)

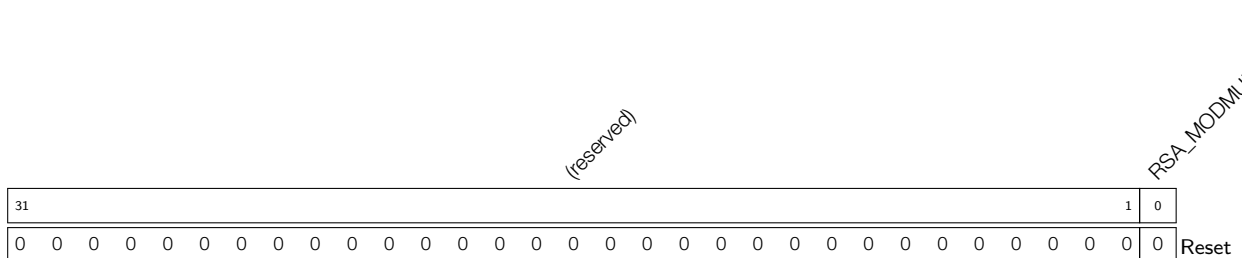

RSA_MODMULT_START Set this bit to 1 to start the modular multiplication. (WO)

Register 20.6. RSA_MULT_START_REG (0x0814)

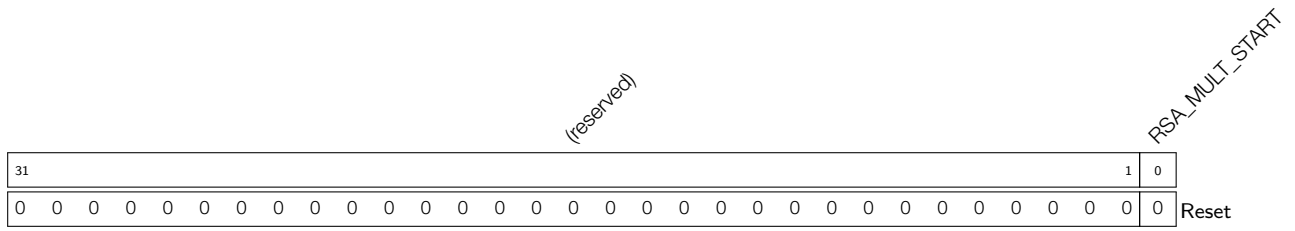

RSA_MULT_START Set this bit to 1 to start the multiplication. (WO)

Register 20.7. RSA_IDLE_REG (0x0818)

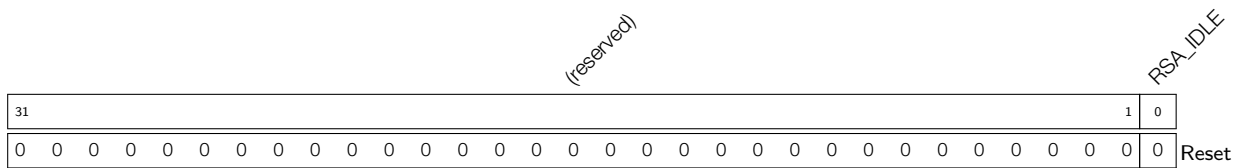

RSA_IDLE The content of this bit is 1 when the RSA accelerator is idle. (RO)

Register 20.8. RSA_CLEAR_INTERRUPT_REG (0x081C)

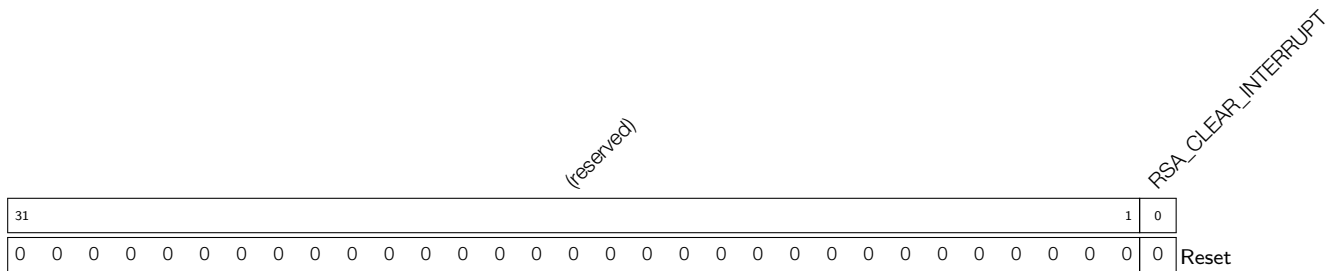

RSA_CLEAR_INTERRUPT Set this bit to 1 to clear the RSA interrupts. (WO)

Register 20.9. RSA_CONSTANT_TIME_REG (0x0820)

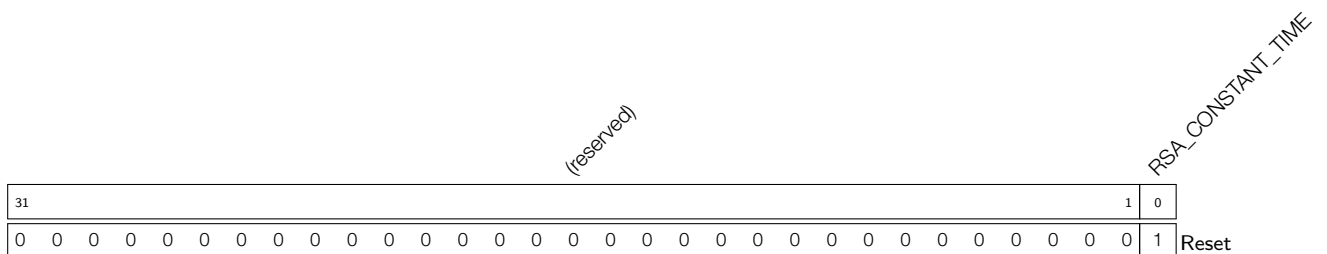

RSA_CONSTANT_TIME_REG Controls the constant_time option. 0: acceleration. 1: no acceleration (by default). (R/W)

Register 20.10. RSA_SEARCH_ENABLE_REG (0x0824)

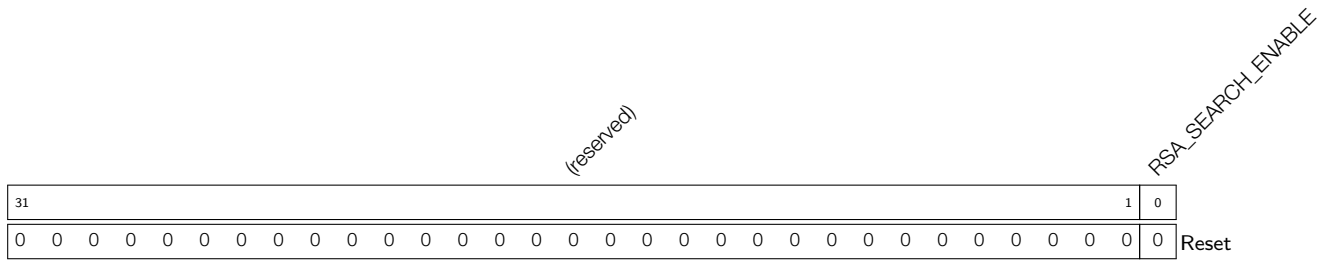

RSA_SEARCH_ENABLE Controls the search option. 0: no acceleration (by default). 1: acceleration.
(R/W)

Register 20.11. RSA_SEARCH_POS_REG (0x0828)

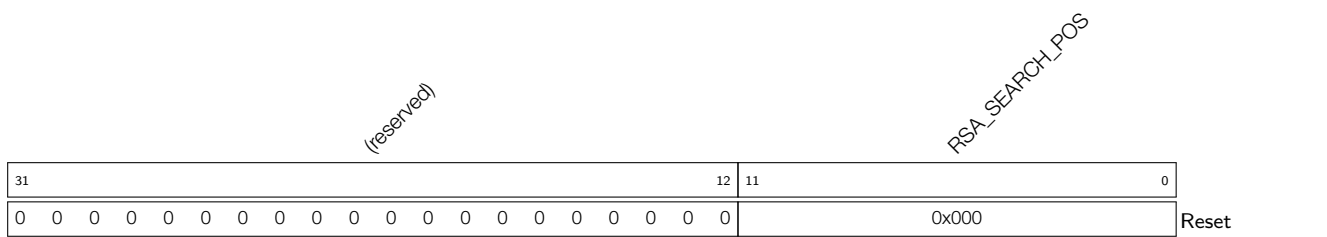

RSA_SEARCH_POS Is used to configure the starting address when the acceleration option of search is used. (R/W)

Register 20.12. RSA_INTERRUPT_ENA_REG (0x082C)

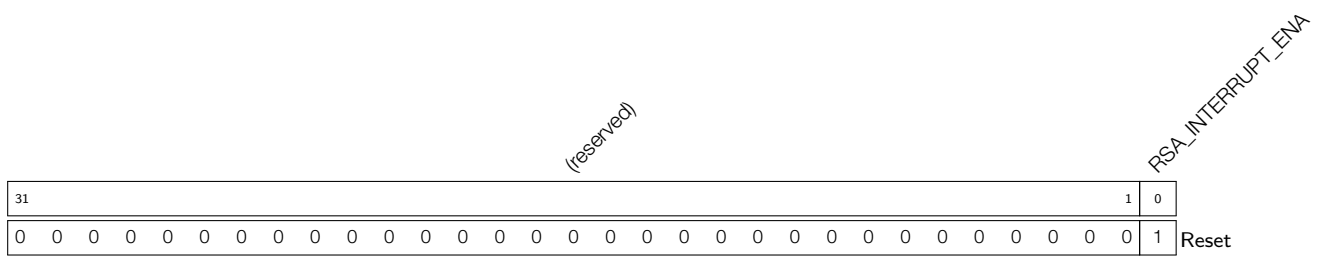

RSA_INTERRUPT_ENA Set this bit to 1 to enable the RSA interrupt. This option is enabled by default.
(R/W)

Register 20.13. RSA_DATE_REG (0x0830)

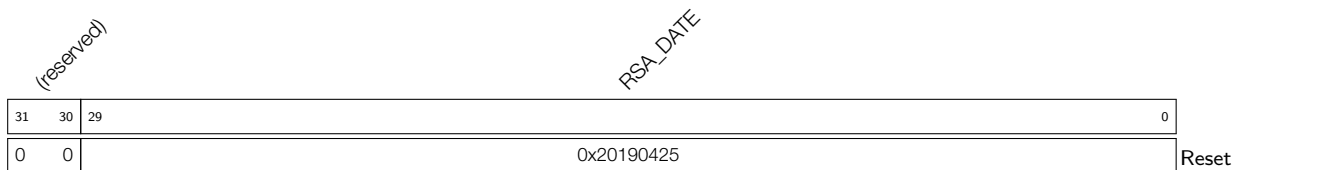

RSA_DATE Version control register. (R/W)

21 HMAC Accelerator (HMAC)

The Hash-based Message Authentication Code (HMAC) module computes Message Authentication Codes (MACs) using Hash algorithm and keys as described in RFC 2104. The underlying hash algorithm is SHA-256, and the 256-bit HMAC key is stored in an eFuse key block and can be set as read-protected for users.

21.1 Main Features

- Standard HMAC-SHA-256 algorithm
- Hash result only accessible by configurable hardware peripheral (in downstream mode)
- Compatible to challenge-response authentication algorithm
- Generates required keys for the Digital Signature (DS) peripheral (in downstream mode)
- Re-enables soft-disabled JTAG (in downstream mode)

21.2 Functional Description

The HMAC module operates in two modes: upstream mode and downstream mode. In upstream mode, the HMAC message is provided by the user and the calculation result is read back by the user; in downstream mode, the HMAC module is used as a Key Derivation Function (KDF) for other internal hardware. For instance, the JTAG can be temporarily disabled by burning odd number bits of `EFUSE_SOFT_DIS_JTAG` in eFuse. In this case, users can temporarily re-enable JTAG using the HMAC module in downstream mode.

After the reset signal being released, the HMAC module will check whether the DS key exists in the eFuse. If the key exists, the HMAC module will enter downstream digital signature mode and finish the DS key calculation automatically.

21.2.1 Upstream Mode

Common use cases for the upstream mode are challenge-response protocols supporting HMAC-SHA-256 algorithm. In upstream mode, the user should provide the related HMAC information and read back its calculation results.

Assume the two entities in the challenge-response protocol are A and B respectively, and the entities share the same secret KEY. The data message they expect to exchange is M. The general process of this protocol is as follows:

- A calculates a unique random number M
- A sends M to B
- B calculates the HMAC value (through M and KEY) and sends the result to A
- A also calculates the HMAC value (through M and KEY) internally
- A compares these two values. If they are the same, then the identity of B is authenticated

To calculate the HMAC value (the following steps should be done by the user):

1. Initialize the HMAC module, and enter upstream mode.
2. Write the correctly padded message to the HMAC, one block at a time.

3. Read back the result from HMAC.

For details of this process, please see Section [21.2.6](#).

21.2.2 Downstream JTAG Enable Mode

There are two parameters in the eFuse memory to disable JTAG debugging, namely [EFUSE_DIS_PAD_JTAG](#) and [EFUSE_SOFT_DIS_JTAG](#). Set [EFUSE_DIS_PAD_JTAG](#) to 1 can disable JTAG permanently, and set odd numbers of 1 to [EFUSE_SOFT_DIS_JTAG](#) can disable JTAG temporarily. For more details, please see Chapter [5 eFuse Controller](#).

To re-enable the temporarily disabled JTAG, users can follow the steps below:

1. Enable the HMAC module and enter downstream JTAG enable mode.
2. Write 1 to the [HMAC_SOFT_JTAG_CTRL_REG](#) register to enter JTAG re-enable compare mode.
3. Write the 256-bit HMAC value which is calculated locally from the 32-byte 0x00 using HMAC-SHA-256 algorithm and the pre-generated key to register [HMAC_WR_JTAG_REG](#), in big-endian order of word.
4. If the HMAC internally calculated value matches the value that user programmed, then JTAG is re-enabled. Otherwise, JTAG remains disabled.
5. JTAG remains in the status as in step 4 until the user writes 1 to register [HMAC_SET_INVALIDATE_JTAG_REG](#) or restart JTAG.

For detailed steps of this process, please see Section [21.2.6](#).

21.2.3 Downstream Digital Signature Mode

The Digital Signature (DS) module encrypts its parameters using AES-CBC algorithm. The HMAC module is used as a Key Derivation Function (KDF) to derive the AES key to decrypt these parameters.

Before starting the DS module, the user needs to obtain the key for it first through HMAC calculation. For more information, please see Chapter [22 Digital Signature \(DS\)](#). After the clock of HMAC be enabled and reset of HMAC be released, the HMAC module will check to see if there is a functional key in eFuses for the DS module. If yes, HMAC will enter downstream digital signature mode and finish DS key calculation automatically.

21.2.4 HMAC eFuse Configuration

The HMAC module provides three different functionalities: re-enabling JTAG and serving as DS KDF in downstream mode as well as pure HMAC calculation in upstream mode. Table [21-1](#) lists the register value corresponding to each purpose, which should be written to register [HMAC_SET_PARA_PURPOSE_REG](#) by the user (see Section [21.2.6](#)).

Table 21-1. HMAC Purposes and Configuration Values

Purpose	Mode	Value	Description
JTAG Re-enable	Downstream	6	EFUSE_KEY_PURPOSE_HMAC_DOWN_JTAG
DS Key Derivation	Downstream	7	EFUSE_KEY_PURPOSE_HMAC_DOWN_DIGITAL_SIGNATURE
HMAC Calculation	Upstream	8	EFUSE_KEY_PURPOSE_HMAC_UP
Both JTAG Re-enable and DS KDF	Downstream	5	EFUSE_KEY_PURPOSE_HMAC_DOWN_ALL

Before enabling HMAC to do calculations, user should make sure the key to be used has been burned in eFuse. You can burn a key to eFuse as follows:

1. Prepare a secret 256-bit HMAC key and burn the key to an empty eFuse block y (there are six blocks for storing a key in eFuse. The numbers of those blocks range from 4 to 9, so $y = 4, 5, \dots, 9$. Hence, if we are talking about key0, we mean eFuse block4), and then program the purpose to `EFUSE_KEY_PURPOSE_(y - 4)`. Take upstream mode as an example: after programming the key, the user should program `EFUSE_KEY_PURPOSE_HMAC_UP` (corresponding value is 8) to `EFUSE_KEY_PURPOSE_(y - 4)`. Please see Chapter 5 *eFuse Controller* on how to program eFuse keys.
2. Configure this eFuse key block to be read protected, so that users cannot read its value. A copy of this key should be kept by any party who needs to verify this device.

21.2.5 HMAC Initialization

The eFuse key blocks (with correctly programmed purpose values) must be coordinated with the HMAC modes, or HMAC will terminate calculation.

Configure HMAC modes

The correct purpose (see Table 21-1) has to be written to register `HMAC_SET_PARA_PURPOSE_REG` by the user.

Select eFuse Key Blocks

The eFuse controller provides six key blocks, i.e., KEY0 ~ 5. To select a particular KEY n for a certain HMAC calculation, write the key number n to register `HMAC_SET_PARA_KEY_REG`.

Note that the purpose of the key has also been programmed to eFuse memory. Only when the configured HMAC purpose matches the defined purpose of KEY n , will the HMAC module execute the configured calculation. Otherwise, it will return a matching error and stop the current calculation. For example, suppose a user selects KEY3 for HMAC calculation, and the value programmed to `KEY_PURPOSE_3` is 6 (`EFUSE_KEY_PURPOSE_HMAC_DOWN_JTAG`). Based on Table 21-1, KEY3 can be used to re-enable JTAG. If the value written to register `HMAC_SET_PARA_PURPOSE_REG` is also 6, then the HMAC module will start the process to re-enable JTAG.

21.2.6 HMAC Process (Detailed)

The process to call HMAC in ESP32-S3 is as follows:

1. Enable HMAC module

- (a) Set the peripheral clock bits for HMAC and SHA peripherals in `SYSTEM_PEIRP_CLK_EN1_REG`, and clear the corresponding peripheral reset bits in `SYSTEM_PEIRP_RST_EN1_REG`. For registers information, please see Chapter 4 *System and Memory*.
- (b) Write 1 to register `HMAC_SET_START_REG`.

2. Configure HMAC keys and key purposes

- (a) Write the key purpose m to register `HMAC_SET_PARA_PURPOSE_REG`. The possible key purpose values are shown in Table 21-1. For more information, please refer to Section 21.2.4.
- (b) Select `KEY n` in eFuse memory as the key by writing n (0 ~ 5) to register `HMAC_SET_PARA_KEY_REG`. For more information, please refer to Section 21.2.5.
- (c) Write 1 to register `HMAC_SET_PARA_FINISH_REG` to complete the configuration.
- (d) Read register `HMAC_QUERY_ERROR_REG`. If its value is 1, it means the purpose of the selected block does not match the configured key purpose and the calculation will not proceed. If its value is 0, it means the purpose of the selected block matches the configured key purpose, and then the calculation can proceed.
- (e) When the value of `HMAC_SET_PARA_PURPOSE_REG` is not 8, it means the HMAC module is in downstream mode, proceed with Step 3. When the value is 8, it means the HMAC module is in upstream mode, proceed with Step 4.

3. Downstream mode

- (a) Poll Status register `HMAC_QUERY_BUSY_REG`. When the value of this register is 0, HMAC calculation in downstream mode is completed.
- (b) In downstream mode, the calculation result is used by either the JTAG or DS module in the hardware. To clear the result and make further usage of the dependent hardware (JTAG or DS), write 1 to either register `HMAC_SET_INVALIDATE_JTAG_REG` to clear the result generated by JTAG key; or to register `HMAC_SET_INVALIDATE_DS_REG` to clear the result generated by DS key.
- (c) Downstream mode operation completed.

4. Transmit message block `Block $_n$` ($n \geq 1$) in upstream mode

- (a) Poll Status register `HMAC_QUERY_BUSY_REG`. When the value of this register is 0, go to step 4(b).
- (b) Write the 512-bit `Block $_n$` to register `HMAC_WDATA0~15_REG`. Write 1 to register `HMAC_SET_MESSAGE_ONE_REG`, to trigger the processing of this message block.
- (c) Poll Status register `HMAC_QUERY_BUSY_REG`. When the value of this register is 0, go to step 4(d).
- (d) Different message blocks will be generated, depending on whether the size of the to-be-processed message is a multiple of 512 bits.
 - If the bit length of the message is a multiple of 512 bits, there are three possible options:
 - i. If `Block $_{n+1}$` exists, write 1 to register `HMAC_SET_MESSAGE_ING_REG` to make $n = n + 1$, and then jump to step 4(b).
 - ii. If `Block $_n$` is the last block of the message and the user wants to apply SHA padding in hardware, write 1 to register `HMAC_SET_MESSAGE_END_REG`, and then jump to step 6.

- iii. If Block_{*n*} is the last block of the padded message and the user has applied SHA padding in software, write 1 to register [HMAC_SET_MESSAGE_PAD_REG](#), and then jump to step 5.
- If the bit length of the message is not a multiple of 512 bits, there are three possible options as follows. Note that in this case, the user should apply SHA padding to the message, after which the padded message length should be a multiple of 512 bits.
 - i. If Block_{*n*} is the only message block, $n = 1$, and Block₁ has included all padding bits, write 1 to register [HMAC_ONE_BLOCK_REG](#), and then jump to step 6.
 - ii. If Block_{*n*} is the second to last padded block, write 1 to register [HMAC_SET_MESSAGE_PAD_REG](#), and then jump to step 5.
 - iii. If Block_{*n*} is neither the last nor the second to last message block, write 1 to register [HMAC_SET_MESSAGE_ING_REG](#) and define $n = n + 1$, and then jump to step 4.(b).
- 5. Apply SHA padding to message
 - (a) After applying SHA padding to the last message block as described in Section 21.3.1, write this block to register [HMAC_WDATA0~15_REG](#), and then write 1 to register [HMAC_SET_MESSAGE_ONE_REG](#). Then the HMAC module will calculate this message block.
 - (b) Jump to step 6.
- 6. Read hash result in upstream mode
 - (a) Poll Status register [HMAC_QUERY_BUSY_REG](#). When the value of this register is 0, go to the next step.
 - (b) Read hash result from register [HMAC_RDATA0~7_REG](#).
 - (c) Write 1 to register [HMAC_SET_RESULT_FINISH_REG](#) to finish calculation.
 - (d) Upstream mode operation is completed.

Note:

The SHA accelerator can be called directly, or used internally by the DS module and the HMAC module. However, they can not share the hardware resources simultaneously. Therefore, SHA module can not be called by the CPU nor DS module when the HMAC module is in use.

21.3 HMAC Algorithm Details

21.3.1 Padding Bits

The HMAC module uses SHA-256 as hash algorithm. If the input message is not a multiple of 512 bits, a SHA-256 padding algorithm must be applied in software. The SHA-256 padding algorithm is the same as described in Section *Padding the Message* of *FIPS PUB 180-4*.

As shown in Figure 21-1, suppose the length of the unpadded message is m bits. Padding steps are as follows:

1. Append one bit of value “1” to the end of the unpadded message;
2. Append k bits of value “0”, where k is the smallest non-negative number which satisfies $m + 1 + k \equiv 448 \pmod{512}$;

- Append a 64-bit integer value as a binary block. This block includes the length of the unpadded message as a big-endian binary integer value m .

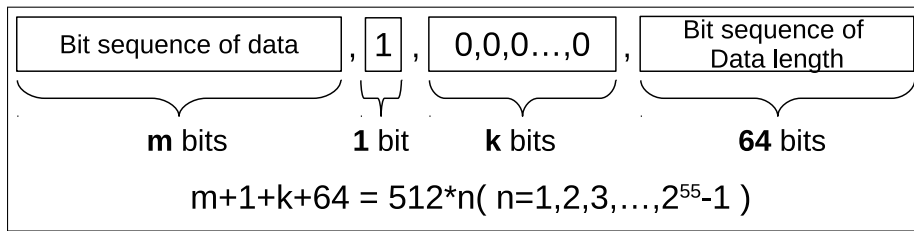

Figure 21-1. HMAC SHA-256 Padding Diagram

In downstream mode, there is no need to input any message or apply padding. In upstream mode, if the length of the unpadded message is a multiple of 512 bits, the user can choose to configure hardware to apply the SHA padding. If the length is not a multiple of 512 bits, the user must apply the SHA padding manually. For detailed steps, please see Section 21.2.6.

21.3.2 HMAC Algorithm Structure

The structure of the implemented algorithm in the HMAC module is shown in Figure 21-2. This is the standard HMAC algorithm as described in RFC 2104.

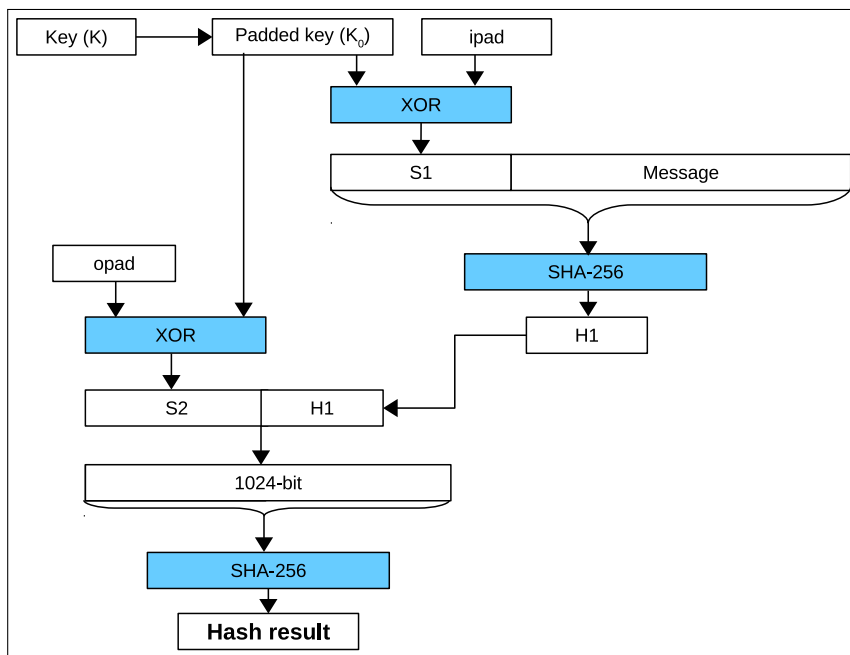

Figure 21-2. HMAC Structure Schematic Diagram

In Figure 21-2:

1. ipad is a 512-bit message block composed of 64 bytes of 0x36.
2. opad is a 512-bit message block composed of 64 bytes of 0x5c.

The HMAC module appends a 256-bit 0 sequence after the bit sequence of the 256-bit key K in order to get a 512-bit K_0 . Then, the HMAC module XORs K_0 with ipad to get the 512-bit S1. Afterwards, the HMAC module appends the input message (multiple of 512 bits) after the 512-bit S1, and exercises the SHA-256 algorithm to get the 256-bit H1.

The HMAC module appends the 256-bit SHA-256 hash result H1 to the 512-bit S2 value, which is calculated using the XOR operation of K_0 and opad. A 768-bit sequence will be generated. Then, the HMAC module uses the SHA padding algorithm described in Section 21.3.1 to pad the 768-bit sequence to a 1024-bit sequence, and applies the SHA-256 algorithm to get the final hash result (256-bit).

21.4 Register Summary

The addresses in this section are relative to HMAC Accelerator base address provided in Table 4-3 in Chapter 4 *System and Memory*.

The abbreviations given in Column **Access** are explained in Section [Access Types for Registers](#).

Name	Description	Address	Access
Status/Control Register			
HMAC_SET_START_REG	HMAC start control register	0x040	WO
HMAC_SET_PARA_PURPOSE_REG	HMAC parameter purpose register	0x044	WO
HMAC_SET_PARA_KEY_REG	HMAC parameter key register	0x048	WO
HMAC_SET_PARA_FINISH_REG	Finish initial configuration	0x04C	WO
HMAC_SET_MESSAGE_ONE_REG	HMAC message control register	0x050	WO
HMAC_SET_MESSAGE_ING_REG	HMAC message continue register	0x054	WO
HMAC_SET_MESSAGE_END_REG	HMAC message end register	0x058	WO
HMAC_SET_RESULT_FINISH_REG	HMAC result reading finish register	0x05C	WO
HMAC_SET_INVALIDATE_JTAG_REG	Invalidate JTAG result register	0x060	WO
HMAC_SET_INVALIDATE_DS_REG	Invalidate digital signature result register	0x064	WO
HMAC_QUERY_ERROR_REG	Stores matching results between keys generated by users and corresponding purposes	0x068	RO
HMAC_QUERY_BUSY_REG	Busy state of HMAC module	0x06C	RO
HMAC Message Block			
HMAC_WR_MESSAGE_0_REG	Message register 0	0x080	WO
HMAC_WR_MESSAGE_1_REG	Message register 1	0x084	WO
HMAC_WR_MESSAGE_2_REG	Message register 2	0x088	WO
HMAC_WR_MESSAGE_3_REG	Message register 3	0x08C	WO
HMAC_WR_MESSAGE_4_REG	Message register 4	0x090	WO
HMAC_WR_MESSAGE_5_REG	Message register 5	0x094	WO
HMAC_WR_MESSAGE_6_REG	Message register 6	0x098	WO
HMAC_WR_MESSAGE_7_REG	Message register 7	0x09C	WO
HMAC_WR_MESSAGE_8_REG	Message register 8	0x0A0	WO
HMAC_WR_MESSAGE_9_REG	Message register 9	0x0A4	WO
HMAC_WR_MESSAGE_10_REG	Message register 10	0x0A8	WO
HMAC_WR_MESSAGE_11_REG	Message register 11	0x0AC	WO
HMAC_WR_MESSAGE_12_REG	Message register 12	0x0B0	WO
HMAC_WR_MESSAGE_13_REG	Message register 13	0x0B4	WO
HMAC_WR_MESSAGE_14_REG	Message register 14	0x0B8	WO
HMAC_WR_MESSAGE_15_REG	Message register 15	0x0BC	WO
HMAC Upstream Result			
HMAC_RD_RESULT_0_REG	Hash result register 0	0x0C0	RO
HMAC_RD_RESULT_1_REG	Hash result register 1	0x0C4	RO
HMAC_RD_RESULT_2_REG	Hash result register 2	0x0C8	RO
HMAC_RD_RESULT_3_REG	Hash result register 3	0x0CC	RO
HMAC_RD_RESULT_4_REG	Hash result register 4	0x0D0	RO
HMAC_RD_RESULT_5_REG	Hash result register 5	0x0D4	RO

Name	Description	Address	Access
HMAC_RD_RESULT_6_REG	Hash result register 6	0x0D8	RO
HMAC_RD_RESULT_7_REG	Hash result register 7	0x0DC	RO
configuration Register			
HMAC_SET_MESSAGE_PAD_REG	Software padding register	0x0F0	WO
HMAC_ONE_BLOCK_REG	One block message register	0x0F4	WO
HMAC_SOFT_JTAG_CTRL_REG	Re-enable JTAG register 0	0x0F8	WO
HMAC_WR_JTAG_REG	Re-enable JTAG register 1	0x0FC	WO
Version Register			
HMAC_DATE_REG	Version control register	0x1FC	R/W

21.5 Registers

The addresses in this section are relative to HMAC Accelerator base address provided in Table 4-3 in Chapter 4 *System and Memory*.

Register 21.1. HMAC_SET_START_REG (0x040)

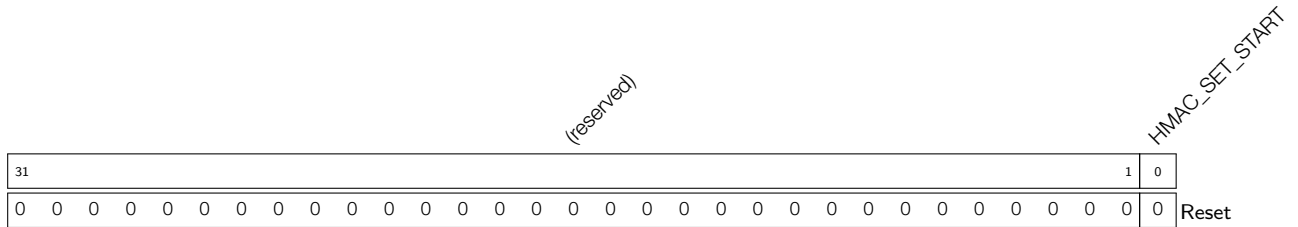

HMAC_SET_START Set this bit to start hmac operation. (WO)

Register 21.2. HMAC_SET_PARA_PURPOSE_REG (0x044)

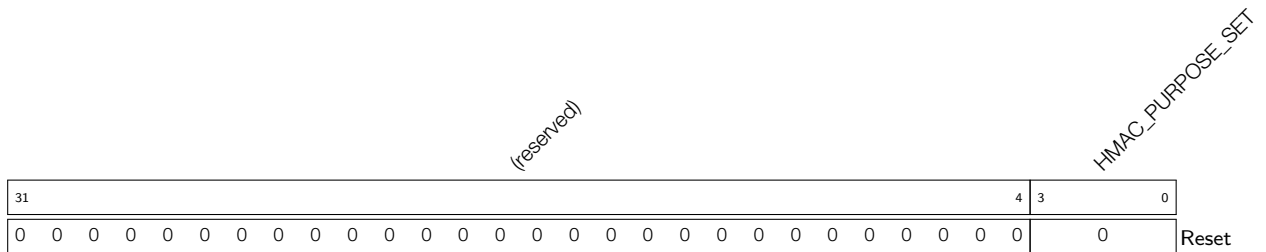

HMAC_PURPOSE_SET Set HMAC parameter purpose, please see Table 21-1. (WO)

Register 21.3. HMAC_SET_PARA_KEY_REG (0x048)

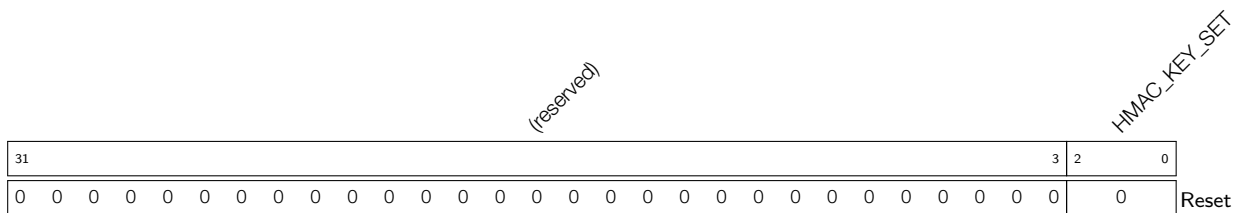

HMAC_KEY_SET Set HMAC parameter key. There are six keys with index 0 ~ 5. Write the index of the selected key to this field. (WO)

Register 21.4. HMAC_SET_PARA_FINISH_REG (0x04C)

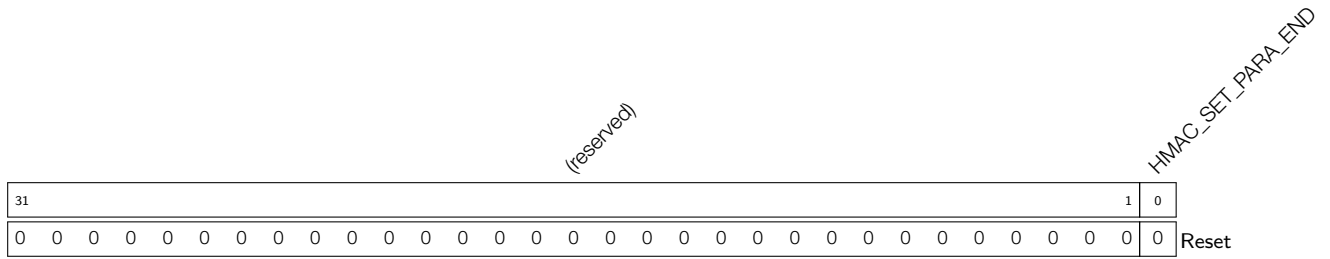

HMAC_SET_PARA_END Set this bit to finish HMAC configuration. (WO)

Register 21.5. HMAC_SET_MESSAGE_ONE_REG (0x050)

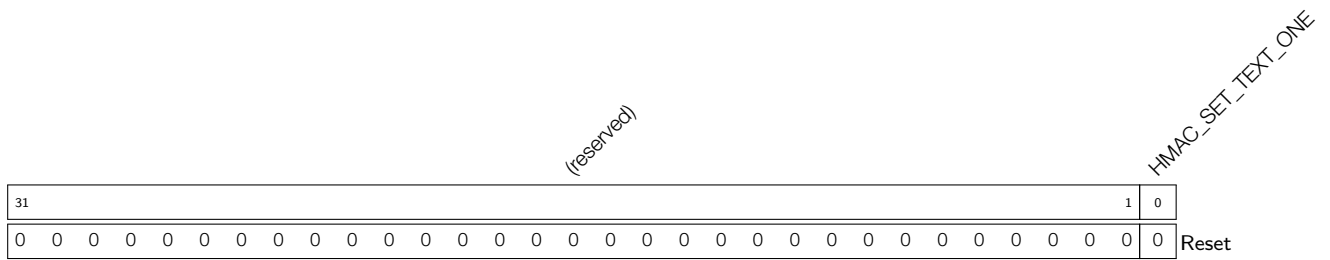

HMAC_SET_TEXT_ONE Call SHA to calculate one message block. (WO)

Register 21.6. HMAC_SET_MESSAGE_ING_REG (0x054)

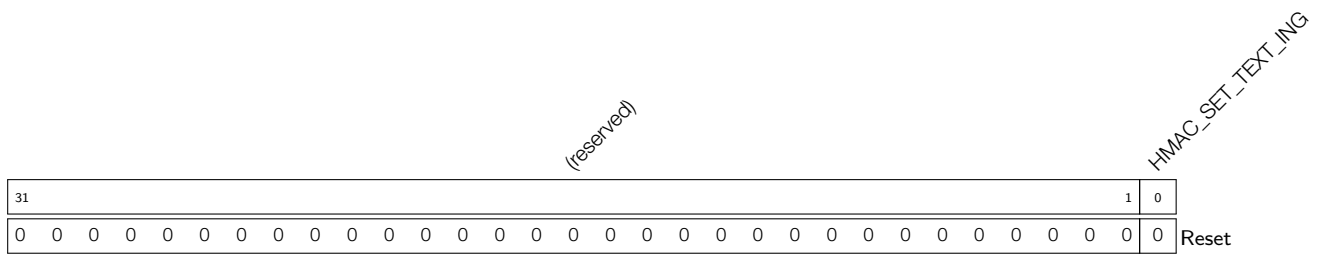

HMAC_SET_TEXT_ING Set this bit to show there are still some message blocks to be processed. (WO)

Register 21.7. HMAC_SET_MESSAGE_END_REG (0x058)

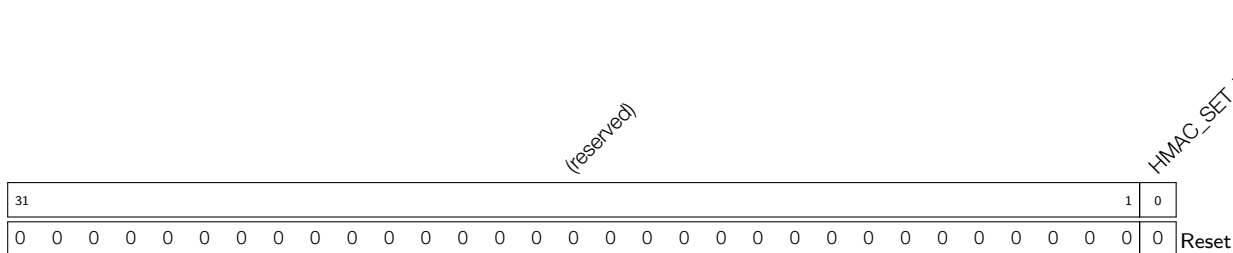

HMAC_SET_TEXT_END Set this bit to start hardware padding. (WO)

Register 21.8. HMAC_SET_RESULT_FINISH_REG (0x05C)

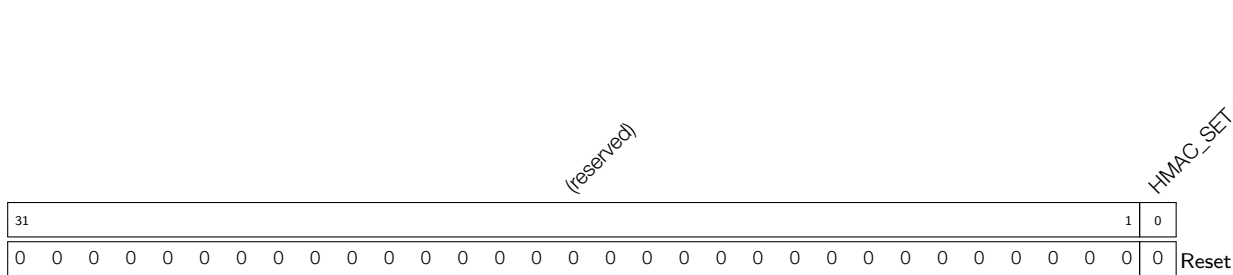

HMAC_SET_RESULT_END After read result from upstream, then let HMAC back to idle. (WO)

Register 21.9. HMAC_SET_INVALIDATE_JTAG_REG (0x060)

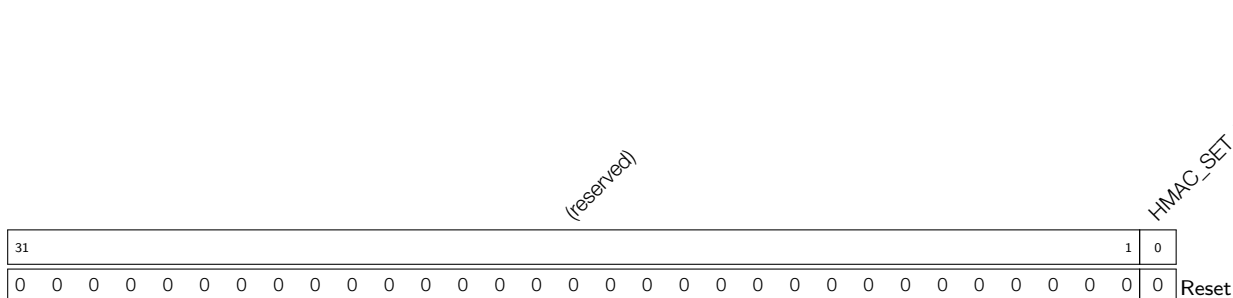

HMAC_SET_INVALIDATE_JTAG Set this bit to clear calculation results when re-enabling JTAG in downstream mode. (WO)

Register 21.10. HMAC_SET_INVALIDATE_DS_REG (0x064)

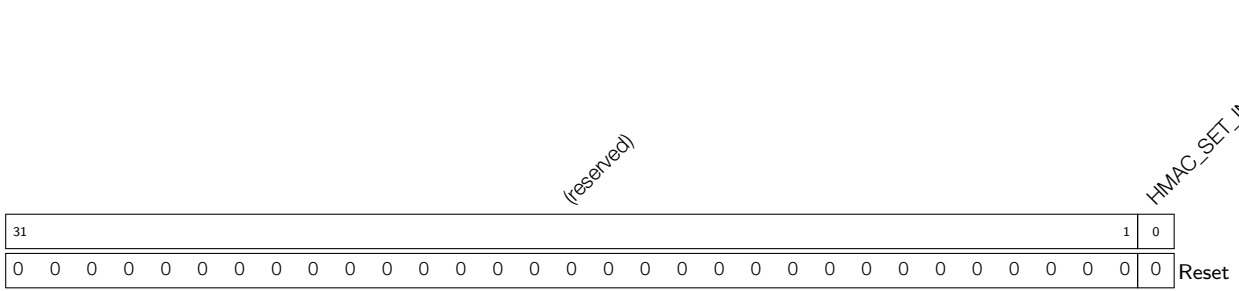

HMAC_SET_INVALIDATE_DS Set this bit to clear calculation results of the DS module in downstream mode. (WO)

Register 21.11. HMAC_QUERY_ERROR_REG (0x068)

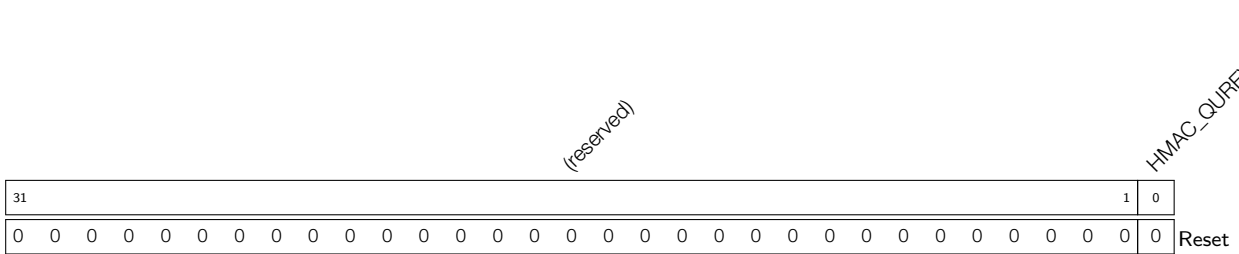

HMAC_QUREY_CHECK Indicates whether a HMAC key matches the purpose.

- 0: HMAC key and purpose match.
- 1: error. (RO)

Register 21.12. HMAC_QUERY_BUSY_REG (0x06C)

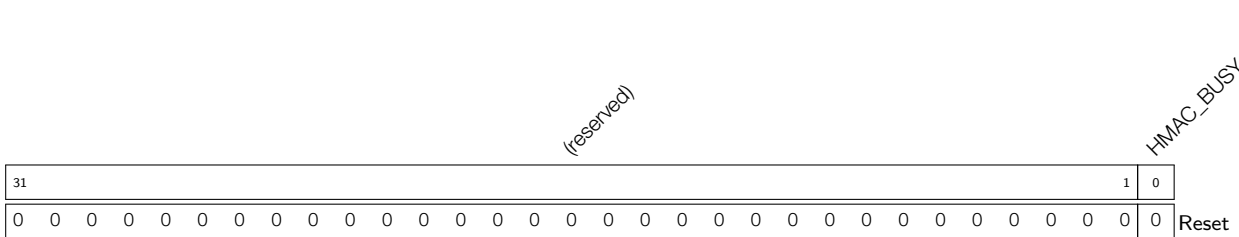

HMAC_BUSY_STATE Indicates whether HMAC is in busy state.

- 1'b0: idle.
- 1'b1: HMAC is still working for calculation. (RO)

Register 21.13. HMAC_WR_MESSAGE_n_REG (n: 0-15) (0x080+4*n)

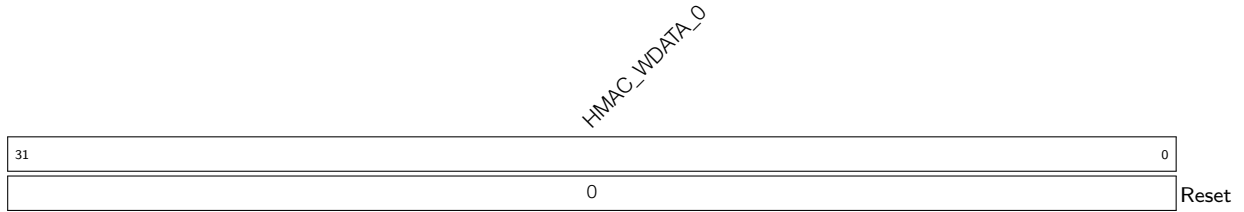

HMAC_WDATA_n Store the *n*th 32-bit of message. (WO)

Register 21.14. HMAC_RD_RESULT_n_REG (n: 0-7) (0x0C0+4*n)

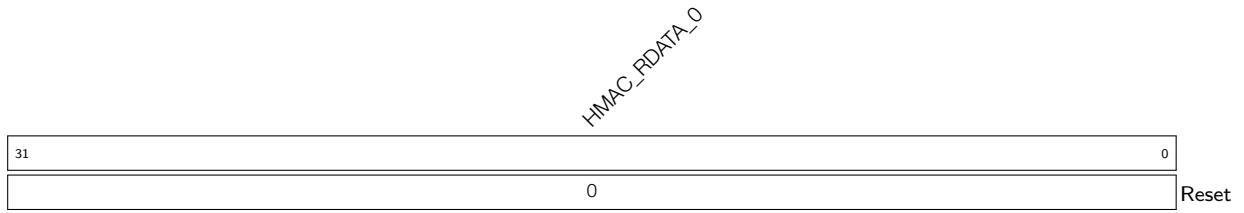

HMAC_RDATA_n Read the *n*th 32-bit of hash result. (RO)

Register 21.15. HMAC_SET_MESSAGE_PAD_REG (0x0F0)

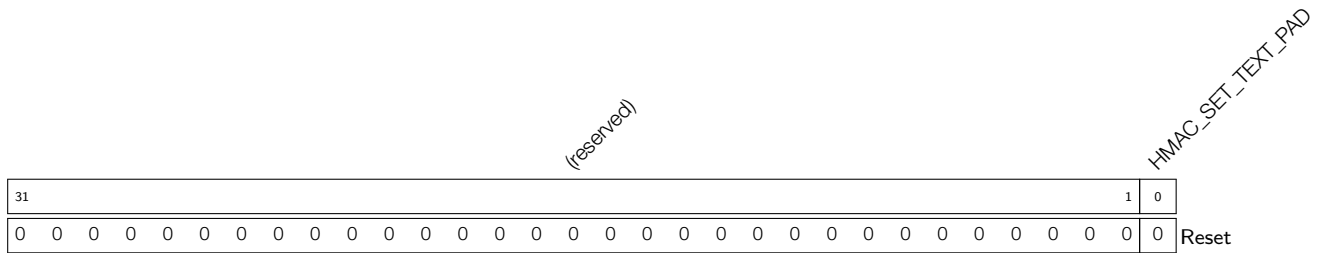

HMAC_SET_TEXT_PAD Set this bit to start software padding. (WO)

Register 21.16. HMAC_ONE_BLOCK_REG (0x0F4)

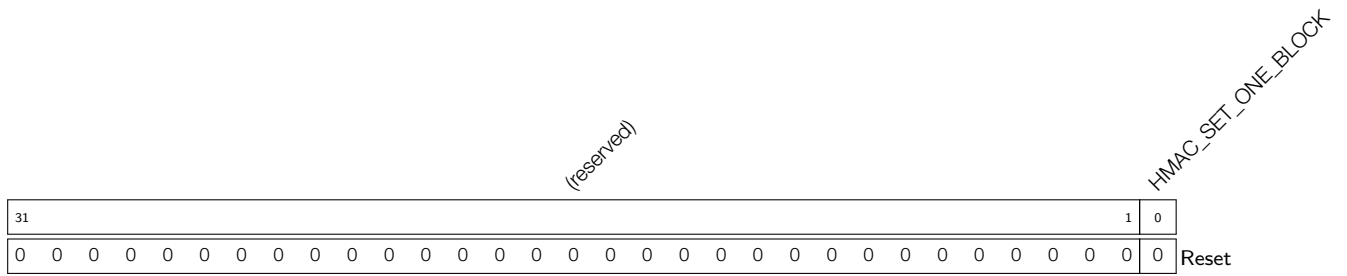

HMAC_SET_ONE_BLOCK Set this bit to show that no padding is required. (WO)

Register 21.17. HMAC_SOFT_JTAG_CTRL_REG (0x0F8)

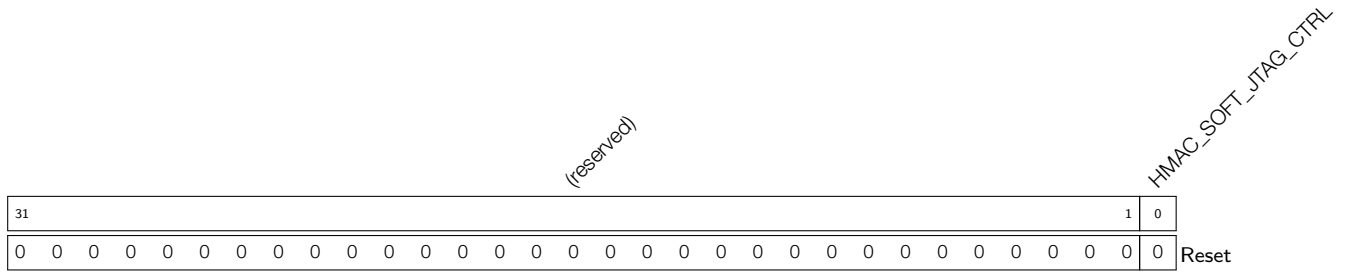

HMAC_SOFT_JTAG_CTRL Set this bit to turn on JTAG verification. (WO)

Register 21.18. HMAC_WR_JTAG_REG (0x0FC)

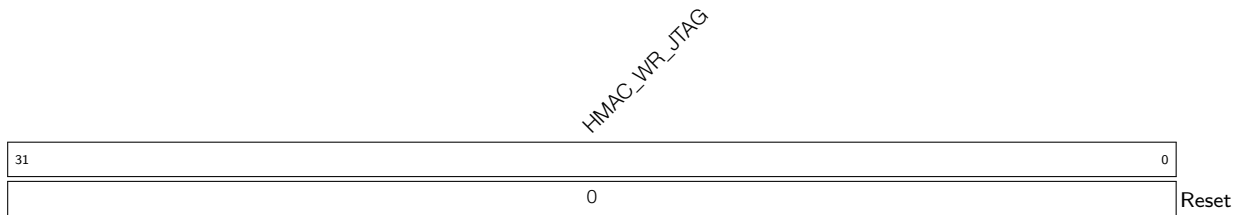

HMAC_WR_JTAG 32-bit of key to be compared. (WO)

Register 21.19. HMAC_DATE_REG (0x1FC)

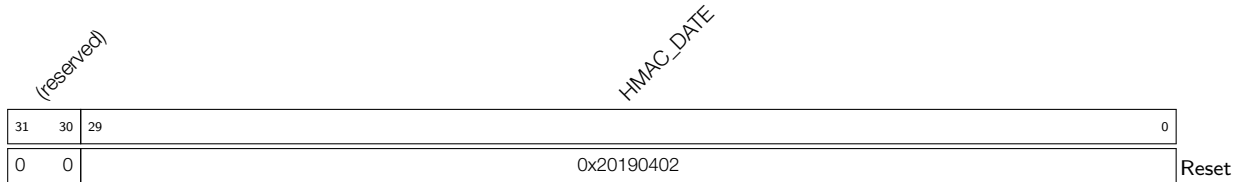

HMAC_DATE Version control register.(R/W)

22 Digital Signature (DS)

22.1 Overview

A Digital Signature is used to verify the authenticity and integrity of a message using a cryptographic algorithm. This can be used to validate a device's identity to a server, or to check the integrity of a message.

The ESP32-S3 includes a Digital Signature (DS) module providing hardware acceleration of messages' signatures based on RSA. It uses pre-encrypted parameters to calculate a signature. The parameters are encrypted using HMAC as a key-derivation function. In turn, the HMAC uses eFuses as an input key. The whole process happens in hardware so that neither the decryption key for the RSA parameters nor the input key for the HMAC key derivation function can be seen by the users while calculating the signature.

22.2 Features

- RSA Digital Signatures with key length up to 4096 bits
- Encrypted private key data, only decryptable by DS peripheral
- SHA-256 digest to protect private key data against tampering by an attacker

22.3 Functional Description

22.3.1 Overview

The DS peripheral calculates RSA signature as $Z = X^Y \bmod M$ where Z is the signature, X is the input message, Y and M are the RSA private key parameters.

Private key parameters are stored in flash or other memory as ciphertext. They are decrypted using a key (DS_KEY) which can only be read by the DS peripheral via the HMAC peripheral. The required inputs ($HMAC_KEY$) to generate the key are only stored in eFuse and can only be accessed by the HMAC peripheral. The DS peripheral hardware can decrypt the private key, and the private key in plaintext is never accessed by the software. For more detailed information about eFuse and HMAC peripherals, please refer to Chapter 5 [eFuse Controller](#) and 21 [HMAC Accelerator \(HMAC\)](#) peripheral.

The input message X will be sent directly to the DS peripheral by the software, each time a signature is needed. After the RSA signature operation, the signature Z is read back by the software.

For better understanding, we define some symbols and functions here, which are only applicable to this chapter:

- 1^s A bit string consist of s bits that stores "1".
- $[x]_s$ A bit string of s bits, in which s should be the integral multiple of 8 bits. If x is a number ($x < 2^s$), it is represented in little endian byte order in the bit string. x may be a variable value such as $[Y]_{4096}$ or as a hexadecimal constant such as $[0x0C]_8$. If necessary, the value $[x]_t$ can be right-padded with $(s - t)$ number of 0 to reach s bits in length, and finally get $[x]_s$. For example, $[0x05]_8 = 00000101$, $[0x05]_{16} = 0000010100000000$, $[0x0005]_{16} = 0000000000000101$, $[0x13]_8 = 00010011$, $[0x13]_{16} = 0001001100000000$, $[0x0013]_{16} = 0000000000010011$.
- $||$ A bit string concatenation operator for joining multiple bit strings into a longer bit string.

22.3.2 Private Key Operands

Private key operands Y (private key exponent) and M (key modulus) are generated by the user. They have a particular RSA key length (up to 4096 bits). Two additional private key operands are needed: \bar{r} and M' . These two operands are derived from Y and M .

Operands Y , M , \bar{r} and M' are encrypted by the user along with an authentication digest and stored as a single ciphertext C . C is inputted to the DS peripheral in this encrypted format, decrypted by the hardware, and then used for RSA signature calculation. Detailed description of how to generate C is provided in Section 22.3.3.

The DS peripheral supports RSA signature calculation $Z = X^Y \bmod M$, in which the length of operands should be $N = 32 \times x$ where $x \in \{1, 2, 3, \dots, 128\}$. The bit lengths of arguments Z , X , Y , M and \bar{r} should be an arbitrary value in N , and all of them in a calculation must be of the same length, while the bit length of M' should always be 32. For more detailed information about RSA calculation, please refer to Section 20.3.1 *Large Number Modular Exponentiation* in Chapter 20 *RSA Accelerator (RSA)*.

22.3.3 Software Prerequisites

The left side of Figure 22-1 lists preparations required by the software before the hardware starts RSA signature calculation, while the right side lists the hardware workflow during the entire calculation procedure.

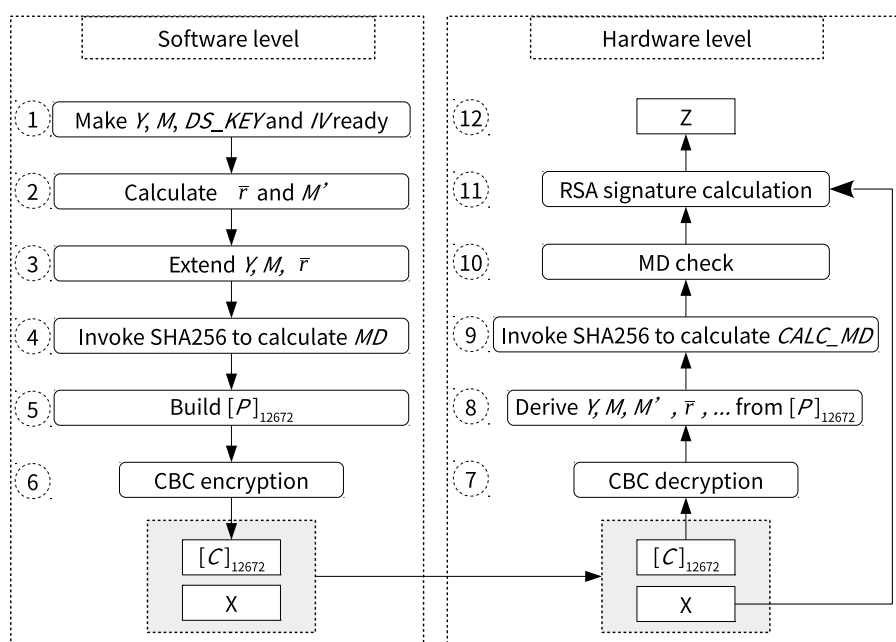

Figure 22-1. Software Preparations and Hardware Working Process

Note:

1. The software preparation (left side in the Figure 22-1) is a one-time operation before any signature is calculated, while the hardware calculation (right side in the Figure 1-1) repeats for every signature calculation.

Users need to follow the steps shown in the left part of Figure 22-1 to calculate C . Detailed instructions are as follows:

- **Step 1:** Prepare operands Y and M whose lengths should meet the requirements in Section 22.3.2.

Define $[L]_{32} = \frac{N}{32}$ (i.e., for RSA 4096, $[L]_{32} = [0x80]_{32}$). Prepare $[HMAC_KEY]_{256}$ and calculate $[DS_KEY]_{256}$ based on $DS_KEY = \text{HMAC-SHA256}([HMAC_KEY]_{256}, 1^{256})$. Generate a random $[IV]_{128}$ which should meet the requirements of the AES-CBC block encryption algorithm. For more information on AES, please refer to Chapter 19 *AES Accelerator (AES)*.

- **Step 2:** Calculate \bar{r} and M' based on M .
- **Step 3:** Extend Y , M and \bar{r} , in order to get $[Y]_{4096}$, $[M]_{4096}$ and $[\bar{r}]_{4096}$, respectively. This step is only required for Y , M and \bar{r} whose length are less than 4096 bits, since their largest length are 4096 bits.
- **Step 4** Calculate MD authentication code using the SHA-256:
 $[MD]_{256} = \text{SHA256}([Y]_{4096} || [M]_{4096} || [\bar{r}]_{4096} || [M']_{32} || [L]_{32} || [IV]_{128})$
- **Step 5:** Build $[P]_{12672} = ([Y]_{4096} || [M]_{4096} || [\bar{r}]_{4096} || [MD]_{256} || [M']_{32} || [L]_{32} || [\beta]_{64})$, where $[\beta]_{64}$ is a PKCS#7 padding value, i.e., a 64-bit string $[0x0808080808080808]_{64}$ composed of 8 bytes (value = 0x80). The purpose of $[\beta]_{64}$ is to make the bit length of P a multiple of 128.
- **Step 6:** Calculate $C = [C]_{12672} = \text{AES-CBC-ENC}([P]_{12672}, [DS_KEY]_{256}, [IV]_{128})$, where C is the ciphertext with length of 12672 bits.

22.3.4 DS Operation at the Hardware Level

The hardware operation is triggered each time a digital signature needs to be calculated. The inputs are the pre-generated private key ciphertext C , a unique message X , and IV .

The DS operation at the hardware level can be divided into the following three stages:

1. Decryption: Step 7 and 8 in Figure 22-1

The decryption process is the inverse of Step 6 in figure 22-1. The DS peripheral will call AES accelerator to decrypt C in CBC block mode and get the resulted plaintext. The decryption process can be represented by $P = \text{AES-CBC-DEC}(C, DS_KEY, IV)$, where IV (i.e., $[IV]_{128}$) is defined by users. $[DS_KEY]_{256}$ is provided by HMAC module, derived from $HMAC_KEY$ stored in eFuse. $[DS_KEY]_{256}$, as well as $[HMAC_KEY]_{256}$ are not readable by users.

With P , the DS peripheral can derive $[Y]_{4096}$, $[M]_{4096}$, $[\bar{r}]_{4096}$, $[M']_{32}$, $[L]_{32}$, MD authentication code, and the padding value $[\beta]_{64}$. This process is the inverse of Step 5.

2. Check: Step 9 and 10 in Figure 22-1

The DS peripheral will perform two checks: MD check and padding check. Padding check is not shown in Figure 22-1, as it happens at the same time with MD check.

- MD check: The DS peripheral calls SHA-256 to calculate the MD authentication code $[CALC_MD]_{256}$ from $[Y]_{4096} || [M]_{4096} || [\bar{r}]_{4096} || [M']_{32} || [L]_{32} || [IV]_{128}$. Then, $[CALC_MD]_{256}$ is compared against the pre-calculated MD authentication code $[MD]_{256}$ from step 4. Only when the two match, MD check passes.
- Padding check: The DS peripheral checks if $[\beta]_{64}$ complies with the aforementioned PKCS#7 format. Only when $[\beta]_{64}$ complies with the format, padding check passes.

The DS peripheral will only perform subsequent operations if MD check passes. If padding check fails, an error bit is set in the query register, but it does not affect the subsequent operations, i.e., it is up to the user to proceed or not.

3. Calculation: Step 11 and 12 in Figure 22-1

The DS peripheral treats X (input by users) and Y , M , \bar{r} (compiled) as big numbers. With M' , all operands to perform $X^Y \bmod M$ are in place. The operand length is defined by L . The DS peripheral will get the signed result Z by calling RSA to perform $Z = X^Y \bmod M$.

22.3.5 DS Operation at the Software Level

The following software steps should be followed each time a Digital Signature needs to be calculated. The inputs are the pre-generated private key ciphertext C , a unique message X , and IV . These software steps trigger the hardware steps described in Section 22.3.4.

We assume that the software has called the HMAC peripheral and HMAC on the hardware has calculated DS_KEY based on $HMAC_KEY$.

1. **Prerequisites:** Prepare operands C , X , IV according to Section 22.3.3.
2. **Activate the DS peripheral:** Write 1 to `DS_SET_START_REG`.
3. **Check if DS_KEY is ready:** Poll `DS_QUERY_BUSY_REG` until the software reads 0.

If the software does not read 0 in `DS_QUERY_BUSY_REG` after approximately 1 ms, it indicates a problem with HMAC initialization. In such a case, the software can read register `DS_QUERY_KEY_WRONG_REG` to get more information:

- If the software reads 0 in `DS_QUERY_KEY_WRONG_REG`, it indicates that the HMAC peripheral has not been activated.
 - If the software reads any value from 1 to 15 in `DS_QUERY_KEY_WRONG_REG`, it indicates that HMAC was activated, but the DS peripheral did not successfully receive the DS_KEY value from the HMAC peripheral. This may indicate that the HMAC operation has been interrupted due to a software concurrency problem.
4. **Configure register:** Write IV block to register `DS_IV_m_REG` (m : 0-3). For more information on the IV block, please refer to Chapter 19 *AES Accelerator (AES)*.
 5. **Write X to memory block `DS_X_MEM`:** Write X_i ($i \in \{0, 1, \dots, n - 1\}$), where $n = \frac{N}{32}$, to memory block `DS_X_MEM` whose capacity is 128 words. Each word can store one base- b digit. The memory block uses the little endian format for storage, i.e., the least significant digit of the operand is in the lowest address. Words in `DS_X_MEM` block after the configured length of X (N bits, as described in Section 22.3.2) are ignored.
 6. **Write C to memory block `DS_C_MEM`:** Write C_i ($i \in \{0, 1, \dots, 395\}$) to memory block `DS_C_MEM` whose capacity is 396 words. Each word can store one base- b digit.
 7. **Start DS operation:** Write 1 to register `DS_SET_ME_REG`.
 8. **Wait for the operation to be completed:** Poll register `DS_QUERY_BUSY_REG` until the software reads 0.
 9. **Query check result:** Read register `DS_QUERY_CHECK_REG` and determine the subsequent operations based on the return value.
 - If the value is 0, it indicates that both padding check and MD check pass. Users can continue to get the signed result Z .

- If the value is 1, it indicates that the padding check passes but MD check fails. The signed result Z is invalid. The operation will resume directly from Step 11.
 - If the value is 2, it indicates that the padding check fails but MD check passes. Users can continue to get the signed result Z . But please note that the data encapsulation format does not comply with the aforementioned PKCS#7 format, which may not be what you want.
 - If the value is 3, it indicates that both padding check and MD check fail. In this case, some fatal errors may occurred and the signed result Z is invalid. The operation will resume directly from Step 11.
10. **Read the signed result:** Read the signed result Z_i ($i \in \{0, 1, \dots, n - 1\}$), where $n = \frac{N}{32}$, from memory block [DS_Z_MEM](#). The memory block stores Z in little-endian byte order.
 11. **Exit the operation:** Write 1 to [DS_SET_FINISH_REG](#), then poll [DS_QUERY_BUSY_REG](#) until the software reads 0.

After the operation, all the input/output registers and memory blocks are cleared.

22.4 Memory Summary

The addresses in this section are relative to the [\[Digital Signature\]](#) base address provided in Table 4-3 in Chapter 4 *System and Memory*.

Name	Description	Size (byte)	Starting Address	Ending Address	Access
DS_C_MEM	Memory block C	1584	0x0000	0x062F	WO
DS_X_MEM	Memory block X	512	0x0800	0x09FF	WO
DS_Z_MEM	Memory block Z	512	0x0A00	0x0BFF	RO

22.5 Register Summary

The addresses in this section are relative to the Digital Signature base address provided in Table 4-3 in Chapter 4 *System and Memory*.

The abbreviations given in Column **Access** are explained in Section [Access Types for Registers](#).

Name	Description	Address	Access
Configuration Registers			
DS_IV_0_REG	IV block data	0x0630	WO
DS_IV_1_REG	IV block data	0x0634	WO
DS_IV_2_REG	IV block data	0x0638	WO
DS_IV_3_REG	IV block data	0x063C	WO
Status/Control Registers			
DS_SET_START_REG	Activates the DS peripheral	0x0E00	WO
DS_SET_ME_REG	Starts DS operation	0x0E04	WO
DS_SET_FINISH_REG	Ends DS operation	0x0E08	WO
DS_QUERY_BUSY_REG	Status of the DS peripheral	0x0E0C	RO
DS_QUERY_KEY_WRONG_REG	Checks the reason why <i>DS_KEY</i> is not ready	0x0E10	RO
DS_QUERY_CHECK_REG	Queries DS check result	0x0814	RO
Version Register			
DS_DATE_REG	Version control register	0x0820	W/R

22.6 Registers

The addresses in this section are relative to the Digital Signature base address provided in Table 4-3 in Chapter 4 *System and Memory*.

Register 22.1. DS_IV_m_REG (m: 0-3) (0x0630+4*m)

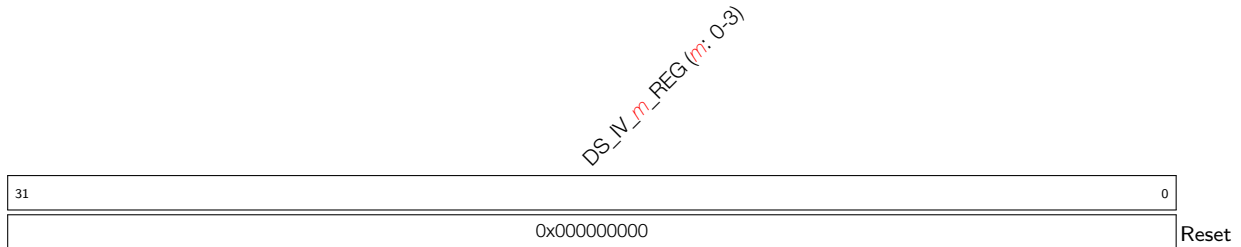

DS_IV_m_REG (m: 0-3) IV block data. (WO)

Register 22.2. DS_SET_START_REG (0x0E00)

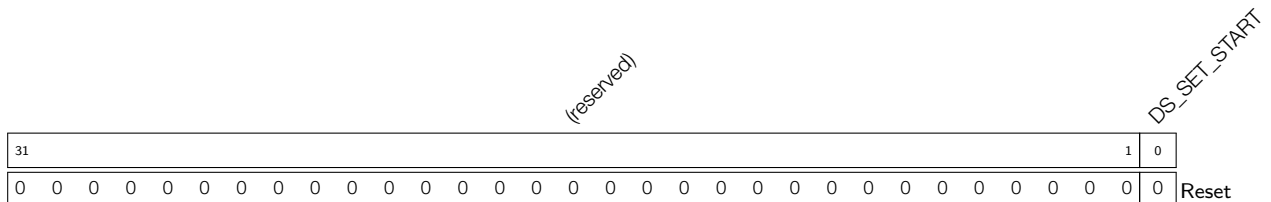

DS_SET_START Write 1 to this register to activate the DS peripheral. (WO)

Register 22.3. DS_SET_ME_REG (0x0E04)

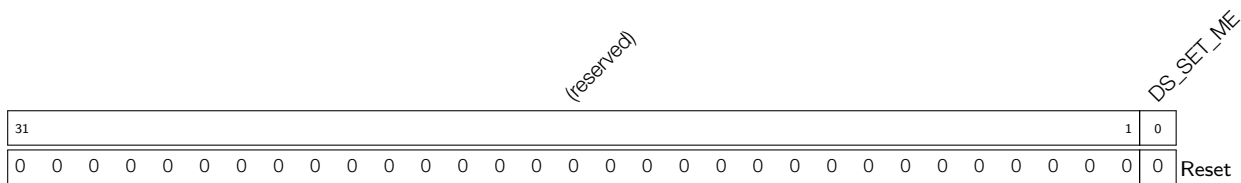

DS_SET_ME Write 1 to this register to start DS operation. (WO)

Register 22.4. DS_SET_FINISH_REG (0x0E08)

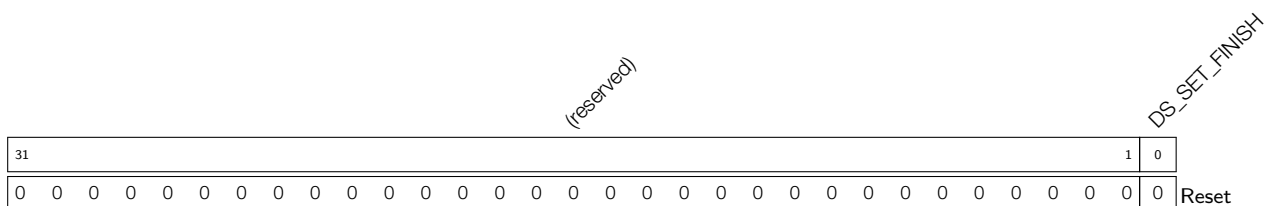

DS_SET_FINISH Write 1 to this register to end DS operation. (WO)

Register 22.5. DS_QUERY_BUSY_REG (0x0E0C)

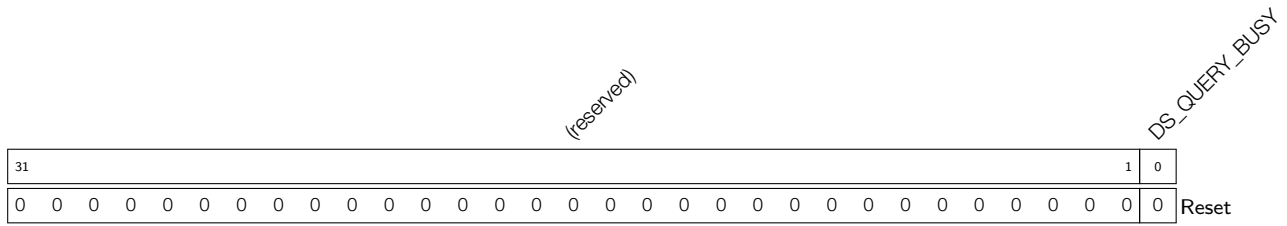

DS_QUERY_BUSY 1: The DS peripheral is busy; 0: The DS peripheral is idle. (RO)

Register 22.6. DS_QUERY_KEY_WRONG_REG (0x0E10)

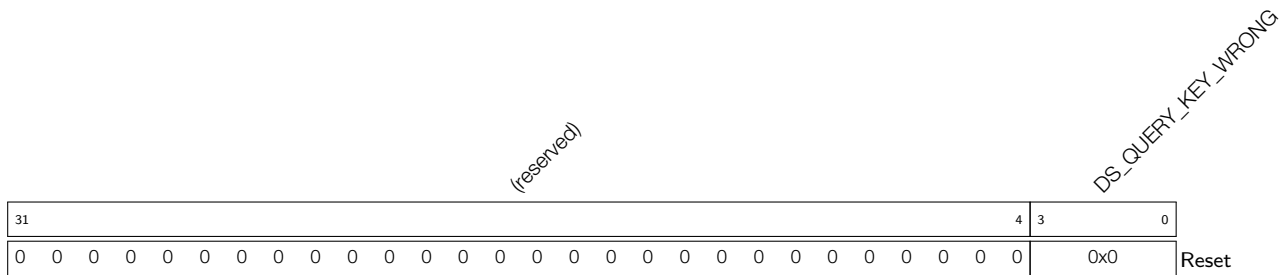

DS_QUERY_KEY_WRONG 1-15: HMAC was activated, but the DS peripheral did not successfully receive the *DS_KEY* from the HMAC peripheral. (The biggest value is 15); 0: HMAC is not activated. (RO)

Register 22.7. DS_QUERY_CHECK_REG (0x0E14)

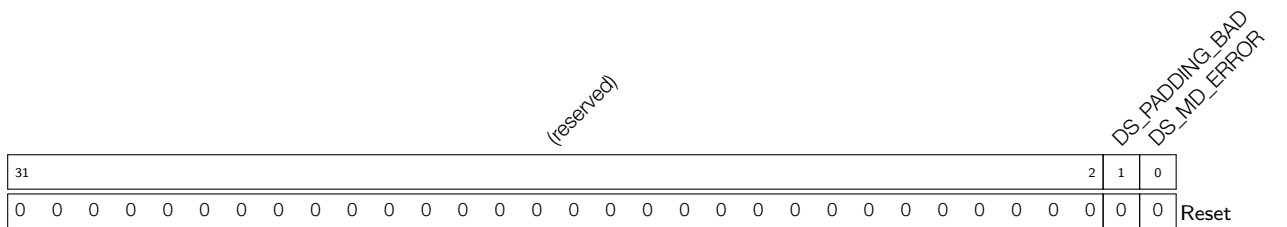

DS_PADDING_BAD 1: The padding check fails; 0: The padding check passes. (RO)

DS_MD_ERROR 1: The MD check fails; 0: The MD check passes. (RO)

Register 22.8. DS_DATE_REG (0x0E20)

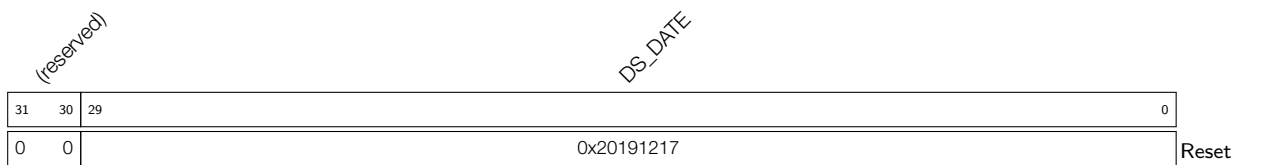

DS_DATE Version control register. (R/W)

23 External Memory Encryption and Decryption (XTS_AES)

23.1 Overview

The ESP32-S3 integrates an External Memory Encryption and Decryption module that complies with the XTS_AES standard algorithm specified in [IEEE Std 1619-2007](#), providing security for users' application code and data stored in the external memory (flash and RAM). Users can store proprietary firmware and sensitive data (e.g., credentials for gaining access to a private network) to the external flash, or store general data to the external RAM.

23.2 Features

- General XTS_AES algorithm, compliant with IEEE Std 1619-2007
- Software-based manual encryption
- High-speed auto encryption, without software's participation
- High-speed auto decryption, without software's participation
- Encryption and decryption functions jointly determined by registers configuration, eFuse parameters, and boot mode

23.3 Module Structure

The External Memory Encryption and Decryption module consists of three blocks, namely the Manual Encryption block, Auto Encryption block, and Auto Decryption block. The module architecture is shown in Figure 23-1.

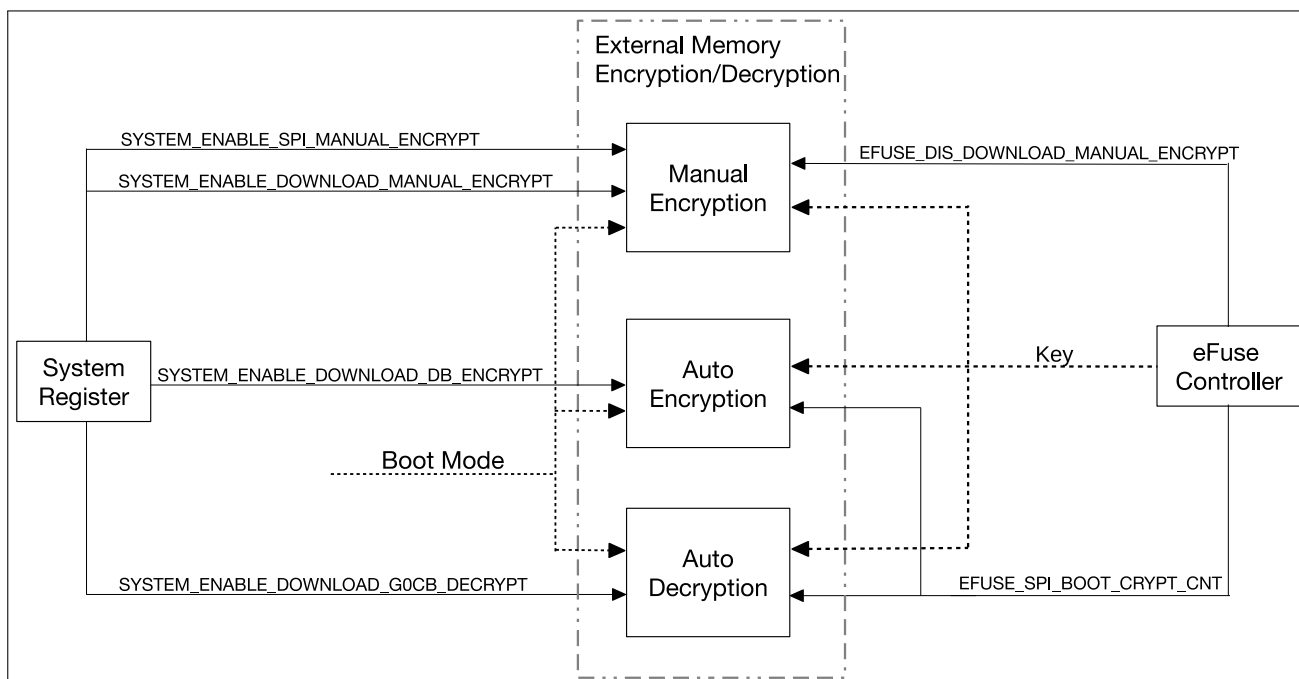

Figure 23-1. External Memory Encryption and Decryption Operation Settings

The Manual Encryption block can encrypt instructions/data which will then be written to the external flash as ciphertext via SPI1.

When the CPU writes data to the external RAM through cache, the Auto Encryption block will automatically encrypt the data first, then the data will be written to the external RAM as ciphertext.

When the CPU reads from the external flash or external RAM through cache, the Auto Decryption block will automatically decrypt the ciphertext to retrieve instructions and data.

In the System Registers (SYSREG) peripheral, the following four bits in register SYSTEM_EXTERNAL_DEVICE_ENCRYPT_DECRYPT_CONTROL_REG are relevant to the external memory encryption and decryption:

- SYSTEM_ENABLE_DOWNLOAD_MANUAL_ENCRYPT
- SYSTEM_ENABLE_DOWNLOAD_G0CB_DECRYPT
- SYSTEM_ENABLE_DOWNLOAD_DB_ENCRYPT
- SYSTEM_ENABLE_SPI_MANUAL_ENCRYPT

The XTS_AES module also fetches two parameters from the peripheral [5 eFuse Controller](#), which are: EFUSE_DIS_DOWNLOAD_MANUAL_ENCRYPT and EFUSE_SPI_BOOT_CRYPT_CNT.

23.4 Functional Description

23.4.1 XTS Algorithm

The manual encryption and auto encryption/decryption all use the same algorithm, i.e., XTS algorithm. During implementation, the XTS algorithm is characterized by a "data unit" of 1024 bits, which is defined in the Section *XTS-AES encryption procedure of XTS-AES Tweakable Block Cipher Standard*. For more information about XTS-AES algorithm, please refer to [IEEE Std 1619-2007](#).

23.4.2 Key

The Manual Encryption block, Auto Encryption block and Auto Decryption block share the same *Key* when implementing XTS algorithm. The *Key* is provided by the eFuse hardware and cannot be accessed by users.

The *Key* can be either 256-bit or 512-bit long. The value and length of the *Key* are determined by eFuse parameters. For easier description, now define:

- Block_A: the BLOCK in BLOCK4 ~ BLOCK9 whose key purpose is EFUSE_KEY_PURPOSE_XTS_AES_256_KEY_1. If Block_A is true, then the 256-bit *Key*_A is stored in it.
- Block_B: the BLOCK in BLOCK4 ~ BLOCK9 whose key purpose is EFUSE_KEY_PURPOSE_XTS_AES_256_KEY_2. If Block_B is true, then the 256-bit *Key*_B is stored in it.
- Block_C: the BLOCK in BLOCK4 ~ BLOCK9 whose key purpose is EFUSE_KEY_PURPOSE_XTS_AES_128_KEY. If Block_C is true, then the 256-bit *Key*_C is stored in it.

There are five possibilities of how the *Key* is generated depending on whether Block_A, Block_B and Block_C exists or not, as shown in Table 23-1. In each case, the *Key* can be uniquely determined by Block_A, Block_B or Block_C.

Table 23-1. *Key generated based on Key_A, Key_B and Key_C*

Block _A	Block _B	Block _C	Key	Key Length (bit)
Yes	Yes	Don't care	Key _A Key _B	512
Yes	No	Don't care	Key _A 0 ²⁵⁶	512
No	Yes	Don't care	0 ²⁵⁶ Key _B	512
No	No	Yes	Key _C	256
No	No	No	0 ²⁵⁶	256

Notes:

“YES” indicates that the block exists; “NO” indicates that the block does not exist; “0²⁵⁶” indicates a bit string that consists of 256-bit zeros; “||” is a bonding operator for joining one bit string to another.

For more information of key purposes, please refer to Table 5-2 *Secure Key Purpose Values* in Chapter 5 *eFuse Controller*.

23.4.3 Target Memory Space

The target memory space refers to a continuous address space in the external memory where the first encrypted ciphertext is stored. The target memory space can be uniquely determined by three relevant parameters: type, size and base address, whose definitions are listed below.

- Type: the *type* of the target memory space, either external flash or external RAM. Value 0 indicates external flash, while 1 indicates external RAM.
- Size: the *size* of the target memory space, indicating the number bytes encrypted in one encryption operation, which supports 16, 32 or 64 bytes.
- Base address: the *base_addr* of the target memory space. It is a 30-bit physical address, with range of 0x0000_0000 ~ 0x3FFF_FFFF. It should be aligned to *size*, i.e., $base_addr \% size == 0$.

For example, if there are 16 bytes of instruction data need to be encrypted and written to address 0x130 ~ 0x13F in the external flash, then the target space is 0x130 ~ 0x13F, type is 0 (external flash), size is 16 (bytes), and base address is 0x130.

The encryption of any length (must be multiples of 16 bytes) of plaintext instruction/data can be completed separately in multiple operations, and each operation has individual target memory space and the relevant parameters.

For Auto Encryption/Decryption blocks, these parameters are automatically defined by hardware. For Manual Encryption block, these parameters should be configured manually by users.

Note:

The “tweak” defined in Chapter 5.1 *Data units and tweaks* of [IEEE Std 1619-2007](#) is a 128-bit non-negative integer (*tweak*), which can be generated according to $tweak = type * 2^{30} + (base_addr \& 0x3FFFFFF80)$. The lowest 7 bits and the highest 97 bits in *tweak* are always zero.

23.4.4 Data Padding

For Auto Encryption/Decryption blocks, data padding is automatically completed by hardware. For Manual Encryption block, data padding should be completed manually by users. The Manual Encryption block has a

registers block which consists of 16 registers, i.e., XTS_AES_PLAIN_*n*_REG (*n*: 0-15), that are dedicated to data padding and can store up to 512 bits of plaintext instructions/data.

Actually, the Manual Encryption block does not care where the plaintext comes from, but only where the ciphertext will be stored. Because of the strict correspondence between plaintext and ciphertext, in order to better describe how the plaintext is stored in the register block, we assume that the plaintext is stored in the target memory space in the first place and replaced by ciphertext after encryption. Therefore, the following description no longer has the concept of “plaintext”, but uses “target memory space” instead. Please note that the plaintext can come from everywhere in actual use, but users should understand how the plaintext is stored in the register block.

How mapping works between target memory space and registers:

Assume a word in the target memory space is stored in *address*, define $offset = address \% 64$, $n = \frac{offset}{4}$, then the word will be stored in register XTS_AES_PLAIN_*n*_REG.

For example, if the *size* of the target memory space is 64, then all the 16 registers will be used for data storage. The mapping between *offset* and registers is shown in Table 23-2.

Table 23-2. Mapping Between Offsets and Registers

<i>offset</i>	Register	<i>offset</i>	Register
0x00	XTS_AES_PLAIN_0_REG	0x20	XTS_AES_PLAIN_8_REG
0x04	XTS_AES_PLAIN_1_REG	0x24	XTS_AES_PLAIN_9_REG
0x08	XTS_AES_PLAIN_2_REG	0x28	XTS_AES_PLAIN_10_REG
0x0C	XTS_AES_PLAIN_3_REG	0x2C	XTS_AES_PLAIN_11_REG
0x10	XTS_AES_PLAIN_4_REG	0x30	XTS_AES_PLAIN_12_REG
0x14	XTS_AES_PLAIN_5_REG	0x34	XTS_AES_PLAIN_13_REG
0x18	XTS_AES_PLAIN_6_REG	0x38	XTS_AES_PLAIN_14_REG
0x1C	XTS_AES_PLAIN_7_REG	0x3C	XTS_AES_PLAIN_15_REG

23.4.5 Manual Encryption Block

The Manual Encryption block is a peripheral module. It is equipped with registers and can be accessed by the CPU directly. Registers embedded in this block, the System Registers (SYSREG) peripheral, eFuse parameters, and boot mode jointly configure and use this module. Please note that the Manual Encryption block can only encrypt for storage in the external flash.

The Manual Encryption block is operational only under certain conditions. The operating conditions are:

- In SPI Boot mode

If bit SYSTEM_ENABLE_SPI_MANUAL_ENCRYPT in register SYSTEM_EXTERNAL_DEVICE_ENCRYPT_DECRYPT_CONTROL_REG is 1, the Manual Encryption block can be enabled. Otherwise, it is not operational.

- In Download Boot mode

If bit SYSTEM_ENABLE_DOWNLOAD_MANUAL_ENCRYPT in register SYSTEM_EXTERNAL_DEVICE_ENCRYPT_DECRYPT_CONTROL_REG is 1 and the eFuse parameter

EFUSE_DIS_DOWNLOAD_MANUAL_ENCRYPT is 0, the Manual Encryption block can be enabled. Otherwise, it is not operational.

Note:

- Even though the CPU can skip cache and get the encrypted instruction/data directly by reading the external memory, users can by no means access *Key*.

23.4.6 Auto Encryption Block

The Auto Encryption block is not a conventional peripheral, so it does not have any registers and cannot be accessed by the CPU directly. The System Registers (SYSREG) peripheral, eFuse parameters, and boot mode jointly configure and use this block.

The Auto Encryption block is operational only under certain conditions. The operating conditions are:

- In SPI Boot mode

If the first bit or the third bit in parameter SPI_BOOT_CRYPT_CNT (3 bits) is set to 1, then the Auto Encryption block can be enabled. Otherwise, it is not operational.

- In Download Boot mode

If bit SYSTEM_ENABLE_DOWNLOAD_DB_ENCRYPT in register SYSTEM_EXTERNAL_DEVICE_ENCRYPT_DECRYPT_CONTROL_REG is 1, the Auto Encryption block can be enabled. Otherwise, it is not operational.

Note:

- When the Auto Encryption block is enabled, it will automatically encrypt data if the CPU writes data to the external RAM, and then the encrypted ciphertext will be written to the external RAM. The entire encryption process does not need software participation and is transparent to the cache. Users can by no means obtain the encryption *Key* during the process.
- When the Auto Encryption block is disabled, it will ignore the CPU's access request to cache and do not process the data. Therefore, the data will be written to the external RAM as plaintext directly.

23.4.7 Auto Decryption Block

The Auto Decryption block is not a conventional peripheral, so it does not have any registers and cannot be accessed by the CPU directly. The System Registers (SYSREG) peripheral, eFuse parameters, and boot mode jointly configure and use this block.

The Auto Decryption block is operational only under certain conditions. The operating conditions are:

- In SPI Boot mode

If the first bit or the third bit in parameter SPI_BOOT_CRYPT_CNT (3 bits) is set to 1, then the Auto Decryption block can be enabled. Otherwise, it is not operational.

- In Download Boot mode

If bit SYSTEM_ENABLE_DOWNLOAD_G0CB_DECRYPT in register SYSTEM_EXTERNAL_DEVICE_ENCRYPT_DECRYPT_CONTROL_REG is 1, the Auto Decryption block

can be enabled. Otherwise, it is not operational.

Note:

- When the Auto Decryption block is enabled, it will automatically decrypt the ciphertext if the CPU reads instructions/data from the external memory via cache to retrieve the instructions/data. The entire decryption process does not need software participation and is transparent to the cache. Users can by no means obtain the decryption *Key* during the process.
- When the Auto Decryption block is disabled, it does not have any effect on the contents stored in the external memory, no matter they are encrypted or not. Therefore, what the CPU reads via cache is the original information stored in the external memory.

23.5 Software Process

When the Manual Encryption block operates, software needs to be involved in the process. The steps are as follows:

1. Configure XTS_AES:

- Set register `XTS_AES_DESTINATION_REG` to $type = 0$.
- Set register `XTS_AES_PHYSICAL_ADDRESS_REG` to $base_addr$.
- Set register `XTS_AES_LINESIZE_REG` to $\frac{size}{32}$.

For definitions of $type$, $base_addr$ and $size$, please refer to Section 23.4.3.

2. Pad plaintext data to the registers block `XTS_AES_PLAIN_n_REG` (n : 0-15). For detailed information, please refer to Section 23.4.4.

Please pad data to registers according to your actual needs, and the unused ones could be set to arbitrary values.

3. Wait for Manual Encrypt block to be idle. Poll register `XTS_AES_STATE_REG` until the software reads 0.

4. Trigger manual encryption by writing 1 to register `XTS_AES_TRIGGER_REG`.

5. Wait for the encryption process. Poll register `XTS_AES_STATE_REG` until the software reads 2.

Step 1 to 5 are the steps of encrypting plaintext instructions with the Manual Encryption block using the *Key*.

6. Grant the ciphertext access to SPI1. Write 1 to register `XTS_AES_RELEASE_REG` to grant SPI1 the access to the encrypted ciphertext. After this, the value of register `XTS_AES_STATE_REG` will become 3.

7. Call SPI1 to write the ciphertext in the external flash (see Chapter 30 *SPI Controller (SPI)*).

8. Destroy the ciphertext. Write 1 to register `XTS_AES_DESTROY_REG`. After this, the value of register `XTS_AES_STATE_REG` will become 0.

Repeat above steps to meet plaintext instructions/data encryption demands.

23.6 Register Summary

The addresses in this section are relative to the External Memory Encryption and Decryption base address provided in Table 4-3 in Chapter 4 *System and Memory*.

The abbreviations given in Column **Access** are explained in Section [Access Types for Registers](#).

Name	Description	Address	Access
Plaintext Register Heap			
XTS_AES_PLAIN_0_REG	Plaintext register 0	0x0000	R/W
XTS_AES_PLAIN_1_REG	Plaintext register 1	0x0004	R/W
XTS_AES_PLAIN_2_REG	Plaintext register 2	0x0008	R/W
XTS_AES_PLAIN_3_REG	Plaintext register 3	0x000C	R/W
XTS_AES_PLAIN_4_REG	Plaintext register 4	0x0010	R/W
XTS_AES_PLAIN_5_REG	Plaintext register 5	0x0014	R/W
XTS_AES_PLAIN_6_REG	Plaintext register 6	0x0018	R/W
XTS_AES_PLAIN_7_REG	Plaintext register 7	0x001C	R/W
XTS_AES_PLAIN_8_REG	Plaintext register 8	0x0020	R/W
XTS_AES_PLAIN_9_REG	Plaintext register 9	0x0024	R/W
XTS_AES_PLAIN_10_REG	Plaintext register 10	0x0028	R/W
XTS_AES_PLAIN_11_REG	Plaintext register 11	0x002C	R/W
XTS_AES_PLAIN_12_REG	Plaintext register 12	0x0030	R/W
XTS_AES_PLAIN_13_REG	Plaintext register 13	0x0034	R/W
XTS_AES_PLAIN_14_REG	Plaintext register 14	0x0038	R/W
XTS_AES_PLAIN_15_REG	Plaintext register 15	0x003C	R/W
Configuration Registers			
XTS_AES_LINESIZE_REG	Configures the size of target memory space	0x0040	R/W
XTS_AES_DESTINATION_REG	Configures the type of the external memory	0x0044	R/W
XTS_AES_PHYSICAL_ADDRESS_REG	Physical address	0x0048	R/W
Contro/Status Registers			
XTS_AES_TRIGGER_REG	Activates AES algorithm	0x004C	WO
XTS_AES_RELEASE_REG	Release control	0x0050	WO
XTS_AES_DESTROY_REG	Destroys control	0x0054	WO
XTS_AES_STATE_REG	Status register	0x0058	RO
Version Register			
XTS_AES_DATE_REG	Version control register	0x005C	RO

23.7 Registers

The addresses in this section are relative to the External Memory Encryption and Decryption base address provided in Table 4-3 in Chapter 4 *System and Memory*.

Register 23.1. XTS_AES_PLAIN_n_REG (n: 0-15) (0x0000+4*n)

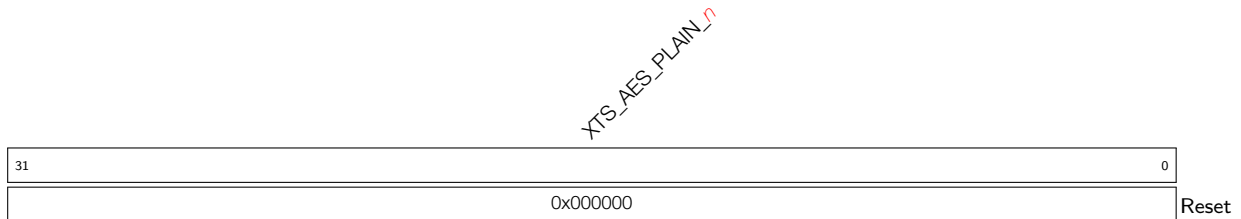

XTS_AES_PLAIN_n Stores *n*th 32-bit piece of plain text. (R/W)

Register 23.2. XTS_AES_LINESIZE_REG (0x0040)

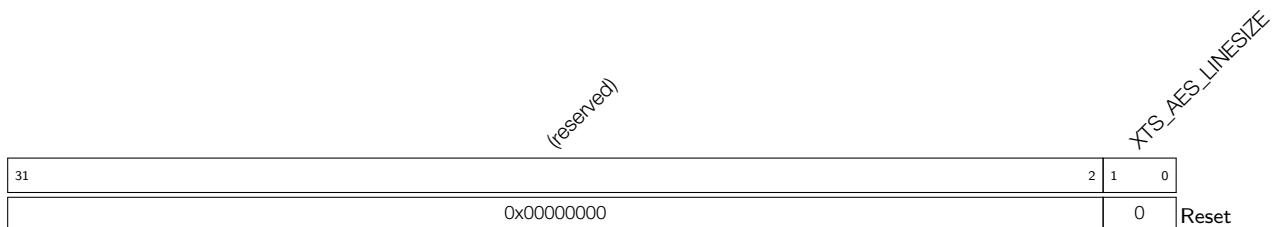

XTS_AES_LINESIZE Configures the data size of one encryption.

- 0: 16 bytes;
- 1: 32 bytes;
- 2: 64 bytes. (R/W)

Register 23.3. XTS_AES_DESTINATION_REG (0x0044)

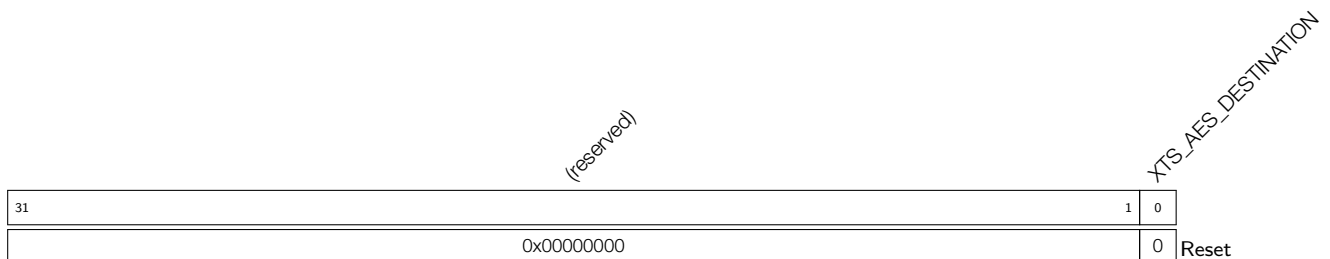

XTS_AES_DESTINATION Configures the type of the external memory. Currently, it must be set to 0, as the Manual Encryption block only supports flash encryption. Errors may occur if users write 1. 0: flash; 1: external RAM. (R/W)

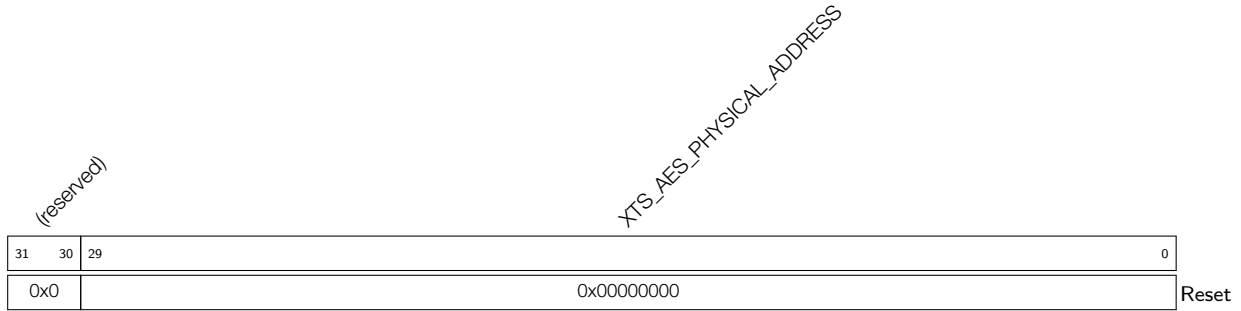
Register 23.4. XTS_AES_PHYSICAL_ADDRESS_REG (0x0048)

XTS_AES_PHYSICAL_ADDRESS Physical address. (R/W)

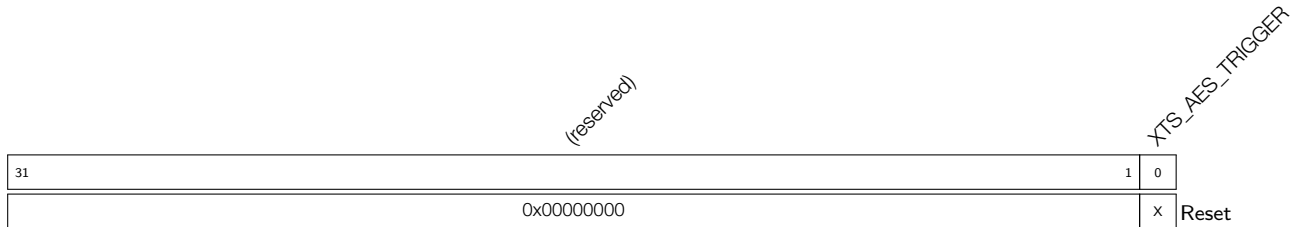
Register 23.5. XTS_AES_TRIGGER_REG (0x004C)

XTS_AES_TRIGGER Write 1 to enable manual encryption. (WO)

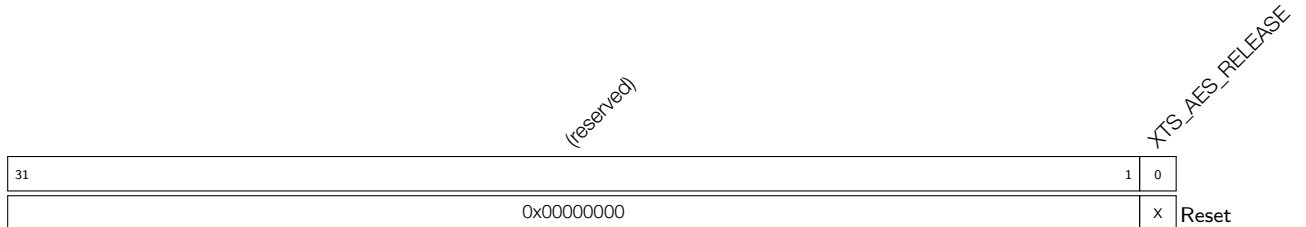
Register 23.6. XTS_AES_RELEASE_REG (0x0050)

XTS_AES_RELEASE Write 1 to grant SPI1 access to encrypted result. (WO)

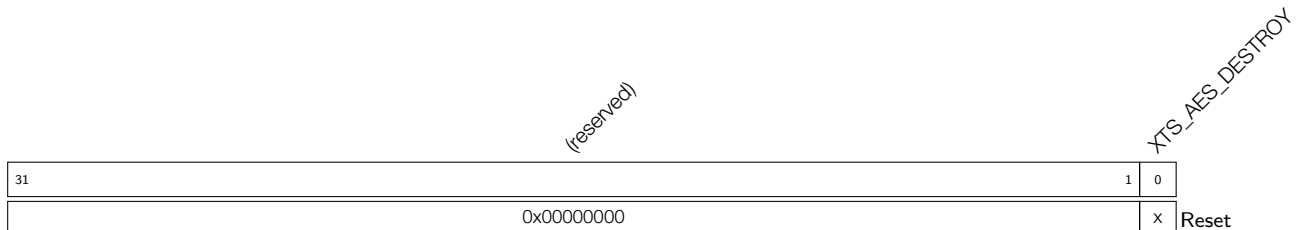
Register 23.7. XTS_AES_DESTROY_REG (0x0054)

XTS_AES_DESTROY Write 1 to destroy encrypted result. (WO)

Register 23.8. XTS_AES_STATE_REG (0x0058)

<i>(reserved)</i>		<i>XTS_AES_STATE</i>	
31	2	1	0
0x00000000			0x0
			Reset

XTS_AES_STATE Indicates the status of the Manual Encryption block. (RO)

- 0x0 (XTS_AES_IDLE): idle;
- 0x1 (XTS_AES_BUSY): busy with encryption;
- 0x2 (XTS_AES_DONE): encryption is completed, but the encrypted result is not accessible to SPI;
- 0x3 (XTS_AES_RELEASE): encrypted result is accessible to SPI.

Register 23.9. XTS_AES_DATE_REG (0x005C)

<i>(reserved)</i>		<i>XTS_AES_DATE</i>	
31	30	29	0
0	0	0x20200111	
			Reset

XTS_AES_DATE Version control register. (R/W)

24 Clock Glitch Detection

24.1 Overview

The Clock Glitch Detection module on ESP32-S3 detects glitches in external crystal XTAL_CLK signals, and generates a system reset signal (see Chapter 7 *Reset and Clock*) when detecting glitches to reset the whole digital circuit including RTC. By doing so, it prevents attackers from injecting glitches on external crystal XTAL_CLK clock to compromise ESP32-S3 and thus strengthens chip security.

24.2 Functional Description

24.2.1 Clock Glitch Detection

The Clock Glitch Detection module on ESP32-S3 monitors input clock signals from XTAL_CLK. If it detects a glitch, namely a clock pulse (a or b in the figure below) with a width shorter than 3 ns, input clock signals from XTAL_CLK are blocked.

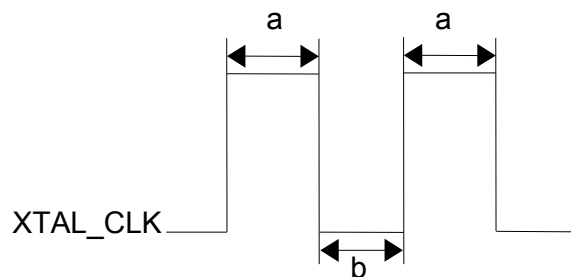

Figure 24-1. XTAL_CLK Pulse Width

24.2.2 Reset

Once detecting a glitch on XTAL_CLK that affects the circuit's normal operation, the Clock Glitch Detection module triggers a system reset if `RTC_CNTL_GLITCH_RST_EN` bit is enabled. By default, this bit is set to enable a reset.

25 Random Number Generator (RNG)

25.1 Introduction

The ESP32-S3 contains a true random number generator, which generates 32-bit random numbers that can be used for cryptographical operations, among other things.

25.2 Features

The random number generator in ESP32-S3 generates true random numbers, which means random number generated from a physical process, rather than by means of an algorithm. No number generated within the specified range is more or less likely to appear than any other number.

25.3 Functional Description

Every 32-bit value that the system reads from the `RNG_DATA_REG` register of the random number generator is a true random number. These true random numbers are generated based on the thermal noise in the system and the asynchronous clock mismatch.

Thermal noise comes from the high-speed ADC or SAR ADC or both. Whenever the high-speed ADC or SAR ADC is enabled, bit streams will be generated and fed into the random number generator through an XOR logic gate as random seeds.

When the `RC_FAST_CLK` clock is enabled for the digital core, the random number generator will also sample `RC_FAST_CLK` (20 MHz) as a random bit seed. `RC_FAST_CLK` is an asynchronous clock source and it increases the RNG entropy by introducing circuit metastability. However, to ensure maximum entropy, it's recommended to always enable an ADC source as well.

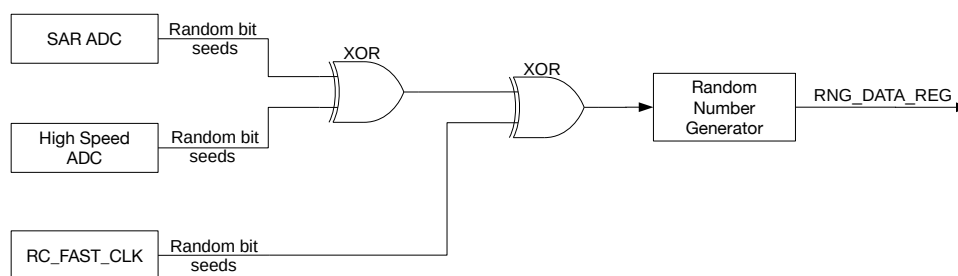

Figure 25-1. Noise Source

When there is noise coming from the SAR ADC, the random number generator is fed with a 2-bit entropy in one clock cycle of `RC_FAST_CLK` (20 MHz), which is generated from an internal RC oscillator (see Chapter 7 *Reset and Clock* for details). Thus, it is advisable to read the `RNG_DATA_REG` register at a maximum rate of 500 kHz to obtain the maximum entropy.

When there is noise coming from the high-speed ADC, the random number generator is fed with a 2-bit entropy in one APB clock cycle, which is normally 80 MHz. Thus, it is advisable to read the `RNG_DATA_REG` register at a maximum rate of 5 MHz to obtain the maximum entropy.

25.4 Programming Procedure

When using the random number generator, make sure at least either the SAR ADC, high-speed ADC, or RC_FAST_CLK is enabled. Otherwise, pseudo-random numbers will be returned.

- SAR ADC can be enabled by using the DIG ADC controller. For details, please refer to Chapter [39 On-Chip Sensors and Analog Signal Processing](#).
- High-speed ADC is enabled automatically when the Wi-Fi or Bluetooth modules is enabled.
- RC_FAST_CLK is enabled by setting the [RTC_CNTL_DIG_CLK8M_EN](#) bit in the [RTC_CNTL_CLK_CONF_REG](#) register.

Note:

Note that, when the Wi-Fi module is enabled, the value read from the high-speed ADC can be saturated in some extreme cases, which lowers the entropy. Thus, it is advisable to also enable the SAR ADC as the noise source for the random number generator for such cases.

When using the random number generator, read the [RNG_DATA_REG](#) register multiple times until sufficient random numbers have been generated. Ensure the rate at which the register is read does not exceed the frequencies described in section [25.3](#) above.

25.5 Register Summary

The address in the following table is relative to the random number generator base address provided in Table [4-3](#) in Chapter [4 System and Memory](#).

The abbreviations given in Column **Access** are explained in Section [Access Types for Registers](#).

Name	Description	Address	Access
RNG_DATA_REG	Random number data	0x0110	RO

25.6 Register

The address in this section is relative to the random number generator base address provided in Table [4-3](#) in Chapter [4 System and Memory](#).

Register 25.1. RNG_DATA_REG (0x0110)

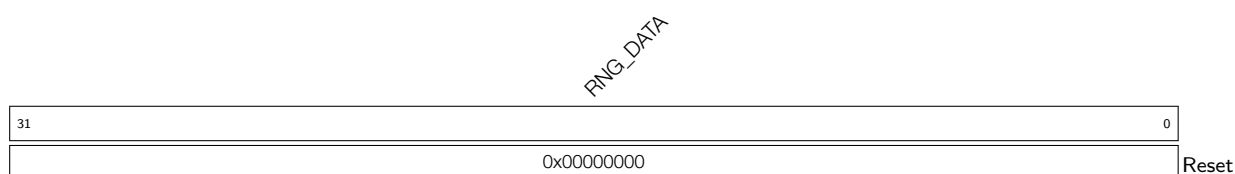

RNG_DATA Random number source. (RO)

26 UART Controller (UART)

26.1 Overview

In embedded system applications, data are required to be transferred in a simple way with minimal system resources. This can be achieved by a Universal Asynchronous Receiver/Transmitter (UART), which flexibly exchanges data with other peripheral devices in full-duplex mode. ESP32-S3 has three UART controllers compatible with various UART devices. They support Infrared Data Association (IrDA) and RS485 transmission.

Each of the three UART controllers has a group of registers that function identically. In this chapter, the three UART controllers are referred to as UART n , in which n denotes 0, 1, or 2.

A UART is a character-oriented data link for asynchronous communication between devices. Such communication does not provide any clock signal to send data. Therefore, in order to communicate successfully, the transmitter and the receiver must operate at the same baud rate with the same stop bit(s) and parity bit.

A UART data frame usually begins with one start bit, followed by data bits, one parity bit (optional) and one or more stop bits. UART controllers on ESP32-S3 support various lengths of data bits and stop bits. These controllers also support software and hardware flow control as well as GDMA for seamless high-speed data transfer. This allows developers to use multiple UART ports at minimal software cost.

26.2 Features

Each UART controller has the following features:

- Three clock sources that can be divided
- Programmable baud rate
- 1024 x 8-bit RAM shared by TX FIFOs and RX FIFOs of the three UART controllers
- Full-duplex asynchronous communication
- Automatic baud rate detection of input signals
- Data bits ranging from 5 to 8
- Stop bits of 1, 1.5, 2 or 3 bits
- Parity bit
- Special character AT_CMD detection
- RS485 protocol
- IrDA protocol
- High-speed data communication using GDMA
- UART as wake-up source
- Software and hardware flow control

26.3 UART Structure

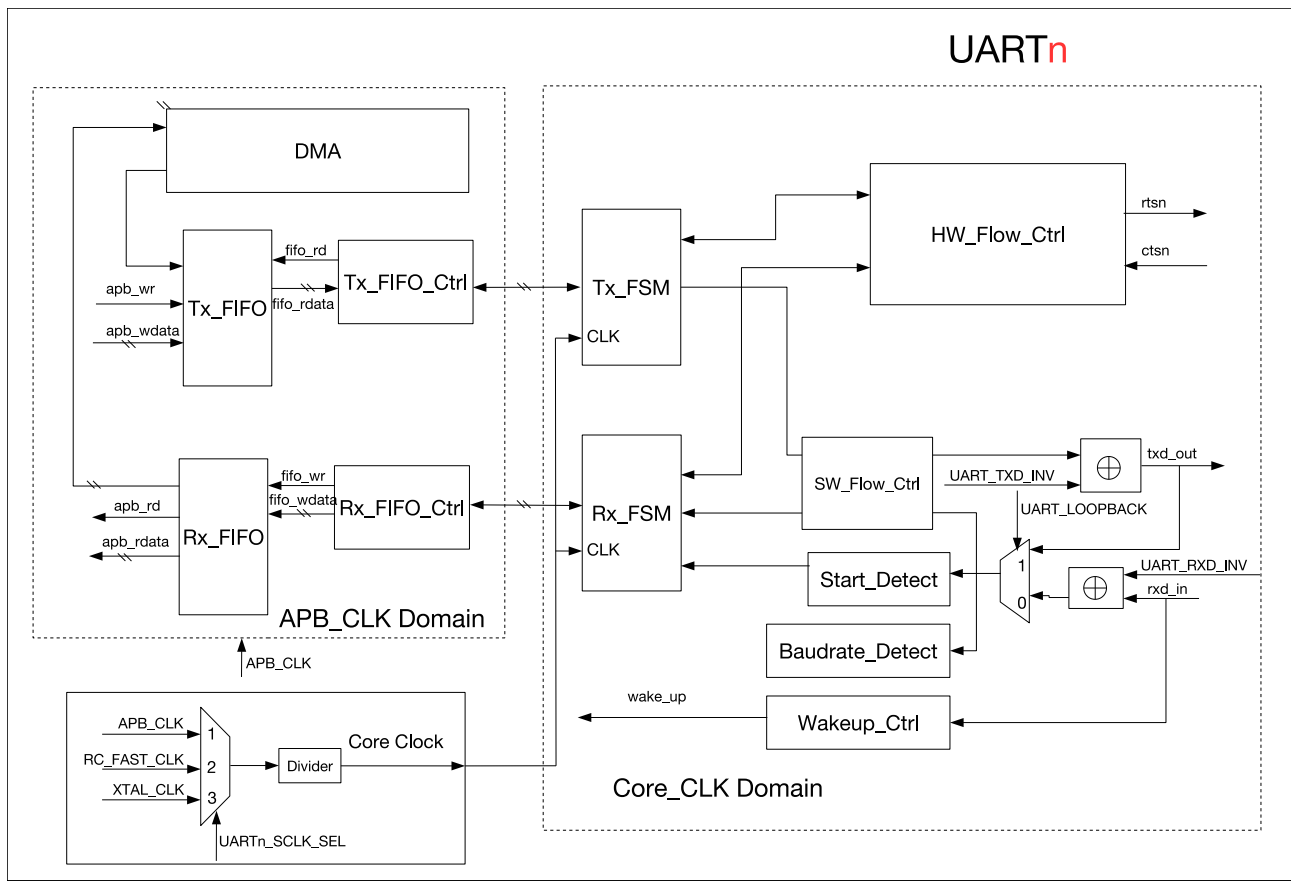

Figure 26-1. UART Structure

Figure 26-1 shows the basic structure of a UART controller. A UART controller works in two clock domains, namely APB_CLK domain and Core Clock domain (the UART Core's clock domain). The UART Core has three clock sources: 80 MHz APB_CLK, RC_FAST_CLK and external crystal clock XTAL_CLK (for details, please refer to Chapter 7 *Reset and Clock*), which are selected by configuring `UART_SCLK_SEL`. The selected clock source is divided by a divider to generate clock signals that drive the UART Core.

A UART controller is broken down into two parts: a transmitter and a receiver.

The transmitter contains a FIFO, called TX FIFO (or Tx_FIFO), which buffers data to be sent. Software can write data to the Tx_FIFO either via the APB bus, or using GDMA. Tx_FIFO_Ctrl controls writing and reading the Tx_FIFO. When Tx_FIFO is not empty, Tx_FSM reads data bits in the data frame via Tx_FIFO_Ctrl, and converts them into a bitstream. The levels of output signal txd_out can be inverted by configuring the `UART_TXD_INV` field.

The receiver also contains a FIFO, called RX FIFO (or Rx_FIFO), which buffers received data. The levels of input signal rxd_in can be inverted by configuring `UART_RXD_INV` field. Baudrate_Detect measures the baud rate of input signal rxd_in by detecting its minimum pulse width. Start_Detect detects the start bit in a data frame. If the start bit is detected, Rx_FSM stores data bits in the data frame into Rx_FIFO by Rx_FIFO_Ctrl. Software can read data from Rx_FIFO via the APB bus, or receive data using GDMA.

HW_Flow_Ctrl controls rxd_in and txd_out data flows by standard UART RTS and CTS flow control signals (rtsn_out and ctsn_in). SW_Flow_Ctrl controls data flows by automatically adding special characters to outgoing

data and detecting special characters in incoming data.

When a UART controller is in Light-sleep mode (see Chapter 10 *Low-power Management (RTC_CNTL)* for more details), Wakeup_Ctrl counts up rising edges of rxd_in. When the number reaches `UART_ACTIVE_THRESHOLD + 2`, a wake_up signal is generated and sent to RTC, which then wakes up the ESP32-S3 chip.

26.4 Functional Description

26.4.1 Clock and Reset

UART controllers are asynchronous. their configuration registers, TX FIFOs, and RX FIFOs are in APB_CLK domain, while the module controlling transmission and reception (i.e. UART Core) is in Core Clock domain. The latter can be sourced out of three clocks, namely APB_CLK, RC_FAST_CLK and external crystal clock XTAL_CLK, which can be selected by configuring `UART_SCLK_SEL`. The selected clock source can be divided. This divider supports fractional division, and the divisor is equal to:

$$UART_SCLK_DIV_NUM + \frac{UART_SCLK_DIV_B}{UART_SCLK_DIV_A}$$

The divisor ranges from 1 ~ 256.

When the frequency of the UART Core's clock is higher than the frequency needed to generate the baud rate, the UART Core can be clocked at a lower frequency by the divider, in order to reduce power consumption. Usually, the UART Core's clock frequency is lower than the APB_CLK's frequency, and can be divided by the largest divisor value when higher than the frequency needed to generate the baud rate. The frequency of the UART Core's clock can also be at most twice higher than the APB_CLK. The clock for the UART transmitter and the UART receiver can be controlled independently. To enable the clock for the UART transmitter, `UART_TX_SCLK_EN` shall be set; to enable the clock for the UART receiver, `UART_RX_SCLK_EN` shall be set.

Section 26.5 explains the procedure to ensure that the configured register values are synchronized between APB_CLK domain and Core Clock domain.

Section 26.5.2.1 explains the procedure to reset the whole UART controller. Note that it is not recommended to only reset the APB clock domain module or UART Core.

26.4.2 UART RAM

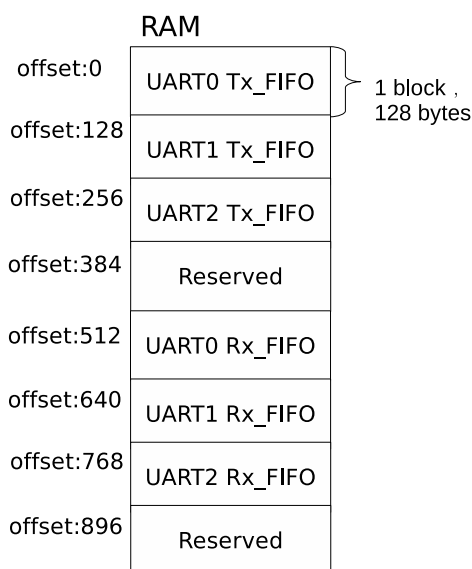

Figure 26-2. UART Controllers Sharing RAM

All three UART controllers on ESP32-S3 share 1024×8 bits of RAM. As Figure 26-2 illustrates, the RAM is divided into 8 blocks, each having 128×8 bits. Figure 26-2 shows how many RAM blocks are allocated by default to TX and RX FIFOs for each of the three UART controllers. UART n Tx_FIFO can be expanded by configuring `UART_TX_SIZE`, while UART n Rx_FIFO can be expanded by configuring `UART_RX_SIZE`. Some limits are imposed:

- UART0 Tx_FIFO can be increased up to 8 blocks (the whole RAM);
- UART1 Tx_FIFO can be increased up to 7 blocks (from offset 128 to the end address);
- UART2 Tx_FIFO can be increased up to 6 blocks (from offset 256 to the end address);
- UART0 Rx_FIFO can be increased up to 4 blocks (from offset 512 to the end address);
- UART1 Rx_FIFO can be increased up to 3 blocks (from offset 640 to the end address);
- UART2 Rx_FIFO can be increased up to 2 blocks (from offset 768 to the end address).

Please note that starting addresses of all FIFOs are fixed, so expanding one FIFO may take up the default space of other FIFOs. For example, by setting `UART_TX_SIZE` of UART0 to 2, the size of UART0 Tx_FIFO is increased by 128 bytes (from offset 0 to offset 255). In this case, UART0 Tx_FIFO takes up the default space for UART1 Tx_FIFO, and UART1's transmitting function cannot be used as a result.

When neither of the three UART controllers is active, RAM can enter low-power mode by setting `UART_MEM_FORCE_PD`.

UART n Tx_FIFO is reset by setting `UART_TXFIFO_RST`. UART n Rx_FIFO is reset by setting `UART_RXFIFO_RST`.

The "empty" signal threshold for Tx_FIFO is configured by setting `UART_TXFIFO_EMPTY_THRHD`. When data stored in Tx_FIFO is less than `UART_TXFIFO_EMPTY_THRHD`, a `UART_TXFIFO_EMPTY_INT` interrupt is generated. The "full" signal threshold for Rx_FIFO is configured by setting `UART_RXFIFO_FULL_THRHD`. When data stored in Rx_FIFO is equal to or greater than `UART_RXFIFO_FULL_THRHD`, a `UART_RXFIFO_FULL_INT`

interrupt is generated. In addition, when Rx_FIFO receives more data than its capacity, a UART_RXFIFO_OVF_INT interrupt is generated.

TX FIFO and RX FIFO can be accessed via the APB bus or GDMA. Access via the APB bus is performed through register `UART_FIFO_REG`. You can put data into TX FIFO by writing `UART_RXFIFO_RD_BYTE`, and get data in RX FIFO by reading this exact same field. For access via GDMA, please refer to Section 26.4.11.

26.4.3 Baud Rate Generation and Detection

26.4.3.1 Baud Rate Generation

Before a UART controller sends or receives data, the baud rate should be configured by setting corresponding registers. The baud rate generator of a UART controller functions by dividing the input clock source. It can divide the clock source by a fractional amount. The divisor is configured by `UART_CLKDIV_REG`: `UART_CLKDIV` for the integer part, and `UART_CLKDIV_FRAG` for the fractional part. When using the 80 MHz input clock, the UART controller supports a maximum baud rate of 5 Mbaud.

The divisor of the baud rate is equal to

$$UART_CLKDIV + \frac{UART_CLKDIV_FRAG}{16}$$

meaning that the final baud rate is equal to

$$\frac{INPUT_FREQ}{UART_CLKDIV + \frac{UART_CLKDIV_FRAG}{16}}$$

where `INPUT_FREQ` is the frequency of UART Core's source clock. For example, if `UART_CLKDIV` = 694 and `UART_CLKDIV_FRAG` = 7 then the divisor value is

$$694 + \frac{7}{16} = 694.4375$$

When `UART_CLKDIV_FRAG` is 0, the baud rate generator is an integer clock divider where an output pulse is generated every `UART_CLKDIV` input pulses.

When `UART_CLKDIV_FRAG` is not 0, the divider is fractional and the output baud rate clock pulses are not strictly uniform. As shown in Figure 26-3, for every 16 output pulses, the frequency of some pulses is $INPUT_FREQ / (UART_CLKDIV + 1)$, and the frequency of the other pulses is $INPUT_FREQ / UART_CLKDIV$. A total of `UART_CLKDIV_FRAG` output pulses are generated by dividing $(UART_CLKDIV + 1)$ input pulses, and the remaining $(16 - UART_CLKDIV_FRAG)$ output pulses are generated by dividing `UART_CLKDIV` input pulses.

The output pulses are interleaved as shown in Figure 26-3 below, to make the output timing more uniform:

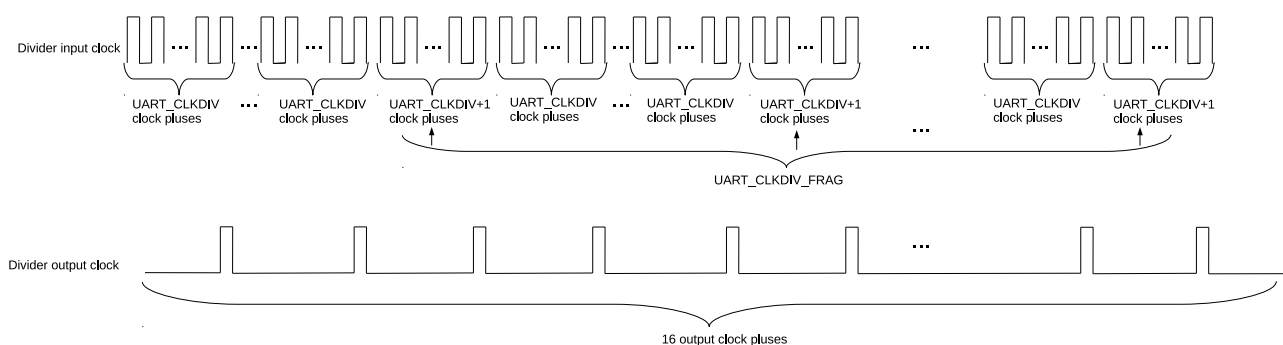

Figure 26-3. UART Controllers Division

To support IrDA (see Section 26.4.7 for details), the fractional clock divider for IrDA data transmission generates clock signals divided by $16 \times \text{UART_CLKDIV_REG}$. This divider works similarly as the one elaborated above: it takes $\text{UART_CLKDIV}/16$ as the integer value and the lowest four bits of UART_CLKDIV as the fractional value.

26.4.3.2 Baud Rate Detection

Automatic baud rate detection (Autobaud) on UARTs is enabled by setting `UART_AUTOBAUD_EN`. The Baudrate_Detect module shown in Figure 26-1 filters any noise whose pulse width is shorter than `UART_GLITCH_FILT`.

Before communication starts, the transmitter can send random data to the receiver for baud rate detection. `UART_LOWPULSE_MIN_CNT` stores the minimum low pulse width, `UART_HIGHPULSE_MIN_CNT` stores the minimum high pulse width, `UART_POSEDGE_MIN_CNT` stores the minimum pulse width between two rising edges, and `UART_NEGEDGE_MIN_CNT` stores the minimum pulse width between two falling edges. These four fields are read by software to determine the transmitter's baud rate.

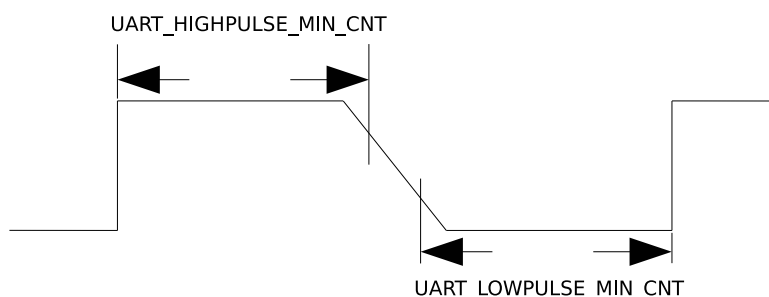

Figure 26-4. The Timing Diagram of Weak UART Signals Along Falling Edges

The baud rate can be determined in the following three ways:

1. Normally, to avoid sampling erroneous data along rising or falling edges in a metastable state, which results in the inaccuracy of `UART_LOWPULSE_MIN_CNT` or `UART_HIGHPULSE_MIN_CNT`, use a weighted average of these two values to eliminate errors. In this case, the baud rate is calculated as follows:

$$B_{\text{uart}} = \frac{f_{\text{clk}}}{(\text{UART_LOWPULSE_MIN_CNT} + \text{UART_HIGHPULSE_MIN_CNT} + 2)/2}$$

2. If UART signals are weak along falling edges as shown in Figure 26-4, which leads to an inaccurate average of `UART_LOWPULSE_MIN_CNT` and `UART_HIGHPULSE_MIN_CNT`, use `UART_POSEDGE_MIN_CNT` to determine the transmitter's baud rate as follows:

$$B_{\text{uart}} = \frac{f_{\text{clk}}}{(\text{UART_POSEDGE_MIN_CNT} + 1)/2}$$

3. If UART signals are weak along rising edges, use `UART_NEGEDGE_MIN_CNT` to determine the transmitter's baud rate as follows:

$$B_{\text{uart}} = \frac{f_{\text{clk}}}{(\text{UART_NEGEDGE_MIN_CNT} + 1)/2}$$

26.4.4 UART Data Frame

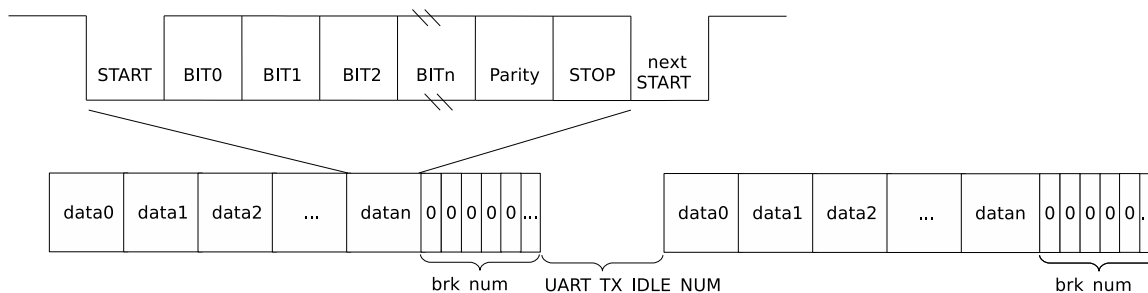

Figure 26-5. Structure of UART Data Frame

Figure 26-5 shows the basic structure of a data frame. A frame starts with one START bit, and ends with STOP bits which can be 1, 1.5, 2 or 3 bits long, configured by `UART_STOP_BIT_NUM`, `UART_DL1_EN` and `UART_DLO_EN`. The START bit is logical low, whereas STOP bits are logical high.

The actual data length can be anywhere between 5 ~ 8 bits, configured by `UART_BIT_NUM`. When `UART_PARITY_EN` is set, a parity bit is added after data bits. `UART_PARITY` is used to choose even parity or odd parity. When the receiver detects a parity bit error in the data received, a `UART_PARITY_ERR_INT` interrupt is generated, and the erroneous data are still stored into the RX FIFO. When the receiver detects a data frame error, a `UART_FRM_ERR_INT` interrupt is generated, and the erroneous data by default is stored into the RX FIFO.

If all data in `Tx_FIFO` have been sent, a `UART_TX_DONE_INT` interrupt is generated. After this, if the `UART_TXD_BRK` bit is set then the transmitter will enter the Break condition and send several NULL characters in which the TX data line is logical low. The number of NULL characters is configured by `UART_TX_BRK_NUM`. Once the transmitter has sent all NULL characters, a `UART_TX_BRK_DONE_INT` interrupt is generated. The minimum interval between data frames can be configured using `UART_TX_IDLE_NUM`. If the transmitter stays idle for `UART_TX_IDLE_NUM` or more time (in the unit of bit time, i.e. the time it takes to transfer one bit), a `UART_TX_BRK_IDLE_DONE_INT` interrupt is generated.

The receiver can also detect the Break conditions when the RX data line remains logical low for one NULL character transmission, and a `UART_BRK_DET_INT` interrupt will be triggered to detect that a Break condition has been completed.

The receiver can detect the current bus state through the timeout interrupt `UART_RXFIFO_TOUT_INT`. The `UART_RXFIFO_TOUT_INT` interrupt will be triggered when the bus is in the idle state for more than `UART_RX_TOUT_THRHD` bit time on current baud rate after the receiver has received at least one byte. You can use this interrupt to detect whether all the data from the transmitter has been sent.

26.4.5 AT_CMD Character Structure

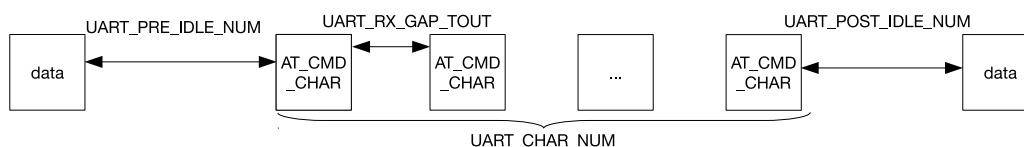

Figure 26-6. AT_CMD Character Structure

Figure 26-6 is the structure of a special character AT_CMD. If the receiver constantly receives AT_CMD_CHAR and the following conditions are met, a UART_AT_CMD_CHAR_DET_INT interrupt is generated. The specific value of AT_CMD_CHAR can be read from UART_n_AT_CMD_CHAR.

- The interval between the first AT_CMD_CHAR and the last non-AT_CMD_CHAR character is at least `UART_PRE_IDLE_NUM` cycles.
- The interval between two AT_CMD_CHAR characters is less than `UART_RX_GAP_TOUT` cycles.
- The number of AT_CMD_CHAR characters is equal to or greater than `UART_CHAR_NUM`.
- The interval between the last AT_CMD_CHAR character and next non-AT_CMD_CHAR character is at least `UART_POST_IDLE_NUM` cycles.

26.4.6 RS485

All three UART controllers support RS485 protocol. This protocol uses differential signals to transmit data, so it can communicate over longer distances at higher bit rates than RS232. RS485 has two-wire half-duplex mode and four-wire full-duplex modes. UART controllers support two-wire half-duplex transmission and bus snooping. In a two-wire RS485 multidrop network, there can be 32 slaves at most.

26.4.6.1 Driver Control

As shown in Figure 26-7, in a two-wire multidrop network, an external RS485 transceiver is needed for differential to single-ended conversion. An RS485 transceiver contains a driver and a receiver. When a UART controller is not in transmitter mode, the connection to the differential line can be broken by disabling the driver. When the DE (Driver Enable) signal is 1, the driver is enabled; when DE is 0, the driver is disabled.

The UART receiver converts differential signals to single-ended signals via an external receiver. RE is the enable control signal for the receiver. When RE is 0, the receiver is enabled; when RE is 1, the receiver is disabled. If RE is configured as 0, the UART controller is allowed to snoop data on the bus, including the data sent by itself.

DE can be controlled by either software or hardware. To reduce the cost of software, DE is controlled by hardware in our design. As shown in Figure 26-7, DE is connected to `dtrn_out` of UART (please refer to Section 26.4.10.1 for more details).

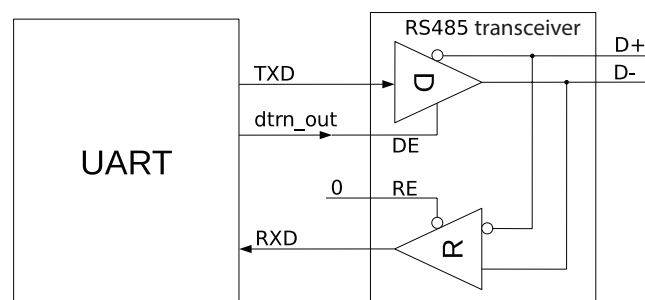

Figure 26-7. Driver Control Diagram in RS485 Mode

26.4.6.2 Turnaround Delay

By default, all three UART controllers work in receiver mode. When a UART controller is switched from transmitter mode to receiver mode, the RS485 protocol requires a turnaround delay of one cycle after the stop bit. The UART transmitter supports adding a turnaround delay of one cycle not only before the start bit but also

after the stop bit. When `UART_DLO_EN` is set, a turnaround delay of one cycle is added before the start bit; when `UART_DL1_EN` is set, a turnaround delay of one cycle is added after the stop bit.

26.4.6.3 Bus Snooping

In a two-wire multidrop network, UART controllers support bus snooping if RE of the external RS485 transceiver is 0. By default, a UART controller is not allowed to transmit and receive data simultaneously. If `UART_RS485TX_RX_EN` is set and the external RS485 transceiver is configured as in Figure 26-7, a UART controller may receive data in transmitter mode and snoop the bus. If `UART_RS485RXBY_TX_EN` is set, a UART controller may transmit data in receiver mode.

All three UART controllers can snoop the data sent by themselves. In transmitter mode, when a UART controller monitors a collision between the data sent and the data received, a `UART_RS485_CLASH_INT` interrupt is generated; when it monitors a data frame error, a `UART_RS485_FRM_ERR_INT` interrupt is generated; when it monitors a polarity error, a `UART_RS485_PARITY_ERR_INT` is generated.

26.4.7 IrDA

IrDA protocol consists of three layers, namely the physical layer, the link access protocol, and the link management protocol. The three UART controllers implement IrDA's physical layer. In IrDA encoding, a UART controller supports data rates up to 115.2 kbit/s (SIR, or serial infrared mode). As shown in Figure 26-8, the IrDA encoder converts a NRZ (non-return to zero code) signal to a RZI (return to zero inverted code) signal and sends it to the external driver and infrared LED. This encoder uses modulated signals whose pulse width is 3/16 bits to indicate logic "0", and low levels to indicate logic "1". The IrDA decoder receives signals from the infrared receiver and converts them to NRZ signals. In most cases, the receiver is high when it is idle, and the encoder output polarity is the opposite of the decoder input polarity. If a low pulse is detected, it indicates that a start bit has been received.

When IrDA function is enabled, one bit is divided into 16 clock cycles. If the bit to be sent is zero, then the 9th, 10th and 11th clock cycle are high.

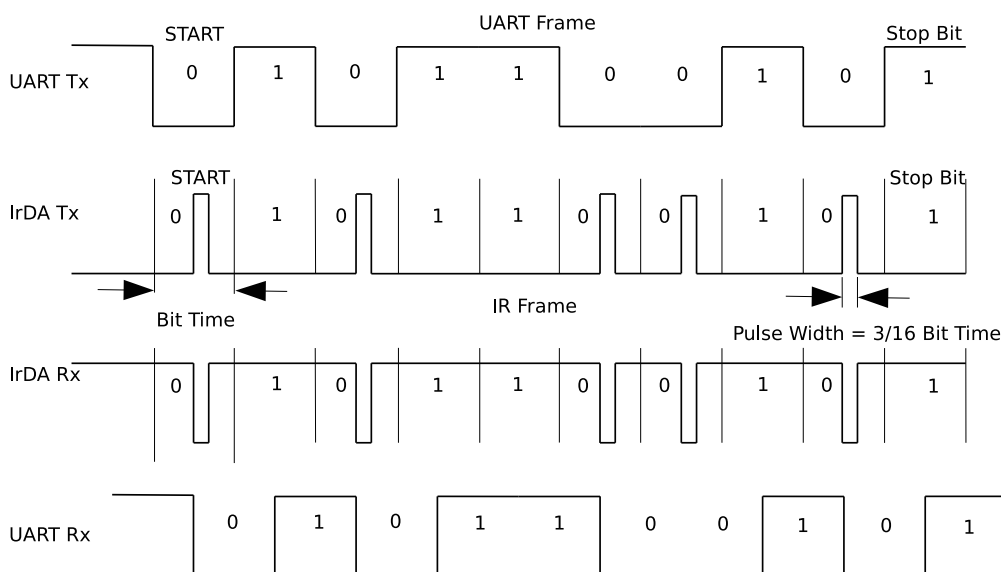

Figure 26-8. The Timing Diagram of Encoding and Decoding in SIR mode

The IrDA transceiver is half-duplex, meaning that it cannot send and receive data simultaneously. As shown in

Figure 26-9, IrDA function is enabled by setting `UART_IRDA_EN`. When `UART_IRDA_TX_EN` is set (high), the IrDA transceiver is enabled to send data and not allowed to receive data; when `UART_IRDA_TX_EN` is reset (low), the IrDA transceiver is enabled to receive data and not allowed to send data.

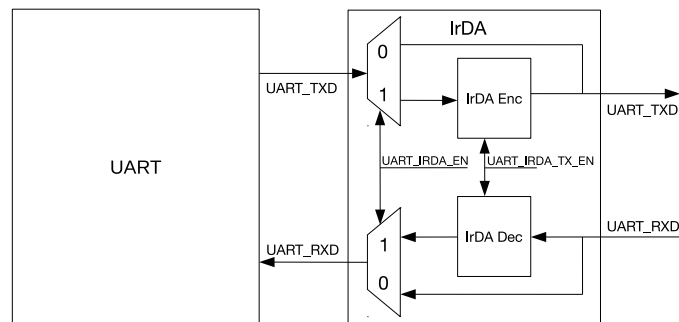

Figure 26-9. IrDA Encoding and Decoding Diagram

26.4.8 Wake-up

UART0 and UART1 can be set as a wake-up source for Light-sleep mode. To be specific Wakeup_Ctrl counts up the rising edges of rxd_in, and when this count becomes greater than `UART_ACTIVE_THRESHOLD + 2`, a wake_up signal is generated and sent to RTC, which then wakes ESP32-S3 up.

26.4.9 Loopback Test

UART n supports loopback testing, which can be enabled by setting `UART_LOOPBACK`. When loopback testing is enabled, UART output signal txd_out is connected to its input signal rxd_in, rtsn_out is connected to ctsn_in, and dtrn_out is connected to dsrn_out. Data are then sent out through txd_out. If the data received match the data sent, it indicates that UART n controller is working properly.

26.4.10 Flow Control

UART controllers have two ways to control data flow, namely hardware flow control and software flow control. Hardware flow control is achieved using output signal rtsn_out and input signal dsrn_in. Software flow control is achieved by inserting special characters (XON or XOFF) in the data flow sent and detecting special characters in the data flow received.

26.4.10.1 Hardware Flow Control

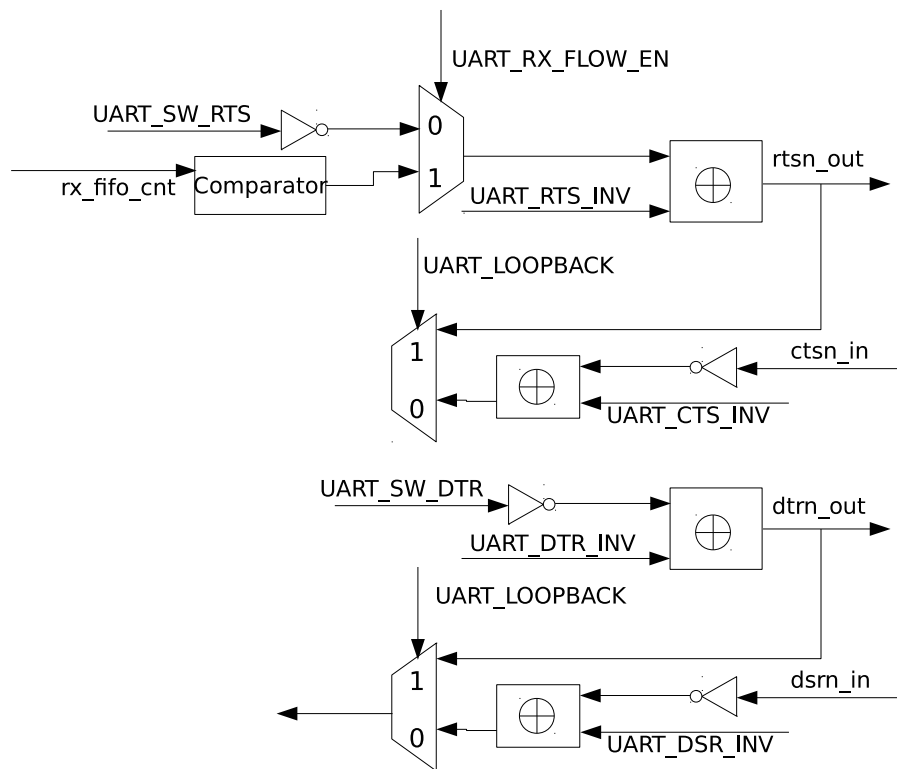

Figure 26-10. Hardware Flow Control Diagram

Figure 26-10 shows the hardware flow control of a UART controller. Hardware flow control uses output signal `rtsn_out` and input signal `dsmn_in`. Figure 26-11 illustrates how these signals are connected between UART on ESP32-S3 (hereinafter referred to as IU0) and the external UART (hereinafter referred to as EU0).

When `rtsn_out` of IU0 is low, EU0 is allowed to send data; when `rtsn_out` of IU0 is high, EU0 is notified to stop sending data until `rtsn_out` of IU0 returns to low. The output signal `rtsn_out` can be controlled in two ways.

- Software control: Enter this mode by clearing `UART_RX_FLOW_EN` to 0. In this mode, the level of `rtsn_out` is changed by configuring `UART_SW_RTS`.
- Hardware control: Enter this mode by setting `UART_RX_FLOW_EN` to 1. In this mode, `rtsn_out` is pulled high when data in Rx_FIFO exceeds `UART_RX_FLOW_THRHD`.

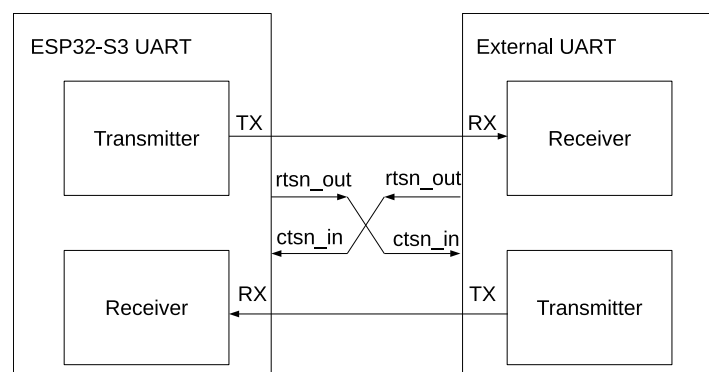

Figure 26-11. Connection between Hardware Flow Control Signals

When `ctsn_in` of IU0 is low, IU0 is allowed to send data; when `ctsn_in` is high, IU0 is not allowed to send data. When IU0 detects an edge change on `ctsn_in`, a `UART_CTS_CHG_INT` interrupt is generated.

If `dtrn_out` of IU0 is high, it indicates that IU0 is ready to transmit data. `dtrn_out` is generated by configuring the `UART_SW_DTR` field. When the IU0 transmitter detects a edge change on `dsrn_in`, a `UART_DSR_CHG_INT` interrupt is generated. After this interrupt is detected, software can obtain the level of input signal `dsrn_in` by reading `UART_DSRN`. If `dsrn_in` is high, it indicates that EU0 is ready to transmit data.

In a two-wire RS485 multidrop network enabled by setting `UART_RS485_EN`, `dtrn_out` is generated by hardware and used for transmit/receive turnaround. When data transmission starts, `dtrn_out` is pulled high and the external driver is enabled; when data transmission completes, `dtrn_out` is pulled low and the external driver is disabled. Please note that when there is a turnaround delay of one cycle added after the stop bit, `dtrn_out` is pulled low after the delay.

26.4.10.2 Software Flow Control

Instead of CTS/RTS lines, software flow control uses XON/XOFF characters to start or stop data transmission. Such flow control can be enabled by setting `UART_SW_FLOW_CON_EN` to 1.

When choosing software flow control, the hardware automatically detects if XON and XOFF characters are used in the data flow, and generates a `UART_SW_XOFF_INT` or a `UART_SW_XON_INT` interrupt accordingly. When XOFF character is detected, the transmitter stops data transmission once the current byte has been transmitted; when XON character is detected, the transmitter starts data transmission. In addition, software can force the transmitter to stop sending data or to start sending data by setting respectively `UART_FORCE_XOFF` or `UART_FORCE_XON`.

Software determines whether to insert flow control characters according to the remaining room in the RX FIFO. When `UART_SEND_XOFF` is set, the transmitter sends an XOFF character configured by `UART_XOFF_CHAR` after the current byte in transmission; when `UART_SEND_XON` is set, the transmitter sends an XON character configured by `UART_XON_CHAR` after the current byte in transmission. If the RX FIFO of a UART controller stores more data than `UART_XOFF_THRESHOLD`, `UART_SEND_XOFF` is set by hardware. As a result, the transmitter sends an XOFF character configured by `UART_XOFF_CHAR` after the current byte in transmission. If the RX FIFO of a UART controller stores less data than `UART_XON_THRESHOLD`, `UART_SEND_XON` is set by hardware. As a result, the transmitter sends an XON character configured by `UART_XON_CHAR` after the current byte in transmission.

26.4.11 GDMA Mode

All three UART controllers on ESP32-S3 share one TX/RX GDMA (general direct memory access) channel via UHCI. In GDMA mode, UART controllers support the decoding and encoding of HCI data packets. The `UHCI_UARTn_CE` field determines which UART controller occupies the GDMA TX/RX channel.

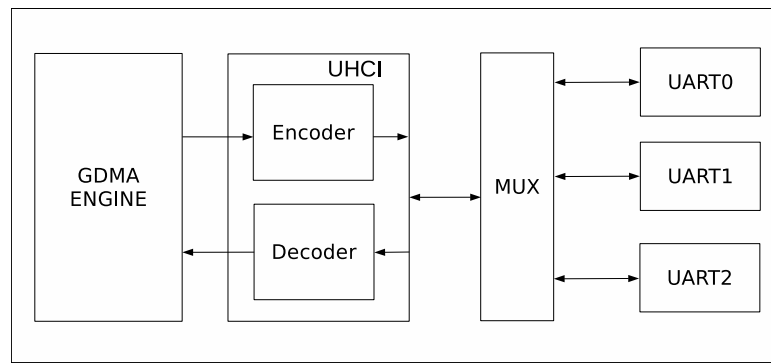

Figure 26-12. Data Transfer in GDMA Mode

Figure 26-12 shows how data are transferred using GDMA. Before GDMA receives data, software prepares an inlink (i.e. a linked list of receive descriptors. For details, see Chapter 3 [GDMA Controller \(GDMA\)](#)).

`GDMA_INLINK_ADDR_CH n` points to the first receive descriptor in the inlink. After `GDMA_INLINK_START_CH n` is set, UHCI passes data that UART has received to the decoder. The decoded data are then stored into the RAM pointed by the inlink under the control of GDMA.

Before GDMA sends data, software prepares an outlink and data to be sent. `GDMA_OUTLINK_ADDR_CH n` points to the first transmit descriptor in the outlink. After `GDMA_OUTLINK_START_CH n` is set, GDMA reads data from the RAM pointed by outlink. The data are then encoded by the encoder, and sent sequentially by the UART transmitter.

HCI data packets have separators at the beginning and the end, with data bits in the middle (separators + data bits + separators). The encoder inserts separators in front of and after data bits, and replaces data bits identical to separators with special characters (i.e. escape characters). The decoder removes separators in front of and after data bits, and replaces escape characters with separators. There can be more than one continuous separator at the beginning and the end of a data packet. The separator is configured by `UHCI_SEPER_CHAR`, 0xC0 by default. The escape characters are configured by `UHCI_ESC_SEQ0_CHAR0` (0xDB by default) and `UHCI_ESC_SEQ0_CHAR1` (0xDD by default). When all data have been sent, a `GDMA_OUT_TOTAL_EOF_CH n _INT` interrupt is generated. When all data have been received, a `GDMA_IN_SUC_EOF_CH n _INT` is generated.

26.4.12 UART Interrupts

- `UART_AT_CMD_CHAR_DET_INT`: Triggered when the receiver detects an AT_CMD character.
- `UART_RS485_CLASH_INT`: Triggered when a collision is detected between the transmitter and the receiver in RS485 mode.
- `UART_RS485_FRM_ERR_INT`: Triggered when an error is detected in the data frame sent by the transmitter in RS485 mode.
- `UART_RS485_PARITY_ERR_INT`: Triggered when an error is detected in the parity bit sent by the transmitter in RS485 mode.
- `UART_TX_DONE_INT`: Triggered when all data in the TX FIFO have been sent.
- `UART_TX_BRK_IDLE_DONE_INT`: Triggered when the transmitter stays idle after sending the last data bit. The minimum amount of time marking the transmitter state as idle is determined by the configurable threshold value.

- `UART_TX_BRK_DONE_INT`: Triggered when the transmitter has sent all NULL characters following the complete transmission of data from the TX FIFO.
- `UART_GLITCH_DET_INT`: Triggered when the receiver detects a glitch in the middle of the start bit.
- `UART_SW_XOFF_INT`: Triggered when `UART_SW_FLOW_CON_EN` is set and the receiver receives a XOFF character.
- `UART_SW_XON_INT`: Triggered when `UART_SW_FLOW_CON_EN` is set and the receiver receives a XON character.
- `UART_RXFIFO_TOUT_INT`: Triggered when the receiver takes more time than `UART_RX_TOUT_THRHD` to receive one byte.
- `UART_BRK_DET_INT`: Triggered when the receiver detects a NULL character (i.e. logic 0 for one NULL character transmission) after stop bits.
- `UART_CTS_CHG_INT`: Triggered when the receiver detects an edge change on CTSn signals.
- `UART_DSR_CHG_INT`: Triggered when the receiver detects an edge change on DSRn signals.
- `UART_RXFIFO_OVF_INT`: Triggered when the receiver receives more data than the capacity of the RX FIFO.
- `UART_FRM_ERR_INT`: Triggered when the receiver detects a data frame error.
- `UART_PARITY_ERR_INT`: Triggered when the receiver detects a parity error.
- `UART_TXFIFO_EMPTY_INT`: Triggered when the TX FIFO stores less data than what `UART_TXFIFO_EMPTY_THRHD` specifies.
- `UART_RXFIFO_FULL_INT`: Triggered when the receiver receives more data than what `UART_RXFIFO_FULL_THRHD` specifies.
- `UART_WAKEUP_INT`: Triggered when UART is woken up.

26.4.13 UHCI Interrupts

- `UHCI_APP_CTRL1_INT`: Triggered when software sets `UHCI_APP_CTRL1_INT_RAW`.
- `UHCI_APP_CTRL0_INT`: Triggered when software sets `UHCI_APP_CTRL0_INT_RAW`.
- `UHCI_OUTLINK_EOF_ERR_INT`: Triggered when an EOF error is detected in a transmit descriptor.
- `UHCI_SEND_A_REG_Q_INT`: Triggered when UHCI has sent a series of short packets using `always_send`.
- `UHCI_SEND_S_REG_Q_INT`: Triggered when UHCI has sent a series of short packets using `single_send`.
- `UHCI_TX_HUNG_INT`: Triggered when UHCI takes too long to read RAM using a GDMA transmit channel.
- `UHCI_RX_HUNG_INT`: Triggered when UHCI takes too long to receive data using a GDMA receive channel.
- `UHCI_TX_START_INT`: Triggered when GDMA detects a separator character.
- `UHCI_RX_START_INT`: Triggered when a separator character has been sent.

26.5 Programming Procedures

26.5.1 Register Type

All UART registers are in APB_CLK domain. According to whether clock domain crossing and synchronization are required, UART registers that can be configured by software are classified into three types, namely synchronous registers, static registers, and immediate registers. Synchronous registers are read in Core Clock domain, and take effect after synchronization. Static registers are also read in Core Clock domain, but would not change dynamically. Therefore, for static registers, clock domain crossing is not required, and software can turn on and off the clock for the UART transmitter or receiver to ensure that the configuration sampled in Core Clock domain is correct. Immediate registers are read in APB_CLK domain, and take effect after being configured via the APB bus.

26.5.1.1 Synchronous Registers

Since synchronous registers are read in core clock domain, but written in APB_CLK domain, they implement the clock domain crossing design to ensure that their values sampled in Core Clock domain are correct. These registers as listed in Table 26-1 are configured as follows:

- Enable register synchronization by clearing `UART_UPDATE_CTRL` to 0;
- Wait for `UART_REG_UPDATE` to become 0, which indicates the completion of last synchronization;
- Configure synchronous registers;
- Synchronize the configured values to Core Clock domain by writing 1 to `UART_REG_UPDATE`.

Table 26-1. UART_n Synchronous Registers

Register	Field
UART_CLKDIV_REG	UART_CLKDIV_FRAG[3:0]
	UART_CLKDIV[11:0]
UART_CONFO_REG	UART_AUTOBAUD_EN
	UART_ERR_WR_MASK
	UART_TXD_INV
	UART_RXD_INV
	UART_IRDA_EN
	UART_TX_FLOW_EN
	UART_LOOPBACK
	UART_IRDA_RX_INV
	UART_IRDA_TX_EN
	UART_IRDA_WCTL
	UART_IRDA_TX_EN
	UART_IRDA_DPLX
	UART_STOP_BIT_NUM
	UART_BIT_NUM
	UART_PARITY_EN
UART_PARITY	

Cont'd on next page

Table 26-1 – cont'd from previous page

Register	Field
UART_FLOW_CONF_REG	UART_SEND_XOFF
	UART_SEND_XON
	UART_FORCE_XOFF
	UART_FORCE_XON
	UART_XONOFF_DEL
	UART_SW_FLOW_CON_EN
UART_RS485_CONF_REG	UART_RS485_TX_DLY_NUM[3:0]
	UART_RS485_RX_DLY_NUM
	UART_RS485RXBY_TX_EN
	UART_RS485TX_RX_EN
	UART_DL1_EN
	UART_DL0_EN
	UART_RS485_EN

26.5.1.2 Static Registers

Static registers, though also read in Core Clock domain, would not change dynamically when UART controllers are at work, so they do not implement the clock domain crossing design. These registers must be configured when the UART transmitter or receiver is not at work. In this case, software can turn off the clock for the UART transmitter or receiver, so that static registers are not sampled in their metastable state. When software turns on the clock, the configured values are stable to be correctly sampled. Static registers as listed in Table 26-2 are configured as follows:

- Turn off the clock for the UART transmitter by clearing `UART_TX_SCLK_EN`, or the clock for the UART receiver by clearing `UART_RX_SCLK_EN`, depending on which one (transmitter or receiver) is not at work;
- Configure static registers;
- Turn on the clock for the UART transmitter by writing 1 to `UART_TX_SCLK_EN`, or the clock for the UART receiver by writing 1 to `UART_RX_SCLK_EN`.

Table 26-2. UART_n Static Registers

Register	Field
UART_RX_FILT_REG	UART_GLITCH_FILT_EN
	UART_GLITCH_FILT[7:0]
UART_SLEEP_CONF_REG	UART_ACTIVE_THRESHOLD[9:0]
UART_SWFC_CONF0_REG	UART_XOFF_CHAR[7:0]
UART_SWFC_CONF1_REG	UART_XON_CHAR[7:0]
UART_IDLE_CONF_REG	UART_TX_IDLE_NUM[9:0]
UART_AT_CMD_PRECNT_REG	UART_PRE_IDLE_NUM[15:0]
UART_AT_CMD_POSTCNT_REG	UART_POST_IDLE_NUM[15:0]
UART_AT_CMD_GAPTOUR_REG	UART_RX_GAP_TOUT[15:0]
UART_AT_CMD_CHAR_REG	UART_CHAR_NUM[7:0]
	UART_AT_CMD_CHAR[7:0]

26.5.1.3 Immediate Registers

Except those listed in Table 26-1 and Table 26-2, registers that can be configured by software are immediate registers read in APB_CLK domain, such as interrupt and FIFO configuration registers.

26.5.2 Detailed Steps

Figure 26-13 illustrates the process to program UART controllers, namely initializing the UART, configuring the registers, enabling the transmitter and/or receiver, and finishing data transmission.

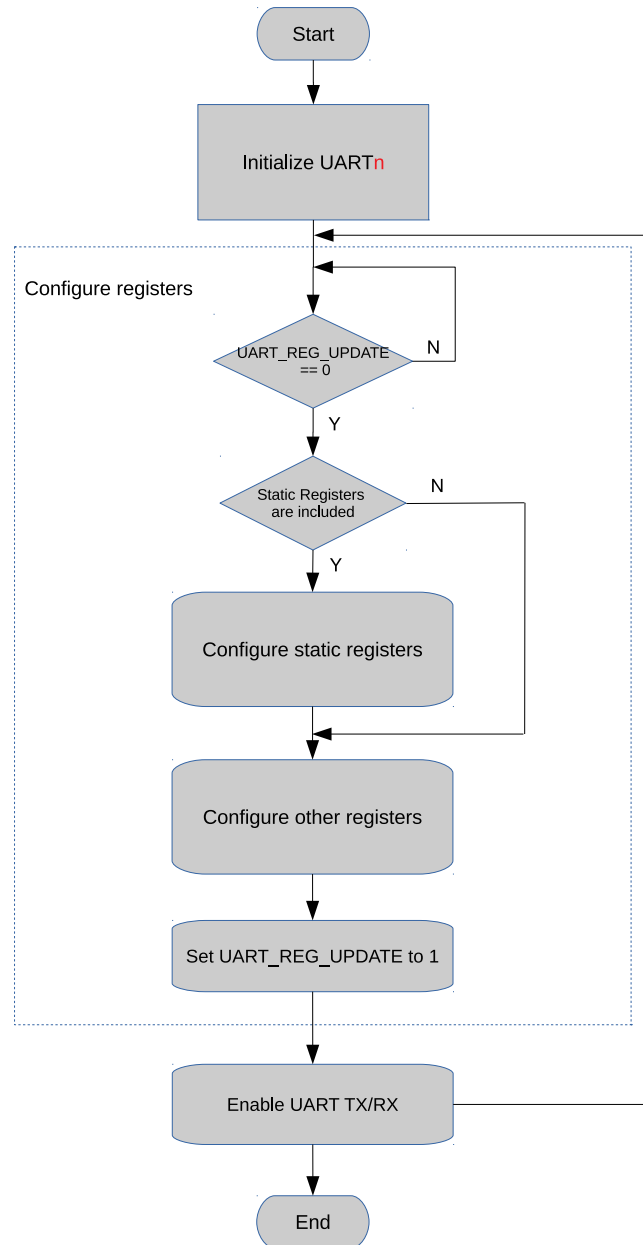

Figure 26-13. UART Programming Procedures

26.5.2.1 Initializing UART_n

Initializing UART_n requires two steps: resetting UART_n and enabling register synchronization.

To reset UART_n:

- enable the clock for UART RAM by setting `SYSTEM_UART_MEM_CLK_EN` to 1;
- enable APB_CLK for UART n by setting `SYSTEM_UART n _CLK_EN` to 1;
- clear `SYSTEM_UART n _RST`;
- write 1 to `UART_RST_CORE`;
- write 1 to `SYSTEM_UART n _RST`;
- clear `SYSTEM_UART n _RST`;
- clear `UART_RST_CORE`.

To enable register synchronization, clear `UART_UPDATE_CTRL`.

26.5.2.2 Configuring UART n Communication

To configure UART n communication:

- wait for `UART_REG_UPDATE` to become 0, which indicates the completion of the last synchronization;
- configure static registers (if any) following Section 26.5.1.2;
- select the clock source via `UART_SCLK_SEL`;
- configure divisor of the divider via `UART_SCLK_DIV_NUM`, `UART_SCLK_DIV_A`, and `UART_SCLK_DIV_B`;
- configure the baud rate for transmission via `UART_CLKDIV` and `UART_CLKDIV_FRAG`;
- configure data length via `UART_BIT_NUM`;
- configure odd or even parity check via `UART_PARITY_EN` and `UART_PARITY`;
- optional steps depending on application ...
- synchronize the configured values to the Core Clock domain by writing 1 to `UART_REG_UPDATE`.

26.5.2.3 Enabling UART n

To enable UART n transmitter:

- configure the TX FIFO's empty threshold via `UART_TXFIFO_EMPTY_THRHD`;
- disable `UART_TXFIFO_EMPTY_INT` interrupt by clearing `UART_TXFIFO_EMPTY_INT_ENA`;
- write data to be sent to `UART_RXFIFO_RD_BYTE`;
- clear `UART_TXFIFO_EMPTY_INT` interrupt by setting `UART_TXFIFO_EMPTY_INT_CLR`;
- enable `UART_TXFIFO_EMPTY_INT` interrupt by setting `UART_TXFIFO_EMPTY_INT_ENA`;
- detect `UART_TXFIFO_EMPTY_INT` and wait for the completion of data transmission.

To enable UART n receiver:

- configure RXFIFO's full threshold via `UART_RXFIFO_FULL_THRHD`;
- enable `UART_RXFIFO_FULL_INT` interrupt by setting `UART_RXFIFO_FULL_INT_ENA`;
- detect `UART_RXFIFO_FULL_INT` and wait until the RXFIFO is full;

- read data from RXFIFO via [UART_RXFIFO_RD_BYTE](#), and obtain the number of bytes received in RXFIFO via [UART_RXFIFO_CNT](#).

26.6 Register Summary

26.6.1 UART Register Summary

The addresses in this section are relative to **UART Controller** base address provided in Table 4-3 in Chapter 4 *System and Memory*.

The abbreviations given in Column **Access** are explained in Section [Access Types for Registers](#).

Name	Description	Address	Access
FIFO Configuration			
UART_FIFO_REG	FIFO data register	0x0000	RO
UART_MEM_CONF_REG	UART threshold and allocation configuration	0x0060	R/W
UART Interrupt Register			
UART_INT_RAW_REG	Raw interrupt status	0x0004	R/WTC/SS
UART_INT_ST_REG	Masked interrupt status	0x0008	RO
UART_INT_ENA_REG	Interrupt enable bits	0x000C	R/W
UART_INT_CLR_REG	Interrupt clear bits	0x0010	WT
Configuration Register			
UART_CLKDIV_REG	Clock divider configuration	0x0014	R/W
UART_RX_FILT_REG	RX filter configuration	0x0018	R/W
UART_CONF0_REG	Configuration register 0	0x0020	R/W
UART_CONF1_REG	Configuration register 1	0x0024	R/W
UART_FLOW_CONF_REG	Software flow control configuration	0x0034	varies
UART_SLEEP_CONF_REG	Sleep mode configuration	0x0038	R/W
UART_SWFC_CONF0_REG	Software flow control character configuration	0x003C	R/W
UART_SWFC_CONF1_REG	Software flow control character configuration	0x0040	R/W
UART_TXBRK_CONF_REG	TX break character configuration	0x0044	R/W
UART_IDLE_CONF_REG	Frame end idle time configuration	0x0048	R/W
UART_RS485_CONF_REG	RS485 mode configuration	0x004C	R/W
UART_CLK_CONF_REG	UART core clock configuration	0x0078	R/W
Status Register			
UART_STATUS_REG	UART status register	0x001C	RO
UART_MEM_TX_STATUS_REG	TX FIFO write and read offset address	0x0064	RO
UART_MEM_RX_STATUS_REG	RX FIFO write and read offset address	0x0068	RO
UART_FSM_STATUS_REG	UART transmitter and receiver status	0x006C	RO
Autobaud Register			
UART_LOWPULSE_REG	Autobaud minimum low pulse duration register	0x0028	RO
UART_HIGHPULSE_REG	Autobaud minimum high pulse duration register	0x002C	RO
UART_RXD_CNT_REG	Autobaud edge change count register	0x0030	RO
UART_POSPULSE_REG	Autobaud high pulse register	0x0070	RO
UART_NEGPULSE_REG	Autobaud low pulse register	0x0074	RO
AT Escape Sequence Selection Configuration			
UART_AT_CMD_PRECNT_REG	Pre-sequence timing configuration	0x0050	R/W
UART_AT_CMD_POSTCNT_REG	Post-sequence timing configuration	0x0054	R/W

Name	Description	Address	Access
UART_AT_CMD_GAPTOOUT_REG	Timeout configuration	0x0058	R/W
UART_AT_CMD_CHAR_REG	AT escape sequence detection configuration	0x005C	R/W
Version Register			
UART_DATE_REG	UART version control register	0x007C	R/W
UART_ID_REG	UART ID register	0x0080	varies

26.6.2 UHCI Register Summary

The addresses in this section are relative to **UHCI Controller** base address provided in Table 4-3 in Chapter 4 *System and Memory*.

The abbreviations given in Column **Access** are explained in Section [Access Types for Registers](#).

Name	Description	Address	Access
Configuration Register			
UHCI_CONF0_REG	UHCI configuration register	0x0000	R/W
UHCI_CONF1_REG	UHCI configuration register	0x0018	varies
UHCI_ESCAPE_CONF_REG	Escape character configuration	0x0024	R/W
UHCI_HUNG_CONF_REG	Timeout configuration	0x0028	R/W
UHCI_ACK_NUM_REG	UHCI ACK number configuration	0x002C	varies
UHCI_QUICK_SENT_REG	UHCI quick_sent configuration register	0x0034	varies
UHCI_REG_Q0_WORD0_REG	Q0_WORD0 quick_sent register	0x0038	R/W
UHCI_REG_Q0_WORD1_REG	Q0_WORD1 quick_sent register	0x003C	R/W
UHCI_REG_Q1_WORD0_REG	Q1_WORD0 quick_sent register	0x0040	R/W
UHCI_REG_Q1_WORD1_REG	Q1_WORD1 quick_sent register	0x0044	R/W
UHCI_REG_Q2_WORD0_REG	Q2_WORD0 quick_sent register	0x0048	R/W
UHCI_REG_Q2_WORD1_REG	Q2_WORD1 quick_sent register	0x004C	R/W
UHCI_REG_Q3_WORD0_REG	Q3_WORD0 quick_sent register	0x0050	R/W
UHCI_REG_Q3_WORD1_REG	Q3_WORD1 quick_sent register	0x0054	R/W
UHCI_REG_Q4_WORD0_REG	Q4_WORD0 quick_sent register	0x0058	R/W
UHCI_REG_Q4_WORD1_REG	Q4_WORD1 quick_sent register	0x005C	R/W
UHCI_REG_Q5_WORD0_REG	Q5_WORD0 quick_sent register	0x0060	R/W
UHCI_REG_Q5_WORD1_REG	Q5_WORD1 quick_sent register	0x0064	R/W
UHCI_REG_Q6_WORD0_REG	Q6_WORD0 quick_sent register	0x0068	R/W
UHCI_REG_Q6_WORD1_REG	Q6_WORD1 quick_sent register	0x006C	R/W
UHCI_ESC_CONF0_REG	Escape sequence configuration register 0	0x0070	R/W
UHCI_ESC_CONF1_REG	Escape sequence configuration register 1	0x0074	R/W
UHCI_ESC_CONF2_REG	Escape sequence configuration register 2	0x0078	R/W
UHCI_ESC_CONF3_REG	Escape sequence configuration register 3	0x007C	R/W
UHCI_PKT_THRES_REG	Configuration register for packet length	0x0080	R/W
UHCI Interrupt Register			
UHCI_INT_RAW_REG	Raw interrupt status	0x0004	varies
UHCI_INT_ST_REG	Masked interrupt status	0x0008	RO
UHCI_INT_ENA_REG	Interrupt enable bits	0x000C	R/W
UHCI_INT_CLR_REG	Interrupt clear bits	0x0010	WT

Name	Description	Address	Access
UHCI_APP_INT_SET_REG	Software interrupt trigger source	0x0014	WT
UHCI Status Register			
UHCI_STATE0_REG	UHCI receive status	0x001C	RO
UHCI_STATE1_REG	UHCI transmit status	0x0020	RO
UHCI_RX_HEAD_REG	UHCI packet header register	0x0030	RO
Version Register			
UHCI_DATE_REG	UHCI version control register	0x0084	R/W

26.7 Registers

26.7.1 UART Registers

The addresses in this section are relative to **UART Controller** base address provided in Table 4-3 in Chapter 4 *System and Memory*.

Register 26.1. UART_FIFO_REG (0x0000)

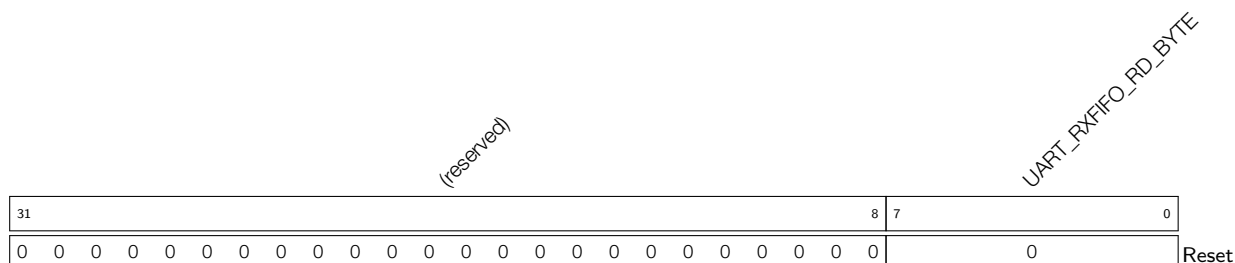

UART_RXFIFO_RD_BYTE UART_n accesses FIFO via this field. (RO)

Register 26.2. UART_MEM_CONF_REG (0x0060)

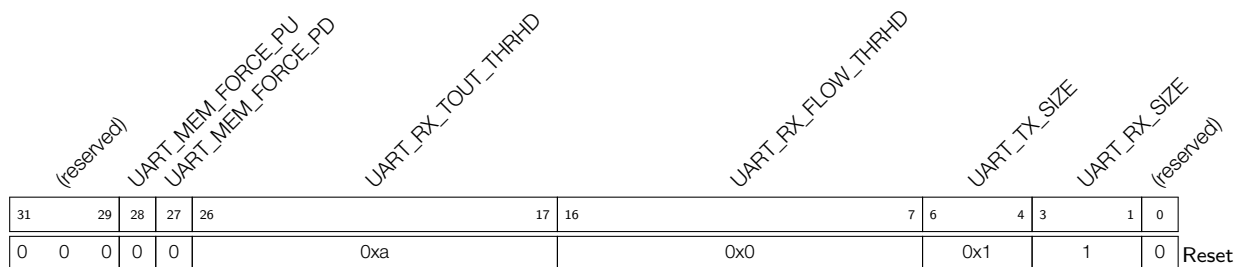

UART_RX_SIZE This field is used to configure the amount of RAM allocated for RX FIFO. The default number is 128 bytes. (R/W)

UART_TX_SIZE This field is used to configure the amount of RAM allocated for TX FIFO. The default number is 128 bytes. (R/W)

UART_RX_FLOW_THRHD This field is used to configure the maximum amount of data bytes that can be received when hardware flow control works. (R/W)

UART_RX_TOUT_THRHD This field is used to configure the threshold time that receiver takes to receive one byte, in the unit of bit time (the time it takes to transfer one bit). The UART_RXFIFO_TOUT_INT interrupt will be triggered when the receiver takes more time to receive one byte with UART_RX_TOUT_EN set to 1. (R/W)

UART_MEM_FORCE_PD Set this bit to force power down UART RAM. (R/W)

UART_MEM_FORCE_PU Set this bit to force power up UART RAM. (R/W)

Register 26.3. UART_INT_RAW_REG (0x0004)

(reserved)												UART_WAKEUP_INT_RAW UART_AT_CMD_CHAR_DET_INT_RAW UART_RS485_CLASH_INT_RAW UART_RS485_FRM_ERR_INT_RAW UART_RS485_PARITY_ERR_INT_RAW UART_TX_DONE_INT_RAW UART_TX_BRK_IDLE_DONE_INT_RAW UART_TX_BRK_DONE_INT_RAW UART_GLITCH_DET_INT_RAW UART_SW_XOFF_INT_RAW UART_SW_XON_INT_RAW UART_RXFIFO_TOUT_INT_RAW UART_BRK_DET_INT_RAW UART_CTS_CHG_INT_RAW UART_DSR_CHG_INT_RAW UART_RXFIFO_OVF_INT_RAW UART_FRM_ERR_INT_RAW UART_PARITY_ERR_INT_RAW UART_TXFIFO_EMPTY_INT_RAW UART_RXFIFO_FULL_INT_RAW																													
31																				20	19	18	17	16	15	14	13	12	11	10	9	8	7	6	5	4	3	2	1	0	Reset
0	0	0	0	0	0	0	0	0	0	0	0	0	0	0	0	0	0	0	0	0	0	0	0	0	0	0	0	0	1	0											

UART_RXFIFO_FULL_INT_RAW This interrupt raw bit turns to high level when the receiver receives more data than what UART_RXFIFO_FULL_THRHD specifies. (R/WTC/SS)

UART_TXFIFO_EMPTY_INT_RAW This interrupt raw bit turns to high level when the amount of data in TX FIFO is less than what UART_TXFIFO_EMPTY_THRHD specifies. (R/WTC/SS)

UART_PARITY_ERR_INT_RAW This interrupt raw bit turns to high level when the receiver detects a parity error in the data. (R/WTC/SS)

UART_FRM_ERR_INT_RAW This interrupt raw bit turns to high level when the receiver detects a data frame error. (R/WTC/SS)

UART_RXFIFO_OVF_INT_RAW This interrupt raw bit turns to high level when the receiver receives more data than the capacity of RX FIFO. (R/WTC/SS)

UART_DSR_CHG_INT_RAW This interrupt raw bit turns to high level when the receiver detects the edge change of DSRn signal. (R/WTC/SS)

UART_CTS_CHG_INT_RAW This interrupt raw bit turns to high level when the receiver detects the edge change of CTSn signal. (R/WTC/SS)

UART_BRK_DET_INT_RAW This interrupt raw bit turns to high level when the receiver detects a 0 after the stop bit. (R/WTC/SS)

UART_RXFIFO_TOUT_INT_RAW This interrupt raw bit turns to high level when the receiver takes more time than UART_RX_TOUT_THRHD to receive a byte. (R/WTC/SS)

UART_SW_XON_INT_RAW This interrupt raw bit turns to high level when the receiver receives an XON character and UART_SW_FLOW_CON_EN is set to 1. (R/WTC/SS)

UART_SW_XOFF_INT_RAW This interrupt raw bit turns to high level when the receiver receives an XOFF character and UART_SW_FLOW_CON_EN is set to 1. (R/WTC/SS)

UART_GLITCH_DET_INT_RAW This interrupt raw bit turns to high level when the receiver detects a glitch in the middle of a start bit. (R/WTC/SS)

Continued on the next page...

Register 26.3. UART_INT_RAW_REG (0x0004)

Continued from the previous page...

UART_TX_BRK_DONE_INT_RAW This interrupt raw bit turns to high level when the transmitter completes sending NULL characters, after all data in TX FIFO are sent. (R/WTC/SS)

UART_TX_BRK_IDLE_DONE_INT_RAW This interrupt raw bit turns to high level when the transmitter has kept the shortest duration after sending the last data. (R/WTC/SS)

UART_TX_DONE_INT_RAW This interrupt raw bit turns to high level when the transmitter has sent out all data in FIFO. (R/WTC/SS)

UART_RS485_PARITY_ERR_INT_RAW This interrupt raw bit turns to high level when the receiver detects a parity error from the echo of the transmitter in RS485 mode. (R/WTC/SS)

UART_RS485_FRM_ERR_INT_RAW This interrupt raw bit turns to high level when the receiver detects a data frame error from the echo of the transmitter in RS485 mode. (R/WTC/SS)

UART_RS485_CLASH_INT_RAW This interrupt raw bit turns to high level when a collision is detected between the transmitter and the receiver in RS485 mode. (R/WTC/SS)

UART_AT_CMD_CHAR_DET_INT_RAW This interrupt raw bit turns to high level when the receiver detects the configured UART_AT_CMD_CHAR. (R/WTC/SS)

UART_WAKEUP_INT_RAW This interrupt raw bit turns to high level when the input RXD edge changes more times than what UART_ACTIVE_THRESHOLD specifies in Light-sleep mode. (R/WTC/SS)

Register 26.4. UART_INT_ST_REG (0x0008)

(reserved)										UART_WAKEUP_INT_ST UART_AT_CMD_CHAR_DET_INT_ST UART_RS485_CLASH_DET_INT_ST UART_RS485_FRM_ERR_INT_ST UART_RS485_PARITY_ERR_INT_ST UART_TX_DONE_INT_ST UART_TX_BRK_IDLE_INT_ST UART_GLITCH_DET_DONE_INT_ST UART_SW_XOFF_INT_ST UART_SW_XON_INT_ST UART_BRK_DET_INT_ST UART_CTS_CHG_INT_ST UART_DSR_CHG_INT_ST UART_RXFIFO_OVF_INT_ST UART_FRM_ERR_INT_ST UART_PARITY_ERR_INT_ST UART_TXFIFO_EMPTY_INT_ST UART_RXFIFO_FULL_INT_ST												
31	20	19	18	17	16	15	14	13	12	11	10	9	8	7	6	5	4	3	2	1	0	
0	0	0	0	0	0	0	0	0	0	0	0	0	0	0	0	0	0	0	0	0	0	0

Reset

UART_RXFIFO_FULL_INT_ST This is the status bit for UART_RXFIFO_FULL_INT when UART_RXFIFO_FULL_INT_ENA is set to 1. (RO)

UART_TXFIFO_EMPTY_INT_ST This is the status bit for UART_TXFIFO_EMPTY_INT when UART_TXFIFO_EMPTY_INT_ENA is set to 1. (RO)

UART_PARITY_ERR_INT_ST This is the status bit for UART_PARITY_ERR_INT when UART_PARITY_ERR_INT_ENA is set to 1. (RO)

UART_FRM_ERR_INT_ST This is the status bit for UART_FRM_ERR_INT when UART_FRM_ERR_INT_ENA is set to 1. (RO)

UART_RXFIFO_OVF_INT_ST This is the status bit for UART_RXFIFO_OVF_INT when UART_RXFIFO_OVF_INT_ENA is set to 1. (RO)

UART_DSR_CHG_INT_ST This is the status bit for UART_DSR_CHG_INT when UART_DSR_CHG_INT_ENA is set to 1. (RO)

UART_CTS_CHG_INT_ST This is the status bit for UART_CTS_CHG_INT when UART_CTS_CHG_INT_ENA is set to 1. (RO)

UART_BRK_DET_INT_ST This is the status bit for UART_BRK_DET_INT when UART_BRK_DET_INT_ENA is set to 1. (RO)

UART_RXFIFO_TOUT_INT_ST This is the status bit for UART_RXFIFO_TOUT_INT when UART_RXFIFO_TOUT_INT_ENA is set to 1. (RO)

UART_SW_XON_INT_ST This is the status bit for UART_SW_XON_INT when UART_SW_XON_INT_ENA is set to 1. (RO)

UART_SW_XOFF_INT_ST This is the status bit for UART_SW_XOFF_INT when UART_SW_XOFF_INT_ENA is set to 1. (RO)

UART_GLITCH_DET_INT_ST This is the status bit for UART_GLITCH_DET_INT when UART_GLITCH_DET_INT_ENA is set to 1. (RO)

UART_TX_BRK_DONE_INT_ST This is the status bit for UART_TX_BRK_DONE_INT when UART_TX_BRK_DONE_INT_ENA is set to 1. (RO)

Continued on the next page...

Register 26.4. UART_INT_ST_REG (0x0008)

Continued from the previous page...

UART_TX_BRK_IDLE_DONE_INT_ST This is the status bit for UART_TX_BRK_IDLE_DONE_INT when UART_TX_BRK_IDLE_DONE_INT_ENA is set to 1. (RO)

UART_TX_DONE_INT_ST This is the status bit for UART_TX_DONE_INT when UART_TX_DONE_INT_ENA is set to 1. (RO)

UART_RS485_PARITY_ERR_INT_ST This is the status bit for UART_RS485_PARITY_ERR_INT when UART_RS485_PARITY_INT_ENA is set to 1. (RO)

UART_RS485_FRM_ERR_INT_ST This is the status bit for UART_RS485_FRM_ERR_INT when UART_RS485_FRM_ERR_INT_ENA is set to 1. (RO)

UART_RS485_CLASH_INT_ST This is the status bit for UART_RS485_CLASH_INT when UART_RS485_CLASH_INT_ENA is set to 1. (RO)

UART_AT_CMD_CHAR_DET_INT_ST This is the status bit for UART_AT_CMD_CHAR_DET_INT when UART_AT_CMD_CHAR_DET_INT_ENA is set to 1. (RO)

UART_WAKEUP_INT_ST This is the status bit for UART_WAKEUP_INT when UART_WAKEUP_INT_ENA is set to 1. (RO)

Register 26.5. UART_INT_ENA_REG (0x000C)

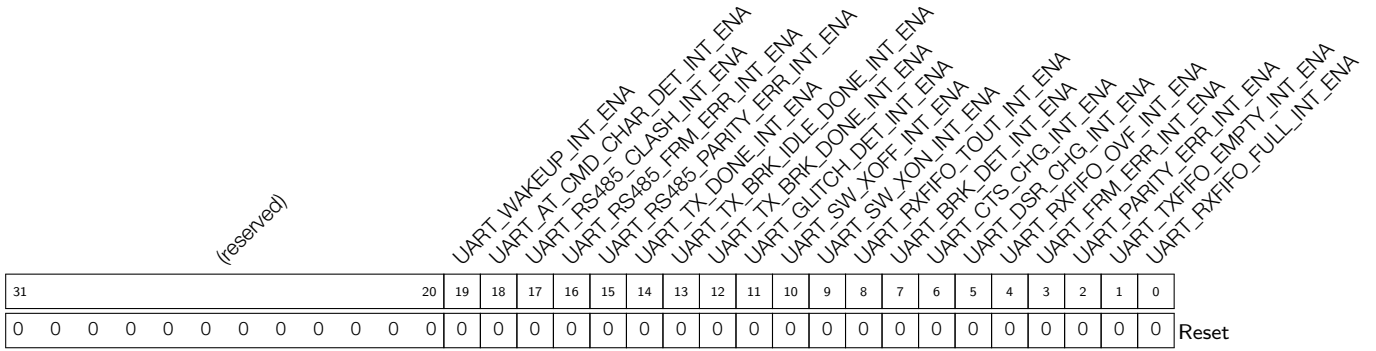

- UART_RXFIFO_FULL_INT_ENA** This is the enable bit for UART_RXFIFO_FULL_INT. (R/W)
 - UART_TXFIFO_EMPTY_INT_ENA** This is the enable bit for UART_TXFIFO_EMPTY_INT. (R/W)
 - UART_PARITY_ERR_INT_ENA** This is the enable bit for UART_PARITY_ERR_INT. (R/W)
 - UART_FRM_ERR_INT_ENA** This is the enable bit for UART_FRM_ERR_INT. (R/W)
 - UART_RXFIFO_OVF_INT_ENA** This is the enable bit for UART_RXFIFO_OVF_INT. (R/W)
 - UART_DSR_CHG_INT_ENA** This is the enable bit for UART_DSR_CHG_INT. (R/W)
 - UART_CTS_CHG_INT_ENA** This is the enable bit for UART_CTS_CHG_INT. (R/W)
 - UART_BRK_DET_INT_ENA** This is the enable bit for UART_BRK_DET_INT. (R/W)
 - UART_RXFIFO_TOUT_INT_ENA** This is the enable bit for UART_RXFIFO_TOUT_INT. (R/W)
 - UART_SW_XON_INT_ENA** This is the enable bit for UART_SW_XON_INT. (R/W)
 - UART_SW_XOFF_INT_ENA** This is the enable bit for UART_SW_XOFF_INT. (R/W)
 - UART_GLITCH_DET_INT_ENA** This is the enable bit for UART_GLITCH_DET_INT. (R/W)
 - UART_TX_BRK_DONE_INT_ENA** This is the enable bit for UART_TX_BRK_DONE_INT. (R/W)
 - UART_TX_BRK_IDLE_DONE_INT_ENA** This is the enable bit for UART_TX_BRK_IDLE_DONE_INT. (R/W)
 - UART_TX_DONE_INT_ENA** This is the enable bit for UART_TX_DONE_INT. (R/W)
- Continued on the next page...

Register 26.5. UART_INT_ENA_REG (0x000C)

Continued from the previous page...

UART_RS485_PARITY_ERR_INT_ENA This is the enable bit for UART_RS485_PARITY_ERR_INT.
(R/W)

UART_RS485_FRM_ERR_INT_ENA This is the enable bit for UART_RS485_PARITY_ERR_INT.
(R/W)

UART_RS485_CLASH_INT_ENA This is the enable bit for UART_RS485_CLASH_INT. (R/W)

UART_AT_CMD_CHAR_DET_INT_ENA This is the enable bit for UART_AT_CMD_CHAR_DET_INT.
(R/W)

UART_WAKEUP_INT_ENA This is the enable bit for UART_WAKEUP_INT. (R/W)

Register 26.6. UART_INT_CLR_REG (0x0010)

31	(reserved)											20	19	18	17	16	15	14	13	12	11	10	9	8	7	6	5	4	3	2	1	0	Reset
0	0	0	0	0	0	0	0	0	0	0	0	0	0	0	0	0	0	0	0	0	0	0	0	0	0	0	0	0	0	0	0	Reset	

UART_RXFIFO_FULL_INT_CLR Set this bit to clear the UART_THE RXFIFO_FULL_INT interrupt. (WT)

UART_TXFIFO_EMPTY_INT_CLR Set this bit to clear the UART_TXFIFO_EMPTY_INT interrupt. (WT)

UART_PARITY_ERR_INT_CLR Set this bit to clear the UART_PARITY_ERR_INT interrupt. (WT)

UART_FRM_ERR_INT_CLR Set this bit to clear the UART_FRM_ERR_INT interrupt. (WT)

UART_RXFIFO_OVF_INT_CLR Set this bit to clear the UART_UART_RXFIFO_OVF_INT interrupt. (WT)

UART_DSR_CHG_INT_CLR Set this bit to clear the UART_DSR_CHG_INT interrupt. (WT)

UART_CTS_CHG_INT_CLR Set this bit to clear the UART_CTS_CHG_INT interrupt. (WT)

UART_BRK_DET_INT_CLR Set this bit to clear the UART_BRK_DET_INT interrupt. (WT)

UART_RXFIFO_TOUT_INT_CLR Set this bit to clear the UART_RXFIFO_TOUT_INT interrupt. (WT)

UART_SW_XON_INT_CLR Set this bit to clear the UART_SW_XON_INT interrupt. (WT)

UART_SW_XOFF_INT_CLR Set this bit to clear the UART_SW_XOFF_INT interrupt. (WT)

UART_GLITCH_DET_INT_CLR Set this bit to clear the UART_GLITCH_DET_INT interrupt. (WT)

UART_TX_BRK_DONE_INT_CLR Set this bit to clear the UART_TX_BRK_DONE_INT interrupt. (WT)

UART_TX_BRK_IDLE_DONE_INT_CLR Set this bit to clear the UART_TX_BRK_IDLE_DONE_INT interrupt. (WT)

UART_TX_DONE_INT_CLR Set this bit to clear the UART_TX_DONE_INT interrupt. (WT)

UART_RS485_PARITY_ERR_INT_CLR Set this bit to clear the UART_RS485_PARITY_ERR_INT interrupt. (WT)

Continued on the next page...

Register 26.6. UART_INT_CLR_REG (0x0010)

Continued from the previous page...

UART_RS485_FRM_ERR_INT_CLR Set this bit to clear the UART_RS485_FRM_ERR_INT interrupt. (WT)

UART_RS485_CLASH_INT_CLR Set this bit to clear the UART_RS485_CLASH_INT interrupt. (WT)

UART_AT_CMD_CHAR_DET_INT_CLR Set this bit to clear the UART_AT_CMD_CHAR_DET_INT interrupt. (WT)

UART_WAKEUP_INT_CLR Set this bit to clear the UART_WAKEUP_INT interrupt. (WT)

Register 26.7. UART_CLKDIV_REG (0x0014)

(reserved)								UART_CLKDIV_FRAG				(reserved)				UART_CLKDIV							
31								24	23				20	19				12	11				0
0 0 0 0 0 0 0 0								0x0				0 0 0 0 0 0 0 0				0x2b6				Reset			

UART_CLKDIV The integral part of the frequency divisor. (R/W)

UART_CLKDIV_FRAG The fractional part of the frequency divisor. (R/W)

Register 26.8. UART_RX_FILT_REG (0x0018)

(reserved)																UART_GLITCH_FILT_EN		UART_GLITCH_FILT		
31															9	8	7			0
0 0 0 0 0 0 0 0 0 0 0 0 0 0 0 0 0 0																0x8		Reset		

UART_GLITCH_FILT When input pulse width is lower than this value, the pulse is ignored. (R/W)

UART_GLITCH_FILT_EN Set this bit to enable RX signal filter. (R/W)

Register 26.9. UART_CONF0_REG (0x0020)

(reserved)	UART_MEM_CLK_EN	UART_AUTOBAUD_EN	UART_ERR_WFL_MASK	UART_CLK_EN	UART_DTR_INV	UART_RTS_INV	UART_TXD_INV	UART_DSR_INV	UART_CTS_INV	UART_RXD_INV	UART_TXFIFO_RST	UART_RXFIFO_RST	UART_IRDA_EN	UART_TX_FLOW_EN	UART_LOOPBACK	UART_IRDA_RX_INV	UART_IRDA_TX_INV	UART_IRDA_WCTL	UART_IRDA_DPLX	UART_TXD_BRK	UART_SW_DTR	UART_SW_RTS	UART_STOP_BIT_NUM	UART_BIT_NUM	UART_PARITY_EN	UART_PARITY				
31	29	28	27	26	25	24	23	22	21	20	19	18	17	16	15	14	13	12	11	10	9	8	7	6	5	4	3	2	1	0
0	0	0	1	0	0	0	0	0	0	0	0	0	0	0	0	0	0	0	0	0	0	0	0	0	1	3	0	0	0	

Reset

- UART_PARITY** This bit is used to configure the parity check mode. (R/W)
- UART_PARITY_EN** Set this bit to enable UART parity check. (R/W)
- UART_BIT_NUM** This field is used to set the length of data. (R/W)
- UART_STOP_BIT_NUM** This field is used to set the length of stop bit. (R/W)
- UART_SW_RTS** This bit is used to configure the software RTS signal which is used in software flow control. (R/W)
- UART_SW_DTR** This bit is used to configure the software DTR signal which is used in software flow control. (R/W)
- UART_TXD_BRK** Set this bit to enable the transmitter to send NULL characters when the process of sending data is done. (R/W)
- UART_IRDA_DPLX** Set this bit to enable IrDA loopback mode. (R/W)
- UART_IRDA_TX_EN** This is the start enable bit for IrDA transmitter. (R/W)
- UART_IRDA_WCTL** 0: Set IrDA transmitter's 11th bit to 0; 1: The IrDA transmitter's 11th bit is the same as 10th bit. (R/W)
- UART_IRDA_TX_INV** Set this bit to invert the level of IrDA transmitter. (R/W)
- UART_IRDA_RX_INV** Set this bit to invert the level of IrDA receiver. (R/W)
- UART_LOOPBACK** Set this bit to enable UART loopback test mode. (R/W)
- UART_TX_FLOW_EN** Set this bit to enable flow control function for transmitter. (R/W)
- UART_IRDA_EN** Set this bit to enable IrDA protocol. (R/W)
- UART_RXFIFO_RST** Set this bit to reset the UART RX FIFO. (R/W)
- UART_TXFIFO_RST** Set this bit to reset the UART TX FIFO. (R/W)
- UART_RXD_INV** Set this bit to invert the level value of UART RXD signal. (R/W)
- UART_CTS_INV** Set this bit to invert the level value of UART CTS signal. (R/W)
- UART_DSR_INV** Set this bit to invert the level value of UART DSR signal. (R/W)

Continued on the next page...

Register 26.9. UART_CONF0_REG (0x0020)

Continued from the previous page...

UART_TXD_INV Set this bit to invert the level value of UART TXD signal. (R/W)

UART_RTS_INV Set this bit to invert the level value of UART RTS signal. (R/W)

UART_DTR_INV Set this bit to invert the level value of UART DTR signal. (R/W)

UART_CLK_EN 0: Support clock only when application writes registers; 1: Force clock on for registers. (R/W)

UART_ERR_WR_MASK 0: Receiver stores the data even if the received data is wrong; 1: Receiver stops storing data into FIFO when data is wrong. (R/W)

UART_AUTOBAUD_EN This is the enable bit for baud rate detection. (R/W)

UART_MEM_CLK_EN The signal to enable UART RAM clock gating. (R/W)

Register 26.10. UART_CONF1_REG (0x0024)

(reserved)								UART_RX_TOUT_EN				UART_TXFIFO_EMPTY_THRHD				UART_RXFIFO_FULL_THRHD				
UART_RX_FLOW_EN								UART_RX_TOUT_FLOW_DIS				UART_TXFIFO_EMPTY_THRHD				UART_RXFIFO_FULL_THRHD				
UART_DIS_RX_DAT_OVF								UART_TXFIFO_EMPTY_THRHD				UART_RXFIFO_FULL_THRHD				UART_RXFIFO_FULL_THRHD				
31								24	23	22	21	20	19			10	9			0
0	0	0	0	0	0	0	0	0	0	0	0	0x60				0x60				Reset

UART_RXFIFO_FULL_THRHD An UART_RXFIFO_FULL_INT interrupt is generated when the receiver receives more data than the value of this field. (R/W)

UART_TXFIFO_EMPTY_THRHD An UART_TXFIFO_EMPTY_INT interrupt is generated when the number of data bytes in TX FIFO is less than the value of this field. (R/W)

UART_DIS_RX_DAT_OVF Disable UART RX data overflow detection. (R/W)

UART_RX_TOUT_FLOW_DIS Set this bit to stop accumulating idle_cnt when hardware flow control works. (R/W)

UART_RX_FLOW_EN This is the flow enable bit for UART receiver. (R/W)

UART_RX_TOUT_EN This is the enable bit for UART receiver's timeout function. (R/W)

Register 26.11. UART_FLOW_CONF_REG (0x0034)

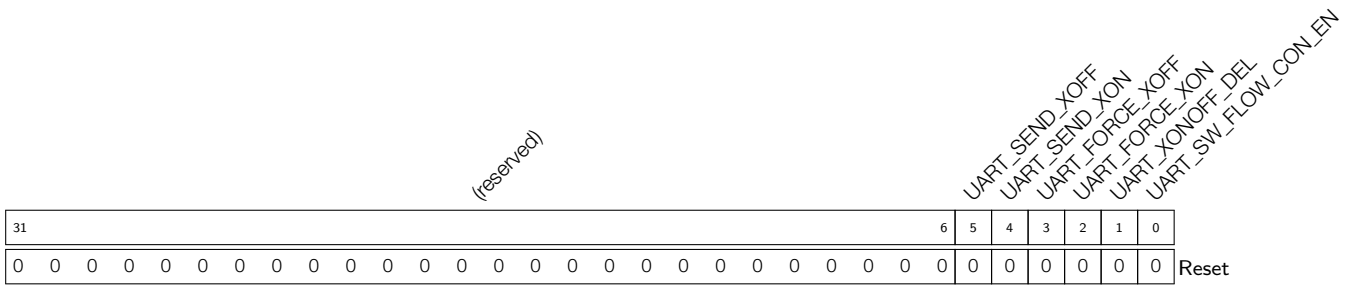

UART_SW_FLOW_CON_EN Set this bit to enable software flow control. When UART receives flow control characters XON or XOFF, which can be configured by UART_XON_CHAR or UART_XOFF_CHAR respectively, UART_SW_XON_INT or UART_SW_XOFF_INT interrupts can be triggered if enabled. (R/W)

UART_XONOFF_DEL Set this bit to remove flow control characters from the received data. (R/W)

UART_FORCE_XON Set this bit to force the transmitter to send data. (R/W)

UART_FORCE_XOFF Set this bit to stop the transmitter from sending data. (R/W)

UART_SEND_XON Set this bit to send an XON character. This bit is cleared by hardware automatically. (R/W/SS/SC)

UART_SEND_XOFF Set this bit to send an XOFF character. This bit is cleared by hardware automatically. (R/W/SS/SC)

Register 26.12. UART_SLEEP_CONF_REG (0x0038)

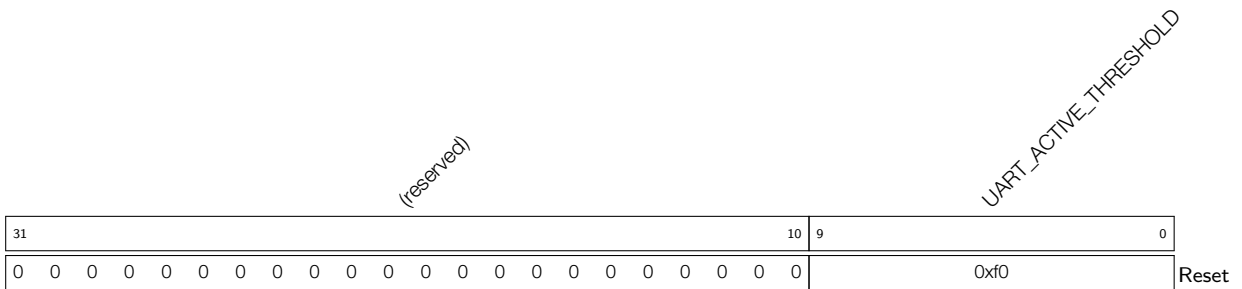

UART_ACTIVE_THRESHOLD UART is activated from Light-sleep mode when the input RXD edge changes more times than the value of this field. (R/W)

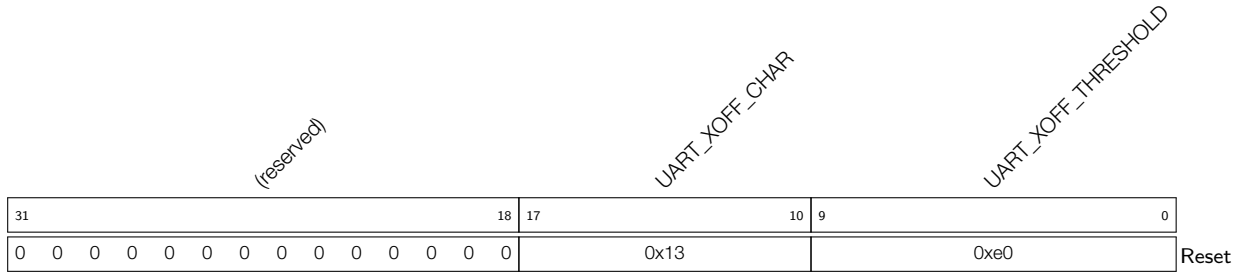
Register 26.13. UART_SWFC_CONF0_REG (0x003C)

UART_XOFF_THRESHOLD When the number of data bytes in RX FIFO is more than the value of this field with UART_SW_FLOW_CON_EN set to 1, the transmitter sends an XOFF character. (R/W)

UART_XOFF_CHAR This field stores the XOFF flow control character. (R/W)

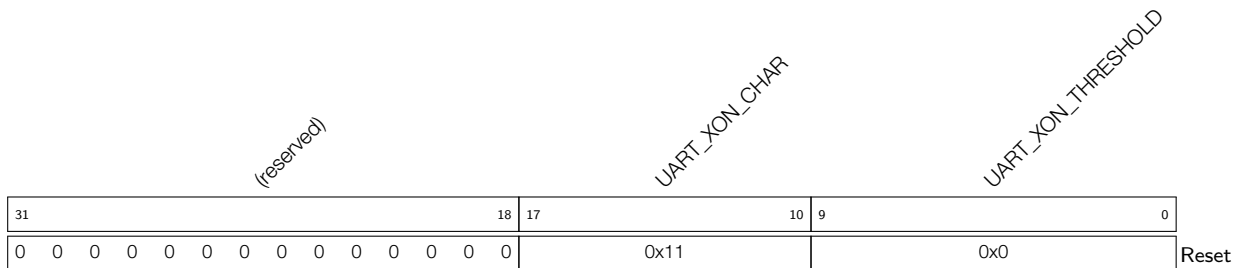
Register 26.14. UART_SWFC_CONF1_REG (0x0040)

UART_XON_THRESHOLD When the number of data bytes in RX FIFO is less than the value of this field with UART_SW_FLOW_CON_EN set to 1, the transmitter sends an XON character. (R/W)

UART_XON_CHAR This field stores the XON flow control character. (R/W)

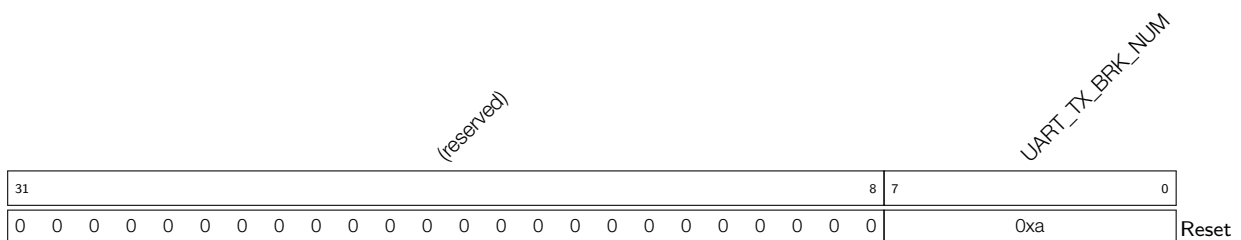
Register 26.15. UART_TXBRK_CONF_REG (0x0044)

UART_TX_BRK_NUM This field is used to configure the number of 0 to be sent after the process of sending data is done. It is active when UART_TXD_BRK is set to 1. (R/W)

Register 26.16. UART_IDLE_CONF_REG (0x0048)

(reserved)										UART_TX_IDLE_NUM										UART_RX_IDLE_THRHD																				
31											20	19											10	9											0					
0										0										0x100										0x100										Reset

UART_RX_IDLE_THRHD A frame end signal is generated when the receiver takes more time to receive one byte data than the value of this field, in the unit of bit time (the time it takes to transfer one bit). (R/W)

UART_TX_IDLE_NUM This field is used to configure the duration time between transfers, in the unit of bit time (the time it takes to transfer one bit). (R/W)

Register 26.17. UART_RS485_CONF_REG (0x004C)

(reserved)										UART_RS485_TX_DLY_NUM										UART_RS485_RX_DLY_NUM										UART_RS485RXBY_TX_EN										UART_RS485TX_RX_EN										UART_DL1_EN										UART_DL0_EN										UART_RS485_EN																														
31											20	19											10	9	8	7	6	5	4	3	2	1	0	31											20	19											10	9											0																															
0										0										0										0										0										0										0										0										0										0										Reset

UART_RS485_EN Set this bit to choose RS485 mode. (R/W)

UART_DL0_EN Set this bit to delay the stop bit by 1 bit. (R/W)

UART_DL1_EN Set this bit to delay the stop bit by 1 bit. (R/W)

UART_RS485TX_RX_EN Set this bit to enable receiver could receive data when the transmitter is transmitting data in RS485 mode. (R/W)

UART_RS485RXBY_TX_EN 1: enable RS485 transmitter to send data when RS485 receiver line is busy. (R/W)

UART_RS485_RX_DLY_NUM This bit is used to delay the receiver's internal data signal. (R/W)

UART_RS485_TX_DLY_NUM This field is used to delay the transmitter's internal data signal. (R/W)

Register 26.18. UART_CLK_CONF_REG (0x0078)

(reserved)				UART_RX_RST_CORE				UART_TX_RST_CORE				UART_RX_SCLK_EN				UART_TX_SCLK_EN				UART_RST_CORE				UART_SCLK_EN				UART_SCLK_SEL				UART_SCLK_DIV_NUM				UART_SCLK_DIV_A				UART_SCLK_DIV_B			
31	28	27	26	25	24	23	22	21	20	19	12	11	6	5	0																												
0	0	0	0	0	0	1	1	0	1	3	0x1				0x0				0x0				Reset																				

UART_SCLK_DIV_B The denominator of the frequency divisor. (R/W)

UART_SCLK_DIV_A The numerator of the frequency divisor. (R/W)

UART_SCLK_DIV_NUM The integral part of the frequency divisor. (R/W)

UART_SCLK_SEL Selects UART clock source. 1: APB_CLK; 2: RC_FAST_CLK; 3: XTAL_CLK.
(R/W)

UART_SCLK_EN Set this bit to enable UART TX/RX clock. (R/W)

UART_RST_CORE Write 1 and then write 0 to this bit, to reset UART TX/RX. (R/W)

UART_TX_SCLK_EN Set this bit to enable UART TX clock. (R/W)

UART_RX_SCLK_EN Set this bit to enable UART RX clock. (R/W)

UART_TX_RST_CORE Write 1 and then write 0 to this bit, to reset UART TX. (R/W)

UART_RX_RST_CORE Write 1 and then write 0 to this bit, to reset UART RX. (R/W)

Register 26.19. UART_STATUS_REG (0x001C)

UART_TXD UART_RTSN UART_DTRN (reserved)			UART_TXFIFO_CNT				UART_RXD UART_CTSN UART_DSRN (reserved)				UART_RXFIFO_CNT		
31	30	29	28	26	25	16	15	14	13	12	10	9	0
1	1	1	0	0	0	0	0	0	0	0	0	0	0

Reset

UART_RXFIFO_CNT Stores the number of valid data bytes in RX FIFO. (RO)

UART_DSRN This bit represents the level of the internal UART DSR signal. (RO)

UART_CTSN This bit represents the level of the internal UART CTS signal. (RO)

UART_RXD This bit represents the level of the internal UART RXD signal. (RO)

UART_TXFIFO_CNT Stores the number of data bytes in TX FIFO. (RO)

UART_DTRN This bit represents the level of the internal UART DTR signal. (RO)

UART_RTSN This bit represents the level of the internal UART RTS signal. (RO)

UART_TXD This bit represents the level of the internal UART TXD signal. (RO)

Register 26.20. UART_MEM_TX_STATUS_REG (0x0064)

(reserved)								UART_TX_RADDR			(reserved)		UART_APB_TX_WADDR	
31	21	20	11	10	9	0	0	0	0	0	0	0	0	
0	0	0	0	0	0	0	0	0	0	0	0	0	0	

Reset

UART_APB_TX_WADDR This field stores the offset address in TX FIFO when software writes TX FIFO via APB. (RO)

UART_TX_RADDR This field stores the offset address in TX FIFO when TX FSM reads data via Tx_FIFO_Ctrl. (RO)

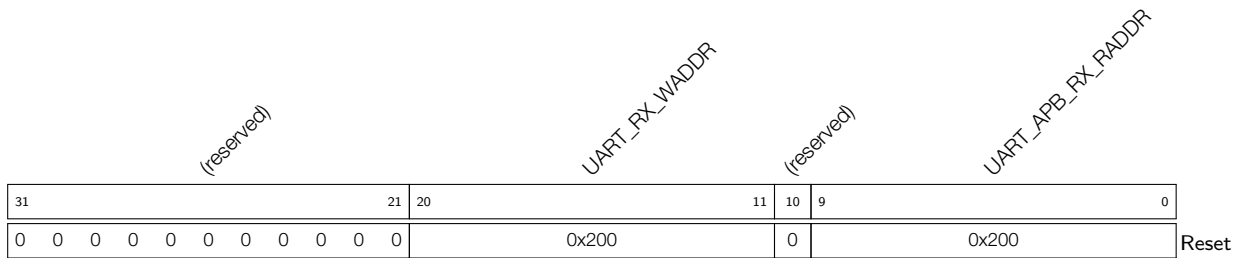
Register 26.21. UART_MEM_RX_STATUS_REG (0x0068)

UART_APB_RX_RADDR This field stores the offset address in RX FIFO when software reads data from RX FIFO via APB. UART0 is 0x200. UART1 is 0x280. UART2 is 0x300. (RO)

UART_RX_WADDR This field stores the offset address in RX FIFO when Rx_FIFO_Ctrl writes RX FIFO. UART0 is 0x200. UART1 is 0x280. UART2 is 0x300. (RO)

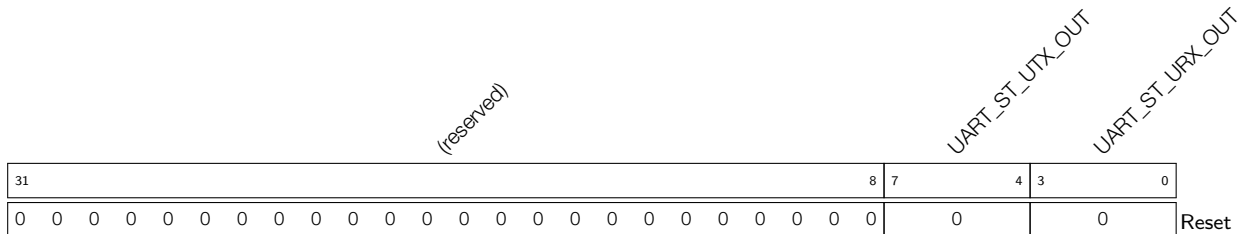
Register 26.22. UART_FSM_STATUS_REG (0x006C)

UART_ST_URX_OUT This is the status field of the receiver. (RO)

UART_ST_UTX_OUT This is the status field of the transmitter. (RO)

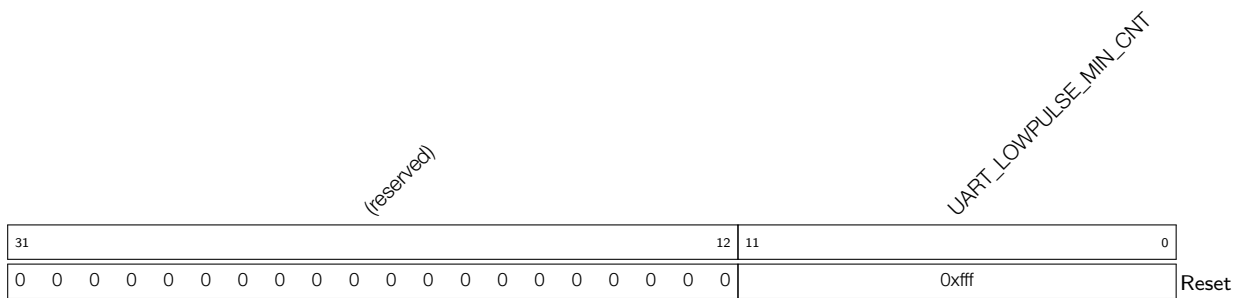
Register 26.23. UART_LOWPULSE_REG (0x0028)

UART_LOWPULSE_MIN_CNT This field stores the value of the minimum duration time of the low level pulse, in the unit of APB_CLK cycles. It is used in baud rate detection. (RO)

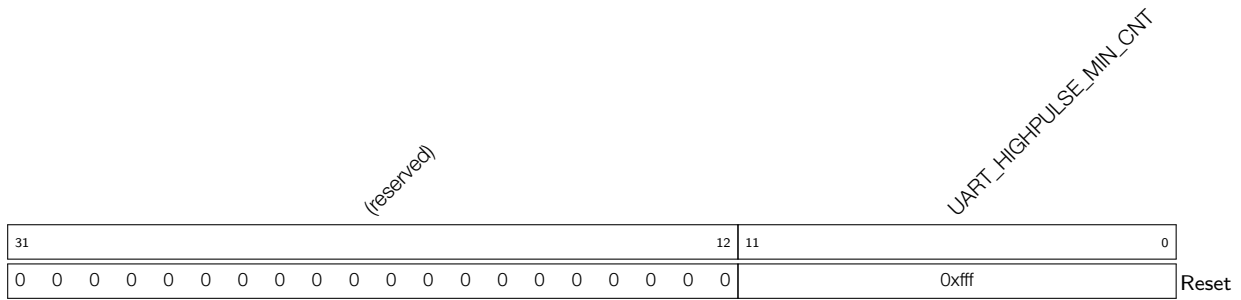
Register 26.24. UART_HIGHPULSE_REG (0x002C)

UART_HIGHPULSE_MIN_CNT This field stores the value of the maximum duration time for the high level pulse, in the unit of APB_CLK cycles. It is used in baud rate detection. (RO)

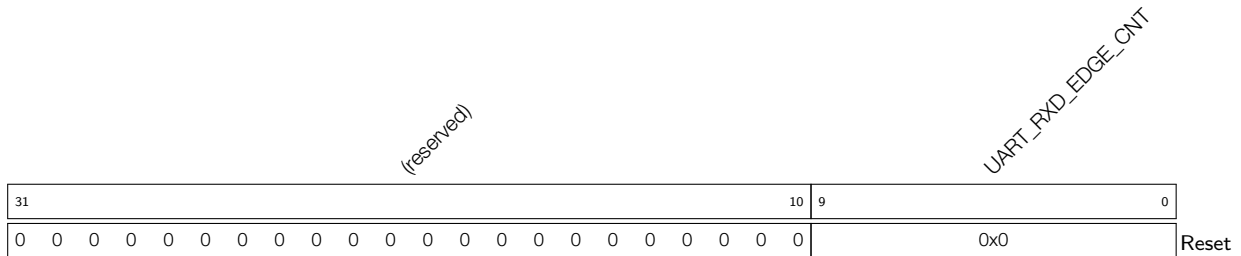
Register 26.25. UART_RXD_CNT_REG (0x0030)

UART_RXD_EDGE_CNT This field stores the count of RXD edge change. It is used in baud rate detection. (RO)

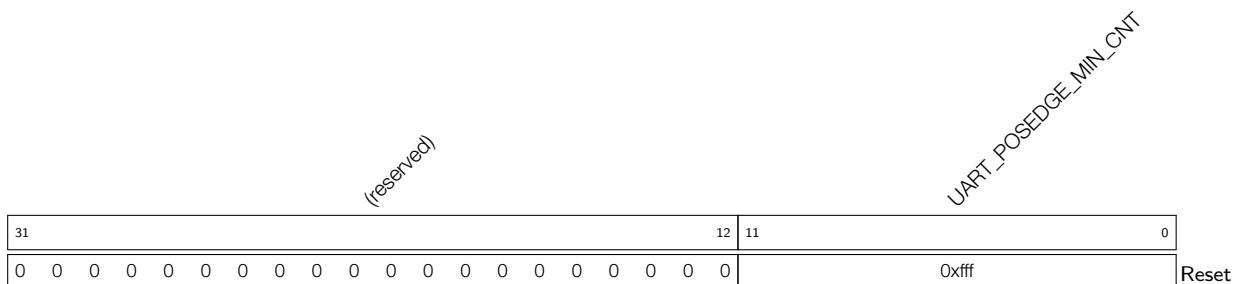
Register 26.26. UART_POSEDGE_REG (0x0070)

UART_POSEDGE_MIN_CNT This field stores the minimal input clock count between two positive edges. It is used in baud rate detection. (RO)

Register 26.27. UART_NEGPULSE_REG (0x0074)

<i>(reserved)</i>																<i>UART_NEGEDGE_MIN_CNT</i>																	
31																12	11																0
0 0 0 0 0 0 0 0 0 0 0 0 0 0 0 0																0xfff																Reset	

UART_NEGEDGE_MIN_CNT This field stores the minimal input clock count between two negative edges. It is used in baud rate detection. (RO)

Register 26.28. UART_AT_CMD_PRECNT_REG (0x0050)

<i>(reserved)</i>																<i>UART_PRE_IDLE_NUM</i>																	
31																16	15																0
0 0 0 0 0 0 0 0 0 0 0 0 0 0 0 0																0x901																Reset	

UART_PRE_IDLE_NUM This field is used to configure the idle duration time before the first AT_CMD is received by the receiver, in the unit of bit time (the time it takes to transfer one bit). (R/W)

Register 26.29. UART_AT_CMD_POSTCNT_REG (0x0054)

<i>(reserved)</i>																<i>UART_POST_IDLE_NUM</i>																	
31																16	15																0
0 0 0 0 0 0 0 0 0 0 0 0 0 0 0 0																0x901																Reset	

UART_POST_IDLE_NUM This field is used to configure the duration time between the last AT_CMD and the next data byte, in the unit of bit time (the time it takes to transfer one bit). (R/W)

Register 26.30. UART_AT_CMD_GAPTOUT_REG (0x0058)

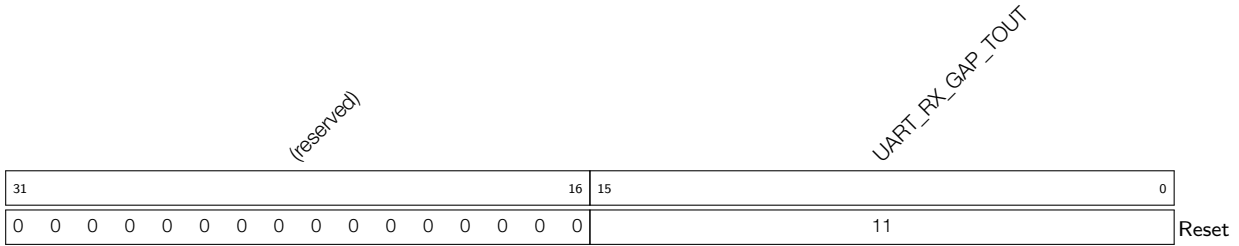

UART_RX_GAP_TOUT This field is used to configure the duration time between the AT_CMD characters, in the unit of bit time (the time it takes to transfer one bit). (R/W)

Register 26.31. UART_AT_CMD_CHAR_REG (0x005C)

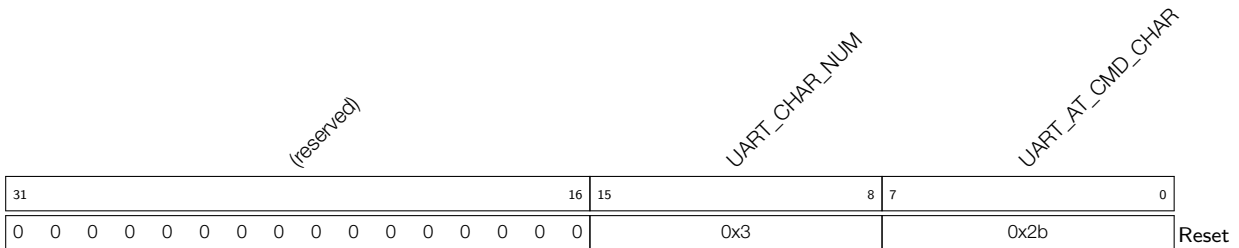

UART_AT_CMD_CHAR This field is used to configure the content of AT_CMD character. (R/W)

UART_CHAR_NUM This field is used to configure the number of continuous AT_CMD characters received by the receiver. (R/W)

Register 26.32. UART_DATE_REG (0x007C)

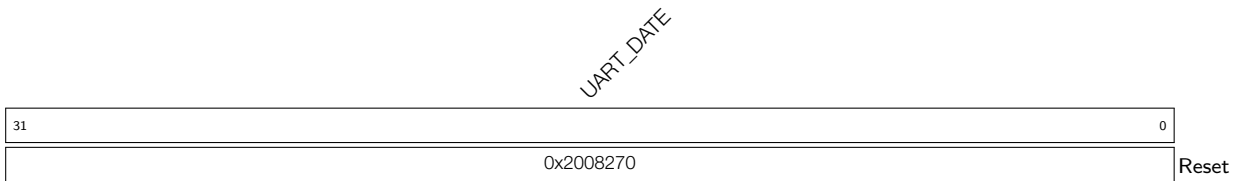

UART_DATE This is the version control register. (R/W)

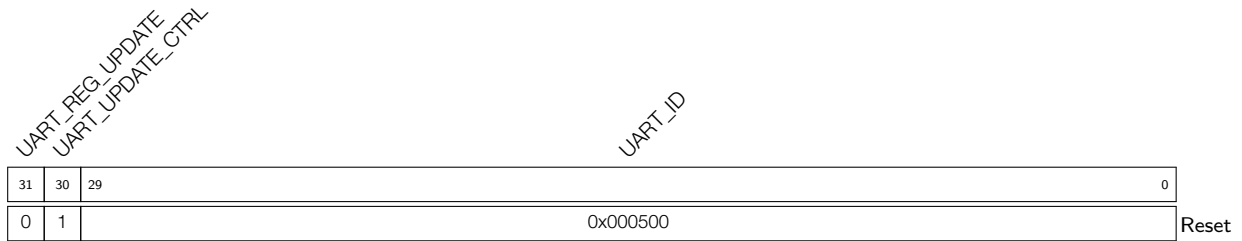
Register 26.33. UART_ID_REG (0x0080)

UART_ID This field is used to configure the UART_ID. (R/W)

UART_UPDATE_CTRL This bit is used to control register synchronization mode. 0: After registers are configured, software needs to write 1 to UART_REG_UPDATE to synchronize registers; 1: Registers are automatically synchronized into UART Core's clock domain. (R/W)

UART_REG_UPDATE When this bit is set to 1 by software, registers are synchronized to UART Core's clock domain. This bit is cleared by hardware after synchronization is done. (R/W/SC)

26.7.2 UHCI Registers

The addresses in this section are relative to **UHCI Controller** base address provided in Table 4-3 in Chapter 4 *System and Memory*.

Register 26.35. UHCI_CONF1_REG (0x0018)

(reserved)										UHCI_SW_START UHCI_WAIT_SW_START (reserved) UHCI_TX_ACK_NUM_RE UHCI_TX_CHECK_SUM_RE UHCI_SAVE_HEAD UHCI_CRC_DISABLE UHCI_CHECK_SEQ_EN UHCI_CHECK_SUM_EN																			
31											9	8	7	6	5	4	3	2	1	0									
0										0										0	0	0	1	1	0	0	1	1	Reset

UHCI_CHECK_SUM_EN This is the enable bit to check header checksum when UHCI receives a data packet. (R/W)

UHCI_CHECK_SEQ_EN This is the enable bit to check sequence number when UHCI receives a data packet. (R/W)

UHCI_CRC_DISABLE Set this bit to support CRC calculation. Data Integrity Check Present bit in UHCI packet frame should be 1. (R/W)

UHCI_SAVE_HEAD Set this bit to save the packet header when UHCI receives a data packet. (R/W)

UHCI_TX_CHECK_SUM_RE Set this bit to encode the data packet with a checksum. (R/W)

UHCI_TX_ACK_NUM_RE Set this bit to encode the data packet with an acknowledgment when a reliable packet is to be transmitted. (R/W)

UHCI_WAIT_SW_START The UHCI encoder will jump to ST_SW_WAIT status if this bit is set to 1. (R/W)

UHCI_SW_START If current UHCI_ENCODE_STATE is ST_SW_WAIT, the UHCI will start to send data packet out when this bit is set to 1. (R/W/SC)

Register 26.37. UHCI_HUNG_CONF_REG (0x0028)

(reserved)								UHCI_RXFIFO_TIMEOUT_ENA				UHCI_RXFIFO_TIMEOUT_SHIFT				UHCI_RXFIFO_TIMEOUT				UHCI_TXFIFO_TIMEOUT_ENA				UHCI_TXFIFO_TIMEOUT_SHIFT				UHCI_TXFIFO_TIMEOUT			
31								24	23	22	20	19				12	11	10	8	7				0							
0 0 0 0 0 0 0 0								1	0	0x10				1	0	0x10				Reset											

UHCI_TXFIFO_TIMEOUT This field stores the timeout value. UHCI will produce the UHCI_TX_HUNG_INT interrupt when DMA takes more time to receive data. (R/W)

UHCI_TXFIFO_TIMEOUT_SHIFT This field is used to configure the maximum tick count. (R/W)

UHCI_TXFIFO_TIMEOUT_ENA This is the enable bit for TX FIFO receive timeout. (R/W)

UHCI_RXFIFO_TIMEOUT This field stores the timeout value. UHCI will produce the UHCI_RX_HUNG_INT interrupt when DMA takes more time to read data from RAM. (R/W)

UHCI_RXFIFO_TIMEOUT_SHIFT This field is used to configure the maximum tick count. (R/W)

UHCI_RXFIFO_TIMEOUT_ENA This is the enable bit for DMA send timeout. (R/W)

Register 26.38. UHCI_ACK_NUM_REG (0x002C)

(reserved)																UHCI_ACK_NUM_LOAD			UHCI_ACK_NUM		
31														4	3	2	0				
0 0 0 0 0 0 0 0 0 0 0 0 0 0 0 0																1	0x0		Reset		

UHCI_ACK_NUM This is the ACK number used in software flow control. (R/W)

UHCI_ACK_NUM_LOAD Set this bit to 1, and the value configured by UHCI_ACK_NUM would be loaded. (WT)

Register 26.39. UHCI_QUICK_SENT_REG (0x0034)

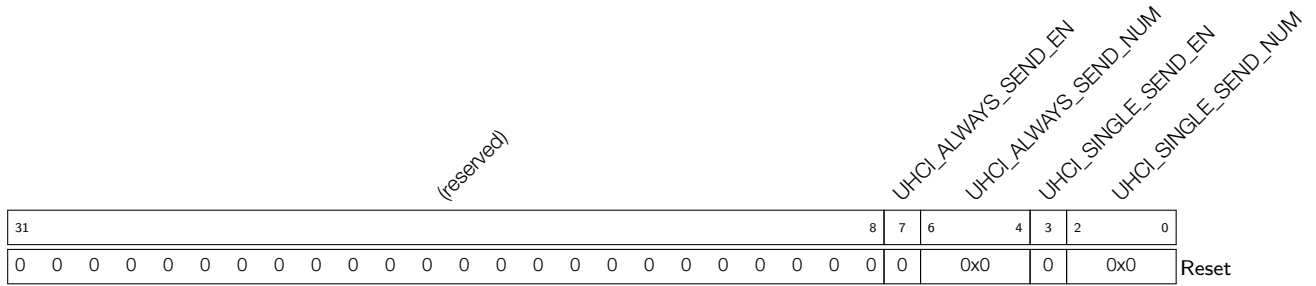

UHCI_SINGLE_SEND_NUM This field is used to specify single_send mode. (R/W)

UHCI_SINGLE_SEND_EN Set this bit to enable single_send mode to send short packets. (R/W/SC)

UHCI_ALWAYS_SEND_NUM This field is used to specify always_send mode. (R/W)

UHCI_ALWAYS_SEND_EN Set this bit to enable always_send mode to send short packets. (R/W)

Register 26.40. UHCI_REG_Q0_WORD0_REG (0x0038)

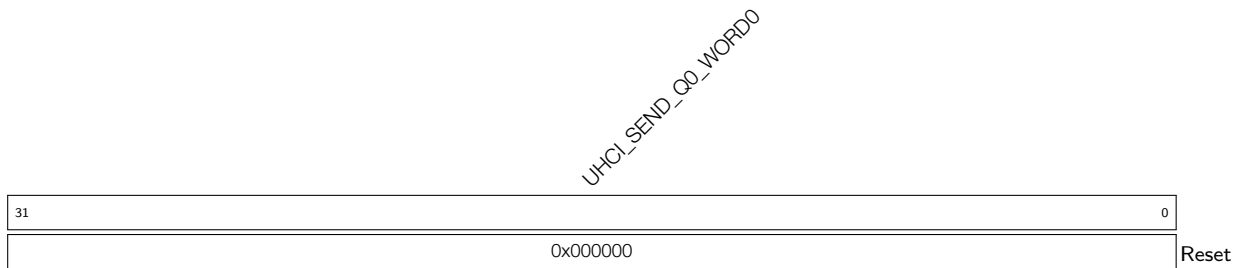

UHCI_SEND_Q0_WORD0 This register is used as a quick_send register when mode is specified by UHCI_ALWAYS_SEND_NUM or UHCI_SINGLE_SEND_NUM. (R/W)

Register 26.41. UHCI_REG_Q0_WORD1_REG (0x003C)

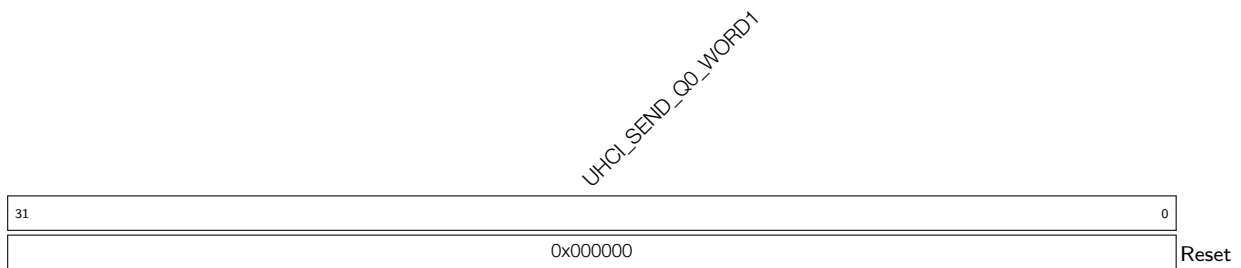

UHCI_SEND_Q0_WORD1 This register is used as a quick_send register when mode is specified by UHCI_ALWAYS_SEND_NUM or UHCI_SINGLE_SEND_NUM. (R/W)

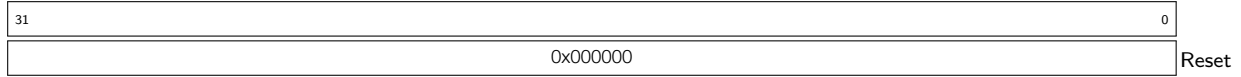
Register 26.42. UHCI_REG_Q1_WORD0_REG (0x0040)*UHCI_SEND_Q1_WORD0*

UHCI_SEND_Q1_WORD0 This register is used as a quick_sent register when mode is specified by UHCI_ALWAYS_SEND_NUM or UHCI_SINGLE_SEND_NUM. (R/W)

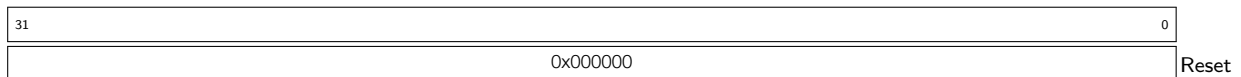
Register 26.43. UHCI_REG_Q1_WORD1_REG (0x0044)*UHCI_SEND_Q1_WORD1*

UHCI_SEND_Q1_WORD1 This register is used as a quick_sent register when mode is specified by UHCI_ALWAYS_SEND_NUM or UHCI_SINGLE_SEND_NUM. (R/W)

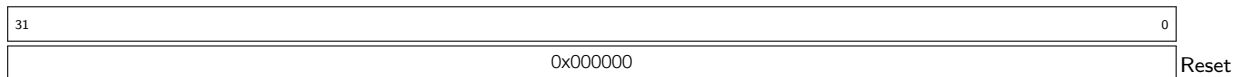
Register 26.44. UHCI_REG_Q2_WORD0_REG (0x0048)*UHCI_SEND_Q2_WORD0*

UHCI_SEND_Q2_WORD0 This register is used as a quick_sent register when mode is specified by UHCI_ALWAYS_SEND_NUM or UHCI_SINGLE_SEND_NUM. (R/W)

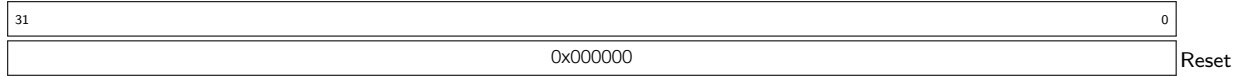
Register 26.45. UHCI_REG_Q2_WORD1_REG (0x004C)*UHCI_SEND_Q2_WORD1*

UHCI_SEND_Q2_WORD1 This register is used as a quick_sent register when mode is specified by UHCI_ALWAYS_SEND_NUM or UHCI_SINGLE_SEND_NUM. (R/W)

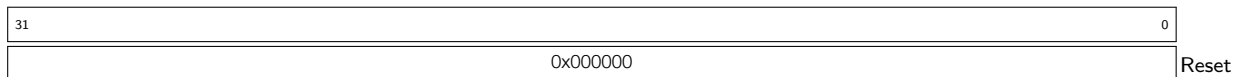
Register 26.46. UHCI_REG_Q3_WORD0_REG (0x0050)*UHCI_SEND_Q3_WORD0*

UHCI_SEND_Q3_WORD0 This register is used as a quick_sent register when mode is specified by UHCI_ALWAYS_SEND_NUM or UHCI_SINGLE_SEND_NUM. (R/W)

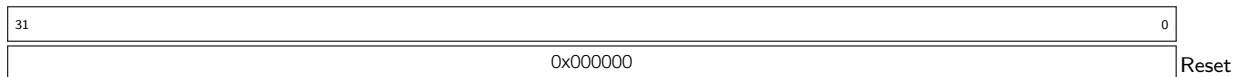
Register 26.47. UHCI_REG_Q3_WORD1_REG (0x0054)*UHCI_SEND_Q3_WORD1*

UHCI_SEND_Q3_WORD1 This register is used as a quick_sent register when mode is specified by UHCI_ALWAYS_SEND_NUM or UHCI_SINGLE_SEND_NUM. (R/W)

Register 26.48. UHCI_REG_Q4_WORD0_REG (0x0058)*UHCI_SEND_Q4_WORD0*

31	0
0x000000	
	Reset

UHCI_SEND_Q4_WORD0 This register is used as a quick_sent register when mode is specified by UHCI_ALWAYS_SEND_NUM or UHCI_SINGLE_SEND_NUM. (R/W)

Register 26.49. UHCI_REG_Q4_WORD1_REG (0x005C)*UHCI_SEND_Q4_WORD1*

31	0
0x000000	
	Reset

UHCI_SEND_Q4_WORD1 This register is used as a quick_sent register when mode is specified by UHCI_ALWAYS_SEND_NUM or UHCI_SINGLE_SEND_NUM. (R/W)

Register 26.50. UHCI_REG_Q5_WORD0_REG (0x0060)*UHCI_SEND_Q5_WORD0*

31	0
0x000000	
	Reset

UHCI_SEND_Q5_WORD0 This register is used as a quick_sent register when mode is specified by UHCI_ALWAYS_SEND_NUM or UHCI_SINGLE_SEND_NUM. (R/W)

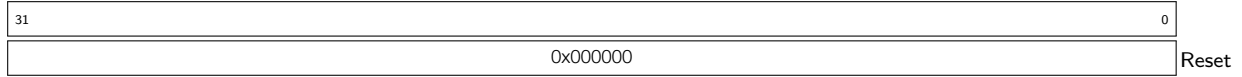
Register 26.51. UHCI_REG_Q5_WORD1_REG (0x0064)*UHCI_SEND_Q5_WORD1*

UHCI_SEND_Q5_WORD1 This register is used as a quick_sent register when mode is specified by UHCI_ALWAYS_SEND_NUM or UHCI_SINGLE_SEND_NUM. (R/W)

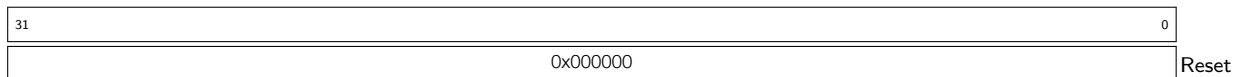
Register 26.52. UHCI_REG_Q6_WORD0_REG (0x0068)*UHCI_SEND_Q6_WORD0*

UHCI_SEND_Q6_WORD0 This register is used as a quick_sent register when mode is specified by UHCI_ALWAYS_SEND_NUM or UHCI_SINGLE_SEND_NUM. (R/W)

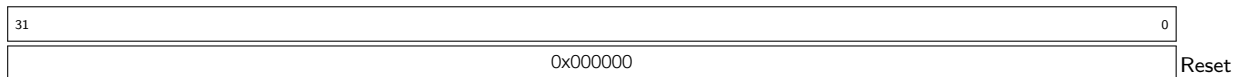
Register 26.53. UHCI_REG_Q6_WORD1_REG (0x006C)*UHCI_SEND_Q6_WORD1*

UHCI_SEND_Q6_WORD1 This register is used as a quick_sent register when mode is specified by UHCI_ALWAYS_SEND_NUM or UHCI_SINGLE_SEND_NUM. (R/W)

Register 26.54. UHCI_ESC_CONF0_REG (0x0070)

(reserved)								UHCI_SEPER_ESC_CHAR1								UHCI_SEPER_ESC_CHAR0								UHCI_SEPER_CHAR																																
31								24								23								16								15								8								7								0
0 0 0 0 0 0 0 0								0xdc								0xdb								0xc0								Reset																								

UHCI_SEPER_CHAR This field is used to define separators to encode data packets. The default value is 0xC0. (R/W)

UHCI_SEPER_ESC_CHAR0 This field is used to define the first character of SLIP escape sequence. The default value is 0xDB. (R/W)

UHCI_SEPER_ESC_CHAR1 This field is used to define the second character of SLIP escape sequence. The default value is 0xDC. (R/W)

Register 26.55. UHCI_ESC_CONF1_REG (0x0074)

(reserved)								UHCI_ESC_SEQ_CHAR1								UHCI_ESC_SEQ_CHAR0								UHCI_ESC_SEQ0																																
31								24								23								16								15								8								7								0
0 0 0 0 0 0 0 0								0xdd								0xdb								0xdb								Reset																								

UHCI_ESC_SEQ0 This field is used to define a character that need to be encoded. The default value is 0xDB that used as the first character of SLIP escape sequence. (R/W)

UHCI_ESC_SEQ0_CHAR0 This field is used to define the first character of SLIP escape sequence. The default value is 0xDB. (R/W)

UHCI_ESC_SEQ0_CHAR1 This field is used to define the second character of SLIP escape sequence. The default value is 0xDD. (R/W)

Register 26.56. UHCI_ESC_CONF2_REG (0x0078)

<i>(reserved)</i>								<i>UHCI_ESC_SEQ1_CHAR1</i>								<i>UHCI_ESC_SEQ1_CHAR0</i>								<i>UHCI_ESC_SEQ1</i>											
31								24	23								16	15								8	7								0
0 0 0 0 0 0 0 0								0xde								0xdb								0x11								Reset			

UHCI_ESC_SEQ1 This field is used to define a character that need to be encoded. The default value is 0x11 that used as a flow control character. (R/W)

UHCI_ESC_SEQ1_CHAR0 This field is used to define the first character of SLIP escape sequence. The default value is 0xDB. (R/W)

UHCI_ESC_SEQ1_CHAR1 This field is used to define the second character of SLIP escape sequence. The default value is 0xDE. (R/W)

Register 26.57. UHCI_ESC_CONF3_REG (0x007C)

<i>(reserved)</i>								<i>UHCI_ESC_SEQ2_CHAR1</i>								<i>UHCI_ESC_SEQ2_CHAR0</i>								<i>UHCI_ESC_SEQ2</i>											
31								24	23								16	15								8	7								0
0 0 0 0 0 0 0 0								0xdf								0xdb								0x13								Reset			

UHCI_ESC_SEQ2 This field is used to define a character that need to be decoded. The default value is 0x13 that used as a flow control character. (R/W)

UHCI_ESC_SEQ2_CHAR0 This field is used to define the first character of SLIP escape sequence. The default value is 0xDB. (R/W)

UHCI_ESC_SEQ2_CHAR1 This field is used to define the second character of SLIP escape sequence. The default value is 0xDF. (R/W)

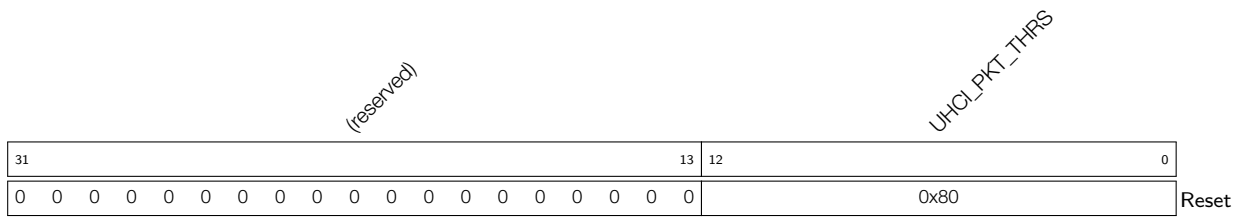
Register 26.58. UHCI_PKT_THRES_REG (0x0080)

UHCI_PKT_THRS This field is used to configure the maximum value of the packet length when UHCI_HEAD_EN is 0. (R/W)

Register 26.59. UHCI_INT_RAW_REG (0x0004)

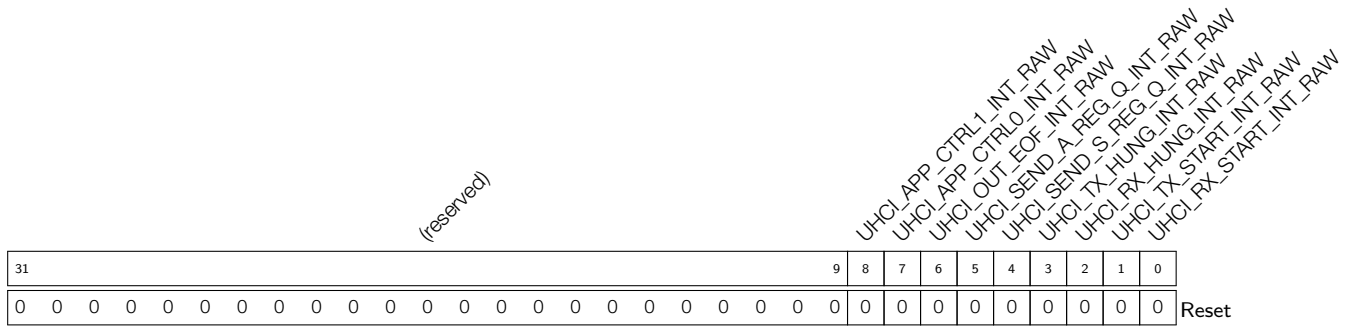

UHCI_RX_START_INT_RAW This is the interrupt raw bit for UHCI_RX_START_INT interrupt. The interrupt is triggered when a separator has been sent. (R/WTC/SS)

UHCI_TX_START_INT_RAW This is the interrupt raw bit for UHCI_TX_START_INT interrupt. The interrupt is triggered when UHCI detects a separator. (R/WTC/SS)

UHCI_RX_HUNG_INT_RAW This is the interrupt raw bit for UHCI_RX_HUNG_INT interrupt. The interrupt is triggered when UHCI takes more time to receive data than configure value. (R/WTC/SS)

UHCI_TX_HUNG_INT_RAW This is the interrupt raw bit for UHCI_TX_HUNG_INT interrupt. The interrupt is triggered when UHCI takes more time to read data from RAM than the configured value. (R/WTC/SS)

UHCI_SEND_S_REG_Q_INT_RAW This is the interrupt raw bit for UHCI_SEND_S_REG_Q_INT interrupt. The interrupt is triggered when UHCI has sent out a short packet using single_send mode. (R/WTC/SS)

UHCI_SEND_A_REG_Q_INT_RAW This is the interrupt raw bit for UHCI_SEND_A_REG_Q_INT interrupt. The interrupt is triggered when UHCI has sent out a short packet using always_send mode. (R/WTC/SS)

UHCI_OUT_EOF_INT_RAW This is the interrupt raw bit for UHCI_OUT_EOF_INT interrupt. The interrupt is triggered when there are some errors in EOF in the transmit descriptors. (R/WTC/SS)

UHCI_APP_CTRL0_INT_RAW This is the interrupt raw bit for UHCI_APP_CTRL0_INT interrupt. The interrupt is triggered when UHCI_APP_CTRL0_IN_SET is set. (R/W)

UHCI_APP_CTRL1_INT_RAW This is the interrupt raw bit for UHCI_APP_CTRL1_INT interrupt. The interrupt is triggered when UHCI_APP_CTRL1_IN_SET is set. (R/W)

Register 26.60. UHCI_INT_ST_REG (0x0008)

(reserved)																UHCI_APP_CTRL1_INT_ST UHCI_APP_CTRL0_INT_ST UHCI_OUTLINK_EOF_ERR_INT_ST UHCI_SEND_A_REG_Q_INT_ST UHCI_SEND_S_REG_Q_INT_ST UHCI_TX_HUNG_INT_ST UHCI_RX_HUNG_INT_ST UHCI_TX_START_INT_ST UHCI_RX_START_INT_ST										
31																9	8	7	6	5	4	3	2	1	0	Reset
0																0										0

UHCI_RX_START_INT_ST This is the masked interrupt bit for UHCI_RX_START_INT interrupt when UHCI_RX_START_INT_ENA is set to 1. (RO)

UHCI_TX_START_INT_ST This is the masked interrupt bit for UHCI_TX_START_INT interrupt when UHCI_TX_START_INT_ENA is set to 1. (RO)

UHCI_RX_HUNG_INT_ST This is the masked interrupt bit for UHCI_RX_HUNG_INT interrupt when UHCI_RX_HUNG_INT_ENA is set to 1. (RO)

UHCI_TX_HUNG_INT_ST This is the masked interrupt bit for UHCI_TX_HUNG_INT interrupt when UHCI_TX_HUNG_INT_ENA is set to 1. (RO)

UHCI_SEND_S_REG_Q_INT_ST This is the masked interrupt bit for UHCI_SEND_S_REG_Q_INT interrupt when UHCI_SEND_S_REG_Q_INT_ENA is set to 1. (RO)

UHCI_SEND_A_REG_Q_INT_ST This is the masked interrupt bit for UHCI_SEND_A_REG_Q_INT interrupt when UHCI_SEND_A_REG_Q_INT_ENA is set to 1. (RO)

UHCI_OUTLINK_EOF_ERR_INT_ST This is the masked interrupt bit for UHCI_OUTLINK_EOF_ERR_INT interrupt when UHCI_OUTLINK_EOF_ERR_INT_ENA is set to 1. (RO)

UHCI_APP_CTRL0_INT_ST This is the masked interrupt bit for UHCI_APP_CTRL0_INT interrupt when UHCI_APP_CTRL0_INT_ENA is set to 1. (RO)

UHCI_APP_CTRL1_INT_ST This is the masked interrupt bit for UHCI_APP_CTRL1_INT interrupt when UHCI_APP_CTRL1_INT_ENA is set to 1. (RO)

Register 26.61. UHCI_INT_ENA_REG (0x000C)

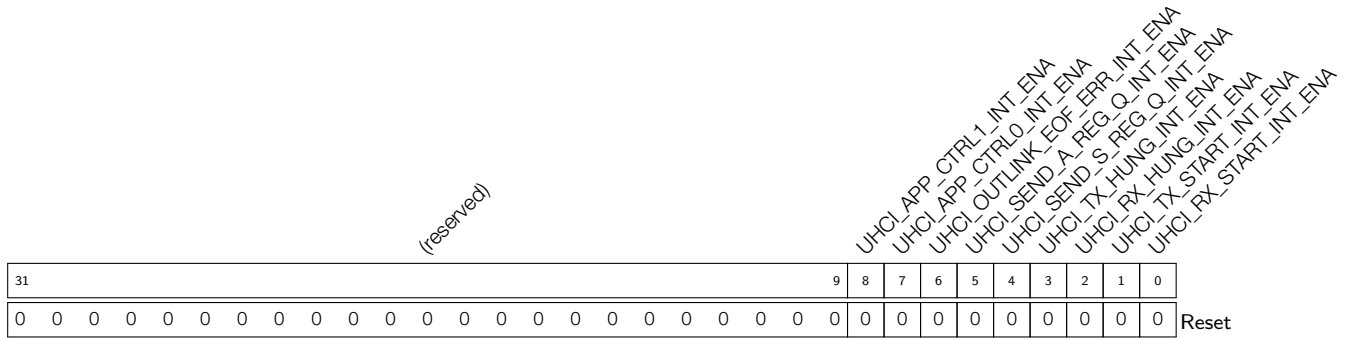

UHCI_RX_START_INT_ENA This is the interrupt enable bit for UHCI_RX_START_INT interrupt. (R/W)

UHCI_TX_START_INT_ENA This is the interrupt enable bit for UHCI_TX_START_INT interrupt. (R/W)

UHCI_RX_HUNG_INT_ENA This is the interrupt enable bit for UHCI_RX_HUNG_INT interrupt. (R/W)

UHCI_TX_HUNG_INT_ENA This is the interrupt enable bit for UHCI_TX_HUNG_INT interrupt. (R/W)

UHCI_SEND_S_REG_Q_INT_ENA This is the interrupt enable bit for UHCI_SEND_S_REG_Q_INT interrupt. (R/W)

UHCI_SEND_A_REG_Q_INT_ENA This is the interrupt enable bit for UHCI_SEND_A_REG_Q_INT interrupt. (R/W)

UHCI_OUTLINK_EOF_ERR_INT_ENA This is the interrupt enable bit for UHCI_OUTLINK_EOF_ERR_INT interrupt. (R/W)

UHCI_APP_CTRL0_INT_ENA This is the interrupt enable bit for UHCI_APP_CTRL0_INT interrupt. (R/W)

UHCI_APP_CTRL1_INT_ENA This is the interrupt enable bit for UHCI_APP_CTRL1_INT interrupt. (R/W)

Register 26.62. UHCI_INT_CLR_REG (0x0010)

(reserved)										UHCI_APP_CTRL1_INT_CLR UHCI_APP_CTRL0_INT_CLR UHCI_OUTLINK_EOF_ERR_INT_CLR UHCI_SEND_A_REG_Q_INT_CLR UHCI_SEND_S_REG_Q_INT_CLR UHCI_TX_HUNG_INT_CLR UHCI_RX_HUNG_INT_CLR UHCI_TX_START_INT_CLR UHCI_RX_START_INT_CLR									
31									9	8	7	6	5	4	3	2	1	0	
0	0	0	0	0	0	0	0	0	0	0	0	0	0	0	0	0	0	0	Reset

- UHCI_RX_START_INT_CLR** Set this bit to clear UHCI_RX_START_INT interrupt. (WT)
- UHCI_TX_START_INT_CLR** Set this bit to clear UHCI_TX_START_INT interrupt. (WT)
- UHCI_RX_HUNG_INT_CLR** Set this bit to clear UHCI_RX_HUNG_INT interrupt. (WT)
- UHCI_TX_HUNG_INT_CLR** Set this bit to clear UHCI_TX_HUNG_INT interrupt. (WT)
- UHCI_SEND_S_REG_Q_INT_CLR** Set this bit to clear UHCI_SEND_S_REG_Q_INT interrupt. (WT)
- UHCI_SEND_A_REG_Q_INT_CLR** Set this bit to clear UHCI_SEND_A_REG_Q_INT interrupt. (WT)
- UHCI_OUTLINK_EOF_ERR_INT_CLR** Set this bit to clear UHCI_OUTLINK_EOF_ERR_INT interrupt. (WT)
- UHCI_APP_CTRL0_INT_CLR** Set this bit to clear UHCI_APP_CTRL0_INT interrupt. (WT)
- UHCI_APP_CTRL1_INT_CLR** Set this bit to clear UHCI_APP_CTRL1_INT interrupt. (WT)

Register 26.63. UHCI_APP_INT_SET_REG (0x0014)

(reserved)										UHCI_APP_CTRL1_INT_SET UHCI_APP_CTRL0_INT_SET										
31																2	1	0		
0	0	0	0	0	0	0	0	0	0	0	0	0	0	0	0	0	0	0	0	Reset

- UHCI_APP_CTRL0_INT_SET** This bit is software interrupt trigger source of UHCI_APP_CTRL0_INT. (WT)
- UHCI_APP_CTRL1_INT_SET** This bit is software interrupt trigger source of UHCI_APP_CTRL1_INT. (WT)

Register 26.64. UHCI_STATE0_REG (0x001C)

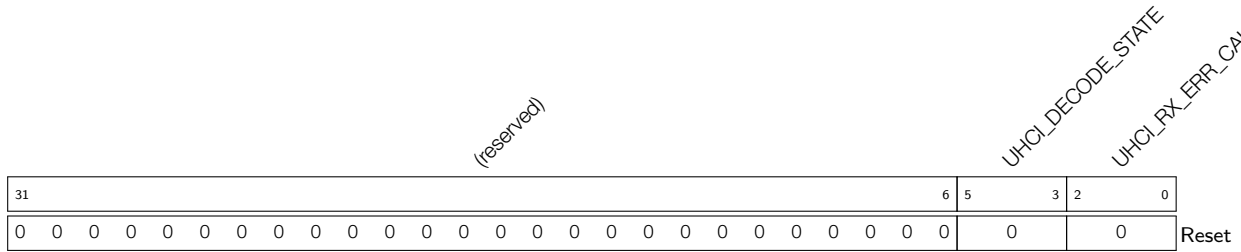

UHCI_RX_ERR_CAUSE This field indicates the error type when DMA has received a packet with error. 3'b001: Checksum error in the HCI packet. 3'b010: Sequence number error in the HCI packet. 3'b011: CRC bit error in the HCI packet. 3'b100: 0xC0 is found but the received HCI packet is not end. 3'b101: 0xC0 is not found when the HCI packet has been received. 3'b110: CRC check error. (RO)

UHCI_DECODE_STATE UHCI decoder status. (RO)

Register 26.65. UHCI_STATE1_REG (0x0020)

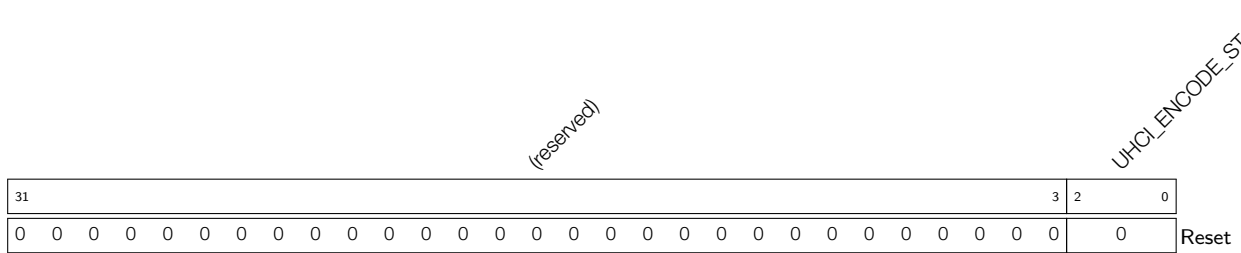

UHCI_ENCODE_STATE UHCI encoder status. (RO)

Register 26.66. UHCI_RX_HEAD_REG (0x0030)

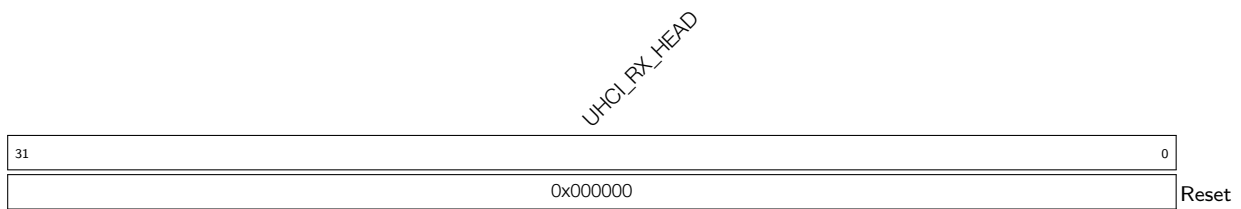

UHCI_RX_HEAD This register stores the header of the current received packet. (RO)

Register 26.67. UHCI_DATE_REG (0x0084)

UHCI_DATE

31	0
0x2010090	
Reset	

UHCI_DATE This is the version control register. (R/W)

27 I2C Controller (I2C)

The I2C (Inter-Integrated Circuit) bus allows ESP32-S3 to communicate with multiple external devices. These external devices can share one bus.

27.1 Overview

The I2C bus has two lines, namely a serial data line (SDA) and a serial clock line (SCL). Both SDA and SCL lines are open-drain. The I2C bus can be connected to a single or multiple master devices and a single or multiple slave devices. However, only one master device can access a slave at a time via the bus.

The master initiates communication by generating a START condition: pulling the SDA line low while SCL is high, and sending nine clock pulses via SCL. The first eight pulses are used to transmit a 7-bit address followed by a read/write (R/\overline{W}) bit. If the address of an I2C slave matches the 7-bit address transmitted, this matching slave can respond by pulling SDA low on the ninth clock pulse. The master and the slave can send or receive data according to the R/\overline{W} bit. Whether to terminate the data transfer or not is determined by the logic level of the acknowledge (ACK) bit. During data transfer, SDA changes only when SCL is low. Once finishing communication, the master sends a STOP condition: pulling SDA up while SCL is high. If a master both reads and writes data in one transfer, then it should send a RSTART condition, a slave address and a R/\overline{W} bit before changing its operation. The RSTART condition is used to change the transfer direction and the mode of the devices (master mode or slave mode).

27.2 Features

The I2C controller has the following features:

- Master mode and slave mode
- Communication between multiple masters and slaves
- Standard mode (100 Kbit/s)
- Fast mode (400 Kbit/s)
- 7-bit addressing and 10-bit addressing
- Continuous data transfer achieved by pulling SCL low
- Programmable digital noise filtering
- Double addressing mode, which uses slave address and slave memory or register address

27.3 I2C Architecture

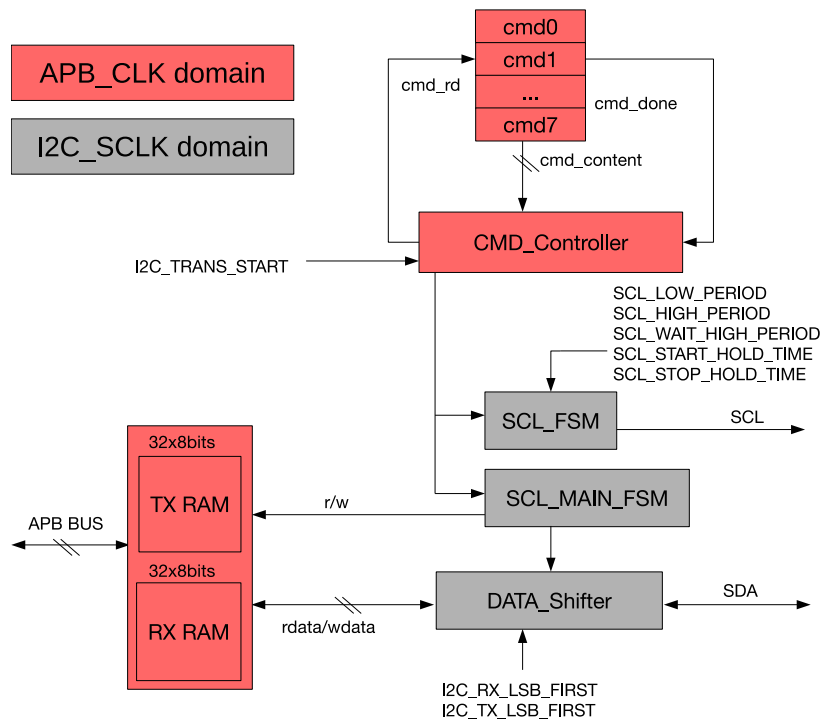

Figure 27-1. I2C Master Architecture

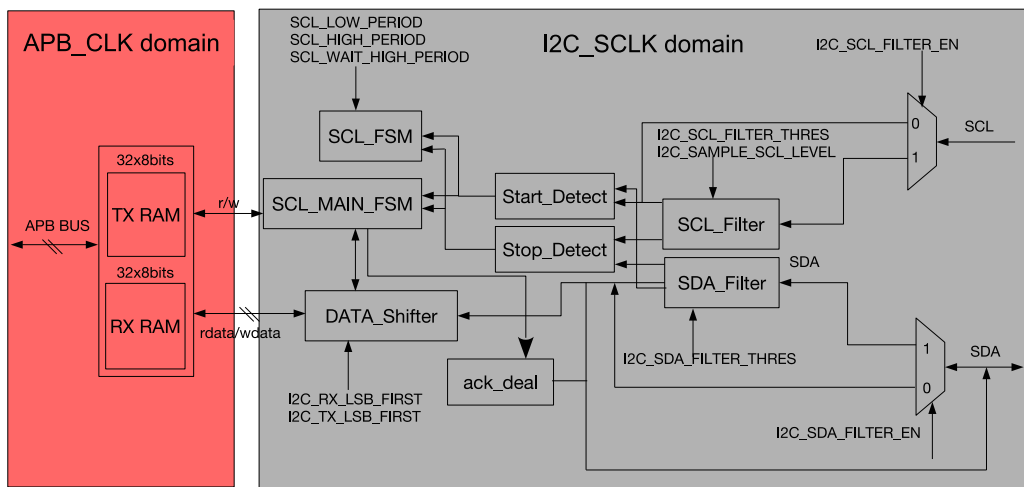

Figure 27-2. I2C Slave Architecture

The I2C controller runs either in master mode or slave mode, which is determined by `I2C_MS_MODE`. Figure 27-1 shows the architecture of a master, while Figure 27-2 shows that of a slave. The I2C controller has the following main parts:

- transmit and receive memory (TX/RX RAM)
- command controller (CMD_Controller)
- SCL clock controller (SCL_FSM)
- SDA data controller (SCL_MAIN_FSM)

- serial/parallel data converter (DATA_Shifter)
- filter for SCL (SCL_Filter)
- filter for SDA (SDA_Filter)

Besides, the I2C controller also has a clock module which generates I2C clocks, and a synchronization module which synchronizes the APB bus and the I2C controller.

The clock module is used to select clock sources, turn on and off clocks, and divide clocks. SCL_Filter and SDA_Filter remove noises on SCL input signals and SDA input signals respectively. The synchronization module synchronizes signal transfer between different clock domains.

Figure 27-3 and Figure 27-4 are the timing diagram and corresponding parameters of the I2C protocol. SCL_FSM generates the timing sequence conforming to the I2C protocol.

SCL_MAIN_FSM controls the execution of I2C commands and the sequence of the SDA line. CMD_Controller is used for an I2C master to generate (R)START, STOP, WRITE, READ and END commands. TX RAM and RX RAM store data to be transmitted and data received respectively. DATA_Shifter shifts data between serial and parallel form.

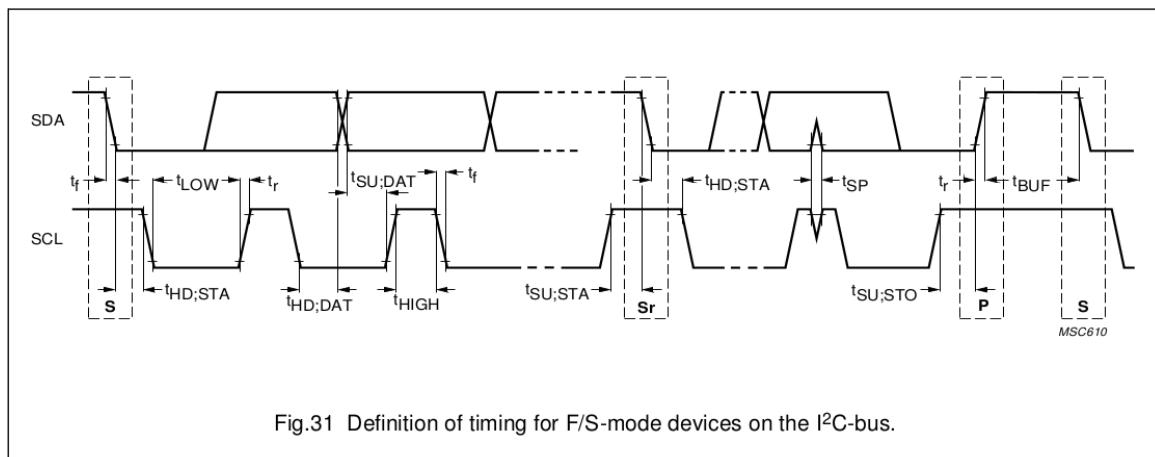

Figure 27-3. I2C Protocol Timing (Cited from Fig.31 in [The I2C-bus specification Version 2.1](#))

PARAMETER	SYMBOL	STANDARD-MODE		FAST-MODE		UNIT
		MIN.	MAX.	MIN.	MAX.	
SCL clock frequency	f _{SCL}	0	100	0	400	kHz
Hold time (repeated) START condition. After this period, the first clock pulse is generated	t _{HD;STA}	4.0	–	0.6	–	μs
LOW period of the SCL clock	t _{LOW}	4.7	–	1.3	–	μs
HIGH period of the SCL clock	t _{HIGH}	4.0	–	0.6	–	μs
Set-up time for a repeated START condition	t _{SU;STA}	4.7	–	0.6	–	μs
Data hold time: for CBUS compatible masters (see NOTE, Section 10.1.3) for I ² C-bus devices	t _{HD;DAT}	5.0 0 ⁽²⁾	– 3.45 ⁽³⁾	– 0 ⁽²⁾	– 0.9 ⁽³⁾	μs μs
Data set-up time	t _{SU;DAT}	250	–	100 ⁽⁴⁾	–	ns
Rise time of both SDA and SCL signals	t _r	–	1000	20 + 0.1C _b ⁽⁵⁾	300	ns
Fall time of both SDA and SCL signals	t _f	–	300	20 + 0.1C _b ⁽⁵⁾	300	ns
Set-up time for STOP condition	t _{SU;STO}	4.0	–	0.6	–	μs
Bus free time between a STOP and START condition	t _{BUF}	4.7	–	1.3	–	μs

Figure 27-4. I2C Timing Parameters (Cited from Table 5 in [The I2C-bus specification Version 2.1](#))

27.4 Functional Description

Note that operations may differ between the I2C controller in ESP32-S3 and other masters or slaves on the bus. Please refer to datasheets of individual I2C devices for specific information.

27.4.1 Clock Configuration

Registers, TX RAM, and RX RAM are configured and accessed in the APB_CLK clock domain, whose frequency is 1 ~ 80 MHz. The main logic of the I2C controller, including SCL_FSM, SCL_MAIN_FSM, SCL_FILTER, SDA_FILTER, and DATA_SHIFTER, are in the I2C_SCLK clock domain.

You can choose the clock source for I2C_SCLK from XTAL_CLK or RC_FAST_CLK via [I2C_SCLK_SEL](#). When [I2C_SCLK_SEL](#) is cleared, the clock source is XTAL_CLK. When [I2C_SCLK_SEL](#) is set, the clock source is RC_FAST_CLK. The clock source is enabled by configuring [I2C_SCLK_ACTIVE](#) as high level, and then passes through a fractional divider to generate I2C_SCLK according to the following equation:

$$Divisor = I2C_SCLK_DIV_NUM + 1 + \frac{I2C_SCLK_DIV_A}{I2C_SCLK_DIV_B}$$

The frequency of XTAL_CLK is 40 MHz, while the frequency of RC_FAST_CLK is 17.5 MHz. Limited by timing parameters, the derived clock I2C_SCLK should operate at a frequency 20 times larger than SCL's frequency.

27.4.2 SCL and SDA Noise Filtering

SCL_Filter and SDA_Filter modules are identical and are used to filter signal noises on SCL and SDA, respectively. These filters can be enabled or disabled by configuring [I2C_SCL_FILTER_EN](#) and [I2C_SDA_FILTER_EN](#).

Take SCL_Filter as an example. When enabled, SCL_Filter samples input signals on the SCL line continuously. These input signals are valid only if they remain unchanged for consecutive [I2C_SCL_FILTER_THRES](#) I2C_SCLK

clock cycles. Given that only valid input signals can pass through the filter, SCL_Filter can remove glitches whose pulse width is shorter than [I2C_SCL_FILTER_THRES](#) I2C_SCLK clock cycles, while SDA_Filter can remove glitches whose pulse width is shorter than [I2C_SDA_FILTER_THRES](#) I2C_SCLK clock cycles.

27.4.3 SCL Clock Stretching

The I2C controller in slave mode (i.e. slave) can hold the SCL line low in exchange for more time to process data. This function called clock stretching is enabled by setting the [I2C_SLAVE_SCL_STRETCH_EN](#) bit. The time period to release the SCL line from stretching is configured by setting the [I2C_STRETCH_PROTECT_NUM](#) field, in order to avoid timing sequence errors. The slave will hold the SCL line low when one of the following four events occurs:

1. Address match: The address of the slave matches the address sent by the master via the SDA line, and the R/\overline{W} bit is 1.
2. RAM being full: RX RAM of the slave is full. Note that when the slave receives less than 32 bytes, it is not necessary to enable clock stretching; when the slave receives 32 bytes or more, you may interrupt data transmission to wrapped around RAM via the FIFO threshold, or enable clock stretching for more time to process data. When clock stretching is enabled, [I2C_RX_FULL_ACK_LEVEL](#) must be cleared, otherwise there will be unpredictable consequences.
3. RAM being empty: The slave is sending data, but its TX RAM is empty.
4. Sending an ACK: If [I2C_SLAVE_BYTE_ACK_CTL_EN](#) is set, the slave pulls SCL low when sending an ACK bit. At this stage, software validates data and configures [I2C_SLAVE_BYTE_ACK_LVL](#) to control the level of the ACK bit. Note that when RX RAM of the slave is full, the level of the ACK bit to be sent is determined by [I2C_RX_FULL_ACK_LEVEL](#), instead of [I2C_SLAVE_BYTE_ACK_LVL](#). In this case, [I2C_RX_FULL_ACK_LEVEL](#) should also be cleared to ensure proper functioning of clock stretching.

After SCL has been stretched low, the cause of stretching can be read from the [I2C_STRETCH_CAUSE](#) bit. Clock stretching is disabled by setting the [I2C_SLAVE_SCL_STRETCH_CLR](#) bit.

27.4.4 Generating SCL Pulses in Idle State

Usually when the I2C bus is idle, the SCL line is held high. The I2C controller in ESP32-S3 can be programmed to generate SCL pulses in idle state. This function only works when the I2C controller is configured as master. If the [I2C_SCL_RST_SLV_EN](#) bit is set, hardware will send [I2C_SCL_RST_SLV_NUM](#) SCL pulses, and then automatically clear this bit. When software reads 0 in [I2C_SCL_RST_SLV_EN](#), set [I2C_CONF_UPGATE](#) to stop this function.

27.4.5 Synchronization

I2C registers are configured in APB_CLK domain, whereas the I2C controller is configured in asynchronous I2C_SCLK domain. Therefore, before being used by the I2C controller, register values should be synchronized by first writing configuration registers and then writing 1 to [I2C_CONF_UPGATE](#). Registers that need synchronization are listed in Table [27-1](#).

Table 27-1. I2C Synchronous Registers

Register	Parameter	Address
I2C_CTR_REG	I2C_SLV_TX_AUTO_START_EN	0x0004
	I2C_ADDR_10BIT_RW_CHECK_EN	
	I2C_ADDR_BROADCASTING_EN	
	I2C_SDA_FORCE_OUT	
	I2C_SCL_FORCE_OUT	
	I2C_SAMPLE_SCL_LEVEL	
	I2C_RX_FULL_ACK_LEVEL	
	I2C_MS_MODE	
	I2C_TX_LSB_FIRST	
	I2C_RX_LSB_FIRST	
	I2C_ARBITRATION_EN	
I2C_TO_REG	I2C_TIME_OUT_EN	0x000C
	I2C_TIME_OUT_VALUE	
I2C_SLAVE_ADDR_REG	I2C_ADDR_10BIT_EN	0x0010
	I2C_SLAVE_ADDR	
I2C_FIFO_CONF_REG	I2C_FIFO_ADDR_CFG_EN	0x0018
I2C_SCL_SP_CONF_REG	I2C_SDA_PD_EN	0x0080
	I2C_SCL_PD_EN	
	I2C_SCL_RST_SLV_NUM	
	I2C_SCL_RST_SLV_EN	
I2C_SCL_STRETCH_CONF_REG	I2C_SLAVE_BYTE_ACK_CTL_EN	0x0084
	I2C_SLAVE_BYTE_ACK_LVL	
	I2C_SLAVE_SCL_STRETCH_EN	
	I2C_STRETCH_PROTECT_NUM	
I2C_SCL_LOW_PERIOD_REG	I2C_SCL_LOW_PERIOD	0x0000
I2C_SCL_HIGH_PERIOD_REG	I2C_WAIT_HIGH_PERIOD	0x0038
	I2C_HIGH_PERIOD	
I2C_SDA_HOLD_REG	I2C_SDA_HOLD_TIME	0x0030
I2C_SDA_SAMPLE_REG	I2C_SDA_SAMPLE_TIME	0x0034
I2C_SCL_START_HOLD_REG	I2C_SCL_START_HOLD_TIME	0x0040
I2C_SCL_RSTART_SETUP_REG	I2C_SCL_RSTART_SETUP_TIME	0x0044
I2C_SCL_STOP_HOLD_REG	I2C_SCL_STOP_HOLD_TIME	0x0048
I2C_SCL_STOP_SETUP_REG	I2C_SCL_STOP_SETUP_TIME	0x004C
I2C_SCL_ST_TIME_OUT_REG	I2C_SCL_ST_TO_I2C	0x0078
I2C_SCL_MAIN_ST_TIME_OUT_REG	I2C_SCL_MAIN_ST_TO_I2C	0x007C
I2C_FILTER_CFG_REG	I2C_SCL_FILTER_EN	0x0050
	I2C_SCL_FILTER_THRES	
	I2C_SDA_FILTER_EN	
	I2C_SDA_FILTER_THRES	

27.4.6 Open-Drain Output

SCL and SDA output drivers must be configured as open drain. There are two ways to achieve this:

1. Set `I2C_SCL_FORCE_OUT` and `I2C_SDA_FORCE_OUT`, and configure `GPIO_PIN n _PAD_DRIVER` for corresponding SCL and SDA pads as open-drain.
2. Clear `I2C_SCL_FORCE_OUT` and `I2C_SDA_FORCE_OUT`.

Because these lines are configured as open-drain, the low-to-high transition time of each line is longer, determined together by the pull-up resistor and line capacitance. The output duty cycle of I2C is limited by the SDA and SCL line's pull-up speed, mainly SCL's speed.

In addition, when `I2C_SCL_FORCE_OUT` and `I2C_SCL_PD_EN` are set to 1, SCL can be forced low; when `I2C_SDA_FORCE_OUT` and `I2C_SDA_PD_EN` are set to 1, SDA can be forced low.

27.4.7 Timing Parameter Configuration

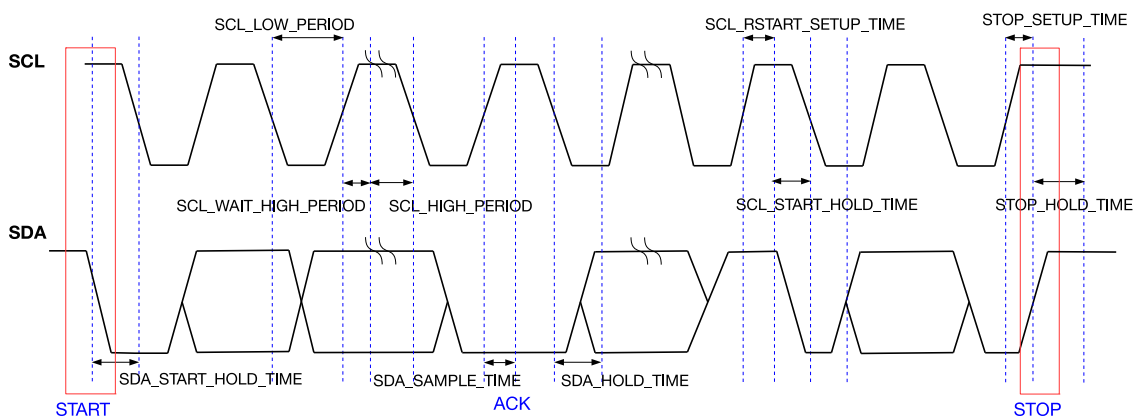

Figure 27-5. I2C Timing Diagram

Figure 27-5 shows the timing diagram of an I2C master. This figure also specifies registers used to configure the START bit, STOP bit, data hold time, data sample time, waiting time on the rising SCL edge, etc. Timing parameters are calculated as follows in `I2C_SCLK` clock cycles:

1. $t_{LOW} = (I2C_SCL_LOW_PERIOD + 1) \cdot T_{I2C_SCLK}$
2. $t_{HIGH} = (I2C_SCL_HIGH_PERIOD + 1) \cdot T_{I2C_SCLK}$
3. $t_{SU:STA} = (I2C_SCL_RSTART_SETUP_TIME + 1) \cdot T_{I2C_SCLK}$
4. $t_{HD:STA} = (I2C_SCL_START_HOLD_TIME + 1) \cdot T_{I2C_SCLK}$
5. $t_r = (I2C_SCL_WAIT_HIGH_PERIOD + 1) \cdot T_{I2C_SCLK}$
6. $t_{SU:STO} = (I2C_SCL_STOP_SETUP_TIME + 1) \cdot T_{I2C_SCLK}$
7. $t_{BUF} = (I2C_SCL_STOP_HOLD_TIME + 1) \cdot T_{I2C_SCLK}$
8. $t_{HD:DAT} = (I2C_SDA_HOLD_TIME + 1) \cdot T_{I2C_SCLK}$
9. $t_{SU:DAT} = (I2C_SCL_LOW_PERIOD - I2C_SDA_HOLD_TIME) \cdot T_{I2C_SCLK}$

Timing registers below are divided into two groups, depending on the mode in which these registers are active:

- Master mode only:

1. **I2C_SCL_START_HOLD_TIME**: Specifies the interval between pulling SDA low and pulling SCL low when the master generates a START condition. This interval is $(I2C_SCL_START_HOLD_TIME + 1)$ in I2C_SCLK cycles. This register is active only when the I2C controller works in master mode.
2. **I2C_SCL_LOW_PERIOD**: Specifies the low period of SCL. This period lasts $(I2C_SCL_LOW_PERIOD + 1)$ in I2C_SCLK cycles. However, it could be extended when SCL is pulled low by peripheral devices or by an END command executed by the I2C controller, or when the clock is stretched. This register is active only when the I2C controller works in master mode.
3. **I2C_SCL_WAIT_HIGH_PERIOD**: Specifies time for SCL to go high in I2C_SCLK cycles. Please make sure that SCL could be pulled high within this time period. Otherwise, the high period of SCL may be incorrect. This register is active only when the I2C controller works in master mode.
4. **I2C_SCL_HIGH_PERIOD**: Specifies the high period of SCL in I2C_SCLK cycles. This register is active only when the I2C controller works in master mode. When SCL goes high within $(I2C_SCL_WAIT_HIGH_PERIOD + 1)$ in I2C_SCLK cycles, its frequency is:

$$f_{scl} = \frac{f_{I2C_SCLK}}{I2C_SCL_LOW_PERIOD + I2C_SCL_HIGH_PERIOD + I2C_SCL_WAIT_HIGH_PERIOD + 3}$$

- Master mode and slave mode:

1. **I2C_SDA_SAMPLE_TIME**: Specifies the interval between the rising edge of SCL and the level sampling time of SDA. It is advised to set a value in the middle of SCL's high period, so as to correctly sample the level of SCL. This register is active both in master mode and slave mode.
2. **I2C_SDA_HOLD_TIME**: Specifies the interval between changing the SDA output level and the falling edge of SCL. This register is active both in master mode and slave mode.

Timing parameters limits corresponding register configuration.

1. $\frac{f_{I2C_SCLK}}{f_{SCL}} > 20$
2. $3 \times f_{I2C_SCLK} \leq (I2C_SDA_HOLD_TIME - 4) \times f_{APB_CLK}$
3. $I2C_SDA_HOLD_TIME + I2C_SCL_START_HOLD_TIME > SDA_FILTER_THRES + 3$
4. $I2C_SCL_WAIT_HIGH_PERIOD < I2C_SDA_SAMPLE_TIME < I2C_SCL_HIGH_PERIOD$
5. $I2C_SDA_SAMPLE_TIME < I2C_SCL_WAIT_HIGH_PERIOD + I2C_SCL_START_HOLD_TIME + I2C_SCL_RSTART_SETUP_TIME$
6. $I2C_STRETCH_PROTECT_NUM + I2C_SDA_HOLD_TIME > I2C_SCL_LOW_PERIOD$

27.4.8 Timeout Control

The I2C controller has three types of timeout control, namely timeout control for SCL_FSM, for SCL_MAIN_FSM, and for the SCL line. The first two are always enabled, while the third is configurable.

When SCL_FSM remains unchanged for more than $2^{I2C_SCL_ST_TO_I2C}$ clock cycles, an I2C_SCL_ST_TO_INT interrupt is triggered, and then SCL_FSM goes to idle state. The value of **I2C_SCL_ST_TO_I2C** should be less than or equal to 22, which means SCL_FSM could remain unchanged for 2^{22} I2C_SCLK clock cycles at most before the interrupt is generated.

When SCL_MAIN_FSM remains unchanged for more than $2^{I2C_SCL_MAIN_ST_TO_I2C}$ I2C_SCLK clock cycles, an

I2C_SCL_MAIN_ST_TO_INT interrupt is triggered, and then SCL_MAIN_FSM goes to idle state. The value of I2C_SCL_MAIN_ST_TO_I2C should be less than or equal to 22, which means SCL_MAIN_FSM could remain unchanged for 2^{22} clock cycles at most before the interrupt is generated.

Timeout control for SCL is enabled by setting I2C_TIME_OUT_EN. When the level of SCL remains unchanged for more than I2C_TIME_OUT_VALUE clock cycles, an I2C_TIME_OUT_INT interrupt is triggered, and then the I2C bus goes to idle state.

27.4.9 Command Configuration

When the I2C controller works in master mode, CMD_Controller reads commands from 8 sequential command registers and controls SCL_FSM and SCL_MAIN_FSM accordingly.

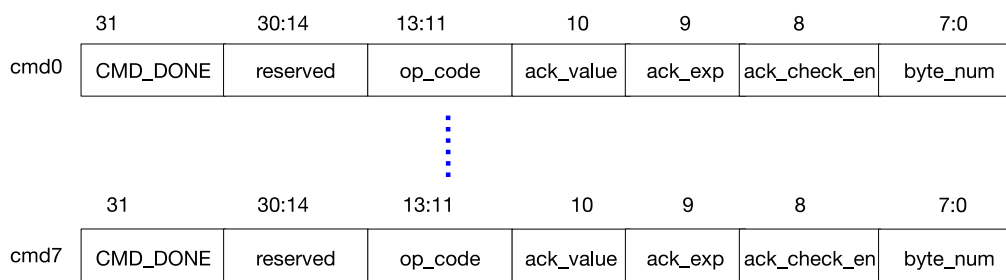

Figure 27-6. Structure of I2C Command Registers

Command registers, whose structure is illustrated in Figure 27-6, are active only when the I2C controller works in master mode. Fields of command registers are:

1. CMD_DONE: Indicates that a command has been executed. After each command has been executed, the CMD_DONE bit in the corresponding command register is set to 1 by hardware. By reading this bit, software can tell if the command has been executed. When writing new commands, this bit must be cleared by software.
2. op_code: Indicates the command. The I2C controller supports five commands:
 - RSTART: op_code = 6. The I2C controller sends a START bit or a RSTART bit defined by the I2C protocol.
 - WRITE: op_code = 1. The I2C controller sends a slave address, a register address (only in double addressing mode) and data to the slave.
 - READ: op_code = 3. The I2C controller reads data from the slave.
 - STOP: op_code = 2. The I2C controller sends a STOP bit defined by the I2C protocol. This code also indicates that the command sequence has been executed, and the CMD_Controller stops reading commands. After restarted by software, the CMD_Controller resumes reading commands from command register 0.
 - END: op_code = 4. The I2C controller pulls the SCL line down and suspends I2C communication. This code also indicates that the command sequence has completed, and the CMD_Controller stops executing commands. Once software refreshes data in command registers and the RAM, the CMD_Controller can be restarted to execute commands from command register 0 again.
3. ack_value: Used to configure the level of the ACK bit sent by the I2C controller during a read operation. This bit is ignored in RSTART, STOP, END and WRITE conditions.

4. `ack_exp`: Used to configure the level of the ACK bit expected by the I2C controller during a write operation. This bit is ignored during RSTART, STOP, END and READ conditions.
5. `ack_check_en`: Used to enable the I2C controller during a write operation to check whether the ACK level sent by the slave matches `ack_exp` in the command. If this bit is set and the level received does not match `ack_exp` in the WRITE command, the master will generate an `I2C_NACK_INT` interrupt and a STOP condition for data transfer. If this bit is cleared, the controller will not check the ACK level sent by the slave. This bit is ignored during RSTART, STOP, END and READ conditions.
6. `byte_num`: Specifies the length of data (in bytes) to be read or written. Can range from 1 to 255 bytes. This bit is ignored during RSTART, STOP and END conditions.

Each command sequence is executed starting from command register 0 and terminated by a STOP or an END. Therefore, there must be a STOP or an END command in the eight command registers.

A complete data transfer on the I2C bus should be initiated by a START and terminated by a STOP. The transfer process may be completed using multiple sequences, separated by END commands. Each sequence may differ in the direction of data transfer, clock frequency, slave addresses, data length, etc. This allows efficient use of available peripheral RAM and also achieves more flexible I2C communication.

27.4.10 TX/RX RAM Data Storage

Both TX RAM and RX RAM are 32×8 bits, and can be accessed in FIFO or non-FIFO mode. If `I2C_NONFIFO_EN` bit is cleared, both RAMs are accessed in FIFO mode; if `I2C_NONFIFO_EN` bit is set, both RAMs are accessed in non-FIFO mode.

TX RAM stores data that the I2C controller needs to send. During communication, when the I2C controller needs to send data (except acknowledgement bits), it reads data from TX RAM and sends them sequentially via SDA. When the I2C controller works in master mode, all data must be stored in TX RAM in the order they will be sent to slaves. The data stored in TX RAM include slave addresses, read/write bits, register addresses (only in double addressing mode) and data to be sent. When the I2C controller works in slave mode, TX RAM only stores data to be sent.

TX RAM can be read and written by the CPU. The CPU writes to TX RAM either in FIFO mode or in non-FIFO mode (direct address). In FIFO mode, the CPU writes to TX RAM via the fixed address `I2C_DATA_REG`, with addresses for writing in TX RAM incremented automatically by hardware. In non-FIFO mode, the CPU accesses TX RAM directly via address fields (`I2C Base Address + 0x100`) ~ (`I2C Base Address + 0x17C`). Each byte in TX RAM occupies an entire word in the address space. Therefore, the address of the first byte is `I2C Base Address + 0x100`, the second byte is `I2C Base Address + 0x104`, the third byte is `I2C Base Address + 0x108`, and so on. The CPU can only read TX RAM via direct addresses. Addresses for reading TX RAM are the same with addresses for writing TX RAM.

RX RAM stores data the I2C controller receives during communication. When the I2C controller works in slave mode, neither slave addresses sent by the master nor register addresses (only in double addressing mode) will be stored into RX RAM. Values of RX RAM can be read by software after I2C communication completes.

RX RAM can only be read by the CPU. The CPU reads RX RAM either in FIFO mode or in non-FIFO mode (direct address). In FIFO mode, the CPU reads RX RAM via the fixed address `I2C_DATA_REG`, with addresses for reading RX RAM incremented automatically by hardware. In non-FIFO mode, the CPU accesses TX RAM directly via address fields (`I2C Base Address + 0x180`) ~ (`I2C Base Address + 0x1FC`). Each byte in RX RAM occupies an entire word in the address space. Therefore, the address of the first byte is `I2C Base Address + 0x180`, the

second byte is [I2C Base Address](#) + 0x184, the third byte is [I2C Base Address](#) + 0x188 and so on.

In FIFO mode, TX RAM of a master may wrap around to send data larger than 32 bytes. Set [I2C_FIFO_PRT_EN](#). If the size of data to be sent is smaller than [I2C_TXFIFO_WM_THRHD](#) (master), an [I2C_TXFIFO_WM_INT](#) (master) interrupt is generated. After receiving the interrupt, software continues writing to [I2C_DATA_REG](#) (master).

Please ensure that software writes to or refreshes TX RAM before the master sends data, otherwise it may result in unpredictable consequences.

In FIFO mode, RX RAM of a slave may also wrap around to receive data larger than 32 bytes. Set [I2C_FIFO_PRT_EN](#) and clear [I2C_RX_FULL_ACK_LEVEL](#). If data already received (to be overwritten) is larger than [I2C_RXFIFO_WM_THRHD](#) (slave), an [I2C_RXFIFO_WM_INT](#) (slave) interrupt is generated. After receiving the interrupt, software continues reading from [I2C_DATA_REG](#) (slave).

27.4.11 Data Conversion

DATA_Shifter is used for serial/parallel conversion, converting byte data in TX RAM to an outgoing serial bitstream or an incoming serial bitstream to byte data in RX RAM. [I2C_RX_LSB_FIRST](#) and [I2C_TX_LSB_FIRST](#) can be used to select LSB- or MSB-first storage and transmission of data.

27.4.12 Addressing Mode

Besides 7-bit addressing, the ESP32-S3 I2C controller also supports 10-bit addressing and double addressing. 10-bit addressing can be mixed with 7-bit addressing.

Define the slave address as `SLV_ADDR`. In 7-bit addressing mode, the slave address is `SLV_ADDR[6:0]`; in 10-bit addressing mode, the slave address is `SLV_ADDR[9:0]`.

In 7-bit addressing mode, the master only needs to send one byte of address, which comprises `SLV_ADDR[6:0]` and a R/\overline{W} bit. In 7-bit addressing mode, there is a special case called general call addressing (broadcast). It is enabled by setting [I2C_ADDR_BROADCASTING_EN](#) in a slave. When the slave receives the general call address (0x00) from the master and the R/\overline{W} bit followed is 0, it responds to the master regardless of its own address.

In 10-bit addressing mode, the master needs to send two bytes of address. The first byte is `slave_addr_first_7bits` followed by a R/\overline{W} bit, and `slave_addr_first_7bits` should be configured as (0x78 | `SLV_ADDR[9:8]`). The second byte is `slave_addr_second_byte`, which should be configured as `SLV_ADDR[7:0]`. The slave can enable 10-bit addressing by configuring [I2C_ADDR_10BIT_EN](#). [I2C_SLAVE_ADDR](#) is used to configure I2C slave address. Specifically, [I2C_SLAVE_ADDR\[14:7\]](#) should be configured as `SLV_ADDR[7:0]`, and [I2C_SLAVE_ADDR\[6:0\]](#) should be configured as (0x78 | `SLV_ADDR[9:8]`). Since a 10-bit slave address has one more byte than a 7-bit address, `byte_num` of the WRITE command and the number of bytes in the RAM increase by one.

When working in slave mode, the I2C controller supports double addressing, where the first address is the address of an I2C slave, and the second one is the slave's memory address. When using double addressing, RAM must be accessed in non-FIFO mode. Double addressing is enabled by setting [I2C_FIFO_ADDR_CFG_EN](#).

27.4.13 R/\overline{W} Bit Check in 10-bit Addressing Mode

In 10-bit addressing mode, when [I2C_ADDR_10BIT_RW_CHECK_EN](#) is set to 1, the I2C controller performs a check on the first byte, which consists of `slave_addr_first_7bits` and a R/\overline{W} bit. When the R/\overline{W} bit does not

indicate a WRITE operation, i.e. not in line with the I2C protocol, the data transfer ends. If the check feature is not enabled, when the R/\overline{W} bit does not indicate a WRITE, the data transfer still continues, but transfer failure may occur.

27.4.14 To Start the I2C Controller

To start the I2C controller in master mode, after configuring the controller to master mode and command registers, write 1 to `I2C_TRANS_START` in order that the master starts to parse and execute command sequences. The master always executes a command sequence starting from command register 0 to a STOP or an END at the end. To execute another command sequence starting from command register 0, refresh commands by writing 1 again to `I2C_TRANS_START`.

To start the I2C controller in slave mode, there are two ways:

- Set `I2C_SLV_TX_AUTO_START_EN`, and the slave starts automatic transfer upon an address match;
- Clear `I2C_SLV_TX_AUTO_START_EN`, and always set `I2C_TRANS_START` before transfer.

27.5 Programming Example

This sections provides programming examples for typical communication scenarios. ESP32-S3 has one I2C controller. For the convenience of description, I2C masters and slaves in all subsequent figures are ESP32-S3 I2C controllers. I2C master is referred to as $I2C_{\text{master}}$, and I2C slave is referred to as $I2C_{\text{slave}}$.

27.5.1 $I2C_{\text{master}}$ Writes to $I2C_{\text{slave}}$ with a 7-bit Address in One Command Sequence

27.5.1.1 Introduction

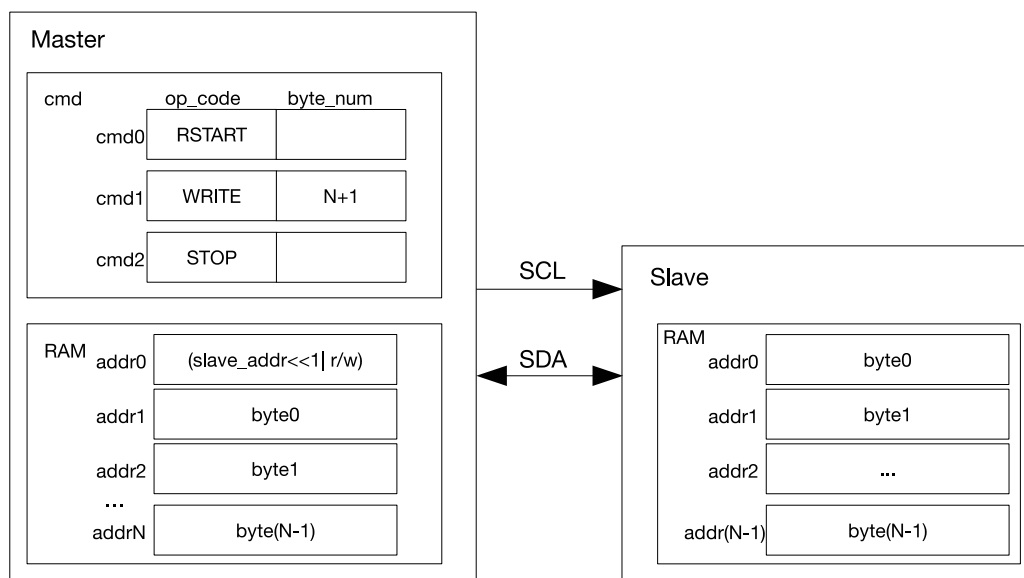

Figure 27-7. $I2C_{\text{master}}$ Writing to $I2C_{\text{slave}}$ with a 7-bit Address

Figure 27-7 shows how $I2C_{\text{master}}$ writes N bytes of data to $I2C_{\text{slave}}$ registers or RAM using 7-bit addressing. As shown in figure 27-7, the first byte in the RAM of $I2C_{\text{master}}$ is a 7-bit $I2C_{\text{slave}}$ address followed by a R/\overline{W} bit. When the R/\overline{W} bit is 0, it indicates a WRITE operation. The remaining bytes are used to store data ready for transfer. The cmd box contains related command sequences.

After the command sequence is configured and data in RAM is ready, I2C_{master} enables the controller and initiates data transfer by setting the I2C_TRANS_START bit. The controller has four steps to take:

1. Wait for SCL to go high, to avoid SCL being used by other masters or slaves.
2. Execute a RSTART command and send a START bit.
3. Execute a WRITE command by taking N+1 bytes from the RAM in order and send them to I2C_{slave} in the same order. The first byte is the address of I2C_{slave}.
4. Send a STOP. Once the I2C_{master} transfers a STOP bit, an I2C_TRANS_COMPLETE_INT interrupt is generated.

27.5.1.2 Configuration Example

1. Configure the timing parameter registers of I2C_{master} and I2C_{slave} according to Section 27.4.7.
2. Set I2C_MS_MODE (master) to 1, and I2C_MS_MODE (slave) to 0.
3. Write 1 to I2C_CONF_UPGATE (master) and I2C_CONF_UPGATE (slave) to synchronize registers.
4. Configure command registers of I2C_{master}.

Command register	op_code	ack_value	ack_exp	ack_check_en	byte_num
I2C_COMMAND0 (master)	RSTART	—	—	—	—
I2C_COMMAND1 (master)	WRITE	ack_value	ack_exp	1	N+1
I2C_COMMAND2 (master)	STOP	—	—	—	—

5. Write the address of I2C_{slave} and data to be sent to TX RAM of I2C_{master} in either FIFO mode or non-FIFO mode according to Section 27.4.10.
6. Write the address of I2C_{slave} to I2C_SLAVE_ADDR (slave) in I2C_SLAVE_ADDR_REG (slave) register.
7. Write 1 to I2C_CONF_UPGATE (master) and I2C_CONF_UPGATE (slave) to synchronize registers.
8. Write 1 to I2C_TRANS_START (master) and I2C_TRANS_START (slave) to start transfer.
9. I2C_{slave} compares the slave address sent by I2C_{master} with its own address in I2C_SLAVE_ADDR (slave). When ack_check_en (master) in I2C_{master}'s WRITE command is 1, I2C_{master} checks ACK value each time it sends a byte. When ack_check_en (master) is 0, I2C_{master} does not check ACK value and take I2C_{slave} as a matching slave by default.
 - Match: If the received ACK value matches ack_exp (master) (the expected ACK value), I2C_{master} continues data transfer.
 - Not match: If the received ACK value does not match ack_exp, I2C_{master} generates an I2C_NACK_INT (master) interrupt and stops data transfer.
10. I2C_{master} sends data, and checks ACK value or not according to ack_check_en (master).
11. If data to be sent (N) is larger than 32 bytes, TX RAM of I2C_{master} may wrap around in FIFO mode. For details, please refer to Section 27.4.10.
12. If data to be received (N) is larger than 32 bytes, RX RAM of I2C_{slave} may wrap around in FIFO mode. For details, please refer to Section 27.4.10.

If data to be received (N) is larger than 32 bytes, the other way is to enable clock stretching by setting the `I2C_SLAVE_SCL_STRETCH_EN` (slave), and clearing `I2C_RX_FULL_ACK_LEVEL`. When RX RAM is full, an `I2C_SLAVE_STRETCH_INT` (slave) interrupt is generated. In this way, $I2C_{slave}$ can hold SCL low, in exchange for more time to read data. After software has finished reading, you can set `I2C_SLAVE_STRETCH_INT_CLR` (slave) to 1 to clear interrupt, and set `I2C_SLAVE_SCL_STRETCH_CLR` (slave) to release the SCL line.

- After data transfer completes, $I2C_{master}$ executes the STOP command, and generates an `I2C_TRANS_COMPLETE_INT` (master) interrupt.

27.5.2 $I2C_{master}$ Writes to $I2C_{slave}$ with a 10-bit Address in One Command Sequence

27.5.2.1 Introduction

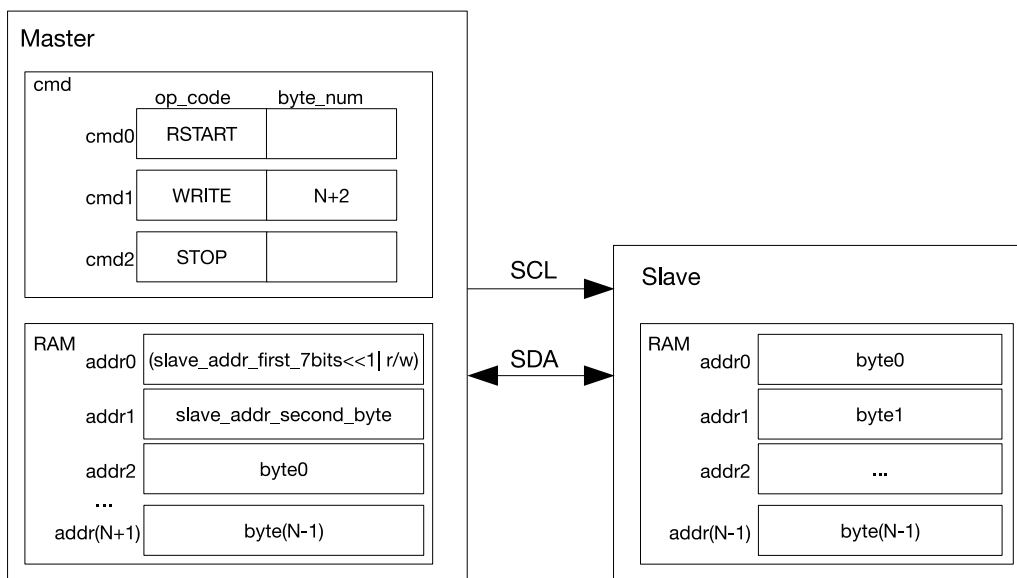

Figure 27-8. $I2C_{master}$ Writing to a Slave with a 10-bit Address

Figure 27-8 shows how $I2C_{master}$ writes N bytes of data using 10-bit addressing to an I2C slave. The configuration and transfer process is similar to what is described in 27.5.1, except that a 10-bit $I2C_{slave}$ address is formed from two bytes. Since a 10-bit $I2C_{slave}$ address has one more byte than a 7-bit $I2C_{slave}$ address, `byte_num` and length of data in TX RAM increase by 1 accordingly.

27.5.2.2 Configuration Example

- Set `I2C_MS_MODE` (master) to 1, and `I2C_MS_MODE` (slave) to 0.
- Write 1 to `I2C_CONF_UPGATE` (master) and `I2C_CONF_UPGATE` (slave) to synchronize registers.
- Configure command registers of $I2C_{master}$.

Command registers	op_code	ack_value	ack_exp	ack_check_en	byte_num
<code>I2C_COMMAND0</code> (master)	RSTART	—	—	—	—
<code>I2C_COMMAND1</code> (master)	WRITE	ack_value	ack_exp	1	N+2
<code>I2C_COMMAND2</code> (master)	STOP	—	—	—	—

4. Configure `I2C_SLAVE_ADDR` (slave) in `I2C_SLAVE_ADDR_REG` (slave) as `I2C_slave`'s 10-bit address, and set `I2C_ADDR_10BIT_EN` (slave) to 1 to enable 10-bit addressing.
5. Write the address of `I2C_slave` and data to be sent to TX RAM of `I2C_master`. The first byte of the address of `I2C_slave` comprises $((0x78 | I2C_SLAVE_ADDR[9:8]) \ll 1)$ and a R/\overline{W} bit. The second byte of the address of `I2C_slave` is `I2C_SLAVE_ADDR[7:0]`. These two bytes are followed by data to be sent in FIFO or non-FIFO mode.
6. Write 1 to `I2C_CONF_UPGATE` (master) and `I2C_CONF_UPGATE` (slave) to synchronize registers.
7. Write 1 to `I2C_TRANS_START` (master) and `I2C_TRANS_START` (slave) to start transfer.
8. `I2C_slave` compares the slave address sent by `I2C_master` with its own address in `I2C_SLAVE_ADDR` (slave). When `ack_check_en` (master) in `I2C_master`'s WRITE command is 1, `I2C_master` checks ACK value each time it sends a byte. When `ack_check_en` (master) is 0, `I2C_master` does not check ACK value and take `I2C_slave` as matching slave by default.
 - Match: If the received ACK value matches `ack_exp` (master) (the expected ACK value), `I2C_master` continues data transfer.
 - Not match: If the received ACK value does not match `ack_exp`, `I2C_master` generates an `I2C_NACK_INT` (master) interrupt and stops data transfer.
9. `I2C_master` sends data, and checks ACK value or not according to `ack_check_en` (master).
10. If data to be sent is larger than 32 bytes, TX RAM of `I2C_master` may wrap around in FIFO mode. For details, please refer to Section 27.4.10.
11. If data to be received is larger than 32 bytes, RX RAM of `I2C_slave` may wrap around in FIFO mode. For details, please refer to Section 27.4.10.

If data to be received is larger than 32 bytes, the other way is to enable clock stretching by setting `I2C_SLAVE_SCL_STRETCH_EN` (slave), and clearing `I2C_RX_FULL_ACK_LEVEL` to 0. When RX RAM is full, an `I2C_SLAVE_STRETCH_INT` (slave) interrupt is generated. In this way, `I2C_slave` can hold SCL low, in exchange for more time to read data. After software has finished reading, you can set `I2C_SLAVE_STRETCH_INT_CLR` (slave) to 1 to clear interrupt, and set `I2C_SLAVE_SCL_STRETCH_CLR` (slave) to release the SCL line.
12. After data transfer completes, `I2C_master` executes the STOP command, and generates an `I2C_TRANS_COMPLETE_INT` (master) interrupt.

27.5.3 `I2C_master` Writes to `I2C_slave` with Two 7-bit Addresses in One Command Sequence

27.5.3.1 Introduction

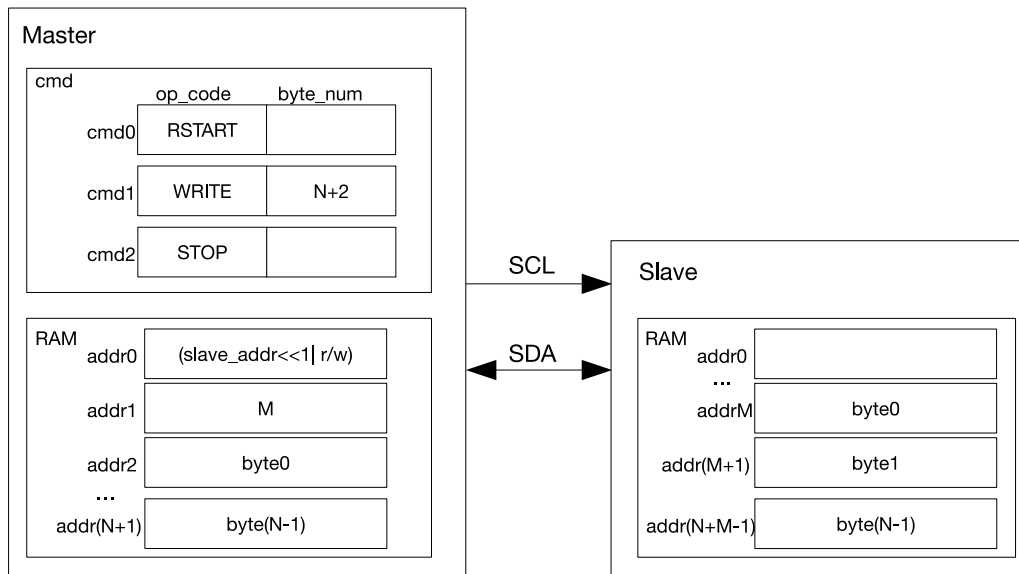

Figure 27-9. I2C_{master} Writing to I2C_{slave} with Two 7-bit Addresses

Figure 27-9 shows how I2C_{master} writes N bytes of data to I2C_{slave} registers or RAM using 7-bit double addressing. The configuration and transfer process is similar to what is described in Section 27.5.1, except that in 7-bit double addressing mode I2C_{master} sends two 7-bit addresses. The first address is the address of an I2C slave, and the second one is I2C_{slave}'s memory address (i.e. addrM in Figure 27-9). When using double addressing, RAM must be accessed in non-FIFO mode. The I2C slave put received byte0 ~ byte(N-1) into its RAM in an order starting from addrM. The RAM is overwritten every 32 bytes.

27.5.3.2 Configuration Example

1. Set I2C_MS_MODE (master) to 1, and I2C_MS_MODE (slave) to 0.
2. Set I2C_FIFO_ADDR_CFG_EN (slave) to 1 to enable double addressing mode.
3. Write 1 to I2C_CONF_UPGATE (master) and I2C_CONF_UPGATE (slave) to synchronize registers.
4. Configure command registers of I2C_{master}.

Command registers	op_code	ack_value	ack_exp	ack_check_en	byte_num
I2C_COMMAND0 (master)	RSTART	—	—	—	—
I2C_COMMAND1 (master)	WRITE	ack_value	ack_exp	1	N+2
I2C_COMMAND2 (master)	STOP	—	—	—	—

5. Write the address of I2C_{slave} and data to be sent to TX RAM of I2C_{master} in FIFO or non-FIFO mode.
6. Write the address of I2C_{slave} to I2C_SLAVE_ADDR (slave) in I2C_SLAVE_ADDR_REG (slave) register.
7. Write 1 to I2C_CONF_UPGATE (master) and I2C_CONF_UPGATE (slave) to synchronize registers.
8. Write 1 to I2C_TRANS_START (master) and I2C_TRANS_START (slave) to start transfer.
9. I2C_{slave} compares the slave address sent by I2C_{master} with its own address in I2C_SLAVE_ADDR (slave).

When `ack_check_en` (master) in `I2Cmaster`'s WRITE command is 1, `I2Cmaster` checks ACK value each time it sends a byte. When `ack_check_en` (master) is 0, `I2Cmaster` does not check ACK value and take `I2Cslave` as matching slave by default.

- Match: If the received ACK value matches `ack_exp` (master) (the expected ACK value), `I2Cmaster` continues data transfer.
- Not match: If the received ACK value does not match `ack_exp`, `I2Cmaster` generates an `I2C_NACK_INT` (master) interrupt and stops data transfer.

10. `I2Cslave` receives the RX RAM address sent by `I2Cmaster` and adds the offset.
11. `I2Cmaster` sends data, and checks ACK value or not according to `ack_check_en` (master).
12. If data to be sent is larger than 32 bytes, TX RAM of `I2Cmaster` may wrap around in FIFO mode. For details, please refer to Section [27.4.10](#).
13. If data to be received is larger than 32 bytes, you may enable clock stretching by setting `I2C_SLAVE_SCL_STRETCH_EN` (slave), and clearing `I2C_RX_FULL_ACK_LEVEL` to 0. When RX RAM is full, an `I2C_SLAVE_STRETCH_INT` (slave) interrupt is generated. In this way, `I2Cslave` can hold SCL low, in exchange for more time to read data. After software has finished reading, you can set `I2C_SLAVE_STRETCH_INT_CLR` (slave) to 1 to clear interrupt, and set `I2C_SLAVE_SCL_STRETCH_CLR` (slave) to release the SCL line.
14. After data transfer completes, `I2Cmaster` executes the STOP command, and generates an `I2C_TRANS_COMPLETE_INT` (master) interrupt.

27.5.4 `I2Cmaster` Writes to `I2Cslave` with a 7-bit Address in Multiple Command Sequences

27.5.4.1 Introduction

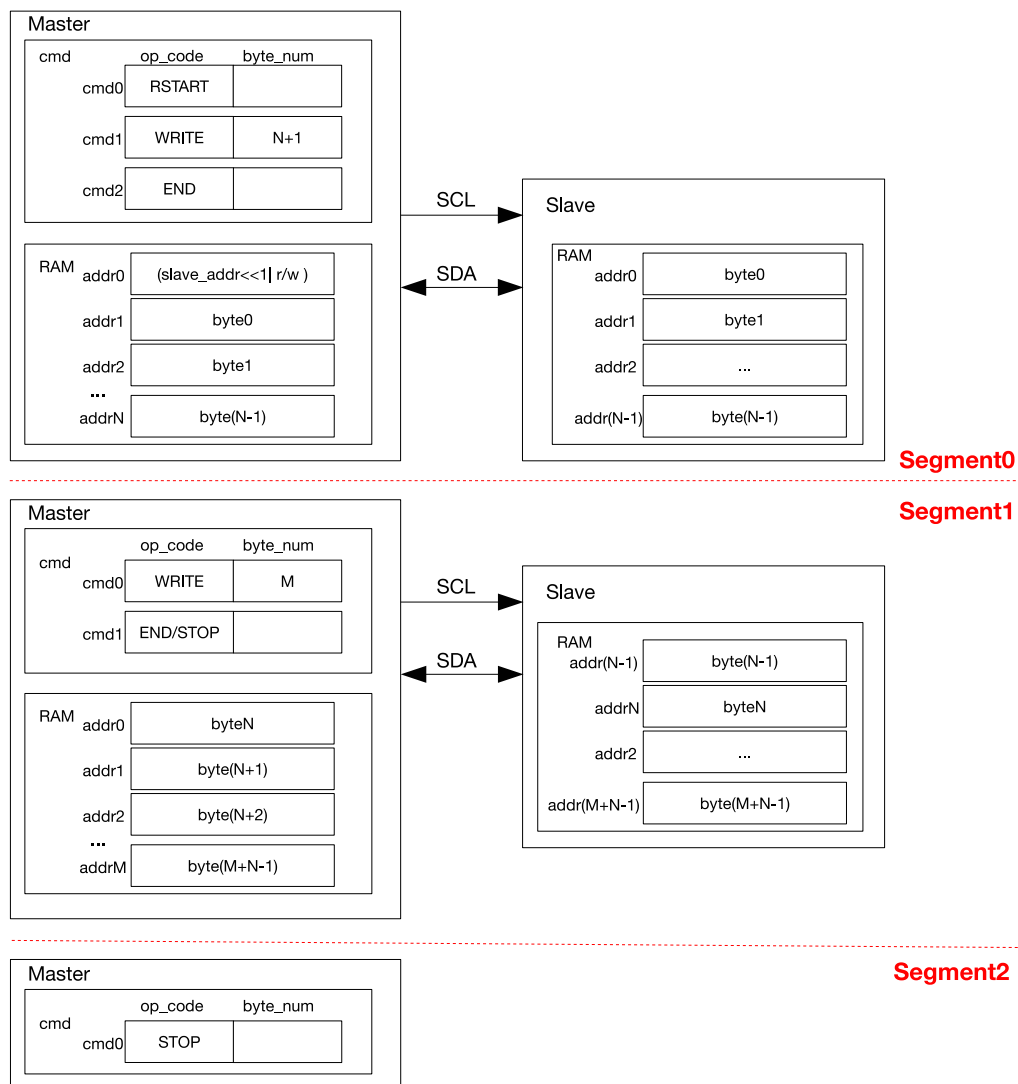

Figure 27-10. I2C_{master} Writing to I2C_{slave} with a 7-bit Address in Multiple Sequences

Given that the I2C Controller RAM holds only 32 bytes, when data are too large to be processed even by the wrapped RAM, it is advised to transmit them in multiple command sequences. At the end of every command sequence is an END command. When the controller executes this END command to pull SCL low, software refreshes command sequence registers and the RAM for next the transfer.

Figure 27-10 shows how I2C_{master} writes to an I2C slave in two or three segments as an example. For the first segment, the CMD_Controller registers are configured as shown in Segment0. Once data in I2C_{master}'s RAM is ready and I2C_TRANS_START is set, I2C_{master} initiates data transfer. After executing the END command, I2C_{master} turns off the SCL clock and pulls SCL low to reserve the bus. Meanwhile, the controller generates an I2C_END_DETECT_INT interrupt.

For the second segment, after detecting the I2C_END_DETECT_INT interrupt, software refreshes the CMD_Controller registers, reloads the RAM and clears this interrupt, as shown in Segment1. If cmd1 in the second segment is a STOP, then data is transmitted to I2C_{slave} in two segments. I2C_{master} resumes data transfer after I2C_TRANS_START is set, and terminates the transfer by sending a STOP bit.

For the third segment, after the second data transfer finishes and an I2C_END_DETECT_INT is detected, the CMD_Controller registers of I2C_{master} are configured as shown in Segment2. Once I2C_TRANS_START is set, I2C_{master} generates a STOP bit and terminates the transfer.

Note that other I2C_{master}s will not transact on the bus between two segments. The bus is only released after a STOP signal is sent. The I2C controller can be reset by setting I2C_FSM_RST field at any time. This field will later be cleared automatically by hardware.

27.5.4.2 Configuration Example

1. Set I2C_MS_MODE (master) to 1, and I2C_MS_MODE (slave) to 0.
2. Write 1 to I2C_CONF_UPGATE (master) and I2C_CONF_UPGATE (slave) to synchronize registers.
3. Configure command registers of I2C_{master}.

Command registers	op_code	ack_value	ack_exp	ack_check_en	byte_num
I2C_COMMAND0 (master)	RSTART	—	—	—	—
I2C_COMMAND1 (master)	WRITE	ack_value	ack_exp	1	N+1
I2C_COMMAND2 (master)	END	—	—	—	—

4. Write the address of I2C_{slave} and data to be sent to TX RAM of I2C_{master} in either FIFO mode or non-FIFO mode according to Section 27.4.10.
5. Write the address of I2C_{slave} to I2C_SLAVE_ADDR (slave) in I2C_SLAVE_ADDR_REG (slave) register
6. Write 1 to I2C_CONF_UPGATE (master) and I2C_CONF_UPGATE (slave) to synchronize registers.
7. Write 1 to I2C_TRANS_START (master) and I2C_TRANS_START (slave) to start transfer.
8. I2C_{slave} compares the slave address sent by I2C_{master} with its own address in I2C_SLAVE_ADDR (slave). When ack_check_en (master) in I2C_{master}'s WRITE command is 1, I2C_{master} checks ACK value each time it sends a byte. When ack_check_en (master) is 0, I2C_{master} does not check ACK value and take I2C_{slave} as matching slave by default.
 - Match: If the received ACK value matches ack_exp (master) (the expected ACK value), I2C_{master} continues data transfer.
 - Not match: If the received ACK value does not match ack_exp, I2C_{master} generates an I2C_NACK_INT (master) interrupt and stops data transfer.
9. I2C_{master} sends data, and checks ACK value or not according to ack_check_en (master).
10. After the I2C_END_DETECT_INT (master) interrupt is generated, set I2C_END_DETECT_INT_CLR (master) to 1 to clear this interrupt.
11. Update I2C_{master}'s command registers.

Command registers	op_code	ack_value	ack_exp	ack_check_en	byte_num
I2C_COMMAND0 (master)	WRITE	ack_value	ack_exp	1	M
I2C_COMMAND1 (master)	END/STOP	—	—	—	—

12. Write M bytes of data to be sent to TX RAM of I2C_{master} in FIFO or non-FIFO mode.

13. Write 1 to `I2C_TRANS_START` (master) bit to start transfer and repeat step 9.
14. If the command is a STOP, I2C stops transfer and generates an `I2C_TRANS_COMPLETE_INT` (master) interrupt.
15. If the command is an END, repeat step 10.
16. Update `I2Cmaster`'s command registers.

Command registers of <code>I2C_{master}</code>	op_code	ack_value	ack_exp	ack_check_en	byte_num
<code>I2C_COMMAND1</code> (master)	STOP	—	—	—	—

17. Write 1 to `I2C_TRANS_START` (master) bit to start transfer.
18. `I2Cmaster` executes the STOP command and generates an `I2C_TRANS_COMPLETE_INT` (master) interrupt.

27.5.5 I2C_{master} Reads I2C_{slave} with a 7-bit Address in One Command Sequence

27.5.5.1 Introduction

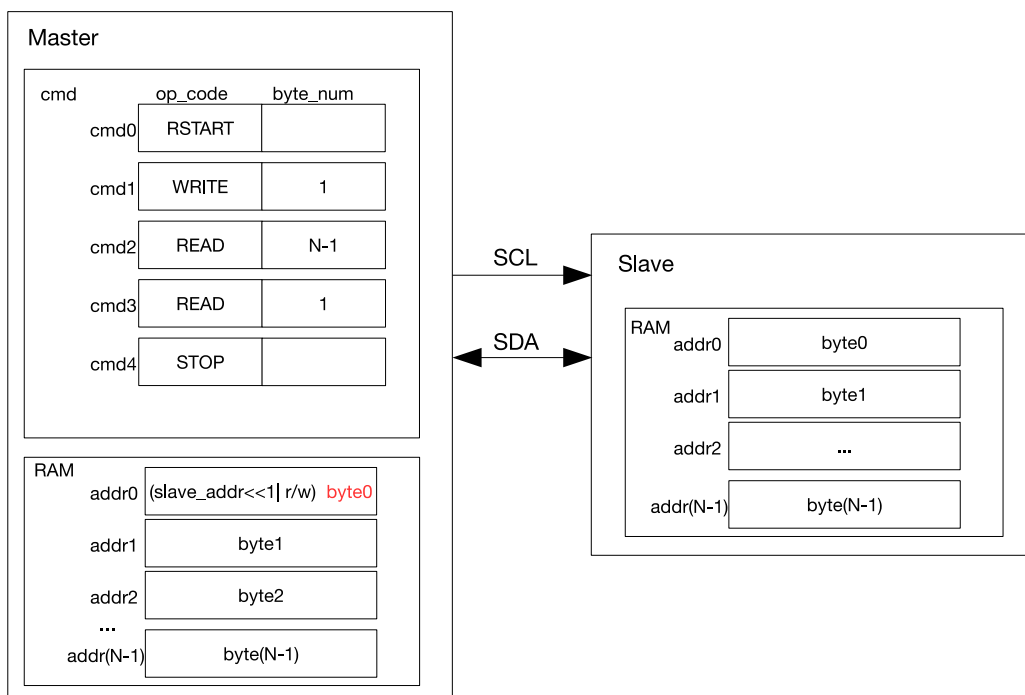

Figure 27-11. I2C_{master} Reading I2C_{slave} with a 7-bit Address

Figure 27-11 shows how I2C_{master} reads N bytes of data from an I2C slave using 7-bit addressing. cmd1 is a WRITE command, and when this command is executed I2C_{master} sends the address of I2C_{slave}. The byte sent comprises a 7-bit I2C_{slave} address and a R/\overline{W} bit. When the R/\overline{W} bit is 1, it indicates a READ operation. If the address of an I2C slave matches the sent address, this matching slave starts sending data to I2C_{master}. I2C_{master} generates acknowledgements according to ack_value defined in the READ command upon receiving a byte.

As illustrated in Figure 27-11, I2C_{master} executes two READ commands: it generates ACKs for (N-1) bytes of data in cmd2, and a NACK for the last byte of data in cmd 3. This configuration may be changed as required.

I2C_{master} writes received data into the controller RAM from addr0, whose original content (a the address of I2C_{slave} and a R/\overline{W} bit) is overwritten by byte0 marked red in Figure 27-11.

27.5.5.2 Configuration Example

1. Set I2C_MS_MODE (master) to 1, and I2C_MS_MODE (slave) to 0.
2. We recommend setting I2C_SLAVE_SCL_STRETCH_EN (slave) to 1, so that SCL can be held low for more processing time when I2C_{slave} needs to send data. If this bit is not set, software should write data to be sent to I2C_{slave}'s TX RAM before I2C_{master} initiates transfer. Configuration below is applicable to scenario where I2C_SLAVE_SCL_STRETCH_EN (slave) is 1.
3. Write 1 to I2C_CONF_UPGATE (master) and I2C_CONF_UPGATE (slave) to synchronize registers.
4. Configure command registers of I2C_{master}.

Command registers of I2C _{master}	op_code	ack_value	ack_exp	ack_check_en	byte_num
I2C_COMMAND0 (master)	RSTART	—	—	—	—
I2C_COMMAND1 (master)	WRITE	0	0	1	1
I2C_COMMAND2 (master)	READ	0	0	1	N-1
I2C_COMMAND3 (master)	READ	1	0	1	1
I2C_COMMAND4 (master)	STOP	—	—	—	—

5. Write the address of I2C_{slave} to TX RAM of I2C_{master} in either FIFO mode or non-FIFO mode according to Section 27.4.10.
6. Write the address of I2C_{slave} to I2C_SLAVE_ADDR (slave) in I2C_SLAVE_ADDR_REG (slave) register.
7. Write 1 to I2C_CONF_UPGATE (master) and I2C_CONF_UPGATE (slave) to synchronize registers.
8. Write 1 to I2C_TRANS_START (master) bit to start I2C_{master}'s transfer.
9. Start I2C_{slave}'s transfer according to Section 27.4.14.
10. I2C_{slave} compares the slave address sent by I2C_{master} with its own address in I2C_SLAVE_ADDR (slave). When ack_check_en (master) in I2C_{master}'s WRITE command is 1, I2C_{master} checks ACK value each time it sends a byte. When ack_check_en (master) is 0, I2C_{master} does not check ACK value and take I2C_{slave} as matching slave by default.
 - Match: If the received ACK value matches ack_exp (master) (the expected ACK value), I2C_{master} continues data transfer.
 - Not match: If the received ACK value does not match ack_exp, I2C_{master} generates an I2C_NACK_INT (master) interrupt and stops data transfer.
11. After I2C_SLAVE_STRETCH_INT (slave) is generated, the I2C_STRETCH_CAUSE bit is 0. The address of I2C_{slave} matches the address sent over SDA, and I2C_{slave} needs to send data.
12. Write data to be sent to TX RAM of I2C_{slave} in either FIFO mode or non-FIFO mode according to Section 27.4.10.
13. Set I2C_SLAVE_SCL_STRETCH_CLR (slave) to 1 to release SCL.

14. I2C_{slave} sends data, and I2C_{master} checks ACK value or not according to ack_check_en (master) in the READ command.
15. If data to be read by I2C_{master} is larger than 32 bytes, an I2C_SLAVE_STRETCH_INT (slave) interrupt will be generated when TX RAM of I2C_{slave} becomes empty. In this way, I2C_{slave} can hold SCL low, so that software has more time to pad data in TX RAM of I2C_{slave} and read data in RX RAM of I2C_{master}. After software has finished reading, you can set I2C_SLAVE_STRETCH_INT_CLR (slave) to 1 to clear interrupt, and set I2C_SLAVE_SCL_STRETCH_CLR (slave) to release the SCL line.
16. After I2C_{master} has received the last byte of data, set ack_value (master) to 1. I2C_{slave} will stop transfer once receiving the I2C_NACK_INT interrupt.
17. After data transfer completes, I2C_{master} executes the STOP command, and generates an I2C_TRANS_COMPLETE_INT (master) interrupt.

27.5.6 I2C_{master} Reads I2C_{slave} with a 10-bit Address in One Command Sequence

27.5.6.1 Introduction

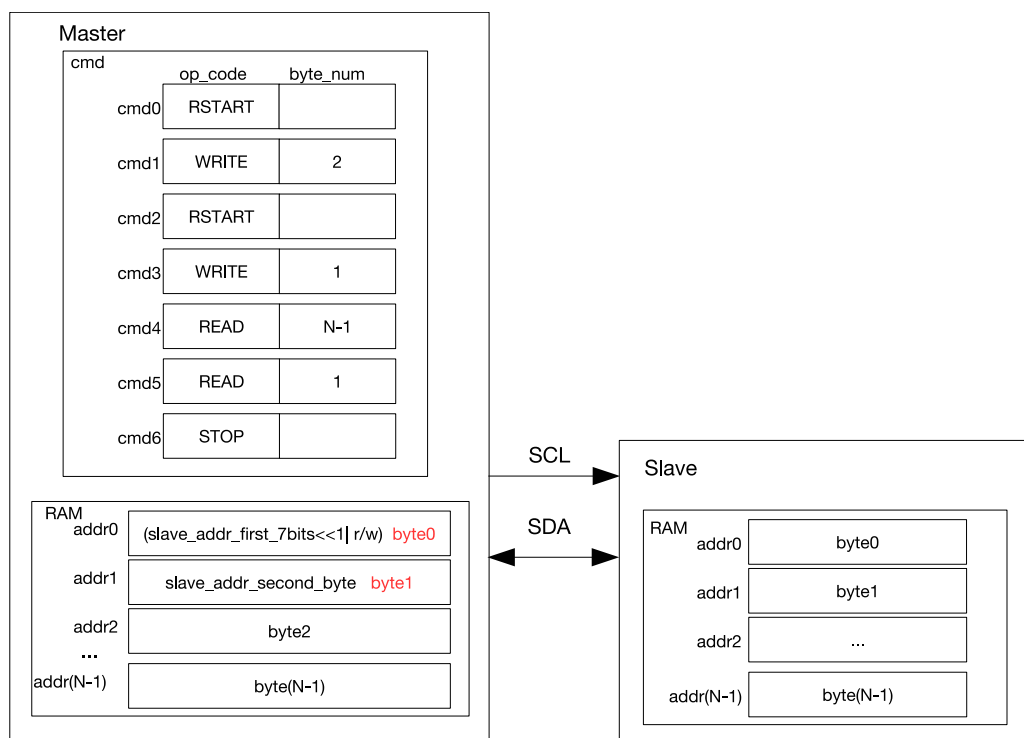

Figure 27-12. I2C_{master} Reading I2C_{slave} with a 10-bit Address

Figure 27-12 shows how I2C_{master} reads data from an I2C slave using 10-bit addressing. Unlike 7-bit addressing, in 10-bit addressing the WRITE command of the I2C_{master} is formed from two bytes, and correspondingly TX RAM of this master stores a 10-bit address of two bytes. The R/\overline{W} bit in the first byte is 0, which indicates a WRITE operation. After a RSTART condition, I2C_{master} sends the first byte of address again to read data from I2C_{slave}, but the R/\overline{W} bit is 1, which indicates a READ operation. The two address bytes can be configured as described in Section 27.5.2.

27.5.6.2 Configuration Example

1. Set `I2C_MS_MODE` (master) to 1, and `I2C_MS_MODE` (slave) to 0.
2. We recommend setting `I2C_SLAVE_SCL_STRETCH_EN` (slave) to 1, so that SCL can be held low for more processing time when `I2C_slave` needs to send data. If this bit is not set, software should write data to be sent to `I2C_slave`'s TX RAM before `I2C_master` initiates transfer. Configuration below is applicable to scenario where `I2C_SLAVE_SCL_STRETCH_EN` (slave) is 1.
3. Write 1 to `I2C_CONF_UPGATE` (master) and `I2C_CONF_UPGATE` (slave) to synchronize registers.
4. Configure command registers of `I2C_master`.

Command registers of <code>I2C_master</code>	op_code	ack_value	ack_exp	ack_check_en	byte_num
<code>I2C_COMMAND0</code> (master)	RSTART	—	—	—	—
<code>I2C_COMMAND1</code> (master)	WRITE	0	0	1	2
<code>I2C_COMMAND2</code> (master)	RSTART	—	—	—	—
<code>I2C_COMMAND3</code> (master)	WRITE	0	0	1	1
<code>I2C_COMMAND4</code> (master)	READ	0	0	1	N-1
<code>I2C_COMMAND5</code> (master)	READ	1	0	1	1
<code>I2C_COMMAND6</code> (master)	STOP	—	—	—	—

5. Configure `I2C_SLAVE_ADDR` (slave) in `I2C_SLAVE_ADDR_REG` (slave) as `I2C_slave`'s 10-bit address, and set `I2C_ADDR_10BIT_EN` (slave) to 1 to enable 10-bit addressing.
6. Write the address of `I2C_slave` and data to be sent to TX RAM of `I2C_master` in either FIFO or non-FIFO mode. The first byte of address comprises $((0x78 | I2C_SLAVE_ADDR[9:8]) \ll 1)$ and a R/\overline{W} bit, which is 1 and indicates a WRITE operation. The second byte of address is `I2C_SLAVE_ADDR[7:0]`. The third byte is $((0x78 | I2C_SLAVE_ADDR[9:8]) \ll 1)$ and a R/\overline{W} bit, which is 1 and indicates a READ operation.
7. Write 1 to `I2C_CONF_UPGATE` (master) and `I2C_CONF_UPGATE` (slave) to synchronize registers.
8. Write 1 to `I2C_TRANS_START` (master) to start `I2C_master`'s transfer.
9. Start `I2C_slave`'s transfer according to Section 27.4.14.
10. `I2C_slave` compares the slave address sent by `I2C_master` with its own address in `I2C_SLAVE_ADDR` (slave). When `ack_check_en` (master) in `I2C_master`'s WRITE command is 1, `I2C_master` checks ACK value each time it sends a byte. When `ack_check_en` (master) is 0, `I2C_master` does not check ACK value and take `I2C_slave` as matching slave by default.
 - Match: If the received ACK value matches `ack_exp` (master) (the expected ACK value), `I2C_master` continues data transfer.
 - Not match: If the received ACK value does not match `ack_exp`, `I2C_master` generates an `I2C_NACK_INT` (master) interrupt and stops data transfer.
11. `I2C_master` sends a RSTART and the third byte in TX RAM, which is $((0x78 | I2C_SLAVE_ADDR[9:8]) \ll 1)$ and a R/\overline{W} bit that indicates READ.
12. `I2C_slave` repeats step 10. If its address matches the address sent by `I2C_master`, `I2C_slave` proceed on to the next steps.

13. After `I2C_SLAVE_STRETCH_INT` (slave) is generated, the `I2C_STRETCH_CAUSE` bit is 0. The address of `I2C_slave` matches the address sent over SDA, and `I2C_slave` needs to send data.
14. Write data to be sent to TX RAM of `I2C_slave` in either FIFO mode or non-FIFO mode according to Section 27.4.10.
15. Set `I2C_SLAVE_SCL_STRETCH_CLR` (slave) to 1 to release SCL.
16. `I2C_slave` sends data, and `I2C_master` checks ACK value or not according to `ack_check_en` (master) in the READ command.
17. If data to be read by `I2C_master` is larger than 32 bytes, an `I2C_SLAVE_STRETCH_INT` (slave) interrupt will be generated when TX RAM of `I2C_slave` becomes empty. In this way, `I2C_slave` can hold SCL low, so that software has more time to pad data in TX RAM of `I2C_slave` and read data in RX RAM of `I2C_master`. After software has finished reading, you can set `I2C_SLAVE_STRETCH_INT_CLR` (slave) to 1 to clear interrupt, and set `I2C_SLAVE_SCL_STRETCH_CLR` (slave) to release the SCL line.
18. After `I2C_master` has received the last byte of data, set `ack_value` (master) to 1. `I2C_slave` will stop transfer once receiving the `I2C_NACK_INT` interrupt.
19. After data transfer completes, `I2C_master` executes the STOP command, and generates an `I2C_TRANS_COMPLETE_INT` (master) interrupt.

27.5.7 I2C_{master} Reads I2C_{slave} with Two 7-bit Addresses in One Command Sequence

27.5.7.1 Introduction

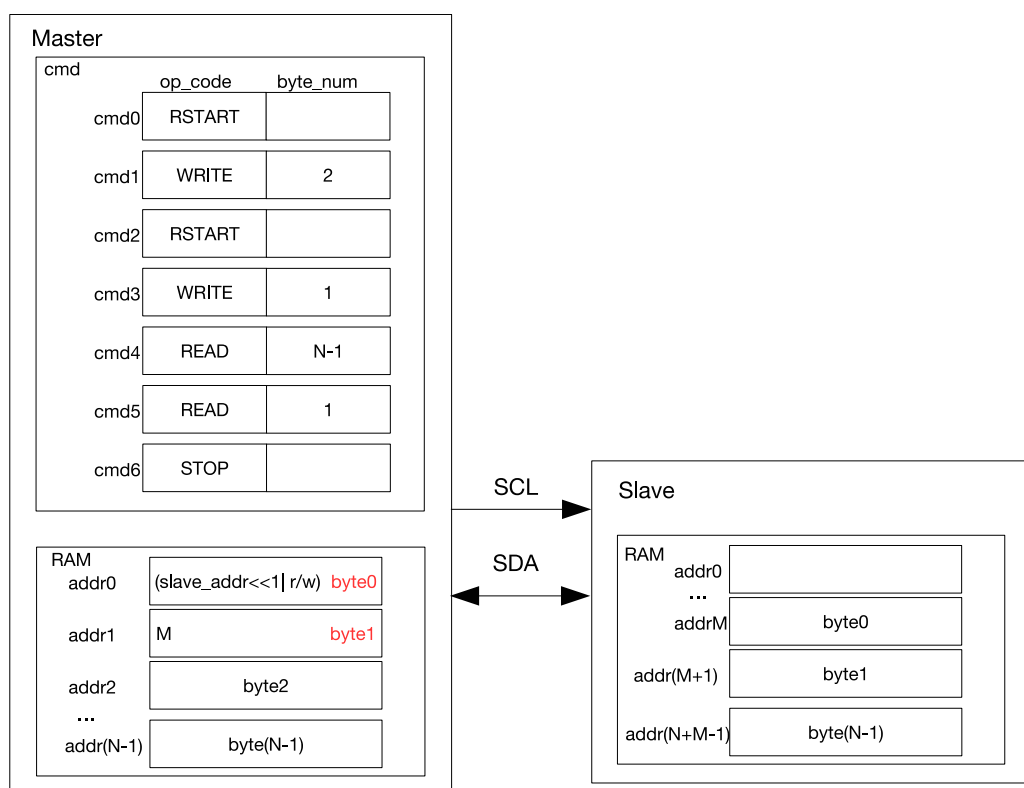

Figure 27-13. I2C_{master} Reading N Bytes of Data from `addrM` of I2C_{slave} with a 7-bit Address

Figure 27-13 shows how I2C_{master} reads data from specified addresses in an I2C slave. I2C_{master} sends two bytes of addresses: the first byte is a 7-bit I2C_{slave} address followed by a R/\overline{W} bit, which is 0 and indicates a WRITE; the second byte is I2C_{slave}'s memory address. After a RSTART condition, I2C_{master} sends the first byte of address again, but the R/\overline{W} bit is 1 which indicates a READ. Then, I2C_{master} reads data starting from addrM.

27.5.7.2 Configuration Example

1. Set I2C_MS_MODE (master) to 1, and I2C_MS_MODE (slave) to 0.
2. We recommend setting I2C_SLAVE_SCL_STRETCH_EN (slave) to 1, so that SCL can be held low for more processing time when I2C_{slave} needs to send data. If this bit is not set, software should write data to be sent to I2C_{slave}'s TX RAM before I2C_{master} initiates transfer. Configuration below is applicable to scenario where I2C_SLAVE_SCL_STRETCH_EN (slave) is 1.
3. Set I2C_FIFO_ADDR_CFG_EN (slave) to 1 to enable double addressing mode.
4. Write 1 to I2C_CONF_UPGATE (master) and I2C_CONF_UPGATE (slave) to synchronize registers.
5. Configure command registers of I2C_{master}.

Command registers of I2C _{master}	op_code	ack_value	ack_exp	ack_check_en	byte_num
I2C_COMMAND0 (master)	RSTART	—	—	—	—
I2C_COMMAND1 (master)	WRITE	0	0	1	2
I2C_COMMAND2 (master)	RSTART	—	—	—	—
I2C_COMMAND3 (master)	WRITE	0	0	1	1
I2C_COMMAND4 (master)	READ	0	0	1	N-1
I2C_COMMAND5 (master)	READ	1	0	1	1
I2C_COMMAND6 (master)	STOP	—	—	—	—

6. Configure I2C_SLAVE_ADDR (slave) in I2C_SLAVE_ADDR_REG (slave) register as I2C_{slave}'s 7-bit address, and set I2C_ADDR_10BIT_EN (slave) to 0 to enable 7-bit addressing.
7. Write the address of I2C_{slave} and data to be sent to TX RAM of I2C_{master} in either FIFO or non-FIFO mode according to Section 27.4.10. The first byte of address comprises (I2C_SLAVE_ADDR[6:0]) \ll 1 and a R/\overline{W} bit, which is 0 and indicates a WRITE. The second byte of address is memory address M of I2C_{slave}. The third byte is (I2C_SLAVE_ADDR[6:0]) \ll 1 and a R/\overline{W} bit, which is 1 and indicates a READ.
8. Write 1 to I2C_CONF_UPGATE (master) and I2C_CONF_UPGATE (slave) to synchronize registers.
9. Write 1 to I2C_TRANS_START (master) to start I2C_{master}'s transfer.
10. Start I2C_{slave}'s transfer according to Section 27.4.14.
11. I2C_{slave} compares the slave address sent by I2C_{master} with its own address in I2C_SLAVE_ADDR (slave). When ack_check_en (master) in I2C_{master}'s WRITE command is 1, I2C_{master} checks ACK value each time it sends a byte. When ack_check_en (master) is 0, I2C_{master} does not check ACK value and take I2C_{slave} as matching slave by default.
 - Match: If the received ACK value matches ack_exp (master) (the expected ACK value), I2C_{master} continues data transfer.

- Not match: If the received ACK value does not match `ack_exp`, `I2C_master` generates an `I2C_NACK_INT` (master) interrupt and stops data transfer.
12. `I2C_slave` receives memory address sent by `I2C_master` and adds the offset.
 13. `I2C_master` sends a RSTART and the third byte in TX RAM, which is $((0x78 | I2C_SLAVE_ADDR[9:8]) \ll 1)$ and a R bit.
 14. `I2C_slave` repeats step 11. If its address matches the address sent by `I2C_master`, `I2C_slave` proceed on to the next steps.
 15. After `I2C_SLAVE_STRETCH_INT` (slave) is generated, the `I2C_STRETCH_CAUSE` bit is 0. The address of `I2C_slave` matches the address sent over SDA, and `I2C_slave` needs to send data.
 16. Write data to be sent to TX RAM of `I2C_slave` in either FIFO mode or non-FIFO mode according to Section [27.4.10](#).
 17. Set `I2C_SLAVE_SCL_STRETCH_CLR` (slave) to 1 to release SCL.
 18. `I2C_slave` sends data, and `I2C_master` checks ACK value or not according to `ack_check_en` (master) in the READ command.
 19. If data to be read by `I2C_master` is larger than 32 bytes, an `I2C_SLAVE_STRETCH_INT` (slave) interrupt will be generated when TX RAM of `I2C_slave` becomes empty. In this way, `I2C_slave` can hold SCL low, so that software has more time to pad data in TX RAM of `I2C_slave` and read data in RX RAM of `I2C_master`. After software has finished reading, you can set `I2C_SLAVE_STRETCH_INT_CLR` (slave) to 1 to clear interrupt, and set `I2C_SLAVE_SCL_STRETCH_CLR` (slave) to release the SCL line.
 20. After `I2C_master` has received the last byte of data, set `ack_value` (master) to 1. `I2C_slave` will stop transfer once receiving the `I2C_NACK_INT` interrupt.
 21. After data transfer completes, `I2C_master` executes the STOP command, and generates an `I2C_TRANS_COMPLETE_INT` (master) interrupt.

27.5.8 `I2C_master` Reads `I2C_slave` with a 7-bit Address in Multiple Command Sequences

27.5.8.1 Introduction

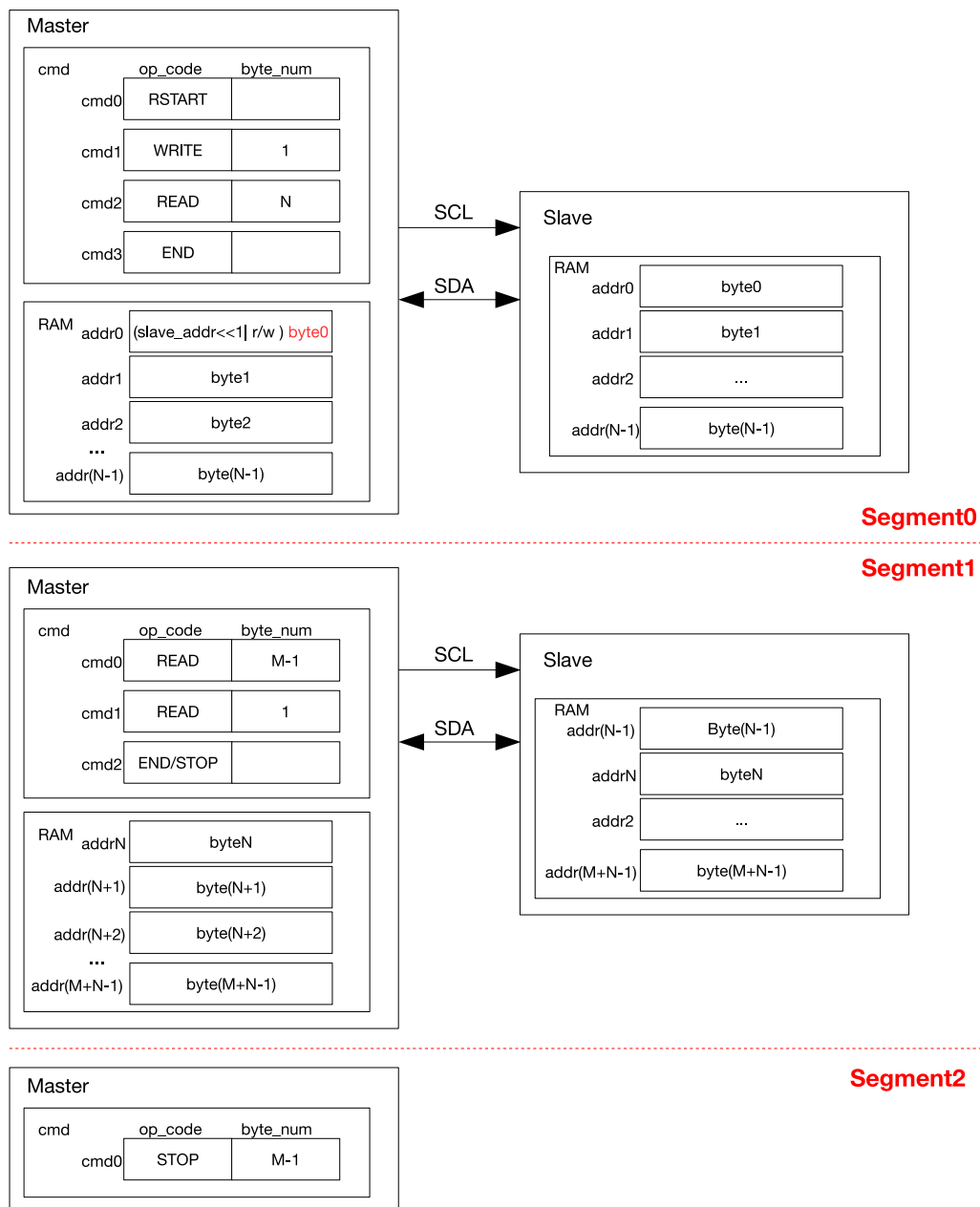

Figure 27-14. I2C_{master} Reading I2C_{slave} with a 7-bit Address in Segments

Figure 27-14 shows how I2C_{master} reads (N+M) bytes of data from an I2C slave in two/three segments separated by END commands. Configuration procedures are described as follows:

1. The procedures for Segment0 is similar to 27-11, except that the last command is an END.
2. Prepare data in the TX RAM of I2C_{slave}, and set I2C_TRANS_START to start data transfer. After executing the END command, I2C_{master} refreshes command registers and the RAM as shown in Segment1, and clears the corresponding I2C_END_DETECT_INT interrupt. If cmd2 in Segment1 is a STOP, then data is read from I2C_{slave} in two segments. I2C_{master} resumes data transfer by setting I2C_TRANS_START and terminates the transfer by sending a STOP bit.
3. If cmd2 in Segment1 is an END, then data is read from I2C_{slave} in three segments. After the second data

transfer finishes and an I2C_END_DETECT_INT interrupt is detected, the cmd box is configured as shown in Segment2. Once I2C_TRANS_START is set, I2C_{master} terminates the transfer by sending a STOP bit.

27.5.8.2 Configuration Example

1. Set I2C_MS_MODE (master) to 1, and I2C_MS_MODE (slave) to 0.
2. We recommend setting I2C_SLAVE_SCL_STRETCH_EN (slave) to 1, so that SCL can be held low for more processing time when I2C_{slave} needs to send data. If this bit is not set, software should write data to be sent to I2C_{slave}'s TX RAM before I2C_{master} initiates transfer. Configuration below is applicable to scenario where I2C_SLAVE_SCL_STRETCH_EN (slave) is 1.
3. Write 1 to I2C_CONF_UPGATE (master) and I2C_CONF_UPGATE (slave) to synchronize registers.
4. Configure command registers of I2C_{master}.

Command registers of I2C _{master}	op_code	ack_value	ack_exp	ack_check_en	byte_num
I2C_COMMAND0 (master)	RSTART	—	—	—	—
I2C_COMMAND1 (master)	WRITE	0	0	1	1
I2C_COMMAND2 (master)	READ	0	0	1	N
I2C_COMMAND3 (master)	END	—	—	—	—

5. Write the address of I2C_{slave} to TX RAM of I2C_{master} in FIFO or non-FIFO mode.
6. Write the address of I2C_{slave} to I2C_SLAVE_ADDR (slave) in I2C_SLAVE_ADDR_REG (slave) register.
7. Write 1 to I2C_CONF_UPGATE (master) and I2C_CONF_UPGATE (slave) to synchronize registers.
8. Write 1 to I2C_TRANS_START (master) to start I2C_{master}'s transfer.
9. Start I2C_{slave}'s transfer according to Section 27.4.14.
10. I2C_{slave} compares the slave address sent by I2C_{master} with its own address in I2C_SLAVE_ADDR (slave). When ack_check_en (master) in I2C_{master}'s WRITE command is 1, I2C_{master} checks ACK value each time it sends a byte. When ack_check_en (master) is 0, I2C_{master} does not check ACK value and take I2C_{slave} as matching slave by default.
 - Match: If the received ACK value matches ack_exp (master) (the expected ACK value), I2C_{master} continues data transfer.
 - Not match: If the received ACK value does not match ack_exp, I2C_{master} generates an I2C_NACK_INT (master) interrupt and stops data transfer.
11. After I2C_SLAVE_STRETCH_INT (slave) is generated, the I2C_STRETCH_CAUSE bit is 0. The address of I2C_{slave} matches the address sent over SDA, and I2C_{slave} needs to send data.
12. Write data to be sent to TX RAM of I2C_{slave} in either FIFO mode or non-FIFO mode according to Section 27.4.10.
13. Set I2C_SLAVE_SCL_STRETCH_CLR (slave) to 1 to release SCL.
14. I2C_{slave} sends data, and I2C_{master} checks ACK value or not according to ack_check_en (master) in the READ command.

15. If data to be read by I2C_{master} in one READ command (N or M) is larger than 32 bytes, an [I2C_SLAVE_STRETCH_INT](#) (slave) interrupt will be generated when TX RAM of I2C_{slave} becomes empty. In this way, I2C_{slave} can hold SCL low, so that software has more time to pad data in TX RAM of I2C_{slave} and read data in RX RAM of I2C_{master}. After software has finished reading, you can set [I2C_SLAVE_STRETCH_INT_CLR](#) (slave) to 1 to clear interrupt, and set [I2C_SLAVE_SCL_STRETCH_CLR](#) (slave) to release the SCL line.
16. Once finishing reading data in the first READ command, I2C_{master} executes the END command and triggers an [I2C_END_DETECT_INT](#) (master) interrupt, which is cleared by setting [I2C_END_DETECT_INT_CLR](#) (master) to 1.
17. Update I2C_{master}'s command registers using one of the following two methods:

Command registers of I2C _{master}	op_code	ack_value	ack_exp	ack_check_en	byte_num
I2C_COMMAND0 (master)	READ	ack_value	ack_exp	1	M
I2C_COMMAND1 (master)	END	—	—	—	—

Or

Command registers of I2C _{master}	op_code	ack_value	ack_exp	ack_check_en	byte_num
I2C_COMMAND0 (master)	READ	0	0	1	M-1
I2C_COMMAND0 (master)	READ	1	0	1	1
I2C_COMMAND1 (master)	STOP	—	—	—	—

18. Write M bytes of data to be sent to TX RAM of I2C_{slave}. If M is larger than 32, then repeat step 14 in FIFO or non-FIFO mode.
19. Write 1 to [I2C_TRANS_START](#) (master) bit to start transfer and repeat step 14.
20. If the last command is a STOP, then set `ack_value` (master) to 1 after I2C_{master} has received the last byte of data. I2C_{slave} stops transfer upon the [I2C_NACK_INT](#) interrupt. I2C_{master} executes the STOP command to stop transfer and generates an [I2C_TRANS_COMPLETE_INT](#) (master) interrupt.
21. If the last command is an END, then repeat step 16 and proceed on to the next steps.
22. Update I2C_{master}'s command registers.

Command registers of I2C _{master}	op_code	ack_value	ack_exp	ack_check_en	byte_num
I2C_COMMAND1 (master)	STOP	—	—	—	—

23. Write 1 to [I2C_TRANS_START](#) (master) bit to start transfer.
24. I2C_{master} executes the STOP command to stop transfer, and generates an [I2C_TRANS_COMPLETE_INT](#) (master) interrupt.

27.6 Interrupts

- [I2C_SLAVE_STRETCH_INT](#): Generated when one of the four stretching events occurs in slave mode.

- I2C_DET_START_INT: Triggered when the master or the slave detects a START bit.
- I2C_SCL_MAIN_ST_TO_INT: Triggered when the main state machine SCL_MAIN_FSM remains unchanged for over [I2C_SCL_MAIN_ST_TO_I2C\[23:0\]](#) clock cycles.
- I2C_SCL_ST_TO_INT: Triggered when the state machine SCL_FSM remains unchanged for over [I2C_SCL_ST_TO_I2C\[23:0\]](#) clock cycles.
- I2C_RXFIFO_UDF_INT: Triggered when the I2C controller reads RX FIFO via the APB bus, but RX FIFO is empty.
- I2C_TXFIFO_OVF_INT: Triggered when the I2C controller writes TX FIFO via the APB bus, but TX FIFO is full.
- I2C_NACK_INT: Triggered when the ACK value received by the master is not as expected, or when the ACK value received by the slave is 1.
- I2C_TRANS_START_INT: Triggered when the I2C controller sends a START bit.
- I2C_TIME_OUT_INT: Triggered when SCL stays high or low for more than [I2C_TIME_OUT_VALUE](#) clock cycles during data transfer.
- I2C_TRANS_COMPLETE_INT: Triggered when the I2C controller detects a STOP bit.
- I2C_MST_TXFIFO_UDF_INT: Triggered when TX FIFO of the master underflows.
- I2C_ARBITRATION_LOST_INT: Triggered when the SDA's output value does not match its input value while the master's SCL is high.
- I2C_BYTE_TRANS_DONE_INT: Triggered when the I2C controller sends or receives a byte.
- I2C_END_DETECT_INT: Triggered when op_code of the master indicates an END command and an END condition is detected.
- I2C_RXFIFO_OVF_INT: Triggered when RX FIFO of the I2C controller overflows.
- I2C_TXFIFO_WM_INT: I2C TX FIFO watermark interrupt. Triggered when [I2C_FIFO_PRT_EN](#) is 1 and the pointers of TX FIFO are less than [I2C_TXFIFO_WM_THRHD\[4:0\]](#).
- I2C_RXFIFO_WM_INT: I2C RX FIFO watermark interrupt. Triggered when [I2C_FIFO_PRT_EN](#) is 1 and the pointers of RX FIFO are greater than [I2C_RXFIFO_WM_THRHD\[4:0\]](#).

27.7 Register Summary

The addresses in this section are relative to **I2C Controller** base address provided in Table 4-3 in Chapter 4 *System and Memory*.

The abbreviations given in Column **Access** are explained in Section [Access Types for Registers](#).

Name	Description	Address	Access
Timing registers			
I2C_SCL_LOW_PERIOD_REG	Configures the low level width of SCL	0x0000	R/W
I2C_SDA_HOLD_REG	Configures the hold time after a negative SCL edge	0x0030	R/W
I2C_SDA_SAMPLE_REG	Configures the sample time after a positive SCL edge	0x0034	R/W
I2C_SCL_HIGH_PERIOD_REG	Configures the high level width of SCL	0x0038	R/W
I2C_SCL_START_HOLD_REG	Configures the delay between the SDA and SCL negative edge for a START condition	0x0040	R/W
I2C_SCL_RSTART_SETUP_REG	Configures the delay between the positive edge of SCL and the negative edge of SDA	0x0044	R/W
I2C_SCL_STOP_HOLD_REG	Configures the delay after the SCL clock edge for a STOP condition	0x0048	R/W
I2C_SCL_STOP_SETUP_REG	Configures the delay between the SDA and SCL positive edge for a STOP condition	0x004C	R/W
I2C_SCL_ST_TIME_OUT_REG	SCL status timeout register	0x0078	R/W
I2C_SCL_MAIN_ST_TIME_OUT_REG	SCL main status timeout register	0x007C	R/W
Configuration registers			
I2C_CTR_REG	Transmission configuration register	0x0004	varies
I2C_TO_REG	Timeout control register	0x000C	R/W
I2C_SLAVE_ADDR_REG	Slave address configuration register	0x0010	R/W
I2C_FIFO_CONF_REG	FIFO configuration register	0x0018	R/W
I2C_FILTER_CFG_REG	SCL and SDA filter configuration register	0x0050	R/W
I2C_CLK_CONF_REG	I2C clock configuration register	0x0054	R/W
I2C_SCL_SP_CONF_REG	Power configuration register	0x0080	varies
I2C_SCL_STRETCH_CONF_REG	Configures SCL clock stretching	0x0084	varies
Status registers			
I2C_SR_REG	Describes I2C work status	0x0008	RO
I2C_FIFO_ST_REG	FIFO status register	0x0014	RO
I2C_DATA_REG	Read/write FIFO register	0x001C	R/W
Interrupt registers			
I2C_INT_RAW_REG	Raw interrupt status	0x0020	R/SS/WTC
I2C_INT_CLR_REG	Interrupt clear bits	0x0024	WT
I2C_INT_ENA_REG	Interrupt enable bits	0x0028	R/W
I2C_INT_STATUS_REG	Status of captured I2C communication events	0x002C	RO
Command registers			
I2C_COMD0_REG	I2C command register 0	0x0058	varies
I2C_COMD1_REG	I2C command register 1	0x005C	varies

Name	Description	Address	Access
I2C_COMD2_REG	I2C command register 2	0x0060	varies
I2C_COMD3_REG	I2C command register 3	0x0064	varies
I2C_COMD4_REG	I2C command register 4	0x0068	varies
I2C_COMD5_REG	I2C command register 5	0x006C	varies
I2C_COMD6_REG	I2C command register 6	0x0070	varies
I2C_COMD7_REG	I2C command register 7	0x0074	varies
Version register			
I2C_DATE_REG	Version control register	0x00F8	R/W

27.8 Registers

The addresses in this section are relative to **I2C Controller** base address provided in Table 4-3 in Chapter 4 *System and Memory*.

Register 27.1. I2C_SCL_LOW_PERIOD_REG (0x0000)

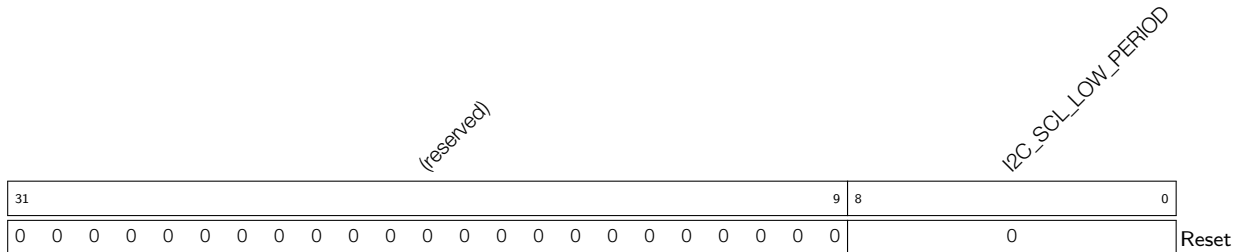

I2C_SCL_LOW_PERIOD This field is used to configure how long SCL remains low in master mode, in I2C module clock cycles. (R/W)

Register 27.2. I2C_SDA_HOLD_REG (0x0030)

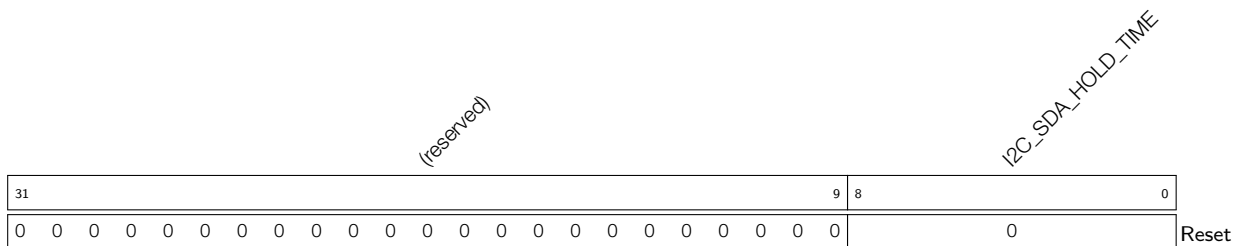

I2C_SDA_HOLD_TIME This field is used to configure the time to hold the data after the falling edge of SCL, in I2C module clock cycles. (R/W)

Register 27.3. I2C_SDA_SAMPLE_REG (0x0034)

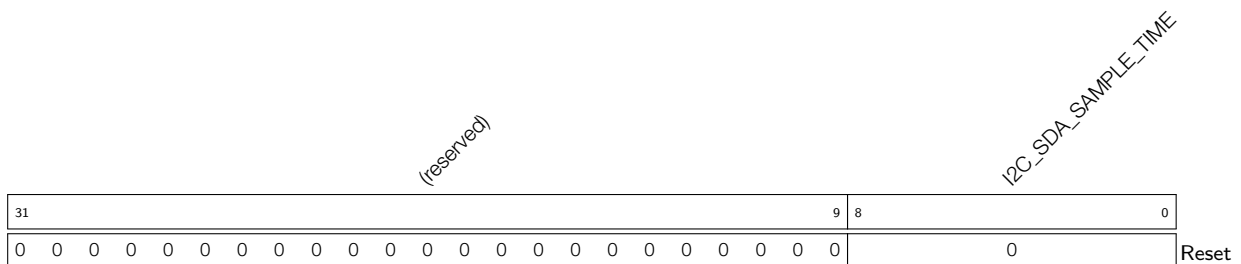

I2C_SDA_SAMPLE_TIME This field is used to configure how long SDA is sampled, in I2C module clock cycles. (R/W)

Register 27.4. I2C_SCL_HIGH_PERIOD_REG (0x0038)

<i>(reserved)</i>																<i>I2C_SCL_WAIT_HIGH_PERIOD</i>				<i>I2C_SCL_HIGH_PERIOD</i>								
31															16	15					9	8					0	
0																0				0				0				Reset

I2C_SCL_HIGH_PERIOD This field is used to configure how long SCL remains high in master mode, in I2C module clock cycles. (R/W)

I2C_SCL_WAIT_HIGH_PERIOD This field is used to configure the SCL_FSM's waiting period for SCL high level in master mode, in I2C module clock cycles. (R/W)

Register 27.5. I2C_SCL_START_HOLD_REG (0x0040)

<i>(reserved)</i>																<i>I2C_SCL_START_HOLD_TIME</i>								
31															9	8					0			
0																8				0				Reset

I2C_SCL_START_HOLD_TIME This field is used to configure the time between the falling edge of SDA and the falling edge of SCL for a START condition, in I2C module clock cycles. (R/W)

Register 27.6. I2C_SCL_RSTART_SETUP_REG (0x0044)

<i>(reserved)</i>																<i>I2C_SCL_RSTART_SETUP_TIME</i>								
31															9	8					0			
0																8				0				Reset

I2C_SCL_RSTART_SETUP_TIME This field is used to configure the time between the rising edge of SCL and the falling edge of SDA for a RSTART condition, in I2C module clock cycles. (R/W)

Register 27.7. I2C_SCL_STOP_HOLD_REG (0x0048)

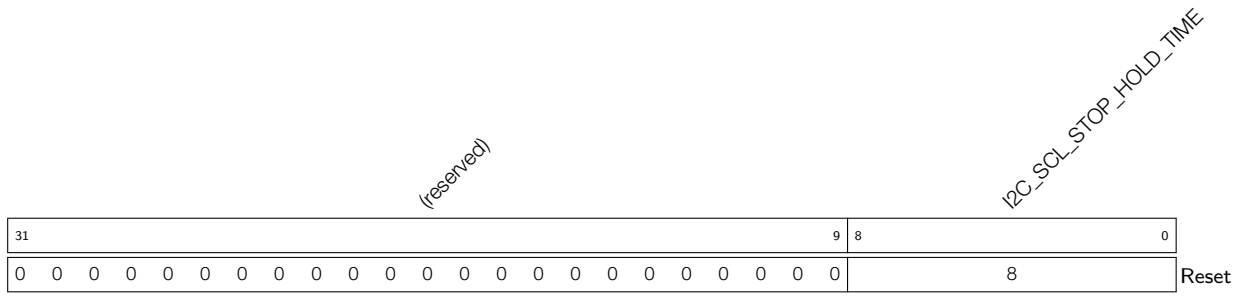

I2C_SCL_STOP_HOLD_TIME This field is used to configure the delay after the STOP condition, in I2C module clock cycles. (R/W)

Register 27.8. I2C_SCL_STOP_SETUP_REG (0x004C)

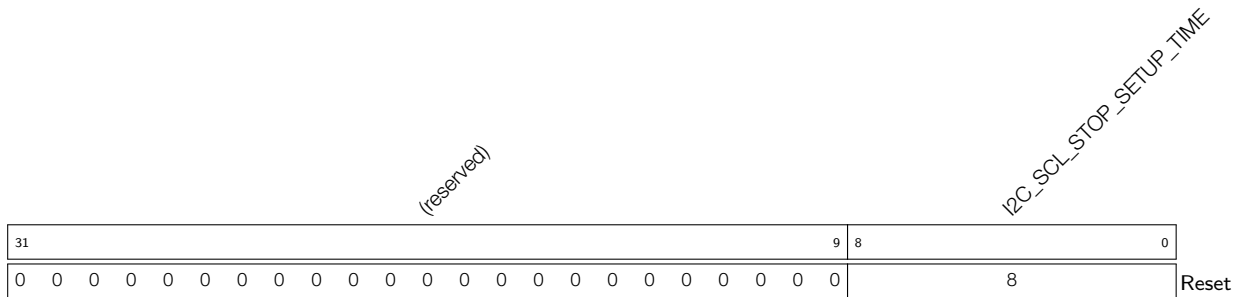

I2C_SCL_STOP_SETUP_TIME This field is used to configure the time between the rising edge of SCL and the rising edge of SDA, in I2C module clock cycles. (R/W)

Register 27.9. I2C_SCL_ST_TIME_OUT_REG (0x0078)

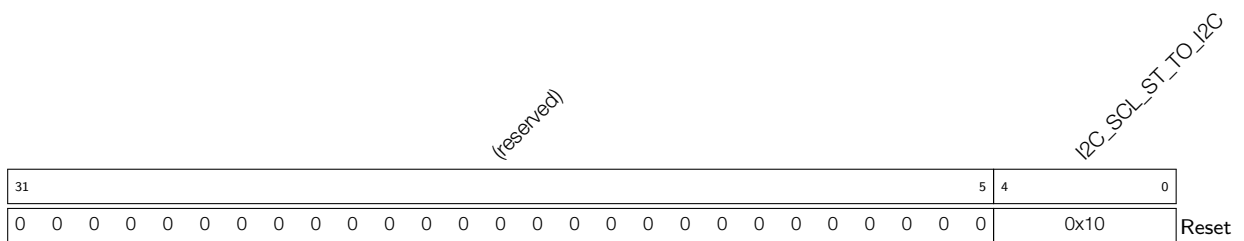

I2C_SCL_ST_TO_I2C The maximum time that SCL_FSM remains unchanged. It should be no more than 23. (R/W)

Register 27.10. I2C_SCL_MAIN_ST_TIME_OUT_REG (0x007C)

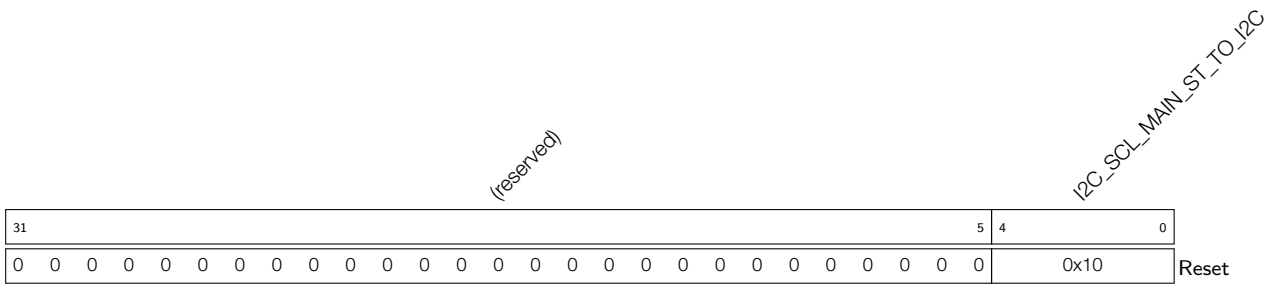

I2C_SCL_MAIN_ST_TO_I2C The maximum time that SCL_MAIN_FSM remains unchanged. It should be no more than 23. (R/W)

Register 27.11. I2C_CTR_REG (0x0004)

(reserved)															I2C_ADDR_BROADCASTING_EN I2C_ADDR_10BIT_RW_CHECK_EN I2C_SLV_TX_AUTO_START_EN I2C_CONF_UPGATE I2C_FSM_RST I2C_ARBITRATION_EN I2C_CLK_EN I2C_RX_LSB_FIRST I2C_TX_LSB_FIRST I2C_TRANS_START I2C_MS_MODE I2C_RX_FULL_ACK_LEVEL I2C_SAMPLE_SCL_LEVEL I2C_SCL_FORCE_OUT I2C_SDA_FORCE_OUT																
31															15	14	13	12	11	10	9	8	7	6	5	4	3	2	1	0	Reset
0	0	0	0	0	0	0	0	0	0	0	0	0	0	0	0	0	1	0	0	0	0	0	0	1	0	1	1				

I2C_SDA_FORCE_OUT 0: direct output; 1: open-drain output. (R/W)

I2C_SCL_FORCE_OUT 0: direct output; 1: open-drain output. (R/W)

I2C_SAMPLE_SCL_LEVEL This bit is used to select the sampling mode. 0: samples SDA data on the SCL high level; 1: samples SDA data on the SCL low level. (R/W)

I2C_RX_FULL_ACK_LEVEL This bit is used to configure the ACK value that need to be sent by master when I2C_RXFIFO_CNT has reached the threshold. (R/W)

I2C_MS_MODE Set this bit to configure the I2C controller as an I2C Master. Clear this bit to configure the I2C controller as a slave. (R/W)

I2C_TRANS_START Set this bit to start sending the data in TX FIFO. (WT)

I2C_TX_LSB_FIRST This bit is used to control the order to send data. 0: sends data from the most significant bit; 1: sends data from the least significant bit. (R/W)

I2C_RX_LSB_FIRST This bit is used to control the order to receive data. 0: receives data from the most significant bit; 1: receives data from the least significant bit. (R/W)

I2C_CLK_EN This field controls APB_CLK clock gating. 0: APB_CLK is gated to save power; 1: APB_CLK is always on. (R/W)

I2C_ARBITRATION_EN This is the enable bit for I2C bus arbitration function. (R/W)

I2C_FSM_RST This bit is used to reset the SCL_FSM. (WT)

I2C_CONF_UPGATE Synchronization bit. (WT)

I2C_SLV_TX_AUTO_START_EN This is the enable bit for slave to send data automatically. (R/W)

I2C_ADDR_10BIT_RW_CHECK_EN This is the enable bit to check if the R/W bit of 10-bit addressing is consistent with the I2C protocol. (R/W)

I2C_ADDR_BROADCASTING_EN This is the enable bit for 7-bit general call addressing. (R/W)

Register 27.12. I2C_TO_REG (0x000C)

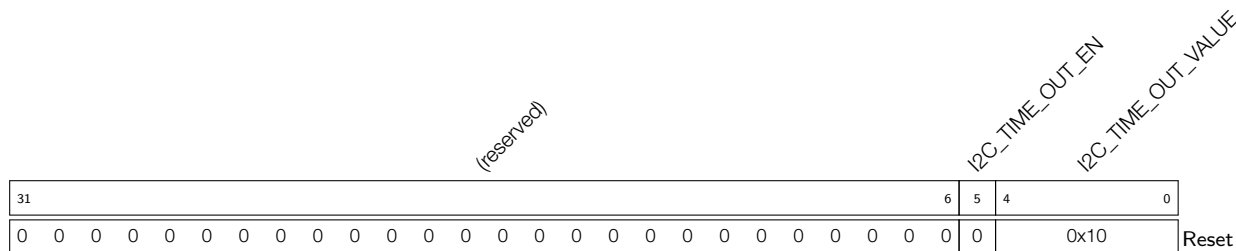

I2C_TIME_OUT_VALUE This field is used to configure the timeout for receiving a data bit in APB clock cycles. (R/W)

I2C_TIME_OUT_EN This is the enable bit for timeout control. (R/W)

Register 27.13. I2C_SLAVE_ADDR_REG (0x0010)

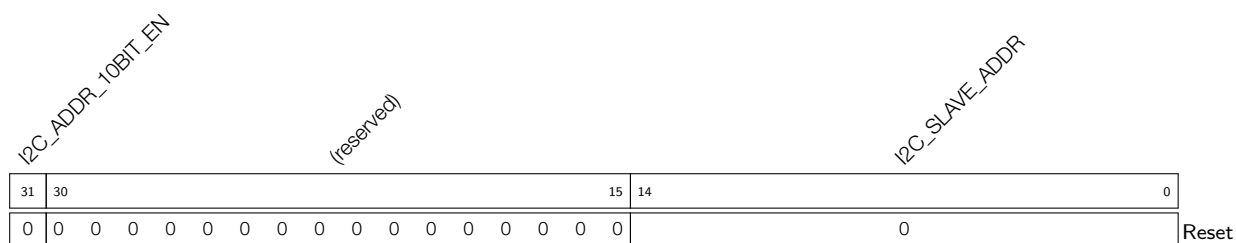

I2C_SLAVE_ADDR When the I2C controller is in slave mode, this field is used to configure the slave address. (R/W)

I2C_ADDR_10BIT_EN This field is used to enable the 10-bit addressing mode in master mode. (R/W)

Register 27.14. I2C_FIFO_CONF_REG (0x0018)

(reserved)															I2C_FIFO_PRT_EN				I2C_TX_FIFO_RST				I2C_RX_FIFO_RST				I2C_FIFO_ADDR_CFG_EN				I2C_NONFIFO_EN				I2C_TXFIFO_WM_THRHD				I2C_RXFIFO_WM_THRHD			
31															15	14	13	12	11	10	9					5	4					0										
0	0	0	0	0	0	0	0	0	0	0	0	0	0	0	0	0	0	1	0	0	0	0	0x4				0xb				Reset											

I2C_RXFIFO_WM_THRHD The watermark threshold of RX FIFO in non-FIFO mode. When I2C_FIFO_PRT_EN is 1 and RX FIFO counter is bigger than I2C_RXFIFO_WM_THRHD[4:0], I2C_RXFIFO_WM_INT_RAW bit is valid. (R/W)

I2C_TXFIFO_WM_THRHD The watermark threshold of TX FIFO in non-FIFO mode. When I2C_FIFO_PRT_EN is 1 and TX FIFO counter is smaller than I2C_TXFIFO_WM_THRHD[4:0], I2C_TXFIFO_WM_INT_RAW bit is valid. (R/W)

I2C_NONFIFO_EN Set this bit to enable APB non-FIFO mode. (R/W)

I2C_FIFO_ADDR_CFG_EN When this bit is set to 1, the byte received after the I2C address byte represents the offset address in the I2C Slave RAM. (R/W)

I2C_RX_FIFO_RST Set this bit to reset RX FIFO. (R/W)

I2C_TX_FIFO_RST Set this bit to reset TX FIFO. (R/W)

I2C_FIFO_PRT_EN The control enable bit of FIFO pointer in non-FIFO mode. This bit controls the valid bits and TX/RX FIFO overflow, underflow, full and empty interrupts. (R/W)

Register 27.15. I2C_FILTER_CFG_REG (0x0050)

(reserved)															I2C_SDA_FILTER_EN				I2C_SCL_FILTER_EN				I2C_SDA_FILTER_THRES				I2C_SCL_FILTER_THRES			
31															10	9	8	7					4	3					0	
0	0	0	0	0	0	0	0	0	0	0	0	0	0	0	0	0	0	0	1	1	0				0				Reset	

I2C_SCL_FILTER_THRES When a pulse on the SCL input has smaller width than the value of this field in I2C module clock cycles, the I2C controller ignores that pulse. (R/W)

I2C_SDA_FILTER_THRES When a pulse on the SDA input has smaller width than the value of this field in I2C module clock cycles, the I2C controller ignores that pulse. (R/W)

I2C_SCL_FILTER_EN This is the filter enable bit for SCL. (R/W)

I2C_SDA_FILTER_EN This is the filter enable bit for SDA. (R/W)

Register 27.16. I2C_CLK_CONF_REG (0x0054)

(reserved)										<i>I2C_SCLK_ACTIVE</i> <i>I2C_SCLK_SEL</i>		<i>I2C_SCLK_DIV_B</i>		<i>I2C_SCLK_DIV_A</i>		<i>I2C_SCLK_DIV_NUM</i>			
31											22	21	20	19	14	13	8	7	0
0 0 0 0 0 0 0 0 0 0										1	0	0		0		0		Reset	

I2C_SCLK_DIV_NUM The integral part of the divisor. (R/W)

I2C_SCLK_DIV_A The numerator of the divisor's fractional part. (R/W)

I2C_SCLK_DIV_B The denominator of the divisor's fractional part. (R/W)

I2C_SCLK_SEL The clock selection bit for the I2C controller. 0: XTAL_CLK; 1: RC_FAST_CLK. (R/W)

I2C_SCLK_ACTIVE The clock switch bit for the I2C controller. (R/W)

Register 27.17. I2C_SCL_SP_CONF_REG (0x0080)

(reserved)																<i>I2C_SDA_PD_EN</i> <i>I2C_SCL_PD_EN</i>		<i>I2C_SCL_RST_SLV_NUM</i>		<i>I2C_SCL_RST_SLV_EN</i>		
31																	8	7	6	5	1	0
0 0 0 0 0 0 0 0 0 0 0 0 0 0 0 0																0	0	0		0		Reset

I2C_SCL_RST_SLV_EN When the master is idle, set this bit to send out SCL pulses. The number of pulses equals to I2C_SCL_RST_SLV_NUM[4:0]. (R/W/SC)

I2C_SCL_RST_SLV_NUM Configures the pulses of SCL generated in master mode. Valid when I2C_SCL_RST_SLV_EN is 1. (R/W)

I2C_SCL_PD_EN The power down enable bit for the I2C output SCL line. 0: Not power down; 1: Power down. Set I2C_SCL_FORCE_OUT and I2C_SCL_PD_EN to 1 to stretch SCL low. (R/W)

I2C_SDA_PD_EN The power down enable bit for the I2C output SDA line. 0: Not power down; 1: Power down. Set I2C_SDA_FORCE_OUT and I2C_SDA_PD_EN to 1 to stretch SDA low. (R/W)

Register 27.19. I2C_SR_REG (0x0008)

(reserved)		I2C_SCL_STATE_LAST		(reserved)		I2C_SCL_MAIN_STATE_LAST		I2C_TXFIFO_CNT		(reserved)		I2C_STRETCH_CAUSE		I2C_RXFIFO_CNT		(reserved)		I2C_SLAVE_ADDRESSED		I2C_BUS_BUSY		I2C_ARB_LOST		(reserved)		I2C_SLAVE_RW		I2C_RESP_REC	
31	30	28	27	26	24	23	18	17	16	15	14	13	8	7	6	5	4	3	2	1	0	Reset							
0	0	0	0	0	0	0	0	0	0	0x3	0	0	0	0	0	0	0	0	0	0	0	0	0	0	0	0	0	0	0

I2C_RESP_REC The received ACK value in master mode or slave mode. 0: ACK; 1: NACK. (RO)

I2C_SLAVE_RW When in slave mode, 0: master writes to slave; 1: master reads from slave. (RO)

I2C_ARB_LOST When the I2C controller loses control of the SCL line, this bit changes to 1. (RO)

I2C_BUS_BUSY 0: the I2C bus is in idle state; 1: the I2C bus is busy transferring data. (RO)

I2C_SLAVE_ADDRESSED When the I2C controller is in slave mode, and the address sent by the master matches the address of the slave, this bit is at high level. (RO)

I2C_RXFIFO_CNT This field represents the number of data bytes to be sent. (RO)

I2C_STRETCH_CAUSE The cause of SCL clock stretching in slave mode. 0: stretching SCL low when the master starts to read data; 1: stretching SCL low when TX FIFO is empty in slave mode; 2: stretching SCL low when RX FIFO is full in slave mode. (RO)

I2C_TXFIFO_CNT This field stores the number of data bytes received in RAM. (RO)

I2C_SCL_MAIN_STATE_LAST This field indicates the status of the state machine. 0: idle; 1: address shift; 2: ACK address; 3: receive data; 4: transmit data; 5: send ACK; 6: wait for ACK. (RO)

I2C_SCL_STATE_LAST This field indicates the status of the state machine used to produce SCL. 0: idle; 1: start; 2: falling edge; 3: low; 4: rising edge; 5: high; 6: stop. (RO)

Register 27.20. I2C_FIFO_ST_REG (0x0014)

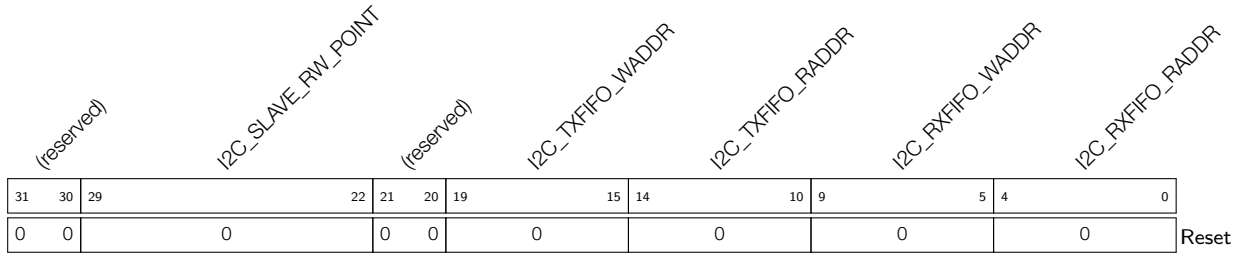

- I2C_RXFIFO_RADDR** This is the offset address of the APB reading from RX FIFO. (RO)
- I2C_RXFIFO_WADDR** This is the offset address of the I2C controller receiving data and writing to RX FIFO. (RO)
- I2C_TXFIFO_RADDR** This is the offset address of the I2C controller reading from TX FIFO. (RO)
- I2C_TXFIFO_WADDR** This is the offset address of APB bus writing to TX FIFO. (RO)
- I2C_SLAVE_RW_POINT** The received data in I2C slave mode. (RO)

Register 27.21. I2C_DATA_REG (0x001C)

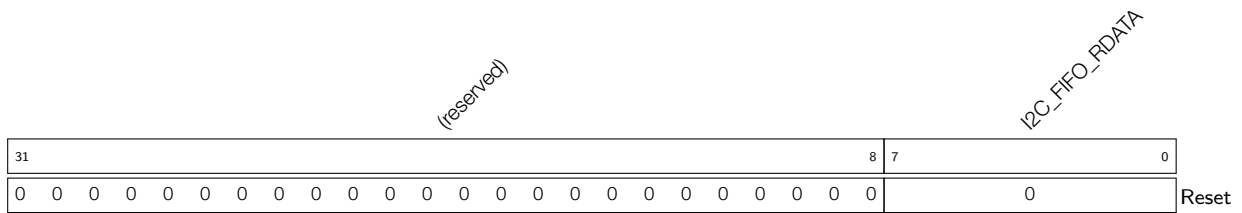

- I2C_FIFO_RDATA** This field is used to read data from RX FIFO, or write data to TX FIFO. (R/W)

Register 27.22. I2C_INT_RAW_REG (0x0020)

(reserved)																		<i>I2C_GENERAL_CALL_INT_RAW</i> <i>I2C_SLAVE_STRETCH_INT_RAW</i> <i>I2C_DET_START_INT_RAW</i> <i>I2C_SCL_MAIN_ST_TO_INT_RAW</i> <i>I2C_SCL_ST_TO_INT_RAW</i> <i>I2C_RXFIFO_UDF_INT_RAW</i> <i>I2C_TXFIFO_UDF_INT_RAW</i> <i>I2C_NACK_INT_RAW</i> <i>I2C_TRANS_START_INT_RAW</i> <i>I2C_TIME_OUT_INT_RAW</i> <i>I2C_TRANS_COMPLETE_INT_RAW</i> <i>I2C_MST_TXFIFO_UDF_INT_RAW</i> <i>I2C_ARBITRATION_LOST_INT_RAW</i> <i>I2C_BYTE_TRANS_DONE_INT_RAW</i> <i>I2C_END_DETECT_INT_RAW</i> <i>I2C_RXFIFO_OVF_INT_RAW</i> <i>I2C_TXFIFO_WM_INT_RAW</i> <i>I2C_RXFIFO_WM_INT_RAW</i>																			
31																		18	17	16	15	14	13	12	11	10	9	8	7	6	5	4	3	2	1	0	
0	0	0	0	0	0	0	0	0	0	0	0	0	0	0	0	0	0	0	0	0	0	0	0	0	0	0	0	1	0	Reset							

I2C_RXFIFO_WM_INT_RAW The raw interrupt bit for the I2C_RXFIFO_WM_INT interrupt. (R/SS/WTC)

I2C_TXFIFO_WM_INT_RAW The raw interrupt bit for the I2C_TXFIFO_WM_INT interrupt. (R/SS/WTC)

I2C_RXFIFO_OVF_INT_RAW The raw interrupt bit for the I2C_RXFIFO_OVF_INT interrupt. (R/SS/WTC)

I2C_END_DETECT_INT_RAW The raw interrupt bit for the I2C_END_DETECT_INT interrupt. (R/SS/WTC)

I2C_BYTE_TRANS_DONE_INT_RAW The raw interrupt bit for the I2C_BYTE_TRANS_DONE_INT interrupt. (R/SS/WTC)

I2C_ARBITRATION_LOST_INT_RAW The raw interrupt bit for the I2C_ARBITRATION_LOST_INT interrupt. (R/SS/WTC)

I2C_MST_TXFIFO_UDF_INT_RAW The raw interrupt bit for the I2C_TRANS_COMPLETE_INT interrupt. (R/SS/WTC)

I2C_TRANS_COMPLETE_INT_RAW The raw interrupt bit for the I2C_TRANS_COMPLETE_INT interrupt. (R/SS/WTC)

I2C_TIME_OUT_INT_RAW The raw interrupt bit for the I2C_TIME_OUT_INT interrupt. (R/SS/WTC)

I2C_TRANS_START_INT_RAW The raw interrupt bit for the I2C_TRANS_START_INT interrupt. (R/SS/WTC)

I2C_NACK_INT_RAW The raw interrupt bit for the I2C_SLAVE_STRETCH_INT interrupt. (R/SS/WTC)

I2C_TXFIFO_OVF_INT_RAW The raw interrupt bit for the I2C_TXFIFO_OVF_INT interrupt. (R/SS/WTC)

I2C_RXFIFO_UDF_INT_RAW The raw interrupt bit for the I2C_RXFIFO_UDF_INT interrupt. (R/SS/WTC)

Continued on the next page...

Register 27.22. I2C_INT_RAW_REG (0x0020)

Continued from the previous page...

I2C_SCL_ST_TO_INT_RAW The raw interrupt bit for the I2C_SCL_ST_TO_INT interrupt.
(R/SS/WTC)

I2C_SCL_MAIN_ST_TO_INT_RAW The raw interrupt bit for the I2C_SCL_MAIN_ST_TO_INT interrupt.
(R/SS/WTC)

I2C_DET_START_INT_RAW The raw interrupt bit for the I2C_DET_START_INT interrupt.
(R/SS/WTC)

I2C_SLAVE_STRETCH_INT_RAW The raw interrupt bit for the I2C_SLAVE_STRETCH_INT interrupt.
(R/SS/WTC)

I2C_GENERAL_CALL_INT_RAW The raw interrupt bit for the I2C_GENERAL_CALL_INT interrupt.
(R/SS/WTC)

Register 27.23. I2C_INT_CLR_REG (0x0024)

(reserved)																		<i>I2C_GENERAL_CALL_INT_CLR</i> <i>I2C_SLAVE_STRETCH_INT_CLR</i> <i>I2C_DET_START_INT_CLR</i> <i>I2C_SCL_MAIN_ST_TO_INT_CLR</i> <i>I2C_SCL_ST_TO_INT_CLR</i> <i>I2C_RXFIFO_UDF_INT_CLR</i> <i>I2C_TXFIFO_OVF_INT_CLR</i> <i>I2C_NACK_INT_CLR</i> <i>I2C_TRANS_START_INT_CLR</i> <i>I2C_TIME_OUT_INT_CLR</i> <i>I2C_MST_TXFIFO_UDF_INT_CLR</i> <i>I2C_TRANS_COMPLETE_INT_CLR</i> <i>I2C_ARBITRATION_LOST_INT_CLR</i> <i>I2C_BYTE_TRANS_DONE_INT_CLR</i> <i>I2C_END_DETECT_INT_CLR</i> <i>I2C_RXFIFO_OVF_INT_CLR</i> <i>I2C_TXFIFO_WM_INT_CLR</i> <i>I2C_RXFIFO_WM_INT_CLR</i>																			
31																		18	17	16	15	14	13	12	11	10	9	8	7	6	5	4	3	2	1	0	Reset
0 0																																					

I2C_RXFIFO_WM_INT_CLR Set this bit to clear the I2C_RXFIFO_WM_INT interrupt. (WT)

I2C_TXFIFO_WM_INT_CLR Set this bit to clear the I2C_TXFIFO_WM_INT interrupt. (WT)

I2C_RXFIFO_OVF_INT_CLR Set this bit to clear the I2C_RXFIFO_OVF_INT interrupt. (WT)

I2C_END_DETECT_INT_CLR Set this bit to clear the I2C_END_DETECT_INT interrupt. (WT)

I2C_BYTE_TRANS_DONE_INT_CLR Set this bit to clear the I2C_END_DETECT_INT interrupt. (WT)

I2C_ARBITRATION_LOST_INT_CLR Set this bit to clear the I2C_ARBITRATION_LOST_INT interrupt. (WT)

I2C_MST_TXFIFO_UDF_INT_CLR Set this bit to clear the I2C_TRANS_COMPLETE_INT interrupt. (WT)

I2C_TRANS_COMPLETE_INT_CLR Set this bit to clear the I2C_TRANS_COMPLETE_INT interrupt. (WT)

I2C_TIME_OUT_INT_CLR Set this bit to clear the I2C_TIME_OUT_INT interrupt. (WT)

I2C_TRANS_START_INT_CLR Set this bit to clear the I2C_TRANS_START_INT interrupt. (WT)

I2C_NACK_INT_CLR Set this bit to clear the I2C_SLAVE_STRETCH_INT interrupt. (WT)

I2C_TXFIFO_OVF_INT_CLR Set this bit to clear the I2C_TXFIFO_OVF_INT interrupt. (WT)

I2C_RXFIFO_UDF_INT_CLR Set this bit to clear the I2C_RXFIFO_UDF_INT interrupt. (WT)

I2C_SCL_ST_TO_INT_CLR Set this bit to clear the I2C_SCL_ST_TO_INT interrupt. (WT)

I2C_SCL_MAIN_ST_TO_INT_CLR Set this bit to clear the I2C_SCL_MAIN_ST_TO_INT interrupt. (WT)

I2C_DET_START_INT_CLR Set this bit to clear the I2C_DET_START_INT interrupt. (WT)

I2C_SLAVE_STRETCH_INT_CLR Set this bit to clear the I2C_SLAVE_STRETCH_INT interrupt. (WT)

I2C_GENERAL_CALL_INT_CLR Set this bit for the I2C_GENARAL_CALL_INT interrupt. (WT)

Register 27.24. I2C_INT_ENA_REG (0x0028)

(reserved)																		I2C_GENERAL_CALL_INT_ENA I2C_SLAVE_STRETCH_INT_ENA I2C_DET_START_INT_ENA I2C_SCL_MAIN_ST_TO_INT_ENA I2C_SCL_ST_TO_INT_ENA I2C_RXFIFO_UDF_INT_ENA I2C_TXFIFO_UDF_INT_ENA I2C_NACK_INT_ENA I2C_TRANS_START_INT_ENA I2C_TIME_OUT_INT_ENA I2C_TRANS_COMPLETE_INT_ENA I2C_ARBITRATION_LOST_INT_ENA I2C_BYTE_TRANS_DONE_INT_ENA I2C_END_DETECT_INT_ENA I2C_RXFIFO_OVF_INT_ENA I2C_TXFIFO_WM_INT_ENA																		
31																		18	17	16	15	14	13	12	11	10	9	8	7	6	5	4	3	2	1	0
0																		0														Reset				

I2C_RXFIFO_WM_INT_ENA The interrupt enable bit for the I2C_RXFIFO_WM_INT interrupt. (R/W)

I2C_TXFIFO_WM_INT_ENA The interrupt enable bit for the I2C_TXFIFO_WM_INT interrupt. (R/W)

I2C_RXFIFO_OVF_INT_ENA The interrupt enable bit for the I2C_RXFIFO_OVF_INT interrupt. (R/W)

I2C_END_DETECT_INT_ENA The interrupt enable bit for the I2C_END_DETECT_INT interrupt. (R/W)

I2C_BYTE_TRANS_DONE_INT_ENA The interrupt enable bit for the I2C_BYTE_TRANS_DONE_INT interrupt. (R/W)

I2C_ARBITRATION_LOST_INT_ENA The interrupt enable bit for the I2C_ARBITRATION_LOST_INT interrupt. (R/W)

I2C_MST_TXFIFO_UDF_INT_ENA The interrupt enable bit for the I2C_TRANS_COMPLETE_INT interrupt. (R/W)

I2C_TRANS_COMPLETE_INT_ENA The interrupt enable bit for the I2C_TRANS_COMPLETE_INT interrupt. (R/W)

I2C_TIME_OUT_INT_ENA The interrupt enable bit for the I2C_TIME_OUT_INT interrupt. (R/W)

I2C_TRANS_START_INT_ENA The interrupt enable bit for the I2C_TRANS_START_INT interrupt. (R/W)

I2C_NACK_INT_ENA The interrupt enable bit for the I2C_SLAVE_STRETCH_INT interrupt. (R/W)

I2C_TXFIFO_OVF_INT_ENA The interrupt enable bit for the I2C_TXFIFO_OVF_INT interrupt. (R/W)

I2C_RXFIFO_UDF_INT_ENA The interrupt enable bit for the I2C_RXFIFO_UDF_INT interrupt. (R/W)

I2C_SCL_ST_TO_INT_ENA The interrupt enable bit for the I2C_SCL_ST_TO_INT interrupt. (R/W)

I2C_SCL_MAIN_ST_TO_INT_ENA The interrupt enable bit for the I2C_SCL_MAIN_ST_TO_INT interrupt. (R/W)

I2C_DET_START_INT_ENA The interrupt enable bit for the I2C_DET_START_INT interrupt. (R/W)

I2C_SLAVE_STRETCH_INT_ENA The interrupt enable bit for the I2C_SLAVE_STRETCH_INT interrupt. (R/W)

I2C_GENERAL_CALL_INT_ENA The interrupt enable bit for the I2C_GENERAL_CALL_INT interrupt. (R/W)

Register 27.25. I2C_INT_STATUS_REG (0x002C)

(reserved)																		I2C_GENERAL_CALL_INT_ST	I2C_SLAVE_STRETCH_INT_ST	I2C_DET_START_INT_ST	I2C_SCL_MAIN_ST	I2C_SCL_ST_TO_INT_ST	I2C_RXFIFO_UDF_INT_ST	I2C_NACK_INT_ST	I2C_TRANS_OVF_INT_ST	I2C_TIME_START_INT_ST	I2C_TRANS_OUT_INT_ST	I2C_MST_TXFIFO_COMPLETE_INT_ST	I2C_ARBITRATION_LOST_INT_ST	I2C_BYTE_TRANS_DONE_INT_ST	I2C_END_DETECT_INT_ST	I2C_RXFIFO_OVF_INT_ST	I2C_RXFIFO_WM_INT_ST	I2C_RXFIFO_WM_INT_ST			
31																		18	17	16	15	14	13	12	11	10	9	8	7	6	5	4	3	2	1	0	Reset
0 0																																					

I2C_RXFIFO_WM_INT_ST The masked interrupt status bit for the I2C_RXFIFO_WM_INT interrupt. (RO)

I2C_TXFIFO_WM_INT_ST The masked interrupt status bit for the I2C_TXFIFO_WM_INT interrupt. (RO)

I2C_RXFIFO_OVF_INT_ST The masked interrupt status bit for the I2C_RXFIFO_OVF_INT interrupt. (RO)

I2C_END_DETECT_INT_ST The masked interrupt status bit for the I2C_END_DETECT_INT interrupt. (RO)

I2C_BYTE_TRANS_DONE_INT_ST The masked interrupt status bit for the I2C_BYTE_TRANS_DONE_INT interrupt. (RO)

I2C_ARBITRATION_LOST_INT_ST The masked interrupt status bit for the I2C_ARBITRATION_LOST_INT interrupt. (RO)

I2C_MST_TXFIFO_UDF_INT_ST The masked interrupt status bit for the I2C_MST_TXFIFO_UDF_INT interrupt. (RO)

I2C_TRANS_COMPLETE_INT_ST The masked interrupt status bit for the I2C_TRANS_COMPLETE_INT interrupt. (RO)

I2C_TIME_OUT_INT_ST The masked interrupt status bit for the I2C_TIME_OUT_INT interrupt. (RO)

I2C_TRANS_START_INT_ST The masked interrupt status bit for the I2C_TRANS_START_INT interrupt. (RO)

I2C_NACK_INT_ST The masked interrupt status bit for the I2C_SLAVE_STRETCH_INT interrupt. (RO)

I2C_TXFIFO_OVF_INT_ST The masked interrupt status bit for the I2C_TXFIFO_OVF_INT interrupt. (RO)

I2C_RXFIFO_UDF_INT_ST The masked interrupt status bit for the I2C_RXFIFO_UDF_INT interrupt. (RO)

Continued on the next page...

Register 27.25. I2C_INT_STATUS_REG (0x002C)

Continued from the previous page...

I2C_SCL_ST_TO_INT_ST The masked interrupt status bit for the I2C_SCL_ST_TO_INT interrupt. (RO)

I2C_SCL_MAIN_ST_TO_INT_ST The masked interrupt status bit for the I2C_SCL_MAIN_ST_TO_INT interrupt. (RO)

I2C_DET_START_INT_ST The masked interrupt status bit for the I2C_DET_START_INT interrupt. (RO)

I2C_SLAVE_STRETCH_INT_ST The masked interrupt status bit for the I2C_SLAVE_STRETCH_INT interrupt. (RO)

I2C_GENERAL_CALL_INT_ST The masked interrupt status bit for the I2C_GENARAL_CALL_INT interrupt. (RO)

Register 27.26. I2C_COMD0_REG (0x0058)

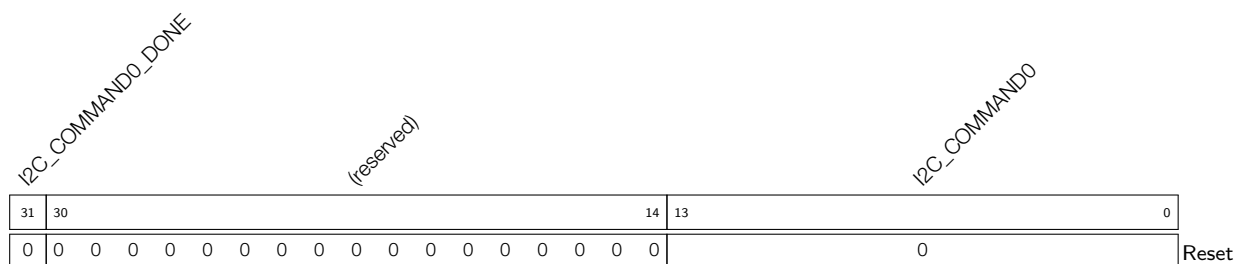

I2C_COMMAND0 This is the content of command register 0. It consists of three parts:

- op_code is the command. 0: RSTART; 1: WRITE; 2: READ; 3: STOP; 4: END.
- Byte_num represents the number of bytes that need to be sent or received.
- ack_check_en, ack_exp and ack are used to control the ACK bit. For more information, see Section 27.4.9.

(R/W)

I2C_COMMAND0_DONE When command 0 has been executed in master mode, this bit changes to high level. (R/W/SS)

Register 27.27. I2C_COMD1_REG (0x005C)

<i>I2C_COMMAND1_DONE</i>														<i>(reserved)</i>														<i>I2C_COMMAND1</i>													
31	30													14	13													0	Reset												
0														0														0													

I2C_COMMAND1 This is the content of command register 1. It is the same as that of [I2C_COMMAND0](#). (R/W)

I2C_COMMAND1_DONE When command 1 has been executed in master mode, this bit changes to high level. (R/W/SS)

Register 27.28. I2C_COMD2_REG (0x0060)

<i>I2C_COMMAND2_DONE</i>														<i>(reserved)</i>														<i>I2C_COMMAND2</i>													
31	30													14	13													0	Reset												
0														0														0													

I2C_COMMAND2 This is the content of command register 2. It is the same as that of [I2C_COMMAND0](#). (R/W)

I2C_COMMAND2_DONE When command 2 has been executed in master mode, this bit changes to high Level. (R/W/SS)

Register 27.29. I2C_COMD3_REG (0x0064)

<i>I2C_COMMAND3_DONE</i>														<i>(reserved)</i>														<i>I2C_COMMAND3</i>													
31	30													14	13													0	Reset												
0														0														0													

I2C_COMMAND3 This is the content of command register 3. It is the same as that of [I2C_COMMAND0](#). (R/W)

I2C_COMMAND3_DONE When command 3 has been executed in master mode, this bit changes to high level. (R/W/SS)

Register 27.30. I2C_COMD4_REG (0x0068)

<i>I2C_COMMAND4_DONE</i>																<i>(reserved)</i>																<i>I2C_COMMAND4</i>																
31																14	13																0															
0																0																0																Reset

I2C_COMMAND4 This is the content of command register 4. It is the same as that of [I2C_COMMAND0](#). (R/W)

I2C_COMMAND4_DONE When command 4 has been executed in master mode, this bit changes to high level. (R/W/SS)

Register 27.31. I2C_COMD5_REG (0x006C)

<i>I2C_COMMAND5_DONE</i>																<i>(reserved)</i>																<i>I2C_COMMAND5</i>																
31																14	13																0															
0																0																0																Reset

I2C_COMMAND5 This is the content of command register 5. It is the same as that of [I2C_COMMAND0](#). (R/W)

I2C_COMMAND5_DONE When command 5 has been executed in master mode, this bit changes to high level. (R/W/SS)

Register 27.32. I2C_COMD6_REG (0x0070)

<i>I2C_COMMAND6_DONE</i>																<i>(reserved)</i>																<i>I2C_COMMAND6</i>																
31																14	13																0															
0																0																0																Reset

I2C_COMMAND6 This is the content of command register 6. It is the same as that of [I2C_COMMAND0](#). (R/W)

I2C_COMMAND6_DONE When command 6 has been executed in master mode, this bit changes to high level. (R/W/SS)

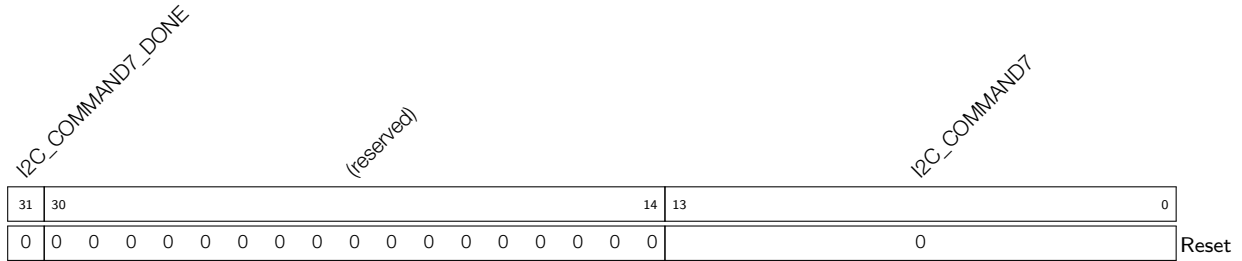
Register 27.33. I2C_COMD7_REG (0x0074)

I2C_COMMAND7 This is the content of command register 7. It is the same as that of [I2C_COMMAND0](#). (R/W)

I2C_COMMAND7_DONE When command 7 has been executed in master mode, this bit changes to high level. (R/W/SS)

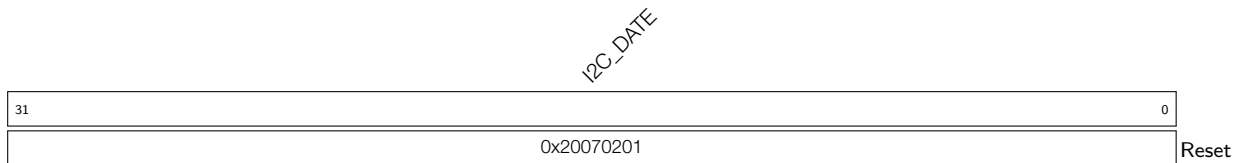
Register 27.34. I2C_DATE_REG (0x00F8)

I2C_DATE This is the version control register. (R/W)

28 I2S Controller (I2S)

28.1 Overview

ESP32-S3 has two built-in I2S interfaces (i.e. I2S0 and I2S1), which provides a flexible communication interface for streaming digital data in multimedia applications, especially digital audio applications.

The I2S standard bus defines three signals: a bit clock signal (BCK), a channel/word select signal (WS), and a serial data signal (SD). A basic I2S data bus has one master and one slave. The roles remain unchanged throughout the communication. The I2S module on ESP32-S3 provides separate transmit (TX) and receive (RX) units for high performance.

Note:

The information provided in this chapter applies to I2S0 and I2S1. Unless otherwise indicated, I2Sn or I2S in this chapter refer to both I2S0 and I2S1.

28.2 Terminology

To better illustrate the functionality of I2Sn, the following terms are used in this chapter.

- Master mode** As a master, I2Sn outputs BCK/WS signals, and sends data to or receives data from a slave.
- Slave mode** As a slave, I2Sn inputs BCK/WS signals, and receives data from or sends data to a master.
- Full-duplex** The sending line and receiving line between the master and the slave are independent. Sending data and receiving data happen at the same time.
- Half-duplex** Only one side, the master or the slave, sends data first, and the other side receives data. Sending data and receiving data can not happen at the same time.
- TDM RX mode** In this mode, pulse code modulated (PCM) data is received and stored into memory via DMA, in a way of time division multiplexing (TDM). The signal lines include: BCK, WS, and DATA. Data from 16 channels at most can be received. TDM Philips standard, TDM MSB alignment standard, TDM PCM standard are supported in this mode, depending on user configuration.
- PDM RX mode** In this mode, pulse density modulation (PDM) data is received and stored into memory via DMA. The signal lines include: WS and DATA. PDM standard is supported in this mode by user configuration.
- TDM TX mode** In this mode, pulse code modulated (PCM) data is sent from memory via DMA, in a way of time division multiplexing (TDM). The signal lines include: BCK, WS, and DATA. Data up to 16 channels can be sent. TDM Philips standard, TDM MSB alignment standard, TDM PCM standard are supported in this mode, depending on user configuration.

PDM TX mode	In this mode, pulse density modulation (PDM) data is sent from memory via DMA. The signal lines include: WS and DATA. PDM standard is supported in this mode by user configuration.
PCM-to-PDM TX mode (for I2S0 only)	In this mode, I2S0 as a master , converts the pulse code modulated (PCM) data from memory via DMA into pulse density modulation (PDM) data, and then sends the data out. The signal lines include: WS and DATA. PDM standard is supported in this mode by user configuration.
PDM-to-PCM RX mode (for I2S0 only)	In this mode, I2S0 works as a master or a slave . Pulse density modulation (PDM) data is received, converted into pulse code modulated (PCM) data, and then stored into memory via DMA. The signal lines include: WS and DATA. PDM standard is supported in this mode by user configuration.

28.3 Features

I2S n has the following features:

- Master mode and slave mode
- Full-duplex and half-duplex communications
- Separate TX unit and RX unit, independent of each other
- TX unit and RX unit to work independently and simultaneously
- A variety of audio standards supported:
 - TDM Philips standard
 - TDM MSB alignment standard
 - TDM PCM standard
 - PDM standard
- Various TX/RX modes supported:
 - TDM TX mode
 - TDM RX mode
 - PDM TX mode
 - PDM RX mode
 - PCM-to-PDM TX mode (for I2S0 only)
 - PDM-to-PCM RX mode (for I2S0 only)
- Configurable high-precision sample clock
- Various frequencies supported: 8 kHz, 16 kHz, 32 kHz, 44.1 kHz, 48 kHz, 88.2 kHz, 96 kHz, 128 kHz, and 192 kHz (192 kHz is not supported in 32-bit slave mode).
- 8-/16-/24-/32-bit data communication

- DMA access
- Standard I2S interface interrupts

28.4 System Architecture

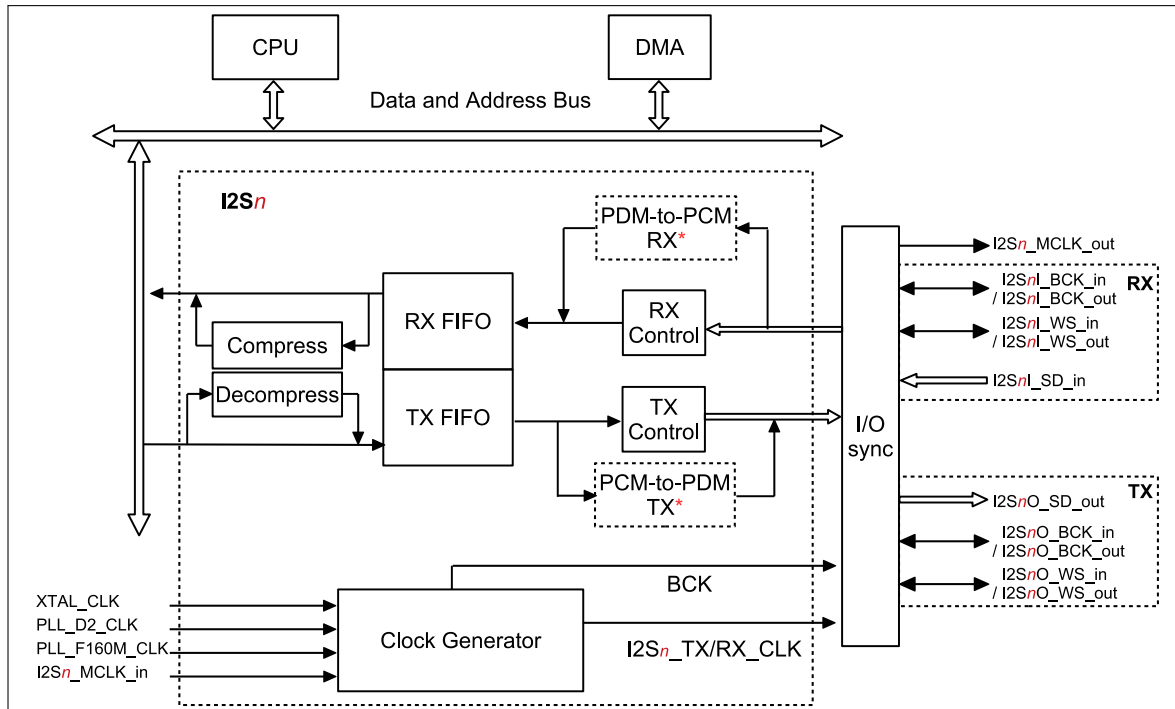

Note: PDM-to-PCM RX and PCM-to-PDM TX are only supported by I2S0.

Figure 28-1. ESP32-S3 I2S System Diagram

Figure 28-1 shows the structure of ESP32-S3 I2S n module, consisting of:

- TX unit (TX control)
- RX unit (RX control)
- Input and Output Timing unit (I/O sync)
- Clock Divider (Clock Generator)
- 64 x 32-bit TX FIFO
- 64 x 32-bit RX FIFO
- Compress/Decompress units

ESP32-S3 I2S n module supports direct access (GDMA) to internal memory and external memory, see Chapter 3 [GDMA Controller \(GDMA\)](#).

Both the TX unit and the RX unit have a three-line interface that includes a bit clock line (BCK), a word select line (WS), and a serial data line (SD). The SD line of the TX unit is fixed as output, and the SD line of the RX unit as input. BCK and WS signal lines for TX unit and RX unit can be configured as master output mode or slave input mode.

The signal bus of I2S n module is shown at the right part of Figure 28-1. The naming of these signals in RX and TX units follows the pattern: I2S n A_B_C, for example, I2S n I_BCK_in.

- “A”: direction of data bus
 - “I”: input, receiving
 - “O”: output, transmitting
- “B”: signal function
 - bit clock signal (BCK)
 - word select signal (WS)
 - serial data signal (SD)
- “C”: signal direction
 - “in”: input signal into I2S n module
 - “out”: output signal from I2S n module

Table 28-2 provides a detailed description of I2S n signals.

Table 28-2. I2S n Signal Description

Signal*	Direction	Function
I2S n I_BCK_in	Input	In slave mode, inputs BCK signal for RX unit.
I2S n I_BCK_out	Output	In master mode, outputs BCK signal for RX unit.
I2S n I_WS_in	Input	In slave mode, inputs WS signal for RX unit.
I2S n I_WS_out	Output	In master mode, outputs WS signal for RX unit.
I2S n I_Data_in	Input	Works as the serial input data bus for RX unit.
I2S n O_Data_out	Output	Works as the serial output data bus for TX unit.
I2S n O_BCK_in	Input	In slave mode, inputs BCK signal for TX unit.
I2S n O_BCK_out	Output	In master mode, outputs BCK signal for TX unit.
I2S n O_WS_in	Input	In slave mode, inputs WS signal for TX unit.
I2S n O_WS_out	Output	In master mode, outputs WS signal for TX unit.
I2S n _MCLK_in	Input	In slave mode, works as a clock source from the external master.
I2S n _MCLK_out	Output	In master mode, works as a clock source for the external slave.
I2S 0 I_Data1_in	Input	In PDM-to-PCM RX mode, works as the serial input data line for RX unit.
I2S 0 I_Data2_in	Input	In PDM-to-PCM RX mode, works as the serial input data line for RX unit.
I2S 0 I_Data3_in	Input	In PDM-to-PCM RX mode, works as the serial input data line for RX unit.
I2S 0 O_Data1_out	Output	In PCM-to-PDM TX mode, works as the serial output data line for TX unit.

* Any required signals of I2S n must be mapped to the chip’s pins via GPIO matrix, see Chapter 6 *IO MUX and GPIO Matrix (GPIO, IO MUX)*.

28.5 Supported Audio Standards

ESP32-S3 I2S n supports multiple audio standards, including TDM Philips standard, TDM MSB alignment standard, TDM PCM standard, and PDM standard.

Select the standard by configuring the following bits:

- [I2S_TX/RX_TDM_EN](#)
 - 0: disable TDM mode.
 - 1: enable TDM mode.
- [I2S_TX/RX_PDM_EN](#)
 - 0: disable PDM mode.
 - 1: enable PDM mode.
- [I2S_TX/RX_MSB_SHIFT](#)
 - 0: WS and SD signals change simultaneously, i.e. enable MSB alignment standard.
 - 1: WS signal changes one BCK clock cycle earlier than SD signal, i.e. enable Philips standard or select PCM standard.
- [I2S_TX/RX_PCM_BYPASS](#)
 - 0: enable PCM standard.
 - 1: disable PCM standard.

28.5.1 TDM Philips Standard

Philips specifications require that WS signal changes one BCK clock cycle earlier than SD signal on BCK falling edge, which means that WS signal is valid from one clock cycle before transmitting the first bit of channel data and changes one clock before the end of channel data transfer. SD signal line transmits the most significant bit of audio data first.

Compared with Philips standard, TDM Philips standard supports multiple channels, see Figure 28-2.

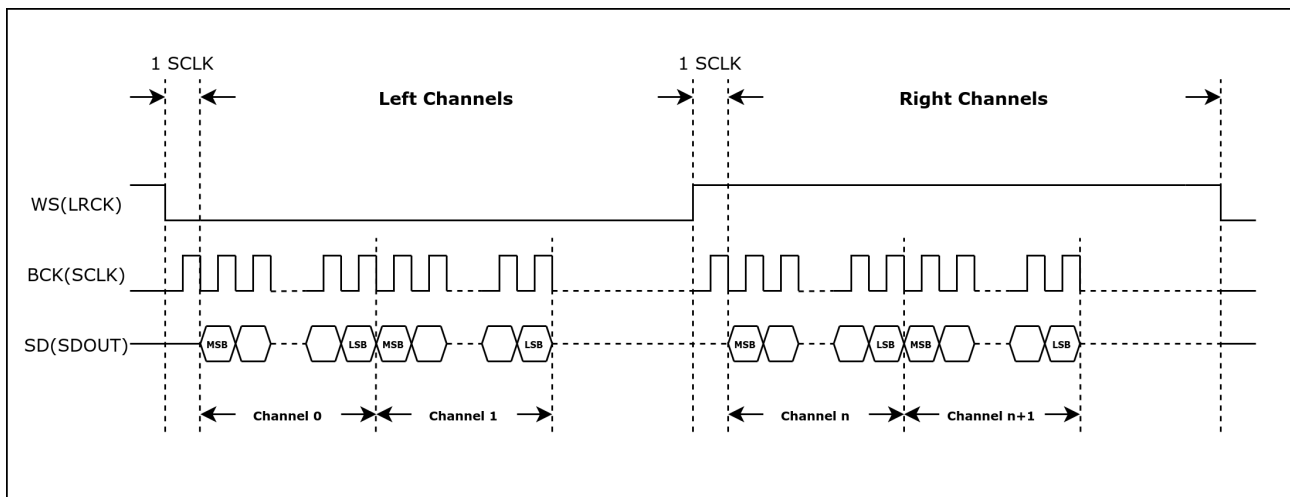

Figure 28-2. TDM Philips Standard Timing Diagram

28.5.2 TDM MSB Alignment Standard

MSB alignment specifications require WS and SD signals change simultaneously on the falling edge of BCK. The WS signal is valid until the end of channel data transfer. The SD signal line transmits the most significant bit of audio data first.

Compared with MSB alignment standard, TDM MSB alignment standard supports multiple channels, see Figure 28-3.

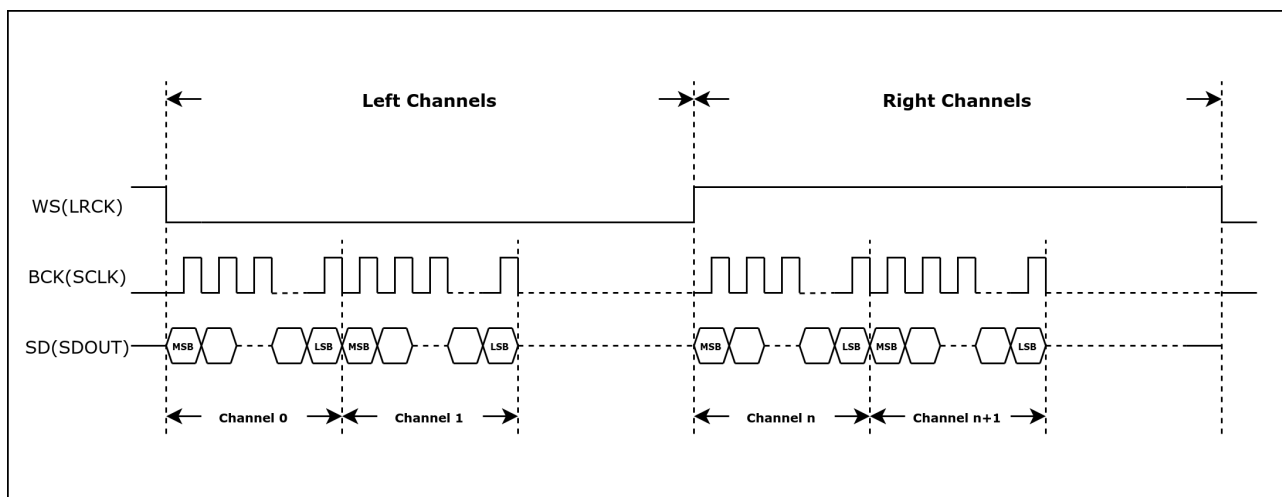

Figure 28-3. TDM MSB Alignment Standard Timing Diagram

28.5.3 TDM PCM Standard

Short frame synchronization under PCM standard requires WS signal changes one BCK clock cycle earlier than SD signal on the falling edge of BCK, which means that the WS signal becomes valid one clock cycle before transferring the first bit of channel data and remains unchanged in this BCK clock cycle. SD signal line transmits the most significant bit of audio data first.

Compared with PCM standard, TDM PCM standard supports multiple channels, see Figure 28-4.

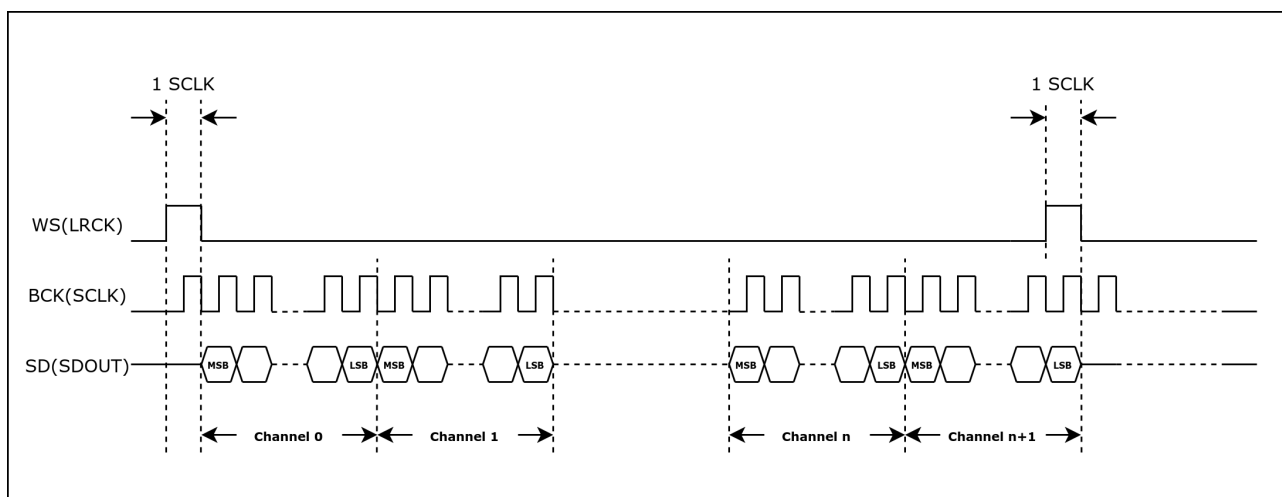

Figure 28-4. TDM PCM Standard Timing Diagram

28.5.4 PDM Standard

Under PDM standard, WS signal changes continuously during data transmission. The low-level and high-level of this signal indicates the left channel and right channel, respectively. WS and SD signals change simultaneously on the falling edge of BCK, see Figure 28-5.

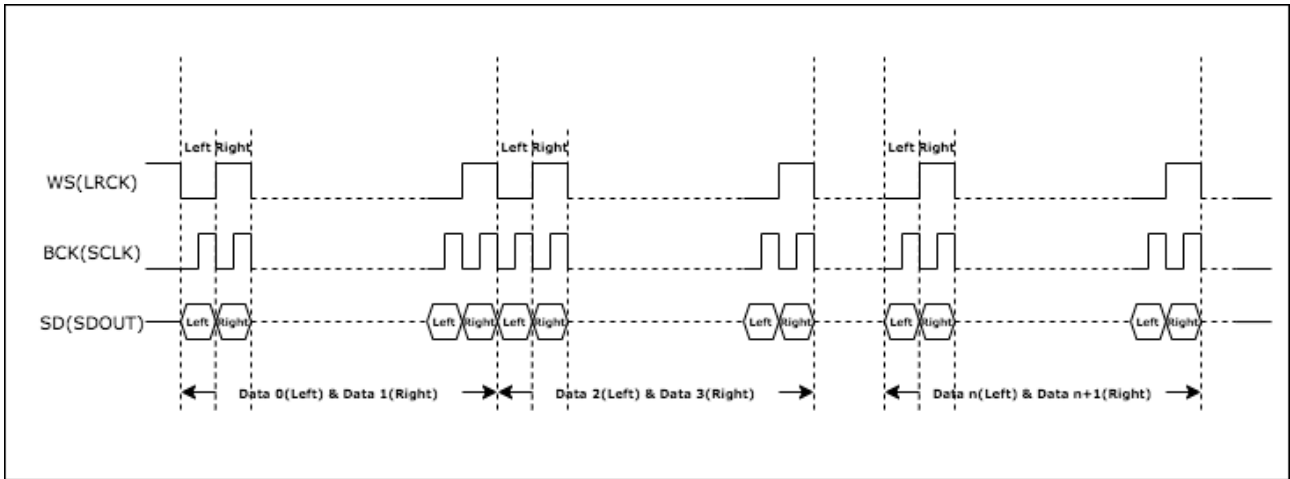

Figure 28-5. PDM Standard Timing Diagram

28.6 TX/RX Clock

I2S_n_TX/RX_CLK as shown in Figure 28-6 is the master clock of I2S_n TX/RX unit, divided from:

- 40 MHz XTAL_CLK
- 160 MHz PLL_F160M_CLK
- 240 MHz PLL_D2_CLK
- or external input clock: I2S_n_MCLK_in

I2S_TX/RX_CLK_SEL is used to select clock source for TX/RX unit, and I2S_TX/RX_CLK_ACTIVE to enable or disable the clock source.

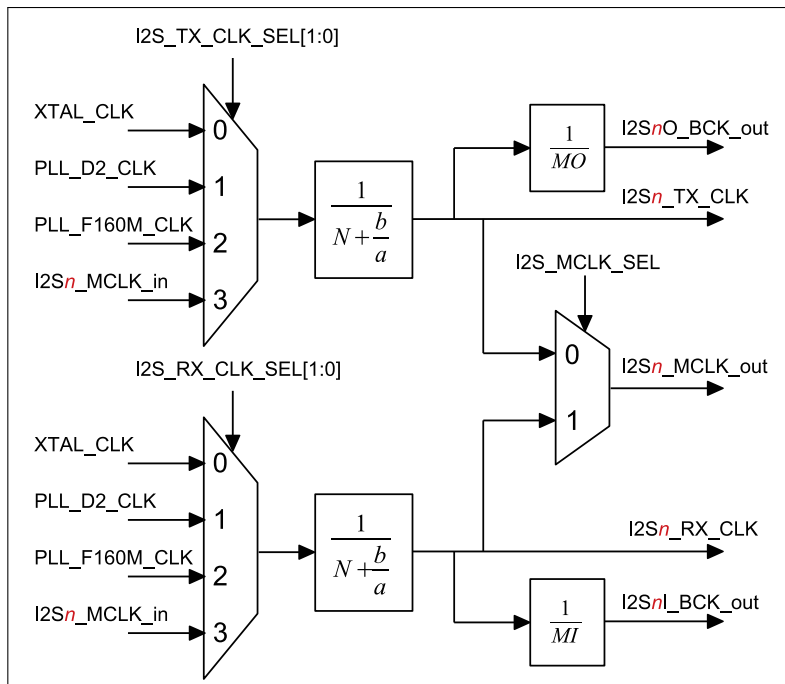

Figure 28-6. I2S_n Clock

The following formula shows the relation between I2S_n_TX/RX_CLK frequency ($f_{I2S_n_TX/RX_CLK}$) and the divider

clock source frequency ($f_{I2S_n_CLK_S}$):

$$f_{I2S_n_TX/RX_CLK} = \frac{f_{I2S_n_CLK_S}}{N + \frac{b}{a}}$$

N is an integer value between 2 and 256. The value of N corresponds to the value of [I2S_TX/RX_CLKM_DIV_NUM](#) in register [I2S_TX/RX_CLKM_CONF_REG](#) as follows:

- When [I2S_TX/RX_CLKM_DIV_NUM](#) = 0, N = 256.
- When [I2S_TX/RX_CLKM_DIV_NUM](#) = 1, N = 2.
- When [I2S_TX/RX_CLKM_DIV_NUM](#) has any other value, N = [I2S_TX/RX_CLKM_DIV_NUM](#).

The values of “a” and “b” in fractional divider depend only on x, y, z, and yn1. The corresponding formulas are as follows:

- When $b \leq \frac{a}{2}$, $yn1 = 0$, $x = \text{floor}(\lceil \frac{a}{b} \rceil) - 1$, $y = a \% b$, $z = b$;
- When $b > \frac{a}{2}$, $yn1 = 1$, $x = \text{floor}(\lceil \frac{a}{a-b} \rceil) - 1$, $y = a \% (a - b)$, $z = a - b$.

The values of x, y, z, and yn1 are configured in [I2S_TX/RX_CLKM_DIV_X](#), [I2S_TX/RX_CLKM_DIV_Y](#), [I2S_TX/RX_CLKM_DIV_Z](#), and [I2S_TX/RX_CLKM_DIV_YN1](#).

To configure the integer divider, clear [I2S_TX/RX_CLKM_DIV_X](#) and [I2S_TX/RX_CLKM_DIV_Z](#), then set [I2S_TX/RX_CLKM_DIV_Y](#) to 1.

Note:

Using fractional divider may introduce some clock jitter.

The serial clock (BCK) of the I2S_n TX/RX unit is divided from I2S_n_TX/RX_CLK, as shown in Figure 28-6.

In master TX mode, the serial clock BCK for I2S_n TX unit is I2S_nO_BCK_out, divided from I2S_n_TX_CLK. That is:

$$f_{I2S_nO_BCK_out} = \frac{f_{I2S_n_TX_CLK}}{MO}$$

“MO” is an integer value:

$$MO = \text{I2S_TX_BCK_DIV_NUM} + 1$$

Note:

[I2S_TX_BCK_DIV_NUM](#) must not be configured as 1.

In master RX mode, the serial clock BCK for I2S_n RX unit is I2S_nI_BCK_out, divided from I2S_n_RX_CLK. That is:

$$f_{I2S_nI_BCK_out} = \frac{f_{I2S_n_RX_CLK}}{MI}$$

“MI” is an integer value:

$$MI = \text{I2S_RX_BCK_DIV_NUM} + 1$$

Note:

- [I2S_RX_BCK_DIV_NUM](#) must not be configured as 1.

- In slave mode, make sure $f_{I2S_n_TX/RX_CLK} \geq 8 * f_{BCK}$. I2S n module can output I2S n_MCLK_out as the master clock for peripherals.

28.7 I2S n Reset

The units and FIFOs in I2S n module are reset by the following bits.

- I2S n TX/RX units: reset by the bits [I2S_TX_RESET](#) and [I2S_RX_RESET](#).
- I2S n TX/RX FIFO: reset by the bits [I2S_TX_FIFO_RESET](#) and [I2S_RX_FIFO_RESET](#).

Note: I2S n module clock must be configured first before the module and FIFO are reset.

28.8 I2S n Master/Slave Mode

The ESP32-S3 I2S n module can operate as a master or a slave, depending on the configuration of [I2S_TX_SLAVE_MOD](#) and [I2S_RX_SLAVE_MOD](#).

- [I2S_TX_SLAVE_MOD](#)
 - 0: master TX mode
 - 1: slave TX mode
- [I2S_RX_SLAVE_MOD](#)
 - 0: master RX mode
 - 1: slave RX mode

28.8.1 Master/Slave TX Mode

- I2S n works as a master transmitter:
 - Set the bit [I2S_TX_START](#) to start transmitting data.
 - TX unit keeps driving the clock signal and serial data.
 - If [I2S_TX_STOP_EN](#) is set and all the data in FIFO is transmitted, the master stops transmitting data.
 - If [I2S_TX_STOP_EN](#) is cleared and all the data in FIFO is transmitted, meanwhile no new data is filled into FIFO, then the TX unit keeps sending the last data frame.
 - Master stops sending data when the bit [I2S_TX_START](#) is cleared.
- I2S n works as a slave transmitter:
 - Set the bit [I2S_TX_START](#).
 - Wait for the master BCK clock to enable a transmit operation.
 - If [I2S_TX_STOP_EN](#) is set and all the data in FIFO is transmitted, then the slave keeps sending zeros, till the master stops providing BCK signal.
 - If [I2S_TX_STOP_EN](#) is cleared and all the data in FIFO is transmitted, meanwhile no new data is filled into FIFO, then the TX unit keeps sending the last data frame.
 - If [I2S_TX_START](#) is cleared, slave keeps sending zeros till the master stops providing BCK clock signal.

28.8.2 Master/Slave RX Mode

- I2S n works as a master receiver:
 - Set the bit [I2S_RX_START](#) to start receiving data.
 - RX unit keeps outputting clock signal and sampling input data.
 - RX unit stops receiving data when the bit [I2S_RX_START](#) is cleared.
- I2S n works as a slave receiver:
 - Set the bit [I2S_RX_START](#).
 - Wait for master BCK signal to start receiving data.
 - RX unit stops receiving data when the bit [I2S_RX_START](#) is cleared.

28.9 Transmitting Data

Note:

Updating the configuration described in this and subsequent sections requires to set [I2S_TX_UPDATE](#) accordingly, to synchronize I2S n TX registers from APB clock domain to TX clock domain. For more detailed configuration, see Section [28.11.1](#).

In TX mode, I2S n first reads data from DMA and sends these data out via output signals according to the configured data mode and channel mode.

28.9.1 Data Format Control

Data format is controlled in the following phases:

- Phase I: read data from memory and write it to TX FIFO.
- Phase II: read the data to send (TX data) from TX FIFO and convert the data according to output data mode.
- Phase III: clock out the TX data serially.

28.9.1.1 Bit Width Control of Channel Valid Data

The bit width of valid data in each channel is determined by [I2S_TX_BITS_MOD](#) and [I2S_TX_24_FILL_EN](#), see the table below.

Table 28-3. Bit Width of Channel Valid Data

Channel Valid Data Width	I2S_TX_BITS_MOD	I2S_TX_24_FILL_EN
32	31	x ¹
	23	1
24	23	0
16	15	x
8	7	x

¹ x: This value is ignored.

28.9.1.2 Endian Control of Channel Valid Data

When I2S n reads data from DMA, the data endian under various data width is controlled by `I2S_TX_BIG_ENDIAN`, see the table below.

Table 28-4. Endian of Channel Valid Data

Channel Valid Data Width	Origin Data	Endian of Processed Data	<code>I2S_TX_BIG_ENDIAN</code>
32	{B3, B2, B1, B0}	{B3, B2, B1, B0}	0
		{B0, B1, B2, B3}	1
24	{B2, B1, B0}	{B2, B1, B0}	0
		{B0, B1, B2}	1
16	{B1, B0}	{B1, B0}	0
		{B0, B1}	1
8	{B0}	{B0}	x

28.9.1.3 A-law/ μ -law Compression and Decompression

ESP32-S3 I2S n compresses/decompresses the valid data into 32-bit by A-law or by μ -law. If the bit width of valid data is smaller than 32, zeros are filled to the extra high bits of the data to be compressed/decompressed by default.

Note:

Extra high bits here mean the bits[31: channel valid data width] of the data to be compressed/decompressed.

Configure `I2S_TX_PCM_BYPASS` to:

- 0, do not compress or decompress the data.
- 1, compress or decompress the data.

Configure `I2S_TX_PCM_CONF` to:

- 0, decompress the data using A-law.
- 1, compress the data using A-law.
- 2, decompress the data using μ -law.
- 3, compress the data using μ -law.

At this point, the first phase of data format control is complete.

28.9.1.4 Bit Width Control of Channel TX Data

The TX data width in each channel is determined by `I2S_TX_TDM_CHAN_BITS`.

- If TX data width in each channel is larger than the valid data width, zeros will be filled to these extra bits.

Configure `I2S_TX_LEFT_ALIGN` to:

- 0, the valid data is at the lower bits of TX data.

- 1, the valid data is at the higher bits of TX data.
- If the TX data width in each channel is smaller than the valid data width, only the lower bits of valid data are sent out, and the higher bits are discarded.

At this point, the second phase of data format control is complete.

28.9.1.5 Bit Order Control of Channel Data

The data bit order in each channel is controlled by `I2S_TX_BIT_ORDER`:

- 1, data is sent out from low bits to high bits.
- 0, data is sent out from high bits to low bits.

At this point, the data format control is complete. Figure 28-7 shows a complete process of TX data format control.

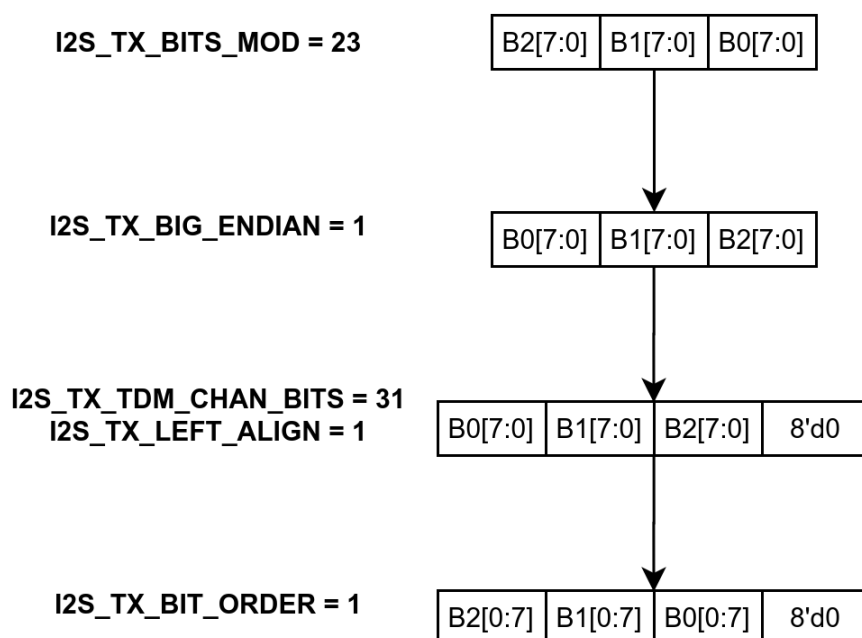

Figure 28-7. TX Data Format Control

28.9.2 Channel Mode Control

ESP32-S3 I2S n supports both TDM TX mode and PDM TX mode. Set `I2S_TX_TDM_EN` to enable TDM TX mode, or set `I2S_TX_PDM_EN` to enable PDM TX mode.

Note:

- `I2S_TX_TDM_EN` and `I2S_TX_PDM_EN` must not be cleared or set simultaneously.
- Most stereo I2S codecs can be controlled by setting the I2S n module into 2-channel mode under TDM standard.

28.9.2.1 I2S_n Channel Control in TDM Mode

In TDM mode, I2S_n supports up to 16 channels to output data. The total number of TX channels in use is controlled by `I2S_TX_TDM_TOT_CHAN_NUM`. For example, if `I2S_TX_TDM_TOT_CHAN_NUM` is set to 5, six channels in total (channel 0 ~ 5) will be used to transmit data, see Figure 28-8.

In these TX channels, if `I2S_TX_TDM_CHANn_EN` is set to:

- 1, this channel sends the channel data out.
- 0, the TX data to be sent by this channel is controlled by `I2S_TX_CHAN_EQUAL`:
 - 1, the data of previous channel is sent out.
 - 0, the data stored in `I2S_SINGLE_DATA` is sent out.

In TDM master mode, WS signal is controlled by `I2S_TX_WS_IDLE_POL` and `I2S_TX_TDM_WS_WIDTH`:

- `I2S_TX_WS_IDLE_POL`: the default level of WS signal
- `I2S_TX_TDM_WS_WIDTH`: the cycles the WS default level lasts for when transmitting all channel data

`I2S_TX_HALF_SAMPLE_BITS` x 2 is equal to the BCK cycles in one WS period.

TDM Channel Configuration Example

In this example, the register configuration is as follows.

- `I2S_TX_TDM_TOT_CHAN_NUM` = 5, i.e. channel 0 ~ 5 are used to transmit data.
- `I2S_TX_CHAN_EQUAL` = 1, i.e. that data of previous channel will be transmitted if the bit `I2S_TX_TDM_CHANn_EN` is cleared. $n = 0 \sim 5$.
- `I2S_TX_TDM_CHAN0/2/5_EN` = 1, i.e. these channels send their channel data out.
- `I2S_TX_TDM_CHAN1/3/4_EN` = 0, i.e. these channels send the previous channel data out.

Once the configuration is done, data is transmitted as follows.

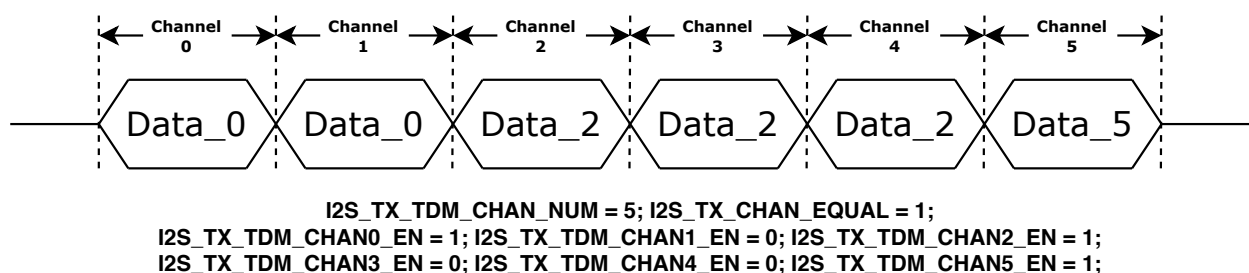

Figure 28-8. TDM Channel Control

28.9.2.2 I2S_n Channel Control in PDM Mode

In PDM mode, fetching data from DMA is controlled by `I2S_TX_MONO` and `I2S_TX_MONO_FST_VLD`, see the table below. Please configure the two bits according to the data stored in memory, be it the single-channel or dual-channel data.

Table 28-5. Data-Fetching Control in PDM Mode

Data-Fetching Control Option	Mode	I2S_TX_MONO	I2S_TX_MONO_FST_VLD
Post data-fetching request to DMA at any edge of WS signal	Stereo mode	0	x
Post data-fetching request to DMA only at the second half period of WS signal	Mono mode	1	0
Post data-fetching request to DMA only at the first half period of WS signal	Mono mode	1	1

In PDM mode, I2S n channel mode is controlled by [I2S_TX_CHAN_MOD](#) and [I2S_TX_WS_IDLE_POL](#), see the table below.

Table 28-6. I2S n Channel Control in PDM Mode

Channel Control Option	Left Channel	Right Channel	Mode Control Field ¹	Channel Select Bit ²
Stereo mode	Transmit the left channel data	Transmit the right channel data	0	x
Mono mode	Transmit the left channel data	Transmit the left channel data	1	0
	Transmit the right channel data	Transmit the right channel data	1	1
	Transmit the right channel data	Transmit the right channel data	2	0
	Transmit the left channel data	Transmit the left channel data	2	1
	Transmit the value of I2S_SINGLE_DATA	Transmit the right channel data	3	0
	Transmit the left channel data	Transmit the value of I2S_SINGLE_DATA	3	1
	Transmit the left channel data	Transmit the value of I2S_SINGLE_DATA	4	0
	Transmit the value of I2S_SINGLE_DATA	Transmit the right channel data	4	1

¹ [I2S_TX_CHAN_MOD](#)

² [I2S_TX_WS_IDLE_POL](#)

In PDM master mode, the WS level of I2S n module is controlled by [I2S_TX_WS_IDLE_POL](#). The frequency of WS signal is half of BCK frequency. The configuration of WS signal is similar to that of BCK signal, see Section 28.6 and Figure 28-9.

ESP32-S3 I2S0 also supports PCM-to-PDM output mode, in which the PCM data from DMA is converted to PDM data and then output in PDM signal format. Configure [I2S_PCM2PDM_CONV_EN](#) to enable this mode.

The register configuration for PCM-to-PDM output mode is as follows:

- Configure 1-line PDM output format or 1-/2-line DAC output mode as the table below:

Table 28-7. PCM-to-PDM Output Mode

Channel Output Format	I2S0_TX_PDM_DAC_MODE_EN	I2S0_TX_PDM_DAC_2OUT_EN
1-line PDM output format ¹	0	x
1-line DAC output format ²	1	0
2-line DAC output format	1	1

¹ In PDM output format, SD data of two channels is sent out in one WS period.

² In DAC output format, SD data of one channel is sent out in one WS period.

- Configure sampling frequency and upsampling rate
In PCM-to-PDM mode, PDM clock frequency is equal to BCK frequency. The relation of sampling frequency (f_{Sampling}) and BCK frequency is as follows:

$$f_{\text{Sampling}} = \frac{f_{\text{BCK}}}{\text{OSR}}$$

Upsampling rate (OSR) is related to I2S0_TX_PDM_SINC_OSR2 as follows:

$$\text{OSR} = \text{I2S0_TX_PDM_SINC_OSR2} \times 64$$

Sampling frequency f_{Sampling} is related to I2S_TX_PDM_FS as follows:

$$f_{\text{Sampling}} = \text{I2S0_TX_PDM_FS} \times 100$$

Configure the registers according to needed sampling frequency, upsampling rate, and PDM clock frequency.

PDM Channel Configuration Example

In this example, the register configuration is as follows.

- I2S_TX_CHAN_MOD = 2, i.e. mono mode is selected.
- I2S_TX_WS_IDLE_POL = 1, i.e. both the left channel and right channel transmit the left channel data.

Once the configuration is done, the channel data is transmitted as follows.

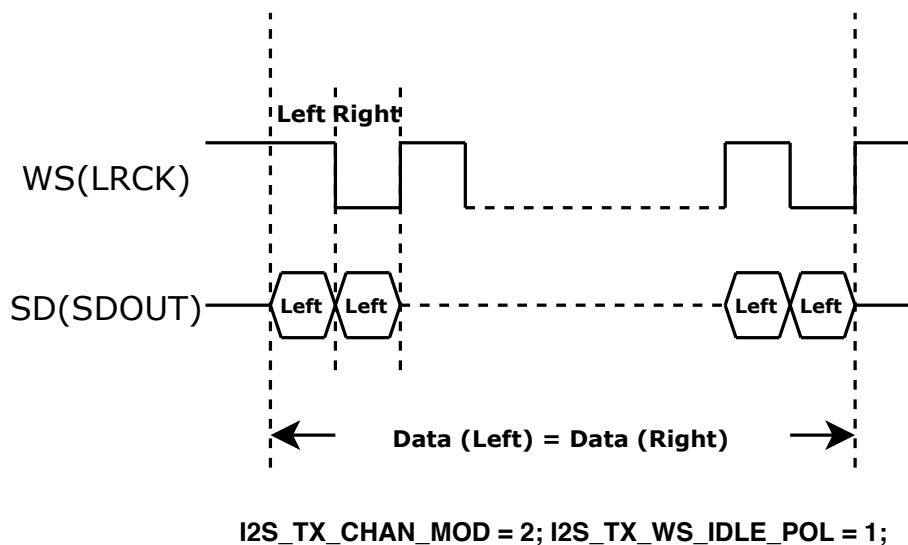

Figure 28-9. PDM Channel Control

28.10 Receiving Data

Note:

Updating the configuration described in this and subsequent sections requires to set `I2S_RX_UPDATE` accordingly, to synchronize `I2Sn` RX registers from APB clock domain to RX clock domain. For more detailed configuration, see Section 28.11.2.

In RX mode, `I2Sn` first reads data from peripheral interface, and then stores the data into memory via DMA, according to the configured channel mode and data mode.

28.10.1 Channel Mode Control

ESP32-S3 `I2Sn` supports both TDM RX mode and PDM RX mode. Set `I2S_RX_TDM_EN` to enable TDM RX mode, or set `I2S_RX_PDM_EN` to enable PDM RX mode.

Note `I2S_RX_TDM_EN` and `I2S_RX_PDM_EN` must not be cleared or set simultaneously.

28.10.1.1 I2S_n Channel Control in TDM Mode

In TDM mode, `I2Sn` supports up to 16 channels to input data. The total number of RX channels in use is controlled by `I2S_RX_TDM_TOT_CHAN_NUM`. For example, if `I2S_RX_TDM_TOT_CHAN_NUM` is set to 5, channel 0 ~ 5 will be used to receive data.

In these RX channels, if `I2S_RX_TDM_CHANn_EN` is set to:

- 1, this channel data is valid and will be stored into RX FIFO.
- 0, this channel data is invalid and will not be stored into RX FIFO.

In TDM master mode, WS signal is controlled by `I2S_RX_WS_IDLE_POL` and `I2S_RX_TDM_WS_WIDTH`:

- `I2S_RX_WS_IDLE_POL`: the default level of WS signal
- `I2S_RX_TDM_WS_WIDTH`: the cycles the WS default level lasts for when receiving all channel data

`I2S_RX_HALF_SAMPLE_BITS` x 2 is equal to the BCK cycles in one WS period.

28.10.1.2 I2S n Channel Control in PDM Mode

In PDM mode, I2S n converts the serial data from channels to the data to be entered into memory.

In PDM master mode, the WS level of I2S n module is controlled by `I2S_RX_WS_IDLE_POL`. WS frequency is half of BCK frequency. The configuration of BCK signal is similar to that of WS signal as described in Section 28.6.

Note, in PDM RX mode, the value of `I2S_RX_HALF_SAMPLE_BITS` must be same as that of `I2S_RX_BITS_MOD`.

I2S0 supports PDM-to-PCM input mode, in which the received PDM data is converted to PCM data and controlled according to the data mode. Configure `I2S_RX_PDM2PCM_EN` to enable this mode.

The register configuration for PDM-to-PCM input mode is as follows:

- Configure sampling frequency and downsampling rate.
In PDM-to-PCM input mode, PDM clock frequency is:
 - in master mode: PDM clock frequency is equal to BCK frequency.
 - in slave mode: PDM clock is provided by external device.

The sampling frequency (f_{Sampling}) is related to PDM clock frequency as follows:

$$f_{\text{Sampling}} = \frac{f_{\text{PDM}}}{\text{DSR}}$$

Downsampling rate (DSR) is related to `I2S0_RX_PDM_SINC_DSR_16_EN` as follows:

$$\text{DSR} = \text{I2S0_RX_PDM_SINC_DSR_16_EN} \times 64$$

Configure the registers according to needed master/slave mode, sampling frequency, and downsampling rate.

- Configure valid channels.
In PDM-to-PCM mode, input signals from eight channels are supported at most. See Table 28-8 for the register configuration and related channels.

Table 28-8. PDM-to-PCM Input Mode

Input Data Signal	Channel	Enable Register
I2S0I_Data_in	Left channel	<code>I2S0_RX_TDM_PDM_CHAN0_EN</code>
	Right channel	<code>I2S0_RX_TDM_PDM_CHAN1_EN</code>
I2S0I1_Data_in	Left channel	<code>I2S0_RX_TDM_PDM_CHAN2_EN</code>
	Right channel	<code>I2S0_RX_TDM_PDM_CHAN3_EN</code>
I2S0I2_Data_in	Left channel	<code>I2S0_RX_TDM_PDM_CHAN4_EN</code>
	Right channel	<code>I2S0_RX_TDM_PDM_CHAN5_EN</code>
I2S0I3_Data_in	Left channel	<code>I2S0_RX_TDM_PDM_CHAN6_EN</code>
	Right channel	<code>I2S0_RX_TDM_PDM_CHAN7_EN</code>

28.10.2 Data Format Control

Data format is controlled in the following phases:

- Phase I: serial input data is converted into the data to be saved to RX FIFO.
- Phase II: the data is read from RX FIFO and converted according to input data mode.

28.10.2.1 Bit Order Control of Channel Data

The data bit order in each channel is controlled by [I2S_RX_BIT_ORDER](#):

- 1, serial data is entered from low bits to high bits.
- 0, serial data is entered from high bits to low bits.

At this point, the first phase of data format control is complete.

28.10.2.2 Bit Width Control of Channel Storage (Valid) Data

The storage data width in each channel is controlled by [I2S_RX_BITS_MOD](#) and [I2S_RX_24_FILL_EN](#), see the table below.

Table 28-9. Channel Storage Data Width

Channel Storage Data Width	I2S_RX_BITS_MOD	I2S_RX_24_FILL_EN
32	31	x
	23	1
24	23	0
16	15	x
8	7	x

28.10.2.3 Bit Width Control of Channel RX Data

The RX data width in each channel is determined by [I2S_RX_TDM_CHAN_BITS](#).

- If the storage data width in each channel is smaller than the received (RX) data width, then only the bits within the storage data width is saved into memory. Configure [I2S_RX_LEFT_ALIGN](#) to:
 - 0, only the lower bits of the received data within the storage data width is stored to memory.
 - 1, only the higher bits of the received data within the storage data width is stored to memory.
- If the received data width is smaller than the storage data width in each channel, the higher bits of the received data will be filled with zeros and then the data is saved to memory.

28.10.2.4 Endian Control of Channel Storage Data

The received data is then converted into storage data (to be stored to memory) after some processing, such as discarding extra bits or filling zeros in missing bits. The endian of the storage data is controlled by [I2S_RX_BIG_ENDIAN](#) under various data width, see the table below.

Table 28-10. Channel Storage Data Endian

Channel Storage Data Width	Origin Data	Endian of Processed Data	I2S_RX_BIG_ENDIAN
32	{B3, B2, B1, B0}	{B3, B2, B1, B0}	0
		{B0, B1, B2, B3}	1
24	{B2, B1, B0}	{B2, B1, B0}	0
		{B0, B1, B2}	1
16	{B1, B0}	{B1, B0}	0
		{B0, B1}	1
8	{B0}	{B0}	x

28.10.2.5 A-law/ μ -law Compression and Decompression

ESP32-S3 I2S n compresses/decompresses the data to be stored in 32-bit by A-law or by μ -law. By default, zeros are filled to high bits.

Configure `I2S_RX_PCM_BYPASS` to:

- 0, do not compress or decompress the data.
- 1, compress or decompress the data.

Configure `I2S_RX_PCM_CONF` to:

- 0, decompress the data using A-law.
- 1, compress the data using A-law.
- 2, decompress the data using μ -law.
- 3, compress the data using μ -law.

At this point, the data format control is complete. Data then is stored into memory via DMA.

28.11 Software Configuration Process

28.11.1 Configure I2S n as TX Mode

Follow the steps below to configure I2S n as TX mode via software:

1. Configure the clock as described in Section 28.6.
2. Configure signal pins according to Table 28-2.
3. Select the mode needed by configuring the bit `I2S_TX_SLAVE_MOD`.
 - 0: master TX mode
 - 1: slave TX mode
4. Set needed TX data mode and TX channel mode as described in Section 28.9, and then set the bit `I2S_TX_UPDATE`.
5. Reset TX unit and TX FIFO as described in Section 28.7.
6. Enable corresponding interrupts, see Section 28.12.

7. Configure DMA outlink.
8. Set [I2S_TX_STOP_EN](#) if needed. For more information, please refer to Section [28.8.1](#).
9. Start transmitting data:
 - In master mode, wait till I2S n slave gets ready, then set [I2S_TX_START](#) to start transmitting data.
 - In slave mode, set the bit [I2S_TX_START](#). When the I2S n master supplies BCK and WS signals, I2S n slave starts transmitting data.
10. Wait for the interrupt signals set in Step [6](#), or check whether the transfer is completed by querying [I2S_TX_IDLE](#):
 - 0: transmitter is working.
 - 1: transmitter is in idle.
11. Clear [I2S_TX_START](#) to stop data transfer.

28.11.2 Configure I2S n as RX Mode

Follow the steps below to configure I2S n as RX mode via software:

1. Configure the clock as described in Section [28.6](#).
2. Configure signal pins according to Table [28-2](#).
3. Select the mode needed by configuring the bit [I2S_RX_SLAVE_MOD](#).
 - 0: master RX mode
 - 1: slave RX mode
4. Set needed RX data mode and RX channel mode as described in Section [28.10](#), and then set the bit [I2S_RX_UPDATE](#).
5. Reset RX unit and its FIFO according to Section [28.7](#).
6. Enable corresponding interrupts, see Section [28.12](#).
7. Configure DMA inlink, and set the length of RX data in [I2S_RXEOF_NUM_REG](#).
8. Start receiving data:
 - In master mode, when the slave is ready, set [I2S_RX_START](#) to start receiving data.
 - In slave mode, set [I2S_RX_START](#) to start receiving data when get BCK and WS signals from the master.
9. The received data is then stored to the specified address of ESP32-S3 memory according the configuration of DMA. Then the corresponding interrupt set in Step [6](#) is generated.

28.12 I2S n Interrupts

- [I2S_TX_HUNG_INT](#): triggered when transmitting data is timed out. For example, if I2S n module is configured as TX slave mode, but the master does not provide BCK or WS signal for time specified in [I2S_LC_HUNG_CONF_REG](#), then this interrupt will be triggered.

- I2S_RX_HUNG_INT: triggered when receiving data is timed out. For example, if I2S_n module is configured as RX slave mode, but the master does not send data for time specified in I2S_LC_HUNG_CONF_REG, then this interrupt will be triggered.
- I2S_TX_DONE_INT: triggered when transmitting data is completed.
- I2S_RX_DONE_INT: triggered when receiving data is completed.

28.13 Register Summary

The addresses in this section are relative to [I2S_n] base address provided in Table 4-3 in Chapter 4 *System and Memory*.

The abbreviations given in Column **Access** are explained in Section [Access Types for Registers](#).

Name	Description	I2S0 Ad- dress	I2S1 Ad- dress	Access
Interrupt registers				
I2S_INT_RAW_REG	Interrupt raw register	0x000C	0x000C	RO/WTC/SS
I2S_INT_ST_REG	Interrupt status register	0x0010	0x0010	RO
I2S_INT_ENA_REG	Interrupt enable register	0x0014	0x0014	R/W
I2S_INT_CLR_REG	Interrupt clear register	0x0018	0x0018	WT
RX/TX control and configuration registers				
I2S_RX_CONF_REG	RX configuration register	0x0020	0x0020	varies
I2S_RX_CONF1_REG	RX configuration register 1	0x0028	0x0028	R/W
I2S_RX_CLKM_CONF_REG	RX clock configuration register	0x0030	0x0030	R/W
I2S_TX_PCM2PDM_CONF_REG	TX PCM-to-PDM configuration register	0x0040	—	R/W
I2S_TX_PCM2PDM_CONF1_REG	TX PCM-to-PDM configuration register 1	0x0044	—	R/W
I2S_RX_TDM_CTRL_REG	TX TDM mode control register	0x0050	0x0050	R/W
I2S_RXEOF_NUM_REG	RX data number control register	0x0064	0x0064	R/W
I2S_TX_CONF_REG	TX configuration register	0x0024	0x0024	varies
I2S_TX_CONF1_REG	TX configuration register 1	0x002C	0x002C	R/W
I2S_TX_CLKM_CONF_REG	TX clock configuration register	0x0034	0x0034	R/W
I2S_TX_TDM_CTRL_REG	TX TDM mode control register	0x0054	0x0054	R/W
RX clock and timing registers				
I2S_RX_CLKM_DIV_CONF_REG	RX unit clock divider configuration register	0x0038	0x0038	R/W
I2S_RX_TIMING_REG	RX timing control register	0x0058	0x0058	R/W
TX clock and timing registers				
I2S_TX_CLKM_DIV_CONF_REG	TX unit clock divider configuration register	0x003C	0x003C	R/W
I2S_TX_TIMING_REG	TX timing control register	0x005C	0x005C	R/W
Control and configuration registers				
I2S_LC_HUNG_CONF_REG	Timeout configuration register	0x0060	0x0060	R/W
I2S_CONF_SIGLE_DATA_REG	Single data register	0x0068	0x0068	R/W
TX status registers				
I2S_STATE_REG	TX status register	0x006C	0x006C	RO
Version register				
I2S_DATE_REG	Version control register	0x0080	0x0080	R/W

28.14 Registers

Register 28.1. I2S_INT_RAW_REG (0x000C)

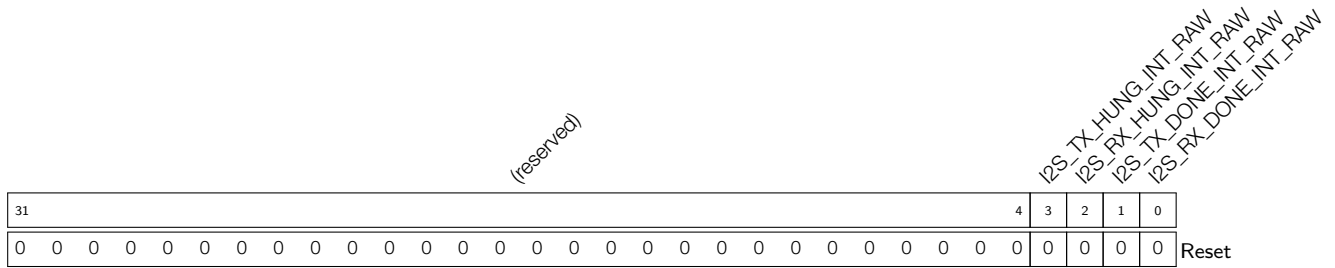

I2S_RX_DONE_INT_RAW The raw interrupt status bit for [I2S_RX_DONE_INT](#) interrupt. (RO/WTC/SS)

I2S_TX_DONE_INT_RAW The raw interrupt status bit for [I2S_TX_DONE_INT](#) interrupt. (RO/WTC/SS)

I2S_RX_HUNG_INT_RAW The raw interrupt status bit for [I2S_RX_HUNG_INT](#) interrupt. (RO/WTC/SS)

I2S_TX_HUNG_INT_RAW The raw interrupt status bit for [I2S_TX_HUNG_INT](#) interrupt. (RO/WTC/SS)

Register 28.2. I2S_INT_ST_REG (0x0010)

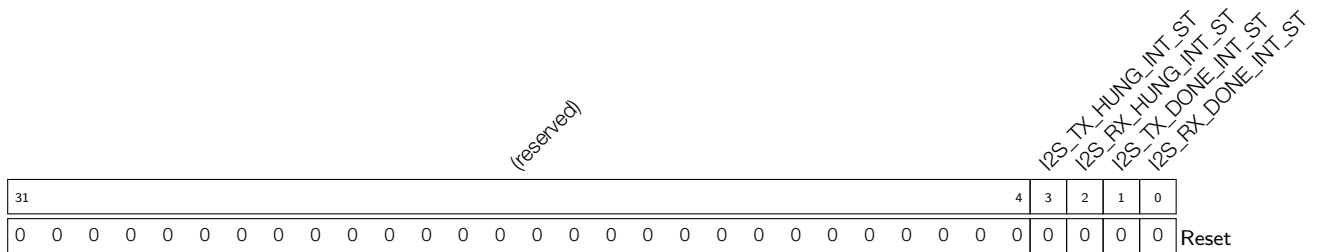

I2S_RX_DONE_INT_ST The masked interrupt status bit for [I2S_RX_DONE_INT](#) interrupt. (RO)

I2S_TX_DONE_INT_ST The masked interrupt status bit for [I2S_TX_DONE_INT](#) interrupt. (RO)

I2S_RX_HUNG_INT_ST The masked interrupt status bit for [I2S_RX_HUNG_INT](#) interrupt. (RO)

I2S_TX_HUNG_INT_ST The masked interrupt status bit for [I2S_TX_HUNG_INT](#) interrupt. (RO)

Register 28.3. I2S_INT_ENA_REG (0x0014)

(reserved)																				<i>I2S_TX_HUNG_INT_ENA</i> <i>I2S_RX_HUNG_INT_ENA</i> <i>I2S_TX_DONE_INT_ENA</i> <i>I2S_RX_DONE_INT_ENA</i>					
31																				4	3	2	1	0	Reset
0 0																				0	0	0	0	0	

I2S_RX_DONE_INT_ENA The interrupt enable bit for **I2S_RX_DONE_INT** interrupt. (R/W)

I2S_TX_DONE_INT_ENA The interrupt enable bit for **I2S_TX_DONE_INT** interrupt. (R/W)

I2S_RX_HUNG_INT_ENA The interrupt enable bit for **I2S_RX_HUNG_INT** interrupt. (R/W)

I2S_TX_HUNG_INT_ENA The interrupt enable bit for **I2S_TX_HUNG_INT** interrupt. (R/W)

Register 28.4. I2S_INT_CLR_REG (0x0018)

(reserved)																				<i>I2S_TX_HUNG_INT_CLR</i> <i>I2S_RX_HUNG_INT_CLR</i> <i>I2S_TX_DONE_INT_CLR</i> <i>I2S_RX_DONE_INT_CLR</i>					
31																				4	3	2	1	0	Reset
0 0																				0	0	0	0	0	

I2S_RX_DONE_INT_CLR Set this bit to clear **I2S_RX_DONE_INT** interrupt. (WT)

I2S_TX_DONE_INT_CLR Set this bit to clear **I2S_TX_DONE_INT** interrupt. (WT)

I2S_RX_HUNG_INT_CLR Set this bit to clear **I2S_RX_HUNG_INT** interrupt. (WT)

I2S_TX_HUNG_INT_CLR Set this bit to clear **I2S_TX_HUNG_INT** interrupt. (WT)

Register 28.5. I2S_RX_CONF_REG (0x0020)

31	23	22	21	20	19	18	17	16	15	14	13	12	11	10	9	8	7	6	5	4	3	2	1	0	Reset	
0	0	0	0	0	0	0	0	0	0	1	0	1	0x1	1	0	0	0	0	0	0	0	0	0	0	0	

- I2S_RX_RESET** Set this bit to reset RX unit. (WT)
- I2S_RX_FIFO_RESET** Set this bit to reset RX FIFO. (WT)
- I2S_RX_START** Set this bit to start receiving data. (R/W)
- I2S_RX_SLAVE_MOD** Set this bit to enable slave RX mode. (R/W)
- I2S_RX_MONO** Set this bit to enable RX unit in mono mode. (R/W)
- I2S_RX_BIG_ENDIAN** I2S RX byte endian. 1: low address data is saved to high address. 0: low address data is saved to low address. (R/W)
- I2S_RX_UPDATE** Set 1 to update I2S RX registers from APB clock domain to I2S RX clock domain. This bit will be cleared by hardware after register update is done. (R/W/SC)
- I2S_RX_MONO_FST_VLD** 1: The first channel data value is valid in I2S RX mono mode. 0: The second channel data value is valid in I2S RX mono mode. (R/W)
- I2S_RX_PCM_CONF** I2S RX compress/decompress configuration bit. 0 (atol): A-Law decompress, 1 (ltoa): A-Law compress, 2 (utol): μ -Law decompress, 3 (ltou): μ -Law compress. (R/W)
- I2S_RX_PCM_BYPASS** Set this bit to bypass Compress/Decompress module for received data. (R/W)
- I2S_RX_STOP_MODE** 0: I2S RX stops only when I2S_RX_START is cleared. 1: I2S RX stops when I2S_RX_START is 0 or in_suc_eof is 1. 2: I2S RX stops when I2S_RX_STAR is 0 or RX FIFO is full. (R/W)
- I2S_RX_LEFT_ALIGN** 1: I2S RX left alignment mode. 0: I2S RX right alignment mode. (R/W)
- I2S_RX_24_FILL_EN** 1: store 24-bit channel data to 32 bits (Extra bits are filled with zeros). 0: store 24-bit channel data to 24 bits. (R/W)
- I2S_RX_WS_IDLE_POL** 0: WS remains low when receiving left channel data, and remains high when receiving right channel data. 1: WS remains high when receiving left channel data, and remains low when receiving right channel data. (R/W)
- I2S_RX_BIT_ORDER** I2S RX bit order. 1: the lowest bit is received first. 0: the highest bit is received first. (R/W)

Continued on the next page...

Register 28.5. I2S_RX_CONF_REG (0x0020)

Continued from the previous page...

I2S_RX_TDM_EN 1: Enable I2S TDM RX mode. 0: Disable I2S TDM RX mode. (R/W)

I2S_RX_PDM_EN 1: Enable I2S PDM RX mode. 0: Disable I2S PDM RX mode. (R/W)

I2S_RX_PDM2PCM_EN (for I2S0 only) 1: Enable PDM-to-PCM RX mode. 0: Disable PDM-to-PCM RX mode. (R/W)

I2S_RX_PDM_SINC_DSR_16_EN (for I2S0 only) Configure the down sampling rate of PDM RX filter group1 module. 1: The down sampling rate is 128. 0: down sampling rate is 64. (R/W)

Register 28.6. I2S_RX_CONF1_REG (0x0028)

(reserved)		I2S_RX_MSB_SHIFT		I2S_RX_TDM_CHAN_BITS		I2S_RX_HALF_SAMPLE_BITS		I2S_RX_BITS_MOD		I2S_RX_BCK_DIV_NUM		I2S_RX_TDM_WS_WIDTH	
31	30	29	28	24	23	18	17	13	12	7	6	0	
0	0	1	0xf		0xf		0xf		6		0x0		Reset

I2S_RX_TDM_WS_WIDTH The width of rx_ws_out (WS default level) in TDM mode is $(I2S_RX_TDM_WS_WIDTH + 1) * T_BCK$. (R/W)

I2S_RX_BCK_DIV_NUM Configure the divider of BCK in RX mode. Note this divider must not be configured to 1. (R/W)

I2S_RX_BITS_MOD Configure the valid data bit length of I2S RX channel. 7: all the valid channel data is in 8-bit mode. 15: all the valid channel data is in 16-bit mode. 23: all the valid channel data is in 24-bit mode. 31: all the valid channel data is in 32-bit mode. (R/W)

I2S_RX_HALF_SAMPLE_BITS I2S RX half sample bits. This value x 2 is equal to the BCK cycles in one WS period. (R/W)

I2S_RX_TDM_CHAN_BITS Configure RX bit number for each channel in TDM mode. Bit number expected = this value + 1. (R/W)

I2S_RX_MSB_SHIFT Control the timing between WS signal and the MSB of data. 1: WS signal changes one BCK clock earlier. 0: Align at rising edge. (R/W)

Register 28.7. I2S_RX_CLKM_CONF_REG (0x0030)

<i>(reserved)</i>		<i>I2S_MCLK_SEL</i>	<i>I2S_RX_CLK_SEL</i>	<i>I2S_RX_CLK_ACTIVE</i>	<i>(reserved)</i>										<i>I2S_RX_CLKM_DIV_NUM</i>											
31	30	29	28	27	26	25											8	7	0							
0	0	0	0	0	0	0	0	0	0	0	0	0	0	0	0	0	0	0	0	0	0	0	0	0	2	Reset

I2S_RX_CLKM_DIV_NUM Integral I2S RX clock divider value. (R/W)

I2S_RX_CLK_ACTIVE Clock enable signal of I2S RX unit. (R/W)

I2S_RX_CLK_SEL Select clock source for I2S RX unit. 0: XTAL_CLK. 1: PLL_D2_CLK. 2: PLL_F160M_CLK. 3: I2S_MCLK_in. (R/W)

I2S_MCLK_SEL 0: Use I2S TX unit clock as I2S_MCLK_OUT. 1: Use I2S RX unit clock as I2S_MCLK_OUT. (R/W)

Register 28.8. I2S_TX_PCM2PDM_CONF_REG (For I2S0 Only) (0x0040)

<i>(reserved)</i>		<i>I2S_PCM2PDM_CONV_EN</i>			<i>I2S_TX_PDM_DAC_MODE_EN</i>			<i>I2S_TX_PDM_DAC_2OUT_EN</i>			<i>(reserved)</i>										<i>I2S_TX_PDM_PRESCALE</i>		<i>I2S_TX_PDM_SINC_OSR2</i>		
31					26	25	24	23	22											5	4	1	0		
0	0	0	0	0	0	0	0	0	0x0											0x2	0	Reset			

I2S_TX_PDM_SINC_OSR2 I2S TX PDM OSR value. (R/W)

I2S_TX_PDM_DAC_2OUT_EN 0: 1-line DAC output mode. 1: 2-line DAC output mode. Only valid when I2S_TX_PDM_DAC_MODE_EN is set. (R/W)

I2S_TX_PDM_DAC_MODE_EN 0: 1-line PDM output mode. 1: DAC output mode. (R/W)

I2S_PCM2PDM_CONV_EN Enable bit for I2S TX PCM-to-PDM conversion. (R/W)

Register 28.9. I2S_TX_PCM2PDM_CONF1_REG (For I2S0 Only) (0x0044)

<i>(reserved)</i>		<i>I2S_TX_PDM_FS</i>								<i>(reserved)</i>										
31					26	19											10	9	0	
0	0	0	0	0	0	0	480											960	Reset	

I2S_TX_PDM_FS I2S PDM TX upsampling parameter. (R/W)

Register 28.10. I2S_RX_TDM_CTRL_REG (0x0050)

Continued from the previous page...

I2S_RX_TDM_CHAN14_EN 1: Enable the valid data input of I2S RX TDM channel 14. 0: Disable.
Channel 14 only inputs 0. (R/W)

I2S_RX_TDM_CHAN15_EN 1: Enable the valid data input of I2S RX TDM channel 15. 0: Disable.
Channel 15 only inputs 0. (R/W)

I2S_RX_TDM_TOT_CHAN_NUM The total number of channels in use in I2S RX TDM mode. Total
channel number in use = this value + 1. (R/W)

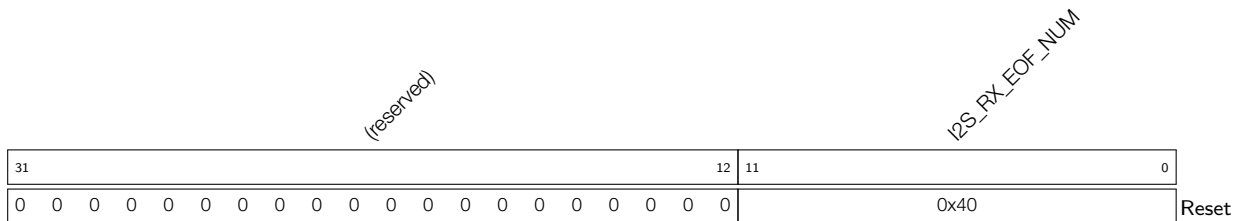
Register 28.11. I2S_RXEOF_NUM_REG (0x0064)

I2S_RX_EOF_NUM The bit length of RX data is $(I2S_RX_BITS_MOD + 1) * (I2S_RX_EOF_NUM + 1)$.
Once the length of received data reaches such bit length, an `in_suc_eof` interrupt is triggered in the
configured DMA RX channel. (R/W)

Register 28.12. I2S_TX_CONF_REG (0x0024)

(reserved)	I2S_SIG_LOOPBACK	I2S_TX_CHAN_MOD	(reserved)	I2S_TX_PDM_EN	I2S_TX_TDM_EN	I2S_TX_BIT_ORDER	I2S_TX_WS_IDLE_POL	I2S_TX_24_FILL_EN	(reserved)	I2S_TX_LEFT_ALIGN	I2S_TX_STOP_EN	I2S_TX_PCM_BYPASS	I2S_TX_PCM_CONF	I2S_TX_MONO_FST_VLD	I2S_TX_UPDATE	I2S_TX_BIG_ENDIAN	I2S_TX_CHAN_EQUAL	(reserved)	I2S_TX_SLAVE_MOD	I2S_TX_START	I2S_TX_FIFO_RESET	I2S_TX_RESET						
31	28	27	26	24	23	21	20	19	18	17	16	15	14	13	12	11	10	9	8	7	6	5	4	3	2	1	0	
0	0	0	0	0	0	0	0	0	0	0	0	1	0	1	1	0x0	1	0	0	0	0	0	0	0	0	0	0	0

Reset

I2S_TX_RESET Set this bit to reset TX unit. (WT)

I2S_TX_FIFO_RESET Set this bit to reset TX FIFO. (WT)

I2S_TX_START Set this bit to start transmitting data. (R/W)

I2S_TX_SLAVE_MOD Set this bit to enable slave TX mode. (R/W)

I2S_TX_MONO Set this bit to enable TX unit in mono mode. (R/W)

I2S_TX_CHAN_EQUAL 1: The left channel data is equal to right channel data in I2S TX mono mode or TDM mode. 0: The invalid channel data is I2S_SINGLE_DATA in I2S TX mono mode or TDM mode. (R/W)

I2S_TX_BIG_ENDIAN I2S TX byte endian. 1: low address data is saved to high address. 0: low address data is saved to low address. (R/W)

I2S_TX_UPDATE Set 1 to update I2S TX registers from APB clock domain to I2S TX clock domain. This bit will be cleared by hardware after register update is done. (R/W/SC)

I2S_TX_MONO_FST_VLD 1: The first channel data is valid in I2S TX mono mode. 0: The second channel data is valid in I2S TX mono mode. (R/W)

I2S_TX_PCM_CONF I2S TX compress/decompress configuration bits. 0 (atol): A-Law decompress, 1 (ltoa): A-Law compress, 2 (utol): μ -Law decompress, 3 (ltou): μ -Law compress. (R/W)

I2S_TX_PCM_BYPASS Set this bit to bypass Compress/Decompress module for transmitted data. (R/W)

I2S_TX_STOP_EN Set this bit to stop outputting BCK signal and WS signal when TX FIFO is empty. (R/W)

I2S_TX_LEFT_ALIGN 1: I2S TX left alignment mode. 0: I2S TX right alignment mode. (R/W)

I2S_TX_24_FILL_EN 1: Send 32 bits in 24-bit channel data mode. Extra bits are filled with zeros. 0: Send 24 bits in 24-bit channel data mode. (R/W)

I2S_TX_WS_IDLE_POL 0: WS remains low when sending left channel data, and remains high when sending right channel data. 1: WS remains high when sending left channel data, and remains low when sending right channel data. (R/W)

I2S_TX_BIT_ORDER I2S TX bit endian. 1: the lowest bit is sent first. 0: the highest bit is sent first. (R/W)

I2S_TX_TDM_EN 1: Enable I2S TDM TX mode. 0: Disable I2S TDM TX mode. (R/W)

Continued on the next page...

Register 28.12. I2S_TX_CONF_REG (0x0024)

Continued from the previous page...

I2S_TX_PDM_EN 1: Enable I2S PDM TX mode. 0: Disable I2S PDM TX mode. (R/W)

I2S_TX_CHAN_MOD I2S TX channel configuration bits. For more information, see Table 28-6. (R/W)

I2S_SIG_LOOPBACK Enable signal loop back mode with TX unit and RX unit sharing the same WS and BCK signals. (R/W)

Register 28.13. I2S_TX_CONF1_REG (0x002C)

(reserved)		I2S_TX_BCK_NO_DLY		I2S_TX_MSB_SHIFT		I2S_TX_TDM_CHAN_BITS		I2S_TX_HALF_SAMPLE_BITS		I2S_TX_BITS_MOD		I2S_TX_BCK_DIV_NUM		I2S_TX_TDM_WS_WIDTH	
31	30	29	28	24	23	18	17	13	12	7	6	0			
0	1	1	0xf		0xf		0xf		6		0x0				Reset

I2S_TX_TDM_WS_WIDTH The width of tx_ws_out (WS default level) in TDM mode is $(I2S_TX_TDM_WS_WIDTH + 1) * T_BCK$. (R/W)

I2S_TX_BCK_DIV_NUM Configure the divider of BCK in TX mode. Note this divider must not be configured to 1. (R/W)

I2S_TX_BITS_MOD Set the bits to configure the valid data bit length of I2S TX channel. 7: all the valid channel data is in 8-bit mode. 15: all the valid channel data is in 16-bit mode. 23: all the valid channel data is in 24-bit mode. 31: all the valid channel data is in 32-bit mode. (R/W)

I2S_TX_HALF_SAMPLE_BITS I2S TX half sample bits. This value x 2 is equal to the BCK cycles in one WS period. (R/W)

I2S_TX_TDM_CHAN_BITS Configure TX bit number for each channel in TDM mode. Bit number expected = this value + 1. (R/W)

I2S_TX_MSB_SHIFT Control the timing between WS signal and the MSB of data. 1: WS signal changes one BCK clock earlier. 0: Align at rising edge. (R/W)

I2S_TX_BCK_NO_DLY 1: BCK is not delayed to generate rising/falling edge in master mode. 0: BCK is delayed to generate rising/falling edge in master mode. (R/W)

Register 28.14. I2S_TX_CLKM_CONF_REG (0x0034)

(reserved)		I2S_CLK_EN		I2S_TX_CLK_SEL		I2S_TX_CLK_ACTIVE		(reserved)												I2S_TX_CLKM_DIV_NUM				
31	30	29	28	27	26	25													8	7	0			
0	0	0	0	0	0	0	0	0	0	0	0	0	0	0	0	0	0	0	0	0	0	0	2	Reset

I2S_TX_CLKM_DIV_NUM Integral I2S TX clock divider value. (R/W)

I2S_TX_CLK_ACTIVE I2S TX unit clock enable signal. (R/W)

I2S_TX_CLK_SEL Select clock clock for I2S TX unit. 0: XTAL_CLK. 1: PLL_D2_CLK. 2: PLL_F160M_CLK. 3: I2S_MCLK_in. (R/W)

I2S_CLK_EN Set this bit to enable clock gate. (R/W)

Register 28.15. I2S_TX_TDM_CTRL_REG (0x0054)

(reserved)										I2S_TX_TDM_SKIP_MSK_EN		I2S_TX_TDM_TOT_CHAN_NUM		I2S_TX_TDM_CHAN[0-9].EN																		
31	30	29	28	27	26	25	24	23	22	21	20	19	18	17	16	15	14	13	12	11	10	9	8	7	6	5	4	3	2	1	0	
0	0	0	0	0	0	0	0	0	0	0	0	0x0	0	1	1	1	1	1	1	1	1	1	1	1	1	1	1	1	1	1	1	Reset

I2S_TX_TDM_CHAN0_EN 1: Enable the valid data output of I2S TX TDM channel 0. 0: Channel TX data is controlled by [I2S_TX_CHAN_EQUAL](#) and [I2S_SINGLE_DATA](#). See Section 28.9.2.1. (R/W)

I2S_TX_TDM_CHAN1_EN 1: Enable the valid data output of I2S TX TDM channel 1. 0: Channel TX data is controlled by [I2S_TX_CHAN_EQUAL](#) and [I2S_SINGLE_DATA](#). See Section 28.9.2.1. (R/W)

I2S_TX_TDM_CHAN2_EN 1: Enable the valid data output of I2S TX TDM channel 2. 0: Channel TX data is controlled by [I2S_TX_CHAN_EQUAL](#) and [I2S_SINGLE_DATA](#). See Section 28.9.2.1. (R/W)

I2S_TX_TDM_CHAN3_EN 1: Enable the valid data output of I2S TX TDM channel 3. 0: Channel TX data is controlled by [I2S_TX_CHAN_EQUAL](#) and [I2S_SINGLE_DATA](#). See Section 28.9.2.1. (R/W)

I2S_TX_TDM_CHAN4_EN 1: Enable the valid data output of I2S TX TDM channel 4. 0: Channel TX data is controlled by [I2S_TX_CHAN_EQUAL](#) and [I2S_SINGLE_DATA](#). See Section 28.9.2.1. (R/W)

I2S_TX_TDM_CHAN5_EN 1: Enable the valid data output of I2S TX TDM channel 5. 0: Channel TX data is controlled by [I2S_TX_CHAN_EQUAL](#) and [I2S_SINGLE_DATA](#). See Section 28.9.2.1. (R/W)

I2S_TX_TDM_CHAN6_EN 1: Enable the valid data output of I2S TX TDM channel 6. 0: Channel TX data is controlled by [I2S_TX_CHAN_EQUAL](#) and [I2S_SINGLE_DATA](#). See Section 28.9.2.1. (R/W)

I2S_TX_TDM_CHAN7_EN 1: Enable the valid data output of I2S TX TDM channel 7. 0: Channel TX data is controlled by [I2S_TX_CHAN_EQUAL](#) and [I2S_SINGLE_DATA](#). See Section 28.9.2.1. (R/W)

I2S_TX_TDM_CHAN8_EN 1: Enable the valid data output of I2S TX TDM channel 8. 0: Channel TX data is controlled by [I2S_TX_CHAN_EQUAL](#) and [I2S_SINGLE_DATA](#). See Section 28.9.2.1. (R/W)

I2S_TX_TDM_CHAN9_EN 1: Enable the valid data output of I2S TX TDM channel 9. 0: Channel TX data is controlled by [I2S_TX_CHAN_EQUAL](#) and [I2S_SINGLE_DATA](#). See Section 28.9.2.1. (R/W)

Continued on the next page...

Register 28.15. I2S_TX_TDM_CTRL_REG (0x0054)

Continued from the previous page...

I2S_TX_TDM_CHAN10_EN 1: Enable the valid data output of I2S TX TDM channel 10. 0: Channel TX data is controlled by [I2S_TX_CHAN_EQUAL](#) and [I2S_SINGLE_DATA](#). See Section 28.9.2.1. (R/W)

I2S_TX_TDM_CHAN11_EN 1: Enable the valid data output of I2S TX TDM channel 11. 0: Channel TX data is controlled by [I2S_TX_CHAN_EQUAL](#) and [I2S_SINGLE_DATA](#). See Section 28.9.2.1. (R/W)

I2S_TX_TDM_CHAN12_EN 1: Enable the valid data output of I2S TX TDM channel 12. 0: Channel TX data is controlled by [I2S_TX_CHAN_EQUAL](#) and [I2S_SINGLE_DATA](#). See Section 28.9.2.1. (R/W)

I2S_TX_TDM_CHAN13_EN 1: Enable the valid data output of I2S TX TDM channel 13. 0: Channel TX data is controlled by [I2S_TX_CHAN_EQUAL](#) and [I2S_SINGLE_DATA](#). See Section 28.9.2.1. (R/W)

I2S_TX_TDM_CHAN14_EN 1: Enable the valid data output of I2S TX TDM channel 14. 0: Channel TX data is controlled by [I2S_TX_CHAN_EQUAL](#) and [I2S_SINGLE_DATA](#). See Section 28.9.2.1. (R/W)

I2S_TX_TDM_CHAN15_EN 1: Enable the valid data output of I2S TX TDM channel 15. 0: Channel TX data is controlled by [I2S_TX_CHAN_EQUAL](#) and [I2S_SINGLE_DATA](#). See Section 28.9.2.1. (R/W)

I2S_TX_TDM_TOT_CHAN_NUM Set the total number of channels in use in I2S TX TDM mode. Total channel number in use = this value + 1. (R/W)

I2S_TX_TDM_SKIP_MSK_EN When DMA TX buffer stores the data of ([I2S_TX_TDM_TOT_CHAN_NUM](#) + 1) channels, and only the data of the enabled channels is sent, then this bit should be set. Clear it when all the data stored in DMA TX buffer is for enabled channels. (R/W)

Register 28.16. I2S_RX_CLKM_DIV_CONF_REG (0x0038)

(reserved)				I2S_RX_CLKM_DIV_YN1				I2S_RX_CLKM_DIV_X				I2S_RX_CLKM_DIV_Y				I2S_RX_CLKM_DIV_Z			
31	28	27	26	18	17	9	8	0											
0	0	0	0	0	0x0				0x1				0x0				Reset		

I2S_RX_CLKM_DIV_Z For $b \leq a/2$, the value of I2S_RX_CLKM_DIV_Z is b . For $b > a/2$, the value of I2S_RX_CLKM_DIV_Z is $(a - b)$. (R/W)

I2S_RX_CLKM_DIV_Y For $b \leq a/2$, the value of I2S_RX_CLKM_DIV_Y is $(a\%b)$. For $b > a/2$, the value of I2S_RX_CLKM_DIV_Y is $(a\%(a - b))$. (R/W)

I2S_RX_CLKM_DIV_X For $b \leq a/2$, the value of I2S_RX_CLKM_DIV_X is $\text{floor}(a/b) - 1$. For $b > a/2$, the value of I2S_RX_CLKM_DIV_X is $\text{floor}(a/(a - b)) - 1$. (R/W)

I2S_RX_CLKM_DIV_YN1 For $b \leq a/2$, the value of I2S_RX_CLKM_DIV_YN1 is 0. For $b > a/2$, the value of I2S_RX_CLKM_DIV_YN1 is 1. (R/W)

Note:

“a” and “b” represent the denominator and the numerator of fractional divider, respectively. For more information, see Section 28.6.

Register 28.17. I2S_RX_TIMING_REG (0x0058)

(reserved)	I2S_RX_BCK_IN_DM	(reserved)	I2S_RX_WS_IN_DM	(reserved)	I2S_RX_BCK_OUT_DM	(reserved)	I2S_RX_WS_OUT_DM	(reserved)	I2S_RX_SD3_IN_DM	(reserved)	I2S_RX_SD2_IN_DM	(reserved)	I2S_RX_SD1_IN_DM	I2S_RX_SD_IN_DM																			
31	30	29	28	27	26	25	24	23	22	21	20	19	18	17	16	15	14	13	12	11	10	9	8	7	6	5	4	3	2	1	0	Reset	
0	0	0x0	0	0	0x0	0	0	0x0	0	0	0x0	0	0	0x0	0	0	0x0	0	0	0x0	0	0	0x0	0	0	0x0	0	0	0x0	0	0	0x0	

I2S_RX_SD_IN_DM The delay mode of I2S RX SD input signal. 0: bypass. 1: delay by rising edge. 2: delay by falling edge. 3: not used. (R/W)

I2S_RX_SD1_IN_DM (for I2S0 only) The delay mode of I2S RX SD1 input signal. 0: bypass. 1: delay by rising edge. 2: delay by falling edge. 3: not used. (R/W)

I2S_RX_SD2_IN_DM (for I2S0 only) The delay mode of I2S RX SD2 input signal. 0: bypass. 1: delay by rising edge. 2: delay by falling edge. 3: not used. (R/W)

I2S_RX_SD3_IN_DM (for I2S0 only) The delay mode of I2S RX SD3 input signal. 0: bypass. 1: delay by rising edge. 2: delay by falling edge. 3: not used. (R/W)

I2S_RX_WS_OUT_DM The delay mode of I2S RX WS output signal. 0: bypass. 1: delay by rising edge. 2: delay by falling edge. 3: not used. (R/W)

I2S_RX_BCK_OUT_DM The delay mode of I2S RX BCK output signal. 0: bypass. 1: delay by rising edge. 2: delay by falling edge. 3: not used. (R/W)

I2S_RX_WS_IN_DM The delay mode of I2S RX WS input signal. 0: bypass. 1: delay by rising edge. 2: delay by falling edge. 3: not used. (R/W)

I2S_RX_BCK_IN_DM The delay mode of I2S RX BCK input signal. 0: bypass. 1: delay by rising edge. 2: delay by falling edge. 3: not used. (R/W)

Register 28.18. I2S_TX_CLKM_DIV_CONF_REG (0x003C)

(reserved)				I2S_TX_CLKM_DIV_YN1				I2S_TX_CLKM_DIV_X				I2S_TX_CLKM_DIV_Y				I2S_TX_CLKM_DIV_Z				
31	28	27	26	18	17	9	8	0												
0 0 0 0				0				0x0				0x1				0x0				Reset

I2S_TX_CLKM_DIV_Z For $b \leq a/2$, the value of I2S_TX_CLKM_DIV_Z is b . For $b > a/2$, the value of I2S_TX_CLKM_DIV_Z is $(a - b)$. (R/W)

I2S_TX_CLKM_DIV_Y For $b \leq a/2$, the value of I2S_TX_CLKM_DIV_Y is $(a\%b)$. For $b > a/2$, the value of I2S_TX_CLKM_DIV_Y is $(a\%(a - b))$. (R/W)

I2S_TX_CLKM_DIV_X For $b \leq a/2$, the value of I2S_TX_CLKM_DIV_X is $\text{floor}(a/b) - 1$. For $b > a/2$, the value of I2S_TX_CLKM_DIV_X is $\text{floor}(a/(a - b)) - 1$. (R/W)

I2S_TX_CLKM_DIV_YN1 For $b \leq a/2$, the value of I2S_TX_CLKM_DIV_YN1 is 0. For $b > a/2$, the value of I2S_TX_CLKM_DIV_YN1 is 1. (R/W)

Note:

“a” and “b” represent the denominator and the numerator of fractional divider, respectively. For more information, see Section 28.6.

Register 28.19. I2S_TX_TIMING_REG (0x005C)

(reserved)		I2S_TX_BCK_IN_DM		(reserved)		I2S_TX_WS_IN_DM		(reserved)		I2S_TX_BCK_OUT_DM		(reserved)		I2S_TX_WS_OUT_DM		(reserved)		I2S_TX_SD1_OUT_DM		(reserved)		I2S_TX_SD_OUT_DM			
31	30	29	28	27	26	25	24	23	22	21	20	19	18	17	16	15		6	5	4	3	2	1	0	
0	0	0x0	0	0	0x0	0	0	0x0	0	0	0x0	0	0	0x0	0	0	0	0	0	0	0	0	0	0	0

Reset

I2S_TX_SD_OUT_DM The delay mode of I2S TX SD output signal. 0: bypass. 1: delay by rising edge. 2: delay by falling edge. 3: not used. (R/W)

I2S_TX_SD1_OUT_DM The delay mode of I2S TX SD1 output signal. 0: bypass. 1: delay by rising edge. 2: delay by falling edge. 3: not used. (R/W)

I2S_TX_WS_OUT_DM The delay mode of I2S TX WS output signal. 0: bypass. 1: delay by rising edge. 2: delay by falling edge. 3: not used. (R/W)

I2S_TX_BCK_OUT_DM The delay mode of I2S TX BCK output signal. 0: bypass. 1: delay by rising edge. 2: delay by falling edge. 3: not used. (R/W)

I2S_TX_WS_IN_DM The delay mode of I2S TX WS input signal. 0: bypass. 1: delay by rising edge. 2: delay by falling edge. 3: not used. (R/W)

I2S_TX_BCK_IN_DM The delay mode of I2S TX BCK input signal. 0: bypass. 1: delay by rising edge. 2: delay by falling edge. 3: not used. (R/W)

Register 28.20. I2S_LC_HUNG_CONF_REG (0x0060)

(reserved)												I2S_LC_FIFO_TIMEOUT_ENA		I2S_LC_FIFO_TIMEOUT_SHIFT		I2S_LC_FIFO_TIMEOUT								
31												12	11	10	8	7							0	
0	0	0	0	0	0	0	0	0	0	0	0	0	0	0	0	0	0	0	0	0	0	0	0	0
																								0x10

Reset

I2S_LC_FIFO_TIMEOUT [I2S_TX_HUNG_INT](#) or [I2S_RX_HUNG_INT](#) interrupt will be triggered when FIFO hung counter is equal to this value. (R/W)

I2S_LC_FIFO_TIMEOUT_SHIFT The bits are used to scale tick counter threshold. The tick counter is reset when counter value $\geq 88000/2^{I2S_LC_FIFO_TIMEOUT_SHIFT}$. (R/W)

I2S_LC_FIFO_TIMEOUT_ENA The enable bit for FIFO timeout. (R/W)

Register 28.21. I2S_CONF_SIGLE_DATA_REG (0x0068)

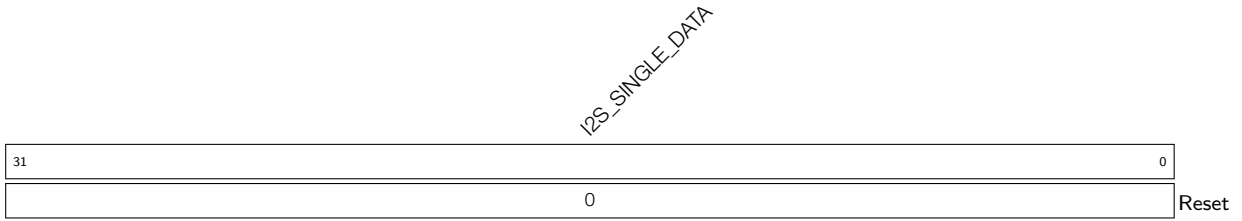

I2S_SINGLE_DATA The configured constant channel data to be sent out. (R/W)

Register 28.22. I2S_STATE_REG (0x006C)



I2S_TX_IDLE 1: I2S TX unit is in idle state. 0: I2S TX unit is working. (RO)

Register 28.23. I2S_DATE_REG (0x0080)

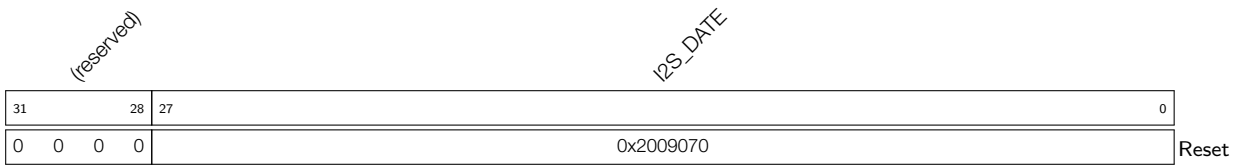

I2S_DATE Version control register. (R/W)

29 LCD and Camera Controller (LCD_CAM)

29.1 Overview

This LCD and Camera (LCD_CAM) controller consists of a LCD module and a camera module. The LCD module is designed to send parallel video data signals, and its bus supports RGB, MOTO6800, and I8080 interface timing. The camera module is designed to receive parallel video data signals, and its bus supports DVP 8-/16-bit modes.

29.2 Features

- Supports the following operation modes:
 - LCD master TX mode
 - Camera slave RX mode
 - Camera master RX mode
- Supports simultaneous connection to an external LCD and an external camera
- When connected with an external LCD, the following is supported:
 - 8-/16-bit parallel output mode
 - RGB, MOTO6800, and I8080 LCD formats
 - LCD data retrieved from internal memory via GDMA
- When connected with an external camera (i.e. DVP image sensor), the following is supported:
 - 8-/16-bit parallel input mode
 - Camera data stored into internal memory via GDMA
- Supports LCD_CAM interface interrupts

29.3 Functional Description

29.3.1 Block Diagram

Figure 29-1 shows the structure of this LCD_CAM module, including

- 1 x TX control unit (LCD_Ctrl)
- 1 x RX control unit (Camera_Ctrl)
- 1 x asynchronous TX FIFO (Async Tx FIFO) for communicating with external devices
- 1 x asynchronous RX FIFO (Async Rx FIFO) for communicating with external devices
- 2 x clock generators (LCD_Clock Generator and CAM_Clock Generator) for generating the module clocks
- 2 x format converters (RGB/YCbCr Converter) for converting video data into various formats

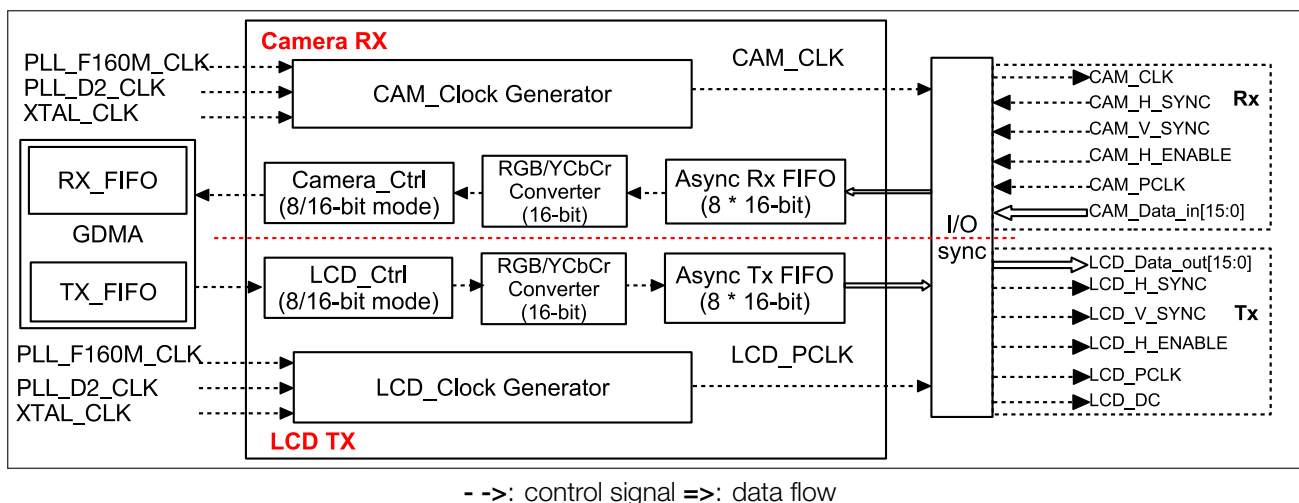

Figure 29-1. LCD_CAM Block Diagram

29.3.2 Signal Description

Table 29-1. Signal Description

Operation Mode	Signal ¹	Direction	Function
Camera Slave RX Mode	CAM_PCLK	Input	Camera pixel clock signal
	CAM_V_SYNC	Input	Vertical synchronization signal (VSYNC) ³
	CAM_H_SYNC	Input	Horizontal synchronization signal (HSYNC) ³
	CAM_H_ENABLE	Input	Horizontal enable signal (DE) ³
	CAM_Data_in[N:0] ²	Input	Camera parallel input data bus, 8-/16-bit supported
Camera Master RX Mode	CAM_PCLK	Input	Camera pixel clock input signal
	CAM_CLK	Output	Camera master clock output signal
	CAM_V_SYNC	Input	Vertical synchronization signal ³
	CAM_H_SYNC	Input	Horizontal synchronization signal ³
	CAM_H_ENABLE	Input	Horizontal enable signal ³
	CAM_Data_in[N:0] ²	Input	Camera parallel input data bus, 8-/16-bit supported
LCD Master TX Mode	LCD_PCLK	Output	LCD pixel clock signal
	LCD_H_SYNC	Output	Horizontal synchronization signal in RGB format
	LCD_V_SYNC	Output	Vertical synchronization signal in RGB mode
	LCD_H_ENABLE	Output	Horizontal enable signal in RGB format
	LCD_CD	Output	Command and data (CD) signal in I8080 format
	LCD_CS	Output	Chip select (CS) signal in I8080/MOTO6800 format
	LCD_Data_out[N:0] ²	Output	LCD parallel output data bus, 8-/16-bit supported

¹ All signals of LCD_CAM must be mapped to the chip's pin via GPIO matrix. For more information, see Chapter 6 [IO MUX and GPIO Matrix \(GPIO, IO MUX\)](#).

² For the input/output signals with 8 or 16 bit width, $N = 7$ or 15 respectively.

³ If `LCD_CAM_CAM_VH_DE_MODE_EN` is set, i.e., VSYNC + HSYNC mode is selected, in this mode, the signals of VSYNC, HSYNC and DE are used to control the data. For this case, users need to wire the three signal lines. If `LCD_CAM_CAM_VH_DE_MODE_EN` is cleared, i.e. DE mode is selected, the signals of VSYNC and DE are used to control the data. For this case, wiring HSYNC signal line is not a must. But in this case, the YUV-RGB conversion function of camera module is not available.

29.3.3 LCD_CAM Module Clocks

29.3.3.1 LCD Clock

The clocks used in LCD module are generated by LCD_Clock Generator from clock sources, see Figure 29-2.

The clocks include:

- master clock: LCD_CLK, divided from clock sources
- pixel clock: LCD_PCLK, divided from LCD_CLK

The clock source can be one of the following, depending on the configuration of `LCD_CAM_LCD_CLK_SEL` in register `LCD_CAM_LCD_CLOCK_REG`:

- 0: disable LCD clock source
- 1: XTAL_CLK
- 2: PLL_D2_CLK
- 3: PLL_F160M_CLK

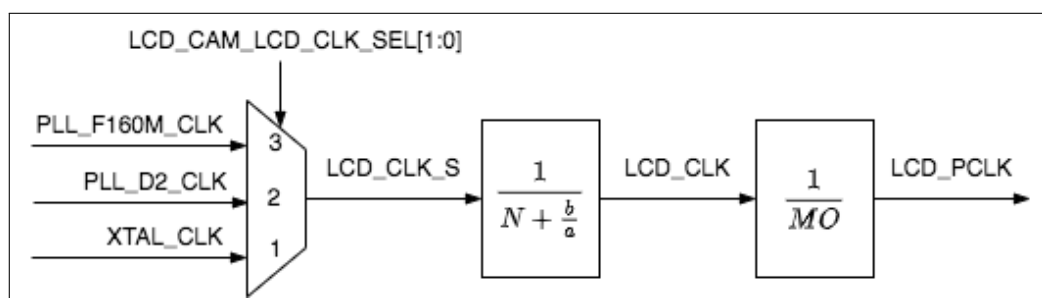

Figure 29-2. LCD Clock

The following formula shows the relation between the frequency of LCD_CLK ($f_{\text{LCD_CLK}}$) and the divider clock source frequency ($f_{\text{LCD_CLK_S}}$):

$$f_{\text{LCD_CLK}} = \frac{f_{\text{LCD_CLK_S}}}{N + \frac{b}{a}}$$

N is an integer value between 2 and 256. The value of N corresponds to the value of `LCD_CAM_LCD_CLKM_DIV_NUM` in register `LCD_CAM_LCD_CLOCK_REG` as follows:

- When `LCD_CAM_LCD_CLKM_DIV_NUM` = 0, N = 256.
- When `LCD_CAM_LCD_CLKM_DIV_NUM` = 1, N = 2.
- When `LCD_CAM_LCD_CLKM_DIV_NUM` has any other value, N = `LCD_CAM_LCD_CLKM_DIV_NUM`.

“b” corresponds to the value of `LCD_CAM_LCD_CLKM_DIV_B`, and “a” to the value of `LCD_CAM_LCD_CLKM_DIV_A`. For integer divider, `LCD_CAM_LCD_CLKM_DIV_A` and `LCD_CAM_LCD_CLKM_DIV_B` are cleared. For fractional divider, the value of `LCD_CAM_LCD_CLKM_DIV_B` should be less than the value of `LCD_CAM_LCD_CLKM_DIV_A`.

The following formula shows the relation between the frequencies of LCD_PCLK ($f_{\text{LCD_PCLK}}$) and LCD_CLK ($f_{\text{LCD_CLK}}$):

$$f_{\text{LCD_PCLK}} = \frac{f_{\text{LCD_CLK}}}{\text{MO}}$$

MO is determined by `LCD_CAM_LCD_CLK_EQU_SYSCLK` and `LCD_CAM_LCD_CLKCNT_N`.

- When `LCD_CAM_LCD_CLK_EQU_SYSCLK = 1`, $\text{MO} = 1$.
- When `LCD_CAM_LCD_CLK_EQU_SYSCLK = 0`, $\text{MO} = \text{LCD_CAM_LCD_CLKCNT_N} + 1$.

Notes:

- `LCD_CAM_LCD_CLKCNT_N` must not be configured as 0.
- Using fractional divider may bring clock jitter. In case that `LCD_CLK` and `LCD_PCLK` can not be generated from `PLL_F160M_CLK` by integer divider, `PLL_D2_CLK` can be used as clock source. For more information, please refer to Chapter 7 *Reset and Clock*.

29.3.3.2 Camera Clock

The clocks used in camera module are generated by CAM_Clock Generator from clock sources, see Figure 29-3.

The clocks include:

- master clock: `CAM_CLK`, master clock output from camera module, divided from clock sources.
- pixel clock: `CAM_CLK`, clock input from camera slave.

`LCD_CAM_CAM_CLK_SEL` in register `LCD_CAM_CAM_CTRL_REG` is used to select one of the following clock sources for camera module:

- 0: disable camera clock source
- 1: `XTAL_CLK`
- 2: `PLL_D2_CLK`
- 3: `PLL_F160M_CLK`

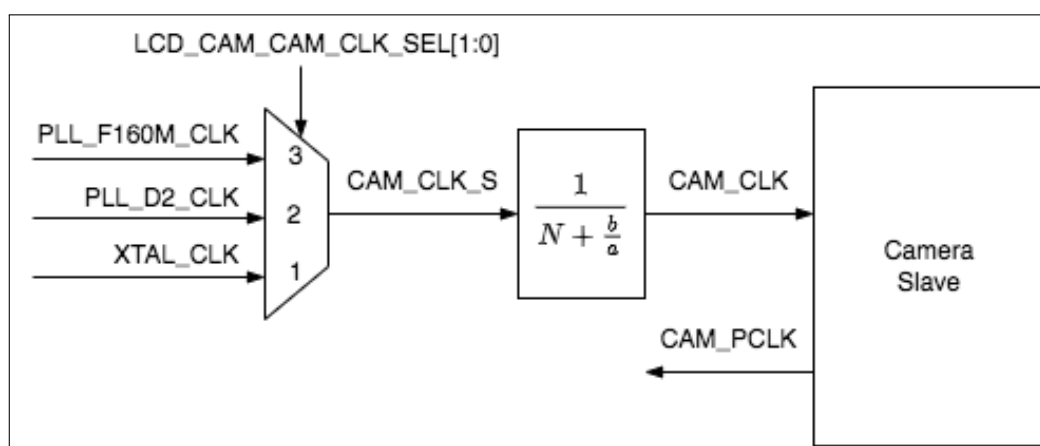

Figure 29-3. Camera Clock

The following formula shows the relation between the frequencies of `CAM_CLK` ($f_{\text{CAM_CLK}}$) and the divider clock

source ($f_{CAM_CLK_S}$):

$$f_{CAM_CLK} = \frac{f_{CAM_CLK_S}}{N + \frac{b}{a}}$$

N is an integer value between 2 and 256. The value of N corresponds to the value of `LCD_CAM_CAM_CLKM_DIV_NUM` in register `LCD_CAM_CAM_CTRL_REG` as follows:

- When `LCD_CAM_CAM_CLKM_DIV_NUM` = 0, N = 256.
- When `LCD_CAM_CAM_CLKM_DIV_NUM` = 1, N = 2.
- When `LCD_CAM_CAM_CLKM_DIV_NUM` has any other value, N = `LCD_CAM_CAM_CLKM_DIV_NUM`.

“b” corresponds to the value of `LCD_CAM_CAM_CLKM_DIV_B`, and “a” to the value of `LCD_CAM_CAM_CLKM_DIV_A`. For integer divider, `LCD_CAM_CAM_CLKM_DIV_A` and `LCD_CAM_CAM_CLKM_DIV_B` are cleared. For fractional divider, the value of `LCD_CAM_CAM_CLKM_DIV_B` should be less than the value of `LCD_CAM_CAM_CLKM_DIV_A`.

29.3.4 LCD_CAM Reset

The units in LCD_CAM module can be reset by the following bits:

- `LCD_CAM_LCD_RESET`: set this bit to reset LCD control unit (LCD_Ctrl) and LCD video data format converter (RGB/YCbCr Converter).
- `LCD_CAM_CAM_RESET`: set this bit to reset camera control unit (Camera_Ctrl) and camera video data format converter (RGB/YCbCr Converter).
- `LCD_CAM_LCD_AFIFO_RESET`: set this bit to reset Async Tx FIFO.
- `LCD_CAM_CAM_AFIFO_RESET`: set this bit to reset Async Rx FIFO.

Notes:

- The above-mentioned reset bits are hardware self-clearing, i.e., the hardware automatically clears these bits once 1 is written.
- LCD/camera module clock must be configured first before the module and FIFO are reset.

29.3.5 LCD_CAM Data Format Control

29.3.5.1 LCD Data Format Control

When the LCD module is used to send data, the bit/byte order of the data from DMA can be adjusted by configuring

- `LCD_CAM_LCD_2BYTE_EN`
 - 1: LCD output data is in 16-bit mode.
 - 0: LCD output data is in 8-bit mode.
- `LCD_CAM_LCD_BIT_ORDER`
 - 1: Change data bit order.
 - * Change `LCD_DATA_out[7:0]` to `LCD_DATA_out[0:7]` in 8-bit mode.
 - * Change `LCD_DATA_out[15:0]` to `LCD_DATA_out[0:15]` in 16-bit mode.

- 0: Do not change the bit order.
- [LCD_CAM_LCD_BYTE_ORDER](#)
 - 1: Invert data byte order, only valid in 16-bit mode.
 - 0: Do not invert.
- [LCD_CAM_LCD_8BITS_ORDER](#)
 - 1: Swap every two data bytes, valid in 8-bit mode
 - 0: Do not swap.

For the detailed configuration, see Table 29-2.

Table 29-2. LCD Data Format Control

Data from DMA ¹	LCD_CAM_LCD_2BYTE_EN	LCD_CAM_LCD_BIT_ORDER	LCD_CAM_LCD_BYTE_ORDER ²	LCD_CAM_LCD_8BITS_ORDER ²	TX Data ^{3,4}
B0,B1,B2,B3	0	0	0	0	{B0}{B1}{B2}{B3}
			0	1	{B1}{B0}{B3}{B2}
		1	0	0	{B0'}{B1'}{B2'}{B3'}
			0	1	{B1'}{B0'}{B3'}{B2'}
	1	0	0	0	{B1,B0}{B3,B2}
			1	0	{B0,B1}{B2,B3}
		1	0	0	{B1',B0'}{B3',B2'}
			1	0	{B0',B1'}{B2',B3'}

¹ B0 ~ B3 represent the bytes of the data from DMA, from low address to high address.

² Only the configuration listed in the table is valid. Other configuration may cause unexpected data errors.

³ In TX data, the bits in {} are in big-endian, and are in parallel with each other, while the data of {} is in serial with the data of other {}. Data is sent out from left to right. Take {B0}{B1}{B2}{B3} as an example. The bits in {B0} are in parallel with each other, but are in serial with the bits in {B1}{B2}{B3}. {B0} is sent out first.

⁴ In TX data, $Bn'[7:0] = Bn[0:7]$ ($n = 0,1,2,3$).

Note:

If only one byte of data is sent out each time, LCD_Data_out[7:0] is valid, while LCD_Data_out[15:8] is invalid.

29.3.5.2 Camera Data Format Control

When the camera module is used to receive data, the bit/byte order of the data to DMA can be adjusted by configuring

- [LCD_CAM_CAM_2BYTE_EN](#)
 - 1: Camera input data is in 16-bit mode.
 - 0: Camera input data is in 8-bit mode.
- [LCD_CAM_CAM_BIT_ORDER](#)
 - 1: Change data bit order.

- * Change CAM_DATA_in[7:0] to CAM_DATA_in[0:7] in 8-bit mode.
- * Change CAM_DATA_in[15:0] to CAM_DATA_in[0:15] in 16-bit mode.
- 0: Do not change the bit order.
- **LCD_CAM_CAM_BYTE_ORDER**
 - 1: Invert data byte order, only valid in 16-bit mode.
 - 0: Do not invert.

For the detailed configuration, see Table 29-3.

Table 29-3. CAM Data Format Control

RX Data ¹	LCD_CAM_CAM _2BYTE_EN	LCD_CAM_CAM _BIT_ORDER ²	LCD_CAM_CAM _BYTE_ORDER ²	Data to DMA ^{3,4}	
{B0}{B1}{B2}{B3}	0	0	0	B0,B1,B2,B3	
		1	0	B0',B1',B2',B3'	
{B1,B0}{B3,B2}	1	0	0	B0,B1,B2,B3	
			1	B1,B0,B3,B2	
		1	0	0	B0',B1',B2',B3'
			1	1	B1',B0',B3',B2'

¹ In RX data, the bits in {} are in big-endian, and are in parallel with each other, while the data of {} is in serial with the data of other {}. Data is received from left to right. Take {B0}{B1}{B2}{B3} as an example. The bits in {B0} are in parallel with each other, but are in serial with the bits in {B1}{B2}{B3}. {B1} is received first.

² Only the configuration listed in the table is valid. Other configuration may cause unexpected data errors.

³ B0 ~ B3 represent the bytes of the data to DMA, from low address to high address.

⁴ In the data to DMA, Bn'[7:0] = Bn[0:7] (n = 0,1,2,3).

Note:

If only one byte is received each time, CAM_Data_in[7:0] is valid data. For such case, users must connect CAM_Data_in[7:0] with the master.

29.3.6 YUV-RGB Data Format Conversion

The LCD_CAM module supports data format conversion among YUV and RGB. LCD module and camera module each has a data format converter. The converter supports format conversion over:

- BT601 and BT709 standards
- RGB565 (full/limited range) and YUV422/420/411 (full/limited range) formats
- YUV422/420/411 (full/limited range) formats

29.3.6.1 YUV Timing

In LCD_CAM module, assume that there are 8 pixels to be transmitted, corresponding to YUV data $[Y_i, U_i, V_i]$ ($i = 1 \sim 8$). Then:

- in YUV422 mode, the LCD sends (or the camera receives) the data as follows:

Y_1	U_1	Y_2	V_2	Y_3	U_3	Y_4	V_4	Y_5	U_5	Y_6	V_6	Y_7	U_7	Y_8	V_8
-------	-------	-------	-------	-------	-------	-------	-------	-------	-------	-------	-------	-------	-------	-------	-------

- in YUV420 mode, the LCD sends (or the camera receives) the data as follows:

Y_1	U_1	Y_2	Y_3	U_3	Y_4	Y_5	V_5	Y_6	Y_7	V_7	Y_8
-------	-------	-------	-------	-------	-------	-------	-------	-------	-------	-------	-------

- in YUV411 mode, the LCD sends (or the camera receives) the data as follows:

Y_1	U_1	Y_2	Y_3	V_3	Y_4	Y_5	U_5	Y_6	Y_7	V_7	Y_8
-------	-------	-------	-------	-------	-------	-------	-------	-------	-------	-------	-------

29.3.6.2 Data Conversion Configuration

The configuration for format converter in camera module is identical to that in LCD module. Therefore, the configuration process is illustrated below using the format conversion in LCD module as an example:

- Enable YUV-RGB format converter by setting [LCD_CAM_LCD_CONV_BYPASS](#).
- Configure the data transfer mode by configuring [LCD_CAM_LCD_CONV_MODE_8BITS_ON](#):
 - 0: use 16-bit data transfer mode
 - 1: use 8-bit data transfer mode
- Select the standard by configuring [LCD_CAM_LCD_CONV_PROTOCOL_MODE](#):
 - 0: use BT601 standard
 - 1: use BT709 standard
- Configure the conversion mode:

Table 29-4. Conversion Mode Control

Conversion Mode	TRANS_MODE ¹	YUV_MODE ²	YUV2YUV_MODE ³
RGB565 -> YUV422	1	0	3
RGB565 -> YUV420	1	1	3
RGB565 -> YUV411	1	2	3
YUV422 -> RGB565	0	0	3
YUV420 -> RGB565	0	1	3
YUV411 -> RGB565	0	2	3
YUV422 -> YUV420	1	0	1
YUV422 -> YUV411	1	0	2
YUV420 -> YUV422	1	1	0
YUV420 -> YUV411	1	1	2
YUV411 -> YUV422	1	2	0
YUV411 -> YUV420	1	2	1

¹ The value of `LCD_CAM_LCD_CONV_TRANS_MODE`

² The value of `LCD_CAM_LCD_CONV_YUV_MODE`

³ The value of `LCD_CAM_LCD_CONV_YUV2YUV_MODE`

- Configure the color range for input data by configuring `LCD_CAM_LCD_CONV_DATA_IN_MODE`:
 - 1: full color range¹
 - 0: limited color range²
- Configure the color range for output data by configuring `LCD_CAM_LCD_CONV_DATA_OUT_MODE`:
 - 0: limited color range
 - 1: full color range

Note:

1. If full color range is selected, the color range of RGB or YUV is 0 ~ 255.
2. If limited color range is selected,
 - the color range of RGB is: 16 ~ 240.
 - the color range of YUV is:
 - Y: 16 ~ 240.
 - U-V: 16 ~ 235.

29.4 Software Configuration Process

Note:

Updating the register configuration described in LCD module or camera module requires to set `LCD_CAM_LCD_UPDATE` and `LCD_CAM_CAM_UPDATE`, respectively, to synchronize registers from APB clock domain to LCD/camera clock domain. For more detailed configuration, see the configuration examples below.

29.4.1 Configure LCD (RGB Format) as TX Mode

Follow the steps below to configure LCD (RGB format) as TX mode via software:

1. Configure clock according to Section 29.3.3.
2. Configure signal pins according to Table 29-1.
3. Enable corresponding interrupts, see Section 29.5.
4. Enable RGB format by setting `LCD_CAM_LCD_RGB_MODE_EN`.
5. Configure frame format by the following registers. See the figures below.
 - `LCD_CAM_LCD_VT_HEIGHT`
 - `LCD_CAM_LCD_VA_HEIGHT`
 - `LCD_CAM_LCD_HB_FRONT`
 - `LCD_CAM_LCD_HT_WIDTH`
 - `LCD_CAM_LCD_HA_WIDTH`
 - `LCD_CAM_VB_FRONT`
 - `LCD_CAM_LCD_VSYNC_WIDTH`

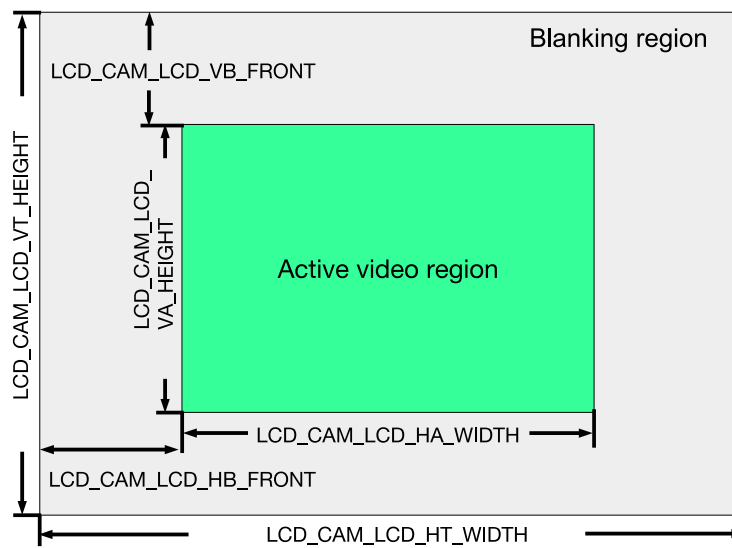

Figure 29-4. LCD Frame Structure

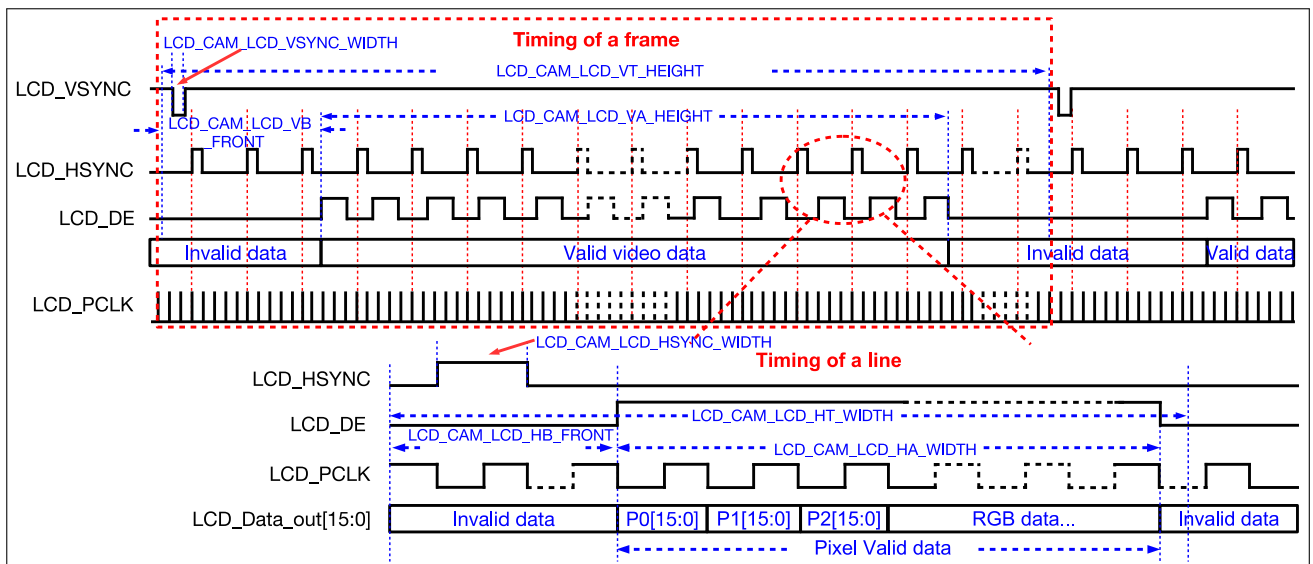

Figure 29-5. LCD Timing (RGB Format)

Note:

When configuring the parameters shown in the figures above, please note that the parameter is equal to the register value + 1. For example, if the expected VSYNC width is 1, then please configure `LCD_CAM_LCD_VSYNC_WIDTH` to 0. For more information, see the register description.

6. Set `LCD_CAM_LCD_UPDATE`.
7. Reset TX control unit (LCD_Ctrl) and Async Tx FIFO as described in Section 29.3.4.
8. Configure GDMA outlink.
9. Start transmitting data:
 - wait till LCD slave gets ready.
 - then set `LCD_CAM_LCD_START` to start transmitting data.
10. Wait for the interrupt signals set in Step 3.
11. In frame intervals during data transmitting, check if the bit `LCD_CAM_LCD_NEXT_FRAME_EN` is set:
 - If yes, set `LCD_CAM_LCD_UPDATE` (repeating the steps above) to continue transmitting next frame.
 - If not, LCD stops transmitting data.
12. Clear `LCD_CAM_LCD_START` if data transmission is done.

29.4.2 Configure LCD (I8080/MOTO6800 Format) as TX Mode

Figure 29-6 shows the LCD timing sequence in I8080 format.

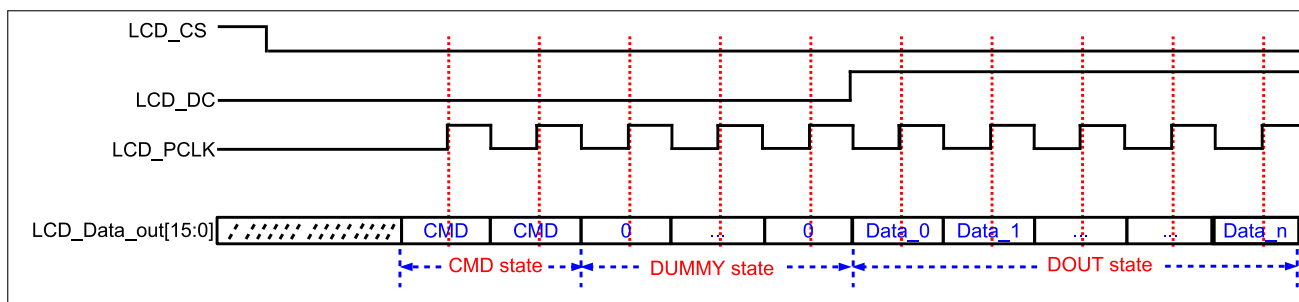

Figure 29-6. LCD Timing (I8080 Format)

Follow the steps below to configure LCD (I8080 format) as TX mode via software:

1. Configure clock according to Section 29.3.3.
2. Configure signal pins according to Table 29-1.
3. Enable corresponding interrupts, see Section 29.5.
4. Clear `LCD_CAM_LCD_RGB_MODE_EN`.
5. Configure CMD phase by `LCD_CAM_LCD_CMD`, `LCD_CAM_LCD_CMD_2_CYCLE_EN`, and `LCD_CAM_LCD_CMD_VALUE`.
6. Configure DUMMY phase by `LCD_CAM_LCD_DUMMY` and `LCD_CAM_LCD_DUMMY_CYCLELEN`.
7. Configure DOUT phase by `LCD_CAM_LCD_DOUT`, depending on the output mode:
 - In a fixed-length output^a, configure data length in `LCD_CAM_LCD_DOUT_CYCLELEN`.
 - In a continuous output^b, set `LCD_CAM_LCD_ALWAYS_OUT_EN`. Users do not need to configure `LCD_CAM_LCD_DOUT_CYCLELEN`.

Note:

- (a) In a fixed-length output, the LCD module stops sending data once the data length reaches the value set in `LCD_CAM_LCD_DOUT_CYCLELEN`.
- (b) In a continuous output, LCD module keeps sending data till:
 - i. `LCD_CAM_LCD_START` is cleared;
 - ii. or `LCD_CAM_LCD_RESET` is set;
 - iii. or all the data in GDMA is sent out.

8. Configure the CD signal mode, including the default value of the CD signal and the values at each phase, see the description of `LCD_CAM_LCD_MISC_REG`.
9. Set `LCD_CAM_LCD_UPDATE`.
10. Reset TX control unit (`LCD_Ctrl`) and Async Tx FIFO as described in Section 29.3.4.
11. Configure GDMA outlink.
12. Start transmitting data:
 - wait till LCD slave gets ready.

- then set `LCD_CAM_LCD_START` to start transmitting data.
13. Wait for the interrupt signals set in Step 3.
 14. Clear `LCD_CAM_LCD_START` if data transmission is done.

Notes:

No matter in which format, RGB or I8080/MOTO6800, the rules below must be followed when accessing internal memory via GDMA:

- If LCD data bus is configured to 8-bit parallel output mode, then
 - pixel clock frequency must be less than 80 MHz.
 - if YUV-RGB format conversion is used meanwhile, the pixel clock frequency must be less than 60 MHz.
- If LCD data bus is configured to 16-bit parallel output mode, then
 - pixel clock frequency must be less than 40 MHz.
 - if YUV-RGB format conversion is used meanwhile, the pixel clock frequency must be less than 30 MHz.

29.4.3 Configure Camera as RX Mode

Follow the steps below to configure camera as RX mode via software:

1. Configure clock according to Section 29.3.3. Note that in slave mode, the module clock frequency should be two times faster than the PCLK frequency of the image sensor.
2. Configure signal pins according to Table 29-1.
3. Set or clear `LCD_CAM_CAM_VH_DE_MODE_EN` according to the control signal HSYNC.
4. Set needed RX channel mode and RX data mode, then set the bit `LCD_CAM_CAM_UPDATE`.
5. Reset RX control unit (Camera_Ctrl) and Async Rx FIFO as described in Section 29.3.4.
6. Enable corresponding interrupts, see Section 29.5.
7. Configure GDMA inlink, and set the length of RX data in `LCD_CAM_CAM_REC_DATA_BYTELEN`.
8. Start receiving data:
 - In master mode, when the slave is ready, set `LCD_CAM_CAM_START` to start receiving data.
 - In slave mode, set `LCD_CAM_CAM_START`. Receiving data starts after the master provides clock signal and control signal.
9. Receive data and store the data to the specified address of ESP32-S3 memory. Then corresponding interrupts set in Step 6 will be generated.

Notes:

- No matter in which operation mode, camera master RX mode or camera slave RX mode, the rules below must be followed when accessing internal memory via GDMA:
 - If 8-bit parallel data input mode is selected, then
 - * pixel clock frequency must be less than 80 MHz.

- * if YUV-RGB format conversion is used meanwhile, the pixel clock frequency must be less than 60 MHz.
- If 16-bit parallel data input mode is selected, then
 - * pixel clock frequency must be less than 40 MHz.
 - * if YUV-RGB format conversion is used meanwhile, the pixel clock frequency must be less than 30 MHz.
- If an external camera and an external LCD are connected simultaneously, ensure that the maximum data throughput on the interface is less than GDMA total data bandwidth of 80 MB/s. Note the default frequency of APB_CLK is 80 MHz here. For more information, see Chapter 7 *Reset and Clock*.

29.5 LCD_CAM Interrupts

- LCD_CAM_CAM_HS_INT: triggered when the total number of received lines by camera is greater than or equal to `LCD_CAM_CAM_LINE_INT_NUM + 1`.
- LCD_CAM_CAM_VSYNC_INT: triggered when the camera received a VSYNC signal.
- LCD_CAM_LCD_TRANS_DONE_INT: triggered when the LCD transmitted all the data.
- LCD_CAM_LCD_VSYNC_INT: triggered when the LCD transmitted a VSYNC signal.

29.6 Register Summary

The addresses in this section are relative to LCD_CAM controller base address provided in Table 4-3 in Chapter 4 *System and Memory*.

The abbreviations given in Column **Access** are explained in Section [Access Types for Registers](#).

Name	Description	Address	Access
LCD configuration registers			
LCD_CAM_LCD_CLOCK_REG	LCD clock configuration register	0x0000	R/W
LCD_CAM_LCD_RGB_YUV_REG	LCD data format conversion register	0x0010	R/W
LCD_CAM_LCD_USER_REG	LCD user configuration register	0x0014	varies
LCD_CAM_LCD_MISC_REG	LCD MISC configuration register	0x0018	varies
LCD_CAM_LCD_CTRL_REG	LCD signal configuration register	0x001C	R/W
LCD_CAM_LCD_CTRL1_REG	LCD signal configuration register 1	0x0020	R/W
LCD_CAM_LCD_CTRL2_REG	LCD signal configuration register 2	0x0024	R/W
LCD_CAM_LCD_CMD_VAL_REG	LCD command value configuration register	0x0028	R/W
LCD_CAM_LCD_DLY_MODE_REG	LCD signal delay configuration register	0x0030	R/W
LCD_CAM_LCD_DATA_DOUT_MODE_REG	LCD data delay configuration register	0x0038	R/W
Camera configuration registers			
LCD_CAM_CAM_CTRL_REG	Camera clock configuration register	0x0004	R/W
LCD_CAM_CAM_CTRL1_REG	Camera control register	0x0008	varies
LCD_CAM_CAM_RGB_YUV_REG	Camera data format conversion register	0x000C	R/W
Interrupt registers			
LCD_CAM_LC_DMA_INT_ENA_REG	LCD_CAM GDMA interrupt enable register	0x0064	R/W
LCD_CAM_LC_DMA_INT_RAW_REG	LCD_CAM GDMA raw interrupt status register	0x0068	RO
LCD_CAM_LC_DMA_INT_ST_REG	LCD_CAM GDMA masked interrupt status register	0x006C	RO
LCD_CAM_LC_DMA_INT_CLR_REG	LCD_CAM GDMA interrupt clear register	0x0070	WO
Version register			
LCD_CAM_LC_REG_DATE_REG	Version control register	0x00FC	R/W

29.7 Registers

The addresses in this section are relative to LCD_CAM controller base address provided in Table 4-3 in Chapter 4 *System and Memory*.

Register 29.1. LCD_CAM_LCD_CLOCK_REG (0x0000)

LCD_CAM_CLK_EN		LCD_CAM_LCD_CLK_SEL		LCD_CAM_LCD_CLKM_DIV_A		LCD_CAM_LCD_CLKM_DIV_B		LCD_CAM_LCD_CLKM_DIV_NUM		LCD_CAM_LCD_CK_OUT_EDGE		LCD_CAM_LCD_CK_IDLE_EDGE		LCD_CAM_LCD_CLK_EQU_SYSCLK		LCD_CAM_LCD_CLKCNT_N	
31	30	29	28	23	22	17	16	9	8	7	6	5	0				
0	0	0x0		0x0		4		0	0	1	0x3				Reset		

LCD_CAM_LCD_CLKCNT_N $f_{LCD_PCLK} = f_{LCD_CLK}/(LCD_CAM_LCD_CLKCNT_N + 1)$ when [LCD_CAM_LCD_CLK_EQU_SYSCLK](#) is 0. Note: this field must not be configured to 0. (R/W)

LCD_CAM_LCD_CLK_EQU_SYSCLK 1: $f_{LCD_PCLK} = f_{LCD_CLK}$. 0: $f_{LCD_PCLK} = f_{LCD_CLK}/(LCD_CAM_LCD_CLKCNT_N + 1)$. (R/W)

LCD_CAM_LCD_CK_IDLE_EDGE 1: LCD_PCLK line is high in idle. 0: LCD_PCLK line is low in idle. (R/W)

LCD_CAM_LCD_CK_OUT_EDGE 1: LCD_PCLK is high in the first half clock cycle. 0: LCD_PCLK is low in the first half clock cycle. (R/W)

LCD_CAM_LCD_CLKM_DIV_NUM Integral LCD clock divider value. (R/W)

LCD_CAM_LCD_CLKM_DIV_B Fractional clock divider numerator value. (R/W)

LCD_CAM_LCD_CLKM_DIV_A Fractional clock divider denominator value. (R/W)

LCD_CAM_LCD_CLK_SEL Select LCD module source clock. 0: clock source is disabled. 1: XTAL_CLK. 2: PLL_D2_CLK. 3: PLL_F160M_CLK. (R/W)

LCD_CAM_CLK_EN Set this bit to force enable the clock for all configuration registers. Clock gate is not used. (R/W)

Register 29.2. LCD_CAM_LCD_RGB_YUV_REG (0x0010)

31	30	29	28	27	26	25	24	23	22	21	20	19	(reserved)												0												
0	0	0	0	0	0	0	0	3	0	0	0	0	0	0	0	0	0	0	0	0	0	0	0	0	0	0	0	0	0	0	0	0	0	0	0	0	Reset

LCD_CAM_LCD_CONV_8BITS_DATA_INV Swap every two 8-bit input data. 1: Enabled. 0: Disabled. (R/W)

LCD_CAM_LCD_CONV_YUV2YUV_MODE In YUV-to-YUV mode, 0: data is converted to YUV422 format. 1: data is converted to YUV420 format. 2: data is converted to YUV411 format. 3: disabled. To enable YUV-to-YUV mode, [LCD_CAM_LCD_CONV_TRANS_MODE](#) must be set to 1. (R/W)

LCD_CAM_LCD_CONV_YUV_MODE In YUV-to-YUV mode and YUV-to-RGB mode, `LCD_CAM_LCD_CONV_YUV_MODE` decides the YUV mode of input data. 0: input data is in YUV422 format. 1: input data is in YUV420 format. 2: input data is in YUV411 format. In RGB-to-YUV mode, 0: data is converted to YUV422 format. 1: data is converted to YUV420 format. 2: data is converted to YUV411 format. (R/W)

LCD_CAM_LCD_CONV_PROTOCOL_MODE 0: BT601. 1: BT709. (R/W)

LCD_CAM_LCD_CONV_DATA_OUT_MODE Configure color range for output data. 0: limited color range. 1: full color range. (R/W)

LCD_CAM_LCD_CONV_DATA_IN_MODE Configure color range for input data. 0: limited color range. 1: full color range. (R/W)

LCD_CAM_LCD_CONV_MODE_8BITS_ON 0: 16-bit mode. 1: 8-bit mode. (R/W)

LCD_CAM_LCD_CONV_TRANS_MODE 0: converted to RGB format. 1: converted to YUV format. (R/W)

LCD_CAM_LCD_CONV_BYPASS 0: Bypass converter. 1: Enable converter. (R/W)

Register 29.3. LCD_CAM_LCD_USER_REG (0x0014)

LCD_CAM_LCD_CMD_2_CYCLE_EN													LCD_CAM_LCD_ALWAYS_OUT_EN					LCD_CAM_LCD_DOUT_CYCLELEN	
LCD_CAM_LCD_DUMMY_CYCLELEN													(reserved)					LCD_CAM_LCD_DOUT_CYCLELEN	
LCD_CAM_LCD_RESET													LCD_CAM_LCD_UPDATE					LCD_CAM_LCD_UPDATE	
LCD_CAM_LCD_START													LCD_CAM_LCD_BIT_ORDER					LCD_CAM_LCD_BIT_ORDER	
LCD_CAM_LCD_CMD													LCD_CAM_LCD_8BITS_ORDER					LCD_CAM_LCD_8BITS_ORDER	
LCD_CAM_LCD_DUMMY													LCD_CAM_LCD_2BYTE_EN					LCD_CAM_LCD_2BYTE_EN	
LCD_CAM_LCD_DOUT													LCD_CAM_LCD_BYTE_ORDER					LCD_CAM_LCD_BYTE_ORDER	
LCD_CAM_LCD_2BYTE_ORDER													LCD_CAM_LCD_BIT_ORDER					LCD_CAM_LCD_BIT_ORDER	
LCD_CAM_LCD_BIT_ORDER													LCD_CAM_LCD_UPDATE					LCD_CAM_LCD_UPDATE	
LCD_CAM_LCD_UPDATE													LCD_CAM_LCD_8BITS_ORDER					LCD_CAM_LCD_8BITS_ORDER	
LCD_CAM_LCD_8BITS_ORDER													LCD_CAM_LCD_ALWAYS_OUT_EN					LCD_CAM_LCD_ALWAYS_OUT_EN	
LCD_CAM_LCD_ALWAYS_OUT_EN													LCD_CAM_LCD_DOUT_CYCLELEN					LCD_CAM_LCD_DOUT_CYCLELEN	
LCD_CAM_LCD_DOUT_CYCLELEN													LCD_CAM_LCD_DOUT_CYCLELEN					LCD_CAM_LCD_DOUT_CYCLELEN	
31	30	29	28	27	26	25	24	23	22	21	20	19	18	14	13	12	0		
0	0	0	0	0	0	0	0	0	0	0	0	0	0	0	0	0	0x01		

LCD_CAM_LCD_DOUT_CYCLELEN Configure the cycles for DOUT phase of LCD module. The cycles = this value + 1. (R/W)

LCD_CAM_LCD_ALWAYS_OUT_EN LCD continues outputting data when LCD is in DOUT phase, till **LCD_CAM_LCD_START** is cleared or **LCD_CAM_LCD_RESET** is set. (R/W)

LCD_CAM_LCD_8BITS_ORDER 1: Swap every two data bytes, valid in 8-bit mode. 0: Do not swap. (R/W)

LCD_CAM_LCD_UPDATE 1: Update LCD registers. This bit is cleared by hardware. 0: Do not care. (R/W)

LCD_CAM_LCD_BIT_ORDER 1: Change data bit order. Change LCD_DATA_out[7:0] to LCD_DATA_out[0:7] in 8-bit mode, and bits[15:0] to bits[0:15] in 16-bit mode. 0: Do not change. (R/W)

LCD_CAM_LCD_BYTE_ORDER 1: Invert data byte order, only valid in 16-bit mode. 0: Do not invert. (R/W)

LCD_CAM_LCD_2BYTE_EN 1: The width of output LCD data is 16 bits. 0: The width of output LCD data is 8 bits. (R/W)

LCD_CAM_LCD_DOUT 1: Be able to send data out in LCD sequence when LCD starts. 0: Disable. (R/W)

LCD_CAM_LCD_DUMMY 1: Enable DUMMY phase in LCD sequence when LCD starts. 0: Disable. (R/W)

LCD_CAM_LCD_CMD 1: Be able to send command in LCD sequence when LCD starts. 0: Disable. (R/W)

LCD_CAM_LCD_START LCD starts sending data enable signal, valid in high level. (R/W)

LCD_CAM_LCD_RESET Reset LCD module. (WO)

LCD_CAM_LCD_DUMMY_CYCLELEN Configure DUMMY cycles. DUMMY cycles = this value + 1. (R/W)

LCD_CAM_LCD_CMD_2_CYCLE_EN The cycle length of command phase. 1: 2 cycles. 0: 1 cycle. (R/W)

Register 29.4. LCD_CAM_LCD_MISC_REG (0x0018)

31	30	29	28	27	26	25	24	12	11	6	5	1	0
0	0	0	0	0	0	0	0	0x00		0x3		11	0

LCD_CAM_LCD_CD_IDLE_EDGE
 LCD_CAM_LCD_CD_CMD_SET
 LCD_CAM_LCD_CD_DUMMY_SET
 LCD_CAM_LCD_CD_DATA_SET
 LCD_CAM_LCD_AFIFO_RESET
 LCD_CAM_LCD_BK_EN
 LCD_CAM_LCD_NEXT_FRAME_EN
 LCD_CAM_LCD_VBK_CYCLELEN
 LCD_CAM_LCD_VFK_CYCLELEN
 LCD_CAM_LCD_AFIFO_THRESHOLD_NUM
 (reserved)

Reset

LCD_CAM_LCD_AFIFO_THRESHOLD_NUM Set the threshold for Async Tx FIFO full event. (R/W)

LCD_CAM_LCD_VFK_CYCLELEN Configure the setup cycles in LCD non-RGB mode. Setup cycles expected = this value + 1. (R/W)

LCD_CAM_LCD_VBK_CYCLELEN Configure the hold time cycles in LCD non-RGB mode. Hold cycles expected = this value + 1. (R/W)

LCD_CAM_LCD_NEXT_FRAME_EN 1: Send the next frame data when the current frame is sent out. 0: LCD stops when the current frame is sent out. (R/W)

LCD_CAM_LCD_BK_EN 1: Enable blank region when LCD sends data out. 0: No blank region. (R/W)

LCD_CAM_LCD_AFIFO_RESET Async Tx FIFO reset signal. (WO)

LCD_CAM_LCD_CD_DATA_SET 1: LCD_CD = !LCD_CAM_LCD_CD_IDLE_EDGE when LCD is in DOUT phase. 0: LCD_CD = LCD_CAM_LCD_CD_IDLE_EDGE. (R/W)

LCD_CAM_LCD_CD_DUMMY_SET 1: LCD_CD = !LCD_CAM_LCD_CD_IDLE_EDGE when LCD is in DUMMY phase. 0: LCD_CD = LCD_CAM_LCD_CD_IDLE_EDGE. (R/W)

LCD_CAM_LCD_CD_CMD_SET 1: LCD_CD = !LCD_CAM_LCD_CD_IDLE_EDGE when LCD is in CMD phase. 0: LCD_CD = LCD_CAM_LCD_CD_IDLE_EDGE. (R/W)

LCD_CAM_LCD_CD_IDLE_EDGE The default value of LCD_CD. (R/W)

Register 29.5. LCD_CAM_LCD_CTRL_REG (0x001C)

<i>LCD_CAM_LCD_RGB_MODE_EN</i>		<i>LCD_CAM_LCD_VT_HEIGHT</i>		<i>LCD_CAM_LCD_VA_HEIGHT</i>		<i>LCD_CAM_LCD_HB_FRONT</i>	
31	30	21	20	11	10		
0		0		0		0	
							Reset

LCD_CAM_LCD_HB_FRONT It is the horizontal blank front porch of a frame. (R/W)

LCD_CAM_LCD_VA_HEIGHT It is the vertical active height of a frame. (R/W)

LCD_CAM_LCD_VT_HEIGHT It is the vertical total height of a frame. (R/W)

LCD_CAM_LCD_RGB_MODE_EN 1: Enable RGB mode, and input VSYNC, HSYNC, and DE signals. 0: Disable. (R/W)

Register 29.6. LCD_CAM_LCD_CTRL1_REG (0x0020)

<i>LCD_CAM_LCD_HT_WIDTH</i>		<i>LCD_CAM_LCD_HA_WIDTH</i>		<i>LCD_CAM_LCD_VB_FRONT</i>	
31	20	19	8	7	0
0		0		0	
					Reset

LCD_CAM_LCD_VB_FRONT It is the vertical blank front porch of a frame. (R/W)

LCD_CAM_LCD_HA_WIDTH It is the horizontal active width of a frame. (R/W)

LCD_CAM_LCD_HT_WIDTH It is the horizontal total width of a frame. (R/W)

Register 29.7. LCD_CAM_LCD_CTRL2_REG (0x0024)

<i>LCD_CAM_LCD_HSYNC_POSITION</i>		<i>LCD_CAM_LCD_HSYNC_IDLE_POL</i>		<i>LCD_CAM_LCD_HSYNC_WIDTH</i>				<i>(reserved)</i>				<i>LCD_CAM_LCD_HS_BLANK_EN</i>		<i>LCD_CAM_LCD_DE_IDLE_POL</i>		<i>LCD_CAM_LCD_VSYNC_IDLE_POL</i>		<i>LCD_CAM_LCD_VSYNC_WIDTH</i>			
31	24	23	22	16	15	10	9	8	7	6											
0		0		1				0 0 0 0 0 0				0 0		0 0		1					
																				Reset	

LCD_CAM_LCD_VSYNC_WIDTH It is the width of LCD_VSYNC active pulse in a line. (R/W)

LCD_CAM_LCD_VSYNC_IDLE_POL It is the idle value of LCD_VSYNC. (R/W)

LCD_CAM_LCD_DE_IDLE_POL It is the idle value of LCD_DE. (R/W)

LCD_CAM_LCD_HS_BLANK_EN 1: The pulse of LCD_HSYNC is out in vertical blanking lines in RGB mode. 0: LCD_HSYNC pulse is valid only in active region lines in RGB mode. (R/W)

LCD_CAM_LCD_HSYNC_WIDTH It is the width of LCD_HSYNC active pulse in a line. (R/W)

LCD_CAM_LCD_HSYNC_IDLE_POL It is the idle value of LCD_HSYNC. (R/W)

LCD_CAM_LCD_HSYNC_POSITION It is the position of LCD_HSYNC active pulse in a line. (R/W)

Register 29.8. LCD_CAM_LCD_CMD_VAL_REG (0x0028)

<i>LCD_CAM_LCD_CMD_VALUE</i>		
31	0	
0x000000		
		Reset

LCD_CAM_LCD_CMD_VALUE The LCD write command value. (R/W)

Register 29.9. LCD_CAM_LCD_DLY_MODE_REG (0x0030)

(reserved)																LCD_CAM_LCD_VSYNC_MODE				LCD_CAM_LCD_HSYNC_MODE				LCD_CAM_LCD_DE_MODE				LCD_CAM_LCD_CD_MODE			
31																8	7	6	5	4	3	2	1	0							
0	0	0	0	0	0	0	0	0	0	0	0	0	0	0	0	0x0	0x0	0x0	0x0	0x0	0x0	0x0	0x0	0x0	0x0	Reset					

LCD_CAM_LCD_CD_MODE The output LCD_CD is delayed by module clock LCD_CLK. 0: output without delay. 1: delayed by the rising edge of LCD_CLK. 2: delayed by the falling edge of LCD_CLK. (R/W)

LCD_CAM_LCD_DE_MODE The output LCD_DE is delayed by module clock LCD_CLK. 0: output without delay. 1: delayed by the rising edge of LCD_CLK. 2: delayed by the falling edge of LCD_CLK. (R/W)

LCD_CAM_LCD_HSYNC_MODE The output LCD_HSYNC is delayed by module clock LCD_CLK. 0: output without delay. 1: delayed by the rising edge of LCD_CLK. 2: delayed by the falling edge of LCD_CLK. (R/W)

LCD_CAM_LCD_VSYNC_MODE The output LCD_VSYNC is delayed by module clock LCD_CLK. 0: output without delay. 1: delayed by the rising edge of LCD_CLK. 2: delay by the falling edge of LCD_CLK. (R/W)

Register 29.10. LCD_CAM_LCD_DATA_DOUT_MODE_REG (0x0038)

LCD_CAM_DOUT15_MODE		LCD_CAM_DOUT14_MODE		LCD_CAM_DOUT13_MODE		LCD_CAM_DOUT12_MODE		LCD_CAM_DOUT11_MODE		LCD_CAM_DOUT10_MODE		LCD_CAM_DOUT9_MODE		LCD_CAM_DOUT8_MODE		LCD_CAM_DOUT7_MODE		LCD_CAM_DOUT6_MODE		LCD_CAM_DOUT5_MODE		LCD_CAM_DOUT4_MODE		LCD_CAM_DOUT3_MODE		LCD_CAM_DOUT2_MODE		LCD_CAM_DOUT1_MODE		LCD_CAM_DOUT0_MODE		
31	30	29	28	27	26	25	24	23	22	21	20	19	18	17	16	15	14	13	12	11	10	9	8	7	6	5	4	3	2	1	0	
0x0	0x0	0x0	0x0	0x0	0x0	0x0	0x0	0x0	0x0	0x0	0x0	0x0	0x0	0x0	0x0	0x0	0x0	0x0	0x0	0x0	0x0	0x0	0x0	0x0	0x0	0x0	0x0	0x0	0x0	0x0	Reset	

LCD_CAM_DOUT_n_MODE (n = 0 - 15) The output data bit *n* is delayed by module clock LCD_CLK. 0: output without delay. 1: delayed by the rising edge of LCD_CLK. 2: delayed by the falling edge of LCD_CLK. (R/W)

Register 29.11. LCD_CAM_CAM_CTRL_REG (0x0004)

(reserved)		LCD_CAM_CAM_CLK_SEL		LCD_CAM_CAM_CLKM_DIV_A		LCD_CAM_CAM_CLKM_DIV_B		LCD_CAM_CAM_CLKM_DIV_NUM		LCD_CAM_CAM_VS_EOF_EN		LCD_CAM_CAM_LINE_INT_EN		LCD_CAM_CAM_BIT_ORDER		LCD_CAM_CAM_BYTE_ORDER		LCD_CAM_CAM_UPDATE		LCD_CAM_CAM_VSYNC_FILTER_THRES		LCD_CAM_CAM_STOP_EN		
31	30	29	28	23	22	17	16	9	8	7	6	5	4	3	1	0								
0	0		0x0		0x0		4		0	0	0	0	0		0x0								0	Reset

LCD_CAM_CAM_STOP_EN Camera stop enable signal, 1: camera stops when GDMA Rx FIFO is full. 0: Do not stop. (R/W)

LCD_CAM_CAM_VSYNC_FILTER_THRES Filter threshold value for CAM_VSYNC signal. (R/W)

LCD_CAM_CAM_UPDATE 1: Update camera registers. This bit is cleared by hardware. 0: Do not care. (R/W)

LCD_CAM_CAM_BYTE_ORDER 1: Invert data byte order, only valid in 16-bit mode. 0: Do not change. (R/W)

LCD_CAM_CAM_BIT_ORDER 1: Change data bit order, change CAM_DATA_in[7:0] to CAM_DATA_in[0:7] in 8-bit mode, and bits[15:0] to bits[0:15] in 16-bit mode. 0: Do not change. (R/W)

LCD_CAM_CAM_LINE_INT_EN 1: Enable to generate [LCD_CAM_CAM_HS_INT](#). 0: Disable. (R/W)

LCD_CAM_CAM_VS_EOF_EN 1: Enable CAM_VSYNC to generate in_suc_eof. 0: in_suc_eof is controlled by [LCD_CAM_CAM_REC_DATA_BYTELEN](#). (R/W)

LCD_CAM_CAM_CLKM_DIV_NUM Integral camera clock divider value. (R/W)

LCD_CAM_CAM_CLKM_DIV_B Fractional clock divider numerator value. (R/W)

LCD_CAM_CAM_CLKM_DIV_A Fractional clock divider denominator value. (R/W)

LCD_CAM_CAM_CLK_SEL Select camera module source clock. 0: Clock source is disabled. 1: XTAL_CLK. 2: PLL_D2_CLK. 3: PLL_F160M_CLK. (R/W)

Register 29.12. LCD_CAM_CAM_CTRL1_REG (0x0008)

LCD_CAM_CAM_REC_DATA_BYTELEN											LCD_CAM_CAM_LINE_INT_NUM						LCD_CAM_CAM_CLK_INV					LCD_CAM_CAM_VSYNC_FILTER_EN					LCD_CAM_CAM_2BYTE_EN					LCD_CAM_CAM_DE_INV					LCD_CAM_CAM_HSYNC_INV					LCD_CAM_CAM_VSYNC_INV					LCD_CAM_CAM_VH_DE_MODE_EN					LCD_CAM_CAM_START					LCD_CAM_CAM_RESET					LCD_CAM_CAM_AFIFO_RESET				
31	30	29	28	27	26	25	24	23	22	21							16	15												0																																				
0	0	0	0	0	0	0	0	0	0	0	0x0						0x00											0																																						

Reset

LCD_CAM_CAM_REC_DATA_BYTELEN Configure camera received data byte length. When the length of received data reaches this value + 1, GDMA in_suc_eof_int is triggered. (R/W)

LCD_CAM_CAM_LINE_INT_NUM Configure line number. When the number of received lines reaches this value + 1, [LCD_CAM_CAM_HS_INT](#) is triggered. (R/W)

LCD_CAM_CAM_CLK_INV 1: Invert the input signal CAM_PCLK. 0: Do not invert. (R/W)

LCD_CAM_CAM_VSYNC_FILTER_EN 1: Enable CAM_VSYNC filter function. 0: Bypass. (R/W)

LCD_CAM_CAM_2BYTE_EN 1: The width of input data is 16 bits. 0: The width of input data is 8 bits. (R/W)

LCD_CAM_CAM_DE_INV CAM_DE invert enable signal, valid in high level. (R/W)

LCD_CAM_CAM_HSYNC_INV CAM_HSYNC invert enable signal, valid in high level. (R/W)

LCD_CAM_CAM_VSYNC_INV CAM_VSYNC invert enable signal, valid in high level. (R/W)

LCD_CAM_CAM_VH_DE_MODE_EN 1: Input control signals are CAM_DE and CAM_HSYNC. CAM_VSYNC is 1. 0: Input control signals are CAM_DE and CAM_VSYNC. CAM_HSYNC and CAM_DE are all 1 at the the same time. (R/W)

LCD_CAM_CAM_START Camera module start signal. (R/W)

LCD_CAM_CAM_RESET Camera module reset signal. (WO)

LCD_CAM_CAM_AFIFO_RESET Camera Async Rx FIFO reset signal. (WO)

Register 29.14. LCD_CAM_LC_DMA_INT_ENA_REG (0x0064)

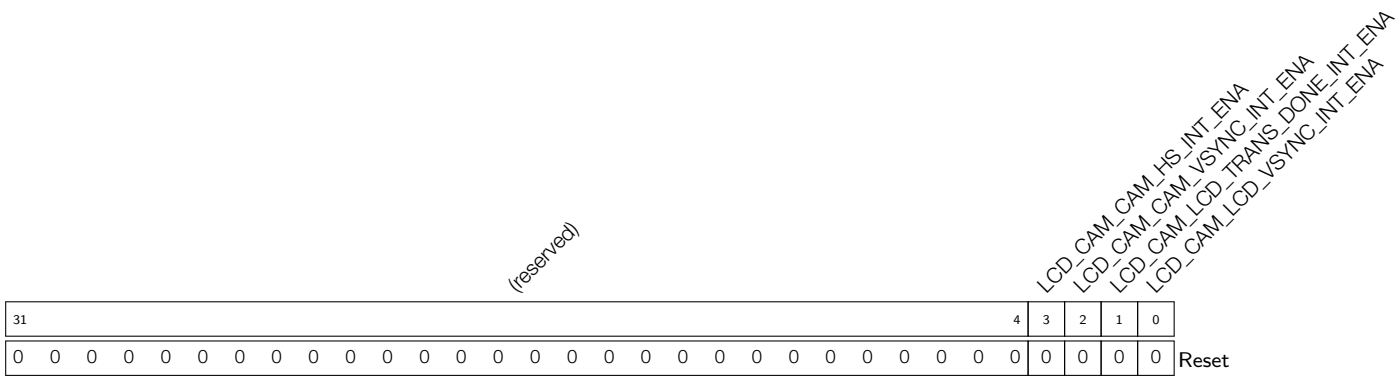

LCD_CAM_LCD_VSYNC_INT_ENA The enable bit for [LCD_CAM_LCD_VSYNC_INT](#) interrupt. (R/W)

LCD_CAM_LCD_TRANS_DONE_INT_ENA The enable bit for [LCD_CAM_LCD_TRANS_DONE_INT](#) interrupt. (R/W)

LCD_CAM_CAM_VSYNC_INT_ENA The enable bit for [LCD_CAM_CAM_VSYNC_INT](#) interrupt. (R/W)

LCD_CAM_CAM_HS_INT_ENA The enable bit for [LCD_CAM_CAM_HS_INT](#) interrupt. (R/W)

Register 29.15. LCD_CAM_LC_DMA_INT_RAW_REG (0x0068)

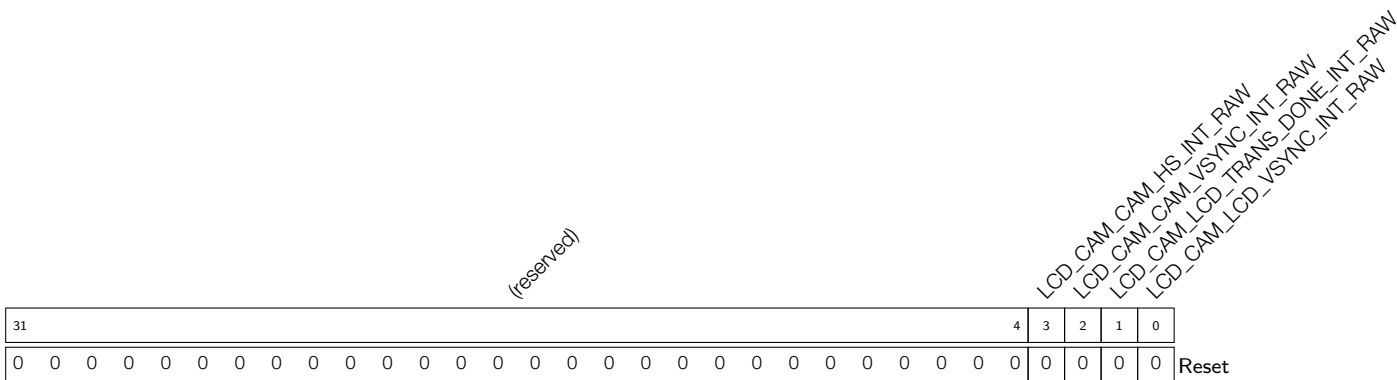

LCD_CAM_LCD_VSYNC_INT_RAW The raw bit for [LCD_CAM_LCD_VSYNC_INT](#) interrupt. (RO)

LCD_CAM_LCD_TRANS_DONE_INT_RAW The raw bit for [LCD_CAM_LCD_TRANS_DONE_INT](#) interrupt. (RO)

LCD_CAM_CAM_VSYNC_INT_RAW The raw bit for [LCD_CAM_CAM_VSYNC_INT](#) interrupt. (RO)

LCD_CAM_CAM_HS_INT_RAW The raw bit for [LCD_CAM_CAM_HS_INT](#) interrupt. (RO)

Register 29.16. LCD_CAM_LC_DMA_INT_ST_REG (0x006C)

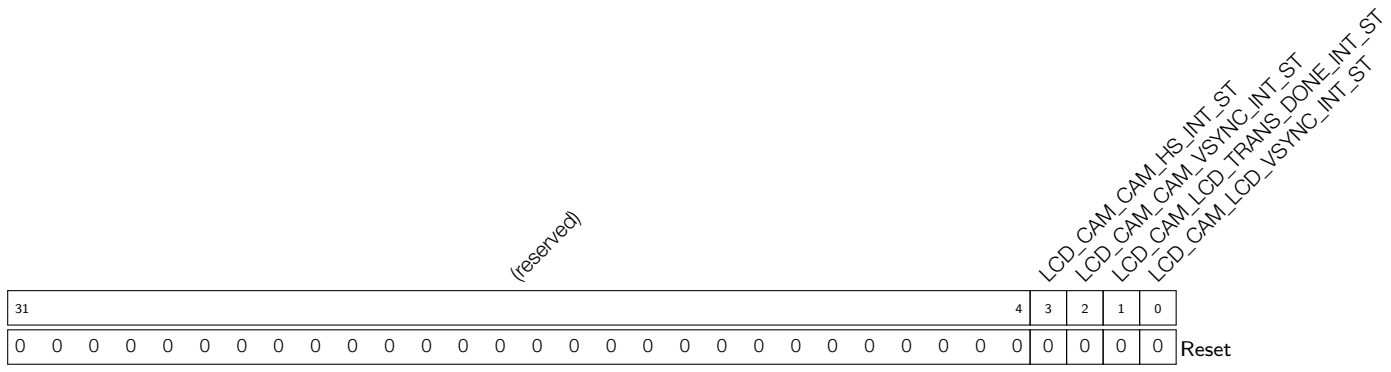

LCD_CAM_LCD_VSYNC_INT_ST The status bit for [LCD_CAM_LCD_VSYNC_INT](#) interrupt. (RO)

LCD_CAM_LCD_TRANS_DONE_INT_ST The status bit for [LCD_CAM_LCD_TRANS_DONE_INT](#) interrupt. (RO)

LCD_CAM_CAM_VSYNC_INT_ST The status bit for [LCD_CAM_CAM_VSYNC_INT](#) interrupt. (RO)

LCD_CAM_CAM_HS_INT_ST The status bit for [LCD_CAM_CAM_HS_INT](#) interrupt. (RO)

Register 29.17. LCD_CAM_LC_DMA_INT_CLR_REG (0x0070)

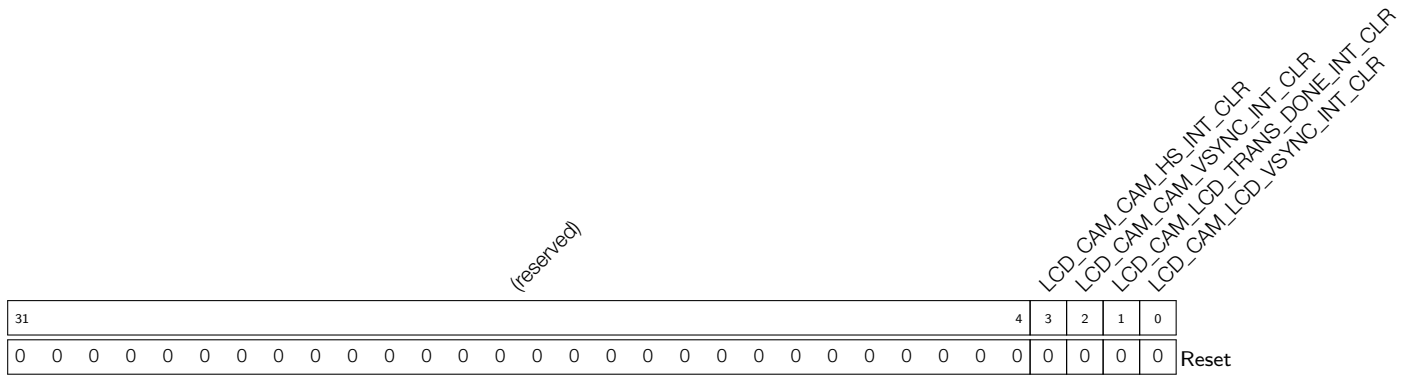

LCD_CAM_LCD_VSYNC_INT_CLR The clear bit for [LCD_CAM_LCD_VSYNC_INT](#) interrupt. (WO)

LCD_CAM_LCD_TRANS_DONE_INT_CLR The clear bit for [LCD_CAM_LCD_TRANS_DONE_INT](#) interrupt. (WO)

LCD_CAM_CAM_VSYNC_INT_CLR The clear bit for [LCD_CAM_CAM_VSYNC_INT](#) interrupt. (WO)

LCD_CAM_CAM_HS_INT_CLR The clear bit for [LCD_CAM_CAM_HS_INT](#) interrupt. (WO)

Register 29.18. LCD_CAM_LC_REG_DATE_REG (0x00FC)

<i>(reserved)</i>				<i>LCD_CAM_LC_DATE</i>																
31	28	27																	0	
0	0	0	0	0x2003020																Reset

LCD_CAM_LC_DATE Version control register (R/W)

30 SPI Controller (SPI)

30.1 Overview

The Serial Peripheral Interface (SPI) is a synchronous serial interface useful for communication with external peripherals. The ESP32-S3 chip integrates four SPI controllers:

- SPI0,
- SPI1,
- General Purpose SPI2 (GP-SPI2),
- and General Purpose SPI3 (GP-SPI3).

SPI0 and SPI1 controllers are primarily reserved for internal use to communicate with external flash and PSRAM memory. This chapter mainly focuses on the GP-SPI controllers, i.e. GP-SPI2 and GP-SPI3. **In this chapter unless otherwise stated, GP-SPI refers to both GP-SPI2 and GP-SPI3.**

30.2 Glossary

To better illustrate the functions of GP-SPI, the following terms are used in this chapter.

Master Mode	GP-SPI acts as an SPI master and initiates SPI transactions.
Slave Mode	GP-SPI acts as an SPI slave and transfers data with its master when its CS is asserted.
MISO	Master in, slave out, data transmission from a slave to a master.
MOSI	Master out, slave in, data transmission from a master to a slave.
Transaction	One instance of a master asserting a CS line, transferring data to and from a slave, and de-asserting the CS line. Transactions are atomic, which means they can never be interrupted by another transaction.
SPI Transfer	The whole process of an SPI master exchanges data with a slave. One SPI transfer consists of one or more SPI transactions.
Single Transfer	An SPI transfer consists of only one transaction.
CPU-Controlled Transfer	A data transfer happens between CPU configured buffer SPI_W0_REG ~ SPI_W15_REG and SPI peripheral.
DMA-Controlled Transfer	A data transfer happens between DMA and SPI peripheral, controlled by DMA engine.
Configurable Segmented Transfer	A data transfer controlled by DMA in SPI master mode. Such transfer consists of multiple transactions (segments), and each of transactions can be configured independently.
Slave Segmented Transfer	A data transfer controlled by DMA in SPI slave mode. Such transfer consists of multiple transactions (segments).
Full-duplex	The sending line and receiving line between the master and the slave are independent. Sending data and receiving data happen at the same time.

Half-duplex	Only one side, the master or the slave, sends data first, and the other side receives data. Sending data and receiving data can not happen at the same time.
4-line full-duplex	4-line here means: clock line, CS line, and two data lines. The two data lines can be used to send or receive data simultaneously.
4-line half-duplex	4-line here means: clock line, CS line, and two data lines. The two data lines can not be used simultaneously.
3-line half-duplex	3-line here means: clock line, CS line, and one data line. The data line is used to transmit or receive data.
1-bit SPI	In one clock cycle, one bit can be transferred.
(2-bit) Dual SPI	In one clock cycle, two bits can be transferred.
Dual Output Read	A data mode of Dual SPI. In one clock cycle, one bit of a command, or one bit of an address, or two bits of data can be transferred.
Dual I/O Read	Another data mode of Dual SPI. In one clock cycle, one bit of a command, or two bits of an address, or two bits of data can be transferred.
(4-bit) Quad SPI	In one clock cycle, four bits can be transferred.
Quad Output Read	A data mode of Quad SPI. In one clock cycle, one bit of a command, or one bit of an address, or four bits of data can be transferred.
Quad I/O Read	Another data mode of Quad SPI. In one clock cycle, one bit of a command, or four bits of an address, or four bits of data can be transferred.
QPI	In one clock cycle, four bits of a command, or four bits of an address, or four bits of data can be transferred.
(8-bit) Octal SPI	In one clock cycle, eight bits can be transferred.
Octal Output Read	A data mode of Octal SPI. In one clock cycle, one bit of a command, or one bit of an address, or eight bits of data can be transferred.
Octal I/O Read	Another data mode of Octal SPI. In one clock cycle, one bit of a command, or eight bits of an address, or eight bits of data can be transferred.
OPI	In one clock cycle, eight bits of a command, or eight bits of an address, or eight bits of data can be transferred.
FSPI	Fast SPI. The prefix of the signals for GP-SPI2. FSPI bus signals are routed to GPIO pins via either GPIO matrix or IO MUX.
SPI3	The prefix of the signals for GP-SPI3. SPI3 bus signals are routed to GPIO pins via GPIO matrix only.

30.3 Features

Some of the key features of GP-SPI are:

- Master and slave modes
- Half- and full-duplex communications
- CPU- and DMA-controlled transfers

- Various data modes:
 - **GP-SPI2:**
 - * 1-bit SPI mode
 - * 2-bit Dual SPI mode
 - * 4-bit Quad SPI mode
 - * QPI mode
 - * 8-bit Octal SPI mode
 - * OPI mode
 - **GP-SPI3:**
 - * 1-bit SPI mode
 - * 2-bit Dual SPI mode
 - * 4-bit Quad SPI mode
 - * QPI mode
- Configurable module clock frequency:
 - Master: up to 80 MHz
 - Slave: up to 60 MHz
- Configurable data length:
 - CPU-controlled transfer in master mode or in slave mode: 1 ~ 64 B
 - DMA-controlled single transfer in master mode: 1 ~ 32 KB
 - DMA-controlled configurable segmented transfer in master mode: data length is unlimited
 - DMA-controlled single transfer or segmented transfer in slave mode: data length is unlimited
- Configurable bit read/write order
- Independent interrupts for CPU-controlled transfer and DMA-controlled transfer
- Configurable clock polarity and phase
- Four SPI clock modes: mode 0 ~ mode 3
- Multiple CS lines in master mode:
 - **GP-SPI2:** CS0 ~ CS5
 - **GP-SPI3:** CS0 ~ CS2
- Able to communicate with SPI devices, such as a sensor, a screen controller, as well as a flash or RAM chip

30.4 Architectural Overview

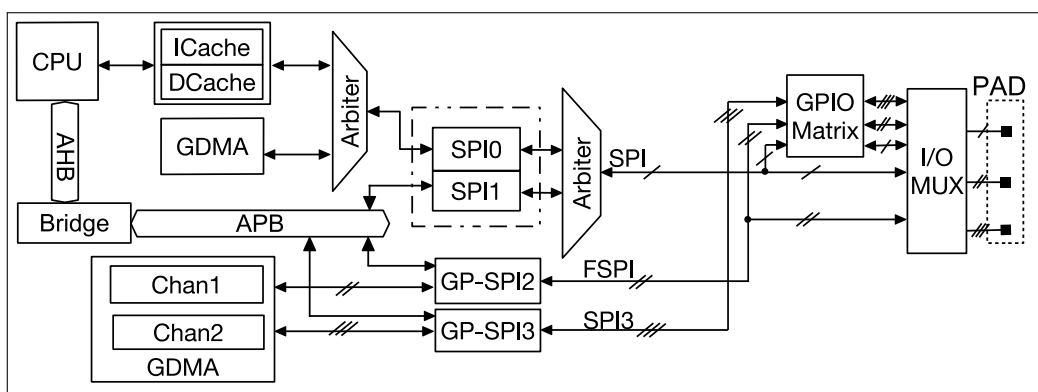

Figure 30-1. SPI Module Overview

Figure 30-1 shows an overview of SPI module. GP-SPI2 and GP-SPI3 exchange data with SPI devices in the following ways:

- CPU-controlled transfer: CPU <-> GP-SPI2 (GP-SPI3) <-> SPI devices
- DMA-controlled transfer: GDMA <-> GP-SPI2 (GP-SPI3) <-> SPI devices

The signals for GP-SPI2 and GP-SPI3 are prefixed with “FSPI” (Fast SPI) and “SPI3”, respectively. FSPI bus signals are routed to GPIO pins via either GPIO matrix or IO MUX. SPI3 bus signals are routed to GPIO pins via GPIO matrix only. For more information, see Chapter 6 *IO MUX and GPIO Matrix (GPIO, IO MUX)*.

The functionalities of GP-SPI3 are nearly the same as those of GP-SPI2. GP-SPI2’s functionalities are described in Section 30.5. The differences between GP-SPI2 and GP-SPI3 are described in Section 30.5.1 and Section 30.9.

30.5 Functional Description

30.5.1 Data Modes

GP-SPI can be configured as either a master or a slave to communicate with other SPI devices in the following data modes, see Table 30-2. As a GP-SPI master, the data modes listed in this table are defined in Section 30.5.8; as a GP-SPI slave, the data modes listed in this table are defined in Section 30.5.9.

Table 30-2. Data Modes Supported by GP-SPI2 and GP-SPI3

Supported Mode		CMD Phase	Address Phase	Data Phase	GP-SPI2	GP-SPI3
1-bit SPI		1-bit	1-bit	1-bit	Y	Y
Dual SPI	Dual Output Read	1-bit	1-bit	2-bit	Y	Y
	Dual I/O Read	1-bit	2-bit	2-bit	Y	Y
Quad SPI	Quad Output Read	1-bit	1-bit	4-bit	Y	Y
	Quad I/O Read	1-bit	4-bit	4-bit	Y	Y
Octal SPI	Octal Output Read	1-bit	1-bit	8-bit	Y	—
	Octal I/O Read	1-bit	8-bit	8-bit	Y	—
QPI		4-bit	4-bit	4-bit	Y	Y
OPI		8-bit	8-bit	8-bit	Y	—

30.5.2 Introduction to FSPI bus and SPI3 Bus Signals

Functional description of FSPI/SPI3 bus signals is shown in Table 30-3. Table 30-4 and Table 30-5 list the signals used in various SPI modes.

Table 30-3. Functional Description of FSPI/SPI3 Bus Signals

FSPI Bus Signal	SPI3 Bus Signal	Function
FSPICLK	SPI3_CLK	Input and output clock in master/slave mode
FSPICS0	SPI3_CS0	Input and output CS signal in master/slave mode
FSPICS1 ~ 5	SPI3_CS1 ~ 2	Output CS signal in master mode
FSPID	SPI3_D	MOSI/SIO0 (serial data input and output, bit0)
FSPIQ	SPI3_Q	MISO/SIO1 (serial data input and output, bit1)
FSPIWP	SPI3_WP	SIO2 (serial data input and output, bit2)
FSPIHD	SPI3_HD	SIO3 (serial data input and output, bit3)
FSPIIO4 ~ 7	—	SIO4 ~ 7 (serial data input and output, bit4 ~ 7)
FSPIDQS	—	Output data mask signal in master mode

Table 30-4. FSPI bus Signals Used in Various SPI Modes

FSPI Signal	Master Mode								Slave Mode					
	1-bit SPI			Dual SPI	Quad SPI	QPI	Octal SPI	OPI	1-bit SPI			Dual SPI	Quad SPI	QPI
	FD ¹	3-line HD ²	4-line HD						FD	3-line HD	4-line HD			
FSPICLK	Y	Y	Y	Y	Y	Y	Y	Y	Y	Y	Y	Y	Y	Y
FSPICS0	Y	Y	Y	Y	Y	Y	Y	Y	Y	Y	Y	Y	Y	Y
FSPICS1	Y	Y	Y	Y	Y	Y	Y	Y						
FSPICS2	Y	Y	Y	Y	Y	Y	Y	Y						
FSPICS3	Y	Y	Y	Y	Y	Y	Y	Y						
FSPICS4	Y	Y	Y	Y	Y	Y	Y	Y						
FSPICS5	Y	Y	Y	Y	Y	Y	Y	Y						
FSPID	Y	Y	(Y) ³	Y ⁴	Y ⁵	Y	Y	Y	Y	Y	(Y) ⁶	Y ⁷	Y ⁸	Y
FSPIQ	Y		(Y) ³	Y ⁴	Y ⁵	Y	Y	Y	Y		(Y) ⁶	Y ⁷	Y ⁸	Y
FSPIWP					Y ⁵	Y	Y	Y					Y ⁸	Y
FSPIHD					Y ⁵	Y	Y	Y					Y ⁸	Y
FSPIO4 ~ 7							Y	Y						
FSPIDQS							Y	Y						

¹ FD: full-duplex

² HD: half-duplex

³ Only one of the two signals is used at a time.

⁴ The two signals are used in parallel.

⁵ The four signals are used in parallel.

⁶ Only one of the two signals is used at a time.

⁷ The two signals are used in parallel.

⁸ The four signals are used in parallel.

Table 30-5. SPI3 bus Signals Used in Various SPI Modes

SPI3 Signal	Master Mode						Slave Mode					
	FD ¹	1-bit SPI		Dual SPI	Quad SPI	QPI	FD	1-bit SPI		Dual SPI	Quad SPI	QPI
		3-line HD ²	4-line HD					3-line HD	4-line HD			
SPI3_CLK	Y	Y	Y	Y	Y	Y	Y	Y	Y	Y	Y	Y
SPI3_CS0	Y	Y	Y	Y	Y	Y	Y	Y	Y	Y	Y	Y
SPI3_CS1	Y	Y	Y	Y	Y	Y						
SPI3_CS2	Y	Y	Y	Y	Y	Y						
SPI3_D	Y	Y	(Y) ³	Y ⁴	Y ⁵	Y	Y	Y	(Y) ⁶	Y ⁷	Y ⁸	Y
SPI3_Q	Y		(Y) ³	Y ⁴	Y ⁵	Y	Y		(Y) ⁶	Y ⁷	Y ⁸	Y
SPI3_WP					Y ⁵	Y					Y ⁸	Y
SPI3_HD					Y ⁵	Y					Y ⁸	Y

¹ FD: full-duplex

² HD: half-duplex

³ Only one of the two signals is used at a time.

⁴ The two signals are used in parallel.

⁵ The four signals are used in parallel.

⁶ Only one of the two signals is used at a time.

⁷ The two signals are used in parallel.

⁸ The four signals are used in parallel.

30.5.3 Bit Read/Write Order Control

In master mode:

- The bit order of the command, address and data sent by the GP-SPI master is controlled by [SPI_WR_BIT_ORDER](#).
- The bit order of the data received by the master is controlled by [SPI_RD_BIT_ORDER](#).

In slave mode:

- The bit order of the data sent by the GP-SPI slave is controlled by [SPI_WR_BIT_ORDER](#).
- The bit order of the command, address and data received by the slave is controlled by [SPI_RD_BIT_ORDER](#).

Table 30-6 shows the function of [SPI_RD/WR_BIT_ORDER](#). In Table 30-6, FSPI Bus signals are used for description. The bit order of SPI3 Bus signals can be referred to Table 30-6.

Table 30-6. Bit Order Control in GP-SPI Master and Slave Modes

Bit Mode	FSPI Bus Signal	SPI_RD/WR_BIT_ORDER = 0 (MSB)	SPI_RD/WR_BIT_ORDER = 2 (MSB)	SPI_RD/WR_BIT_ORDER = 1 (LSB)	SPI_RD/WR_BIT_ORDER = 3 (LSB)
1-bit mode	FSPID or FSPIQ	B7->B6->B5->B4->B3->B2->B1->B0	B7->B6->B5->B4->B3->B2->B1->B0	B0->B1->B2->B3->B4->B5->B6->B7	B0->B1->B2->B3->B4->B5->B6->B7
2-bit mode	FSPIQ	B7->B5->B3->B1	B6->B4->B2->B0	B1->B3->B5->B7	B0->B2->B4->B6
	FSPID	B6->B4->B2->B0	B7->B5->B3->B1	B0->B2->B4->B6	B1->B3->B5->B7
4-bit mode	FSPIHD	B7->B3	B4->B0	B3->B7	B0->B4
	FSPIWP	B6->B2	B5->B1	B2->B6	B1->B5
	FSPIQ	B5->B1	B6->B2	B1->B5	B2->B6
	FSPID	B4->B0	B7->B3	B0->B4	B3->B7
8-bit mode	FSPIO7	B7	B7	B0	B0
	FSPIO6	B6	B6	B1	B1
	FSPIO5	B5	B5	B2	B2
	FSPIO4	B4	B4	B3	B3
	FSPIHD	B3	B3	B4	B4
	FSPIWP	B2	B2	B5	B5
	FSPIQ	B1	B1	B6	B6
	FSPID	B0	B0	B7	B7

30.5.4 Transfer Modes

GP-SPI supports the following transfers when working as a master or a slave.

Table 30-7. Supported Transfers in Master and Slave Modes

Mode		CPU-Controlled Single Transfer	DMA-Controlled Single Transfer	DMA-Controlled Configurable Segmented Transfer*	DMA-Controlled Slave Segmented Transfer
Master	Full-Duplex	Y	Y	Y	—
	Half-Duplex	Y	Y	Y	—
Slave	Full-Duplex	Y	Y	—	Y
	Half-Duplex	Y	Y	—	Y

* DMA-Controlled Configurable Segmented Transfer is not supported on GP-SPI3.

The following sections provide detailed information about the transfer modes listed in the table above.

30.5.5 CPU-Controlled Data Transfer

GP-SPI provides 16 x 32-bit data buffers, i.e., SPI_W0_REG ~ SPI_W15_REG, see Figure 30-2. CPU-controlled transfer indicates the transfer, in which the data to send is from GP-SPI data buffer and the received data is stored to GP-SPI data buffer. In such transfer, every single transaction needs to be triggered by the CPU, after its related registers are configured. For such reason, the CPU-controlled transfer is always single transfers (consisting of only one transaction). CPU-controlled transfer supports full-duplex communication and half-duplex communication.

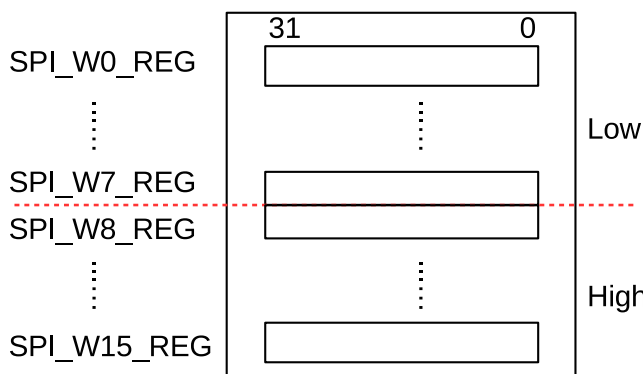

Figure 30-2. Data Buffer Used in CPU-Controlled Transfer

30.5.5.1 CPU-Controlled Master Mode

In a CPU-controlled master full-duplex or half-duplex transfer, the RX or TX data is saved to or sent from SPI_W0_REG ~ SPI_W15_REG. The bits SPI_USR_MOSI_HIGHPART and SPI_USR_MISO_HIGHPART control which buffers are used, see the list below.

- TX data
 - When SPI_USR_MOSI_HIGHPART is cleared, i.e. high part mode is disabled, TX data is from SPI_W0_REG ~ SPI_W15_REG and the data address is incremented by 1 on each byte transferred. If the data byte length is larger than 64, the data in SPI_W0_REG ~ SPI_W15_REG may be sent more

than once. For instance, 66 bytes (byte0 ~ byte65) need to send out, the address of byte65 is the result of $(65 \% 64 = 1)$, i.e. byte65 is from [SPI_W0_REG\[15:8\]](#), and byte64 is from [SPI_W0_REG\[7:0\]](#). For this case, the content of [SPI_W0_REG\[15:0\]](#) may be sent more than once.

- When [SPI_USR_MOSI_HIGHPART](#) is set, i.e. high part mode is enabled, TX data is from [SPI_W8_REG ~ SPI_W15_REG](#) and the data address is incremented by 1 on each byte transferred. If the data byte length is larger than 32, the data in [SPI_W8_REG ~ SPI_W15_REG](#) may be sent more than once.
- RX data
 - When [SPI_USR_MISO_HIGHPART](#) is cleared, i.e. high part mode is disabled, RX data is saved to [SPI_W0_REG ~ SPI_W15_REG](#), and the data address is incremented by 1 on each byte transferred. If the data byte length is larger than 64, the data in [SPI_W0_REG ~ SPI_W15_REG](#) may be overwritten. For instance, 66 bytes (byte0 ~ byte65) are received, byte65 and byte64 will be stored to the addresses of $(65 \% 64 = 1)$ and $(64 \% 64 = 0)$, i.e. [SPI_W0_REG\[15:8\]](#) and [SPI_W0_REG\[7:0\]](#). For this case, the content of [SPI_W0_REG\[15:0\]](#) may be overwritten.
 - When [SPI_USR_MISO_HIGHPART](#) is set, i.e. high part mode is enabled, the RX data is saved to [SPI_W8_REG ~ SPI_W15_REG](#), and the data address is incremented by 1 on each byte transferred. If the data byte length is larger than 32, the content of [SPI_W8_REG ~ SPI_W15_REG](#) may be overwritten.

Note:

- TX/RX data address mentioned above both are byte-addressable. Address 0 stands for [SPI_W0_REG\[7:0\]](#), and Address 1 for [SPI_W0_REG\[15:8\]](#), and so on. The largest address is [SPI_W15_REG\[31:24\]](#).
- To avoid any possible error in TX/RX data, such as TX data being sent more than once or RX data being overwritten, please make sure the registers are configured correctly.

30.5.5.2 CPU-Controlled Slave Mode

In a CPU-controlled slave full-duplex or half-duplex transfer, the RX data or TX data is saved to or sent from [SPI_W0_REG ~ SPI_W15_REG](#), which are byte-addressable.

- In full-duplex communication, the address of [SPI_W0_REG ~ SPI_W15_REG](#) starts from 0 and is incremented by 1 on each byte transferred. If the data address is larger than 63, the content of [SPI_W15_REG\[31:24\]](#) is overwritten.
- In half-duplex communication, the ADDR value in [transmission format](#) is the start address of the RX or TX data, corresponding to the registers [SPI_W0_REG ~ SPI_W15_REG](#). The RX or TX address is incremented by 1 on each byte transferred. If the address is larger than 63 (the highest byte address, i.e. [SPI_W15_REG\[31:24\]](#)), the address of overflowing data is always 63 and only the content of [SPI_W15_REG\[31:24\]](#) is overwritten.

According to your applications, the registers [SPI_W0_REG ~ SPI_W15_REG](#) can be used as:

- data buffers only
- data buffers and status buffers
- status buffers only

30.5.6 DMA-Controlled Data Transfer

DMA-controlled transfer refers to the transfer, in which GDMA RX module receives data and GDMA TX module sends data. This transfer is supported both in master mode and in slave mode.

A DMA-controlled transfer can be

- a single transfer, consisting of only one transaction. GP-SPI supports this transfer both in master and slave modes.
- a configurable segmented transfer, consisting of several transactions (segments). Only GP-SPI2 supports this transfer in master mode. For more information, see Section 30.5.8.5.
- a slave segmented transfer, consisting of several transactions (segments). GP-SPI supports this transfer only in slave mode. For more information, see Section 30.5.9.3.

A DMA-controlled transfer only needs to be triggered once by CPU. When such transfer is triggered, data is transferred by the GDMA engine from or to the DMA-linked memory, without CPU operation.

DMA-controlled transfer supports full-duplex communication, half-duplex communication and functions described in Section 30.5.8 and Section 30.5.9. Meanwhile, the GDMA RX module is independent from the GDMA TX module, which means that there are four kinds of full-duplex communications:

- Data is received in DMA-controlled mode and sent in DMA-controlled mode.
- Data is received in DMA-controlled mode but sent in CPU-controlled mode.
- Data is received in CPU-controlled mode but sent in DMA-controlled mode.
- Data is received in CPU-controlled mode and sent in CPU-controlled mode.

30.5.6.1 GDMA Configuration

- Select a GDMA channel n , and configure a GDMA TX/RX descriptor, see Chapter 3 *GDMA Controller (GDMA)*.
- Set the bit `GDMA_INLINK_START_CH n` /`GDMA_OUTLINK_START_CH n` to start GDMA RX/TX engine.
- Before all the GDMA TX buffer is used or the GDMA TX engine is reset, if `GDMA_OUTLINK_RESTART_CH n` is set, a new TX buffer will be added to the end of the last TX buffer in use.
- GDMA RX buffer is linked in the same way as the GDMA TX buffer, by setting `GDMA_INLINK_START_CH n` or `GDMA_INLINK_RESTART_CH n` .
- The TX and RX data lengths are determined by the configured GDMA TX and RX buffer respectively, both of which can be unlimited.
- Initialize GDMA inlink and outlink before GDMA starts. The bits `SPI_DMA_RX_ENA` and `SPI_DMA_TX_ENA` in register `SPI_DMA_CONF_REG` should be set, otherwise the read/write data will be stored to/sent from the registers `SPI_W0_REG` ~ `SPI_W15_REG`.

In master mode, if `GDMA_IN_SUC_EOF_CH n _INT_ENA` is set, then the interrupt `GDMA_IN_SUC_EOF_CH n _INT` will be triggered when one single transfer or one configurable segmented transfer is finished.

In slave mode, if `GDMA_IN_SUC_EOF_CH n _INT_ENA` is set, then the interrupt `GDMA_IN_SUC_EOF_CH n _INT` will be triggered when one of conditions listed in Table 30-8 are met.

Table 30-8. Interrupt Trigger Condition on GP-SPI Data Transfer in Slave Mode

Transfer Type	Control Bit ¹	Control Bit ²	Condition
Slave Single Transfer	0	0	A single transfer is done.
	1	0	A single transfer is done. Or the length of the received data is equal to (SPI_MS_DATA_BITLEN + 1)
Slave Segmented Transfer	0	1	(CMD7 or End_SEG_TRANS) is received correctly.
	1	1	(CMD7 or End_SEG_TRANS) is received correctly. Or the length of the received data is equal to (SPI_MS_DATA_BITLEN + 1)

¹ SPI_RX_EOF_EN

² SPI_DMA_SLV_SEG_TRANS_EN

30.5.6.2 GDMA TX/RX Buffer Length Control

It is recommended that the length of configured GDMA TX/RX buffer is equal to the length of real transferred data.

- If the length of configured GDMA TX buffer is shorter than that of real transferred data, the extra data will be the same as the last transferred data. SPI_OUTFIFO_EMPTY_ERR_INT and GDMA_OUT_EOF_CH_n_INT are triggered.
- If the length of configured GDMA TX buffer is longer than that of real transferred data, the TX buffer is not fully used, and the remaining buffer is available for following transaction even if a new TX buffer is linked later. Please keep it in mind. Or save the unused data and reset DMA.
- If the length of configured GDMA RX buffer is shorter than that of real transferred data, the extra data will be lost. The interrupts SPI_INFIFO_FULL_ERR_INT and SPI_TRANS_DONE_INT are triggered. But GDMA_IN_SUC_EOF_CH_n_INT interrupt is not generated.
- If the length of configured GDMA RX buffer is longer than that of real transferred data, the RX buffer is not fully used, and the remaining buffer is discarded. In the following transaction, a new linked buffer will be used directly.

30.5.7 Data Flow Control in GP-SPI Master and Slave Modes

CPU-controlled and DMA-controlled transfers are supported in GP-SPI master and slave modes. CPU-controlled transfer means that data transfers between registers SPI_W0_REG ~ SPI_W15_REG and the SPI device. DMA-controlled transfer means that data transfers between the configured GDMA TX/RX buffer and the SPI device. To select between the two transfer modes, configure SPI_DMA_RX_ENA and SPI_DMA_TX_ENA before the transfer starts.

30.5.7.1 GP-SPI Functional Blocks

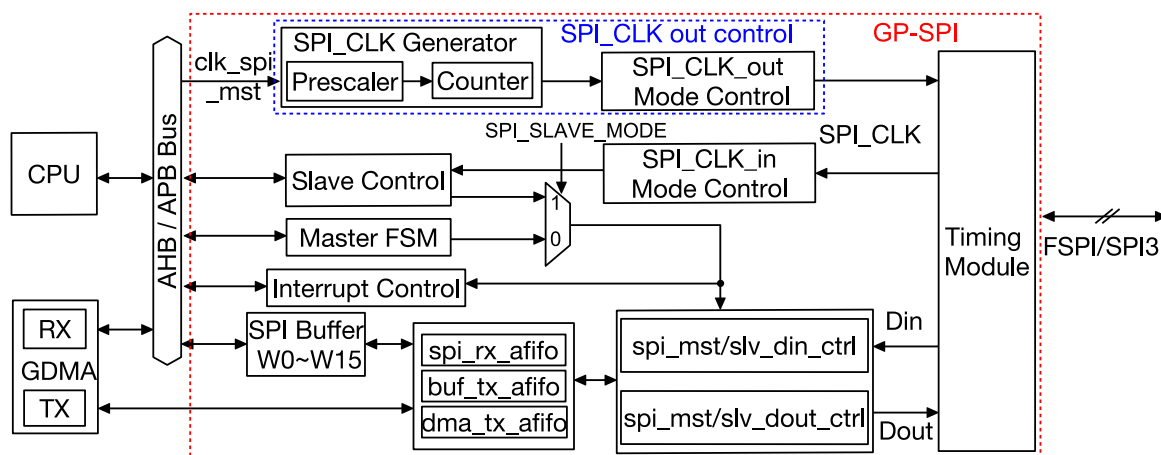

Figure 30-3. GP-SPI Block Diagram

Figure 30-3 shows main functional blocks in GP-SPI, including:

- **Master FSM:** all the features, supported in GP-SPI master mode, are controlled by this state machine together with register configuration.
- **SPI Buffer:** `SPI_W0_REG ~ SPI_W15_REG`, see Figure 30-2. The data transferred in CPU-controlled mode is prepared in this buffer.
- **Timing Module:** capture data on FSPI/SPI3 bus.
- `spi_mst/slv_din/dout_ctrl`: convert the TX/RX data into bytes.
- `spi_rx_afifo`: store the received data.
- `buf_tx_afifo`: store the data to send.
- `dma_tx_afifo`: store the data from GDMA.
- `clk_spi_mst`: this clock is the module clock of GP-SPI and derived from `PLL_CLK`. It is used in GP-SPI master mode, to generate `SPI_CLK` signal for data transfer and for slaves.
- **SPI_CLK Generator:** generate `SPI_CLK` by dividing `clk_spi_mst`. The divider is determined by `SPI_CLKCNT_N` and `SPI_CLKDIV_PRE`.
- **SPI_CLK_out Mode Control:** output the `SPI_CLK` signal for data transfer and for slaves.
- **SPI_CLK_in Mode Control:** capture the `SPI_CLK` signal from SPI master when GP-SPI works as a slave.

30.5.7.2 Data Flow Control in Master Mode

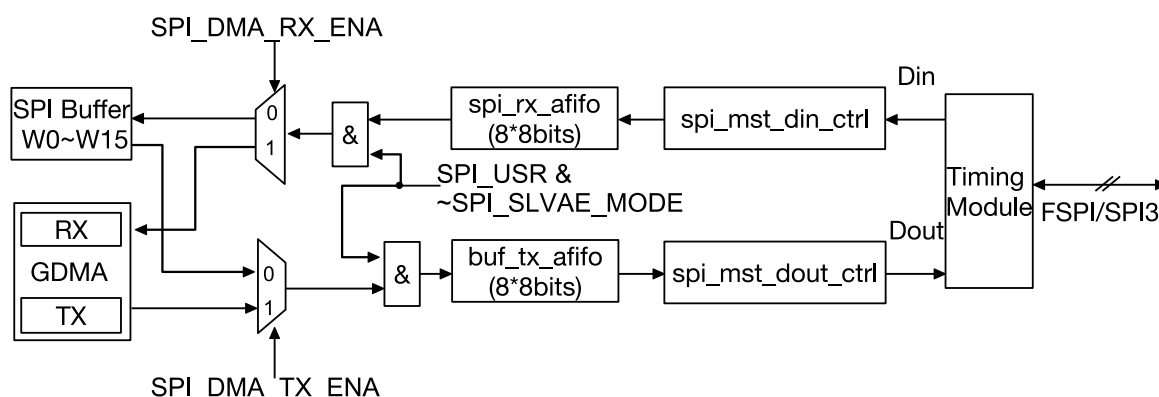

Figure 30-4. Data Flow Control in GP-SPI Master Mode

Figure 30-4 shows the data flow of GP-SPI in master mode. Its control logic is as follows:

- RX data: data in FSPi/SPI3 bus is captured by Timing Module, converted in units of bytes by spi_mst_din_ctrl module, then buffered in spi_rx_afifo, and finally stored in corresponding addresses according to the transfer modes.
 - CPU-controlled transfer: the data is stored to registers SPI_W0_REG ~ SPI_W15_REG.
 - DMA-controlled transfer: the data is stored to GDMA RX buffer.
- TX data: the TX data is from corresponding addresses according to transfer modes and is saved to buf_tx_afifo.
 - CPU-controlled transfer: TX data is from SPI_W0_REG ~ SPI_W15_REG.
 - DMA-controlled transfer: TX data is from GDMA TX buffer.

The data in buf_tx_afifo is sent out to Timing Module in 1/2/4/8-bit modes, controlled by GP-SPI state machine. The Timing Module can be used for timing compensation. For more information, see Section 30.8.

30.5.7.3 Data Flow Control in Slave Mode

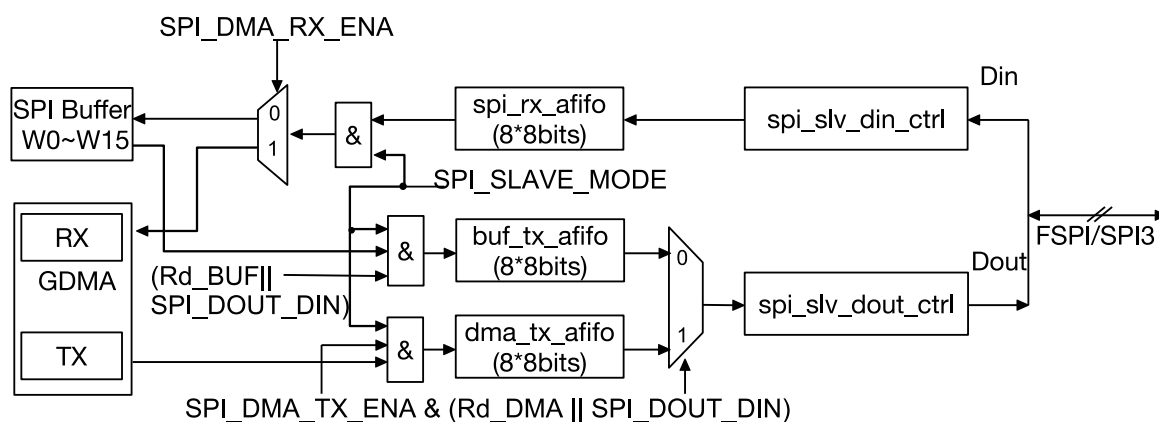

Figure 30-5. Data Flow Control in GP-SPI Slave Mode

Figure 30-5 shows the data flow in GP-SPI slave mode. Its control logic is as follows:

- In CPU/DMA-controlled full-duplex/half-duplex modes, when an external SPI master starts the SPI transfer, data on the FSPI/SPI3 bus is captured, converted into unit of bytes by `spi_slv_din_ctrl` module, and then is stored in `spi_rx_afifo`.
 - In CPU-controlled full-duplex transfer, the received data in `spi_rx_afifo` will be later stored into registers `SPI_W0_REG ~ SPI_W15_REG`, successively.
 - In half-duplex `Wr_BUF` transfer, when the value of address (`SLV_ADDR[7:0]`) is received, the received data in `spi_rx_afifo` will be stored in the related address of registers `SPI_W0_REG ~ SPI_W15_REG`.
 - In DMA-controlled full-duplex transfer or in half-duplex `Wr_DMA` transfer, the received data in `spi_rx_afifo` will be stored in the configured GDMA RX buffer.
- In CPU-controlled full-/half-duplex transfer, the data to send is stored in `buf_tx_afifo`. In DMA-controlled full-/half-duplex transfer, the data to send is stored in `dma_tx_afifo`. Therefore, `Rd_BUF` transaction controlled by CPU and `Rd_DMA` transaction controlled by DMA can be done in one slave segmented transfer. TX data comes from corresponding addresses according to the transfer modes.
 - In CPU-controlled full-duplex transfer, when `SPI_SLAVE_MODE` and `SPI_DOUTDIN` are set and `SPI_DMA_TX_ENA` is cleared, the data in `SPI_W0_REG ~ SPI_W15_REG` will be stored into `buf_tx_afifo`.
 - In CPU-controlled half-duplex transfer, when `SPI_SLAVE_MODE` is set, `SPI_DOUTDIN` is cleared, `Rd_BUF` command and `SLV_ADDR[7:0]` are received, the data started from the related address of `SPI_W0_REG ~ SPI_W15_REG` will be stored into `buf_tx_afifo`.
 - In DMA-controlled full-duplex transfer, when `SPI_SLAVE_MODE`, `SPI_DOUTDIN` and `SPI_DMA_TX_ENA` are set, the data in the configured GDMA TX buffer will be stored into `dma_tx_afifo`.
 - In DMA-controlled half-duplex transfer, when `SPI_SLAVE_MODE` is set, `SPI_DOUTDIN` is cleared, and `Rd_DMA` command is received, the data in the configured GDMA TX buffer will be stored into `dma_tx_afifo`.

The data in `buf_tx_afifo` or `dma_tx_afifo` is sent out by `spi_slv_dout_ctrl` module in 1/2/4-bit modes.

30.5.8 GP-SPI Works as a Master

GP-SPI can be configured as a SPI master by clearing the bit `SPI_SLAVE_MODE` in `SPI_SLAVE_REG`. In this operation mode, GP-SPI provides clock signal (the divided clock from GP-SPI module clock) and six CS lines (`CS0 ~ CS5`).

Note:

- The length of transferred data must be in unit of bytes, otherwise the extra bits will be lost. The extra bits here means the result of total data bits % 8.
- To transfer bits not in unit of bytes, consider implementing it in CMD state or ADDR state.

30.5.8.1 State Machine

When GP-SPI works as a master, the state machine controls its various states during data transfer, including configuration (CONF), preparation (PREP), command (CMD), address (ADDR), dummy (DUMMY), data out (DOUT), and data in (DIN) states. GP-SPI is mainly used to access 1/2/4/8-bit SPI devices, such as flash and external RAM, thus the naming of GP-SPI states keeps consistent with the sequence naming of flash and external RAM. The meaning of each state is described as follows and Figure 30-6 shows the workflow of GP-SPI state machine.

1. IDLE: GP-SPI is not active or is in slave mode.
2. CONF: only used in DMA-controlled [configurable segmented transfer](#) (valid only for GP-SPI2). Set [SPI_USR](#) and [SPI_USR_CONF](#) to enable this state. If this state is not enabled, it means the current transfer is a single transfer.
3. PREP: prepare an SPI transaction and control SPI CS setup time. Set [SPI_USR](#) and [SPI_CS_SETUP](#) to enable this state.
4. CMD: send command sequence. Set [SPI_USR](#) and [SPI_USR_COMMAND](#) to enable this state.
5. ADDR: send address sequence. Set [SPI_USR](#) and [SPI_USR_ADDR](#) to enable this state.
6. DUMMY (wait cycle): send dummy sequence. Set [SPI_USR](#) and [SPI_USR_DUMMY](#) to enable this state.
7. DATA: transfer data.
 - DOUT: send data sequence. Set [SPI_USR](#) and [SPI_USR_MOSI](#) to enable this state.
 - DIN: receive data sequence. Set [SPI_USR](#) and [SPI_USR_MISO](#) to enable this state.
8. DONE: control SPI CS hold time. Set [SPI_USR](#) to enable this state.

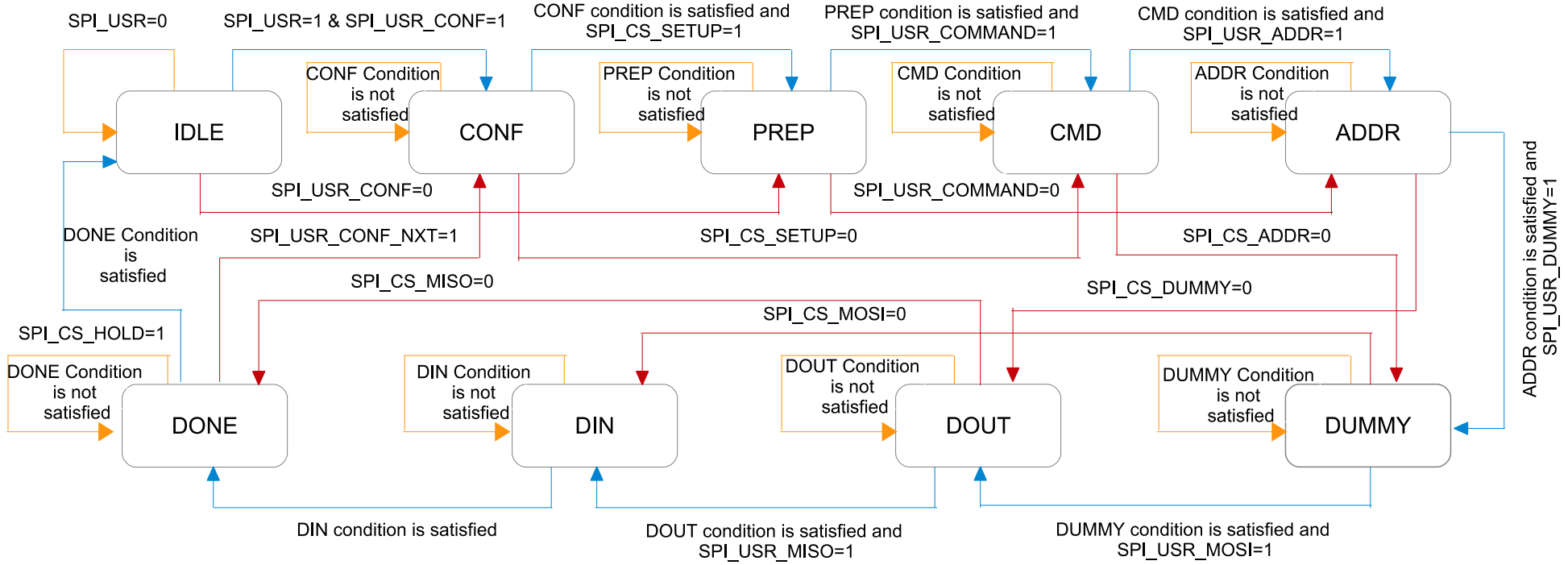

Figure 30-6. GP-SPI State Machine in Master Mode

Legend to state flow:

- —: indicates corresponding state condition is not satisfied; repeats current state.
- —: corresponding registers are set and conditions are satisfied; goes to next state.
- —: state registers are not set; skips one or more following states, depending on the registers of the following states are set or not.

Explanation of the conditions listed in the figure above:

- CONF condition: $gpc[17:0] \geq SPI_CONF_BITLEN[17:0]$
- PREP condition: $gpc[4:0] \geq SPI_CS_SETUP_TIME[4:0]$
- CMD condition: $gpc[3:0] \geq SPI_USR_COMMAND_BITLEN[3:0]$
- ADDR condition: $gpc[4:0] \geq SPI_USR_ADDR_BITLEN[4:0]$
- DUMMY condition: $gpc[7:0] \geq SPI_USR_DUMMY_CYCLELEN[7:0]$
- DOUT condition: $gpc[17:0] \geq SPI_MS_DATA_BITLEN[17:0]$
- DIN condition: $gpc[17:0] \geq SPI_MS_DATA_BITLEN[17:0]$
- DONE condition: $(gpc[4:0] \geq SPI_CS_HOLD_TIME[4:0] \parallel SPI_CS_HOLD == 1'b0)$

A counter ($gpc[17:0]$) is used in the state machine to control the cycle length of each state. The states CONF, PREP, CMD, ADDR, DUMMY, DOUT, and DIN can be enabled or disabled independently. The cycle length of each state can also be configured independently.

30.5.8.2 Register Configuration for State and Bit Mode Control

Introduction

The registers, related to GP-SPI state control, are listed in Table 30-9. Users can enable QPI mode for GP-SPI by setting the bit `SPI_QPI_MODE` in register `SPI_USER_REG`.

Table 30-9. Registers Used for State Control in 1/2/4/8-bit Modes

State	Control Registers for 1-bit Mode FSPI/SPI3 Bus	Control Registers for 2-bit Mode FSPI/SPI3 Bus	Control Registers for 4-bit Mode FSPI/SPI3 Bus	Control Registers for 8-bit Mode FSPI/SPI3 Bus
CMD	SPI_USR_COMMAND_VALUE SPI_USR_COMMAND_BITLEN SPI_USR_COMMAND	SPI_USR_COMMAND_VALUE SPI_USR_COMMAND_BITLEN SPI_FCMD_DUAL SPI_USR_COMMAND	SPI_USR_COMMAND_VALUE SPI_USR_COMMAND_BITLEN SPI_FCMD_QUAD SPI_USR_COMMAND	SPI_USR_COMMAND_VALUE SPI_USR_COMMAND_BITLEN SPI_FCMD_OCT SPI_USR_COMMAND
ADDR	SPI_USR_ADDR_VALUE SPI_USR_ADDR_BITLEN SPI_USR_ADDR	SPI_USR_ADDR_VALUE SPI_USR_ADDR_BITLEN SPI_USR_ADDR SPI_FADDR_DUAL	SPI_USR_ADDR_VALUE SPI_USR_ADDR_BITLEN SPI_USR_ADDR SPI_FADDR_QUAD	SPI_USR_ADDR_VALUE SPI_USR_ADDR_BITLEN SPI_USR_ADDR SPI_FADDR_OCT
DUMMY	SPI_USR_DUMMY_CYCLELEN SPI_USR_DUMMY	SPI_USR_DUMMY_CYCLELEN SPI_USR_DUMMY	SPI_USR_DUMMY_CYCLELEN SPI_USR_DUMMY	SPI_USR_DUMMY_CYCLELEN SPI_USR_DUMMY
DIN	SPI_USR_MISO SPI_MS_DATA_BITLEN	SPI_USR_MISO SPI_MS_DATA_BITLEN SPI_FREAD_DUAL	SPI_USR_MISO SPI_MS_DATA_BITLEN SPI_FREAD_QUAD	SPI_USR_MISO SPI_MS_DATA_BITLEN SPI_FREAD_OCT
DOUT	SPI_USR_MOSI SPI_MS_DATA_BITLEN	SPI_USR_MOSI SPI_MS_DATA_BITLEN SPI_FWRITE_DUAL	SPI_USR_MOSI SPI_MS_DATA_BITLEN SPI_FWRITE_QUAD	SPI_USR_MOSI SPI_MS_DATA_BITLEN SPI_FWRITE_OCT

As shown in Table 30-9, the registers in each cell should be configured to set the FSPI/SPI3 bus to corresponding bit mode, i.e. the mode shown in the table header, at a specific state (corresponding to the first column).

Configuration

For instance, when GP-SPI reads data, and

- CMD is in 1-bit mode
- ADDR is in 2-bit mode
- DUMMY is 8 clock cycles
- DIN is in 4-bit mode

The register configuration can be as follows:

1. Configure CMD state related registers.
 - Configure the required command value in [SPI_USR_COMMAND_VALUE](#).
 - Configure command bit length in [SPI_USR_COMMAND_BITLEN](#). [SPI_USR_COMMAND_BITLEN](#) = expected bit length - 1.
 - Set [SPI_USR_COMMAND](#).
 - Clear [SPI_FCMD_DUAL](#) and [SPI_FCMD_QUAD](#).
2. Configure ADDR state related registers.
 - Configure the required address value in [SPI_USR_ADDR_VALUE](#).
 - Configure address bit length in [SPI_USR_ADDR_BITLEN](#). [SPI_USR_ADDR_BITLEN](#) = expected bit length - 1.
 - Set [SPI_USR_ADDR](#) and [SPI_FADDR_DUAL](#).
 - Clear [SPI_FADDR_QUAD](#).
3. Configure DUMMY state related registers.
 - Configure DUMMY cycles in [SPI_USR_DUMMY_CYCLELEN](#). [SPI_USR_DUMMY_CYCLELEN](#) = expected clock cycles - 1.
 - Set [SPI_USR_DUMMY](#).
4. Configure DIN state related registers.
 - Configure read data bit length in [SPI_MS_DATA_BITLEN](#). [SPI_MS_DATA_BITLEN](#) = bit length expected - 1.
 - Set [SPI_FREAD_QUAD](#) and [SPI_USR_MISO](#).
 - Clear [SPI_FREAD_DUAL](#).
 - Configure GDMA in DMA-controlled mode. In CPU controlled mode, no action is needed.
5. Clear [SPI_USR_MOSI](#).
6. Set [SPI_DMA_AFIFO_RST](#), [SPI_BUF_AFIFO_RST](#), and [SPI_RX_AFIFO_RST](#) to reset these buffers.
7. Set [SPI_USR](#) to start GP-SPI transfer.

When writing data (DOUT state), [SPI_USR_MOSI](#) should be configured instead, while [SPI_USR_MISO](#) should be cleared. The output data bit length is the value of [SPI_MS_DATA_BITLEN](#) + 1. Output data should be configured in GP-SPI data buffer ([SPI_W0_REG](#) ~ [SPI_W15_REG](#)) in CPU-controlled mode, or GDMA TX buffer in DMA-controlled mode. The data byte order is incremented from LSB (byte 0) to MSB.

Pay special attention to the command value in [SPI_USR_COMMAND_VALUE](#) and to address value in [SPI_USR_ADDR_VALUE](#).

The configuration of command value is as follows:

Table 30-10. Sending Sequence of Command Value

COMMAND_BITLEN ¹	COMMAND_VALUE ²	BIT_ORDER ³	Sending Sequence of Command Value
0 - 7	[7:0]	1	COMMAND_VALUE [COMMAND_BITLEN :0] is sent first.
		0	COMMAND_VALUE [7:7 - COMMAND_BITLEN] is sent first.
8 - 15	[15:0]	1	COMMAND_VALUE [7:0] is sent first, and then COMMAND_VALUE [COMMAND_BITLEN :8] is sent.
		0	COMMAND_VALUE [7:0] is sent first, and then COMMAND_VALUE [15:15 - COMMAND_BITLEN] is sent.

¹ [SPI_USR_COMMAND_BITLEN](#): this field is used to configure the bit length of the command.

² [SPI_USR_COMMAND_VALUE](#): command value is written into this field. For which part of this field is used, see the table above.

³ [SPI_WR_BIT_ORDER](#): 0: LSB first; 1: MSB first.

The configuration of address value is as follows:

Table 30-11. Sending Sequence of Address Value

ADDR_BITLEN ¹	ADDR_VALUE ²	BIT_ORDER ³	Sending Sequence of Address Value
0 - 7	[31:24]	1	COMMAND_VALUE[ADDR_BITLEN + 24:24] is sent first.
		0	ADDR_VALUE[31:31 - ADDR_BITLEN] is sent first.
8 - 15	[31:16]	1	ADDR_VALUE[31:24] is sent first, and then ADDR_VALUE[ADDR_BITLEN + 8:16] is sent.
		0	ADDR_VALUE[31:24] is sent first, and then ADDR_VALUE[23:31 - ADDR_BITLEN] is sent.
16 - 23	[31:8]	1	ADDR_VALUE[31:16] is sent first, and then ADDR_VALUE[ADDR_BITLEN - 8:8] is sent.
		0	ADDR_VALUE[31:16] is sent first, and then ADDR_VALUE[15:31 - ADDR_BITLEN] is sent.
24 - 31	[31:0]	1	ADDR_VALUE[31:8] is sent first, and then ADDR_VALUE[ADDR_BITLEN - 24:0] is sent.
		0	ADDR_VALUE[31:8] is sent first, and then ADDR_VALUE[7:31 - ADDR_BITLEN] is sent.

¹ SPI_USR_ADDR_BITLEN: this field is used to configure the bit length of the address.

² SPI_USR_ADDR_VALUE: address value is written into this field. For which part of this field is used, see the table above.

³ SPI_WR_BIT_ORDER: 0: LSB first; 1: MSB first.

30.5.8.3 Full-Duplex Communication (1-bit Mode Only)

Introduction

GP-SPI supports SPI full-duplex communication. In this mode, SPI master provides CLK and CS signals, exchanging data with SPI slave in 1-bit mode via MOSI (FSPID/SPI3_D, sending) and MISO (FSPIQ/SPI3_Q, receiving) at the same time. To enable this communication mode, set the bit SPI_DOUTDIN in register SPI_USER_REG. Figure 30-7 illustrates the connection of GP-SPI2 with its slave in full-duplex communication.

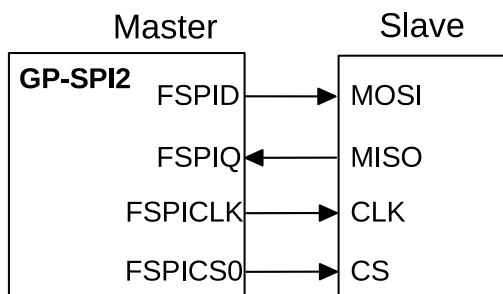

Figure 30-7. Full-Duplex Communication Between GP-SPI2 Master and a Slave

In full-duplex communication, the behavior of states CMD, ADDR, DUMMY, DOUT and DIN are configurable. Usually, the states CMD, ADDR and DUMMY are not used in this communication. The bit length of transferred

data is configured in [SPI_MS_DATA_BITLEN](#). The actual bit length used in communication equals to ([SPI_MS_DATA_BITLEN](#) + 1).

Configuration (Take GP-SPI2 as an example)

To start a data transfer, follow the steps below:

- Configure the IO path via IO MUX or GPIO matrix between GP-SPI2 and an external SPI device.
- Configure APB clock (APB_CLK, see Chapter 7 *Reset and Clock*) and module clock (clk_spi_mst) for the GP-SPI2 module.
- Set [SPI_DOUTDIN](#) and clear [SPI_SLAVE_MODE](#), to enable full-duplex communication in master mode.
- Configure GP-SPI2 registers listed in Table 30-9.
- Configure SPI CS setup time and hold time according to Section 30.6.
- Set the property of FSPICLK according to Section 30.7.
- Prepare data according to the selected transfer mode:
 - In CPU-controlled MOSI mode, prepare data in registers [SPI_W0_REG](#) ~ [SPI_W15_REG](#).
 - In DMA-controlled mode,
 - * configure [SPI_DMA_TX_ENA/SPI_DMA_RX_ENA](#)
 - * configure GDMA TX/RX link
 - * start GDMA TX/RX engine, as described in Section 30.5.6 and Section 30.5.7.
- Configure interrupts and wait for SPI slave to get ready for transfer.
- Set [SPI_DMA_AFIFO_RST](#), [SPI_BUF_AFIFO_RST](#), and [SPI_RX_AFIFO_RST](#) to reset these buffers.
- Set [SPI_USR](#) in register [SPI_CMD_REG](#) to start the transfer and wait for the configured interrupts.

30.5.8.4 Half-Duplex Communication (1/2/4/8-bit Mode)

Introduction

In this mode, GP-SPI provides CLK and CS signals. Only one side (SPI master or slave) can send data at a time, while the other side receives the data. To enable this communication mode, clear the bit [SPI_DOUTDIN](#) in register [SPI_USER_REG](#). The standard format of SPI half-duplex communication is CMD + [ADDR +] [DUMMY +] [DOUT or DIN]. The states ADDR, DUMMY, DOUT, and DIN are optional, and can be disabled or enabled independently.

As described in Section 30.5.8.2, the properties of GP-SPI states: CMD, ADDR, DUMMY, DOUT and DIN, such as cycle length, value, and parallel bus bit mode, can be set independently. For the register configuration, see Table 30-9.

The detailed properties of half-duplex GP-SPI are as follows:

1. CMD: 0 ~ 16 bits, master output, slave input.
2. ADDR: 0 ~ 32 bits, master output, slave input.
3. DUMMY: 0 ~ 256 FSPICLK/SPI3_CLK cycles, master output, slave input.

4. DOUT: 0 ~ 64 B in CPU-controlled mode, 0 ~ 32 KB in DMA-controlled single transfer mode and unlimited data length in DMA-controlled configurable segmented mode; master output, slave input.
5. DIN: 0 ~ 64 B in CPU-controlled mode and 0 ~ 32 KB in DMA-controlled single transfer mode and unlimited data length in DMA-controlled configurable segmented mode; master input, slave output.

Configuration (Take GP-SPI2 as an example)

The register configuration is as follows:

1. Configure the IO path via IO MUX or GPIO matrix between GP-SPI2 and an external SPI device.
2. Configure APB clock (APB_CLK) and module clock (clk_spi_mst) for the GP-SPI2 module.
3. Clear [SPI_DOUTDIN](#) and [SPI_SLAVE_MODE](#), to enable half-duplex communication in master mode.
4. Configure GP-SPI2 registers listed in Table 30-9.
5. Configure SPI CS setup time and hold time according to Section 30.6.
6. Set the property of FSPICLK according to Section 30.7.
7. Prepare data according to the selected transfer mode:
 - In CPU-controlled MOSI mode, prepare data in registers [SPI_W0_REG](#) ~ [SPI_W15_REG](#).
 - In DMA-controlled mode,
 - configure [SPI_DMA_TX_ENA/SPI_DMA_RX_ENA](#);
 - configure GDMA TX/RX link;
 - start GDMA TX/RX engine, as described in Section 30.5.6 and Section 30.5.7.
8. Configure interrupts and wait for SPI slave to get ready for transfer.
9. Set [SPI_DMA_AFIFO_RST](#), [SPI_BUF_AFIFO_RST](#), and [SPI_RX_AFIFO_RST](#) to reset these buffers.
10. Set [SPI_USR](#) in register [SPI_CMD_REG](#) to start the transfer and wait for the configured interrupts.

Application Example

The following example shows how GP-SPI2 accesses flash and external RAM in master half-duplex mode.

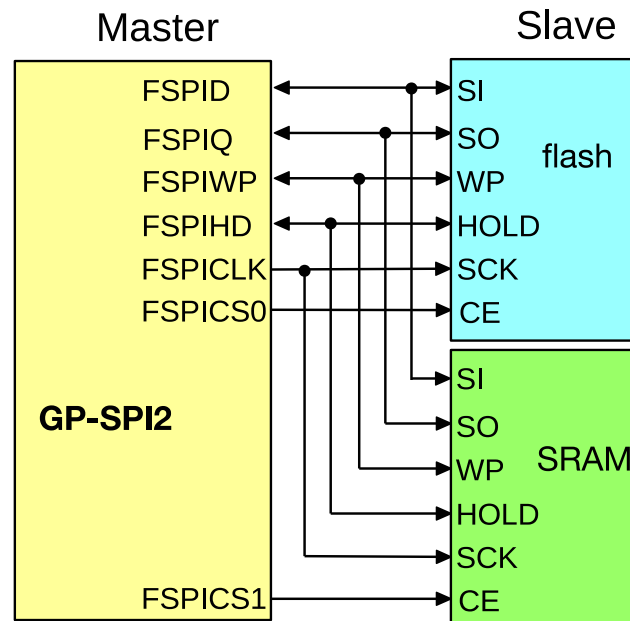

Figure 30-8. Connection of GP-SPI2 to Flash and External RAM in 4-bit Mode

Figure 30-9 indicates GP-SPI2 Quad I/O Read sequence according to standard flash specification. Other GP-SPI2 command sequences are implemented in accordance with the requirements of SPI slaves.

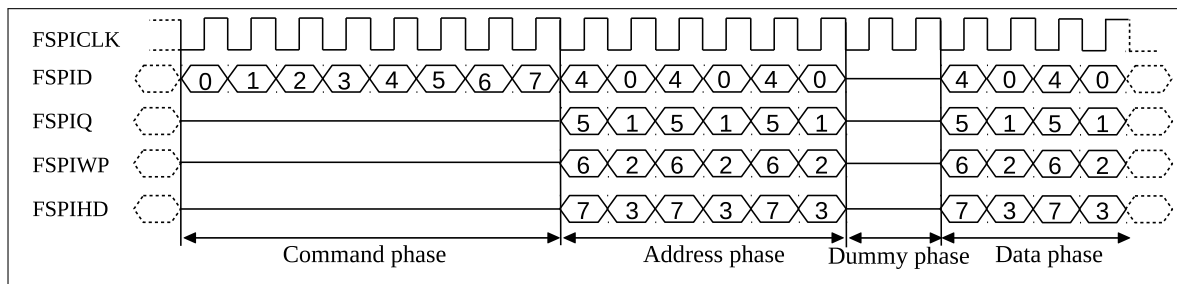

Figure 30-9. SPI Quad I/O Read Command Sequence Sent by GP-SPI2 to Flash

30.5.8.5 DMA-Controlled Configurable Segmented Transfer

Note:

- This feature is only supported by GP-SPI2.
- Note that there is no separate section on how to configure a single transfer in master mode, since the CONF state of a configurable segmented transfer can be skipped to implement a single transfer.

Introduction

When GP-SPI2 works as a master, it provides a feature named: configurable segmented transfer controlled by DMA.

A DMA-controlled transfer in master mode can be

- a single transfer, consisting of only one transaction;
- or a configurable segmented transfer, consisting of several transactions (segments).

In a configurable segmented transfer, the registers of each single transaction (segment) are configurable. This feature enables GP-SPI2 to do as many transactions (segments) as configured after such transfer is triggered once by the CPU. Figure 30-10 shows how this feature works.

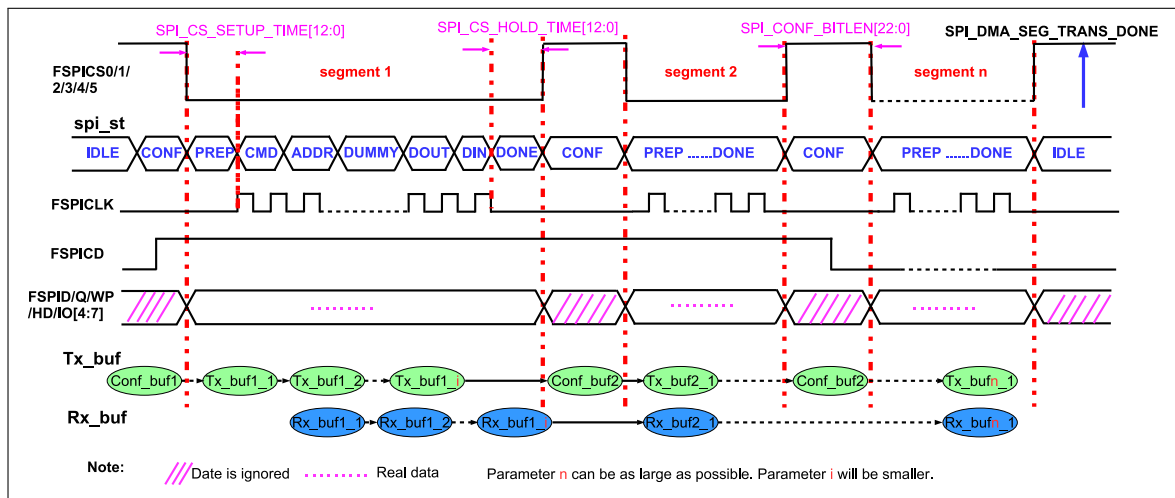

Figure 30-10. Configurable Segmented Transfer in DMA-Controlled Master Mode

As shown in Figure 30-10, the registers for one transaction (segment *n*) can be reconfigured by GP-SPI2 hardware according to the content in its Conf_buf_{*n*} during a CONF state, before this segment starts.

It's recommended to provide separate GDMA CONF links and CONF buffers (Conf_buf_{*i*} in Figure 30-10) for each CONF state. A GDMA TX link is used to connect all the CONF buffers and TX data buffers (Tx_buf_{*i*} in Figure 30-10) into a chain. Hence, the behavior of the FSPI bus in each segment can be controlled independently.

For example, in a configurable segmented transfer, its segment_{*i*}, segment_{*j*}, and segment_{*k*} can be configured to full-duplex, half-duplex MISO, and half-duplex MOSI, respectively. *i*, *j*, and *k* are integer variables, which can be any segment number.

Meanwhile, the state of GP-SPI2, the data length and cycle length of the FSPI bus, and the behavior of the GDMA, can be configured independently for each segment. When this whole DMA-controlled transfer (consisting of several segments) has finished, a GP-SPI2 interrupt, SPI_DMA_SEG_TRANS_DONE_INT, is triggered.

Configuration

1. Configure the IO path via IO MUX or GPIO matrix between GP-SPI2 and an external SPI device.
2. Configure APB clock (APB_CLK) and module clock (clk_spi_mst) for GP-SPI2 module.
3. Clear SPI_DOUTDIN and SPI_SLAVE_MODE, to enable half-duplex communication in master mode.
4. Configure GP-SPI2 registers listed in Table 30-9.
5. Configure SPI CS setup time and hold time according to Section 30.6.
6. Set the property of FSPICLK according to Section 30.7.
7. Prepare descriptors for GDMA CONF buffer and TX data (optional) for each segment. Chain the descriptors of CONF buffer and TX buffers of several segments into one linked list.
8. Similarly, prepare descriptors for RX buffers for each segment and chain them into one linked list.

9. Configure all the needed CONF buffers, TX buffers and RX buffers, respectively for each segment before this DMA-controlled transfer begins.
10. Point `GDMA_OUTLINK_ADDR_CH n` to the head address of the CONF and TX buffer descriptor linked list, and then set `GDMA_OUTLINK_START_CH n` to start the TX GDMA.
11. Clear the bit `SPI_RX_EOF_EN` in register `SPI_DMA_CONF_REG`. Point `GDMA_INLINK_ADDR_CH n` to the head address of the RX buffer descriptor linked list, and then set `GDMA_INLINK_START_CH n` to start the RX GDMA.
12. Set `SPI_USR_CONF` to enable CONF state.
13. Set `SPI_DMA_SEG_TRANS_DONE_INT_ENA` to enable the `SPI_DMA_SEG_TRANS_DONE_INT` interrupt. Configure other interrupts if needed according to Section 30.10.
14. Wait for all the slaves to get ready for transfer.
15. Set `SPI_DMA_AFIFO_RST`, `SPI_BUF_AFIFO_RST` and `SPI_RX_AFIFO_RST`, to reset these buffers.
16. Set `SPI_USR` to start this DMA-controlled transfer.
17. Wait for `SPI_DMA_SEG_TRANS_DONE_INT` interrupt, which means this transfer has finished and the data has been stored into corresponding memory.

Configuration of CONF Buffer and Magic Value

In a configurable segmented transfer, only registers which will change from the last transaction (segment) need to be re-configured to new values in CONF state. The configuration of other registers can be skipped (i.e. kept the same) to save time and chip resources.

The first word in GDMA CONF buffer i , called `SPI_BIT_MAP_WORD`, defines whether given GP-SPI2 register is to be updated or not in segment i . The relation of `SPI_BIT_MAP_WORD` and GP-SPI2 registers to update can be seen in Table 30-12 Bitmap (BM) Table. If a bit in the BM table is set to 1, its corresponding register value will be updated in this segment. Registers with corresponding bit set to 0 remains unchanged.

Table 30-12. BM Table for CONF State

BM Bit	Register Name	BM Bit	Register Name
0	<code>SPI_ADDR_REG</code>	7	<code>SPI_MISC_REG</code>
1	<code>SPI_CTRL_REG</code>	8	<code>SPI_DIN_MODE_REG</code>
2	<code>SPI_CLOCK_REG</code>	9	<code>SPI_DIN_NUM_REG</code>
3	<code>SPI_USER_REG</code>	10	<code>SPI_DOUT_MODE_REG</code>
4	<code>SPI_USER1_REG</code>	11	<code>SPI_DMA_CONF_REG</code>
5	<code>SPI_USER2_REG</code>	12	<code>SPI_DMA_INT_ENA_REG</code>
6	<code>SPI_MS_DLEN_REG</code>	13	<code>SPI_DMA_INT_CLR_REG</code>

Then new values of all the registers to be modified should be placed right after `SPI_BIT_MAP_WORD`, in consecutive words in the CONF buffer.

To ensure the correctness of the content in each CONF buffer, the value in `SPI_BIT_MAP_WORD[31:28]` is used as “magic value”, and will be compared with `SPI_DMA_SEG_MAGIC_VALUE` in register `SPI_SLAVE_REG`. The value of `SPI_DMA_SEG_MAGIC_VALUE` should be configured before this DMA-controlled transfer starts, and can not be changed during these segments.

- If `SPI_BIT_MAP_WORD[31:28] == SPI_DMA_SEG_MAGIC_VALUE`, this DMA-controlled transfer continues normally; the interrupt `SPI_DMA_SEG_TRANS_DONE_INT` is triggered at the end of this DMA-controlled transfer.
- If `SPI_BIT_MAP_WORD[31:28] != SPI_DMA_SEG_MAGIC_VALUE`, GP-SPI2 state (`spi_st`) goes back to IDLE and the transfer is ended immediately. The interrupt `SPI_DMA_SEG_TRANS_DONE_INT` is still triggered, with `SPI_SEG_MAGIC_ERR_INT_RAW` bit set to 1.

CONF Buffer Configuration Example

Table 30-13 and Table 30-14 provide an example to show how to configure a CONF buffer for a transaction (segment *i*) in which `SPI_ADDR_REG`, `SPI_CTRL_REG`, `SPI_CLOCK_REG`, `SPI_USER_REG`, `SPI_USER1_REG` need to be updated.

Table 30-13. An Example of CONF buffer_{*i*} in Segment_{*i*}

CONF buffer _{<i>i</i>}	Note
<code>SPI_BIT_MAP_WORD</code>	The first word in this buffer. Its value is 0xA000001F in this example when the <code>SPI_DMA_SEG_MAGIC_VALUE</code> is set to 0xA. As shown in Table 30-14, bits 0, 1, 2, 3, and 4 are set, indicating the following registers will be updated.
<code>SPI_ADDR_REG</code>	The second word, stores the new value to <code>SPI_ADDR_REG</code> .
<code>SPI_CTRL_REG</code>	The third word, stores the new value to <code>SPI_CTRL_REG</code> .
<code>SPI_CLOCK_REG</code>	The fourth word, stores the new value to <code>SPI_CLOCK_REG</code> .
<code>SPI_USER_REG</code>	The fifth word, stores the new value to <code>SPI_USER_REG</code> .
<code>SPI_USER1_REG</code>	The sixth word, stores the new value to <code>SPI_USER1_REG</code> .

Table 30-14. BM Bit Value v.s. Register to Be Updated in This Example

BM Bit	Value	Register Name	BM Bit	Value	Register Name
0	1	<code>SPI_ADDR_REG</code>	7	0	<code>SPI_MISC_REG</code>
1	1	<code>SPI_CTRL_REG</code>	8	0	<code>SPI_DIN_MODE_REG</code>
2	1	<code>SPI_CLOCK_REG</code>	9	0	<code>SPI_DIN_NUM_REG</code>
3	1	<code>SPI_USER_REG</code>	10	0	<code>SPI_DOUT_MODE_REG</code>
4	1	<code>SPI_USER1_REG</code>	11	0	<code>SPI_DMA_CONF_REG</code>
5	0	<code>SPI_USER2_REG</code>	12	0	<code>SPI_DMA_INT_ENA_REG</code>
6	0	<code>SPI_MS_DLEN_REG</code>	13	0	<code>SPI_DMA_INT_CLR_REG</code>

Notes:

In a DMA-controlled configurable segmented transfer, please pay special attention to the following bits:

- `SPI_USR_CONF`: set `SPI_USR_CONF` before `SPI_USR` is set, to enable this transfer.
- `SPI_USR_CONF_NXT`: if segment *i* is not the final transaction of this whole DMA-controlled transfer, its `SPI_USR_CONF_NXT` should be set to 1.
- `SPI_CONF_BITLEN`: GP-SPI2 CS setup time and hold time are programmable independently in each segment, see Section 30.6 for detailed configuration. The CS high time in each segment is about:

$$(SPI_CONF_BITLEN + 5) \times T_{APB_CLK}$$

The CS high time in CONF state can be set from 62.5 μ s to 3.2768 ms when f_{APB_CLK} is 80 MHz. (`SPI_CONF_BITLEN + 5`) will overflow from (0x40000 - `SPI_CONF_BITLEN - 5`) if `SPI_CONF_BITLEN` is larger than 0x3FFFA.

30.5.9 GP-SPI Works as a Slave

GP-SPI can be used as a slave to communicate with an SPI master. As a slave, GP-SPI supports 1-bit SPI, 2-bit dual SPI, 4-bit quad SPI, and QPI modes, with specific communication formats. To enable this mode, set `SPI_SLAVE_MODE` in register `SPI_SLAVE_REG`.

The CS signal must be held low during the transmission, and its falling/rising edges indicate the start/end of a single or segmented transfer.

Note:

The length of transferred data must be in unit of bytes, otherwise the extra bits will be lost. The extra bits here means the result of total bits % 8.

30.5.9.1 Communication Formats

In GP-SPI slave mode, SPI full-duplex and half-duplex communications are available. To select from the two communications, configure `SPI_DOUTDIN` in register `SPI_USER_REG`.

Full-duplex communication means that input data and output data are transmitted simultaneously throughout the entire transaction. All bits are treated as input or output data, which means no command, address or dummy states are expected. The interrupt `SPI_TRANS_DONE_INT` is triggered once the transaction ends.

In half-duplex communication, the format is CMD+ADDR+DUMMY+DATA (DIN or DOUT).

- “DIN” means that an SPI master reads data from GP-SPI.
- “DOUT” means that an SPI master writes data to GP-SPI.

The detailed properties of each state are as follows:

1. CMD:

- Indicate the function of SPI slave;
- One byte from master to slave;
- Only the values in Table 30-15 and Table 30-16 are valid;
- Can be sent in 1-bit SPI mode or 4-bit QPI mode.

2. ADDR:

- The address for `Wr_BUF` and `Rd_BUF` commands in CPU-controlled transfer, or placeholder bits in other transfers and can be defined by application;
- One byte from master to slave;
- Can be sent in 1-bit, 2-bit or 4-bit modes (according to the command).

3. DUMMY:

- Its value is meaningless. SPI slave prepares data in this state;

- Bit mode of FSPI/SPI3 bus is also meaningless here;
- Last for eight SPI_CLK cycles.

4. DIN or DOUT:

- Data length can be 0 ~ 64 B in CPU-controlled mode and unlimited in DMA-controlled mode;
- Can be sent in 1-bit, 2-bit or 4-bit modes according to the CMD value.

Note:

The states of ADDR and DUMMY can never be skipped in any half-duplex communications.

When a half-duplex transaction is complete, the transferred CMD and ADDR values are latched into [SPI_SLV_LAST_COMMAND](#) and [SPI_SLV_LAST_ADDR](#) respectively. The [SPI_SLV_CMD_ERR_INT_RAW](#) will be set if the transferred CMD value is not supported by GP-SPI slave mode. The [SPI_SLV_CMD_ERR_INT_RAW](#) can only be cleared by software.

30.5.9.2 Supported CMD Values in Half-Duplex Communication

In half-duplex communication, the defined values of CMD determine the transfer types. Unsupported CMD values are disregarded, meanwhile the related transfer is ignored and [SPI_SLV_CMD_ERR_INT_RAW](#) is set. The transfer format is CMD (8 bits) + ADDR (8 bits) + DUMMY (8 SPI_CLK cycles) + DATA (unit in bytes). The detailed description of CMD[3:0] is as follows:

- 0x1 (Wr_BUF): CPU-controlled write mode. Master sends data and GP-SPI receives data. The data is stored in the related address of [SPI_W0_REG](#) ~ [SPI_W15_REG](#).
- 0x2 (Rd_BUF): CPU-controlled read mode. Master receives the data sent by GP-SPI. The data comes from the related address of [SPI_W0_REG](#) ~ [SPI_W15_REG](#).
- 0x3 (Wr_DMA): DMA-controlled write mode. Master sends data and GP-SPI receives data. The data is stored in GP-SPI GDMA RX buffer.
- 0x4 (Rd_DMA): DMA-controlled read mode. Master receives the data sent by GP-SPI. The data comes from GP-SPI GDMA TX buffer.
- 0x7 (CMD7): used to generate an [SPI_SLV_CMD7_INT](#) interrupt. It can also generate a [GDMA_IN_SUC_EOF](#) [_CH_n_INT](#) interrupt in a slave segmented transfer when GDMA RX link is used. But it will not end GP-SPI's slave segmented transfer.
- 0x8 (CMD8): only used to generate an [SPI_SLV_CMD8_INT](#) interrupt, which will not end GP-SPI's slave segmented transfer.
- 0x9 (CMD9): only used to generate an [SPI_SLV_CMD9_INT](#) interrupt, which will not end GP-SPI's slave segmented transfer.
- 0xA (CMDA): only used to generate an [SPI_SLV_CMDA_INT](#) interrupt, which will not end GP-SPI's slave segmented transfer.

The detailed function of CMD7, CMD8, CMD9, and CMDA commands is reserved for user definition. These commands can be used as handshake signals, the passwords of some specific functions, the triggers of some

user defined actions, and so on.

1/2/4-bit modes in states of CMD, ADDR, DATA are supported, which are determined by value of CMD[7:4]. The DUMMY state is always in 1-bit mode and lasts for eight SPI_CLK cycles. The definition of CMD[7:4] is as follows:

- 0x0: CMD, ADDR, and DATA states all are in 1-bit mode.
- 0x1: CMD and ADDR are in 1-bit mode. DATA is in 2-bit mode.
- 0x2: CMD and ADDR are in 1-bit mode. DATA is in 4-bit mode.
- 0x5: CMD is in 1-bit mode. ADDR and DATA are in 2-bit mode.
- 0xA: CMD is in 1-bit mode, ADDR and DATA are in 4-bit mode. Or in QPI mode.

In addition, if the value of CMD[7:0] is 0x05, 0xA5, 0x06, or 0xDD, DUMMY and DATA states are skipped. The definition of CMD[7:0] is as follows:

- 0x05 (End_SEG_TRANS): master sends 0x05 command to end slave segmented transfer in SPI mode.
- 0xA5 (End_SEG_TRANS): master sends 0xA5 command to end slave segmented transfer in QPI mode.
- 0x06 (En_QPI): GP-SPI enters QPI mode when receiving the 0x06 command and the bit [SPI_QPI_MODE](#) in register [SPI_USER_REG](#) is set.
- 0xDD (Ex_QPI): GP-SPI exits QPI mode when receiving the 0xDD command and the bit [SPI_QPI_MODE](#) is cleared.

All the CMD values supported by GP-SPI are listed in [Table 30-15](#) and [Table 30-16](#). Note that DUMMY state is always in 1-bit mode and lasts for eight SPI_CLK cycles.

Table 30-15. Supported CMD Values in SPI Mode

Transfer Type	CMD[7:0]	CMD State	ADDR State	DATA State
Wr_BUF	0x01	1-bit mode	1-bit mode	1-bit mode
	0x11	1-bit mode	1-bit mode	2-bit mode
	0x21	1-bit mode	1-bit mode	4-bit mode
	0x51	1-bit mode	2-bit mode	2-bit mode
	0xA1	1-bit mode	4-bit mode	4-bit mode
Rd_BUF	0x02	1-bit mode	1-bit mode	1-bit mode
	0x12	1-bit mode	1-bit mode	2-bit mode
	0x22	1-bit mode	1-bit mode	4-bit mode
	0x52	1-bit mode	2-bit mode	2-bit mode
	0xA2	1-bit mode	4-bit mode	4-bit mode
Wr_DMA	0x03	1-bit mode	1-bit mode	1-bit mode
	0x13	1-bit mode	1-bit mode	2-bit mode
	0x23	1-bit mode	1-bit mode	4-bit mode
	0x53	1-bit mode	2-bit mode	2-bit mode
	0xA3	1-bit mode	4-bit mode	4-bit mode
Rd_DMA	0x04	1-bit mode	1-bit mode	1-bit mode
	0x14	1-bit mode	1-bit mode	2-bit mode
	0x24	1-bit mode	1-bit mode	4-bit mode
	0x54	1-bit mode	2-bit mode	2-bit mode

Table 30-15. Supported CMD Values in SPI Mode

Transfer Type	CMD[7:0]	CMD State	ADDR State	DATA State
	0xA4	1-bit mode	4-bit mode	4-bit mode
CMD7	0x07	1-bit mode	1-bit mode	-
	0x17	1-bit mode	1-bit mode	-
	0x27	1-bit mode	1-bit mode	-
	0x57	1-bit mode	2-bit mode	-
	0xA7	1-bit mode	4-bit mode	-
CMD8	0x08	1-bit mode	1-bit mode	-
	0x18	1-bit mode	1-bit mode	-
	0x28	1-bit mode	1-bit mode	-
	0x58	1-bit mode	2-bit mode	-
	0xA8	1-bit mode	4-bit mode	-
CMD9	0x09	1-bit mode	1-bit mode	-
	0x19	1-bit mode	1-bit mode	-
	0x29	1-bit mode	1-bit mode	-
	0x59	1-bit mode	2-bit mode	-
	0xA9	1-bit mode	4-bit mode	-
CMDA	0x0A	1-bit mode	1-bit mode	-
	0x1A	1-bit mode	1-bit mode	-
	0x2A	1-bit mode	1-bit mode	-
	0x5A	1-bit mode	2-bit mode	-
	0xAA	1-bit mode	4-bit mode	-
End_SEG_TRANS	0x05	1-bit mode	-	-
En_QPI	0x06	1-bit mode	-	-

Table 30-16. Supported CMD Values in QPI Mode

Transfer Type	CMD[7:0]	CMD State	ADDR State	DATA State
Wr_BUF	0xA1	4-bit mode	4-bit mode	4-bit mode
Rd_BUF	0xA2	4-bit mode	4-bit mode	4-bit mode
Wr_DMA	0xA3	4-bit mode	4-bit mode	4-bit mode
Rd_DMA	0xA4	4-bit mode	4-bit mode	4-bit mode
CMD7	0xA7	4-bit mode	4-bit mode	-
CMD8	0xA8	4-bit mode	4-bit mode	-
CMD9	0xA9	4-bit mode	4-bit mode	-
CMDA	0xAA	4-bit mode	4-bit mode	-
End_SEG_TRANS	0xA5	4-bit mode	4-bit mode	-
Ex_QPI	0xDD	4-bit mode	4-bit mode	-

Master sends 0x06 CMD (En_QPI) to set GP-SPI slave to QPI mode and all the states of supported transfer will be in 4-bit mode afterwards. If 0xDD CMD (Ex_QPI) is received, GP-SPI slave will be back to SPI mode.

Other transfer types than described in Table 30-15 and Table 30-16 are ignored. If the transferred data is not in

unit of byte, GP-SPI can send or receive these extra bits (total bits mod 8), however, the correctness of the data is not guaranteed. But if the CS low time is longer than two APB clock (APB_CLK) cycles, [SPI_TRANS_DONE_INT](#) will be triggered. For more information on interrupts triggered at the end of transmissions, please refer to Section 30.10.

30.5.9.3 Slave Single Transfer and Slave Segmented Transfer

When GP-SPI works as a slave, it supports full-duplex and half-duplex communications controlled by DMA and by CPU. DMA-controlled transfer can be a single transfer, or a slave segmented transfer consisting of several transactions (segments). The CPU-controlled transfer can only be one single transfer, since each CPU-controlled transaction needs to be triggered by CPU.

In a slave segmented transfer, all transfer types listed in Table 30-15 and Table 30-16 are supported in a single transaction (segment). It means that CPU-controlled transaction and DMA-controlled transaction can be mixed in one slave segmented transfer.

It is recommended that in a slave segmented transfer:

- CPU-controlled transaction is used for handshake communication and short data transfers.
- DMA-controlled transaction is used for large data transfers.

30.5.9.4 Configuration of Slave Single Transfer

In slave mode, GP-SPI supports CPU/DMA-controlled full-duplex/half-duplex single transfers. The register configuration procedure is as follows:

1. Configure the IO path via IO MUX or GPIO matrix between GP-SPI and an external SPI device.
2. Configure APB clock (APB_CLK).
3. Set the bit [SPI_SLAVE_MODE](#), to enable slave mode.
4. Configure [SPI_DOUTDIN](#):
 - 1: enable full-duplex communication.
 - 0: enable half-duplex communication.
5. Prepare data:
 - if CPU-controlled transfer mode is selected and GP-SPI is used to send data, then prepare data in registers [SPI_W0_REG](#) ~ [SPI_W15_REG](#).
 - if DMA-controlled transfer mode is selected,
 - configure [SPI_DMA_TX_ENA/SPI_DMA_RX_ENA](#) and [SPI_RX_EOF_EN](#).
 - configure GDMA TX/RX link.
 - start GDMA TX/RX engine, as described in Section 30.5.6 and Section 30.5.7.
6. Set [SPI_DMA_AFIFO_RST](#), [SPI_BUF_AFIFO_RST](#), and [SPI_RX_AFIFO_RST](#) to reset these buffers.
7. Clear [SPI_DMA_SLV_SEG_TRANS_EN](#) in register [SPI_DMA_CONF_REG](#) to enable slave single transfer mode.

8. Set `SPI_TRANS_DONE_INT_ENA` in `SPI_DMA_INT_ENA_REG` and wait for the interrupt `SPI_TRANS_DONE_INT`. In DMA-controlled mode, it is recommended to wait for the interrupt `GDMA_IN_SUC_EOF_CH n _INT` when GDMA RX buffer is used, which means that data has been stored in the related memory. Other interrupts described in Section 30.10 are optional.

30.5.9.5 Configuration of Slave Segmented Transfer in Half-Duplex

GDMA must be used in this mode. The register configuration procedure is as follows:

1. Configure the IO path via IO MUX or GPIO matrix between GP-SPI and an external SPI device.
2. Configure APB clock (`APB_CLK`).
3. Set `SPI_SLAVE_MODE` to enable slave mode.
4. Clear `SPI_DOUTDIN` to enable half-duplex communication.
5. Prepare data in registers `SPI_W0_REG` ~ `SPI_W15_REG`, if needed.
6. Set `SPI_DMA_AFIFO_RST`, `SPI_BUF_AFIFO_RST` and `SPI_RX_AFIFO_RST` to reset these buffers.
7. Set bits `SPI_DMA_RX_ENA` and `SPI_DMA_TX_ENA`. Clear the bit `SPI_RX_EOF_EN`. Configure GDMA TX/RX link and start GDMA TX/RX engine, as shown in Section 30.5.6 and Section 30.5.7.
8. Set `SPI_DMA_SLV_SEG_TRANS_EN` in `SPI_DMA_CONF_REG` to enable slave segmented transfer.
9. Set `SPI_DMA_SEG_TRANS_DONE_INT_ENA` in `SPI_DMA_INT_ENA_REG` and wait for the interrupt `SPI_DMA_SEG_TRANS_DONE_INT`, which means that the segmented transfer has finished and data has been put into the related memory. Other interrupts described in Section 30.10 are optional.

When `End_SEG_TRANS` (0x05 in SPI mode, 0xA5 in QPI mode) is received by GP-SPI, this slave segmented transfer is ended and the interrupt `SPI_DMA_SEG_TRANS_DONE_INT` is triggered.

30.5.9.6 Configuration of Slave Segmented Transfer in Full-Duplex

GDMA must be used in this mode. In such transfer, the data is transferred from and to the GDMA buffer. The interrupt `GDMA_IN_SUC_EOF_CH n _INT` is triggered when the transfer ends. The configuration procedure is as follows:

1. Configure the IO path via IO MUX or GPIO matrix between GP-SPI and an external SPI device.
2. Configure APB clock (`APB_CLK`).
3. Set `SPI_SLAVE_MODE` and `SPI_DOUTDIN`, to enable full-duplex communication in slave mode.
4. Set `SPI_DMA_AFIFO_RST`, `SPI_BUF_AFIFO_RST`, and `SPI_RX_AFIFO_RST`, to reset these buffers.
5. Set `SPI_DMA_TX_ENA/SPI_DMA_RX_ENA`. Configure GDMA TX/RX link and start GDMA TX/RX engine, as shown in Section 30.5.6 and Section 30.5.7.
6. Set the bit `SPI_RX_EOF_EN` in register `SPI_DMA_CONF_REG`. Configure `SPI_MS_DATA_BITLEN[17:0]` in register `SPI_MS_DLEN_REG` to the byte length of the received DMA data.
7. Set `SPI_DMA_SLV_SEG_TRANS_EN` in `SPI_DMA_CONF_REG` to enable slave segmented transfer mode.
8. Set `GDMA_IN_SUC_EOF_CH n _INT_ENA` and wait for the interrupt `GDMA_IN_SUC_EOF_CH n _INT`.

30.6 CS Setup Time and Hold Time Control

SPI bus CS (SPI_CS) setup time and hold time are very important to meet the timing requirements of various SPI devices (e.g. flash or PSRAM).

CS setup time is the time between the CS falling edge and the first latch edge of SPI bus CLK (SPI_CLK). The first latch edge for mode 0 and mode 3 is rising edge, and falling edge for mode 2 and mode 4.

CS hold time is the time between the last latch edge of SPI_CLK and the CS rising edge.

In slave mode, the CS setup time and hold time should be longer than $0.5 \times T_{\text{SPI_CLK}}$, otherwise the SPI transfer may be incorrect. $T_{\text{SPI_CLK}}$: one cycle of SPI_CLK.

In master mode, set the CS setup time by specifying `SPI_CS_SETUP` in `SPI_USER_REG` and `SPI_CS_SETUP_TIME` in `SPI_USER1_REG`:

- If `SPI_CS_SETUP` is cleared, the SPI CS setup time is $0.5 \times T_{\text{SPI_CLK}}$.
- If `SPI_CS_SETUP` is set, the SPI CS setup time is $(\text{SPI_CS_SETUP_TIME} + 1.5) \times T_{\text{SPI_CLK}}$.

Set the CS hold time by specifying `SPI_CS_HOLD` in `SPI_USER_REG` and `SPI_CS_HOLD_TIME` in `SPI_USER1_REG`:

- If `SPI_CS_HOLD` is cleared, the SPI CS hold time is $0.5 \times T_{\text{SPI_CLK}}$.
- If `SPI_CS_HOLD` is set, the SPI CS hold time is $(\text{SPI_CS_HOLD_TIME} + 1.5) \times T_{\text{SPI_CLK}}$.

Figure 30-11 and Figure 30-12 show the recommended CS timing and register configuration to access external RAM and flash.

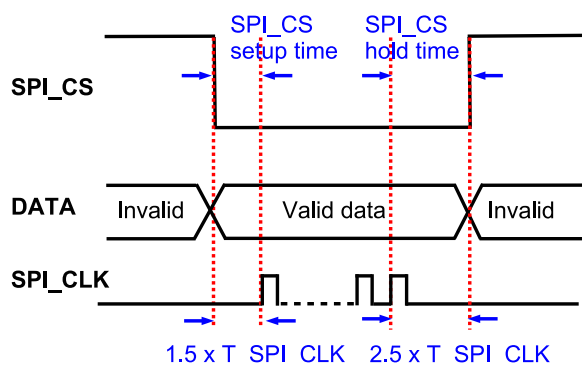

Register Configurations:

```
SPI_CS_SETUP = 1; SPI_CS_SETUP_TIME = 0;
SPI_CS_HOLD = 1; SPI_CS_HOLD_TIME = 1.
```

Figure 30-11. Recommended CS Timing and Settings When Accessing External RAM

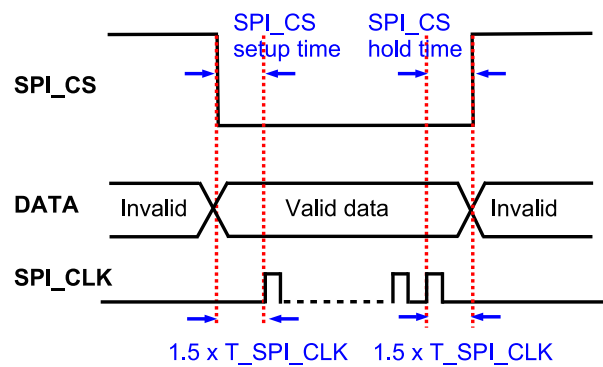

Register Configurations:

SPI_CS_SETUP = 1; SPI_CS_SETUP_TIME = 0;
 SPI_CS_HOLD = 1; SPI_CS_HOLD_TIME = 0.

Figure 30-12. Recommended CS Timing and Settings When Accessing Flash

30.7 GP-SPI Clock Control

GP-SPI has the following clocks:

- **clk_spi_mst**: module clock of GP-SPI, derived from PLL_CLK or XTAL_CLK. It is controlled by bits `SPI_MST_CLK_ACTIVE` and `SPI_MST_CLK_SEL`. Used in GP-SPI master mode, to generate `SPI_CLK` signal for data transfer and for slaves.
- **clk_hclk**: module timing compensation clock of GP-SPI. When PLL_CLK is available and the bit `SPI_TIMING_HCLK_ACTIVE` is set, the frequency is 160 MHz; otherwise, it is powered off.
- **SPI_CLK**: output clock in master mode.
- **APB_CLK**: clock for register configuration.

In master mode, the maximum output clock frequency of GP-SPI is $f_{\text{clk_spi_mst}}$. To have slower frequencies, the output clock frequency can be divided as follows:

$$f_{\text{SPI_CLK}} = \frac{f_{\text{clk_spi_mst}}}{(\text{SPI_CLKCNT_N} + 1)(\text{SPI_CLKDIV_PRE} + 1)}$$

The divider is configured by `SPI_CLKCNT_N` and `SPI_CLKDIV_PRE` in register `SPI_CLOCK_REG`. When the bit `SPI_CLK_EQU_SYSCLK` in register `SPI_CLOCK_REG` is set to 1, the output clock frequency of GP-SPI will be $f_{\text{clk_spi_mst}}$. And for other integral clock divisions, `SPI_CLK_EQU_SYSCLK` should be set to 0.

In slave mode, the supported input clock frequency ($f_{\text{SPI_CLK}}$) of GP-SPI is:

- If $f_{\text{APB_CLK}} \geq 60 \text{ MHz}$, $f_{\text{SPI_CLK}} \leq 60 \text{ MHz}$;
- If $f_{\text{APB_CLK}} < 60 \text{ MHz}$, $f_{\text{SPI_CLK}} \leq f_{\text{APB_CLK}}$.

30.7.1 Clock Phase and Polarity

There are four clock modes in SPI protocol, modes 0 ~ 3, see Figure 30-13 and Figure 30-14 (excerpted from SPI protocol):

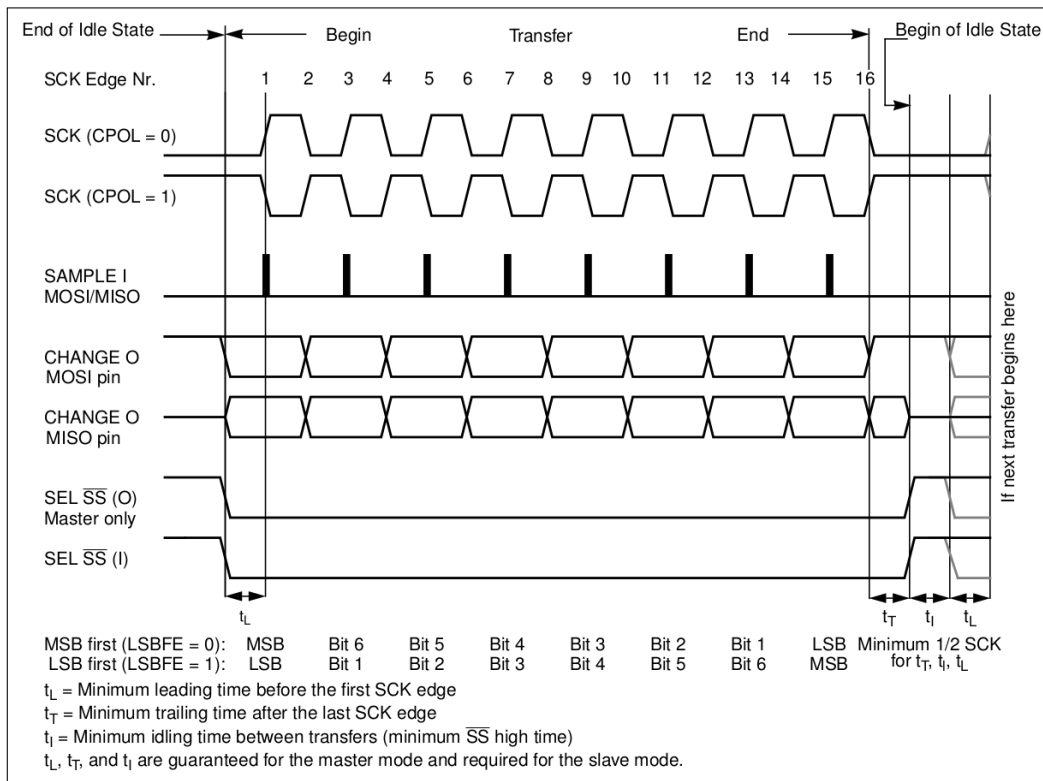

Figure 30-13. SPI Clock Mode 0 or 2

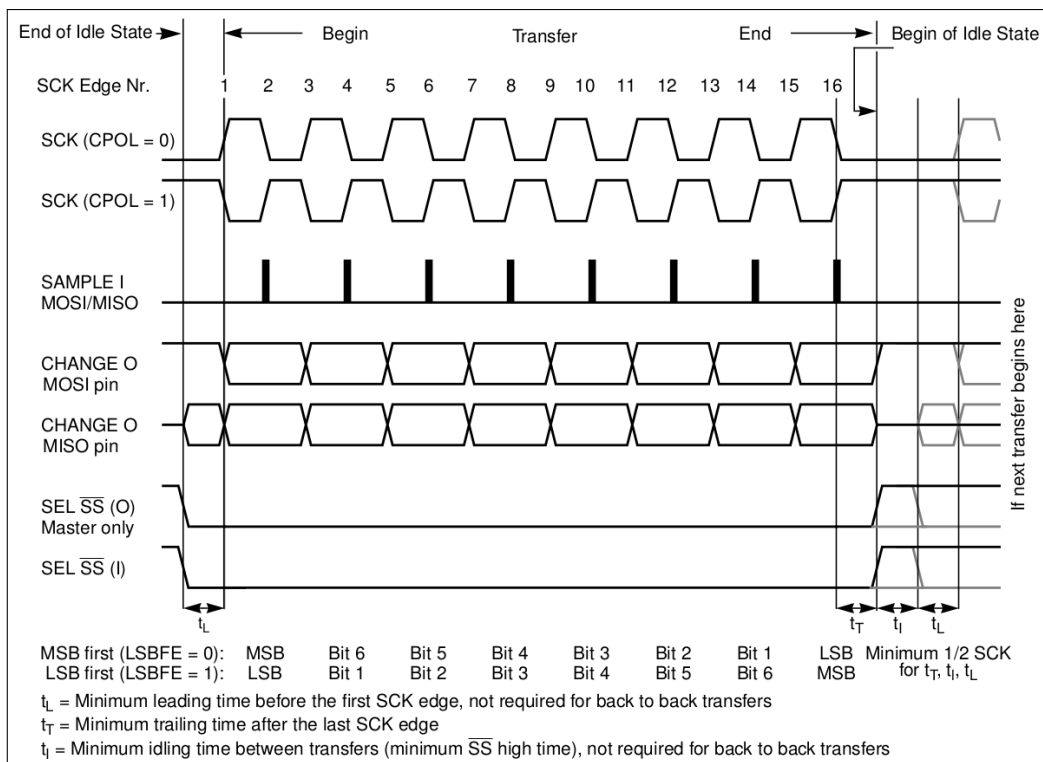

Figure 30-14. SPI Clock Mode 1 or 3

- Mode 0: CPOL = 0, CPHA = 0; SCK is 0 when the SPI is in idle state; data is changed on the negative edge of SCK and sampled on the positive edge. The first data is shifted out before the first negative edge of SCK.
- Mode 1: CPOL = 0, CPHA = 1; SCK is 0 when the SPI is in idle state; data is changed on the positive edge of SCK and sampled on the negative edge.
- Mode 2: CPOL = 1, CPHA = 0; SCK is 1 when the SPI is in idle state; data is changed on the positive edge of SCK and sampled on the negative edge. The first data is shifted out before the first positive edge of SCK.
- Mode 3: CPOL = 1, CPHA = 1; SCK is 1 when the SPI is in idle state; data is changed on the negative edge of SCK and sampled on the positive edge.

30.7.2 Clock Control in Master Mode

The four clock modes 0 ~ 3 are supported in GP-SPI master mode. The polarity and phase of GP-SPI clock are controlled by the bit [SPI_CK_IDLE_EDGE](#) in register [SPI_MISC_REG](#) and the bit [SPI_CK_OUT_EDGE](#) in register [SPI_USER_REG](#). The register configuration for SPI clock modes 0 ~ 3 is provided in Table 30-17, and can be changed according to the path delay in the application.

Table 30-17. Clock Phase and Polarity Configuration in Master Mode

Control Bit	Mode 0	Mode 1	Mode 2	Mode 3
SPI_CK_IDLE_EDGE	0	0	1	1
SPI_CK_OUT_EDGE	0	1	1	0

[SPI_CLK_MODE](#) is used to select the number of rising edges of SPI_CLK, when SPI_CS raises high, to be 0, 1, 2 or SPI_CLK always on.

Note:

When [SPI_CLK_MODE](#) is configured to 1 or 2, the bit [SPI_CS_HOLD](#) must be set and the value of [SPI_CS_HOLD_TIME](#) should be larger than 1.

30.7.3 Clock Control in Slave Mode

GP-SPI slave mode also supports clock modes 0 ~ 3. The polarity and phase are configured by the bits [SPI_TSCK_I_EDGE](#) and [SPI_RSCK_I_EDGE](#) in register [SPI_USER_REG](#). The output edge of data is controlled by [SPI_CLK_MODE_13](#) in register [SPI_SLAVE_REG](#). The detailed register configuration is shown in Table 30-18:

Table 30-18. Clock Phase and Polarity Configuration in Slave Mode

Control Bit	Mode 0	Mode 1	Mode 2	Mode 3
SPI_TSCK_I_EDGE	0	1	1	0
SPI_RSCK_I_EDGE	0	1	1	0
SPI_CLK_MODE_13	0	1	0	1

30.8 GP-SPI Timing Compensation

Introduction (Take GP-SPI2 as an example)

The I/O lines are mapped via GPIO matrix or IO MUX for GP-SPI2. But there is no timing adjustment in IO MUX. The input data and output data can be delayed for 1 or 2 APB_CLK cycles at the rising or falling edge in GPIO matrix. For detailed register configuration, see Chapter 6 *IO MUX and GPIO Matrix (GPIO, IO MUX)*.

Figure 30-15 shows the timing compensation control for GP-SPI2 master mode, including the following paths:

- “CLK”: the output path of GP-SPI2 bus clock. The clock is sent out by SPI_CLK out control module, passes through GPIO matrix or IO MUX and then goes to an external SPI device.
- “IN”: data input path of GP-SPI2 (see line 3 path in color purple in Figure 30-15). The input data from an external SPI device passes through GPIO matrix or IO MUX, then is adjusted by the Timing Module (see Figure 30-3) and finally is stored into spi_rx_afifo.
- “OUT”: data output path of GP-SPI2 (see line 2 path in color rose-red in Figure 30-15). The output data is sent out to the Timing Module, passes through GPIO matrix or IO MUX and is then captured by an external SPI device.

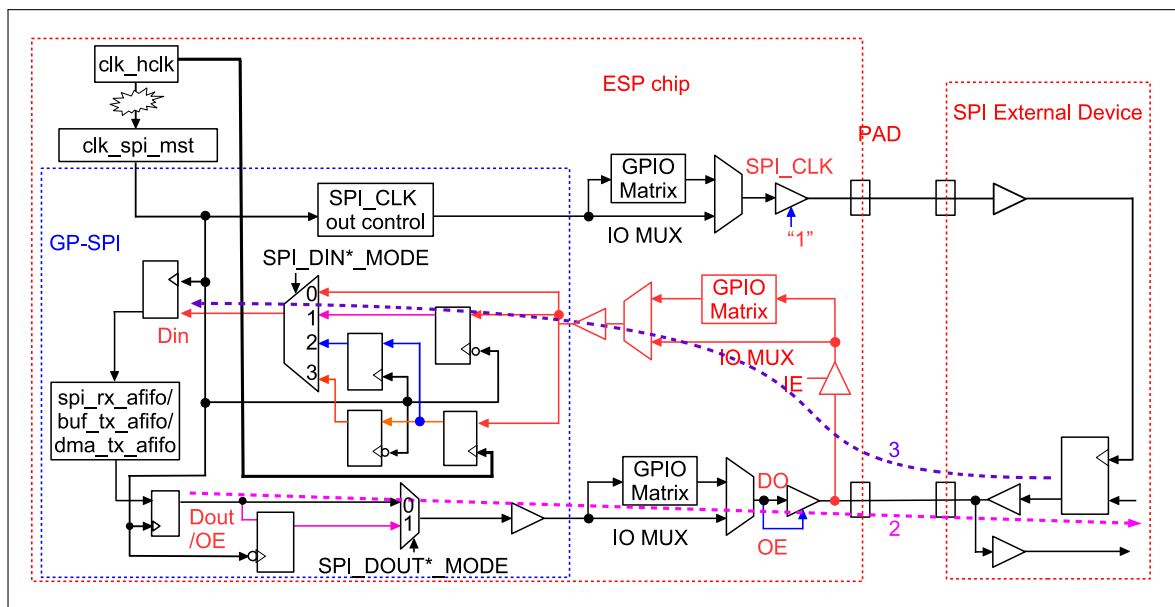

Figure 30-15. Timing Compensation Control Diagram in GP-SPI2 Master Mode

Every input and output data is passing through the Timing Module and the module can be used to apply delay in units of $T_{clk_spi_mst}$ (one cycle of clk_spi_mst) on rising or falling edge.

Key Registers

- **SPI_DIN_MODE_REG**: select the latch edge of input data
- **SPI_DIN_NUM_REG**: select the delay cycles of input data
- **SPI_DOUT_MODE_REG**: select the latch edge of output data

Timing Compensation Example

Figure 30-16 shows a timing compensation example in GP-SPI2 master mode. Note that DUMMY cycle length is configurable to compensate the delay in I/O lines, so as to enhance the performance of GP-SPI2.

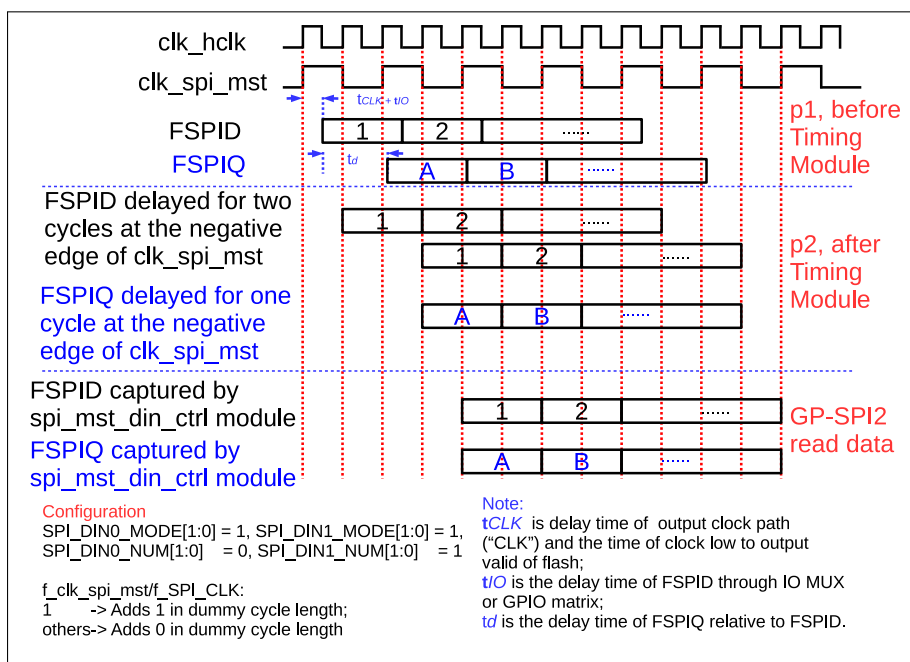

Figure 30-16. Timing Compensation Example in GP-SPI2 Master Mode

In Figure 30-16, “p1” is the point of input data of Timing Module, “p2” is the point of output data of Timing Module. Since the input data FSPIQ is unaligned to FSPID, the read data of GP-SPI2 will be wrong without the timing compensation.

To get correct read data, follow the the settings below, assuing $f_{clk_spi_mst}$ equals to f_{SPI_CLK} :

- Delay FSPID for two cycles at the falling edge of clk_spi_mst.
- Delay FSPIQ for one cycle at the falling edge of clk_spi_mst.
- Add one extra dummy cycle.

In GP-SPI2 slave mode, if the bit `SPI_RSCK_DATA_OUT` in register `SPI_SLAVE_REG` is set to 1, the output data is sent at latch edge, which is half an SPI clock cycle earlier. This can be used for slave mode timing compensation.

30.9 Differences Between GP-SPI2 and GP-SPI3

The feature differences between GP-SPI2 and GP-SPI3 are as follows:

- The communication mode for each GP-SPI2 state (CMD, ADDR, DOUT or DIN) can be configured independently. Data can either be in 1/2/4/8-bit master mode or 1/2/4-bit slave mode. Whereas GP-SPI3 supports 1/2/4-bit master mode or 1/2/4-bit slave mode.
- DMA-controlled configurable segmented transfer is only supported in GP-SPI2. Therefore, CONF state is not used in GP-SPI3.
- The I/O lines of GP-SPI2 can be mapped to physical GPIO pins either via GPIO matrix or IO MUX. However, GP-SPI3 lines can be configured only via GPIO matrix.
- GP-SPI2 has six CS signals in master mode. GP-SPI3 only has three CS signals in master mode.

Apart from that, the functions of GP-SPI2 and GP-SPI3 are the same. GP-SPI2 can use all the GP-SPI registers, while GP-SPI3 can only use some of the GP-SPI registers, see Table 30-19 for details.

Table 30-19. Invalid Registers and Fields for GP-SPI3

Invalid Register	Invalid Field
SPI_USER_REG	SPI_OPI_MODE SPI_FWRITE_OCT
SPI_CTRL_REG	SPI_FADDR_OCT SPI_FCMD_OCT SPI_FREAD_OCT
SPI_MISC_REG	SPI_CS3_DIS SPI_CS4_DIS SPI_CS5_DIS SPI_MASTER_CS_POL[5:3]
SPI_DIN_MODE_REG	SPI_DIN4_MODE SPI_DIN5_MODE SPI_DIN6_MODE SPI_DIN7_MODE
SPI_DIN_NUM_REG	SPI_DIN4_NUM SPI_DIN5_NUM SPI_DIN6_NUM SPI_DIN7_NUM
SPI_DOUT_MODE_REG	SPI_DOUT4_MODE SPI_DOUT5_MODE SPI_DOUT6_MODE SPI_DOUT7_MODE

GP-SPI3 has the same 1/2/4-bit mode functions and register configuration rules as to GP-SPI2. GP-SPI3 interface can be seen as a 1/2/4-bit mode GP-SPI2 interface, without DMA-controlled configurable segmented transfer.

30.10 Interrupts

Interrupt Summary

GP-SPI provides SPI_INTR_2/3 interrupt interfaces. When an SPI transfer ends, an interrupt is generated in GP-SPI:

- SPI_DMA_INFIFO_FULL_ERR_INT: triggered when GDMA RX FIFO length is shorter than the real transferred data length.
- SPI_DMA_OUTFIFO_EMPTY_ERR_INT: triggered when GDMA TX FIFO length is shorter than the real transferred data length.
- SPI_SLV_EX_QPI_INT: triggered when Ex_QPI is received correctly in GP-SPI slave mode and the SPI transfer ends.
- SPI_SLV_EN_QPI_INT: triggered when En_QPI is received correctly in GP-SPI slave mode and the SPI transfer ends.
- SPI_SLV_CMD7_INT: triggered when CMD7 is received correctly in GP-SPI slave mode and the SPI transfer ends.
- SPI_SLV_CMD8_INT: triggered when CMD8 is received correctly in GP-SPI slave mode and the SPI transfer ends.
- SPI_SLV_CMD9_INT: triggered when CMD9 is received correctly in GP-SPI slave mode and the SPI transfer ends.
- SPI_SLV_CMDA_INT: triggered when CMDA is received correctly in GP-SPI slave mode and the SPI transfer ends.
- SPI_SLV_RD_DMA_DONE_INT: triggered at the end of Rd_DMA transfer in slave mode.
- SPI_SLV_WR_DMA_DONE_INT: triggered at the end of Wr_DMA transfer in slave mode.
- SPI_SLV_RD_BUF_DONE_INT: triggered at the end of Rd_BUF transfer in slave mode.
- SPI_SLV_WR_BUF_DONE_INT: triggered at the end of Wr_BUF transfer in slave mode.
- SPI_TRANS_DONE_INT: triggered at the end of SPI bus transfer in both master and slave modes.
- SPI_DMA_SEG_TRANS_DONE_INT: triggered at the end of End_SEG_TRANS transfer in GP-SPI slave segmented transfer mode or at the end of configurable segmented transfer in master mode.
- SPI_SEG_MAGIC_ERR_INT: triggered when a Magic error occurs in CONF buffer during configurable segmented transfer in master mode. (Only valid in GP-SPI2)
- SPI_MST_RX_AFIFO_WFULL_ERR_INT: triggered by RX AFIFO write-full error in GP-SPI master mode.
- SPI_MST_TX_AFIFO_REMPTY_ERR_INT: triggered by TX AFIFO read-empty error in GP-SPI master mode.
- SPI_SLV_CMD_ERR_INT: triggered when a received command value is not supported in GP-SPI slave mode.
- SPI_APP2_INT: Set [SPI_APP2_INT_SET](#) to trigger this interrupt. It is only used for user defined function.
- SPI_APP1_INT: Set [SPI_APP1_INT_SET](#) to trigger this interrupt. It is only used for user defined function.

Interrupts Used in Master and Slave Modes

Table 30-20 and Table 30-21 show the interrupts used in GP-SPI master and slave modes. Set the interrupt enable bit SPI*_INT_ENA in SPI_DMA_INT_ENA_REG and wait for the SPI_INT interrupt. When the transfer ends, the related interrupt is triggered and should be cleared by software before the next transfer.

Table 30-20. GP-SPI Master Mode Interrupts

Transfer Type	Communication Mode	Controlled by	Interrupt
Single Transfer	Full-duplex	DMA	GDMA_IN_SUC_EOF_CH n _INT ¹
		CPU	SPI_TRANS_DONE_INT ²
	Half-duplex MOSI Mode	DMA	SPI_TRANS_DONE_INT
		CPU	SPI_TRANS_DONE_INT
	Half-duplex MISO Mode	DMA	GDMA_IN_SUC_EOF_CH n _INT
		CPU	SPI_TRANS_DONE_INT
Configurable Segmented Transfer	Full-duplex	DMA	SPI_DMA_SEG_TRANS_DONE_INT ³
		CPU	Not supported
	Half-duplex MOSI Mode	DMA	SPI_DMA_SEG_TRANS_DONE_INT
		CPU	Not supported
	Half-duplex MISO	DMA	SPI_DMA_SEG_TRANS_DONE_INT
		CPU	Not supported

¹ If GDMA_IN_SUC_EOF_CH n _INT is triggered, it means all the RX data of GP-SPI has been stored in the RX buffer, and the TX data has been transferred to the slave.

² SPI_TRANS_DONE_INT is triggered when CS is high, which indicates that master has completed the data exchange in SPI_W0_REG ~ SPI_W15_REG with slave in this mode.

³ If SPI_DMA_SEG_TRANS_DONE_INT is triggered, it means that the whole configurable segmented transfer (consisting of several segments) has finished, i.e. the RX data has been stored in the RX buffer completely and all the TX data has been sent out.

Table 30-21. GP-SPI Slave Mode Interrupts

Transfer Type	Communication Mode	Controlled by	Interrupt
Single Transfer	Full-duplex	DMA	GDMA_IN_SUC_EOF_CH n _INT ¹
		CPU	SPI_TRANS_DONE_INT ²
	Half-duplex MOSI Mode	DMA (Wr_DMA)	GDMA_IN_SUC_EOF_CH n _INT ³
		CPU (Wr_BUF)	SPI_TRANS_DONE_INT ⁴
	Half-duplex MISO Mode	DMA (Rd_DMA)	SPI_TRANS_DONE_INT ⁵
		CPU (Rd_BUF)	SPI_TRANS_DONE_INT ⁶
Slave Segmented Transfer	Full-duplex	DMA	GDMA_IN_SUC_EOF_CH n _INT ⁷
		CPU	Not supported ⁸
	Half-duplex MOSI Mode	DMA (Wr_DMA)	SPI_DMA_SEG_TRANS_DONE_INT ⁹
		CPU (Wr_BUF)	Not supported ¹⁰
	Half-duplex MISO Mode	DMA (Rd_DMA)	SPI_DMA_SEG_TRANS_DONE_INT ¹¹
		CPU (Rd_BUF)	Not supported ¹²

Continued on the next page

Table 30-21 – Continued from the previous page

Transfer Type	Communication Mode	Controlled by	Interrupt
---------------	--------------------	---------------	-----------

¹ If `GDMA_IN_SUC_EOF_CH n _INT` is triggered, it means all the RX data has been stored in the RX buffer, and the TX data has been sent to the slave.

² `SPI_TRANS_DONE_INT` is triggered when CS is high, which indicates that master has completed the data exchange in `SPI_W0_REG ~ SPI_W15_REG` with slave in this mode.

³ `SPI_SLV_WR_DMA_DONE_INT` just means that the transmission on the SPI bus is done, but can not ensure that all the push data has been stored in the RX buffer. For this reason, `GDMA_IN_SUC_EOF_CH n _INT` is recommended.

⁴ Or wait for `SPI_SLV_WR_BUF_DONE_INT`.

⁵ Or wait for `SPI_SLV_RD_DMA_DONE_INT`.

⁶ Or wait for `SPI_SLV_RD_BUF_DONE_INT`.

⁷ Slave should set the total read data byte length in `SPI_MS_DATA_BITLEN` before the transfer begins. Set `SPI_RX_EOF_EN` to 1 before the end of the interrupt program.

⁸ Master and slave should define a method to end the segmented transfer, such as via GPIO interrupt.

⁹ Master sends `End_SEG_TRAN` to end the segmented transfer or slave sets the total read data byte length in `SPI_MS_DATA_BITLEN` and waits for `GDMA_IN_SUC_EOF_CH n _INT`.

¹⁰ Half-duplex `Wr_BUF` single transfer can be used in a slave segmented transfer.

¹¹ Master sends `End_SEG_TRAN` to end the segmented transfer.

¹² Half-duplex `Rd_BUF` single transfer can be used in a slave segmented transfer.

30.11 Register Summary

The addresses in this section are relative to SPI2/SPI3 base address provided in Table 4-3 in Chapter 4 *System and Memory*.

The abbreviations given in Column **Access** are explained in Section [Access Types for Registers](#).

Name	Description	SPI2 Address	SPI3 Address	Access
User-defined control registers				
SPI_CMD_REG	Command control register	0x0000	0x0000	varies
SPI_ADDR_REG	Address value register	0x0004	0x0004	R/W
SPI_USER_REG	SPI USER control register	0x0010	0x0010	varies
SPI_USER1_REG	SPI USER control register 1	0x0014	0x0014	R/W
SPI_USER2_REG	SPI USER control register 2	0x0018	0x0018	R/W
Control and configuration registers				
SPI_CTRL_REG	SPI control register	0x0008	0x0008	R/W
SPI_MS_DLEN_REG	SPI data bit length control register	0x001C	0x001C	R/W
SPI_MISC_REG	SPI misc register	0x0020	0x0020	R/W
SPI_DMA_CONF_REG	SPI DMA control register	0x0030	0x0030	varies
SPI_SLAVE_REG	SPI slave control register	0x00E0	0x00E0	varies
SPI_SLAVE1_REG	SPI slave control register 1	0x00E4	0x00E4	R/W/SS
Clock control registers				
SPI_CLOCK_REG	SPI clock control register	0x000C	0x000C	R/W
SPI_CLK_GATE_REG	SPI module clock and register clock control	0x00E8	0x00E8	R/W

Name	Description	SPI2 Address	SPI3 Address	Access
Timing registers				
SPI_DIN_MODE_REG	SPI input delay mode configuration	0x0024	0x0024	R/W
SPI_DIN_NUM_REG	SPI input delay number configuration	0x0028	0x0028	R/W
SPI_DOUT_MODE_REG	SPI output delay mode configuration	0x002C	0x002C	R/W
Interrupt registers				
SPI_DMA_INT_ENA_REG	SPI interrupt enable register	0x0034	0x0034	R/W
SPI_DMA_INT_CLR_REG	SPI interrupt clear register	0x0038	0x0038	WT
SPI_DMA_INT_RAW_REG	SPI interrupt raw register	0x003C	0x003C	R/WTC/SS
SPI_DMA_INT_ST_REG	SPI interrupt status register	0x0040	0x0040	RO
SPI_DMA_INT_SET_REG	SPI interrupt software set register	0x0044	0x0044	WT
CPU-controlled data buffer				
SPI_W0_REG	SPI CPU-controlled buffer0	0x0098	0x0098	R/W/SS
SPI_W1_REG	SPI CPU-controlled buffer1	0x009C	0x009C	R/W/SS
SPI_W2_REG	SPI CPU-controlled buffer2	0x00A0	0x00A0	R/W/SS
SPI_W3_REG	SPI CPU-controlled buffer3	0x00A4	0x00A4	R/W/SS
SPI_W4_REG	SPI CPU-controlled buffer4	0x00A8	0x00A8	R/W/SS
SPI_W5_REG	SPI CPU-controlled buffer5	0x00AC	0x00AC	R/W/SS
SPI_W6_REG	SPI CPU-controlled buffer6	0x00B0	0x00B0	R/W/SS
SPI_W7_REG	SPI CPU-controlled buffer7	0x00B4	0x00B4	R/W/SS
SPI_W8_REG	SPI CPU-controlled buffer8	0x00B8	0x00B8	R/W/SS
SPI_W9_REG	SPI CPU-controlled buffer9	0x00BC	0x00BC	R/W/SS
SPI_W10_REG	SPI CPU-controlled buffer10	0x00C0	0x00C0	R/W/SS
SPI_W11_REG	SPI CPU-controlled buffer11	0x00C4	0x00C4	R/W/SS
SPI_W12_REG	SPI CPU-controlled buffer12	0x00C8	0x00C8	R/W/SS
SPI_W13_REG	SPI CPU-controlled buffer13	0x00CC	0x00CC	R/W/SS
SPI_W14_REG	SPI CPU-controlled buffer14	0x00D0	0x00D0	R/W/SS
SPI_W15_REG	SPI CPU-controlled buffer15	0x00D4	0x00D4	R/W/SS
Version register				
SPI_DATE_REG	Version control	0x00F0	0x00F0	R/W

30.12 Registers

The addresses in this section are relative to SPI2/SPI3 base address provided in Table 4-3 in Chapter 4 *System and Memory*.

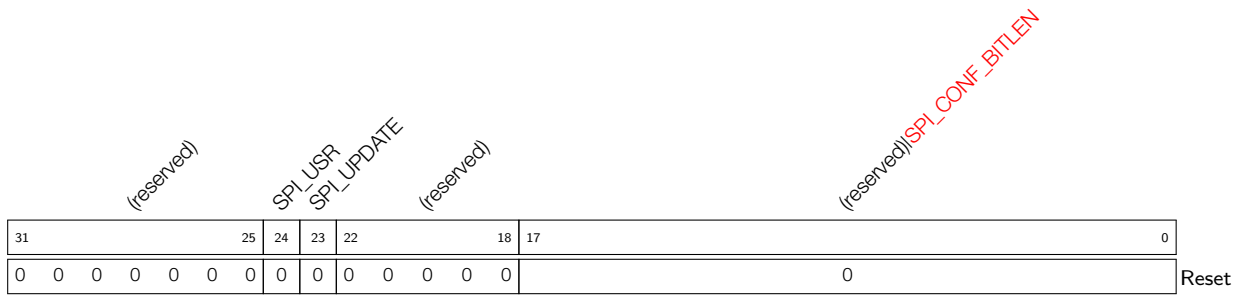
Register 30.1. SPI_CMD_REG (0x0000)

SPI_CONF_BITLEN (for SPI2 only) Define the cycles of `APB_CLK` in CONF state. Can be configured in CONF state. (R/W)

SPI_UPDATE Set this bit to synchronize SPI registers from APB clock domain into SPI module clock domain. This bit is only used in SPI master mode. (WT)

SPI_USR User-defined command enable. An SPI operation will be triggered when the bit is set. The bit will be cleared once the operation is done. 1: enable. 0: disable. Can not be changed by `CONF_buf`. (R/W/SC)

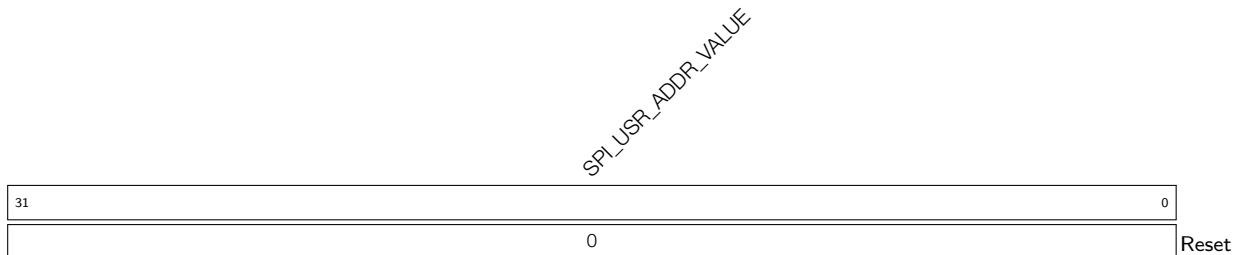
Register 30.2. SPI_ADDR_REG (0x0004)

SPI_USR_ADDR_VALUE Address to slave. Can be configured in CONF state. (R/W)

Register 30.3. SPI_USER_REG (0x0010)

Continued from the previous page...

SPI_USR_CONF_NXT (for SPI2 only) Enable the CONF state for the next transaction (segment) in a configurable segmented transfer. Can be configured in CONF state. (R/W)

- If this bit is set, it means this configurable segmented transfer will continue its next transaction (segment).
- If this bit is cleared, it means this transfer will end after the current transaction (segment) is finished. Or this is not a configurable segmented transfer.

SPI_SIO Set the bit to enable 3-line half-duplex communication, where MOSI and MISO signals share the same pin. 1: enable. 0: disable. Can be configured in CONF state. (R/W)

SPI_USR_MISO_HIGHPART In read-data phase, only access to high-part of the buffers [SPI_W8_REG](#) ~ [SPI_W15_REG](#). 1: enable. 0: disable. Can be configured in CONF state. (R/W)

SPI_USR_MOSI_HIGHPART In write-data phase, only access to high-part of the buffers [SPI_W8_REG](#) ~ [SPI_W15_REG](#). 1: enable. 0: disable. Can be configured in CONF state. (R/W)

SPI_USR_DUMMY_IDLE If this bit is set, SPI clock is disable in DUMMY state. Can be configured in CONF state. (R/W)

SPI_USR_MOSI Set this bit to enable the write-data (DOUT) state of an operation. Can be configured in CONF state. (R/W)

SPI_USR_MISO Set this bit to enable the read-data (DIN) state of an operation. Can be configured in CONF state. (R/W)

SPI_USR_DUMMY Set this bit to enable the DUMMY state of an operation. Can be configured in CONF state. (R/W)

SPI_USR_ADDR Set this bit to enable the address (ADDR) state of an operation. Can be configured in CONF state. (R/W)

SPI_USR_COMMAND Set this bit to enable the command (CMD) state of an operation. Can be configured in CONF state. (R/W)

Register 30.4. SPI_USER1_REG (0x0014)

SPI_USR_ADDR_BITLEN		SPI_CS_HOLD_TIME				SPI_CS_SETUP_TIME				SPI_MST_WFULL_ERR_END_EN				(reserved)				SPI_USR_DUMMY_CYCLELEN						
31	27	26	22	21	17	16	15	8	7	0	23	0x1	0	1	0	0	0	0	0	0	0	0	0	7
Reset																								

SPI_USR_DUMMY_CYCLELEN The length of DUMMY state, in unit of SPI_CLK cycles. The value is (the expected cycle number - 1). Can be configured in CONF state. (R/W)

SPI_MST_WFULL_ERR_END_EN 1: SPI transfer is ended when SPI RX AFIFO wfull error occurs in GP-SPI master full-/half-duplex modes. 0: SPI transfer is not ended when SPI RX AFIFO wfull error occurs in GP-SPI master full-/half-duplex modes. (R/W)

SPI_CS_SETUP_TIME The length of prepare (PREP) state, in unit of SPI_CLK cycles. This value is equal to the expected cycles - 1. This field is used together with [SPI_CS_SETUP](#). Can be configured in CONF state. (R/W)

SPI_CS_HOLD_TIME Delay cycles of CS pin, in units of SPI_CLK cycles. This field is used together with [SPI_CS_HOLD](#). Can be configured in CONF state. (R/W)

SPI_USR_ADDR_BITLEN The bit length in address state. This value is (expected bit number - 1). Can be configured in CONF state. (R/W)

Register 30.5. SPI_USER2_REG (0x0018)

SPI_USR_COMMAND_BITLEN				SPI_MST_REMPTY_ERR_END_EN												(reserved)				SPI_USR_COMMAND_VALUE					
31	28	27	26	16	15	0	7	1	0	0	0	0	0	0	0	0	0	0	0	0	0	0	0	0	0
Reset																									

SPI_USR_COMMAND_VALUE The value of command. Can be configured in CONF state. (R/W)

SPI_MST_REMPTY_ERR_END_EN 1: SPI transfer is ended when SPI TX AFIFO read empty error occurs in GP-SPI master full-/half-duplex modes. 0: SPI transfer is not ended when SPI TX AFIFO read empty error occurs in GP-SPI master full-/half-duplex modes. (R/W)

SPI_USR_COMMAND_BITLEN The bit length of command state. This value is (expected bit number - 1). Can be configured in CONF state. (R/W)

Register 30.6. **SPI_CTRL_REG** (0x0008)

(reserved)	SPI_WR_BIT_ORDER	SPI_RD_BIT_ORDER	(reserved)	SPI_WP_POL	SPI_HOLD_POL	SPI_D_POL	SPI_Q_POL	(reserved)	(reserved)	SPI_FREAD_QUAD	SPI_FREAD_DUAL	(reserved)	(reserved)	SPI_FCMD_QUAD	SPI_FCMD_DUAL	(reserved)	(reserved)	SPI_FADDR_QUAD	SPI_FADDR_DUAL	(reserved)	SPI_DUMMY_OUT	(reserved)					
31	27	26	25	24	23	22	21	20	19	18	17	16	15	14	13	11	10	9	8	7	6	5	4	3	2	0	
0	0	0	0	0	0	0	1	1	1	1	0	0	0	0	0	0	0	0	0	0	0	0	0	0	0	0	0

Reset

SPI_DUMMY_OUT Can be configured in CONF state. (R/W)

- For SPI2:
 - 0: In DUMMY state, the FSPI bus signals are not output.
 - 1: In DUMMY state, the FSPI bus signals are output.
- For SPI3: In DUMMY state, the signal level of SPI is output by the SPI controller.

SPI_FADDR_DUAL Apply 2-bit mode during address (ADDR) state. 1: enable. 0: disable. Can be configured in CONF state. (R/W)

SPI_FADDR_QUAD Apply 4-bit mode during address (ADDR) state. 1: enable. 0: disable. Can be configured in CONF state. (R/W)

SPI_FADDR_OCT (for SPI2 only) Apply 8-bit mode during address (ADDR) state. 1: enable. 0: disable. Can be configured in CONF state. (R/W)

SPI_FCMD_DUAL Apply 2-bit mode during command (CMD) state. 1: enable. 0: disable. Can be configured in CONF state. (R/W)

SPI_FCMD_QUAD Apply 4-bit mode during command (CMD) state. 1: enable. 0: disable. Can be configured in CONF state. (R/W)

SPI_FCMD_OCT (for SP2 only) Apply 8-bit mode during command (CMD) state. 1: enable. 0: disable. Can be configured in CONF state. (R/W)

SPI_FREAD_DUAL In read operations, read-data (DIN) state is in 2-bit mode. 1: enable. 0: disable. Can be configured in CONF state. (R/W)

SPI_FREAD_QUAD In read operations, read-data (DIN) state is in 4-bit mode. 1: enable. 0: disable. Can be configured in CONF state. (R/W)

SPI_FREAD_OCT (for SP2 only) In read operations, read-data (DIN) state is in 8-bit mode. 1: enable. 0: disable. Can be configured in CONF state. (R/W)

SPI_Q_POL The bit is used to set MISO line polarity. 1: high. 0: low. Can be configured in CONF state. (R/W)

SPI_D_POL The bit is used to set MOSI line polarity, 1: high. 0, low. Can be configured in CONF state. (R/W)

Continued on the next page...

Register 30.8. SPI_MISC_REG (For SPI2 Only) (0x0020)

SPI_QUAD_DIN_PIN_SWAP		SPI_CS_KEEP_ACTIVE		(reserved)		SPI_DQS_IDLE_EDGE		(reserved)		SPI_CMD_DTR_EN		SPI_ADDR_DTR_EN		SPI_DATA_DTR_EN		(reserved)		SPI_MASTER_CS_POL		SPI_CLK_DIS		SPI_CS5_DIS		SPI_CS4_DIS		SPI_CS3_DIS		SPI_CS2_DIS		SPI_CS1_DIS		SPI_CS0_DIS	
31	30	29	28	25	24	23	22	20	19	18	17	16	15	13	12	7	6	5	4	3	2	1	0	Reset									
0	0	0	0	0	0	0	0	0	0	0	0	0	0	0	0	0	0	1	1	1	1	1	1	0									

SPI_CS0_DIS SPI CS0 pin enable bit. 1: disable CS0. 0: SPI_CS0 signal is from/to CS0 pin. Can be configured in CONF state. (R/W)

SPI_CS1_DIS SPI CS1 pin enable bit. 1: disable CS1. 0: SPI_CS1 signal is from/to CS1 pin. Can be configured in CONF state. (R/W)

SPI_CS2_DIS SPI CS2 pin enable bit. 1: disable CS2. 0: SPI_CS2 signal is from/to CS2 pin. Can be configured in CONF state. (R/W)

SPI_CS3_DIS SPI CS3 pin enable bit. 1: disable CS3. 0: SPI_CS3 signal is from/to CS3 pin. Can be configured in CONF state. (R/W)

SPI_CS4_DIS SPI CS4 pin enable bit. 1: disable CS4. 0: SPI_CS4 signal is from/to CS4 pin. Can be configured in CONF state. (R/W)

SPI_CS5_DIS SPI CS5 pin enable bit. 1: disable CS5 0: SPI_CS5 signal is from/to CS5 pin. Can be configured in CONF state. (R/W)

SPI_CLK_DIS 1: Disable SPI_CLK output. 0: Enable SPI_CLK output. Can be configured in CONF state. (R/W)

SPI_MASTER_CS_POL SPI_MASTER_CS_POL[*i*] configures the polarity of SPI CS^{*i*} (*i* is from 0 ~ 2) line in master mode. 0: CS^{*i*} is low active. 1: CS^{*i*} is high active. Can be configured in CONF state. (R/W)

SPI_CLK_DATA_DTR_EN 1: SPI master DDR mode is applied to SPI clock, data, and SPI_DQS. 0: SPI master DDR mode is only applied to SPI_DQS. This bit should be used with bit 17/18/19. (R/W)

SPI_DATA_DTR_EN 1: SPI clock and data of DOUT and DIN states are in DDR mode, including master 1/2/4/8-bit mode. 0: SPI clock and data of DOUT and DIN states are in SDR mode. Can be configured in CONF state. (R/W)

SPI_ADDR_DTR_EN 1: SPI clock and data of SPI_SEND_ADDR state are in DDR mode, including master 1/2/4/8-bit mode. 0: SPI clock and data of SPI_SEND_ADDR state are in SDR mode. Can be configured in CONF state. (R/W)

SPI_CMD_DTR_EN 1: SPI clock and data of SPI_SEND_CMD state are in DDR mode, including master 1/2/4/8-bit mode. 0: SPI clock and data of SPI_SEND_CMD state are in SDR mode. Can be configured in CONF state. (R/W)

SPI_SLAVE_CS_POL Configure SPI slave input CS polarity. 1: invert. 0: not change. Can be configured in CONF state. (R/W)

Continued on the next page...

Register 30.8. SPI_MISC_REG (For SPI2 Only) (0x0020)

Continued from the previous page...

SPI_DQS_IDLE_EDGE The default value of SPI_DQS. 0: low voltage level; 1: high voltage level. Can be configured in CONF state. (R/W)

SPI_CK_IDLE_EDGE 1: SPI_CLK line is high when GP-SPI2 is in idle. 0: SPI_CLK line is low when GP-SPI2 is in idle. Can be configured in CONF state. (R/W)

SPI_CS_KEEP_ACTIVE SPI CS line keeps low when the bit is set. Can be configured in CONF state. (R/W)

SPI_QUAD_DIN_PIN_SWAP SPI quad input swap enable. 1: swap FSPID with FSPIQ, swap FSPIWP with FSPIHD. 0: SPI quad input swap disable. Can be configured in CONF state. (R/W)

Register 30.9. SPI_MISC_REG (For SPI3 Only) (0x0020)

SPI_QUAD_DIN_PIN_SWAP				SPI_CS_KEEP_ACTIVE				SPI_CLK_IDLE_EDGE				(reserved)				SPI_SLAVE_CS_POL				(reserved)				SPI_MASTER_CS_POL				SPI_CLK_DIS				(reserved)				SPI_CS2_DIS				SPI_CS1_DIS				SPI_CS0_DIS			
31	30	29	28	27	26	25	24	23	22	21	20	19	18	17	16	15	14	13	12	11	10	9	8	7	6	5	4	3	2	1	0																
0	0	0	0	0	0	0	0	0	0	0	0	0	0	0	0	0	0	0	0	0	0	0	0	0	0	0	0	0	1	1	0																

Reset

SPI_CS0_DIS SPI CS0 pin enable bit. 1: disable CS0. 0: SPI_CS0 signal is from/to CS0 pin. Can be configured in CONF state. (R/W)

SPI_CS1_DIS SPI CS1 pin enable bit. 1: disable CS1. 0: SPI_CS1 signal is from/to CS1 pin. Can be configured in CONF state. (R/W)

SPI_CS2_DIS SPI CS2 pin enable bit. 1: disable CS2. 0: SPI_CS2 signal is from/to CS2 pin. Can be configured in CONF state. (R/W)

SPI_CLK_DIS 1: Disable SPI_CLK output. 0: Enable SPI_CLK output. Can be configured in CONF state. (R/W)

SPI_MASTER_CS_POL SPI_MASTER_CS_POL[i] configures the polarity of SPI CS_i (i is from 0 ~ 5) line in master mode. 0: CS_i is low active. 1: CS_i is high active. Can be configured in CONF state. (R/W)

SPI_SLAVE_CS_POL Configure SPI slave input CS polarity. 1: invert. 0: not change. Can be configured in CONF state. (R/W)

SPI_CLK_IDLE_EDGE 1: SPI_CLK line is high when GP-SPI3 is in idle. 0: SPI_CLK line is low when GP-SPI3 is in idle. Can be configured in CONF state. (R/W)

SPI_CS_KEEP_ACTIVE SPI CS line keeps low when the bit is set. Can be configured in CONF state. (R/W)

SPI_QUAD_DIN_PIN_SWAP 1: SPI quad input swap enable. 0: SPI quad input swap disable. Can be configured in CONF state. (R/W)

Register 30.12. SPI_SLAVE1_REG (0x00E4)

SPI_SLV_LAST_ADDR		SPI_SLV_LAST_COMMAND		SPI_SLV_DATA_BITLEN	
31	26	25	18	17	0
0		0		0	
Reset					

SPI_SLV_DATA_BITLEN Configure the transferred data bit length in SPI slave full-/half-duplex modes. (R/W/SS)

SPI_SLV_LAST_COMMAND In slave mode, it is the value of command. (R/W/SS)

SPI_SLV_LAST_ADDR In slave mode, it is the value of address. (R/W/SS)

Register 30.13. SPI_CLOCK_REG (0x000C)

SPI_CLK_EQU_SYSCLK		(reserved)		SPI_CLKDIV_PRE		SPI_CLKCNT_N		SPI_CLKCNT_H		SPI_CLKCNT_L	
31	30	22	21	18	17	12	11	6	5	0	0
1		0 0 0 0 0 0 0 0		0		0x3		0x1		0x3	
Reset											

SPI_CLKCNT_L In master mode, this field must be equal to SPI_CLKCNT_N. In slave mode, it must be 0. Can be configured in CONF state. (R/W)

SPI_CLKCNT_H In master mode, this field must be $\text{floor}((\text{SPI_CLKCNT_N} + 1)/2 - 1)$. $\text{floor}()$ here is to down round a number, $\text{floor}(2.2) = 2$. In slave mode, it must be 0. Can be configured in CONF state. (R/W)

SPI_CLKCNT_N In master mode, this is the divider of SPI_CLK. So SPI_CLK frequency is $f_{\text{apb_clk}}/(\text{SPI_CLKDIV_PRE} + 1)/(\text{SPI_CLKCNT_N} + 1)$. Can be configured in CONF state. (R/W)

SPI_CLKDIV_PRE In master mode, this is pre-divider of SPI_CLK. Can be configured in CONF state. (R/W)

SPI_CLK_EQU_SYSCLK In master mode, 1: SPI_CLK is equal to APB_CLK. 0: SPI_CLK is divided from APB_CLK. Can be configured in CONF state. (R/W)

Register 30.14. SPI_CLK_GATE_REG (0x00E8)

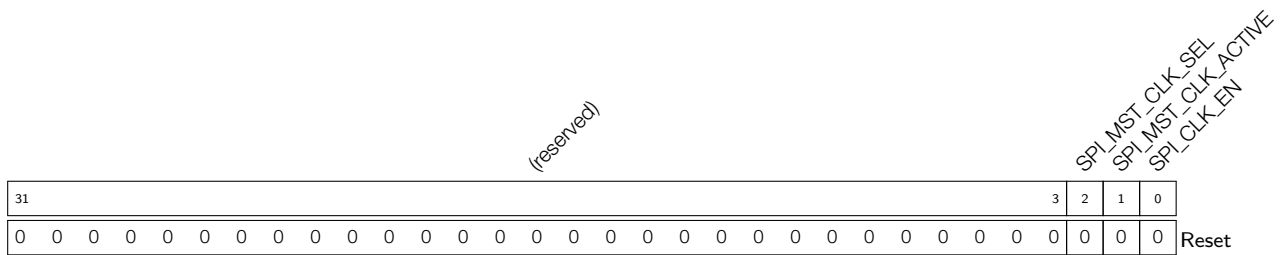

SPI_CLK_EN Set this bit to enable clock gate. (R/W)

SPI_MST_CLK_ACTIVE Set this bit to power on the SPI module clock. (R/W)

SPI_MST_CLK_SEL This bit is used to select SPI module clock source in master mode.

1: PLL_F80M_CLK

0: XTAL_CLK

(R/W)

Register 30.15. SPI_DIN_MODE_REG (0x0024)

(reserved)																	SPI_TIMING_HCLK_ACTIVE	(reserved)	SPI_DIN7_MODE	(reserved)	SPI_DIN6_MODE	(reserved)	SPI_DIN5_MODE	(reserved)	SPI_DIN4_MODE	SPI_DIN3_MODE	SPI_DIN2_MODE	SPI_DIN1_MODE	SPI_DIN0_MODE								
31																		17	16	15	14	13	12	11	10	9	8	7	6	5	4	3	2	1	0		
0	0	0	0	0	0	0	0	0	0	0	0	0	0	0	0	0	0	0	0	0	0	0	0	0	0	0	0	0	0	0	0	0	0	0	0	0	Reset

SPI_DIN0_MODE Configure the input mode for input data bit0 signal. Can be configured in CONF state. (R/W)

- 0: input without delay
- 1: input data is delayed by the falling edge of [SPI_CLK](#) for $(\text{SPI_DIN0_NUM} + 1)$ cycles
- 2: input data is delayed by the rising edge of [clk_hclk](#) for $(\text{SPI_DIN0_NUM} + 1)$ cycles, and then delayed by the rising edge of [SPI_CLK](#) for one cycle
- 3: input data is delayed by the rising edge of [clk_hclk](#) for $(\text{SPI_DIN0_NUM} + 1)$ cycles, and then delayed by the falling edge of [SPI_CLK](#) for one cycle

SPI_DIN1_MODE Configure the input mode for input data bit1 signal. Can be configured in CONF state. (R/W)

- 0: input without delay
- 1: input data is delayed by the falling edge of [SPI_CLK](#) for $(\text{SPI_DIN1_NUM} + 1)$ cycles
- 2: input data is delayed by the rising edge of [clk_hclk](#) for $(\text{SPI_DIN1_NUM} + 1)$ cycles, and then delayed by the rising edge of [SPI_CLK](#) for one cycle
- 3: input data is delayed by the rising edge of [clk_hclk](#) for $(\text{SPI_DIN1_NUM} + 1)$ cycles, and then delayed by the falling edge of [SPI_CLK](#) for one cycle

SPI_DIN2_MODE Configure the input mode for input data bit2 signal. Can be configured in CONF state. (R/W)

- 0: input without delay
- 1: input data is delayed by the falling edge of [SPI_CLK](#) for $(\text{SPI_DIN2_NUM} + 1)$ cycles
- 2: input data is delayed by the rising edge of [clk_hclk](#) for $(\text{SPI_DIN2_NUM} + 1)$ cycles, and then delayed by the rising edge of [SPI_CLK](#) for one cycle
- 3: input data is delayed by the rising edge of [clk_hclk](#) for $(\text{SPI_DIN2_NUM} + 1)$ cycles, and then delayed by the falling edge of [SPI_CLK](#) for one cycle

Continued on the next page...

Register 30.15. SPI_DIN_MODE_REG (0x0024)

Continued from the previous page...

SPI_DIN3_MODE Configure the input mode for input data bit3 signal. Can be configured in CONF state. (R/W)

- 0: input without delay
- 1: input data is delayed by the falling edge of `SPI_CLK` for $(\text{SPI_DIN3_NUM} + 1)$ cycles
- 2: input data is delayed by the rising edge of `clk_hclk` for $(\text{SPI_DIN3_NUM} + 1)$ cycles, and then delayed by the rising edge of `SPI_CLK` for one cycle
- 3: input data is delayed by the rising edge of `clk_hclk` for $(\text{SPI_DIN3_NUM} + 1)$ cycles, and then delayed by the falling edge of `SPI_CLK` for one cycle

SPI_DIN4_MODE (for SPI2 only) Configure the input mode for input data bit4 signal. Can be configured in CONF state. (R/W)

- 0: input without delay
- 1: input data is delayed by the falling edge of `SPI_CLK` for $(\text{SPI_DIN4_NUM} + 1)$ cycles
- 2: input data is delayed by the rising edge of `clk_hclk` for $(\text{SPI_DIN4_NUM} + 1)$ cycles, and then delayed by the rising edge of `SPI_CLK` for one cycle
- 3: input data is delayed by the rising edge of `clk_hclk` for $(\text{SPI_DIN4_NUM} + 1)$ cycles, and then delayed by the falling edge of `SPI_CLK` for one cycle

SPI_DIN5_MODE (for SPI2 only) Configure the input mode for input data bit5 signal. Can be configured in CONF state. (R/W)

- 0: input without delay
- 1: input data is delayed by the falling edge of `SPI_CLK` for $(\text{SPI_DIN5_NUM} + 1)$ cycles
- 2: input data is delayed by the rising edge of `clk_hclk` for $(\text{SPI_DIN5_NUM} + 1)$ cycles, and then delayed by the rising edge of `SPI_CLK` for one cycle
- 3: input data is delayed by the rising edge of `clk_hclk` for $(\text{SPI_DIN5_NUM} + 1)$ cycles, and then delayed by the falling edge of `SPI_CLK` for one cycle

SPI_DIN6_MODE (for SPI2 only) Configure the input mode for input data bit6 signal. Can be configured in CONF state. (R/W)

- 0: input without delay
- 1: input data is delayed by the falling edge of `SPI_CLK` for $(\text{SPI_DIN6_NUM} + 1)$ cycles
- 2: input data is delayed by the rising edge of `clk_hclk` for $(\text{SPI_DIN6_NUM} + 1)$ cycles, and then delayed by the rising edge of `SPI_CLK` for one cycle
- 3: input data is delayed by the rising edge of `clk_hclk` for $(\text{SPI_DIN6_NUM} + 1)$ cycles, and then delayed by the falling edge of `SPI_CLK` for one cycle

Continued on the next page...

Register 30.15. SPI_DIN_MODE_REG (0x0024)

Continued from the previous page...

SPI_DIN7_MODE (for SPI2 only) Configure the input mode for input data bit7 signal. Can be configured in CONF state. (R/W)

- 0: input without delay
- 1: input data is delayed by the falling edge of `SPI_CLK` for (`SPI_DIN7_NUM` +1) cycles
- 2: input data is delayed by the rising edge of `clk_hclk` for (`SPI_DIN7_NUM` +1) cycles, and then delayed by the rising edge of `SPI_CLK` for one cycle
- 3: input data is delayed by the rising edge of `clk_hclk` for (`SPI_DIN7_NUM` +1) cycles, and then delayed by the falling edge of `SPI_CLK` for one cycle

SPI_TIMING_HCLK_ACTIVE 1: Enable `clk_hclk` (high-frequency clock) in SPI input timing module.
0: disable `clk_hclk`. Can be configured in CONF state. (R/W)

Register 30.16. SPI_DIN_NUM_REG (0x0028)

(reserved)																(reserved)		SPI_DIN7_NUM	(reserved)	SPI_DIN6_NUM	(reserved)	SPI_DIN5_NUM	(reserved)	SPI_DIN4_NUM	SPI_DIN3_NUM	SPI_DIN2_NUM	SPI_DIN1_NUM	SPI_DIN0_NUM					
31																16	15	14	13	12	11	10	9	8	7	6	5	4	3	2	1	0	
0																0	0	0	0	0	0	0	0	0	0	0	0	0	0	0	0	0	Reset

SPI_DIN0_NUM Configure the delays to input data bit0 signal based on the setting of [SPI_DIN0_MODE](#). Can be configured in CONF state. (R/W)

SPI_DIN1_NUM Configure the delays to input data bit1 signal based on the setting of [SPI_DIN1_MODE](#). Can be configured in CONF state. (R/W)

SPI_DIN2_NUM Configure the delays to input data bit2 signal based on the setting of [SPI_DIN2_MODE](#). Can be configured in CONF state. (R/W)

SPI_DIN3_NUM Configure the delays to input data bit3 signal based on the setting of [SPI_DIN3_MODE](#). Can be configured in CONF state. (R/W)

SPI_DIN4_NUM (for SPI2 only) Configure the delays to input data bit4 signal based on the setting of [SPI_DIN4_MODE](#). Can be configured in CONF state. (R/W)

SPI_DIN5_NUM (for SPI2 only) Configure the delays to input data bit5 signal based on the setting of [SPI_DIN5_MODE](#). Can be configured in CONF state. (R/W)

SPI_DIN6_NUM (for SPI2 only) Configure the delays to input data bit6 signal based on the setting of [SPI_DIN6_MODE](#). Can be configured in CONF state. (R/W)

SPI_DIN7_NUM (for SPI2 only) Configure the delays to input data bit7 signal based on the setting of [SPI_DIN7_MODE](#). Can be configured in CONF state. (R/W)

Register 30.17. SPI_DOUT_MODE_REG (0x002C)

(reserved)										(reserved) SPI_D_DQS_MODE (reserved) SPI_DOUT7_MODE (reserved) SPI_DOUT6_MODE (reserved) SPI_DOUT5_MODE (reserved) SPI_DOUT4_MODE SPI_DOUT3_MODE SPI_DOUT2_MODE SPI_DOUT1_MODE SPI_DOUT0_MODE											
31											9	8	7	6	5	4	3	2	1	0	Reset
0										0											

SPI_DOUT0_MODE Configure the output mode for output data bit0 signal. Can be configured in CONF state. (R/W)

- 0: output without delay
- 1: output data is delayed by the falling edge of [SPI_CLK](#) for one cycle

SPI_DOUT1_MODE Configure the output mode for output data bit1 signal. Can be configured in CONF state. (R/W)

- 0: output without delay
- 1: output data is delayed by the falling edge of [SPI_CLK](#) for one cycle

SPI_DOUT2_MODE Configure the output mode for output data bit2 signal. Can be configured in CONF state. (R/W)

- 0: output without delay
- 1: output data is delayed by the falling edge of [SPI_CLK](#) for one cycle

SPI_DOUT3_MODE Configure the output mode for output data bit3 signal. Can be configured in CONF state. (R/W)

- 0: output without delay
- 1: output data is delayed by the falling edge of [SPI_CLK](#) for one cycle

SPI_DOUT4_MODE (for SPI2 only) Configure the output mode for output data bit4 signal. Can be configured in CONF state. (R/W)

- 0: output without delay
- 1: output data is delayed by the falling edge of [SPI_CLK](#) for one cycle

SPI_DOUT5_MODE (for SPI2 only) Configure the output mode for output data bit5 signal. Can be configured in CONF state. (R/W)

- 0: output without delay
- 1: output data is delayed by the falling edge of [SPI_CLK](#) for one cycle

Continued on the next page...

Register 30.17. SPI_DOUT_MODE_REG (0x002C)

Continued from the previous page...

SPI_DOUT6_MODE (for SPI2 only) Configure the output mode for output data bit6 signal. Can be configured in CONF state. (R/W)

- 0: output without delay
- 1: output data is delayed by the falling edge of [SPI_CLK](#) for one cycle

SPI_DOUT7_MODE (for SPI2 only) Configure the output mode for output data bit7 signal. Can be configured in CONF state. (R/W)

- 0: output without delay
- 1: output data is delayed by the falling edge of [SPI_CLK](#) for one cycle

SPI_D_DQS_MODE (for SPI2 only) Configure the output mode for output SPI_DQS signal. Can be configured in CONF state. (R/W)

- 0: output without delay
- 1: output data is delayed by the falling edge of [SPI_CLK](#) for one cycle

Register 30.18. **SPI_DMA_INT_ENA_REG (0x0034)**

(reserved)											SPI_APP1_INT_ENA	SPI_APP2_INT_ENA	SPI_MST_TX_INT_ENA	SPI_MST_RX_INT_ENA	SPI_SLV_CMD_ERR_INT_ENA	(reserved)	(reserved)	SPI_DMA_SEG_TRANS_DONE_INT_ENA	SPI_TRANS_DONE_INT_ENA	SPI_SLV_WR_BUF_DONE_INT_ENA	SPI_SLV_RD_BUF_DONE_INT_ENA	SPI_SLV_WR_DMA_DONE_INT_ENA	SPI_SLV_RD_DMA_DONE_INT_ENA	SPI_SLV_CMDA_INT_ENA	SPI_SLV_CMD9_INT_ENA	SPI_SLV_CMD8_INT_ENA	SPI_SLV_CMD7_INT_ENA	SPI_SLV_EX_QPI_INT_ENA	SPI_SLV_EN_QPI_INT_ENA	SPI_DMA_OUTFIFO_EMPTY_ERR_INT_ENA	SPI_DMA_INFIFO_FULL_ERR_INT_ENA	
31											21	20	19	18	17	16	15	14	13	12	11	10	9	8	7	6	5	4	3	2	1	0
0	0	0	0	0	0	0	0	0	0	0	0	0	0	0	0	0	0	0	0	0	0	0	0	0	0	0	0	0	0	0	0	Reset

SPI_DMA_INFIFO_FULL_ERR_INT_ENA The enable bit for **SPI_DMA_INFIFO_FULL_ERR_INT** interrupt. (R/W)

SPI_DMA_OUTFIFO_EMPTY_ERR_INT_ENA The enable bit for **SPI_DMA_OUTFIFO_EMPTY_ERR_INT** interrupt. (R/W)

SPI_SLV_EX_QPI_INT_ENA The enable bit for **SPI_SLV_EX_QPI_INT** interrupt. (R/W)

SPI_SLV_EN_QPI_INT_ENA The enable bit for **SPI_SLV_EN_QPI_INT** interrupt. (R/W)

SPI_SLV_CMD7_INT_ENA The enable bit for **SPI_SLV_CMD7_INT** interrupt. (R/W)

SPI_SLV_CMD8_INT_ENA The enable bit for **SPI_SLV_CMD8_INT** interrupt. (R/W)

SPI_SLV_CMD9_INT_ENA The enable bit for **SPI_SLV_CMD9_INT** interrupt. (R/W)

SPI_SLV_CMDA_INT_ENA The enable bit for **SPI_SLV_CMDA_INT** interrupt. (R/W)

SPI_SLV_RD_DMA_DONE_INT_ENA The enable bit for **SPI_SLV_RD_DMA_DONE_INT** interrupt. (R/W)

SPI_SLV_WR_DMA_DONE_INT_ENA The enable bit for **SPI_SLV_WR_DMA_DONE_INT** interrupt. (R/W)

SPI_SLV_RD_BUF_DONE_INT_ENA The enable bit for **SPI_SLV_RD_BUF_DONE_INT** interrupt. (R/W)

SPI_SLV_WR_BUF_DONE_INT_ENA The enable bit for **SPI_SLV_WR_BUF_DONE_INT** interrupt. (R/W)

SPI_TRANS_DONE_INT_ENA The enable bit for **SPI_TRANS_DONE_INT** interrupt. (R/W)

SPI_DMA_SEG_TRANS_DONE_INT_ENA The enable bit for **SPI_DMA_SEG_TRANS_DONE_INT** interrupt. (R/W)

SPI_SEG_MAGIC_ERR_INT_ENA (for SPI2 only) The enable bit for **SPI_SEG_MAGIC_ERR_INT** interrupt. (R/W)

SPI_SLV_CMD_ERR_INT_ENA The enable bit for **SPI_SLV_CMD_ERR_INT** interrupt. (R/W)

Continued on the next page...

Register 30.18. SPI_DMA_INT_ENA_REG (0x0034)

Continued from the previous page...

SPI_MST_RX_AFIFO_WFULL_ERR_INT_ENA The enable bit for [SPI_MST_RX_AFIFO_WFULL_ERR_INT](#) interrupt. (R/W)

SPI_MST_TX_AFIFO_EMPTY_ERR_INT_ENA The enable bit for [SPI_MST_TX_AFIFO_EMPTY_ERR_INT](#) interrupt. (R/W)

SPI_APP2_INT_ENA The enable bit for [SPI_APP2_INT](#) interrupt. (R/W)

SPI_APP1_INT_ENA The enable bit for [SPI_APP1_INT](#) interrupt. (R/W)

Register 30.19. SPI_DMA_INT_CLR_REG (0x0038)

(reserved)		SPI_APP1_INT_CLR			SPI_APP2_INT_CLR			SPI_MST_TX_AFIPO_EMPTY_ERR_INT_CLR			SPI_MST_RX_AFIPO_WFULL_ERR_INT_CLR			(reserved)			SPI_DMA_SEG_TRANS_DONE_INT_CLR			SPI_SLV_WR_BUF_DONE_INT_CLR			SPI_SLV_RD_BUF_DONE_INT_CLR			SPI_SLV_RD_DMA_DONE_INT_CLR			SPI_SLV_CMD9_INT_CLR			SPI_SLV_CMD8_INT_CLR			SPI_SLV_CMD7_INT_CLR			SPI_SLV_EX_QPI_INT_CLR			SPI_DMA_OUTFIFO_EMPTY_ERR_INT_CLR			SPI_DMA_INFIFO_FULL_ERR_INT_CLR		
31	21	20	19	18	17	16	15	14	13	12	11	10	9	8	7	6	5	4	3	2	1	0	Reset																							
0												0												0																						

SPI_DMA_INFIFO_FULL_ERR_INT_CLR The clear bit for [SPI_DMA_INFIFO_FULL_ERR_INT](#) interrupt. (WT)

SPI_DMA_OUTFIFO_EMPTY_ERR_INT_CLR The clear bit for [SPI_DMA_OUTFIFO_EMPTY_ERR_INT](#) interrupt. (WT)

SPI_SLV_EX_QPI_INT_CLR The clear bit for [SPI_SLV_EX_QPI_INT](#) interrupt. (WT)

SPI_SLV_EN_QPI_INT_CLR The clear bit for [SPI_SLV_EN_QPI_INT](#) interrupt. (WT)

SPI_SLV_CMD7_INT_CLR The clear bit for [SPI_SLV_CMD7_INT](#) interrupt. (WT)

SPI_SLV_CMD8_INT_CLR The clear bit for [SPI_SLV_CMD8_INT](#) interrupt. (WT)

SPI_SLV_CMD9_INT_CLR The clear bit for [SPI_SLV_CMD9_INT](#) interrupt. (WT)

SPI_SLV_CMDA_INT_CLR The clear bit for [SPI_SLV_CMDA_INT](#) interrupt. (WT)

SPI_SLV_RD_DMA_DONE_INT_CLR The clear bit for [SPI_SLV_RD_DMA_DONE_INT](#) interrupt. (WT)

SPI_SLV_WR_DMA_DONE_INT_CLR The clear bit for [SPI_SLV_WR_DMA_DONE_INT](#) interrupt. (WT)

SPI_SLV_RD_BUF_DONE_INT_CLR The clear bit for [SPI_SLV_RD_BUF_DONE_INT](#) interrupt. (WT)

SPI_SLV_WR_BUF_DONE_INT_CLR The clear bit for [SPI_SLV_WR_BUF_DONE_INT](#) interrupt. (WT)

SPI_TRANS_DONE_INT_CLR The clear bit for [SPI_TRANS_DONE_INT](#) interrupt. (WT)

SPI_DMA_SEG_TRANS_DONE_INT_CLR The clear bit for [SPI_DMA_SEG_TRANS_DONE_INT](#) interrupt. (WT)

SPI_SEG_MAGIC_ERR_INT_CLR (for SPI2 only) The clear bit for [SPI_SEG_MAGIC_ERR_INT](#) interrupt. (WT)

SPI_SLV_CMD_ERR_INT_CLR The clear bit for [SPI_SLV_CMD_ERR_INT](#) interrupt. (WT)

Continued on the next page...

Register 30.19. SPI_DMA_INT_CLR_REG (0x0038)

Continued from the previous page...

SPI_MST_RX_AFIFO_WFULL_ERR_INT_CLR The clear bit for [SPI_MST_RX_AFIFO_WFULL_ERR_INT](#) interrupt. (WT)

SPI_MST_TX_AFIFO_REMPTY_ERR_INT_CLR The clear bit for [SPI_MST_TX_AFIFO_REMPTY_ERR_INT](#) interrupt. (WT)

SPI_APP2_INT_CLR The clear bit for [SPI_APP2_INT](#) interrupt. (WT)

SPI_APP1_INT_CLR The clear bit for [SPI_APP1_INT](#) interrupt. (WT)

Register 30.20. SPI_DMA_INT_RAW_REG (0x003C)

(reserved)											SPI_APP1_INT_RAW SPI_APP2_INT_RAW SPI_MST_TX_AFFO_EMPTY_ERR_INT_RAW SPI_MST_RX_AFFO_WFULL_ERR_INT_RAW SPI_SLV_CMD_ERR_INT_RAW (reserved) (reserved) SPI_DMA_SEG_TRANS_DONE_INT_RAW SPI_TRANS_DONE_INT_RAW SPI_SLV_WR_BUF_DONE_INT_RAW SPI_SLV_RD_BUF_DONE_INT_RAW SPI_SLV_WR_DMA_DONE_INT_RAW SPI_SLV_RD_DMA_DONE_INT_RAW SPI_SLV_CMD9_INT_RAW SPI_SLV_CMD8_INT_RAW SPI_SLV_CMD7_INT_RAW SPI_SLV_EN_QPI_INT_RAW SPI_SLV_EX_QPI_INT_RAW SPI_DMA_OUTFIFO_EMPTY_ERR_INT_RAW SPI_DMA_INFIFO_FULL_ERR_INT_RAW											
31	21	20	19	18	17	16	15	14	13	12	11	10	9	8	7	6	5	4	3	2	1	0
0	0	0	0	0	0	0	0	0	0	0	0	0	0	0	0	0	0	0	0	0	0	0

Reset

SPI_DMA_INFIFO_FULL_ERR_INT_RAW The raw bit for [SPI_DMA_INFIFO_FULL_ERR_INT](#) interrupt. (R/WTC/SS)

SPI_DMA_OUTFIFO_EMPTY_ERR_INT_RAW The raw bit for [SPI_DMA_OUTFIFO_EMPTY_ERR_INT](#) interrupt. (R/WTC/SS)

SPI_SLV_EX_QPI_INT_RAW The raw bit for [SPI_SLV_EX_QPI_INT](#) interrupt. (R/WTC/SS)

SPI_SLV_EN_QPI_INT_RAW The raw bit for [SPI_SLV_EN_QPI_INT](#) interrupt. (R/WTC/SS)

SPI_SLV_CMD7_INT_RAW The raw bit for [SPI_SLV_CMD7_INT](#) interrupt. (R/WTC/SS)

SPI_SLV_CMD8_INT_RAW The raw bit for [SPI_SLV_CMD8_INT](#) interrupt. (R/WTC/SS)

SPI_SLV_CMD9_INT_RAW The raw bit for [SPI_SLV_CMD9_INT](#) interrupt. (R/WTC/SS)

SPI_SLV_CMDA_INT_RAW The raw bit for [SPI_SLV_CMDA_INT](#) interrupt. (R/WTC/SS)

SPI_SLV_RD_DMA_DONE_INT_RAW The raw bit for [SPI_SLV_RD_DMA_DONE_INT](#) interrupt. (R/WTC/SS)

SPI_SLV_WR_DMA_DONE_INT_RAW The raw bit for [SPI_SLV_WR_DMA_DONE_INT](#) interrupt. (R/WTC/SS)

SPI_SLV_RD_BUF_DONE_INT_RAW The raw bit for [SPI_SLV_RD_BUF_DONE_INT](#) interrupt. (R/WTC/SS)

SPI_SLV_WR_BUF_DONE_INT_RAW The raw bit for [SPI_SLV_WR_BUF_DONE_INT](#) interrupt. (R/WTC/SS)

SPI_TRANS_DONE_INT_RAW The raw bit for [SPI_TRANS_DONE_INT](#) interrupt. (R/WTC/SS)

Continued on the next page...

Register 30.20. SPI_DMA_INT_RAW_REG (0x003C)

Continued from the previous page...

SPI_DMA_SEG_TRANS_DONE_INT_RAW The raw bit for [SPI_DMA_SEG_TRANS_DONE_INT](#) interrupt. (R/WTC/SS)

SPI_SEG_MAGIC_ERR_INT_RAW (for SPI2 only) The raw bit for [SPI_SEG_MAGIC_ERR_INT](#) interrupt. (R/WTC/SS)

SPI_SLV_CMD_ERR_INT_RAW The raw bit for [SPI_SLV_CMD_ERR_INT](#) interrupt. (R/WTC/SS)

SPI_MST_RX_AFIFO_WFULL_ERR_INT_RAW The raw bit for [SPI_MST_RX_AFIFO_WFULL_ERR_INT](#) interrupt. (R/WTC/SS)

SPI_MST_TX_AFIFO_EMPTY_ERR_INT_RAW The raw bit for [SPI_MST_TX_AFIFO_EMPTY_ERR_INT](#) interrupt. (R/WTC/SS)

SPI_APP2_INT_RAW The raw bit for [SPI_APP2_INT](#) interrupt. The value is only controlled by software. (R/WTC/SS)

SPI_APP1_INT_RAW The raw bit for [SPI_APP1_INT](#) interrupt. The value is only controlled by software. (R/WTC/SS)

Register 30.21. **SPI_DMA_INT_ST_REG (0x0040)**

(reserved)	SPI_APP1_INT_ST	SPI_APP2_INT_ST	SPI_MST_TX_AFIFO_EMPTY_ERR_INT_ST	SPI_MST_RX_AFIFO_WFULL_ERR_INT_ST	SPI_SLV_CMD_ERR_INT_ST	(reserved)	(reserved)	SPI_DMA_SEG_MAGIC_ERR_INT_ST	SPI_TRANS_DONE_INT_ST	SPI_SLV_WR_BUF_DONE_INT_ST	SPI_SLV_RD_BUF_DONE_INT_ST	SPI_SLV_WR_DMA_DONE_INT_ST	SPI_SLV_RD_DMA_DONE_INT_ST	SPI_SLV_CMDA_INT_ST	SPI_SLV_CMD9_INT_ST	SPI_SLV_CMD8_INT_ST	SPI_SLV_EN_QPI_INT_ST	SPI_SLV_EX_QPI_INT_ST	SPI_DMA_OUTFIFO_EMPTY_ERR_INT_ST	SPI_DMA_INFIFO_FULL_ERR_INT_ST		
31	21	20	19	18	17	16	15	14	13	12	11	10	9	8	7	6	5	4	3	2	1	0
0	0	0	0	0	0	0	0	0	0	0	0	0	0	0	0	0	0	0	0	0	0	0

Reset

SPI_DMA_INFIFO_FULL_ERR_INT_ST The status bit for [SPI_DMA_INFIFO_FULL_ERR_INT](#) interrupt. (RO)

SPI_DMA_OUTFIFO_EMPTY_ERR_INT_ST The status bit for [SPI_DMA_OUTFIFO_EMPTY_ERR_INT](#) interrupt. (RO)

SPI_SLV_EX_QPI_INT_ST The status bit for [SPI_SLV_EX_QPI_INT](#) interrupt. (RO)

SPI_SLV_EN_QPI_INT_ST The status bit for [SPI_SLV_EN_QPI_INT](#) interrupt. (RO)

SPI_SLV_CMD7_INT_ST The status bit for [SPI_SLV_CMD7_INT](#) interrupt. (RO)

SPI_SLV_CMD8_INT_ST The status bit for [SPI_SLV_CMD8_INT](#) interrupt. (RO)

SPI_SLV_CMD9_INT_ST The status bit for [SPI_SLV_CMD9_INT](#) interrupt. (RO)

SPI_SLV_CMDA_INT_ST The status bit for [SPI_SLV_CMDA_INT](#) interrupt. (RO)

SPI_SLV_RD_DMA_DONE_INT_ST The status bit for [SPI_SLV_RD_DMA_DONE_INT](#) interrupt. (RO)

SPI_SLV_WR_DMA_DONE_INT_ST The status bit for [SPI_SLV_WR_DMA_DONE_INT](#) interrupt. (RO)

SPI_SLV_RD_BUF_DONE_INT_ST The status bit for [SPI_SLV_RD_BUF_DONE_INT](#) interrupt. (RO)

SPI_SLV_WR_BUF_DONE_INT_ST The status bit for [SPI_SLV_WR_BUF_DONE_INT](#) interrupt. (RO)

SPI_TRANS_DONE_INT_ST The status bit for [SPI_TRANS_DONE_INT](#) interrupt. (RO)

SPI_DMA_SEG_TRANS_DONE_INT_ST The status bit for [SPI_DMA_SEG_TRANS_DONE_INT](#) interrupt. (RO)

SPI_SEG_MAGIC_ERR_INT_ST (for SPI2 only) The status bit for [SPI_SEG_MAGIC_ERR_INT](#) interrupt. (RO)

SPI_SLV_CMD_ERR_INT_ST The status bit for [SPI_SLV_CMD_ERR_INT](#) interrupt. (RO)

SPI_MST_RX_AFIFO_WFULL_ERR_INT_ST The status bit for [SPI_MST_RX_AFIFO_WFULL_ERR_INT](#) interrupt. (RO)

Continued on the next page...

Register 30.21. SPI_DMA_INT_ST_REG (0x0040)

Continued from the previous page...

SPI_MST_TX_AFIFO_EMPTY_ERR_INT_ST The status bit for [SPI_MST_TX_AFIFO_EMPTY_ERR_INT](#) interrupt. (RO)

SPI_APP2_INT_ST The status bit for [SPI_APP2_INT](#) interrupt. (RO)

SPI_APP1_INT_ST The status bit for [SPI_APP1_INT](#) interrupt. (RO)

Register 30.22. SPI_DMA_INT_SET_REG (0x0044)

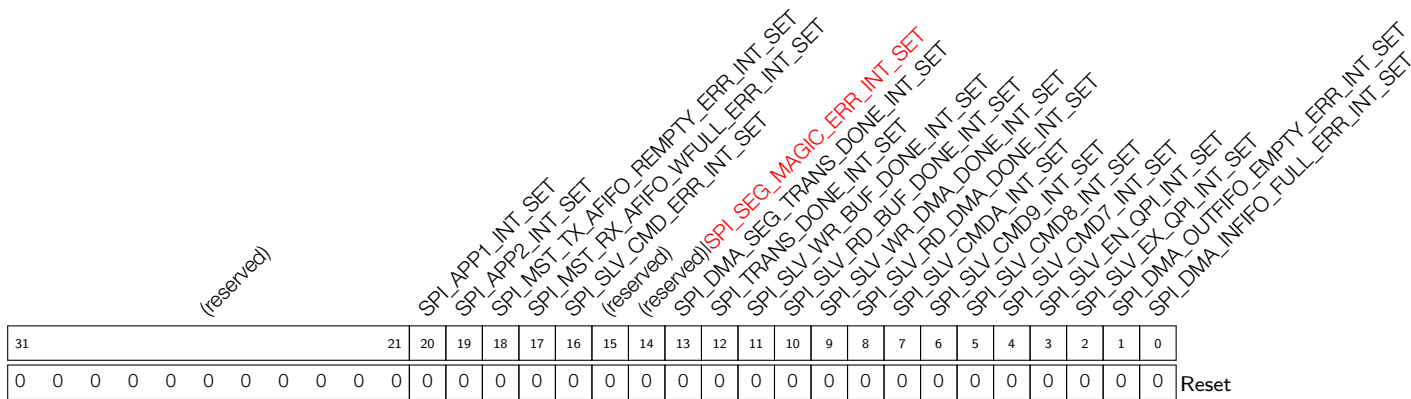

SPI_DMA_INFIFO_FULL_ERR_INT_SET The software set bit for [SPI_DMA_INFIFO_FULL_ERR_INT](#) interrupt. (WT)

SPI_DMA_OUTFIFO_EMPTY_ERR_INT_SET The software set bit for [SPI_DMA_OUTFIFO_EMPTY_ERR_INT](#) interrupt. (WT)

SPI_SLV_EX_QPI_INT_SET The software set bit for [SPI_SLV_EX_QPI_INT](#) interrupt. (WT)

SPI_SLV_EN_QPI_INT_SET The software set bit for [SPI_SLV_EN_QPI_INT](#) interrupt. (WT)

SPI_SLV_CMD7_INT_SET The software set bit for [SPI_SLV_CMD7_INT](#) interrupt. (WT)

SPI_SLV_CMD8_INT_SET The software set bit for [SPI_SLV_CMD8_INT](#) interrupt. (WT)

SPI_SLV_CMD9_INT_SET The software set bit for [SPI_SLV_CMD9_INT](#) interrupt. (WT)

SPI_SLV_CMDA_INT_SET The software set bit for [SPI_SLV_CMDA_INT](#) interrupt. (WT)

Continued on the next page...

Register 30.22. **SPI_DMA_INT_SET_REG (0x0044)**

Continued from the previous page...

SPI_SLV_RD_DMA_DONE_INT_SET The software set bit for [SPI_SLV_RD_DMA_DONE_INT](#) interrupt. (WT)

SPI_SLV_WR_DMA_DONE_INT_SET The software set bit for [SPI_SLV_WR_DMA_DONE_INT](#) interrupt. (WT)

SPI_SLV_RD_BUF_DONE_INT_SET The software set bit for [SPI_SLV_RD_BUF_DONE_INT](#) interrupt. (WT)

SPI_SLV_WR_BUF_DONE_INT_SET The software set bit for [SPI_SLV_WR_BUF_DONE_INT](#) interrupt. (WT)

SPI_TRANS_DONE_INT_SET The software set bit for [SPI_TRANS_DONE_INT](#) interrupt. (WT)

SPI_DMA_SEG_TRANS_DONE_INT_SET The software set bit for [SPI_DMA_SEG_TRANS_DONE_INT](#) interrupt. (WT)

SPI_SEG_MAGIC_ERR_INT_SET (for SPI2 only) The software set bit for [SPI_SEG_MAGIC_ERR_INT](#) interrupt. (WT)

SPI_SLV_CMD_ERR_INT_SET The software set bit for [SPI_SLV_CMD_ERR_INT](#) interrupt. (WT)

SPI_MST_RX_AFIFO_WFULL_ERR_INT_SET The software set bit for [SPI_MST_RX_AFIFO_WFULL_ERR_INT](#) interrupt. (WT)

SPI_MST_TX_AFIFO_REMPTY_ERR_INT_SET The software set bit for [SPI_MST_TX_AFIFO_REMPTY_ERR_INT](#) interrupt. (WT)

SPI_APP2_INT_SET The software set bit for [SPI_APP2_INT](#) interrupt. (WT)

SPI_APP1_INT_SET The software set bit for [SPI_APP1_INT](#) interrupt. (WT)

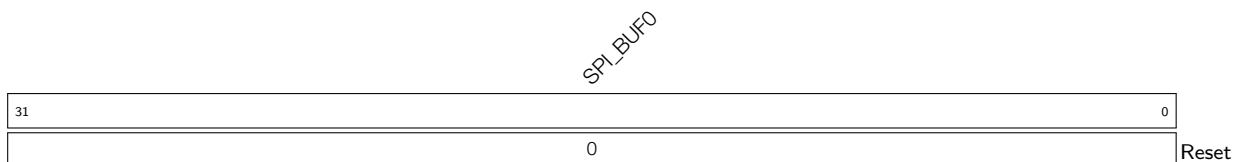
Register 30.23. **SPI_W0_REG (0x0098)**

SPI_BUF0 32-bit data buffer 0. (R/W/SS)

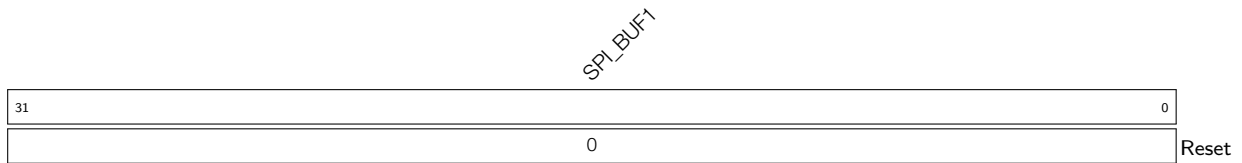
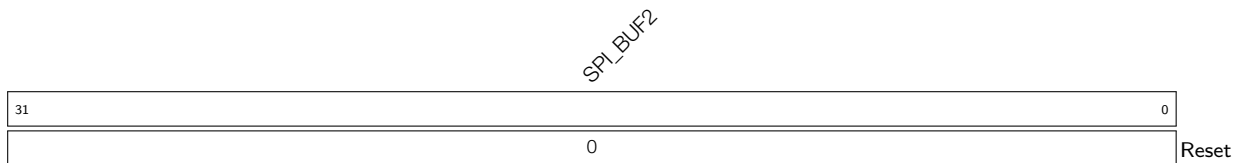
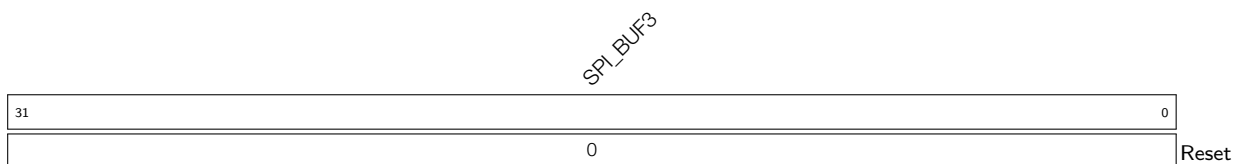
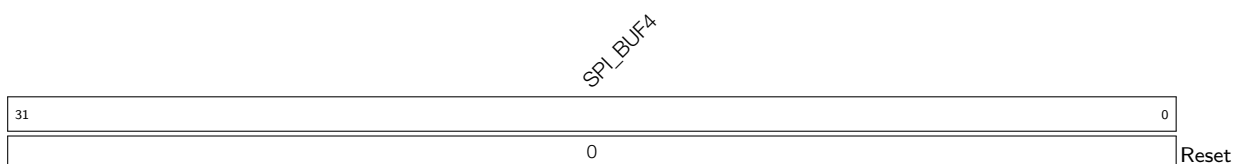
Register 30.24. SPI_W1_REG (0x009C)**SPI_BUF1** 32-bit data buffer 1. (R/W/SS)**Register 30.25. SPI_W2_REG (0x00A0)****SPI_BUF2** 32-bit data buffer 2. (R/W/SS)**Register 30.26. SPI_W3_REG (0x00A4)****SPI_BUF3** 32-bit data buffer 3. (R/W/SS)**Register 30.27. SPI_W4_REG (0x00A8)****SPI_BUF4** 32-bit data buffer 4. (R/W/SS)

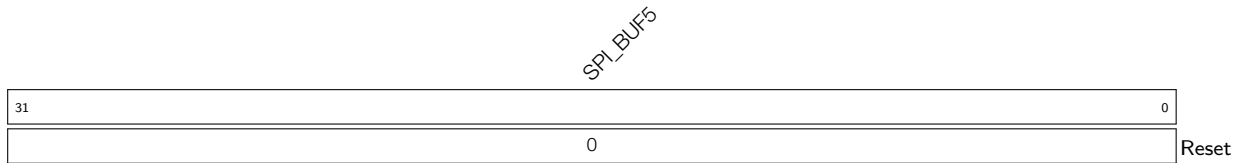
Register 30.28. SPI_W5_REG (0x00AC)

SPI_BUF5 32-bit data buffer 5. (R/W/SS)

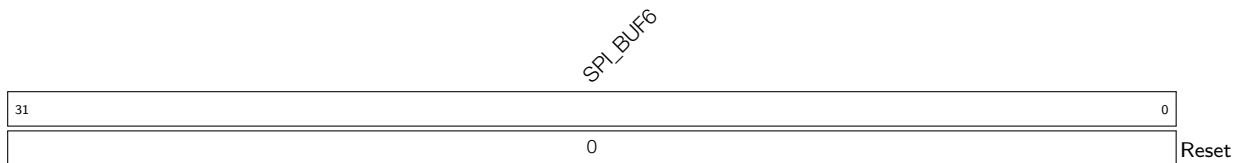
Register 30.29. SPI_W6_REG (0x00B0)

SPI_BUF6 32-bit data buffer 6. (R/W/SS)

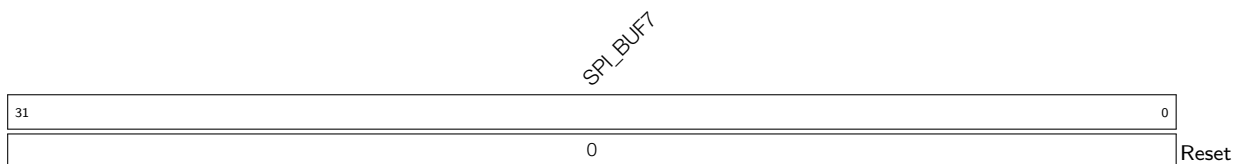
Register 30.30. SPI_W7_REG (0x00B4)

SPI_BUF7 32-bit data buffer 7. (R/W/SS)

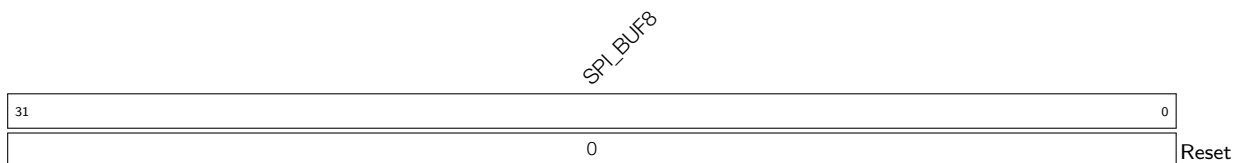
Register 30.31. SPI_W8_REG (0x00B8)

SPI_BUF8 32-bit data buffer 8. (R/W/SS)

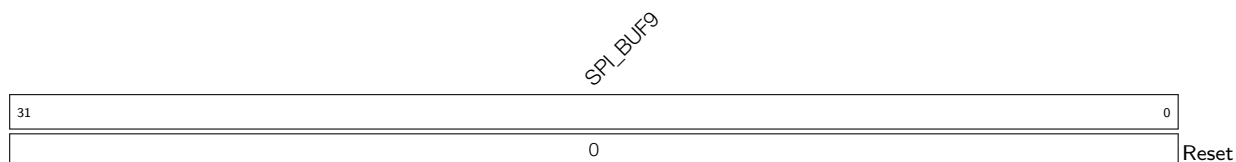
Register 30.32. SPI_W9_REG (0x00BC)

SPI_BUF9 32-bit data buffer 9. (R/W/SS)

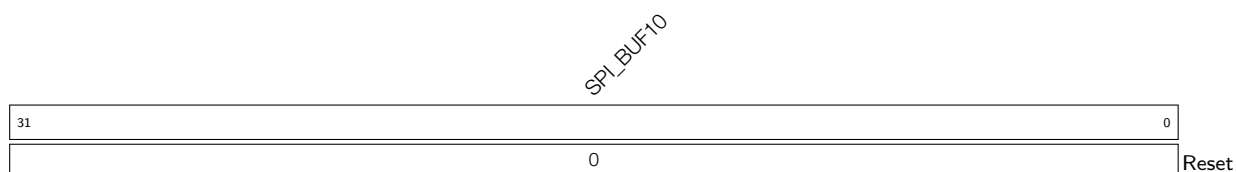
Register 30.33. SPI_W10_REG (0x00C0)

SPI_BUF10 32-bit data buffer 10. (R/W/SS)

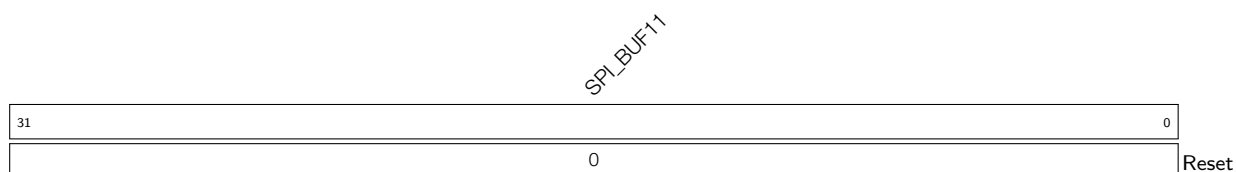
Register 30.34. SPI_W11_REG (0x00C4)

SPI_BUF11 32-bit data buffer 11. (R/W/SS)

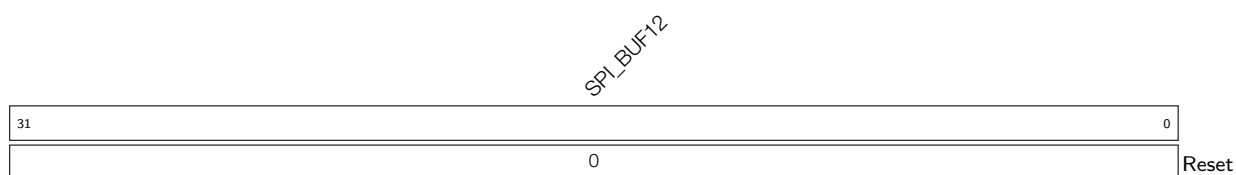
Register 30.35. SPI_W12_REG (0x00C8)

SPI_BUF12 32-bit data buffer 12. (R/W/SS)

Register 30.36. SPI_W13_REG (0x00CC)

31	<i>SPI_BUF13</i>	0
0		Reset

SPI_BUF13 32-bit data buffer 13. (R/W/SS)

Register 30.37. SPI_W14_REG (0x00D0)

31	<i>SPI_BUF14</i>	0
0		Reset

SPI_BUF14 32-bit data buffer 14. (R/W/SS)

Register 30.38. SPI_W15_REG (0x00D4)

31	<i>SPI_BUF15</i>	0
0		Reset

SPI_BUF15 32-bit data buffer 15. (R/W/SS)

Register 30.39. SPI_DATE_REG (0x00F0)

31	<i>(reserved)</i>	28	27	<i>SPI_DATE</i>	0
0 0 0 0				0x2101190	Reset

SPI_DATE Version control register. (R/W)

31 Two-wire Automotive Interface (TWAI®)

31.1 Overview

The Two-wire Automotive Interface (TWAI)® is a multi-master, multi-cast communication protocol with error detection and signaling and inbuilt message priorities and arbitration. The TWAI protocol is suited for automotive and industrial applications (see Section 31.3 for more details).

ESP32-S3 contains a TWAI controller that can be connected to a TWAI bus via an external transceiver. The TWAI controller contains numerous advanced features, and can be utilized in a wide range of use cases such as automotive products, industrial automation controls, building automation etc.

31.2 Features

ESP32-S3 TWAI controller supports the following features:

- Compatible with ISO 11898-1 protocol (CAN Specification 2.0)
- Supports Standard Frame Format (11-bit ID) and Extended Frame Format (29-bit ID)
- Bit rates from 1 Kbit/s to 1 Mbit/s
- Multiple modes of operation
 - Normal
 - Listen-only (no influence on bus)
 - Self-test (no acknowledgment required during data transmission)
- 64-byte Receive FIFO
- Special transmissions
 - Single-shot transmissions (does not automatically re-transmit upon error)
 - Self Reception (the TWAI controller transmits and receives messages simultaneously)
- Acceptance Filter (supports single and dual filter modes)
- Error detection and handling
 - Error Counters
 - Configurable Error Warning Limit
 - Error Code Capture
 - Arbitration Lost Capture

31.3 Functional Protocol

31.3.1 TWAI Properties

The TWAI protocol connects two or more nodes in a bus network, and allows nodes to exchange messages in a latency bounded manner. A TWAI bus has the following properties.

Single Channel and Non-Return-to-Zero: The bus consists of a single channel to carry bits, thus communication is half-duplex. Synchronization is also implemented in this channel, so extra channels (e.g., clock or enable) are not required. The bit stream of a TWAI message is encoded using the Non-Return-to-Zero (NRZ) method.

Bit Values: The single channel can either be in a dominant or recessive state, representing a logical 0 and a logical 1 respectively. A node transmitting data in a dominant state will always override another node transmitting data in a recessive state. The physical implementation on the bus is left to the application level to decide (e.g., differential pair or a single wire).

Bit Stuffing: Certain fields of TWAI messages are bit-stuffed. A transmitter that transmits five consecutive bits of the same value should automatically insert a complementary bit. Likewise, a receiver that receives five consecutive bits should treat the next bit as a stuffed bit. Bit stuffing is applied to the following fields: SOF, arbitration field, control field, data field, and CRC sequence (see Section 31.3.2 for more details).

Multi-cast: All nodes receive the same bits as they are connected to the same bus. Data is consistent across all nodes unless there is a bus error (see Section 31.3.3 for more details).

Multi-master: Any node can initiate a transmission. If a transmission is already ongoing, a node will wait until the current transmission is over before beginning its own transmission.

Message Priorities and Arbitration: If two or more nodes simultaneously initiate a transmission, the TWAI protocol ensures that one node will win arbitration of the bus. The arbitration field of the message transmitted by each node is used to determine which node will win arbitration.

Error Detection and Signaling: Each node will actively monitor the bus for errors, and signal the detection errors by transmitting an error frame.

Fault Confinement: Each node will maintain a set of error counts that are incremented/decremented according to a set of rules. When the error counts surpass a certain threshold, a node will automatically eliminate itself from the network by switching itself off.

Configurable Bit Rate: The bit rate for a single TWAI bus is configurable. However, all nodes within the same bus must operate at the same bit rate.

Transmitters and Receivers: At any point in time, a TWAI node can either be a transmitter or a receiver.

- A node originating a message is a transmitter. The node remains a transmitter until the bus is idle or until the node loses arbitration. Note that multiple nodes can be transmitters if they have yet to lose arbitration.
- All nodes that are not transmitters are receivers.

31.3.2 TWAI Messages

TWAI nodes use messages to transmit data, and signal errors to other nodes. Messages are split into various frame types, and some frame types will have different frame formats.

The TWAI protocol has of the following frame types:

- Data frames
- Remote frames
- Error frames
- Overload frames

- Interframe space

The TWAI protocol has the following frame formats:

- Standard Frame Format (SFF) that consists of a 11-bit identifier
- Extended Frame Format (EFF) that consists of a 29-bit identifier

31.3.2.1 Data Frames and Remote Frames

Data frames are used by nodes to send data to other nodes, and can have a payload of 0 to 8 data bytes.

Remote frames are used for nodes to request a data frame with the same identifier from another node, thus they do not contain any data bytes. However, data frames and remote frames share many common fields. Figure 31-1 illustrates the fields and sub-fields of different frames and formats.

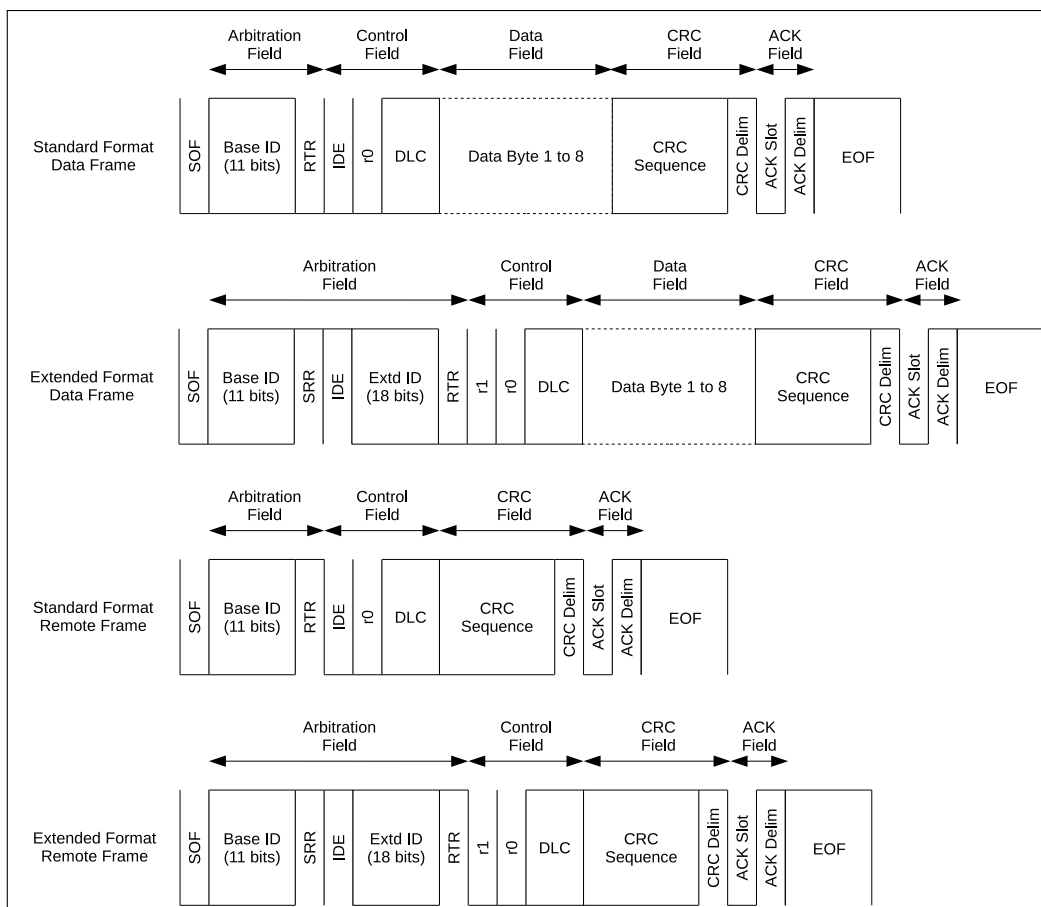

Figure 31-1. Bit Fields in Data Frames and Remote Frames

Arbitration Field

When two or more nodes transmit a data or remote frame simultaneously, the arbitration field is used to determine which node will win arbitration of the bus. During the arbitration field, if a node transmits a recessive bit while observing a dominant bit, this indicates that another node has overridden its recessive bit. Therefore, the node transmitting the recessive bit has lost arbitration of the bus and should immediately switch to be a receiver.

The arbitration field primarily consists of the frame identifier that is transmitted from the most significant bit first. Given that a dominant bit represents a logical 0, and a recessive bit represents a logical 1:

- A frame with the smallest ID value will always win arbitration.

- Given the same ID and format, data frames will always prevail over remote frames.
- Given the same first 11 bits of ID, a Standard Format Data Frame will prevail over an Extended Format Data Frame due to the SRR being recessive.

Control Field

The control field primarily consists of the DLC (Data Length Code) which indicates the number of payload data bytes for a data frame, or the number of requested data bytes for a remote frame. The DLC is transmitted from the most significant bit first.

Data Field

The data field contains the actual payload data bytes of a data frame. Remote frames do not contain a data field.

CRC Field

The CRC field primarily consists of a CRC sequence. The CRC sequence is a 15-bit cyclic redundancy code calculated from the de-stuffed contents (everything from the SOF to the end of the data field) of a data or remote frame.

ACK Field

The ACK field primarily consists of an ACK Slot and an ACK Delim. The ACK field is mainly intended for the receiver to indicate to a transmitter that it has received an effective message.

Table 31-1. Data Frames and Remote Frames in SFF and EFF

Data/Remote Frames	Description
SOF	The SOF (Start of Frame) is a single dominant bit used to synchronize nodes on the bus.
Base ID	The Base ID (ID.28 to ID.18) is the 11-bit identifier for SFF, or the first 11-bits of the 29-bit identifier for EFF.
RTR	The RTR (Remote Transmission Request) bit indicates whether the message is a data frame (dominant) or a remote frame (recessive). This means that a remote frame will always lose arbitration to a data frame given they have the same ID.
SRR	The SRR (Substitute Remote Request) bit is transmitted in EFF to substitute for the RTR bit at the same position in SFF.
IDE	The IDE (Identifier Extension) bit indicates whether the message is SFF (dominant) or EFF (recessive). This means that a SFF frame will always win arbitration over an EFF frame given they have the same Base ID.
Extd ID	The Extended ID (ID.17 to ID.0) is the remaining 18-bits of the 29-bit identifier for EFF.
r1	The r1 bit (reserved bit 1) is always dominant.
r0	The r0 bit (reserved bit 0) is always dominant.
DLC	The DLC (Data Length Code) is 4-bit long and should contain any value from 0 to 8. Data frames use the DLC to indicate the number of data bytes in the data frame. Remote frames used the DLC to indicate the number of data bytes to request from another node.
Data Bytes	The data payload of data frames. The number of bytes should match the value of DLC. Data byte 0 is transmitted first, and each data byte is transmitted from the most significant bit first.

Cont'd on next page

Table 31-1 – cont'd from previous page

Data/Remote Frames	Description
CRC Sequence	The CRC sequence is a 15-bit cyclic redundancy code.
CRC Delim	The CRC Delim (CRC Delimiter) is a single recessive bit that follows the CRC sequence.
ACK Slot	The ACK Slot (Acknowledgment Slot) is intended for receiver nodes to indicate that the data or remote frame was received without an issue. The transmitter node will send a recessive bit in the ACK Slot and receiver nodes should override the ACK Slot with a dominant bit if the frame was received without errors.
ACK Delim	The ACK Delim (Acknowledgment Delimiter) is a single recessive bit.
EOF	The EOF (End of Frame) marks the end of a data or remote frame, and consists of seven recessive bits.

31.3.2.2 Error and Overload Frames

Error Frames

Error frames are transmitted when a node detects a bus error. Error frames notably consist of an Error Flag which is made up of 6 consecutive bits of the same value, thus violating the bit-stuffing rule. Therefore, when a particular node detects a bus error and transmits an error frame, all other nodes will then detect a stuff error and transmit their own error frames in response. This has the effect of propagating the detection of a bus error across all nodes on the bus.

When a node detects a bus error, it will transmit an error frame starting from the next bit. However, if the type of bus error was a CRC error, then the error frame will start at the bit following the ACK Delim (see Section 31.3.3 for more details). The following Figure 31-2 shows different fields of an error frame:

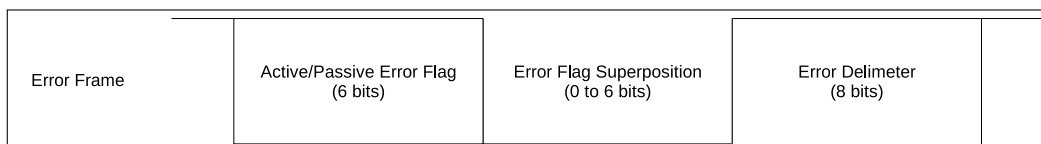

Figure 31-2. Fields of an Error Frame

Table 31-2. Error Frame

Error Frame	Description
Error Flag	The Error Flag has two forms, the Active Error Flag consisting of 6 dominant bits and the Passive Error Flag consisting of 6 recessive bits (unless overridden by dominant bits of other nodes). Active Error Flags are sent by error active nodes, whilst Passive Error Flags are sent by error passive nodes.
Error Flag Superposition	The Error Flag Superposition field meant to allow for other nodes on the bus to transmit their respective Active Error Flags. The superposition field can range from 0 to 6 bits, and ends when the first recessive bit is detected (i.e., the first bit of the Delimiter).
Error Delimiter	The Delimiter field marks the end of the error/overload frame, and consists of 8 recessive bits.

Overload Frames

An overload frame has the same bit fields as an error frame containing an Active Error Flag. The key difference is in the conditions that can trigger the transmission of an overload frame. Figure 31-3 below shows the bit fields of an overload frame.

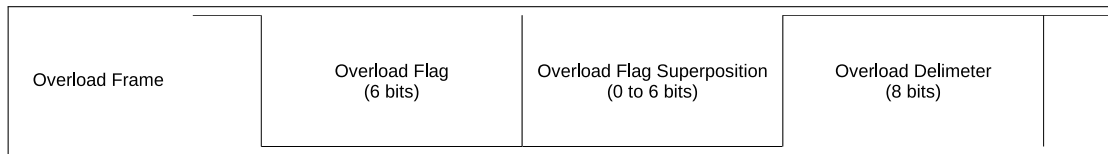

Figure 31-3. Fields of an Overload Frame

Table 31-3. Overload Frame

Overload Flag	Description
Overload Flag	Consists of 6 dominant bits. Same as an Active Error Flag.
Overload Flag Superposition	Allows for the superposition of Overload Flags from other nodes, similar to an Error Flag Superposition.
Overload Delimiter	Consists of 8 recessive bits. Same as an Error Delimiter.

Overload frames will be transmitted under the following conditions:

1. A receiver requires a delay of the next data or remote frame.
2. A dominant bit is detected at the first and second bit of intermission.
3. A dominant bit is detected at the eighth (last) bit of an Error Delimiter. Note that in this case, TEC and REC will not be incremented (see Section 31.3.3 for more details).

Transmitting an overload frame due to one of the conditions must also satisfy the following rules:

- Transmitting an overload frame due to condition 1 must only be started at the first bit of intermission.
- Transmitting an overload frame due to condition 2 and 3 must start one bit after the detecting the dominant bit of the condition.
- A maximum of two overload frames may be generated in order to delay the next data or remote frame.

31.3.2.3 Interframe Space

The Interframe Space acts as a separator between frames. Data frames and remote frames must be separated from preceding frames by an Interframe Space, regardless of the preceding frame's type (data frame, remote frame, error frame, overload frame). However, error frames and overload frames do not need to be separated from preceding frames.

Figure 31-4 shows the fields within an Interframe Space:

Table 31-4. Interframe Space

Interframe Space	Description
Intermission	The Intermission consists of 3 recessive bits.

Cont'd on next page

Table 31-4 – cont'd from previous page

Interframe Space	Description
Suspend Transmission	An Error Passive node that has just transmitted a message must include a Suspend Transmission field. This field consists of 8 recessive bits. Error Active nodes should not include this field.
Bus Idle	The Bus Idle field is of arbitrary length. Bus Idle ends when an SOF is transmitted. If a node has a pending transmission, the SOF should be transmitted at the first bit following Intermission.

31.3.3 TWAI Errors

31.3.3.1 Error Types

Bus Errors in TWAI are categorized into one of the following types:

Bit Error

A Bit Error occurs when a node transmits a bit value (i.e., dominant or recessive) but the opposite bit is detected (e.g., a dominant bit is transmitted but a recessive is detected). However, if the transmitted bit is recessive and is located in the Arbitration Field or ACK Slot or Passive Error Flag, then detecting a dominant bit will not be considered a Bit Error.

Stuff Error

A stuff error is detected when 6 consecutive bits of the same value are detected (thus violating the bit-stuffing encoding rules).

CRC Error

A receiver of a data or remote frame will calculate a CRC based on the bits it has received. A CRC error occurs when the CRC calculated by the receiver does not match the CRC sequence in the received data or remote Frame.

Format Error

A Format Error is detected when a fixed-form bit field of a message contains an illegal bit. For example, the r1 and r0 fields must be dominant.

ACK Error

An ACK Error occurs when a transmitter does not detect a dominant bit at the ACK Slot.

31.3.3.2 Error States

TWAI nodes implement fault confinement by each maintaining two error counters, where the counter values determine the error state. The two error counters are known as the Transmit Error Counter (TEC) and Receive Error Counter (REC). TWAI has the following error states.

Error Active

An Error Active node is able to participate in bus communication and transmit an Active Error Flag when it detects an error.

Error Passive

An Error Passive node is able to participate in bus communication, but can only transmit an Passive Error Flag when it detects an error. Error Passive nodes that have transmitted a data or remote frame must also include the Suspend Transmission field in the subsequent Interframe Space.

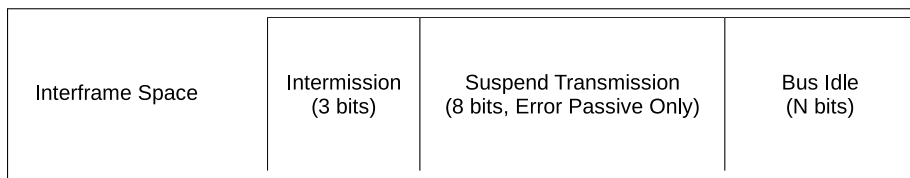

Figure 31-4. The Fields within an Interframe Space

Bus Off

A Bus Off node is not permitted to influence the bus in any way (i.e., is not allowed to transmit anything).

31.3.3.3 Error Counters

The TEC and REC are incremented/decremented according to the following rules. **Note that more than one rule can apply for a given message transfer.**

1. When a receiver detects an error, the REC is increased by 1, except when the detected error was a Bit Error during the transmission of an Active Error Flag or an Overload Flag.
2. When a receiver detects a dominant bit as the first bit after sending an Error Flag, the REC is increased by 8.
3. When a transmitter sends an Error Flag, the TEC is increased by 8. However, the following scenarios are exempt from this rule:
 - If a transmitter is Error Passive that detects an Acknowledgment Error due to not detecting a dominant bit in the ACK Slot, it should send a Passive Error Flag. If no dominant bit is detected in that Passive Error Flag, the TEC should not be increased.
 - A transmitter transmits an Error Flag due to a Stuff Error during Arbitration. If the offending bit should have been recessive but was monitored as dominant, then the TEC should not be increased.
4. If a transmitter detects a Bit Error whilst sending an Active Error Flag or Overload Flag, the TEC is increased by 8.
5. If a receiver detects a Bit Error while sending an Active Error Flag or Overload Flag, the REC is increased by 8.
6. A node can tolerate up to 7 consecutive dominant bits after sending an Active/Passive Error Flag, or Overload Flag. After detecting the 14th consecutive dominant bit (when sending an Active Error Flag or Overload Flag), or the 8th consecutive dominant bit following a Passive Error Flag, a transmitter will increase its TEC by 8 and a receiver will increase its REC by 8. Every additional eight consecutive dominant bits will also increase the TEC (for transmitters) or REC (for receivers) by 8 as well.
7. When a transmitter successfully transmits a message (getting ACK and no errors until the EOF is complete), the TEC is decremented by 1, unless the TEC is already at 0.
8. When a receiver successfully receives a message (no errors before ACK Slot, and successful sending of ACK), the REC is decremented.
 - If the REC was between 1 and 127, the REC is decremented by 1.
 - If the REC was greater than 127, the REC is set to 127.
 - If the REC was 0, the REC remains 0.

9. A node becomes Error Passive when its TEC and/or REC is greater than or equal to 128. The error condition that causes a node to become Error Passive will cause the node to send an Active Error Flag. Note that once the REC has reached to 128, any further increases to its value are invalid until the REC returns to a value less than 128.
10. A node becomes Bus Off when its TEC is greater than or equal to 256.
11. An Error Passive node becomes Error Active when both the TEC and REC are less than or equal to 127.
12. A Bus Off node can become Error Active (with both its TEC and REC reset to 0) after it monitors 128 occurrences of 11 consecutive recessive bits on the bus.

31.3.4 TWAI Bit Timing

31.3.4.1 Nominal Bit

The TWAI protocol allows a TWAI bus to operate at a particular bit rate. However, all nodes within a TWAI bus must operate at the same bit rate.

- **The Nominal Bit Rate** is defined as the number of bits transmitted per second from an ideal transmitter and without any synchronization.
- **The Nominal Bit Time** is defined as $1/\text{Nominal Bit Rate}$.

A single Nominal Bit Time is divided into multiple segments, and each segment is made up of multiple Time Quanta. A **Time Quantum** is a fixed unit of time, and is implemented as some form of prescaled clock signal in each node. Figure 31-5 illustrates the segments within a single Nominal Bit Time.

TWAI controllers will operate in time steps of one Time Quanta where the state of the TWAI bus is analyzed. If two consecutive Time Quantas have different bus states (i.e., recessive to dominant or vice versa), this will be considered an edge. When the bus is analyzed at the intersection of PBS1 and PBS2, this is considered the Sample Point and the sampled bus value is considered the value of that bit.

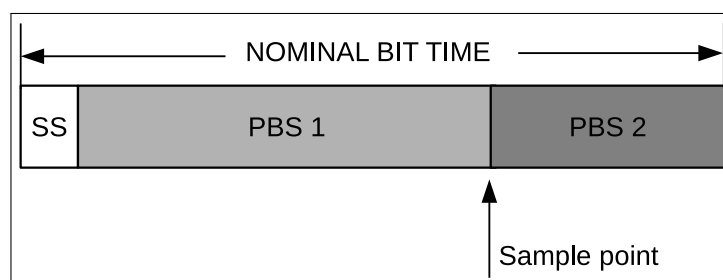

Figure 31-5. Layout of a Bit

Table 31-5. Segments of a Nominal Bit Time

Segment	Description
SS	The SS (Synchronization Segment) is 1 Time Quantum long. If all nodes are perfectly synchronized, the edge of a bit will lie in the SS.
PBS1	PBS1 (Phase Buffer Segment 1) can be 1 to 16 Time Quanta long. PBS1 is meant to compensate for the physical delay times within the network. PBS1 can also be lengthened for synchronization purposes.

Cont'd on next page

Table 31-5 – cont'd from previous page

Segment	Description
PBS2	PBS2 (Phase Buffer Segment 2) can be 1 to 8 Time Quanta long. PBS2 is meant to compensate for the information processing time of nodes. PBS2 can also be shortened for synchronization purposes.

31.3.4.2 Hard Synchronization and Resynchronization

Due to clock skew and jitter, the bit timing of nodes on the same bus may become out of phase. Therefore, a bit edge may come before or after the SS. To ensure that the internal bit timing clocks of each node are kept in phase, TWAI has various methods of synchronization. The **Phase Error “e”** is measured in the number of Time Quanta and relative to the SS.

- A positive Phase Error ($e > 0$) is when the edge lies after the SS and before the Sample Point (i.e., the edge is late).
- A negative Phase Error ($e < 0$) is when the edge lies after the Sample Point of the previous bit and before SS (i.e., the edge is early).

To correct for Phase Errors, there are two forms of synchronization, known as **Hard Synchronization** and **Resynchronization**. **Hard Synchronization** and **Resynchronization** obey the following rules:

- Only one synchronization may occur in a single bit time.
- Synchronizations only occurs on recessive to dominant edges.

Hard Synchronization

Hard Synchronization occurs on the recessive to dominant edges when the bus is idle (i.e., the first SOF bit after Bus Idle). All nodes will restart their internal bit timings so that the recessive to dominant edge lies within the SS of the restarted bit timing.

Resynchronization

Resynchronization occurs on recessive to dominant edges not during Bus Idle. If the edge has a positive Phase Error ($e > 0$), PBS1 is lengthened by a certain number of Time Quanta. If the edge has a negative Phase Error ($e < 0$), PBS2 will be shortened by a certain number of Time Quanta.

The number of Time Quanta to lengthen or shorten depends on the magnitude of the Phase Error, and is also limited by the Synchronization Jump Width (SJW) value which is programmable.

- When the magnitude of the Phase Error (**e**) is less than or equal to the SJW, PBS1/PBS2 are lengthened/shortened by the **e** number of Time Quanta. This has a same effect as Hard Synchronization.
- When the magnitude of the Phase Error is greater to the SJW, PBS1/PBS2 are lengthened/shortened by the SJW number of Time Quanta. This means it may take multiple bits of synchronization before the Phase Error is entirely corrected.

31.4 Architectural Overview

The major functional blocks of the TWAI controller are shown in Figure 31-6.

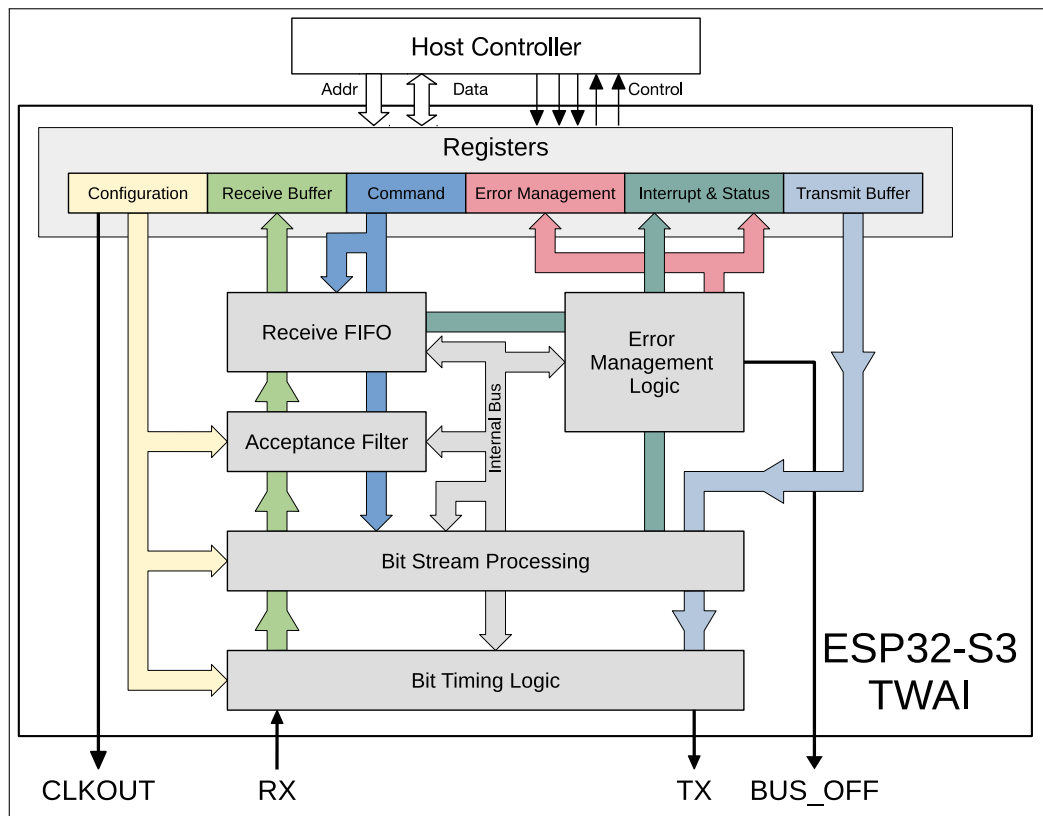

Figure 31-6. TWAI Overview Diagram

31.4.1 Registers Block

The ESP32-S3 CPU accesses peripherals using 32-bit aligned words. However, the majority of registers in the TWAI controller only contain useful data at the least significant byte (bits [7:0]). Therefore, in these registers, bits [31:8] are ignored on writes, and return 0 on reads.

Configuration Registers

The configuration registers store various configuration items for the TWAI controller such as bit rates, operation mode, Acceptance Filter etc. Configuration registers can only be modified whilst the TWAI controller is in Reset Mode (See Section 31.5.1).

Command Registers

The command register is used by the CPU to drive the TWAI controller to initiate certain actions such as transmitting a message or clearing the Receive Buffer. The command register can only be modified when the TWAI controller is in Operation Mode (see section 31.5.1).

Interrupt & Status Registers

The interrupt register indicates what events have occurred in the TWAI controller (each event is represented by a separate bit). The status register indicates the current status of the TWAI controller.

Error Management Registers

The error management registers include error counters and capture registers. The error counter registers represent TEC and REC values. The capture registers will record information about instances where TWAI controller detects a bus error, or when it loses arbitration.

Transmit Buffer Registers

The transmit buffer is a 13-byte buffer used to store a TWAI message to be transmitted.

Receive Buffer Registers

The Receive Buffer is a 13-byte buffer which stores a single message. The Receive Buffer acts as a window of Receive FIFO, whose first message will be mapped into the Receive Buffer.

Note that the Transmit Buffer registers, Receive Buffer registers, and the Acceptance Filter registers share the same address range (offset 0x0040 to 0x0070). Their access is governed by the following rules:

- When the TWAI controller is in Reset Mode, all reads and writes to the address range maps to the Acceptance Filter registers.
- When the TWAI controller is in Operation Mode:
 - All reads to the address range maps to the Receive Buffer registers.
 - All writes to the address range maps to the Transmit Buffer registers.

31.4.2 Bit Stream Processor

The Bit Stream Processing (BSP) module frames data from the Transmit Buffer (e.g. bit stuffing and additional CRC fields) and generating a bit stream for the Bit Timing Logic (BTL) module. At the same time, the BSP module is also responsible for processing the received bit stream (e.g., de-stuffing and verifying CRC) from the BTL module and placing the message into the Receive FIFO. The BSP will also detect errors on the TWAI bus and report them to the Error Management Logic (EML).

31.4.3 Error Management Logic

The Error Management Logic (EML) module updates the TEC and REC, recording error information like error types and positions, and updating the error state of the TWAI controller such that the BSP module generates the correct Error Flags. Furthermore, this module also records the bit position when the TWAI controller loses arbitration.

31.4.4 Bit Timing Logic

The Bit Timing Logic (BTL) module transmits and receives messages at the configured bit rate. The BTL module also handles synchronization of out of phase bits so that communication remains stable. A single bit time consists of multiple programmable segments that allows users to set the length of each segment to account for factors such as propagation delay and controller processing time etc.

31.4.5 Acceptance Filter

The Acceptance Filter is a programmable message filtering unit that allows the TWAI controller to accept or reject a received message based on the message's ID field. Only accepted messages will be stored in the Receive FIFO. The Acceptance Filter's registers can be programmed to specify a single filter, or two separate filters (dual filter mode).

31.4.6 Receive FIFO

The Receive FIFO is a 64-byte buffer (inside the TWAI controller) that stores received messages accepted by the Acceptance Filter. Messages in the Receive FIFO can vary in size (between 3 to 13-bytes). When the Receive FIFO is full (or does not have enough space to store the next received message in its entirety), the Overrun Interrupt will be triggered, and any subsequent received messages will be lost until adequate space is cleared in the Receive FIFO. The first message in the Receive FIFO will be mapped to the 13-byte Receive Buffer until that

message is cleared (using the Release Receive Buffer command bit). After clearing, the Receive Buffer will map to the next message in the Receive FIFO, and the space occupied by the previous message in the Receive FIFO can be used to receive new messages.

31.5 Functional Description

31.5.1 Modes

The ESP32-S3 TWAI controller has two working modes: Reset Mode and Operation Mode. Reset Mode and Operation Mode are entered by setting or clearing the [TWAI_RESET_MODE](#) bit.

31.5.1.1 Reset Mode

Entering Reset Mode is required in order to modify the various configuration registers of the TWAI controller. When entering Reset Mode, the TWAI controller is essentially disconnected from the TWAI bus. When in Reset Mode, the TWAI controller will not be able to transmit any messages (including error signals). Any transmission in progress is immediately terminated. Likewise, the TWAI controller will not be able to receive any messages either.

31.5.1.2 Operation Mode

In operation mode, the TWAI controller connects to the bus and write-protect all configuration registers to ensure consistency during operation. When in Operation Mode, the TWAI controller can transmit and receive messages (including error signaling) depending on which operation sub-mode the TWAI controller was configured with. The TWAI controller supports the following operation sub-modes:

- **Normal Mode:** The TWAI controller can transmit and receive messages including error signaling (such as error and overload Frames).
- **Self-test Mode:** Self-test mode is similar to normal Mode, but the TWAI controller will consider the transmission of a data or RTR frame successful and do not generate ACK error even if it was not acknowledged. This is commonly used when self-testing the TWAI controller.
- **Listen-only Mode:** The TWAI controller will be able to receive messages, but will remain completely passive on the TWAI bus. Thus, the TWAI controller will not be able to transmit any messages, acknowledgments, or error signals. The error counters will remain frozen. This mode is useful for TWAI bus monitoring.

Note that when exiting Reset Mode (i.e., entering Operation Mode), the TWAI controller must wait for 11 consecutive recessive bits to occur before being able to fully connect the TWAI bus (i.e., be able to transmit or receive).

31.5.2 Bit Timing

The operating bit rate of the TWAI controller must be configured whilst the TWAI controller is in Reset Mode. The bit rate is configured using [TWAI_BUS_TIMING_0_REG](#) and [TWAI_BUS_TIMING_1_REG](#), and the two registers contain the following fields:

The following Table 31-6 illustrates the bit fields of [TWAI_BUS_TIMING_0_REG](#).

Table 31-6. Bit Information of `TWAI_BUS_TIMING_0_REG` (0x18)

Bit 31-16	Bit 15	Bit 14	Bit 13	Bit 12	Bit 1	Bit 0
Reserved	SJW.1	SJW.0	Reserved	BRP.12	BRP.1	BRP.0

Notes:

- BRP: The TWAI Time Quanta clock is derived from the APB clock that is usually 80 MHz. The Baud Rate Prescaler (BRP) field is used to define the prescaler according to the equation below, where t_{Tq} is the Time Quanta clock cycle and t_{CLK} is APB clock cycle:

$$t_{Tq} = 2 \times t_{CLK} \times (2^{12} \times \text{BRP.12} + 2^{11} \times \text{BRP.11} + \dots + 2^1 \times \text{BRP.1} + 2^0 \times \text{BRP.0} + 1)$$
- SJW: Synchronization Jump Width (SJW) is configured in SJW.0 and SJW.1 where $\text{SJW} = (2 \times \text{SJW.1} + \text{SJW.0} + 1)$

The following Table 31-7 illustrates the bit fields of `TWAI_BUS_TIMING_1_REG`.

Table 31-7. Bit Information of `TWAI_BUS_TIMING_1_REG` (0x1c)

Bit 31-8	Bit 7	Bit 6	Bit 5	Bit 4	Bit 3	Bit 2	Bit 1	Bit 0
Reserved	SAM	PBS2.2	PBS2.1	PBS2.0	PBS1.3	PBS1.2	PBS1.1	PBS1.0

Notes:

- PBS1: The number of Time Quanta in Phase Buffer Segment 1 is defined according to the following equation: $(8 \times \text{PBS1.3} + 4 \times \text{PBS1.2} + 2 \times \text{PBS1.1} + \text{PBS1.0} + 1)$
- PBS2: The number of Time Quanta in Phase Buffer Segment 2 is defined according to the following equation: $(4 \times \text{PBS2.2} + 2 \times \text{PBS2.1} + \text{PBS2.0} + 1)$
- SAM: Enables triple sampling if set to 1. This is useful for low/medium speed buses to filter spikes on the bus line.

31.5.3 Interrupt Management

The ESP32-S3 TWAI controller provides eight interrupts, each represented by a single bit in the `TWAI_INT_RAW_REG`. For a particular interrupt to be triggered, the corresponding enable bit in `TWAI_INT_ENA_REG` must be set.

The TWAI controller provides the following interrupts:

- Receive Interrupt
- Transmit Interrupt
- Error Warning Interrupt
- Data Overrun Interrupt
- Error Passive Interrupt
- Arbitration Lost Interrupt
- Bus Error Interrupt
- Bus Status Interrupt

The TWAI controller's interrupt signal to the interrupt matrix will be asserted whenever one or more interrupt bits are set in the `TWAI_INT_RAW_REG`, and deasserted when all bits in `TWAI_INT_RAW_REG` are cleared. The

majority of interrupt bits in [TWAI_INT_RAW_REG](#) are automatically cleared when the register is read, except for the Receive Interrupt which can only be cleared when all the messages are released by setting the [TWAI_RELEASE_BUF](#) bit.

31.5.3.1 Receive Interrupt (RXI)

The Receive Interrupt (RXI) is asserted whenever the TWAI controller has received messages that are pending to be read from the Receive Buffer (i.e., when [TWAI_RX_MESSAGE_CNT_REG](#) > 0). Pending received messages includes valid messages in the Receive FIFO and also overrun messages. The RXI will not be deasserted until all pending received messages are cleared using the [TWAI_RELEASE_BUF](#) command bit.

31.5.3.2 Transmit Interrupt (TXI)

The Transmit Interrupt (TXI) is triggered whenever Transmit Buffer becomes free, indicating another message can be loaded into the Transmit Buffer to be transmitted. The Transmit Buffer becomes free under the following scenarios:

- A message transmission has completed successfully, i.e., acknowledged without any errors. (Any failed messages will automatically be resent.)
- A single shot transmission has completed (successfully or unsuccessfully, indicated by the [TWAI_TX_COMPLETE](#) bit).
- A message transmission was aborted using the [TWAI_ABORT_TX](#) command bit.

31.5.3.3 Error Warning Interrupt (EWI)

The Error Warning Interrupt (EWI) is triggered whenever there is a change to the [TWAI_ERR_ST](#) and [TWAI_BUS_OFF_ST](#) bits of the [TWAI_STATUS_REG](#) (i.e., transition from 0 to 1 or vice versa). Thus, an EWI could indicate one of the following events, depending on the values [TWAI_ERR_ST](#) and [TWAI_BUS_OFF_ST](#) at the moment when the EWI is triggered.

- If [TWAI_ERR_ST](#) = 0 and [TWAI_BUS_OFF_ST](#) = 0:
 - If the TWAI controller was in the Error Active state, it indicates both the TEC and REC have returned below the threshold value set by [TWAI_ERR_WARNING_LIMIT_REG](#).
 - If the TWAI controller was previously in the Bus Off Recovery state, it indicates that Bus Recovery has completed successfully.
- If [TWAI_ERR_ST](#) = 1 and [TWAI_BUS_OFF_ST](#) = 0: The TEC or REC error counters have exceeded the threshold value set by [TWAI_ERR_WARNING_LIMIT_REG](#).
- If [TWAI_ERR_ST](#) = 1 and [TWAI_BUS_OFF_ST](#) = 1: The TWAI controller has entered the BUS_OFF state (due to the TEC >= 256).
- If [TWAI_ERR_ST](#) = 0 and [TWAI_BUS_OFF_ST](#) = 1: The TWAI controller's TEC has dropped below the threshold value set by [TWAI_ERR_WARNING_LIMIT_REG](#) during BUS_OFF recovery.

31.5.3.4 Data Overrun Interrupt (DOI)

The Data Overrun Interrupt (DOI) is triggered whenever the Receive FIFO has overrun. The DOI indicates that the Receive FIFO is full and should be cleared immediately to prevent any further overrun messages.

The DOI is only triggered by the first message that causes the Receive FIFO to overrun (i.e., the transition from the Receive FIFO not being full to the Receive FIFO overflowing). Any subsequent overrun messages will not trigger the DOI again. The DOI could be triggered again when all received messages (valid or overrun) have been cleared.

31.5.3.5 Error Passive Interrupt (TXI)

The Error Passive Interrupt (EPI) is triggered whenever the TWAI controller switches from Error Active to Error Passive, or vice versa.

31.5.3.6 Arbitration Lost Interrupt (ALI)

The Arbitration Lost Interrupt (ALI) is triggered whenever the TWAI controller is attempting to transmit a message and loses arbitration. The bit position where the TWAI controller lost arbitration is automatically recorded in Arbitration Lost Capture register (TWAI_ARB_LOST_CAP_REG). When the ALI occurs again, the Arbitration Lost Capture register will no longer record new bit location until it is cleared (via reading this register through the CPU).

31.5.3.7 Bus Error Interrupt (BEI)

The Bus Error Interrupt (BEI) is triggered whenever TWAI controller detects an error on the TWAI bus. When a bus error occurs, the Bus Error type and its bit position are automatically recorded in the Error Code Capture register (TWAI_ERR_CODE_CAP_REG). When the BEI occurs again, the Error Code Capture register will no longer record new error information until it is cleared (via a read from the CPU).

31.5.3.8 Bus Status Interrupt (BSI)

The Bus Status Interrupt (BSI) is triggered whenever TWAI controller is switching between receive/transmit status and idle status. When a BSI occurs, the current status of TWAI controller can be measured by reading TWAI_RX_ST and TWAI_TX_ST in TWAI_STATUS_REG register.

31.5.4 Transmit and Receive Buffers

31.5.4.1 Overview of Buffers

Table 31-8. Buffer Layout for Standard Frame Format and Extended Frame Format

Standard Frame Format (SFF)		Extended Frame Format (EFF)	
TWAI Address	Content	TWAI Address	Content
0x40	TX/RX frame information	0x40	TX/RX frame information
0x44	TX/RX identifier 1	0x44	TX/RX identifier 1
0x48	TX/RX identifier 2	0x48	TX/RX identifier 2
0x4c	TX/RX data byte 1	0x4c	TX/RX identifier 3
0x50	TX/RX data byte 2	0x50	TX/RX identifier 4
0x54	TX/RX data byte 3	0x54	TX/RX data byte 1
0x58	TX/RX data byte 4	0x58	TX/RX data byte 2
0x5c	TX/RX data byte 5	0x5c	TX/RX data byte 3

Cont'd on next page

Table 31-8 – cont'd from previous page

Standard Frame Format (SFF)		Extended Frame Format (EFF)	
TWAI Address	Content	TWAI Address	Content
0x60	TX/RX data byte 6	0x60	TX/RX data byte 4
0x64	TX/RX data byte 7	0x64	TX/RX data byte 5
0x68	TX/RX data byte 8	0x68	TX/RX data byte 6
0x6c	reserved	0x6c	TX/RX data byte 7
0x70	reserved	0x70	TX/RX data byte 8

Table 31-8 illustrates the layout of the Transmit Buffer and Receive Buffer registers. Both the Transmit and Receive Buffer registers share the same address space and are only accessible when the TWAI controller is in Operation Mode. CPU write operations access the Transmit Buffer registers, and CPU read operations access the Receive Buffer registers. However, both buffers share the exact same register layout and fields to represent a message (received or to be transmitted). The Transmit Buffer registers are used to configure a TWAI message to be transmitted. The CPU would write to the Transmit Buffer registers specifying the message's frame type, frame format, frame ID, and frame data (payload). Once the Transmit Buffer is configured, the CPU would then initiate the transmission by setting the [TWAI_TX_REQ](#) bit in [TWAI_CMD_REG](#).

- For a self-reception request, set the [TWAI_SELF_RX_REQ](#) bit instead.
- For a single-shot transmission, set both the [TWAI_TX_REQ](#) and the [TWAI_ABORT_TX](#) simultaneously.

The Receive Buffer registers map the first message in the Receive FIFO. The CPU would read the Receive Buffer registers to obtain the first message's frame type, frame format, frame ID, and frame data (payload). Once the message has been read from the Receive Buffer registers, the CPU can set the [TWAI_RELEASE_BUF](#) bit in [TWAI_CMD_REG](#) to clear the Receive Buffer registers. If there are still messages in the Receive FIFO, the Receive Buffer registers will map the first message again.

31.5.4.2 Frame Information

The frame information is one byte long and specifies a message's frame type, frame format, and length of data. The frame information fields are shown in Table 31-9.

Table 31-9. TX/RX Frame Information (SFF/EFF) TWAI Address 0x40

Bit 31-8	Bit 7	Bit 6	Bit 5	Bit 4	Bit 3	Bit 2	Bit 1	Bit 0
Reserved	FF ¹	RTR ²	X ³	X ³	DLC.3 ⁴	DLC.2 ⁴	DLC.1 ⁴	DLC.0 ⁴

Notes:

1. FF: The Frame Format (FF) bit specifies whether the message is Extended Frame Format (EFF) or Standard Frame Format (SFF). The message is EFF when FF bit is 1, and SFF when FF bit is 0.
2. RTR: The Remote Transmission Request (RTR) bit specifies whether the message is a data frame or a remote frame. The message is a remote frame when the RTR bit is 1, and a data frame when the RTR bit is 0.
3. X: Don't care, can be any value.
4. DLC: The Data Length Code (DLC) field specifies the number of data bytes for a data frame, or the number of data bytes to request in a remote frame. TWAI data frames are limited to a maximum payload of 8 data bytes.

bytes, and thus the DLC should range anywhere from 0 to 8.

31.5.4.3 Frame Identifier

The Frame Identifier fields is two-byte (11-bit) long if the message is SFF, and four-byte (29-bit) long if the message is EFF.

The Frame Identifier fields for an SFF (11-bit) message is shown in Table 31-10-31-11.

Table 31-10. TX/RX Identifier 1 (SFF); TWAI Address 0x44

Bit 31-8	Bit 7	Bit 6	Bit 5	Bit 4	Bit 3	Bit 2	Bit 1	Bit 0
Reserved	ID.10	ID.9	ID.8	ID.7	ID.6	ID.5	ID.4	ID.3

Table 31-11. TX/RX Identifier 2 (SFF); TWAI Address 0x48

Bit 31-8	Bit 7	Bit 6	Bit 5	Bit 4	Bit 3	Bit 2	Bit 1	Bit 0
Reserved	ID.2	ID.1	ID.0	X ¹	X ²	X ²	X ²	X ²

Notes:

1. Don't care. Recommended to be compatible with receive buffer (i.e., set to RTR) in case of using the self reception functionality (or together with self-test functionality).
2. Don't care. Recommended to be compatible with receive buffer (i.e., set to 0) in case of using the self reception functionality (or together with self-test functionality).

The Frame Identifier fields for an EFF (29-bits) message is shown in Table 31-12-31-15.

Table 31-12. TX/RX Identifier 1 (EFF); TWAI Address 0x44

Bit 31-8	Bit 7	Bit 6	Bit 5	Bit 4	Bit 3	Bit 2	Bit 1	Bit 0
Reserved	ID.28	ID.27	ID.26	ID.25	ID.24	ID.23	ID.22	ID.21

Table 31-13. TX/RX Identifier 2 (EFF); TWAI Address 0x48

Bit 31-8	Bit 7	Bit 6	Bit 5	Bit 4	Bit 3	Bit 2	Bit 1	Bit 0
Reserved	ID.20	ID.19	ID.18	ID.17	ID.16	ID.15	ID.14	ID.13

Table 31-14. TX/RX Identifier 3 (EFF); TWAI Address 0x4c

Bit 31-8	Bit 7	Bit 6	Bit 5	Bit 4	Bit 3	Bit 2	Bit 1	Bit 0
Reserved	ID.12	ID.11	ID.10	ID.9	ID.8	ID.7	ID.6	ID.5

Table 31-15. TX/RX Identifier 4 (EFF); TWAI Address 0x50

Bit 31-8	Bit 7	Bit 6	Bit 5	Bit 4	Bit 3	Bit 2	Bit 1	Bit 0
Reserved	ID.4	ID.3	ID.2	ID.1	ID.0	X ¹	X ²	X ²

Notes:

1. Don't care. Recommended to be compatible with receive buffer (i.e., set to RTR) in case of using the self reception functionality (or together with self-test functionality).
2. Don't care. Recommended to be compatible with receive buffer (i.e., set to 0) in case of using the self reception functionality (or together with self-test functionality).

31.5.4.4 Frame Data

The Frame Data field contains the payloads of transmitted or received data frame, and can range from 0 to eight bytes. The number of valid bytes should be equal to the DLC. However, if the DLC is larger than eight, the number of valid bytes would still be limited to eight. Remote frames do not have data payloads, thus their Frame Data fields will be unused.

For example, when transmitting a data frame with five bytes, the CPU should write five to the DLC field, and then write data to the corresponding register of the first to the fifth data field. Likewise, when receiving a data frame with a DLC of five data bytes, only the first to the fifth data byte will contain valid payload data for the CPU to read.

31.5.5 Receive FIFO and Data Overruns

The Receive FIFO is a 64-byte internal buffer used to store received messages in First In First Out order. A single received message can occupy between three to 13 bytes of space in the Receive FIFO, and their endianness is identical to the register layout of the Receive Buffer registers. The Receive Buffer registers are mapped to the bytes of the first message in the Receive FIFO.

When the TWAI controller receives a message, it will increment the value of [TWAI_RX_MESSAGE_COUNTER](#) up to a maximum of 64. If there is adequate space in the Receive FIFO, the message contents will be written into the Receive FIFO. Once a message has been read from the Receive Buffer, the [TWAI_RELEASE_BUF](#) bit should be set. This will decrement [TWAI_RX_MESSAGE_COUNTER](#) and free the space occupied by the first message in the Receive FIFO. The Receive Buffer will then map to the next message in the Receive FIFO.

A data overrun occurs when the TWAI controller receives a message, but the Receive FIFO lacks the adequate free space to store the received message in its entirety (either due to the message contents being larger than the free space in the Receive FIFO, or the Receive FIFO being completely full).

When a data overrun occurs:

- The free space left in the Receive FIFO is filled with the partial contents of the overrun message. If the Receive FIFO is already full, then none of the overrun message's contents will be stored.
- When data in the Receive FIFO overruns for the first time, a Data Overrun Interrupt will be triggered.
- Each overrun message will still increment the [TWAI_RX_MESSAGE_COUNTER](#) up to a maximum of 64.
- The RX FIFO will internally mark overrun messages as invalid. The [TWAI_MISS_ST](#) bit can be used to determine whether the message currently mapped to by the Receive Buffer is valid or overrun.

To clear an overrun Receive FIFO, the [TWAI_RELEASE_BUF](#) must be called repeatedly until [TWAI_RX_MESSAGE_COUNTER](#) is 0. This has the effect of freeing all valid messages in the Receive FIFO and clearing all overrun messages.

The Acceptance Filter allows the TWAI controller to filter out received messages based on their ID (and optionally their first data byte and frame type). Only accepted messages are passed on to the Receive FIFO. The use of

Acceptance Filters allows a more lightweight operation of the TWAI controller (e.g., less use of Receive FIFO, fewer Receive Interrupts) since the TWAI Controller only need to handle a subset of messages.

The Acceptance Filter configuration registers can only be accessed whilst the TWAI controller is in Reset Mode, since they share the same address spaces as the Transmit Buffer and Receive Buffer registers.

The configuration registers consist of a 32-bit Acceptance Code Value and a 32-bit Acceptance Mask Value. The Acceptance Code value specifies a bit pattern which each filtered bit of the message must match in order for the message to be accepted. The Acceptance Mask Value is able to mask out certain bits of the Code value (i.e., set as “Don’t Care” bits). Each filtered bit of the message must either match the acceptance code or be masked in order for the message to be accepted, as demonstrated in Figure 31-7.

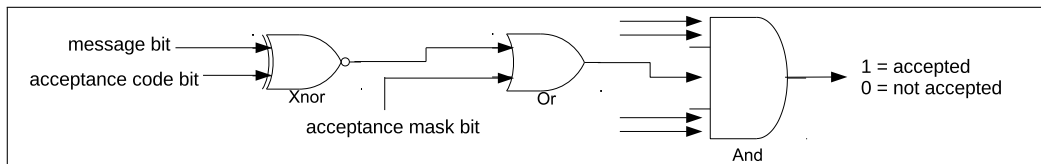

Figure 31-7. Acceptance Filter

The TWAI controller Acceptance Filter allows the 32-bit Acceptance Code and Mask Values to either define a single filter (i.e., Single Filter Mode), or two filters (i.e., Dual Filter Mode). How the Acceptance Filter interprets the 32-bit code and mask values is dependent on whether Single Filter Mode is enabled, and the received message format (i.e., SFF or EFF).

31.5.5.1 Single Filter Mode

Single Filter Mode is enabled by setting the `TWAI_RX_FILTER_MODE` bit to 1. This will cause the 32-bit code and mask values to define a single filter. The single filter can filter the following bits of a data or remote frame:

- SFF
 - The entire 11-bit ID
 - RTR bit
 - Data byte 1 and Data byte 2
- EFF
 - The entire 29-bit ID
 - RTR bit

The following Figure 31-8 illustrates how the 32-bit code and mask values will be interpreted under Single Filter Mode.

31.5.5.2 Dual Filter Mode

Dual Filter Mode is enabled by clearing the `TWAI_RX_FILTER_MODE` bit to 0. This will cause the 32-bit code and mask values to define a two separate filters referred to as filter 1 or filter 2. Under Dual Filter Mode, a message will be accepted if it is accepted by one of the two filters.

The two filters can filter the following bits of a data or remote frame:

- SFF

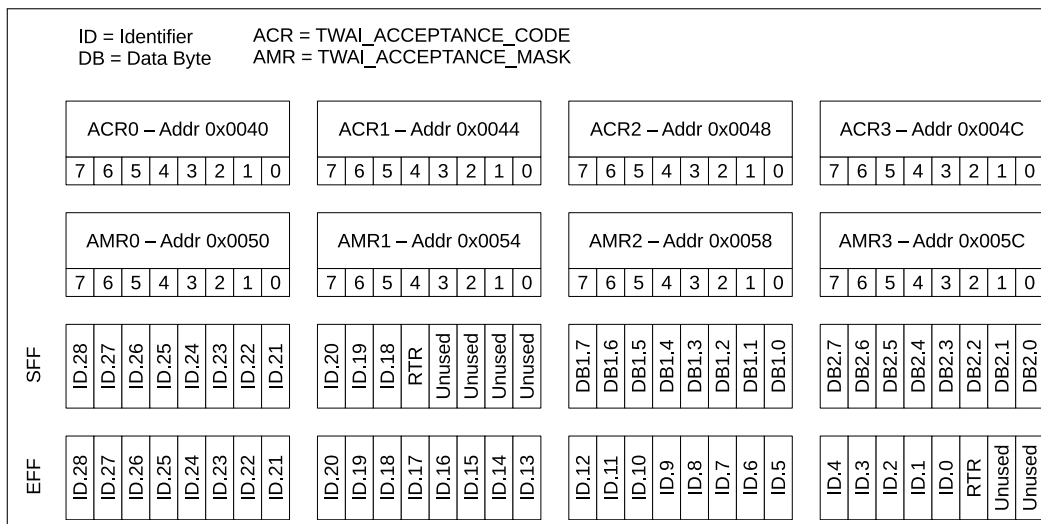

Figure 31-8. Single Filter Mode

- The entire 11-bit ID
- RTR bit
- Data byte 1 (for filter 1 only)
- EFF
 - The first 16 bits of the 29-bit ID

The following Figure 31-9 illustrates how the 32-bit code and mask values will be interpreted in Dual Filter Mode.

31.5.6 Error Management

The TWAI protocol requires that each TWAI node maintains the Transmit Error Count (TEC) and Receive Error Count (REC). The value of both error counts determines the current error state of the TWAI controller (i.e., Error Active, Error Passive, Bus-Off). The TWAI controller stores the TEC and REC values in the [TWAI_TX_ERR_CNT_REG](#) and [TWAI_RX_ERR_CNT_REG](#) respectively, and they can be read by the CPU anytime. In addition to the error states, the TWAI controller also offers an Error Warning Limit (EWL) feature that can warn the user of the occurrence of severe bus errors before the TWAI controller enters the Error Passive state.

The current error state of the TWAI controller is indicated via a combination of the following values and status bits: TEC, REC, [TWAI_ERR_ST](#), and [TWAI_BUS_OFF_ST](#). Certain changes to these values and bits will also trigger interrupts, thus allowing the users to be notified of error state transitions (see section 31.5.3). The following figure 31-10 shows the relation between the error states, values and bits, and error state related interrupts.

31.5.6.1 Error Warning Limit

The Error Warning Limit (EWL) feature is a configurable threshold value for the TEC and REC, which will trigger an interrupt when exceeded. The EWL is intended to serve as a warning about severe TWAI bus errors, and is triggered before the TWAI controller enters the Error Passive state. The EWL is configured in the [TWAI_ERR_WARNING_LIMIT_REG](#) and can only be configured whilst the TWAI controller is in Reset Mode. The [TWAI_ERR_WARNING_LIMIT_REG](#) has a default value of 96. When the values of TEC and/or REC are larger than

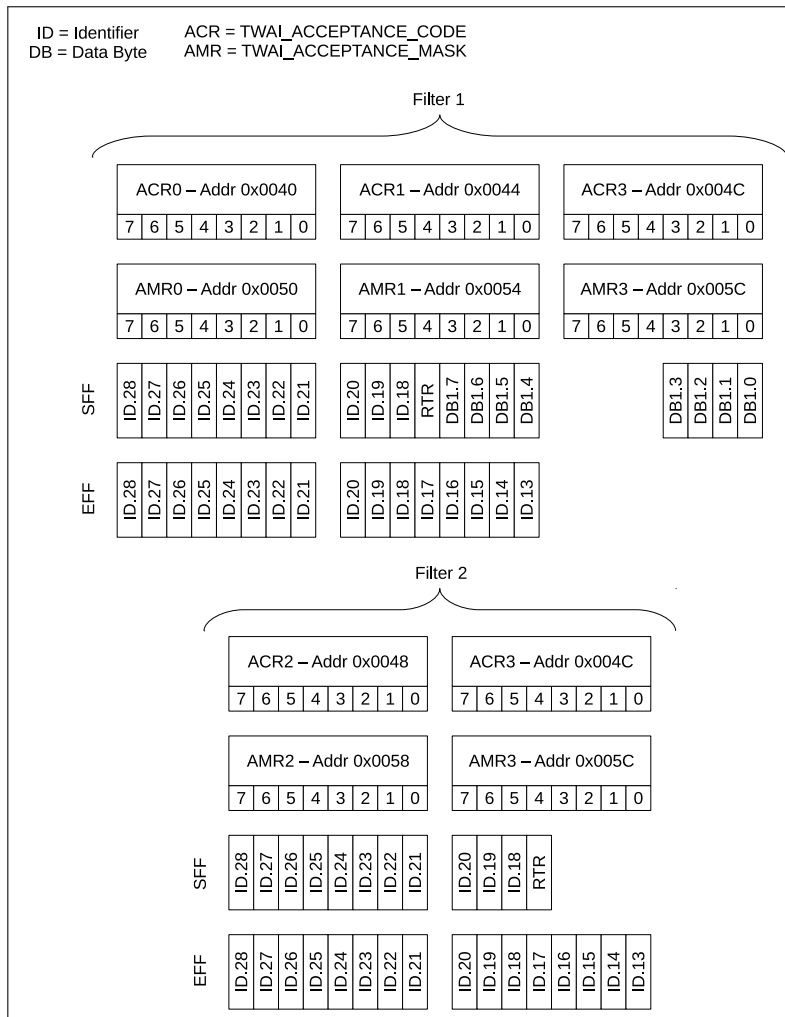

Figure 31-9. Dual Filter Mode

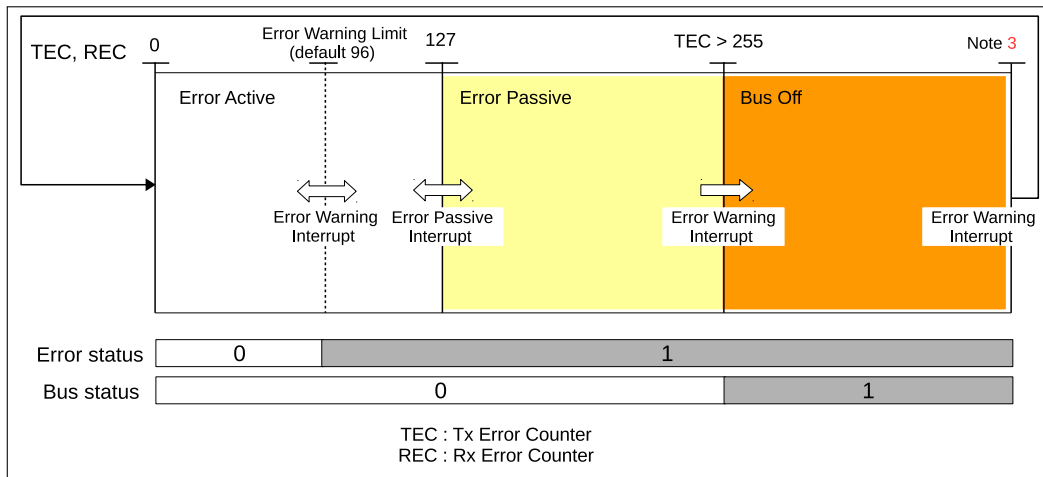

Figure 31-10. Error State Transition

or equal to the EWL value, the `TWAI_ERR_ST` bit is immediately set to 1. Likewise, when the values of both the TEC and REC are smaller than the EWL value, the `TWAI_ERR_ST` bit is immediately reset to 0. The Error Warning Interrupt is triggered whenever the value of the `TWAI_ERR_ST` bit (or the `TWAI_BUS_OFF_ST`) changes.

31.5.6.2 Error Passive

The TWAI controller is in the Error Passive state when the TEC or REC value exceeds 127. Likewise, when both the TEC and REC are less than or equal to 127, the TWAI controller enters the Error Active state. The Error Passive Interrupt is triggered whenever the TWAI controller transitions from the Error Active state to the Error Passive state or vice versa.

31.5.6.3 Bus-Off and Bus-Off Recovery

The TWAI controller enters the Bus-Off state when the TEC value exceeds 255. On entering the Bus-Off state, the TWAI controller will automatically do the following:

- Set REC to 0
- Set TEC to 127
- Set the `TWAI_BUS_OFF_ST` bit to 1
- Enter Reset Mode

The Error Warning Interrupt is triggered whenever the value of the `TWAI_BUS_OFF_ST` bit (or the `TWAI_ERR_ST` bit) changes.

To return to the Error Active state, the TWAI controller must undergo Bus-Off Recovery. Bus-Off Recovery requires the TWAI controller to observe 128 occurrences of 11 consecutive recessive bits on the bus. To initiate Bus-Off Recovery (after entering the Bus-Off state), the TWAI controller should enter Operation Mode by setting the `TWAI_RESET_MODE` bit to 0. The TEC tracks the progress of Bus-Off Recovery by decrementing the TEC each time when the TWAI controller observes 11 consecutive recessive bits. When Bus-Off Recovery has completed (i.e., TEC has decremented from 127 to 0), the `TWAI_BUS_OFF_ST` bit will automatically be reset to 0, thus triggering the Error Warning Interrupt.

31.5.7 Error Code Capture

The Error Code Capture (ECC) feature allows the TWAI controller to record the error type and bit position of a TWAI bus error in the form of an error code. Upon detecting a TWAI bus error, the Bus Error Interrupt is triggered and the error code is recorded in the `TWAI_ERR_CODE_CAP_REG`. Subsequent bus errors will trigger the Bus Error Interrupt, but their error codes will not be recorded until the current error code is read from the `TWAI_ERR_CODE_CAP_REG`.

The following Table 31-16 shows the fields of the `TWAI_ERR_CODE_CAP_REG`:

Table 31-16. Bit Information of `TWAI_ERR_CODE_CAP_REG` (0x30)

Bit 31-8	Bit 7	Bit 6	Bit 5	Bit 4	Bit 3	Bit 2	Bit 1	Bit 0
Reserved	ERRC.1 ¹	ERRC.0 ¹	DIR ²	SEG.4 ³	SEG.3 ³	SEG.2 ³	SEG.1 ³	SEG.0 ³

Notes:

- **ERRC:** The Error Code (ERRC) indicates the type of bus error: 00 for bit error, 01 for format error, 10 for stuff error, 11 for other types of error.
- **DIR:** The Direction (DIR) indicates whether the TWAI controller was transmitting or receiving when the bus error occurred: 0 for transmitter, 1 for receiver.
- **SEG:** The Error Segment (SEG) indicates which segment of the TWAI message (i.e., bit position) the bus

error occurred at.

The following Table 31-17 shows how to interpret the SEG.0 to SEG.4 bits.

Table 31-17. Bit Information of Bits SEG.4 - SEG.0

Bit SEG.4	Bit SEG.3	Bit SEG.2	Bit SEG.1	Bit SEG.0	Description
0	0	0	1	1	start of frame
0	0	0	1	0	ID.28 ~ ID.21
0	0	1	1	0	ID.20 ~ ID.18
0	0	1	0	0	bit SRTR
0	0	1	0	1	bit IDE
0	0	1	1	1	ID.17 ~ ID.13
0	1	1	1	1	ID.12 ~ ID.5
0	1	1	1	0	ID.4 ~ ID.0
0	1	1	0	0	bit RTR
0	1	1	0	1	reserved bit 1
0	1	0	0	1	reserved bit 0
0	1	0	1	1	data length code
0	1	0	1	0	data field
0	1	0	0	0	CRC sequence
1	1	0	0	0	CRC delimiter
1	1	0	0	1	ACK slot
1	1	0	1	1	ACK delimiter
1	1	0	1	0	end of frame
1	0	0	1	0	intermission
1	0	0	0	1	active error flag
1	0	1	1	0	passive error flag
1	0	0	1	1	tolerate dominant bits
1	0	1	1	1	error delimiter
1	1	1	0	0	overload flag

Notes:

- Bit SRTR: under Standard Frame Format.
- Bit IDE: Identifier Extension Bit, 0 for Standard Frame Format.

31.5.8 Arbitration Lost Capture

The Arbitration Lost Capture (ALC) feature allows the TWAI controller to record the bit position where it loses arbitration. When the TWAI controller loses arbitration, the bit position is recorded in the TWAI_ARB LOST CAP_REG and the Arbitration Lost Interrupt is triggered.

Subsequent loses in arbitration will trigger the Arbitration Lost Interrupt, but will not be recorded in the TWAI_ARB LOST CAP_REG until the current Arbitration Lost Capture is read from the TWAI_ERR_CODE_CAP_REG.

Table 31-18 illustrates bits and fields of the TWAI_ERR_CODE_CAP_REG whilst Figure 31-11 illustrates the bit positions of a TWAI message.

Table 31-18. Bit Information of TWAI_ARB LOST CAP_REG (0x2c)

Bit 31-5	Bit 4	Bit 3	Bit 2	Bit 1	Bit 0
Reserved	BITNO.4 ¹	BITNO.3 ¹	BITNO.2 ¹	BITNO.1 ¹	BITNO.0 ¹

Notes:

- BITNO: Bit Number (BITNO) indicates the nth bit of a TWAI message where arbitration was lost.

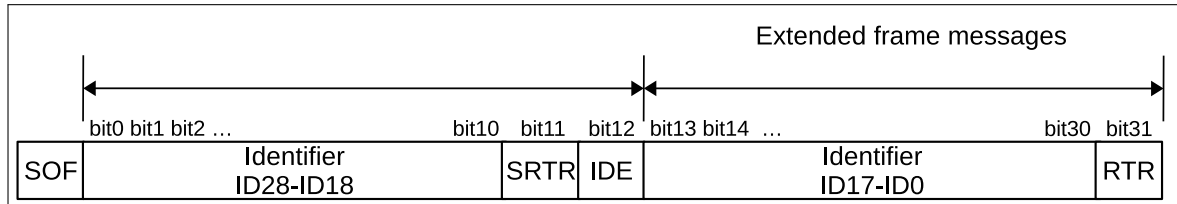

Figure 31-11. Positions of Arbitration Lost Bits

31.6 Register Summary

'|' here means separate line. The left describes the access in Operation Mode. The right belongs to Reset Mode. The addresses in this section are relative to the [\[Two-wire Automotive Interface\]](#) base address provided in Table 4-3 in Chapter 4 *System and Memory*.

The abbreviations given in Column **Access** are explained in Section [Access Types for Registers](#).

Name	Description	Address	Access
Configuration Registers			
TWAI_MODE_REG	Mode Register	0x0000	R/W
TWAI_BUS_TIMING_0_REG	Bus Timing Register 0	0x0018	RO R/W
TWAI_BUS_TIMING_1_REG	Bus Timing Register 1	0x001C	RO R/W
TWAI_ERR_WARNING_LIMIT_REG	Error Warning Limit Register	0x0034	RO R/W
TWAI_DATA_0_REG	Data Register 0	0x0040	WO R/W
TWAI_DATA_1_REG	Data Register 1	0x0044	WO R/W
TWAI_DATA_2_REG	Data Register 2	0x0048	WO R/W
TWAI_DATA_3_REG	Data Register 3	0x004C	WO R/W
TWAI_DATA_4_REG	Data Register 4	0x0050	WO R/W
TWAI_DATA_5_REG	Data Register 5	0x0054	WO R/W
TWAI_DATA_6_REG	Data Register 6	0x0058	WO R/W
TWAI_DATA_7_REG	Data Register 7	0x005C	WO R/W
TWAI_DATA_8_REG	Data Register 8	0x0060	WO RO
TWAI_DATA_9_REG	Data Register 9	0x0064	WO RO
TWAI_DATA_10_REG	Data Register 10	0x0068	WO RO
TWAI_DATA_11_REG	Data Register 11	0x006C	WO RO
TWAI_DATA_12_REG	Data Register 12	0x0070	WO RO
TWAI_CLOCK_DIVIDER_REG	Clock Divider Register	0x007C	varies
Control Registers			
TWAI_CMD_REG	Command Register	0x0004	WO
Status Register			
TWAI_STATUS_REG	Status Register	0x0008	RO
TWAI_ARB_LOST_CAP_REG	Arbitration Lost Capture Register	0x002C	RO
TWAI_ERR_CODE_CAP_REG	Error Code Capture Register	0x0030	RO
TWAI_RX_ERR_CNT_REG	Receive Error Counter Register	0x0038	RO R/W
TWAI_TX_ERR_CNT_REG	Transmit Error Counter Register	0x003C	RO R/W
TWAI_RX_MESSAGE_CNT_REG	Receive Message Counter Register	0x0074	RO
Interrupt Registers			
TWAI_INT_RAW_REG	Interrupt Register	0x000C	RO
TWAI_INT_ENA_REG	Interrupt Enable Register	0x0010	R/W

31.7 Registers

'|' here means separate line. The left describes the access in Operation Mode. The right belongs to Reset Mode with red color. The addresses in this section are relative to the Two-wire Automotive Interface base address provided in Table 4-3 in Chapter 4 *System and Memory*.

Register 31.1. TWAI_MODE_REG (0x0000)

(reserved)																TWAI_RX_FILTER_MODE TWAI_SELF_TEST_MODE TWAI_LISTEN_ONLY_MODE TWAI_RESET_MODE			
31													4	3	2	1	0		
0 0 0 0 0 0 0 0 0 0 0 0 0 0 0 0												0	0	0	0	1	Reset		

TWAI_RESET_MODE This bit is used to configure the operation mode of the TWAI Controller. 1: Reset mode; 0: Operation mode (R/W)

TWAI_LISTEN_ONLY_MODE 1: Listen only mode. In this mode the nodes will only receive messages from the bus, without generating the acknowledge signal nor updating the RX error counter. (R/W)

TWAI_SELF_TEST_MODE 1: Self test mode. In this mode the TX nodes can perform a successful transmission without receiving the acknowledge signal. This mode is often used to test a single node with the self reception request command. (R/W)

TWAI_RX_FILTER_MODE This bit is used to configure the filter mode. 0: Dual filter mode; 1: Single filter mode (R/W)

Register 31.2. TWAI_BUS_TIMING_0_REG (0x0018)

(reserved)												TWAI_SYNC_JUMP_WIDTH (reserved)				TWAI_BAUD_PRESC						
31													16	15	14	13	12					
0 0 0 0 0 0 0 0 0 0 0 0 0 0 0 0												0x0	0x0	0x00				Reset				

TWAI_BAUD_PRESC Baud Rate Prescaler value, determines the frequency dividing ratio. (RO | R/W)

TWAI_SYNC_JUMP_WIDTH Synchronization Jump Width (SJW), 1 ~ 14 Tq wide. (RO | R/W)

Register 31.3. TWAI_BUS_TIMING_1_REG (0x001C)

(reserved)																TWAI_TIME_SAMP		TWAI_TIME_SEG2		TWAI_TIME_SEG1		
31																	8	7	6	4	3	0
0 0																0		0x0		0x0		Reset

TWAI_TIME_SEG1 The width of PBS1. (RO | R/W)

TWAI_TIME_SEG2 The width of PBS2. (RO | R/W)

TWAI_TIME_SAMP The number of sample points. 0: the bus is sampled once; 1: the bus is sampled three times (RO | R/W)

Register 31.4. TWAI_ERR_WARNING_LIMIT_REG (0x0034)

(reserved)																TWAI_ERR_WARNING_LIMIT						
31																8	7	0				
0 0																0x60						Reset

TWAI_ERR_WARNING_LIMIT Error warning threshold. In the case when any of an error counter value exceeds the threshold, or all the error counter values are below the threshold, an error warning interrupt will be triggered (given the enable signal is valid). (RO | R/W)

Register 31.5. TWAI_DATA_0_REG (0x0040)

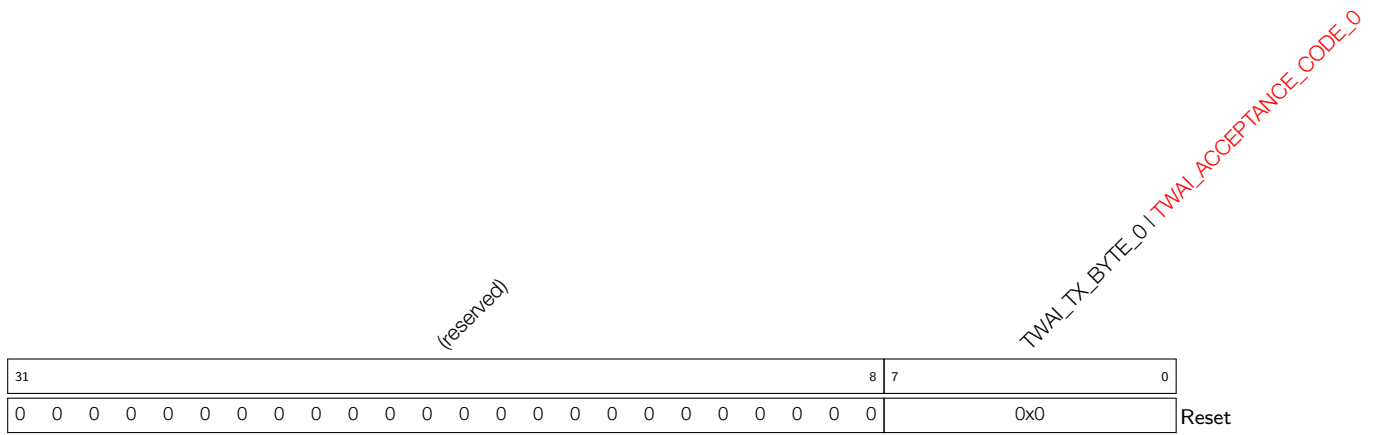

TWAI_TX_BYTE_0 Stored the 0th byte information of the data to be transmitted in operation mode. (WO)

TWAI_ACCEPTANCE_CODE_0 Stored the 0th byte of the filter code in reset mode. (R/W)

Register 31.6. TWAI_DATA_1_REG (0x0044)

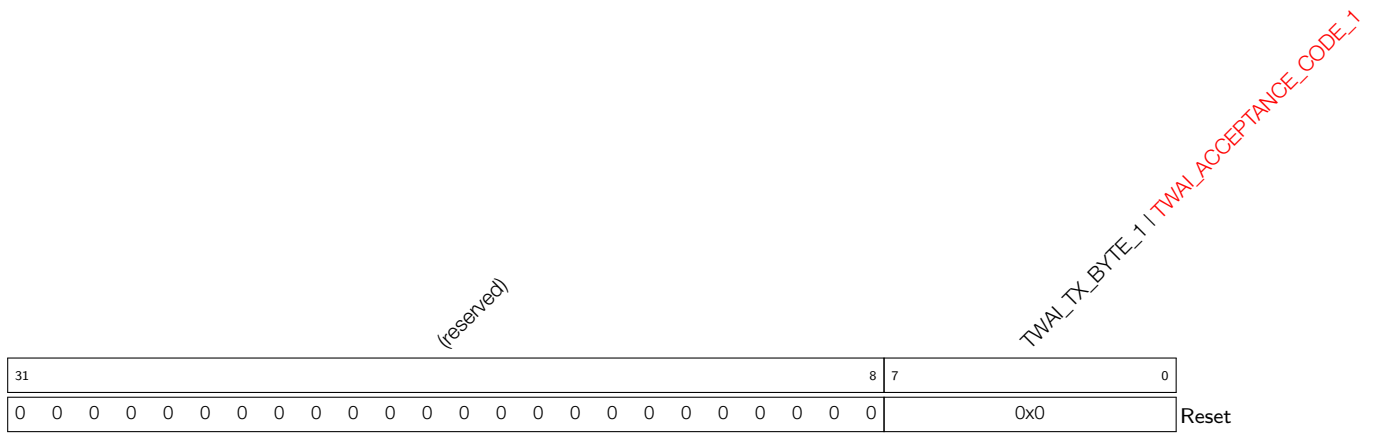

TWAI_TX_BYTE_1 Stored the 1st byte information of the data to be transmitted in operation mode. (WO)

TWAI_ACCEPTANCE_CODE_1 Stored the 1st byte of the filter code in reset mode. (R/W)

Register 31.7. TWAI_DATA_2_REG (0x0048)

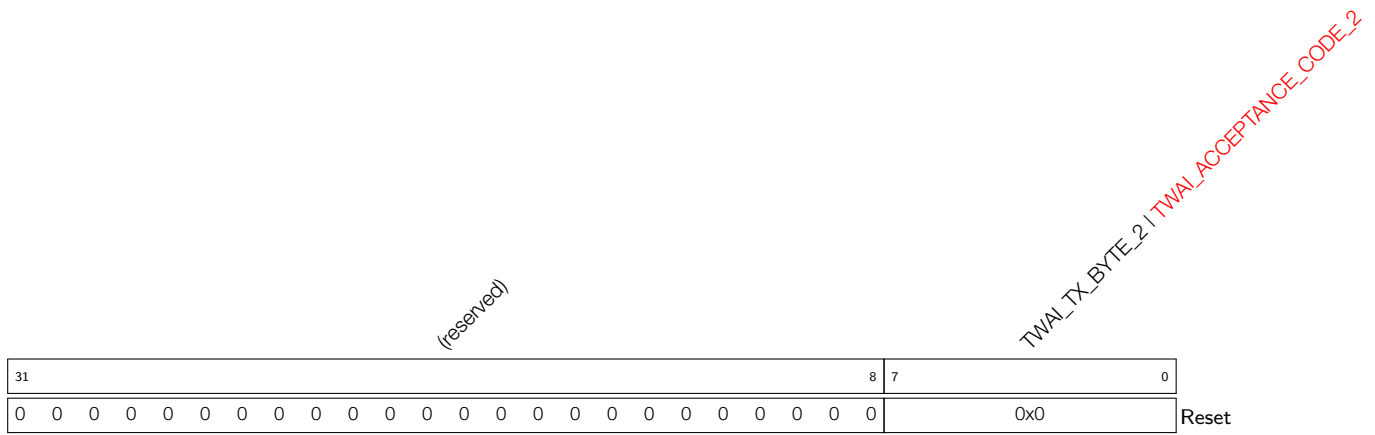

TWAI_TX_BYTE_2 Stored the 2nd byte information of the data to be transmitted in operation mode. (WO)

TWAI_ACCEPTANCE_CODE_2 Stored the 2nd byte of the filter code in reset mode. (R/W)

Register 31.8. TWAI_DATA_3_REG (0x004C)

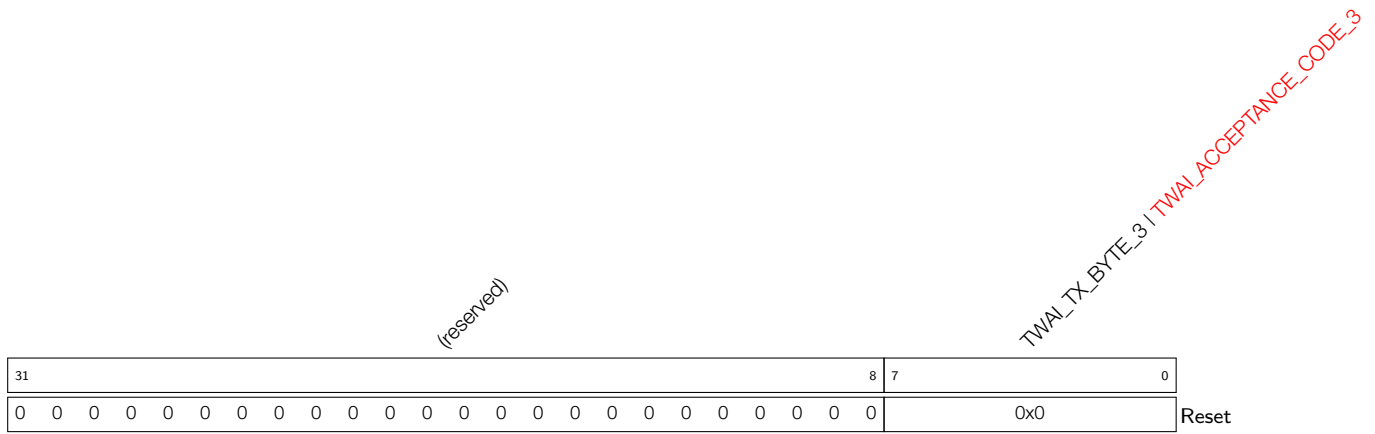

TWAI_TX_BYTE_3 Stored the 3rd byte information of the data to be transmitted in operation mode. (WO)

TWAI_ACCEPTANCE_CODE_3 Stored the 3rd byte of the filter code in reset mode. (R/W)

Register 31.9. TWAI_DATA_4_REG (0x0050)

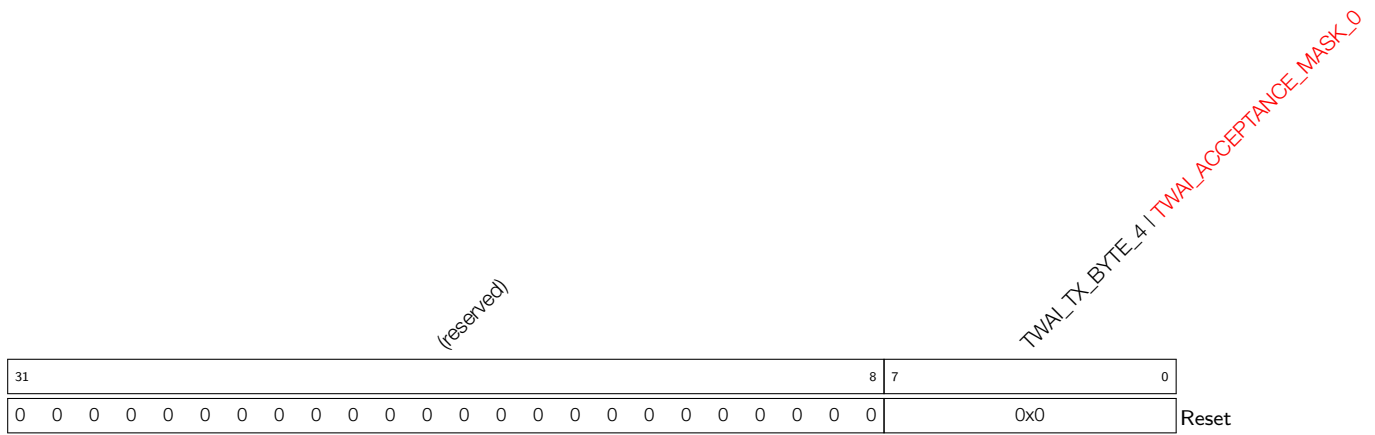

TWAI_TX_BYTE_4 Stored the 4th byte information of the data to be transmitted in operation mode. (WO)

TWAI_ACCEPTANCE_MASK_0 Stored the 0th byte of the filter code in reset mode. (R/W)

Register 31.10. TWAI_DATA_5_REG (0x0054)

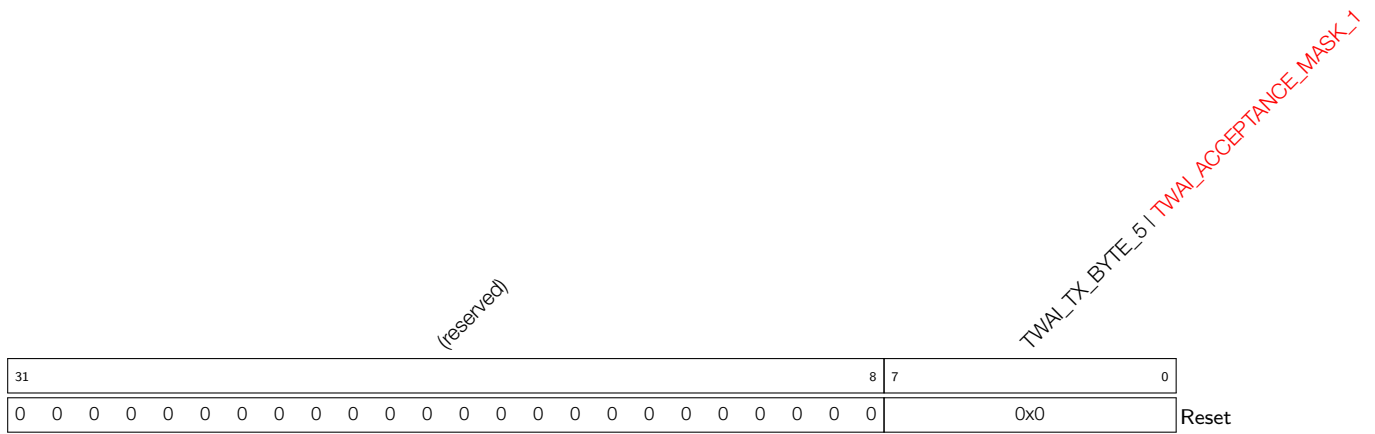

TWAI_TX_BYTE_5 Stored the 5th byte information of the data to be transmitted in operation mode. (WO)

TWAI_ACCEPTANCE_MASK_1 Stored the 1st byte of the filter code in reset mode. (R/W)

Register 31.11. TWAI_DATA_6_REG (0x0058)

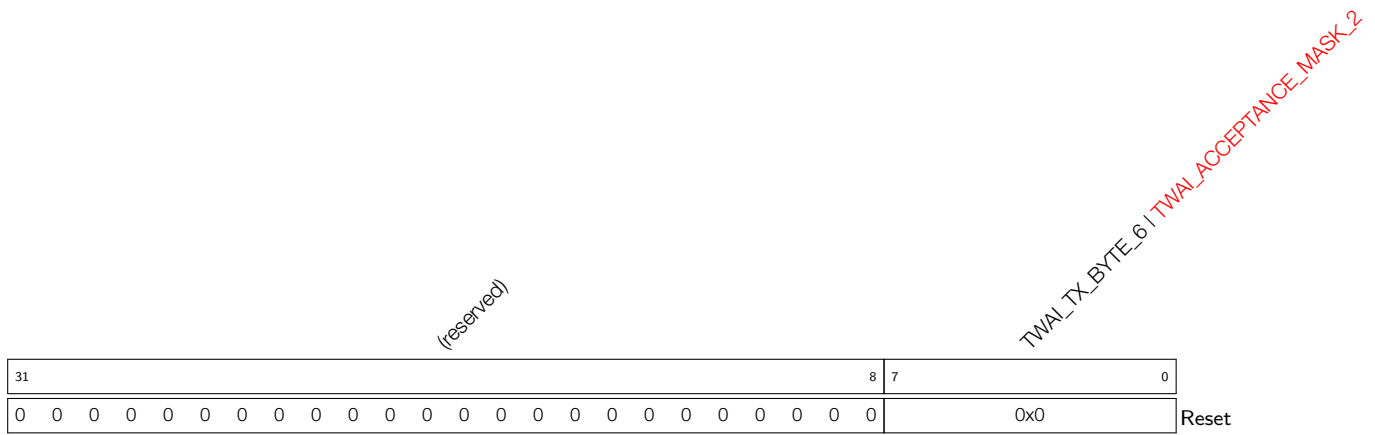

TWAI_TX_BYTE_6 Stored the 6th byte information of the data to be transmitted in operation mode. (WO)

TWAI_ACCEPTANCE_MASK_2 Stored the 2nd byte of the filter code in reset mode. (R/W)

Register 31.12. TWAI_DATA_7_REG (0x005C)

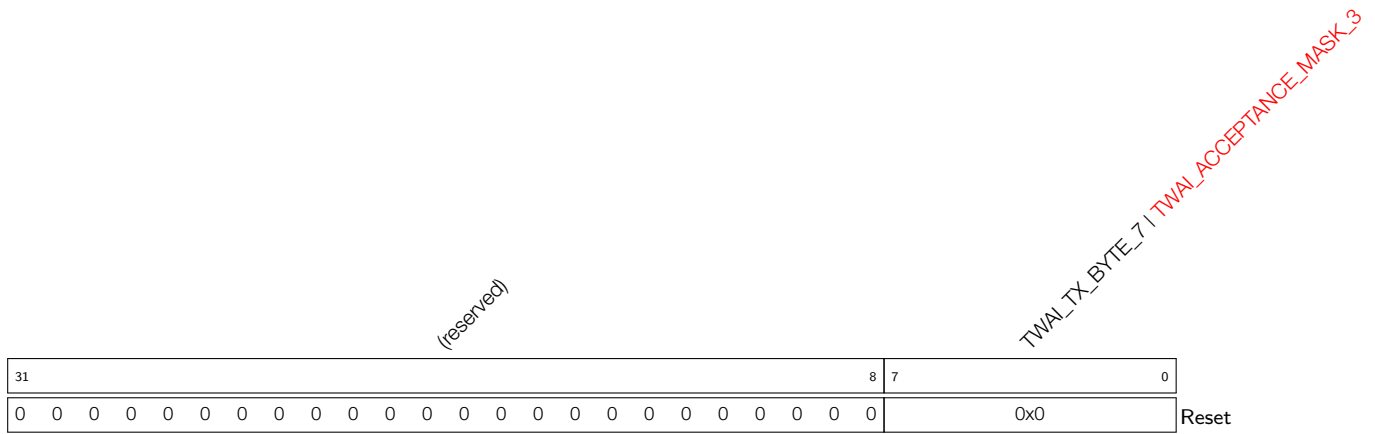

TWAI_TX_BYTE_7 Stored the 7th byte information of the data to be transmitted in operation mode. (WO)

TWAI_ACCEPTANCE_MASK_3 Stored the 3rd byte of the filter code in reset mode. (R/W)

Register 31.13. TWAI_DATA_8_REG (0x0060)

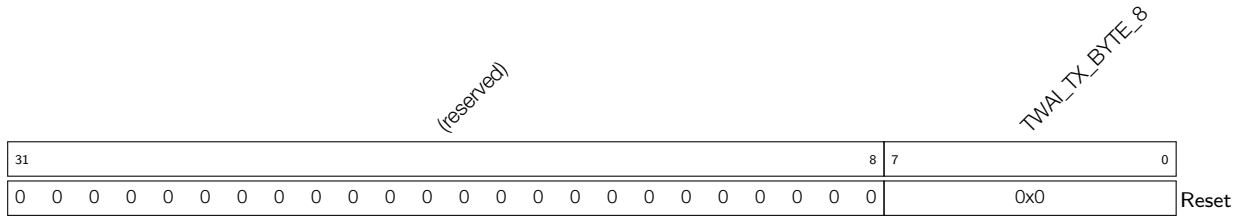

TWAI_TX_BYTE_8 Stored the 8th byte information of the data to be transmitted in operation mode.
(WO)

Register 31.14. TWAI_DATA_9_REG (0x0064)

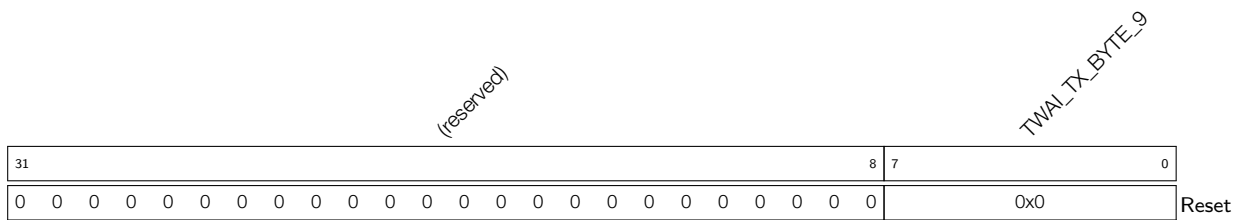

TWAI_TX_BYTE_9 Stored the 9th byte information of the data to be transmitted in operation mode.
(WO)

Register 31.15. TWAI_DATA_10_REG (0x0068)

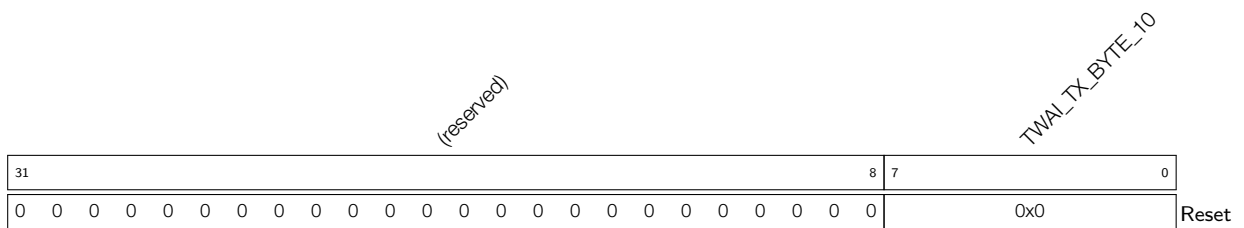

TWAI_TX_BYTE_10 Stored the 10th byte information of the data to be transmitted in operation mode.
(WO)

Register 31.16. TWAI_DATA_11_REG (0x006C)

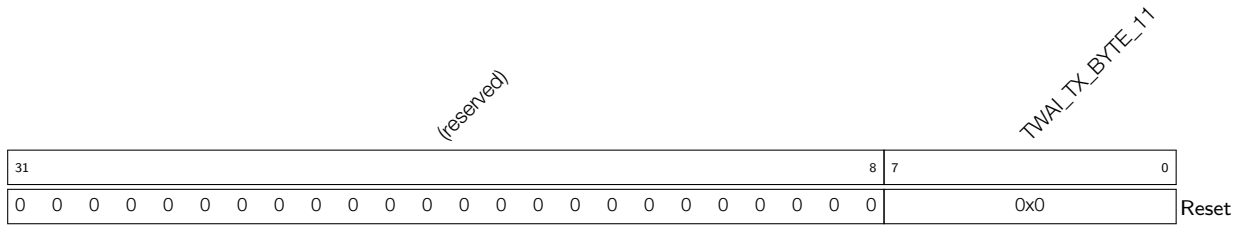

TWAI_TX_BYTE_11 Stored the 11th byte information of the data to be transmitted in operation mode. (WO)

Register 31.17. TWAI_DATA_12_REG (0x0070)

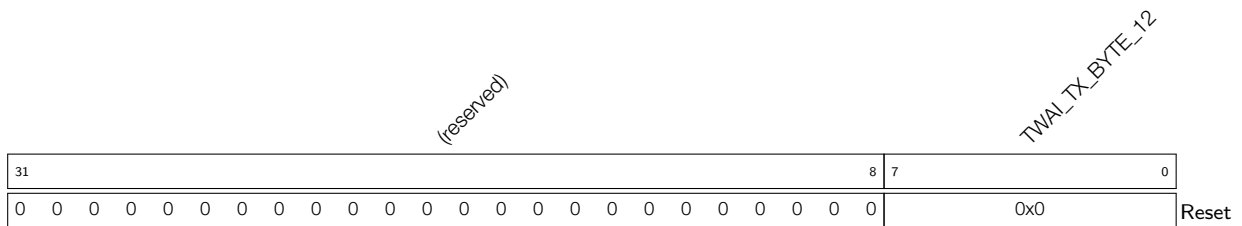

TWAI_TX_BYTE_12 Stored the 12th byte information of the data to be transmitted in operation mode. (WO)

Register 31.18. TWAI_CLOCK_DIVIDER_REG (0x007C)

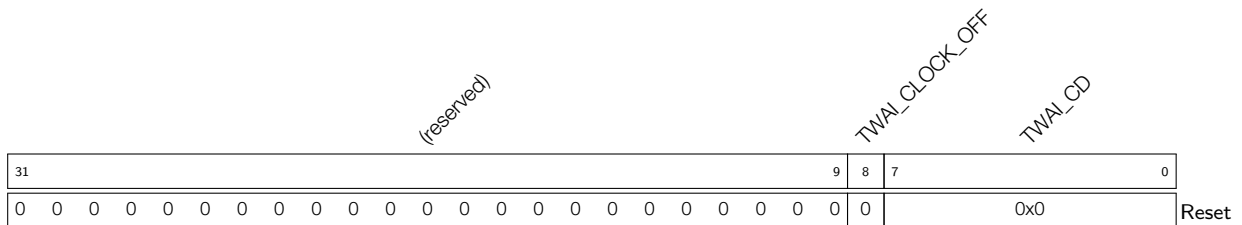

TWAI_CD These bits are used to configure the divisor of the external CLKOUT pin. (R/W)

TWAI_CLOCK_OFF This bit can be configured in reset mode. 1: Disable the external CLKOUT pin; 0: Enable the external CLKOUT pin (RO | R/W)

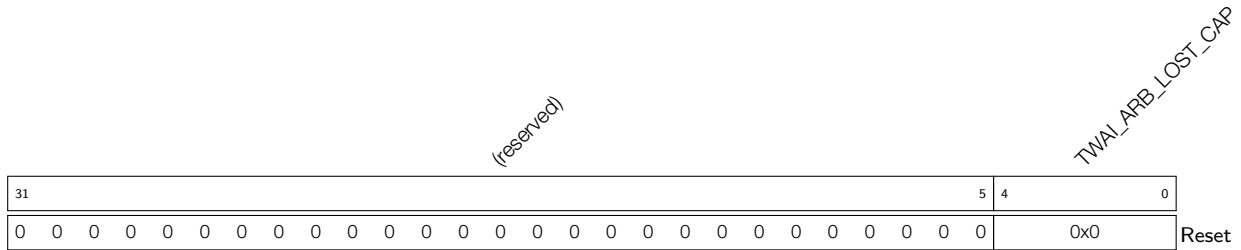
Register 31.21. TWAI_ARB_LOST_CAP_REG (0x002C)

TWAI_ARB_LOST_CAP This register contains information about the bit position of lost arbitration. (RO)

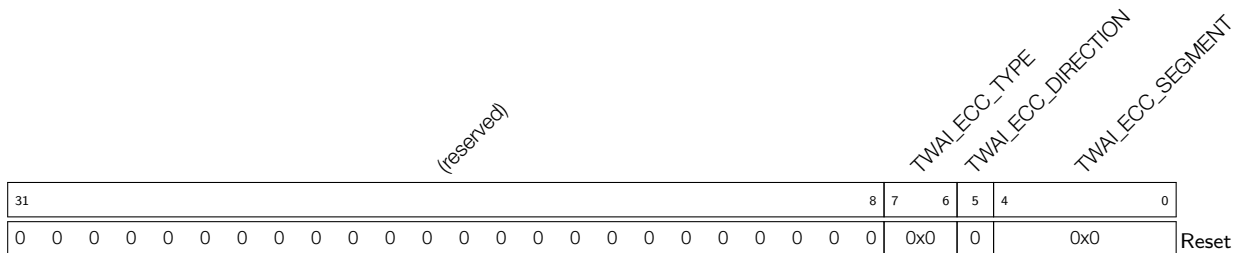
Register 31.22. TWAI_ERR_CODE_CAP_REG (0x0030)

TWAI_ERR_SEGMENT This register contains information about the location of errors, see Table 31-16 for details. (RO)

TWAI_ERR_DIRECTION This register contains information about transmission direction of the node when error occurs. 1: Error occurs when receiving a message; 0: Error occurs when transmitting a message (RO)

TWAI_ERR_TYPE This register contains information about error types: 00: bit error; 01: form error; 10: stuff error; 11: other type of error (RO)

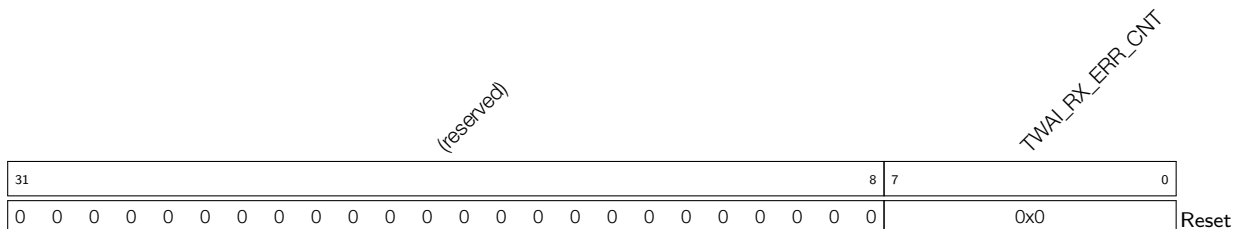
Register 31.23. TWAI_RX_ERR_CNT_REG (0x0038)

TWAI_RX_ERR_CNT The RX error counter register, reflects value changes in reception status. (RO | R/W)

Register 31.24. TWAI_TX_ERR_CNT_REG (0x003C)

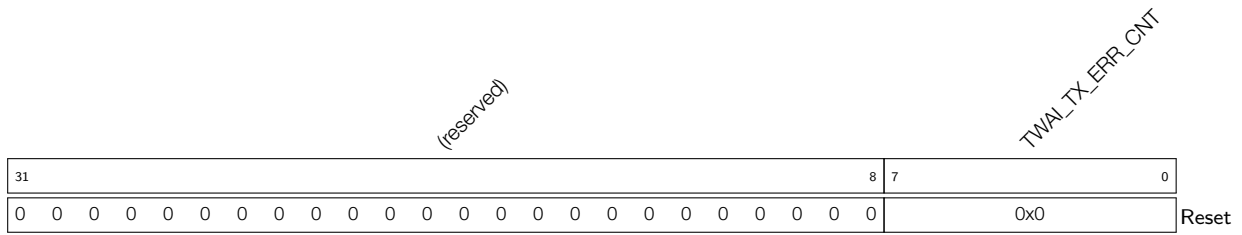

TWAI_TX_ERR_CNT The TX error counter register, reflects value changes in transmission status. (RO
I R/W)

Register 31.25. TWAI_RX_MESSAGE_CNT_REG (0x0074)

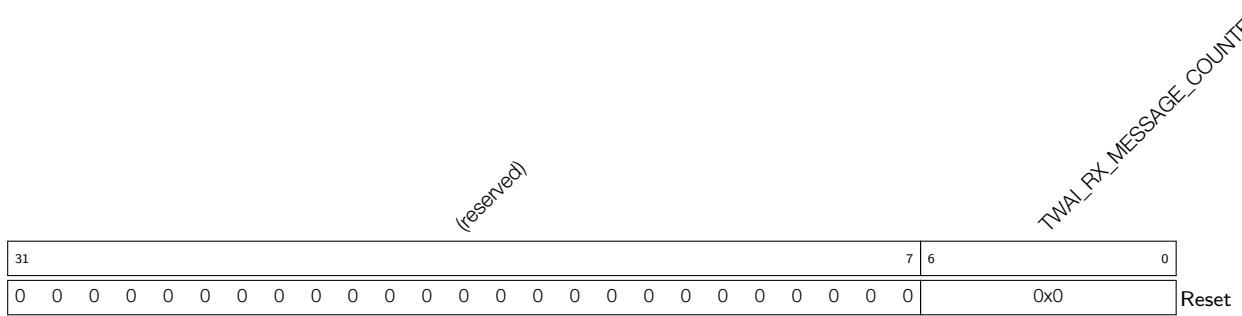

TWAI_RX_MESSAGE_COUNTER This register reflects the number of messages available within the RX FIFO. (RO)

Register 31.26. TWAI_INT_RAW_REG (0x000C)

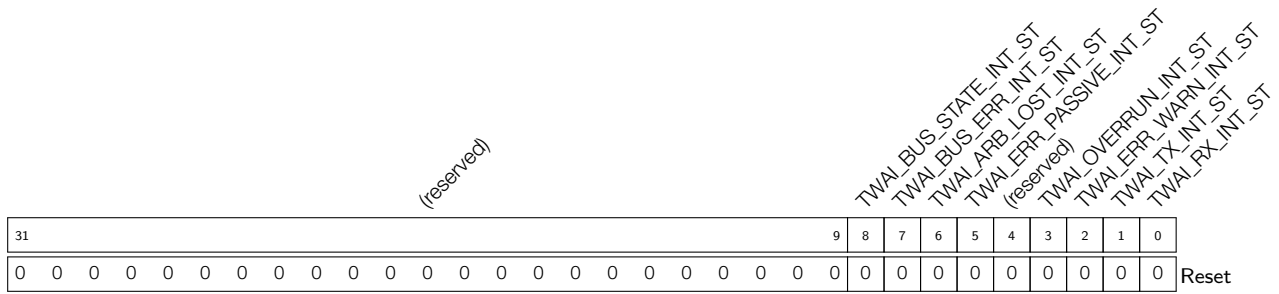

TWAI_RX_INT_ST Receive interrupt. If this bit is set to 1, it indicates there are messages to be handled in the RX FIFO. (RO)

TWAI_TX_INT_ST Transmit interrupt. If this bit is set to 1, it indicates the message transmission is finished and a new transmission is able to start. (RO)

TWAI_ERR_WARN_INT_ST Error warning interrupt. If this bit is set to 1, it indicates the error status signal and the bus-off status signal of Status register have changed (e.g., switched from 0 to 1 or from 1 to 0). (RO)

TWAI_OVERRUN_INT_ST Data overrun interrupt. If this bit is set to 1, it indicates a data overrun interrupt is generated in the RX FIFO. (RO)

TWAI_ERR_PASSIVE_INT_ST Error passive interrupt. If this bit is set to 1, it indicates the TWAI Controller is switched between error active status and error passive status due to the change of error counters. (RO)

TWAI_ARB_LOST_INT_ST Arbitration lost interrupt. If this bit is set to 1, it indicates an arbitration lost interrupt is generated. (RO)

TWAI_BUS_ERR_INT_ST Error interrupt. If this bit is set to 1, it indicates an error is detected on the bus. (RO)

TWAI_BUS_STATE_INT_ST Bus state interrupt. If this bit is set to 1, it indicates the status of TWAI controller has changed. (RO)

Register 31.27. TWAI_INT_ENA_REG (0x0010)

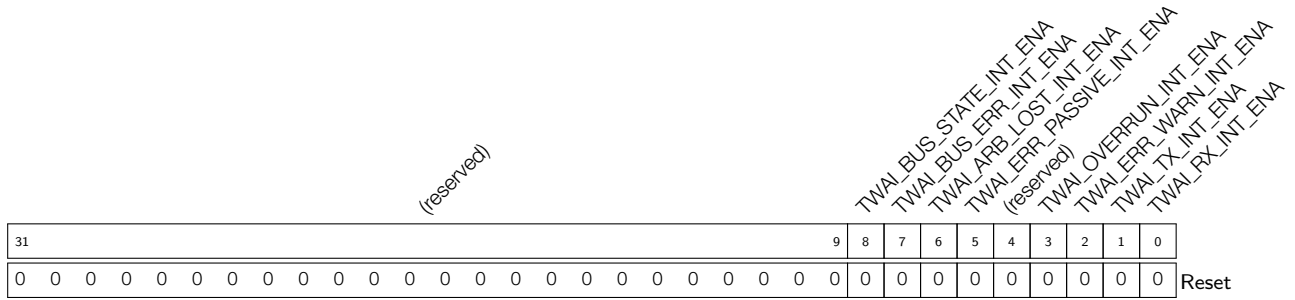

TWAI_RX_INT_ENA Set this bit to 1 to enable receive interrupt. (R/W)

TWAI_TX_INT_ENA Set this bit to 1 to enable transmit interrupt. (R/W)

TWAI_ERR_WARN_INT_ENA Set this bit to 1 to enable error warning interrupt. (R/W)

TWAI_OVERRUN_INT_ENA Set this bit to 1 to enable data overrun interrupt. (R/W)

TWAI_ERR_PASSIVE_INT_ENA Set this bit to 1 to enable error passive interrupt. (R/W)

TWAI_ARB_LOST_INT_ENA Set this bit to 1 to enable arbitration lost interrupt. (R/W)

TWAI_BUS_ERR_INT_ENA Set this bit to 1 to enable bus error interrupt. (R/W)

TWAI_BUS_STATE_INT_ENA Set this bit to 1 to enable bus state interrupt. (R/W)

32 USB On-The-Go (USB)

32.1 Overview

The ESP32-S3 features a USB On-The-Go peripheral (henceforth referred to as OTG_FS) along with an integrated transceiver. The OTG_FS can operate as either a USB Host or Device and supports 12 Mbit/s full-speed (FS) and 1.5 Mbit/s low-speed (LS) data rates of the USB 2.0 specification. The Host Negotiation Protocol (HNP) and the Session Request Protocol (SRP) are also supported.

32.2 Features

32.2.1 General Features

- FS and LS data rates
- HNP and SRP as A-device or B-device
- Dynamic FIFO (DFIFO) sizing
- Multiple modes of memory access
 - Scatter/Gather DMA mode
 - Buffer DMA mode
 - Slave mode
- Can choose integrated transceiver or external transceiver
- Utilizing integrated transceiver with USB Serial/JTAG by time-division multiplexing when only integrated transceiver is used
- Support USB OTG using one of the transceivers while USB Serial/JTAG using the other one when both integrated transceiver or external transceiver are used

32.2.2 Device Mode Features

- Endpoint number 0 always present (bi-directional, consisting of EP0 IN and EP0 OUT)
- Six additional endpoints (endpoint numbers 1 to 6), configurable as IN or OUT
- Maximum of five IN endpoints concurrently active at any time (including EP0 IN)
- All OUT endpoints share a single RX FIFO
- Each IN endpoint has a dedicated TX FIFO

32.2.3 Host Mode Features

- Eight channels (pipes)
 - A control pipe consists of two channels (IN and OUT), as IN and OUT transactions must be handled separately. Only Control transfer type is supported.
 - Each of the other seven channels is dynamically configurable to be IN or OUT, and supports Bulk, Isochronous, and Interrupt transfer types.

- All channels share an RX FIFO, non-periodic TX FIFO, and periodic TX FIFO. The size of each FIFO is configurable.

32.3 Functional Description

32.3.1 Controller Core and Interfaces

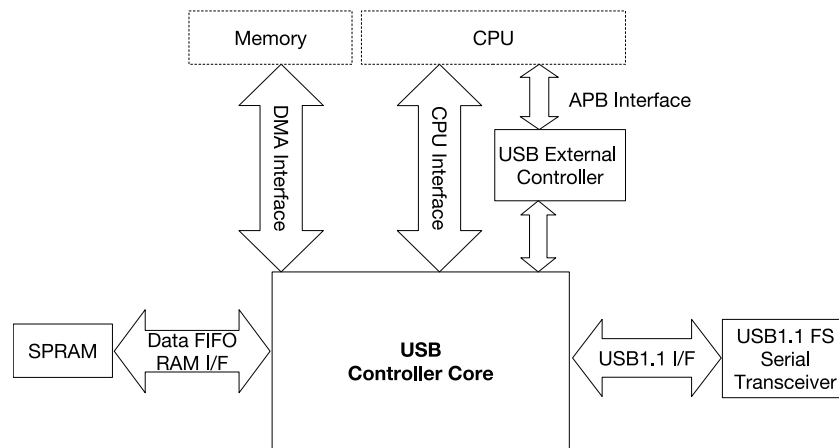

Figure 32-1. OTG_FS System Architecture

The core part of the OTG_FS peripheral is the USB Controller Core. The controller core has the following interfaces (see Figure 32-1):

- **CPU Interface**
Provides the CPU with read/write access to the controller core's various registers and FIFOs. This interface is internally implemented as an AHB Slave Interface. The way to access the FIFOs through the CPU interface is called Slave mode.
- **APB Interface**
Allows the CPU to control the USB controller core via the USB external controller.
- **DMA Interface**
Provides the controller core's internal DMA with read/write access to system memory (e.g., fetching and writing data payloads when operating in DMA mode). This interface is internally implemented as an AHB Master interface.
- **USB 1.1 Interface**
This interface is used to connect the controller core to a USB 1.1 FS serial transceiver. Aside from USB OTG, ESP32-S3 also includes a USB Serial/JTAG controller (see Chapter 33 [USB Serial/JTAG Controller \(USB_SERIAL_JTAG\)](#)). These two USB controllers can utilize the integrated internal transceiver by time-division multiplexing or one USB controller connects to internal transceiver and the other one connects to an external transceiver.

When only internal transceiver is used, it is shared by USB OTG and USB Serial/JTAG. In default, internal transceiver is connected to USB Serial/JTAG. When `RTC_CNTL_SW_HW_USB_PHY_SEL_CFG` is 0, the connection of internal transceiver is controlled by efuse bit `EFUSE_USB_PHY_SEL`. When `EFUSE_USB_PHY_SEL` is 0, internal transceiver is connected with USB Serial/JTAG. Otherwise, it is connected to USB OTG. When `RTC_CNTL_SW_HW_USB_PHY_SEL_CFG` is 1, the connection switching is controlled by `RTC_CNTL_SW_USB_PHY_SEL_CFG`(it has the same meaning with

EFUSE_USB_PHY_SEL).

When both internal transceiver and external transceiver are used, one USB controller select one of transceivers, the other would select the other transceiver. The specific connection mapping please refer to Chapter 33 *USB Serial/JTAG Controller (USB_SERIAL_JTAG)*.

- **USB External Controller**

The USB External Controller is primarily used to control the routing of the USB 2.0 FS serial interface to either the internal or external transceiver. The External Controller can also enable a power saving mode by gating the controller core's clock (AHB clock) or powering down the connected SPRAM. Note that this power saving mode is different for the power savings via SRP.

- **Data FIFO RAM Interface**

The multiple FIFOs used by the controller core are not actually located within the controller core itself, but on the SPRAM (Single-Port RAM). FIFOs are dynamically sized, thus are allocated at run-time in the SPRAM. When the CPU, DMA, or the controller core attempts to read/write to FIFOs, those accesses are routed through the data FIFO RAM interface.

32.3.2 Memory Layout

The following diagram illustrates the memory layout of the OTG_FS registers which are used to configure and control the USB Controller Core. Note that USB External Controller uses a separate set of registers (called wrap registers).

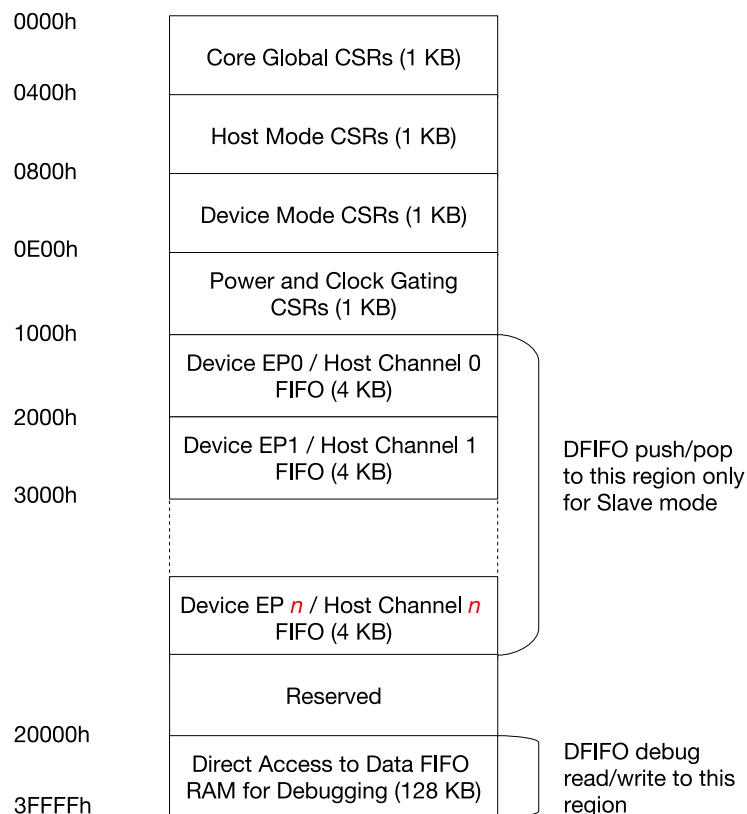

Figure 32-2. OTG_FS Register Layout

32.3.2.1 Control & Status Registers

- **Global CSRs**

These registers are responsible for the configuration/control/status of the global features of OTG_FS (i.e., features which are common to both Host and Device modes). These features include OTG control (HNP, SRP, and A/B-device detection), USB configuration (selecting Host or Device mode and PHY selection), and system-level interrupts. Software can access these registers whilst in Host or Device modes.

- **Host Mode CSRs**

These registers are responsible for the configuration/control/status when operating in Host mode, thus should only be accessed when operating in Host mode. Each channel will have its own set of registers within the Host mode CSRs.

- **Device Mode CSRs**

These registers are responsible for the configuration/control/status when operating in Device mode, thus should only be accessed when operating in Device mode. Each Endpoint will have its own set of registers within the Device mode CSRs.

- **Power and Clock Gating**

A single register used to control power-down and gate various clocks.

32.3.2.2 FIFO Access

The OTG_FS makes use of multiple FIFOs to buffer transmitted or received data payloads. The number and type of FIFOs are dependent on Host or Device mode, and the number of channels or endpoints used (see Section 32.3.3). There are two ways to access the FIFOs: DMA mode and Slave mode. When using Slave mode, the CPU will need to access to these FIFOs by reading and writing to either the DFIFO push/pop regions or the DFIFO read/write debug region. FIFO access is governed by the following rules:

- Read access to any address in any one of the 4 KB push/pop regions will result in a pop from the shared RX FIFO.
- Write access to a particular 4 KB push/pop region will result in a push to the corresponding endpoint or channel's TX FIFO given that the endpoint is an IN endpoint, or the channel is an OUT channel.
 - In Device mode, data is pushed to the corresponding IN endpoint's dedicated TX FIFO.
 - In Host mode, data is pushed to the non-periodic TX FIFO or the periodic TX FIFO depending on whether the channel is a non-periodic channel, or a periodic channel.
- Access to the 128 KB read/write region will result in direct read/write instead of a push/pop. This is generally used for debugging purposes only.

Note that pushing and popping data to and from the FIFOs by the CPU is only required when operating in Slave mode. When operating in DMA mode, the internal DMA will handle all pushing/popping of data to and from the TX and RX FIFOs.

32.3.3 FIFO and Queue Organization

The FIFOs in OTG_FS are primarily used to hold data packet payloads (the data field of USB Data packets). TX FIFOs are used to store data payloads that will be transmitted by OUT transactions in Host mode or IN transactions in Device mode. RX FIFOs are used to store received data payloads of IN transactions in Host mode

or OUT transactions in Device mode. In addition to storing data payloads, RX FIFOs also store a **status entry** for each data payload. Each status entry contains information about a data payload such as channel number, byte count, and validity status. When operating in slave mode, status entries are also used to indicate various channel events.

The portion of SPRAM that can be used for FIFO allocation has a depth of 256 and a width of 35 bits (32 data bits plus 3 control bits). The multiple FIFOs used by each channel (in Host mode) or endpoint (in Device mode) are allocated into the SPRAM and can be dynamically sized.

32.3.3.1 Host Mode FIFOs and Queues

The following FIFOs are used when operating in Host mode (see Figure 32-3):

- **Non-periodic TX FIFO:** Stores data payloads of bulk and control OUT transactions for all channels.
- **Periodic TX FIFO:** Stores data payloads of interrupt or isochronous OUT transactions for all channels.
- **RX FIFO:** Stores data payloads of all IN transactions, and status entries that are used to indicate size of data payloads and transaction/channel events such as transfer complete or channel halted.

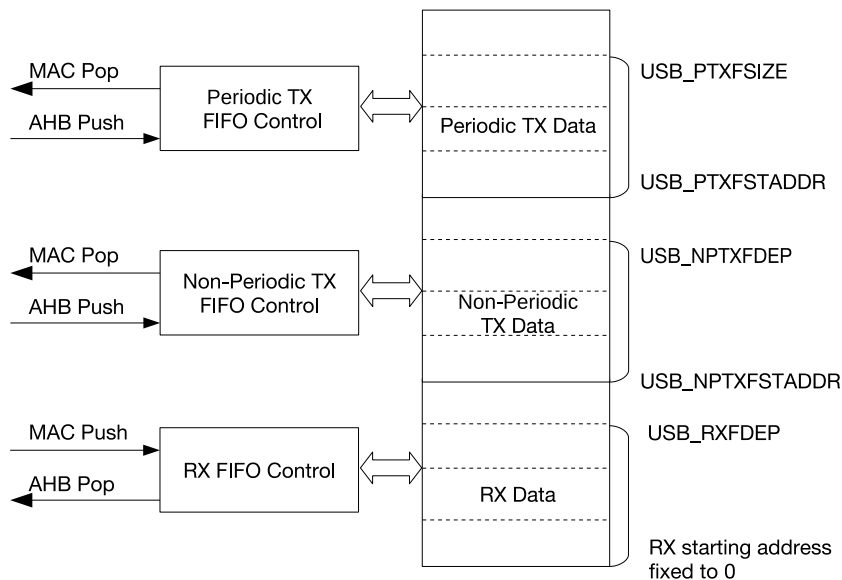

Figure 32-3. Host Mode FIFOs

In addition to FIFOs, Host mode also contains two request queues used to queue up the various transaction request from the multiple channels. Each entry in a request queue holds the IN/OUT channel number along with other information to perform the transaction (such as transaction type). Request queues are also used to queue other types of requests such as a channel halt request.

Unlike FIFOs, request queues are fixed in size and cannot be accessed directly by software. Rather, once a channel is enabled, requests will be automatically written to the request queue by the Host core. The order in which the requests are written into the queue determines the sequence of transactions on the USB.

Host mode contains the following request queues:

- **Non-periodic request queue:** Request queue for all non-periodic channels (bulk and control). The queue has a depth of four entries.

- **Periodic request queue:** Request queue for all periodic channels (interrupt and isochronous). The queue has a depth of eight entries.

When scheduling transactions, hardware will execute all requests on the periodic request queue first before executing requests on the non-periodic request queue.

32.3.3.2 Device Mode FIFOs

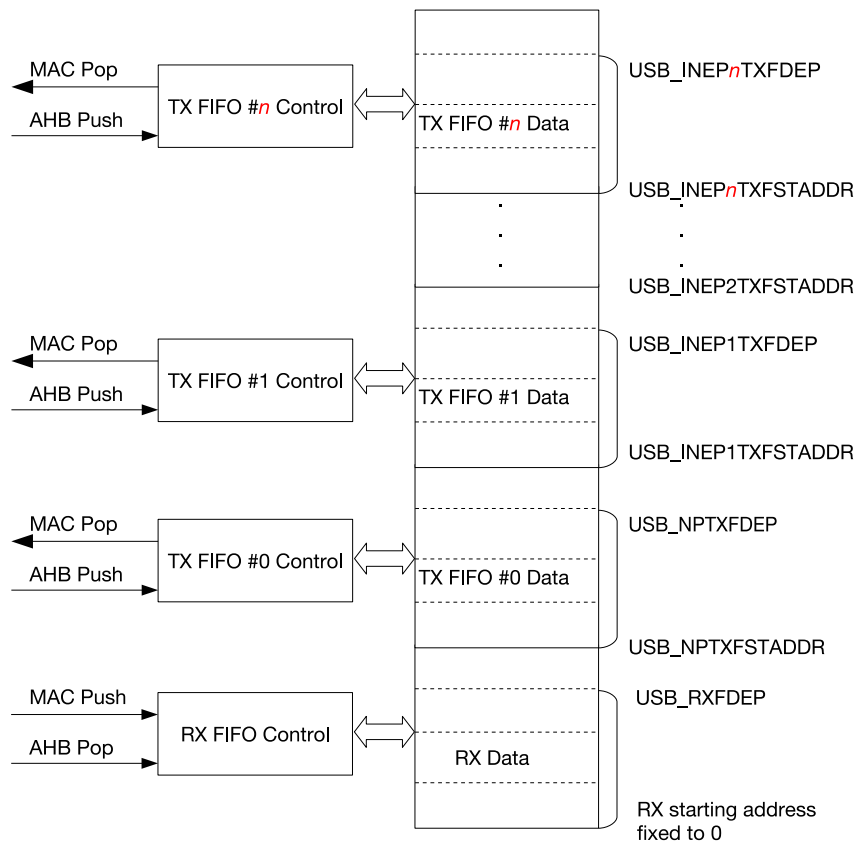

Figure 32-4. Device Mode FIFOs

The following FIFOs are used when operating in Device mode (See Figure 32-4):

- **RX FIFO:** Stores data payloads received in Data packet, and status entries (used to indicate size of those data payloads).
- **Dedicated TX FIFO:** Each active IN endpoint will have a dedicated TX FIFO used to store all IN data payloads of that endpoint, regardless of the transaction type (both periodic and non-periodic IN transactions).

Due to the dedicated FIFOs, Device mode does not use any request queues. Instead, the order of IN transactions are determined by the Host.

32.3.4 Interrupt Hierarchy

OTG_FS provides a single interrupt line which can be routed via the interrupt matrix to one of the CPUs. The interrupt signal can be unmasked by setting USB_GLBLINTRMSK. The OTG_FS interrupt is an OR of all bits in the USB_GINTSTS_REG register, and the bits in USB_GINTSTS_REG can be unmasked by setting the corresponding bits in the USB_GINTMSK_REG register. USB_GINTSTS_REG contains system level interrupts,

and also specific bits for Host or Device mode interrupts, and OTG specific interrupts. OTG_FS interrupt sources are organized as Figure 32-5 shows.

The following bits of the USB_GINTSTS_REG register indicate an interrupt source lower in the hierarchy:

- **USB_PRTINT** indicates that the Host port has a pending interrupt. The USB_HPRT_REG register indicates the interrupt source.
- **USB_HCHINT** indicates that one or more Host channels have a pending interrupt. Read the USB_HAINT_REG register to determine which channel(s) have a pending interrupt, then read the pending channel's USB_HCINT_{*n*}_REG register to determine the interrupt source.
- **USB_OEPINT** indicates that one or more OUT endpoints have a pending interrupt. Read the USB_DAINTEP_REG register to determine which OUT endpoint(s) have a pending interrupt, then read the USB_DOEPINT_{*n*}_REG register to determine the interrupt source.
- **USB_IEPINT** indicates that one or more IN endpoints have a pending interrupt. Read the USB_DAINTEP_REG register to determine which IN endpoint(s) are pending, then read the pending IN endpoint's USB_DIEPINT_{*n*}_REG register to determine the interrupt source.
- **USB_OTGINT** indicates an On-The-Go event has triggered an interrupt. Read the USB_GOTGINT_REG register to determine which OTG event(s) triggered the interrupt.

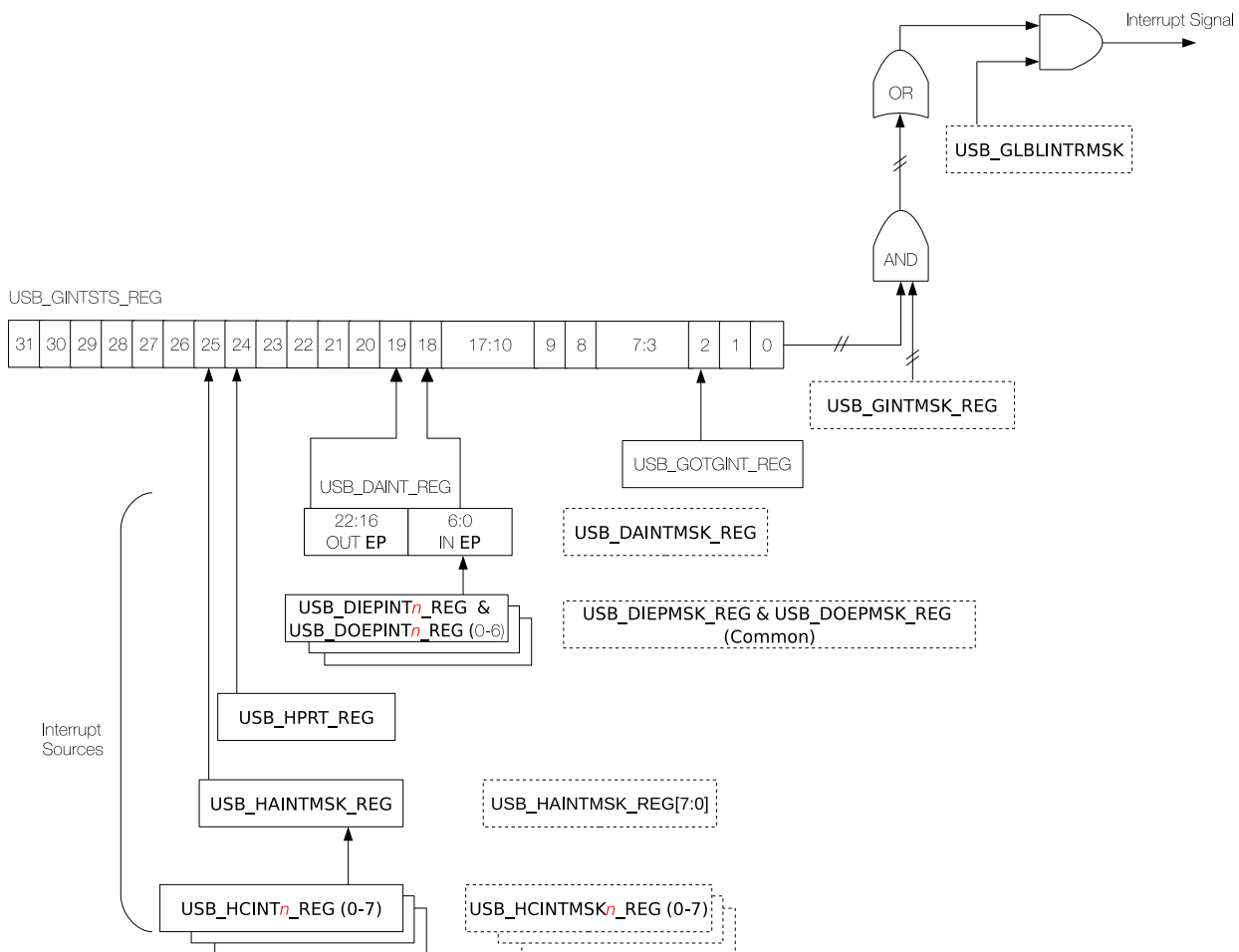

Figure 32-5. OTG_FS Interrupt Hierarchy

32.3.5 DMA Modes and Slave Mode

USB On-The-Go supports three ways to access memory: Scatter/Gather DMA mode, Buffer DMA mode, and Slave mode.

32.3.5.1 Slave Mode

When operating in Slave mode, all data payloads must be pushed/popped to and from the FIFOs by the CPU.

- When transmitting a packet using IN endpoints or OUT channels, the data payload must be pushed into the corresponding endpoint or channel's TX FIFO.
- When receiving a packet, the packet's status entry must first be popped off the RX FIFO by reading USB_GRXSTSP_REG. The status entry should be used to determine the length of the packet's payload (in bytes). The corresponding number of bytes must then be manually popped off the RX FIFO by reading from the RX FIFO's memory region.

32.3.5.2 Buffer DMA Mode

Buffer mode is similar to Slave mode but utilizes the internal DMA to push and pop data payloads to the FIFOs.

- When transmitting a packet using IN endpoints or OUT channels, the data payload's address in memory should be written to the USB_HCDMA n _REG (in Host mode) or USB_DOEPDMA n _REG (in Device mode) registers. When the endpoint or channel is enabled, the internal DMA will push the data payload from memory into the TX FIFO of the channel or endpoint.
- When receiving a packet using OUT endpoints or IN channels, the address of an empty buffer in memory should be written to the USB_HCDMA n _REG (in Host mode) or USB_DOEPDMA n _REG (in Device mode) registers. When the endpoint or channel is enabled, the internal DMA will pop the data payload from RX FIFO into the buffer.

32.3.5.3 Scatter/Gather DMA Mode

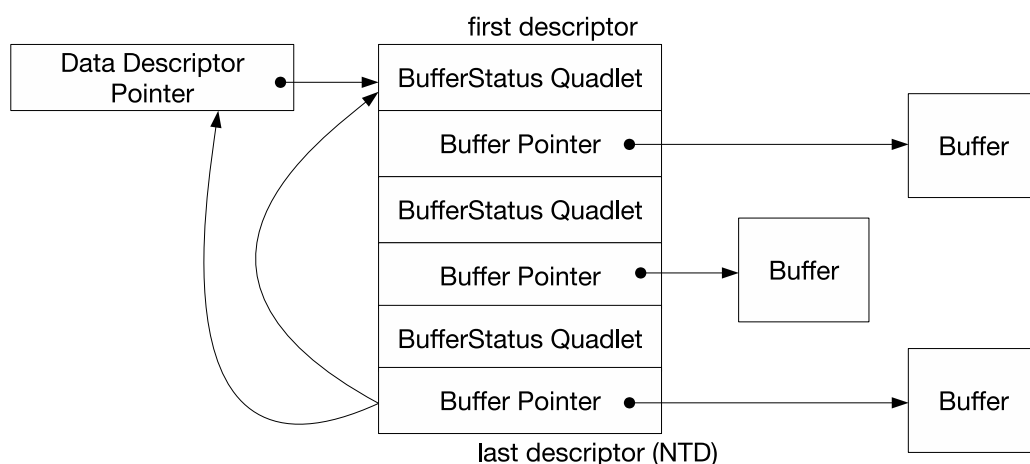

Figure 32-6. Scatter/Gather DMA Descriptor List

When operating in Scatter/Gather DMA mode, buffers containing data payloads can be scattered throughout memory. Each endpoint or channel will have a contiguous DMA descriptor list, where each descriptor contains a 32-bit pointer to the data payload or buffer and a 32-bit buffer descriptor (BufferStatus Quadlet). The data payloads and buffers can correspond to a single transaction (i.e., < 1 MPS bytes) or an entire transfer (> 1 MPS bytes). (MPS: maximum packet size) The list is implemented as a ring buffer meaning that the DMA will return to the first entry when it encounters the last entry on the list.

- When transmitting a transfer/transaction using IN endpoints or OUT channels, the DMA will gather the data payloads from the multiple buffers and push them into a TX FIFO.
- When receiving a transfer/transaction using OUT endpoints or IN channels, the DMA will pop the received data payloads from the RX FIFO and scatter them to the multiple buffers pointed to by the DMA list entries.

32.3.6 Transaction and Transfer Level Operation

When operating in either Host or Device mode, communication can operate either at the transaction level or the transfer level.

32.3.6.1 Transaction and Transfer Level in DMA Mode

When operating at the transfer level in DMA Host mode, software is interrupted only when a channel has been halted. Channels are halted when their programmed transfer size has completed successfully, has received a STALL, or if there are excessive transaction errors (i.e., 3 consecutive transaction errors). When operating in DMA Device mode, all errors are handled by the controller core itself.

When operating at the transaction level in DMA mode, the transfer size is set to the size of one data packet (either a maximum packet size or a short packet size).

32.3.6.2 Transaction and Transfer Level in Slave Mode

When operating at the transaction level in Slave Mode, transfers are handled one transaction at a time. Each data payload should correspond to a single data packet, and software must determine whether a retry of the transaction is necessary based on the handshake response received on the USB (e.g., ACK or NAK).

The following table describes transaction level operation in Slave mode for both IN and OUT transactions.

Table 32-1. IN and OUT Transactions in Slave Mode

Host Mode	Device Mode
OUT Transactions	
<ol style="list-style-type: none"> 1. Software specifies the size of the data packet and the number of data packets (1 data packet) in the USB_HCTSIZ_n_REG register, enables the channel, then copies the packet's data payload into the TX FIFO. 2. When the last DWORD of the data payload has been pushed, the controller core will automatically write a request into the appropriate request queue. 3. If the transaction was successful, the USB_XFERCOMPL interrupt will be generated. If the transaction was unsuccessful, an error interrupt (e.g. USB_H_NACK_n) will occur. 	<ol style="list-style-type: none"> 1. Software specifies the expected size of the data packet (1 MPS) and the number of data packets (1 data packet) in the USB_DIEPTSIZ_n_REG register. Once the endpoint is enabled, it will wait for the host to transmit a packet to it. 2. The received packet will be pushed into the RX FIFO along with a packet status entry. 3. If the transaction was unsuccessful (e.g., due to a full RX FIFO), the endpoint will automatically NAK the incoming packet.
IN Transactions	
<ol style="list-style-type: none"> 1. Software specifies the expected size of the data packet and the number of packets (1 data packet) in the USB_HCTSIZ_n_REG register, then enables the channel. 2. The controller core will automatically write a request into the appropriate request queue. 3. If the transaction was successful, the received data along with a status entry should be written to the RX FIFO. If the transaction was unsuccessful, an error interrupt (e.g., USB_H_NACK_n) will occur. 	<ol style="list-style-type: none"> 1. Software specifies the size of the data packet and the number of data packets (1 data packet) in the USB_DIEPTSIZ_n_REG register. Once the endpoint is enabled, it will wait for the host to read the packet. 2. When the packet has been transmitted, the USB_XFERCOMPL interrupt will be generated.

When operating at the transfer level in Slave mode, one or more transaction-level operations can be pipelined thus being analogous to transfer level operation in DMA mode. Within pipelined transactions, multiple packets of the same transfer can be read/written from the FIFOs in single instance, thus preventing the need for interrupting the software on a per-packet basis.

Operating on a transfer level in Slave mode is similar to operating on the transaction-level, except the transfer size and packet count for each transfer in the USB_HCTSIZ_n_REG or USB_DIEPTSIZ_n_REG register will need to be set to reflect the entire transfer. After the channel or endpoint is enabled, multiple data packets worth of payloads should be written to or read from the TX or RX FIFOs respectively (given that there is enough space or enough data).

32.4 OTG

USB OTG allows OTG devices to act in the USB Host role or the USB Device role. Thus, OTG devices will typically have a Mini-AB or Micro-AB receptacle so that it can receive an A-plug or B-plug. OTG devices will become either an A-device or a B-device depending on whether an A-plug or a B-plug is connected.

- A-device defaults to the Host role (A-Host) whilst B-device defaults to the Device role (B-Peripheral).
- A-device and B-device may exchange roles by using the Host Negotiation Protocol (HNP), thus becoming A-peripheral and B-Host.
- A-device can turn off Vbus to save power. B-device can then wake up the A-device by requesting it to turn on Vbus and start a new session. This mechanism is called session request protocol (SRP).
- A-device always powers Vbus even if it is an A-peripheral.

OTG devices are able to determine whether they are connected to an A plug or a B plug using the ID pin of the plugs. The ID pin in A-plugs are pulled to ground whilst B-plugs have the ID pin left floating.

32.4.1 OTG Interface

The OTG_FS supports both the Session Request Protocol (SRP) and Host Negotiation Protocol (HNP) of the OTG Revision 1.3 specification. The OTG_FS controller core interfaces with the transceiver (internal or external) using the UTMI+ OTG interface. The UTMI+ OTG interface allows the controller core to manipulate the transceiver for OTG purposes (e.g., enabling/disabling pull-ups and pull-downs in HNP), and also allows the transceiver to indicate OTG related events. If an external transceiver is used instead, the UTMI+ OTG interface signals will be routed to the ESP32-S3's GPIOs instead through GPIO Matrix, please refer to Chapter [6 IO MUX and GPIO Matrix \(GPIO, IO MUX\)](#). The UTMI+ OTG interface signals are described in Table 32-2.

Table 32-2. UTMI OTG Interface

Signal Name	I/O	Description
usb_otg_iddig_in	I	Mini A/B Plug Indicator. Indicates whether the connected plug is mini-A or mini-B. Valid only when usb_otg_idpullup is sampled asserted. 1'b0: Mini-A connected 1'b1: Mini-B connected
usb_otg_avalid_in	I	A-Peripheral Session Valid. Indicates if the voltage Vbus is at a valid level for an A-peripheral session. The comparator thresholds are: 1'b0: Vbus <0.8 V 1'b1: Vbus = 0.2 V to 2.0 V
usb_otg_bvalid_in	I	B-Peripheral Session Valid. Indicates if the voltage Vbus is at a valid level for a B-peripheral session. The comparator thresholds are: 1'b0: Vbus <0.8 V 1'b1: Vbus = 0.8 V to 4 V
usb_otg_vbusvalid_in	I	Vbus Valid. Indicates if the voltage Vbus is valid for A/B-device/peripheral operation. The comparator thresholds are: 1'b0: Vbus <4.4 V 1'b1: Vbus >4.75 V

Signal Name	I/O	Description
usb_srp_sessend_in	I	B-device Session End. Indicates if the voltage Vbus is below the B-device Session End threshold. The comparator thresholds are: 1'b0: Vbus >0.8 V 1'b1: Vbus <0.2 V
usb_otg_idpullup	O	Analog ID input Sample Enable. Enables sampling the analog ID line. 1'b0: ID pin sampling disabled 1'b1: ID pin sampling enabled
usb_otg_dppulldown	O	D+ Pull-down Resistor Enable. Enables the 15 kΩ pull-down resistor on the D+ line.
usb_otg_dmpulldown	O	D- Pull-down Resistor Enable. Enables the 15 kΩ pull-down resistor on the D- line.
usb_otg_drvvbus	O	Drive Vbus. Enables driving Vbus to 5 V. 1'b0: Do not drive Vbus 1'b1: Drive Vbus
usb_srp_chrgvbus	O	Vbus Input Charge Enable. Directs the PHY to charge Vbus. 1'b0: Do not charge Vbus through a resistor 1'b1: Charge Vbus through a resistor (must be active for at least 30 ms)
usb_srp_dischrgvbus	O	Vbus Input Discharge Enable. Directs the PHY to discharge Vbus. 1'b0: Do not discharge Vbus through a resistor. 1'b1: Discharge Vbus through a resistor (must be active for at least 50 ms).

32.4.2 ID Pin Detection

Bit USB_CONIDSTS in register USB_GOTGCTL_REG indicates whether the OTG controller is an A-device (1'b0) or a B-device (1'b1). The USB_CONIDSTSCHNG interrupt will trigger whenever there is a change to USB_CONIDSTS (i.e., when a plug is connected or disconnected).

32.4.3 Session Request Protocol (SRP)

32.4.3.1 A-Device SRP

Figure 32-7 illustrates the flow of SRP when the OTG_FS is acting as an A-device (i.e., default host and the device that powers Vbus).

1. To save power, the application suspends and turns off port power when the bus is idle by writing to the Port Suspend (USB_PRTSUSP to 1'b0) and Port Power (USB_P RTPWR to 1'b0) bits in the Host Port Control and Status register.
2. PHY indicates port power off by deasserting the usb_otg_vbusvalid_in signal.
3. The A-device must detect SE0 for at least 2 ms to start SRP when Vbus power is off.
4. To initiate SRP, the B-device turns on its data line pull-up resistor for 5 to 10 ms. The OTG_FS core detects data-line pulsing.
5. The device drives Vbus above the A-device session valid (2.0 V minimum) for Vbus pulsing. The OTG_FS core interrupts the application on detecting SRP. The Session Request Detected bit (USB_SESSREQINT) is set in Global Interrupt Status register.

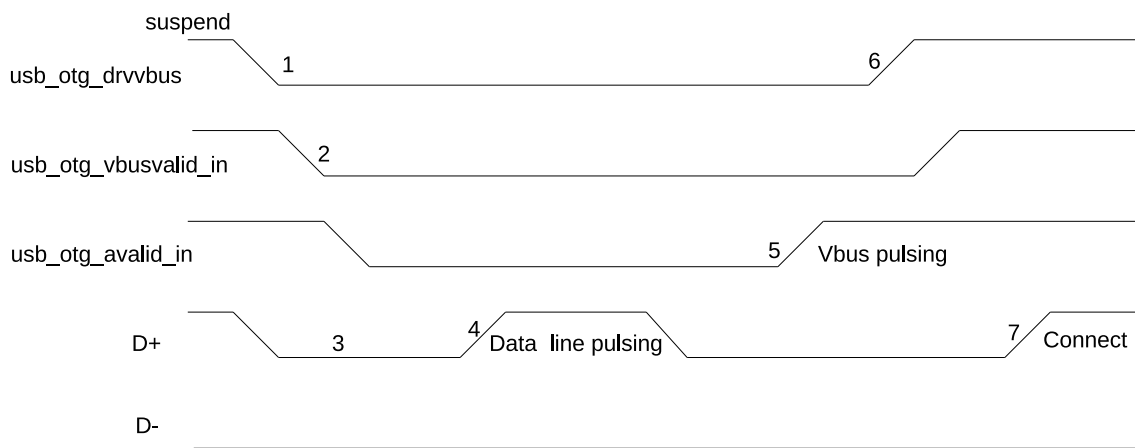

Figure 32-7. A-Device SRP

- The application must service the Session Request Detected interrupt and turn on the Port Power bit by writing the Port Power bit in the Host Port Control and Status register. The PHY indicates port power-on by asserting `usb_otg_vbusvalid_in` signal.
- When the USB is powered, the B-device connects, completing the SRP process.

32.4.3.2 B-Device SRP

Figure 32-8 illustrates the flow of SRP when the OTG_FS is acting as a B-device (i.e., does not power Vbus).

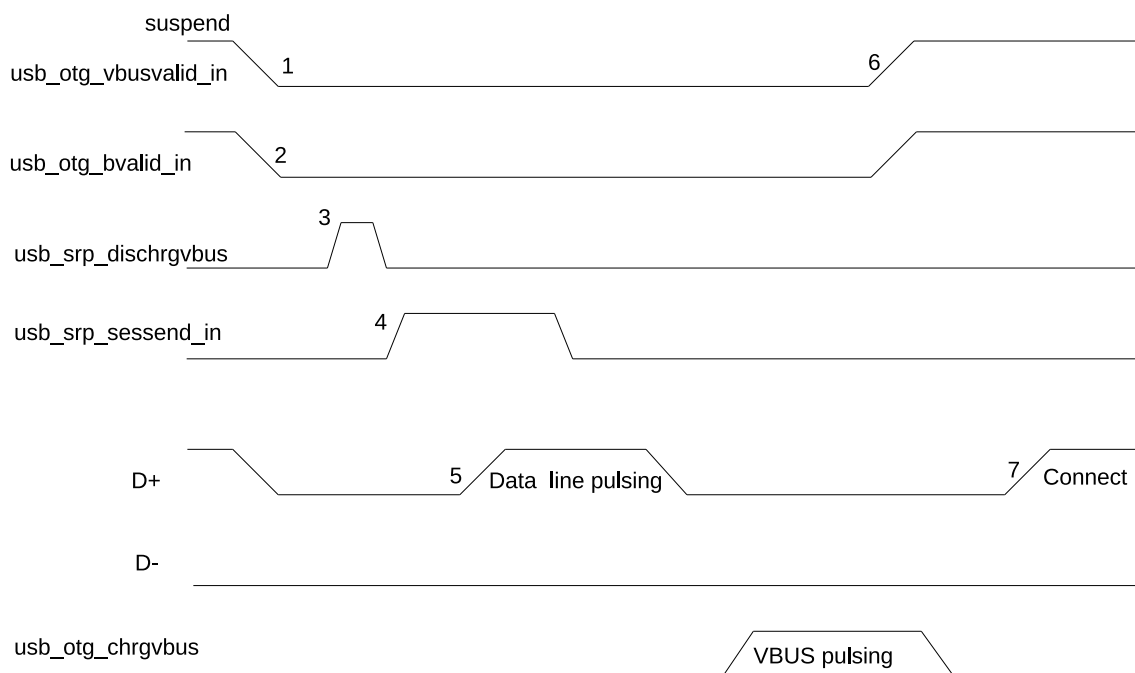

Figure 32-8. B-Device SRP

- To save power, the host (A-device) suspends and turns off port power when the bus is idle. PHY indicates port power off by deasserting the `usb_otg_vbusvalid_in` signal. The OTG_FS core sets the Early Suspend bit in the Core Interrupt register (USB_ERLYSUSP interrupt) after detecting 3 ms of bus idleness. Following this, the OTG_FS core sets the USB Suspend bit (USB_USBSUSP) in the Core Interrupt register. The PHY

indicates the end of the B-device session by deasserting the `usb_otg_bvalid_in` signal.

2. The OTG_FS core asserts the `usb_otg_dischrgvbus` signal to indicate to the PHY to speed up Vbus discharge.
3. The PHY indicates the session's end by asserting the `usb_otg_sessend_in` signal. This is the initial condition for SRP. The OTG_FS core requires 2 ms of SE0 before initiating SRP. For a USB 2.0 full-speed serial transceiver, the application must wait until Vbus discharges to 0.2 V after `USB_BSESVLD` is deasserted.
4. The application waits for 1.5 seconds (`TB_SE0_SRP` time) before initiating SRP by writing the Session Request bit (`USB_SESREQ`) in the OTG Control and Status register. The OTG_FS core performs data-line pulsing followed by Vbus pulsing.
5. The host (A-device) detects SRP from either the data-line or Vbus pulsing, and turns on Vbus. The PHY indicates Vbus power-on by asserting `usb_otg_vbusvalid_in`.
6. The OTG_FS core performs Vbus pulsing by asserting `usb_srp_chrgvbus`. The host (A-device) starts a new session by turning on Vbus, indicating SRP success. The OTG_FS core interrupts the application by setting the Session Request Success Status Change bit (`USB_SESREQSC`) in the OTG Interrupt Status register. The application reads the Session Request Success bit in the OTG Control and Status register.
7. When the USB is powered, the OTG_FS core connects, completing the SRP process.

32.4.4 Host Negotiation Protocol (HNP)

32.4.4.1 A-Device HNP

Figure 32-9 illustrates the flow of HNP when the OTG_FS is acting as an A-device.

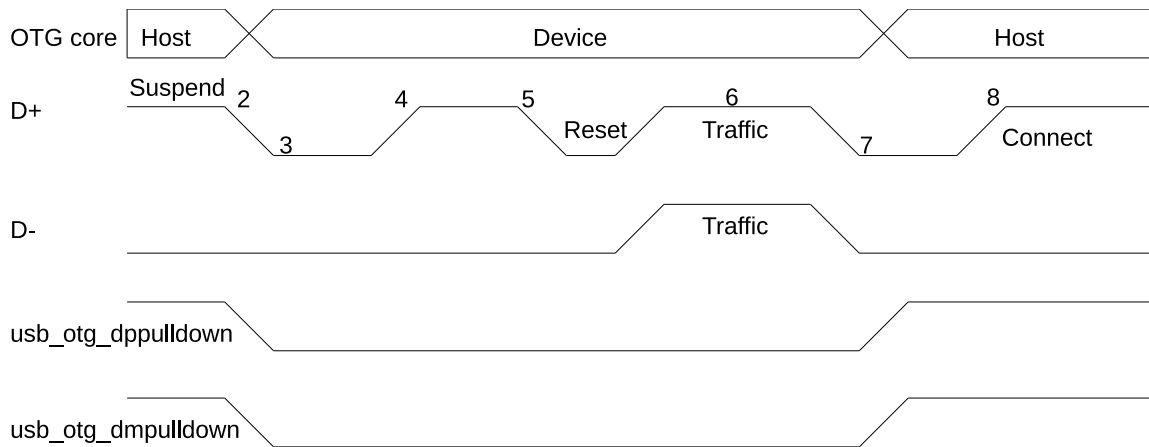

Figure 32-9. A-Device HNP

1. The OTG_FS core sends the B-device a SetFeature `b_hnp_enable` descriptor to enable HNP support. The B-device's ACK response indicates that the B-device supports HNP. The application must set Host Set HNP Enable bit (`USB_HSTSETHNPEN`) in the OTG Control and Status register to indicate to the OTG_FS core that the B-device supports HNP.
2. When it has finished using the bus, the application suspends by writing the Port Suspend bit (`USB_PRTSUSP`) in the Host Port Control and Status register.
3. When the B-device observes a USB suspend, it disconnects, indicating the initial condition for HNP. The B-device initiates HNP only when it must switch to the host role; otherwise, the bus continues to be

suspended. The OTG_FS core sets the Host Negotiation Detected interrupt (USB_HSTNEGDET) in the OTG Interrupt Status register, indicating the start of HNP. The OTG_FS core deasserts the `usb_otg_dppulldown` and `usb_otg_dmpulldown` signals to indicate a device role. The PHY enables the D+ pull-up resistor, thus indicates a connection for the B-device. The application must read the Current Mode bit (USB_CURMOD_INT) in the OTG Control and Status register to determine Device mode operation.

4. The B-device detects the connection, issues a USB reset, and enumerates the OTG_FS core for data traffic.
5. The B-device continues the host role, initiating traffic, and suspends the bus when done. The OTG_FS core sets the Early Suspend bit (USB_ERLYSUSP) in the Core Interrupt register after detecting 3 ms of bus idleness. Following this, the OTG_FS core sets the USB Suspend bit (USB_USBSUSP) in the Core Interrupt register.
6. In Negotiated mode, the OTG_FS core detects the suspend, disconnects, and switches back to the host role. The OTG_FS core asserts the `usb_otg_dppulldown` and `usb_otg_dmpulldown` signals to indicate its assumption of the host role.
7. The OTG_FS core sets the Connector ID Status Change interrupt (USB_CONIDSTS) in the OTG Interrupt Status register. The application must read the connector ID status in the OTG Control and Status register to determine the OTG_FS core's operation as an A-device. This indicates the completion of HNP to the application. The application must read the Current Mode bit in the OTG Control and Status register to determine Host mode operation.
8. The B-device connects, completing the HNP process.

32.4.4.2 B-Device HNP

Figure 32-10 illustrates the flow of HNP when the OTG_FS is acting as an B-device.

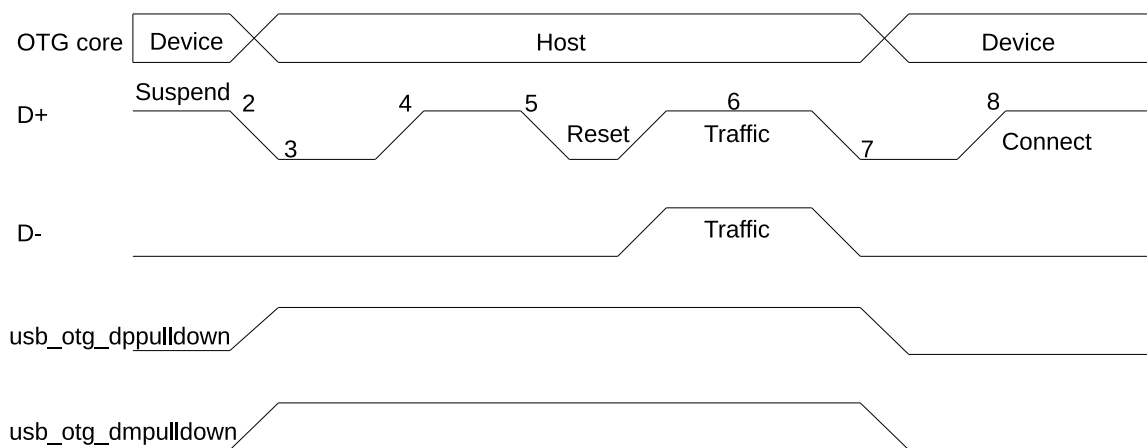

Figure 32-10. B-Device HNP

1. The A-device sends the SetFeature `b_hnp_enable` descriptor to enable HNP support. The OTG_FS core's ACK response indicates that it supports HNP. The application must set the Device HNP Enable bit (USB_DEVHNPEN) in the OTG Control and Status register to indicate HNP support. The application sets the HNP Request bit (USB_DEVHNPEN) in the OTG Control and Status register to indicate to the OTG_FS core to initiate HNP.
2. When A-device has finished using the bus, it suspends the bus.

- (a) The OTG_FS core sets the Early Suspend bit (USB_ERLYSUSP) in the Core Interrupt register after 3 ms of bus idleness. Following this, the OTG_FS core sets the USB Suspend bit (USB_USBSUSP) in the Core Interrupt register. The OTG_FS core disconnects and the A-device detects SE0 on the bus, indicating HNP.
 - (b) The OTG_FS core asserts the `usb_otg_dppulldown` and `usb_otg_dmpulldown` signals to indicate its assumption of the host role.
 - (c) The A-device responds by activating its D+ pull-up resistor within 3 ms of detecting SE0. The OTG_FS core detects this as a connect.
 - (d) The OTG_FS core sets the Host Negotiation Success Status Change interrupt in the OTG Interrupt Status register (USB_CONIDSTS), indicating the HNP status. The application must read the Host Negotiation Success bit (USB_HSTNEGSCS) in the OTG Control and Status register to determine host negotiation success. The application must read the Current Mode bit (USB_CURMOD_INT) in the Core Interrupt register to determine Host mode operation.
3. Program the USB_PRTPWR bit to 1'b1. This drives Vbus on the USB.
 4. Wait for the USB_PRTCONDET interrupt. This indicates that a device is connected to the port.
 5. The application sets the reset bit (USB_PRTRST) and the OTG_FS core issues a USB reset and enumerates the A-device for data traffic.
 6. Wait for the USB_PRTENCHNG interrupt.
 7. The OTG_FS core continues the host role of initiating traffic, and when done, suspends the bus by writing the Port Suspend bit (USB_PRTSUSP) in the Host Port Control and Status register.
 8. In Negotiated mode, when the A-device detects a suspend, it disconnects and switches back to the host role. The OTG_FS core deasserts the `usb_otg_dppulldown` and `usb_otg_dmpulldown` signals to indicate the assumption of the device role.
 9. The application must read the Current Mode bit (USB_CURMOD_INT) in the Core Interrupt register to determine the Host mode operation.
 10. The OTG_FS core connects, completing the HNP process.

33 USB Serial/JTAG Controller (USB_SERIAL_JTAG)

The ESP32-S3 contains an USB Serial/JTAG Controller. This unit can be used to program the SoC's flash, read program output, as well as attach a debugger to the running program. All of these are possible for any computer with a USB host ('host' in the rest of this text) without any active external components.

33.1 Overview

The workflow of developing on previous versions of Espressif chips generally use two methods of communication with the SoC: one is a serial port and the other is the JTAG debugging port. The serial port is a two-wire interface traditionally used to push new firmware-under-development to the chip ('programming'). As most modern computers do not have a compatible serial port anymore, interfacing to this serial port requires an USB-to-serial converter IC or board. After programming is finished, the port is used to monitor any debugging output from the program, in order to keep an eye on the general state of program execution. When program execution is not what the developer expects (i.e. the program crashes), the JTAG debugging port is then used to inspect the state of the program and its variables and set break- and watchpoints. This requires interfacing with the JTAG debug port, which generally requires an external JTAG adapter.

All these external interfaces take up six pins in total, which cannot be used for other purposes while debugging. Especially on devices with small packages, like the ESP32-S3, not being able to use these pins can be limiting to a design.

In order to alleviate this issue, as well as to negate the need for external devices, the ESP32-S3 contains an USB Serial/JTAG Controller, which integrates the functionality of both an USB-to-serial converter as well as those of an USB-to-JTAG adapter. As this device directly interfaces to an external USB host using only the two data lines required by USB Specification 2.0, debugging the ESP32-S3 only requires two pins to be dedicated to this functionality.

33.2 Features

- USB Full-speed device.
- Can be configured to either use internal USB PHY of ESP32-S3 or external PHY via GPIO matrix.
- Fixed function device, hardwired for CDC-ACM (Communication Device Class - Abstract Control Model) and JTAG adapter functionality.
- 2 OUT Endpoints, 3 IN Endpoints in addition to Control Endpoint 0; Up to 64-byte data payload size.
- Internal PHY, so no or very few external components needed to connect to a host computer.
- CDC-ACM adherent serial port emulation is plug-and-play on most modern OSes.
- JTAG interface allows fast communication with CPU debug core using a compact representation of JTAG instructions.
- CDC-ACM supports host controllable chip reset and entry into download mode.

As shown in Figure 33-1, the USB Serial/JTAG Controller consists of an USB PHY, a USB device interface, a JTAG command processor and a response capture unit, as well as the CDC-ACM registers. The PHY and part of the device interface are clocked from a 48 MHz clock derived from the main PLL, the rest of the logic is clocked from APB_CLK. The JTAG command processor is connected to the JTAG debug unit of the main processor; the

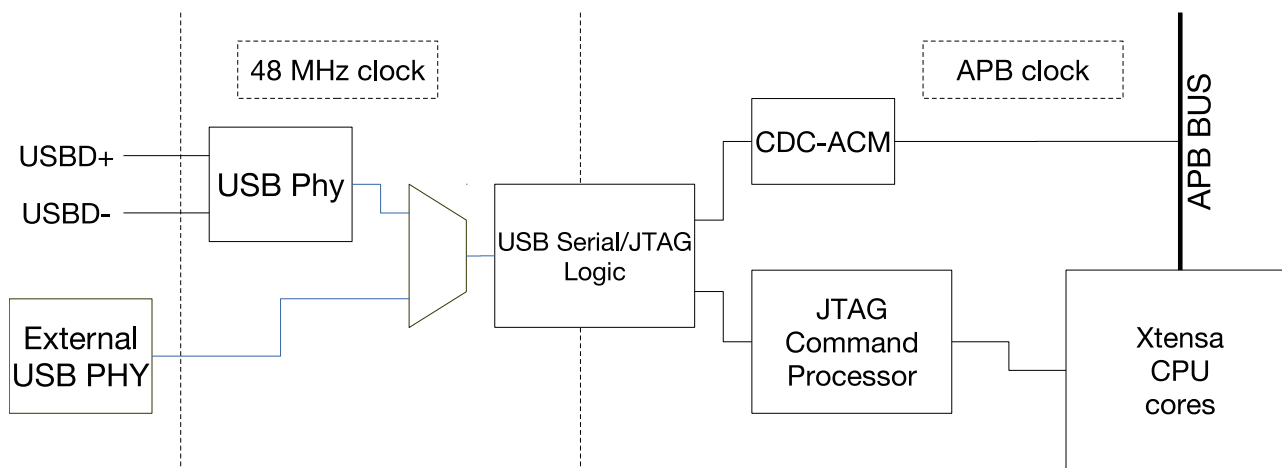

Figure 33-1. USB Serial/JTAG High Level Diagram

CDC-ACM registers are connected to the APB bus and as such can be read from and written to by software running on the main CPU.

Note that while the USB Serial/JTAG device is a USB 2.0 device, it only supports Full-speed (12 Mbps) and not the High-speed (480 Mbps) mode the USB 2.0 standard introduced.

Figure 33-2 shows the internal details of the USB Serial/JTAG controller on the USB side. The USB Serial/JTAG Controller consists of an USB 2.0 Full Speed device. It contains a control endpoint, a dummy interrupt endpoint, two bulk input endpoints as well as two bulk output endpoints. Together, these form an USB Composite device, which consists of an CDC-ACM USB class device as well as a vendor-specific device implementing the JTAG interface. On the SoC side, the JTAG interface is directly connected to the debugging interface of the two Xtensa CPUs, allowing debugging of programs running on that core. Meanwhile, the CDC-ACM device is exposed as a set of registers, allowing a program on the CPU to read and write from this. Additionally, the ROM startup code of the SoC contains code allowing the user to reprogram attached flash memory using this interface.

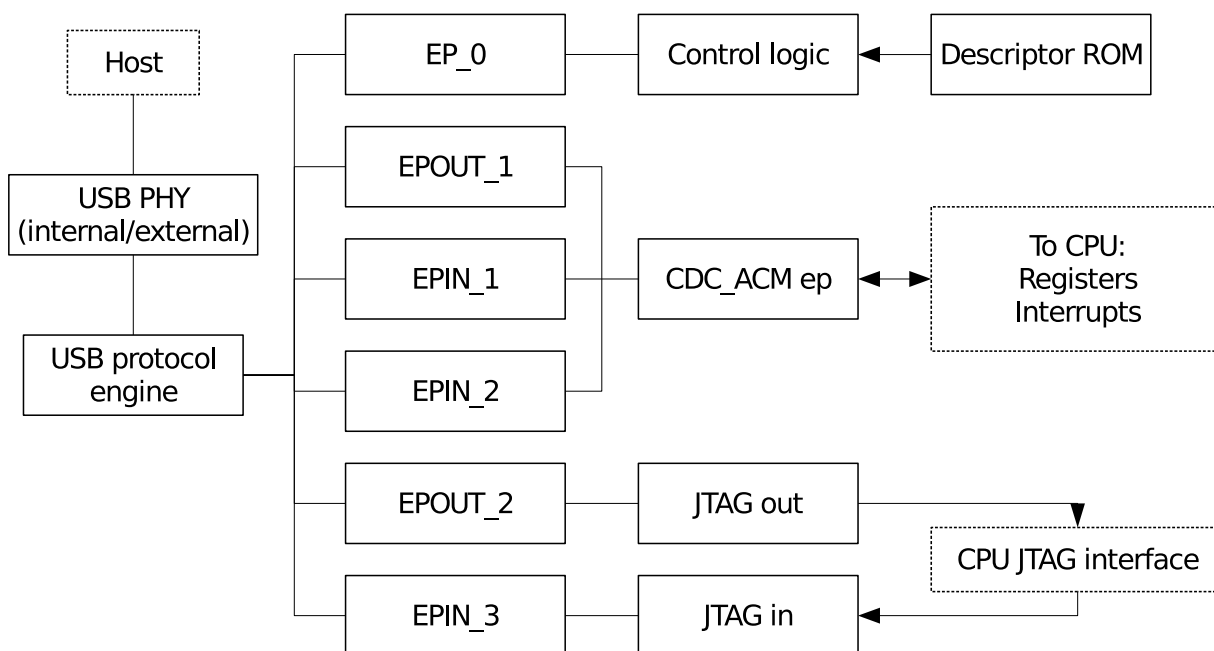

Figure 33-2. USB Serial/JTAG Block Diagram

33.3 Functional Description

The USB Serial/JTAG Controller interfaces with an USB host processor on one side, and the CPU debug hardware as well as the software running on the USB port on the other side.

33.3.1 USB Serial/JTAG host connection

As shown in Figure 33-3, interfacing with an USB host connection on the physical level is done with a PHY. The ESP32-S3 has an internal PHY, which is shared between the USB-OTG and the USB Serial/JTAG hardware. Either one of these can use the internal PHY. Optionally, the signals from the unit not using the internal PHY can be routed out via the GPIO matrix to IO pads. Adding an external USB PHY to these pads results in a second usable USB port.

The actual routing from USB Serial/JTAG Controller and USB-OTG to internal and external PHYs initially is decided using eFuses as described in Table 33-6. This configuration can later be modified using register writes.

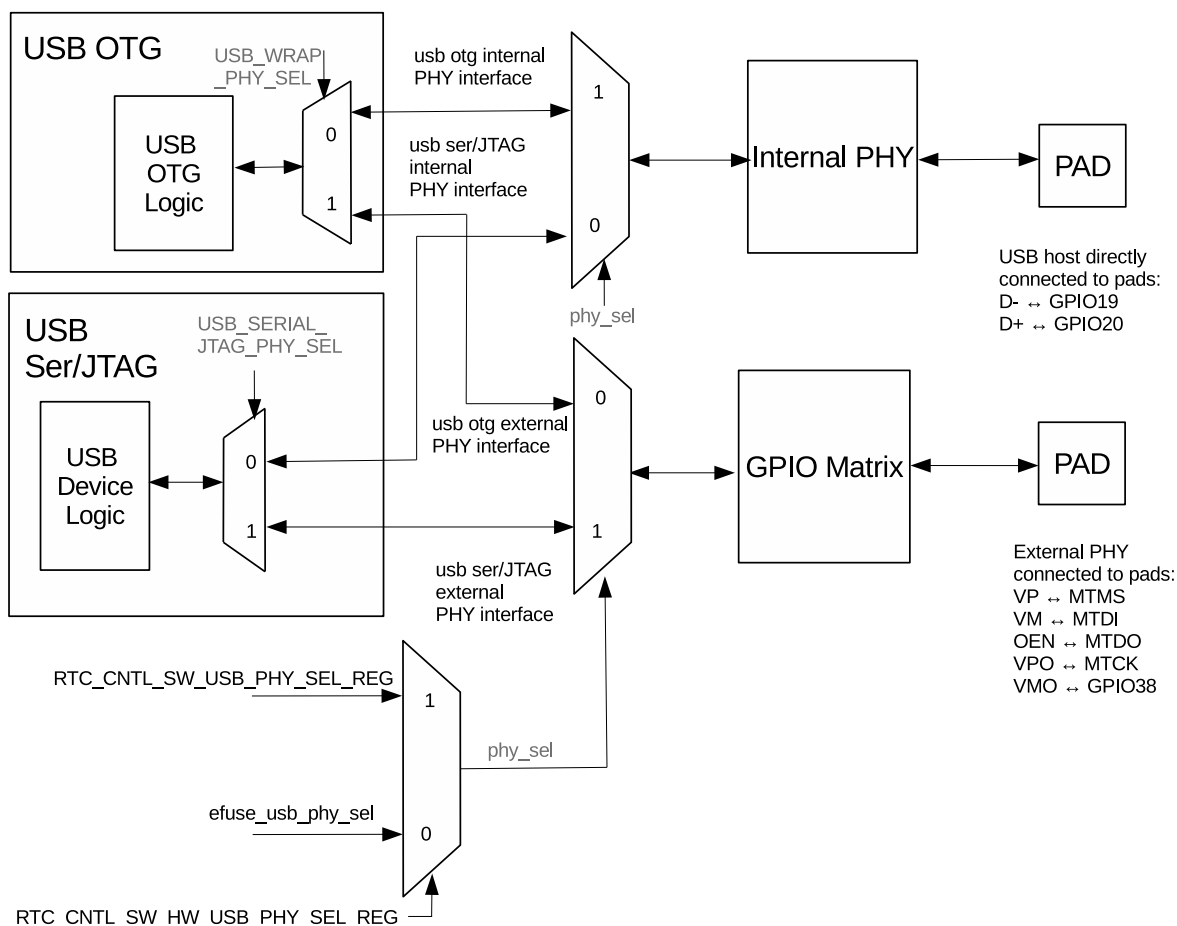

Figure 33-3. USB Serial/JTAG and USB-OTG Internal/External PHY Routing Diagram

The CPU JTAG signals can be routed to the USB Serial/JTAG Controller or external GPIO pads using eFuses and when the user program has started, software control as well. At that time, the JTAG signals from the USB Serial/JTAG can also be routed to the GPIO matrix. This allows debugging a secondary SoC via JTAG using the ESP32-S3 USB Serial/JTAG Controller.

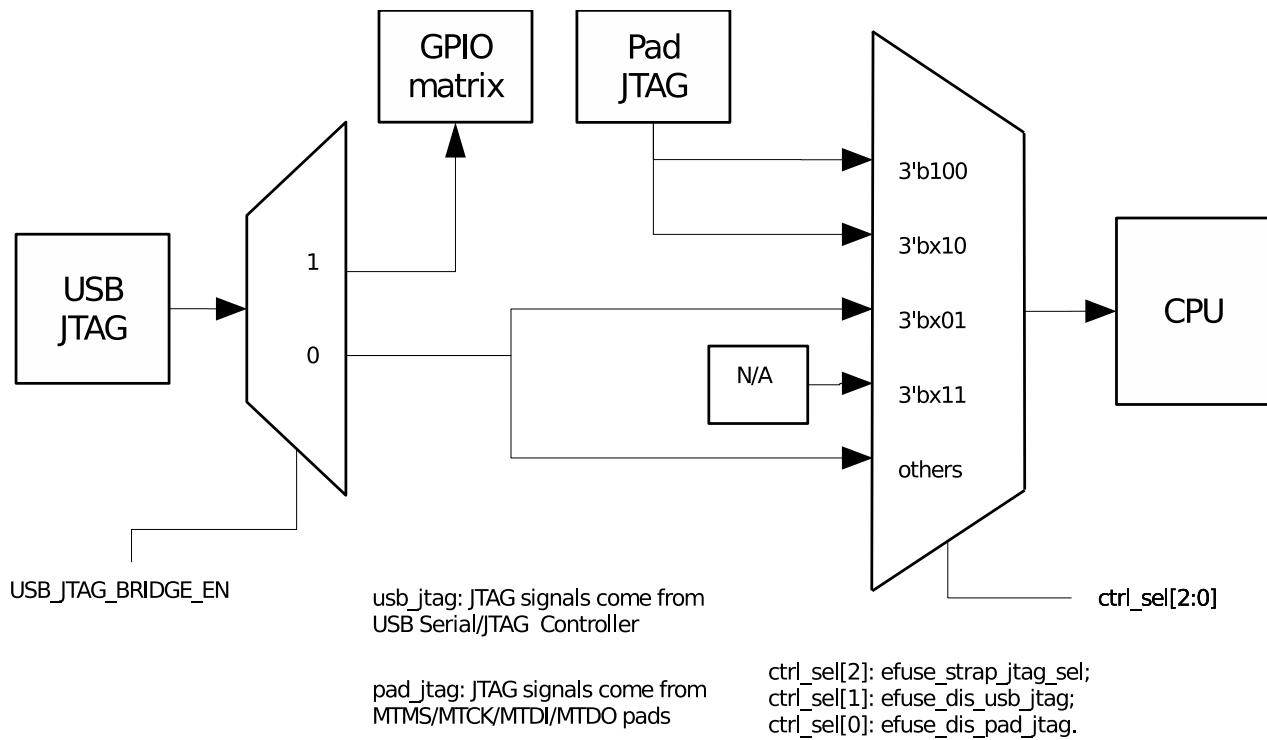

Figure 33-4. JTAG Routing Diagram

33.3.2 CDC-ACM USB Interface Functional Description

The CDC-ACM interface adheres to the standard USB CDC-ACM class for serial port emulation. It contains a dummy interrupt endpoint (which will never send any events, as they are not implemented nor needed) and a Bulk IN as well as a Bulk OUT endpoint for the host's received and sent serial data respectively. These endpoints can handle 64-byte packets at a time, allowing for high throughput. As CDC-ACM is a standard USB device class, a host generally does not need any special installation procedures for it to function: when the USB debugging device is properly connected to a host, the operating system should show a new serial port moments later.

The CDC-ACM interface accepts the following standard CDC-ACM control requests:

Table 33-1. Standard CDC-ACM Control Requests

Command	Action
SEND_BREAK	Accepted but ignored (dummy)
SET_LINE_CODING	Accepted but ignored (dummy)
GET_LINE_CODING	Always returns 9600 baud, no parity, 8 databits, 1 stopbit
SET_CONTROL_LINE_STATE	Set the state of the RTS/DTR lines, see Table 33-2

Aside from general-purpose communication, the CDC-ACM interface also can be used to reset the ESP32-S3 and optionally make it go into download mode in order to flash new firmware. This is done by setting the RTS and DTR lines on the virtual serial port.

Table 33-2. CDC-ACM Settings with RTS and DTR

RTS	DTR	Action
0	0	Clear download mode flag
0	1	Set download mode flag
1	0	Reset ESP32-S3
1	1	No action

Note that if the download mode flag is set when the ESP32-S3 is reset, the ESP32-S3 will reboot into download mode. When this flag is cleared and the chip is reset, the ESP32-S3 will boot from flash. For specific sequences, please refer to Section 33.4. All these functions can also be disabled by programming various eFuses, please refer to Chapter 5 *eFuse Controller* for more details.

33.3.3 CDC-ACM Firmware Interface Functional Description

As the USB Serial/JTAG Controller is connected to the internal APB bus of the ESP32-S3, the CPU can interact with it. This is mainly used to read and write data from and to the virtual serial port on the attached host.

USB CDC-ACM serial data is sent to and received from the host in packets of 0 to 64 bytes in size. When enough CDC-ACM data has accumulated in the host, the host will send a packet to the CDC-ACM receive endpoint, and when the USB Serial/JTAG Controller has a free buffer, it will accept this packet. Conversely, the host will check periodically if the USB Serial/JTAG Controller has a packet ready to be sent to the host, and if so, receive this packet.

Firmware can get notified of new data from the host in one of two ways. First of all, the [USB_SERIAL_JTAG_SERIAL_OUT_EP_DATA_AVAIL](#) bit will remain set to 1 as long as there still is unread host data in the buffer. Secondly, the availability of data will trigger the [USB_SERIAL_JTAG_SERIAL_OUT_RECV_PKT_INT](#) interrupt as well.

When data is available, it can be read by firmware by repeatedly reading bytes from [USB_SERIAL_JTAG_EP1_REG](#). The amount of bytes to read can be determined by checking the [USB_SERIAL_JTAG_SERIAL_OUT_EP_DATA_AVAIL](#) bit after reading each byte to see if there is more data to read. After all data is read, the USB debug device is automatically readied to receive a new data packet from the host.

When the firmware has data to send, it can do so by putting it in the send buffer and triggering a flush, allowing the host to receive the data in a USB packet. In order to do so, there needs to be space available in the send buffer. Firmware can check this by reading [USB_REG_SERIAL_IN_EP_DATA_FREE](#); a 1 in this register field indicates there is still free room in the buffer. While this is the case, firmware can fill the buffer by writing bytes to the [USB_SERIAL_JTAG_EP1_REG](#) register.

Writing the buffer doesn't immediately trigger sending data to the host. This does not happen until the buffer is flushed; a flush causes the entire buffer to be readied for reception by the USB host at once. A flush can be triggered in two ways: after the 64th byte is written to the buffer, the USB hardware will automatically flush the buffer to the host. Alternatively, firmware can trigger a flush by writing a 1 to [USB_REG_SERIAL_WR_DONE](#).

Regardless of how a flush is triggered, the send buffer will be unavailable for firmware to write into until it has been fully read by the host. As soon as this happens, the [USB_SERIAL_JTAG_SERIAL_IN_EMPTY_INT](#) interrupt will be triggered, indicating the send buffer can receive another 64 bytes.

33.3.4 USB-to-JTAG Interface

The USB-to-JTAG interface uses a vendor-specific class for its implementation. It consists of two endpoints, one to receive commands and one to send responses. Additionally, some less time-sensitive commands can be given as control requests.

33.3.5 JTAG Command Processor

Commands from the host to the JTAG interface are interpreted by the JTAG command processor. Internally, the JTAG command processor implements a full four-wire JTAG bus, consisting of the TCK, TMS and TDI output lines to the Xtensa CPUs, as well as the TDO line signalling back from the CPU to the JTAG response capture unit. These signals adhere to the IEEE 1149.1 JTAG standards. Additionally, there is a SRST line to reset the SoC.

The JTAG command processor parses each received nibble (4-bit value) as a command. As USB data is received in 8-bit bytes, this means each byte contains two commands. The USB command processor will execute high-nibble first and low-nibble second. The commands are used to control the TCK, TMS, TDI, and SRST lines of the internal JTAG bus, as well as signal the JTAG response capture unit that the state of the TDO line (which is driven by the CPU debug logic) needs to be captured.

Of this internal JTAG bus, TCK, TMS, TDI and TDO are connected directly to the JTAG debugging logic of the Xtensa CPUs. SRST is connected to the reset logic of the digital circuitry in the SoC and a high level on this line will cause a digital system reset. Note that the USB Serial/JTAG Controller itself is not affected by SRST.

A nibble can contain the following commands:

Table 33-3. Commands of a Nibble

bit	3	2	1	0
CMD_CLK	0	cap	tms	tdi
CMD_RST	1	0	0	srst
CMD_FLUSH	1	0	1	0
CMD_RSV	1	0	1	1
CMD_REP	1	1	R1	R0

- CMD_CLK will set the TDI and TMS to the indicated values and emit one clock pulse on TCK. If the CAP bit is 1, it will also instruct the JTAG response capture unit to capture the state of the TDO line. This instruction forms the basis of JTAG communication.
- CMD_RST will set the state of the SRST line to the indicated value. This can be used to reset the ESP32-S3.
- CMD_FLUSH will instruct the JTAG response capture unit to flush the buffer of all bits it collected so the host is able to read them. Note that in some cases, a JTAG transaction will end in an odd number of commands and as such an odd number of nibbles. In this case, it is allowable to repeat the CMD_FLUSH to get an even number of nibbles fitting an integer number of bytes.
- CMD_RSV is reserved in the current implementation. The ESP32-S3 will ignore this command when it receives it.
- CMD_REP repeats the last (non-CMD_REP) command a certain number of times. It's intended goal is to compress command streams which repeat the same CMD_CLK instruction multiple times. A command like

CMD_CLK can be followed by multiple CMD_REP commands. The number of repetitions done by one CMD_REP can be expressed as $no_repetitions = (R1 \times 2 + R0) \times (4^{cmd_rep_count})$, where `cmd_rep_count` is how many CMD_REP instructions went directly before it. Note that the CMD_REP is only intended to repeat a CMD_CLK command. Specifically, using it on a CMD_FLUSH command may lead to an unresponsive USB device, needing an USB reset to recover.

33.3.6 USB-to-JTAG Interface: CMD_REP usage example

Here is a list of commands as an illustration of the use of CMD_REP. Note each command is a nibble; in this example the bitwise command stream would be 0x0D 0x5E 0xCF.

1. 0x0 (CMD_CLK: cap=0, tdi=0, tms=0)
2. 0xD (CMD_REP: R1=0, R0=1)
3. 0x5 (CMD_CLK: cap=1, tdi=0, tms=1)
4. 0xE (CMD_REP: R1=1, R0=0)
5. 0xC (CMD_REP: R1=0, R0=0)
6. 0xF (CMD_REP: R1=1, R0=1)

This is what happens at every step:

1. TCK is clocked with the TDI and TMS lines set to 0. No data is captured.
2. TCK is clocked another $(0 \times 2 + 1) \times (4^0) = 1$ time with the same settings as step 1.
3. TCK is clocked with the TDI and TMS lines set to 0. Data on the TDO line is captured.
4. TCK is clocked another $(1 \times 2 + 0) \times (4^0) = 2$ times with the same settings as step 3.
5. Nothing happens: $(0 \times 2 + 0) \times (4^1) = 0$. Note that this does increase `cmd_rep_count` for the next step.
6. TCK is clocked another $(1 \times 2 + 1) \times (4^2) = 48$ times with the same settings as step 3.

In other words: This example stream has the same net effect as command 1 twice, then repeating command 3 for 51 times.

33.3.7 USB-to-JTAG Interface: Response Capture Unit

The response capture unit reads the TDO line of the internal JTAG bus and captures its value when the command parser executes a CMD_CLK with cap=1. It puts this bit into an internal shift register, and writes a byte into the USB buffer when 8 bits have been collected. Of these 8 bits, the least significant one is the one that is read from TDO the earliest.

As soon as either 64 bytes (512 bits) have been collected or a CMD_FLUSH command is executed, the response capture unit will make the buffer available for the host to receive. Note that the interface to the USB logic is double-buffered. This way, as long as USB throughput is sufficient, the response capture unit can always receive more data: while one of the buffers is waiting to be sent to the host, the other one can receive more data. When the host has received data from its buffer and the response capture unit flushes its buffer, the two buffers change position.

This also means that a command stream can cause at most 128 bytes of capture data to be generated (less if there are flush commands in the stream) without the host acting to receive the generated data. If more data is

generated anyway, the command stream is paused and the device will not accept more commands before the generated capture data is read out.

Note that in general, the logic of the response capture unit tries not to send zero-byte responses: for instance, sending a series of CMD_FLUSH commands will not cause a series of zero-byte USB responses to be sent. However, in the current implementation, some zero-byte responses may be generated in extraordinary circumstances. It's recommended to ignore these responses.

33.3.8 USB-to-JTAG Interface: Control Transfer Requests

Aside from the command processor and the response capture unit, the USB-to-JTAG interface also understands some control requests, as documented in the table below:

Table 33-4. USB-to-JTAG Control Requests

bmRequestType	bRequest	wValue	wIndex	wLength	Data
01000000b	0 (VEND_JTAG_SETDIV)	[divider]	interface	0	None
01000000b	1 (VEND_JTAG_SETIO)	[iobits]	interface	0	None
11000000b	2 (VEND_JTAG_GETTDO)	0	interface	1	[iostate]
10000000b	6 (GET_DESCRIPTOR)	0x2000	0	256	[jtag cap desc]

- VEND_JTAG_SETDIV sets the divider used. This directly affects the duration of a TCK clock pulse. The TCK clock pulses are derived from APB_CLK, which is divided down using an internal divider. This control request allows the host to set this divider. Note that on startup, the divider is set to 2, meaning the TCK clock rate will generally be 40 MHz.
- VEND_JTAG_SETIO can bypass the JTAG command processor to set the internal TDI, TDO, TMS and SRST lines to given values. These values are encoded in the wValue field in the format of 11'b0, srst, trst, tck, tms, tdi.
- VEND_JTAG_GETTDO can bypass the JTAG response capture unit to read the internal TDO signal directly. This request returns one byte of data, of which the least significant bit represents the status of the TDO line.
- GET_DESCRIPTOR is a standard USB request, however it can also be used with a vendor-specific wValue of 0x2000 to get the JTAG capabilities descriptor. This returns a certain amount of bytes representing the following fixed structure, which describes the capabilities of the USB-to-JTAG adapter. This structure allows host software to automatically support future revisions of the hardware without needing an update.

The JTAG capabilities descriptor of the ESP32-S3 is as follows. Note that all 16-bit values are little-endian.

Table 33-5. JTAG Capabilities Descriptor

Byte	Value	Description
0	1	JTAG protocol capabilities structure version
1	10	Total length of JTAG protocol capabilities
2	1	Type of this struct: 1 for speed capabilities struct
3	8	Length of this speed capabilities struct
4 ~ 5	8000	APB_CLK speed in 10 kHz increments. Note that the maximal TCK speed is half of this
6 ~ 7	1	Minimum divisor settable by the VEND_JTAG_SETDIV request
8 ~ 9	255	Maximum divisor settable by the VEND_JTAG_SETDIV request

33.4 Recommended Operation

33.4.1 Internal/external PHY selection

As the ESP32-S3 only has a single internal PHY, at first programming you may need to decide how that is going to be used in the intended application by burning eFuses to affect the initial USB configuration. This affects ROM download mode as well: while both USB-OTG as well as the USB Serial/JTAG controller allows serial programming, only USB-OTG supports the DFU protocol and only the USB Serial/JTAG controller supports JTAG debugging over USB. Even when not using USB, eFuse configuration is required when an external JTAG adapter will be used.

Table 33-6 indicates which eFuse to burn to get a certain boot-up configuration. Note that this is mostly relevant for the configuration in download mode and the bootloader as the configuration can be altered at runtime as soon as user code is running.

Table 33-6. Use cases and eFuse settings

Use case	eFuses	Note
USB serial/JTAG on internal PHY only	None	-
USB OTG on internal PHY only	EFUSE_USB_PHY_SEL + EFUSE_DIS_USB_JTAG	JTAG on GPIO pins
USB serial/JTAG on internal PHY, OTG on external PHY	None	-
USB OTG on internal PHY, USB serial/JTAG on external	EFUSE_USB_PHY_SEL	-

After the user program is running, it can modify the initial configuration by setting registers. Specifically, [RTC_CNTL_SW_HW_USB_PHY_SEL](#) can be used to have software override the effect of [EFUSE_USB_PHY_SEL](#): if this bit is set, the USB PHY selection logic will use the value of the [RTC_CNTL_SW_USB_PHY_SEL](#) bit in place of that of [EFUSE_USB_PHY_SEL](#).

As shown in 33-3, by default (`phy_sel = 0`), ESP32-S3 USB Serial/JTAG Controller is connected to internal PHY and USB-OTG is connected to external PHY. However, when USB-OTG Download mode is enabled, the chip initializes the IO pad connected to the external PHY in ROM when starts up. The status of each IO pad after initialization is as follows.

Table 33-7. IO Pad Status After Chip Initialization in the USB-OTG Download Mode

IO Pad	Input/Output Mode	Level Status
VP (MTMS)	INPUT	-
VM (MTDI)	INPUT	-
RCV (GPIO21)	INPUT	-
OEN (MTDO)	OUTPUT	HIGH
VPO (MTCK)	OUTPUT	LOW
VMO(GPIO38)	OUTPUT	LOW

If the USB-OTG Download mode is not needed, it is suggested to disable the USB-OTG Download mode by setting the eFuse bit [EFUSE_DIS_USB_OTG_DOWNLOAD_MODE](#) to avoid IO pad state change.

33.4.2 Runtime operation

There is very little setup needed in order to use the USB Serial/JTAG Device. The USB-to-JTAG hardware itself does not need any setup aside from the standard USB initialization the host operating system already does. The CDC-ACM emulation, on the host side, also is plug-and-play.

On the firmware side, very little initialization should be needed either: the USB hardware is self-initializing and after boot-up, if a host is connected and listening on the CDC-ACM interface, data can be exchanged as described above without any specific setup aside from the firmware optionally setting up an interrupt service handler.

One thing to note is that there may be situations where the host is either not attached or the CDC-ACM virtual port is not opened. In this case, the packets that are flushed to the host will never be picked up and the transmit buffer will never be empty. It is important to detect this and time out, as this is the only way to reliably detect that the port on the host side is closed.

Another thing to note is that the USB device is dependent on both the PLL for the 48 MHz USB PHY clock, as well as APB_CLK. Specifically, an APB_CLK of 40 MHz or more is required for proper USB compliant operation, although the USB device will still function with most hosts with an APB_CLK as low as 10 MHz. Behaviour shown when this happens is dependent on the host USB hardware and drivers, and can include the device being unresponsive and it disappearing when first accessed.

More specifically, the APB_CLK will be affected by clock gating the USB Serial/JTAG Controller, which may happen in Light-sleep. Additionally, the USB serial/JTAG Controller (as well as the attached Xtensa CPUs) will be entirely powered down in Deep-sleep mode. If a device needs to be debugged in either of these two modes, it may be preferable to use an external JTAG debugger and serial interface instead.

The CDC-ACM interface can also be used to reset the SoC and take it into or out of download mode. Generating the correct sequence of handshake signals can be a bit complicated: Most operating systems only allow setting or resetting DTR and RTS separately, and not in tandem. Additionally, some drivers (e.g. the standard CDC-ACM driver on Windows) do not set DTR until RTS is set and the user needs to explicitly set RTS in order to 'propagate' the DTR value. These are the recommended procedures:

To reset the SoC into download mode:

Table 33-8. Reset SoC into Download Mode

Action	Internal state	Note
Clear DTR	RTS=?, DTR=0	Initialize to known values
Clear RTS	RTS=0, DTR=0	-
Set DTR	RTS=0, DTR=1	Set download mode flag
Clear RTS	RTS=0, DTR=1	Propagate DTR
Set RTS	RTS=1, DTR=1	-
Clear DTR	RTS=1, DTR=0	Reset SoC
Set RTS	RTS=1, DTR=0	Propagate DTR
Clear RTS	RTS=0, DTR=0	Clear download flag

To reset the SoC into booting from flash:

Table 33-9. Reset SoC into Booting

Action	Internal state	Note
Clear DTR	RTS=?, DTR=0	-
Clear RTS	RTS=0, DTR=0	Clear download flag
Set RTS	RTS=1, DTR=0	Reset SoC
Clear RTS	RTS=0, DTR=0	Exit reset

33.5 Register Summary

The addresses in this section are relative to USB Serial/JTAG Controller base address provided in Table 4-3 in Chapter 4 *System and Memory*.

The abbreviations given in Column **Access** are explained in Section [Access Types for Registers](#).

Name	Description	Address	Access
Configuration Registers			
USB_SERIAL_JTAG_EP1_REG	Endpoint 1 FIFO register	0x0000	R/W
USB_SERIAL_JTAG_EP1_CONF_REG	Endpoint 1 configure and status register	0x0004	varies
USB_SERIAL_JTAG_CONF0_REG	Configure 0 register	0x0018	R/W
USB_SERIAL_JTAG_MISC_CONF_REG	MISC register	0x0044	R/W
USB_SERIAL_JTAG_MEM_CONF_REG	Memory power control	0x0048	R/W
USB_SERIAL_JTAG_TEST_REG	USB Internal PHY test register	0x001C	varies
Interrupt Registers			
USB_SERIAL_JTAG_INT_RAW_REG	Raw status interrupt	0x0008	R/WTC/SS
USB_SERIAL_JTAG_INT_ST_REG	Masked interrupt	0x000C	RO
USB_SERIAL_JTAG_INT_ENA_REG	Interrupt enable bits	0x0010	R/W
USB_SERIAL_JTAG_INT_CLR_REG	Interrupt clear bits	0x0014	WT
Status Registers			
USB_SERIAL_JTAG_JFIFO_ST_REG	USB-JTAG FIFO status	0x0020	varies
USB_SERIAL_JTAG_FRAM_NUM_REG	SOF frame number	0x0024	RO
USB_SERIAL_JTAG_IN_EP0_ST_REG	IN Endpoint 0 status	0x0028	RO
USB_SERIAL_JTAG_IN_EP1_ST_REG	IN Endpoint 1 status	0x002C	RO
USB_SERIAL_JTAG_IN_EP2_ST_REG	IN Endpoint 2 status	0x0030	RO
USB_SERIAL_JTAG_IN_EP3_ST_REG	IN Endpoint 3 status	0x0034	RO
USB_SERIAL_JTAG_OUT_EP0_ST_REG	OUT Endpoint 0 status	0x0038	RO
USB_SERIAL_JTAG_OUT_EP1_ST_REG	OUT Endpoint 1 status	0x003C	RO
USB_SERIAL_JTAG_OUT_EP2_ST_REG	OUT Endpoint 2 status	0x0040	RO
Version Register			
USB_SERIAL_JTAG_DATE_REG	Version control register	0x0080	R/W

33.6 Registers

The addresses in this section are relative to USB Serial/JTAG Controller base address provided in Table 4-3 in Chapter 4 *System and Memory*.

Register 33.1. USB_SERIAL_JTAG_EP1_REG (0x0000)

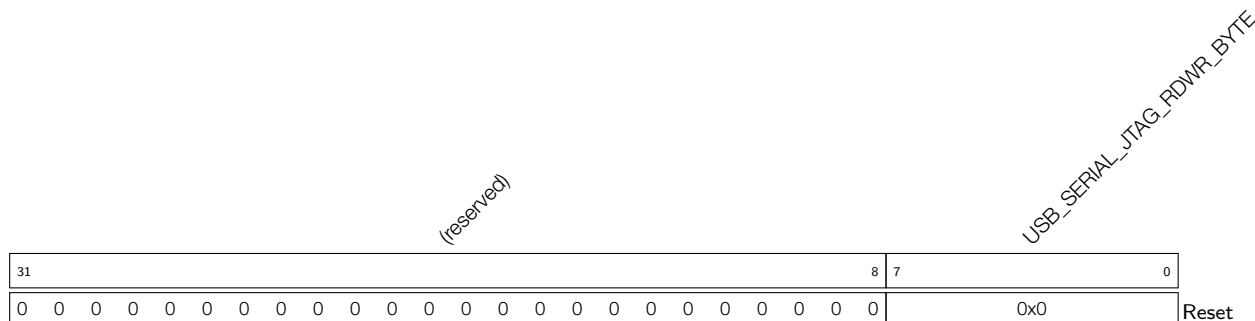

USB_SERIAL_JTAG_RDWR_BYTE Write and read byte data to/from UART Tx/Rx FIFO through this field. When USB_SERIAL_JTAG_SERIAL_IN_EMPTY_INT is set, then user can write data (up to 64 bytes) into UART Tx FIFO. When USB_SERIAL_JTAG_SERIAL_OUT_RECV_PKT_INT is set, user can check USB_SERIAL_JTAG_OUT_EP1_WR_ADDR USB_SERIAL_JTAG_OUT_EP1_RD_ADDR to know how many data is received, then read data from UART Rx FIFO. (R/W)

Register 33.2. USB_SERIAL_JTAG_EP1_CONF_REG (0x0004)

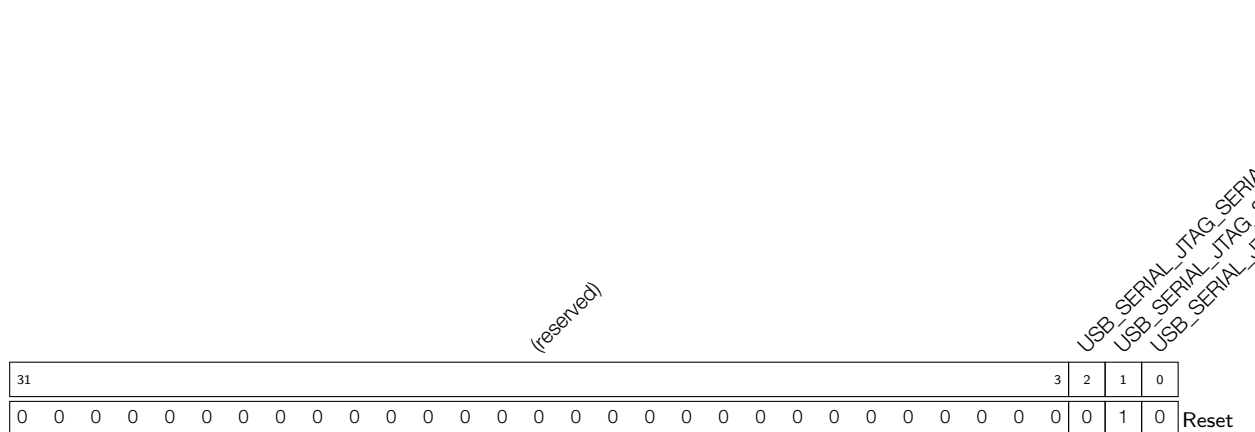

USB_SERIAL_JTAG_WR_DONE Set this bit to indicate writing byte data to UART Tx FIFO is done. (WT)

USB_SERIAL_JTAG_SERIAL_IN_EP_DATA_FREE 1'b1: Indicate UART Tx FIFO is not full and can write data into in. After writing USB_SERIAL_JTAG_WR_DONE, this bit would be 1'b0 until data in UART Tx FIFO is read by USB Host. (RO)

USB_SERIAL_JTAG_SERIAL_OUT_EP_DATA_AVAIL 1'b1: Indicate there is data in UART Rx FIFO. (RO)

Register 33.6. USB_SERIAL_JTAG_INT_RAW_REG (0x0008)

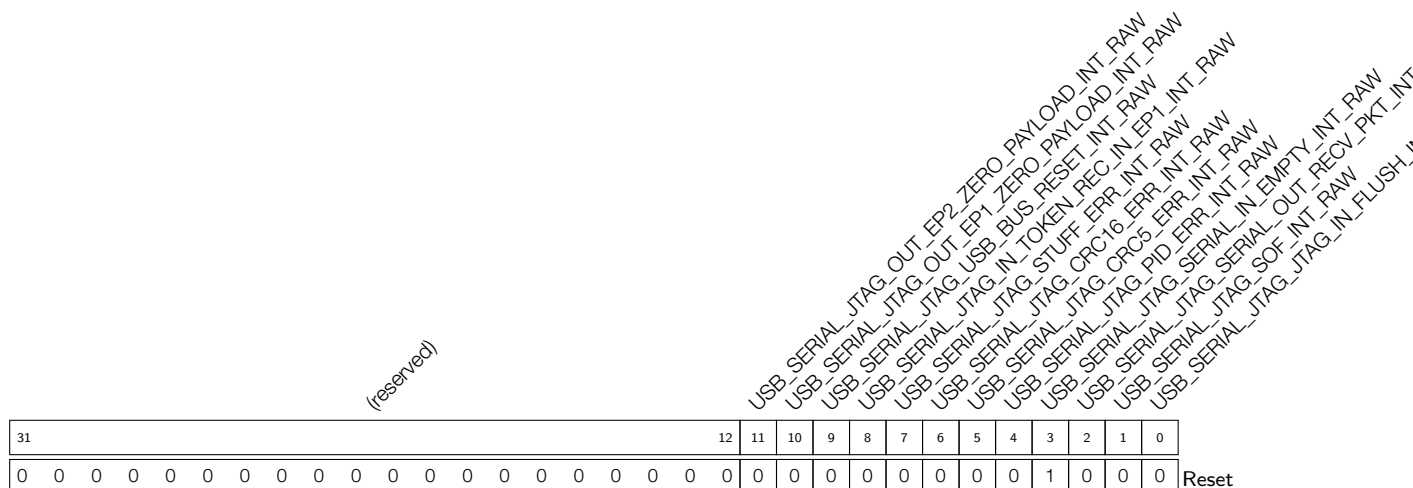

USB_SERIAL_JTAG_JTAG_IN_FLUSH_INT_RAW The raw interrupt bit turns to high level when flush cmd is received for IN endpoint 2 of JTAG. (R/WTC/SS)

USB_SERIAL_JTAG_SOF_INT_RAW The raw interrupt bit turns to high level when SOF frame is received. (R/WTC/SS)

USB_SERIAL_JTAG_SERIAL_OUT_RECV_PKT_INT_RAW The raw interrupt bit turns to high level when Serial Port OUT Endpoint received one packet. (R/WTC/SS)

USB_SERIAL_JTAG_SERIAL_IN_EMPTY_INT_RAW The raw interrupt bit turns to high level when Serial Port IN Endpoint is empty. (R/WTC/SS)

USB_SERIAL_JTAG_PID_ERR_INT_RAW The raw interrupt bit turns to high level when pid error is detected. (R/WTC/SS)

USB_SERIAL_JTAG_CRC5_ERR_INT_RAW The raw interrupt bit turns to high level when CRC5 error is detected. (R/WTC/SS)

USB_SERIAL_JTAG_CRC16_ERR_INT_RAW The raw interrupt bit turns to high level when CRC16 error is detected. (R/WTC/SS)

USB_SERIAL_JTAG_STUFF_ERR_INT_RAW The raw interrupt bit turns to high level when stuff error is detected. (R/WTC/SS)

USB_SERIAL_JTAG_IN_TOKEN_REC_IN_EP1_INT_RAW The raw interrupt bit turns to high level when IN token for IN endpoint 1 is received. (R/WTC/SS)

USB_SERIAL_JTAG_USB_BUS_RESET_INT_RAW The raw interrupt bit turns to high level when usb bus reset is detected. (R/WTC/SS)

USB_SERIAL_JTAG_OUT_EP1_ZERO_PAYLOAD_INT_RAW The raw interrupt bit turns to high level when OUT endpoint 1 received packet with zero palyload. (R/WTC/SS)

USB_SERIAL_JTAG_OUT_EP2_ZERO_PAYLOAD_INT_RAW The raw interrupt bit turns to high level when OUT endpoint 2 received packet with zero palyload. (R/WTC/SS)

Register 33.7. USB_SERIAL_JTAG_INT_ST_REG (0x000C)

(reserved)												USB_SERIAL_JTAG_OUT_EP2_ZERO_PAYLOAD_INT_ST USB_SERIAL_JTAG_OUT_EP1_ZERO_PAYLOAD_INT_ST USB_SERIAL_JTAG_USB_BUS_RESET_INT_ST USB_SERIAL_JTAG_IN_TOKEN_REC_IN_EP1_INT_ST USB_SERIAL_JTAG_STUFF_ERR_INT_ST USB_SERIAL_JTAG_CRC16_ERR_INT_ST USB_SERIAL_JTAG_CRC5_ERR_INT_ST USB_SERIAL_JTAG_PID_ERR_INT_ST USB_SERIAL_JTAG_SERIAL_IN_EMPTY_INT_ST USB_SERIAL_JTAG_SERIAL_OUT_RECV_PKT_INT_ST											
31											12	11	10	9	8	7	6	5	4	3	2	1	0
0 0																						Reset	

USB_SERIAL_JTAG_JTAG_IN_FLUSH_INT_ST The raw interrupt status bit for the USB_SERIAL_JTAG_JTAG_IN_FLUSH_INT interrupt. (RO)

USB_SERIAL_JTAG_SOF_INT_ST The raw interrupt status bit for the USB_SERIAL_JTAG_SOF_INT interrupt. (RO)

USB_SERIAL_JTAG_SERIAL_OUT_RECV_PKT_INT_ST The raw interrupt status bit for the USB_SERIAL_JTAG_SERIAL_OUT_RECV_PKT_INT interrupt. (RO)

USB_SERIAL_JTAG_SERIAL_IN_EMPTY_INT_ST The raw interrupt status bit for the USB_SERIAL_JTAG_SERIAL_IN_EMPTY_INT interrupt. (RO)

USB_SERIAL_JTAG_PID_ERR_INT_ST The raw interrupt status bit for the USB_SERIAL_JTAG_PID_ERR_INT interrupt. (RO)

USB_SERIAL_JTAG_CRC5_ERR_INT_ST The raw interrupt status bit for the USB_SERIAL_JTAG_CRC5_ERR_INT interrupt. (RO)

USB_SERIAL_JTAG_CRC16_ERR_INT_ST The raw interrupt status bit for the USB_SERIAL_JTAG_CRC16_ERR_INT interrupt. (RO)

USB_SERIAL_JTAG_STUFF_ERR_INT_ST The raw interrupt status bit for the USB_SERIAL_JTAG_STUFF_ERR_INT interrupt. (RO)

USB_SERIAL_JTAG_IN_TOKEN_REC_IN_EP1_INT_ST The raw interrupt status bit for the USB_SERIAL_JTAG_IN_TOKEN_REC_IN_EP1_INT interrupt. (RO)

USB_SERIAL_JTAG_USB_BUS_RESET_INT_ST The raw interrupt status bit for the USB_SERIAL_JTAG_USB_BUS_RESET_INT interrupt. (RO)

USB_SERIAL_JTAG_OUT_EP1_ZERO_PAYLOAD_INT_ST The raw interrupt status bit for the USB_SERIAL_JTAG_OUT_EP1_ZERO_PAYLOAD_INT interrupt. (RO)

USB_SERIAL_JTAG_OUT_EP2_ZERO_PAYLOAD_INT_ST The raw interrupt status bit for the USB_SERIAL_JTAG_OUT_EP2_ZERO_PAYLOAD_INT interrupt. (RO)

Register 33.8. USB_SERIAL_JTAG_INT_ENA_REG (0x0010)

(reserved)												USB_SERIAL_JTAG_OUT_EP2_ZERO_PAYLOAD_INT_ENA USB_SERIAL_JTAG_OUT_EP1_ZERO_PAYLOAD_INT_ENA USB_SERIAL_JTAG_USB_BUS_RESET_INT_ENA USB_SERIAL_JTAG_IN_TOKEN_REC_IN_EP1_INT_ENA USB_SERIAL_JTAG_STUFF_ERR_INT_ENA USB_SERIAL_JTAG_CRC16_ERR_INT_ENA USB_SERIAL_JTAG_PID_ERR_INT_ENA USB_SERIAL_JTAG_SERIAL_IN_EMPTY_INT_ENA USB_SERIAL_JTAG_SERIAL_OUT_RECV_PKT_INT_ENA													
31												12	11	10	9	8	7	6	5	4	3	2	1	0	Reset
0 0																									

USB_SERIAL_JTAG_JTAG_IN_FLUSH_INT_ENA The interrupt enable bit for the USB_SERIAL_JTAG_JTAG_IN_FLUSH_INT interrupt. (R/W)

USB_SERIAL_JTAG_SOF_INT_ENA The interrupt enable bit for the USB_SERIAL_JTAG_SOF_INT interrupt. (R/W)

USB_SERIAL_JTAG_SERIAL_OUT_RECV_PKT_INT_ENA The interrupt enable bit for the USB_SERIAL_JTAG_SERIAL_OUT_RECV_PKT_INT interrupt. (R/W)

USB_SERIAL_JTAG_SERIAL_IN_EMPTY_INT_ENA The interrupt enable bit for the USB_SERIAL_JTAG_SERIAL_IN_EMPTY_INT interrupt. (R/W)

USB_SERIAL_JTAG_PID_ERR_INT_ENA The interrupt enable bit for the USB_SERIAL_JTAG_PID_ERR_INT interrupt. (R/W)

USB_SERIAL_JTAG_CRC5_ERR_INT_ENA The interrupt enable bit for the USB_SERIAL_JTAG_CRC5_ERR_INT interrupt. (R/W)

USB_SERIAL_JTAG_CRC16_ERR_INT_ENA The interrupt enable bit for the USB_SERIAL_JTAG_CRC16_ERR_INT interrupt. (R/W)

USB_SERIAL_JTAG_STUFF_ERR_INT_ENA The interrupt enable bit for the USB_SERIAL_JTAG_STUFF_ERR_INT interrupt. (R/W)

USB_SERIAL_JTAG_IN_TOKEN_REC_IN_EP1_INT_ENA The interrupt enable bit for the USB_SERIAL_JTAG_IN_TOKEN_REC_IN_EP1_INT interrupt. (R/W)

USB_SERIAL_JTAG_USB_BUS_RESET_INT_ENA The interrupt enable bit for the USB_SERIAL_JTAG_USB_BUS_RESET_INT interrupt. (R/W)

USB_SERIAL_JTAG_OUT_EP1_ZERO_PAYLOAD_INT_ENA The interrupt enable bit for the USB_SERIAL_JTAG_OUT_EP1_ZERO_PAYLOAD_INT interrupt. (R/W)

USB_SERIAL_JTAG_OUT_EP2_ZERO_PAYLOAD_INT_ENA The interrupt enable bit for the USB_SERIAL_JTAG_OUT_EP2_ZERO_PAYLOAD_INT interrupt. (R/W)

Register 33.9. USB_SERIAL_JTAG_INT_CLR_REG (0x0014)

(reserved)												USB_SERIAL_JTAG_OUT_EP2_ZERO_PAYLOAD_INT_CLR USB_SERIAL_JTAG_OUT_EP1_ZERO_PAYLOAD_INT_CLR USB_SERIAL_JTAG_USB_BUS_RESET_INT_CLR USB_SERIAL_JTAG_IN_TOKEN_REC_IN_EP1_INT_CLR USB_SERIAL_JTAG_STUFF_ERR_INT_CLR USB_SERIAL_JTAG_CRC16_ERR_INT_CLR USB_SERIAL_JTAG_PID_ERR_INT_CLR USB_SERIAL_JTAG_SERIAL_IN_EMPTY_INT_CLR USB_SERIAL_JTAG_SERIAL_OUT_RECV_PKT_INT_CLR													
31												12	11	10	9	8	7	6	5	4	3	2	1	0	
0 0																						Reset			

USB_SERIAL_JTAG_JTAG_IN_FLUSH_INT_CLR Set this bit to clear the USB_SERIAL_JTAG_JTAG_IN_FLUSH_INT interrupt. (WT)

USB_SERIAL_JTAG_SOF_INT_CLR Set this bit to clear the USB_SERIAL_JTAG_JTAG_SOF_INT interrupt. (WT)

USB_SERIAL_JTAG_SERIAL_OUT_RECV_PKT_INT_CLR Set this bit to clear the USB_SERIAL_JTAG_SERIAL_OUT_RECV_PKT_INT interrupt. (WT)

USB_SERIAL_JTAG_SERIAL_IN_EMPTY_INT_CLR Set this bit to clear the USB_SERIAL_JTAG_SERIAL_IN_EMPTY_INT interrupt. (WT)

USB_SERIAL_JTAG_PID_ERR_INT_CLR Set this bit to clear the USB_SERIAL_JTAG_PID_ERR_INT interrupt. (WT)

USB_SERIAL_JTAG_CRC5_ERR_INT_CLR Set this bit to clear the USB_SERIAL_JTAG_CRC5_ERR_INT interrupt. (WT)

USB_SERIAL_JTAG_CRC16_ERR_INT_CLR Set this bit to clear the USB_SERIAL_JTAG_CRC16_ERR_INT interrupt. (WT)

USB_SERIAL_JTAG_STUFF_ERR_INT_CLR Set this bit to clear the USB_SERIAL_JTAG_STUFF_ERR_INT interrupt. (WT)

USB_SERIAL_JTAG_IN_TOKEN_REC_IN_EP1_INT_CLR Set this bit to clear the USB_SERIAL_JTAG_IN_TOKEN_REC_IN_EP1_INT interrupt. (WT)

USB_SERIAL_JTAG_USB_BUS_RESET_INT_CLR Set this bit to clear the USB_SERIAL_JTAG_USB_BUS_RESET_INT interrupt. (WT)

USB_SERIAL_JTAG_OUT_EP1_ZERO_PAYLOAD_INT_CLR Set this bit to clear the USB_SERIAL_JTAG_OUT_EP1_ZERO_PAYLOAD_INT interrupt. (WT)

USB_SERIAL_JTAG_OUT_EP2_ZERO_PAYLOAD_INT_CLR Set this bit to clear the USB_SERIAL_JTAG_OUT_EP2_ZERO_PAYLOAD_INT interrupt. (WT)

Register 33.12. USB_SERIAL_JTAG_FRAM_NUM_REG (0x0024)

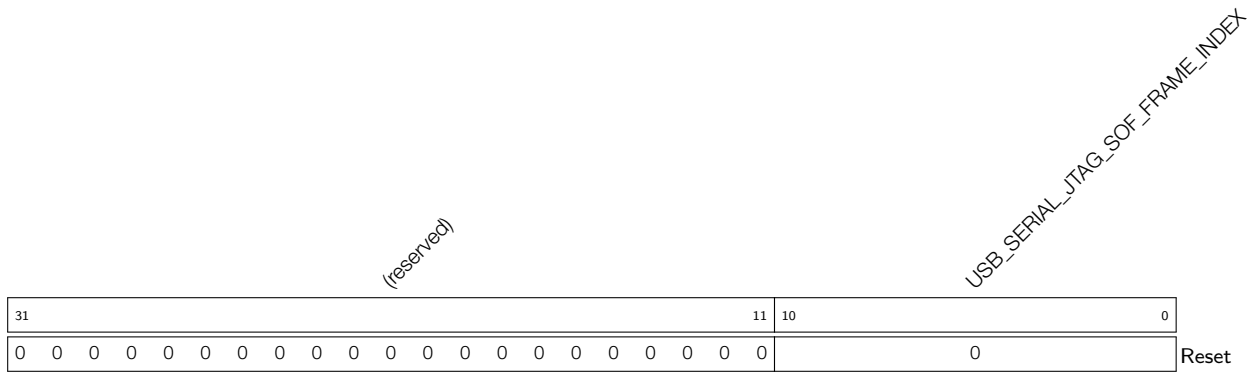

USB_SERIAL_JTAG_SOF_FRAME_INDEX Frame index of received SOF frame. (RO)

Register 33.13. USB_SERIAL_JTAG_IN_EP0_ST_REG (0x0028)

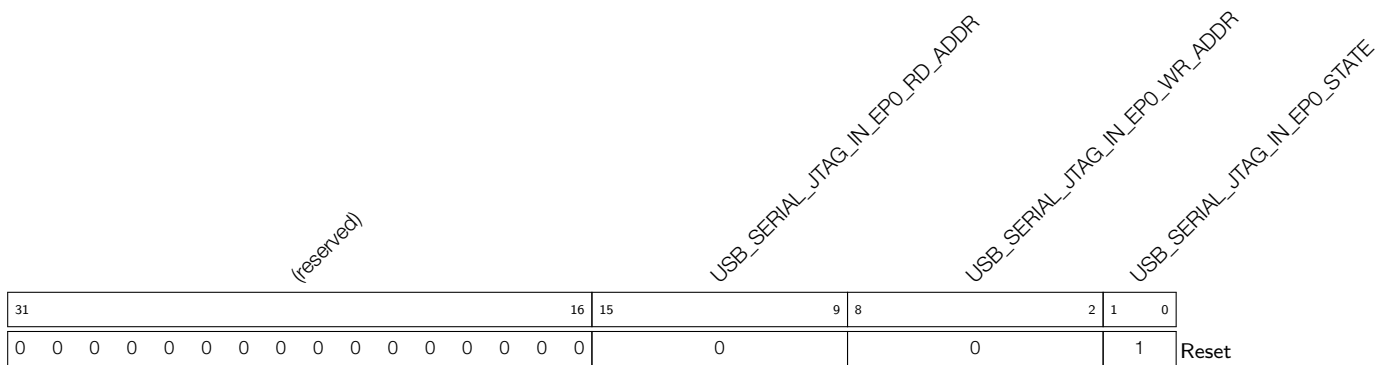

USB_SERIAL_JTAG_IN_EP0_STATE State of IN Endpoint 0. (RO)

USB_SERIAL_JTAG_IN_EP0_WR_ADDR Write data address of IN endpoint 0. (RO)

USB_SERIAL_JTAG_IN_EP0_RD_ADDR Read data address of IN endpoint 0. (RO)

Register 33.14. USB_SERIAL_JTAG_IN_EP1_ST_REG (0x002C)

(reserved)																USB_SERIAL_JTAG_IN_EP1_RD_ADDR				USB_SERIAL_JTAG_IN_EP1_WR_ADDR				USB_SERIAL_JTAG_IN_EP1_STATE			
31																15	9	8					2	1	0	Reset	
0 0 0 0 0 0 0 0 0 0 0 0 0 0 0 0																0				0				1			

USB_SERIAL_JTAG_IN_EP1_STATE State of IN Endpoint 1. (RO)

USB_SERIAL_JTAG_IN_EP1_WR_ADDR Write data address of IN endpoint 1. (RO)

USB_SERIAL_JTAG_IN_EP1_RD_ADDR Read data address of IN endpoint 1. (RO)

Register 33.15. USB_SERIAL_JTAG_IN_EP2_ST_REG (0x0030)

(reserved)																USB_SERIAL_JTAG_IN_EP2_RD_ADDR				USB_SERIAL_JTAG_IN_EP2_WR_ADDR				USB_SERIAL_JTAG_IN_EP2_STATE			
31																15	9	8					2	1	0	Reset	
0 0 0 0 0 0 0 0 0 0 0 0 0 0 0 0																0				0				1			

USB_SERIAL_JTAG_IN_EP2_STATE State of IN Endpoint 2. (RO)

USB_SERIAL_JTAG_IN_EP2_WR_ADDR Write data address of IN endpoint 2. (RO)

USB_SERIAL_JTAG_IN_EP2_RD_ADDR Read data address of IN endpoint 2. (RO)

Register 33.16. USB_SERIAL_JTAG_IN_EP3_ST_REG (0x0034)

(reserved)																USB_SERIAL_JTAG_IN_EP3_RD_ADDR								USB_SERIAL_JTAG_IN_EP3_WR_ADDR				USB_SERIAL_JTAG_IN_EP3_STATE				
31																16	15								9	8			2	1	0	
0																0								0				1				Reset

USB_SERIAL_JTAG_IN_EP3_STATE State of IN Endpoint 3. (RO)

USB_SERIAL_JTAG_IN_EP3_WR_ADDR Write data address of IN endpoint 3. (RO)

USB_SERIAL_JTAG_IN_EP3_RD_ADDR Read data address of IN endpoint 3. (RO)

Register 33.17. USB_SERIAL_JTAG_OUT_EP0_ST_REG (0x0038)

(reserved)																USB_SERIAL_JTAG_OUT_EP0_RD_ADDR								USB_SERIAL_JTAG_OUT_EP0_WR_ADDR				USB_SERIAL_JTAG_OUT_EP0_STATE				
31																16	15								9	8			2	1	0	
0																0								0				0				Reset

USB_SERIAL_JTAG_OUT_EP0_STATE State of OUT Endpoint 0. (RO)

USB_SERIAL_JTAG_OUT_EP0_WR_ADDR Write data address of OUT endpoint 0.
When `USB_SERIAL_JTAG_SERIAL_OUT_RECV_PKT_INT` is detected, there are `USB_SERIAL_JTAG_OUT_EP0_WR_ADDR-2` bytes data in OUT EP0. (RO)

USB_SERIAL_JTAG_OUT_EP0_RD_ADDR Read data address of OUT endpoint 0. (RO)

Register 33.18. USB_SERIAL_JTAG_OUT_EP1_ST_REG (0x003C)

(reserved)										USB_SERIAL_JTAG_OUT_EP1_REC_DATA_CNT						USB_SERIAL_JTAG_OUT_EP1_RD_ADDR						USB_SERIAL_JTAG_OUT_EP1_WR_ADDR						USB_SERIAL_JTAG_OUT_EP1_STATE									
31											23	22							16	15							9	8							2	1	0
0 0 0 0 0 0 0 0 0 0										0						0						0						0						Reset			

USB_SERIAL_JTAG_OUT_EP1_STATE State of OUT Endpoint 1. (RO)

USB_SERIAL_JTAG_OUT_EP1_WR_ADDR Write data address of OUT endpoint 1. When USB_SERIAL_JTAG_SERIAL_OUT_RECV_PKT_INT is detected, there are USB_SERIAL_JTAG_OUT_EP1_WR_ADDR-2 bytes data in OUT EP1. (RO)

USB_SERIAL_JTAG_OUT_EP1_RD_ADDR Read data address of OUT endpoint 1. (RO)

USB_SERIAL_JTAG_OUT_EP1_REC_DATA_CNT Data count in OUT endpoint 1 when one packet is received. (RO)

Register 33.19. USB_SERIAL_JTAG_OUT_EP2_ST_REG (0x0040)

(reserved)																USB_SERIAL_JTAG_OUT_EP2_RD_ADDR						USB_SERIAL_JTAG_OUT_EP2_WR_ADDR						USB_SERIAL_JTAG_OUT_EP2_STATE							
31																	16	15							9	8							2	1	0
0 0 0 0 0 0 0 0 0 0 0 0 0 0 0 0																0						0						0						Reset	

USB_SERIAL_JTAG_OUT_EP2_STATE State of OUT Endpoint 2. (RO)

USB_SERIAL_JTAG_OUT_EP2_WR_ADDR Write data address of OUT endpoint 2. When USB_SERIAL_JTAG_SERIAL_OUT_RECV_PKT_INT is detected, there are USB_SERIAL_JTAG_OUT_EP2_WR_ADDR-2 bytes data in OUT EP2. (RO)

USB_SERIAL_JTAG_OUT_EP2_RD_ADDR Read data address of OUT endpoint 2. (RO)

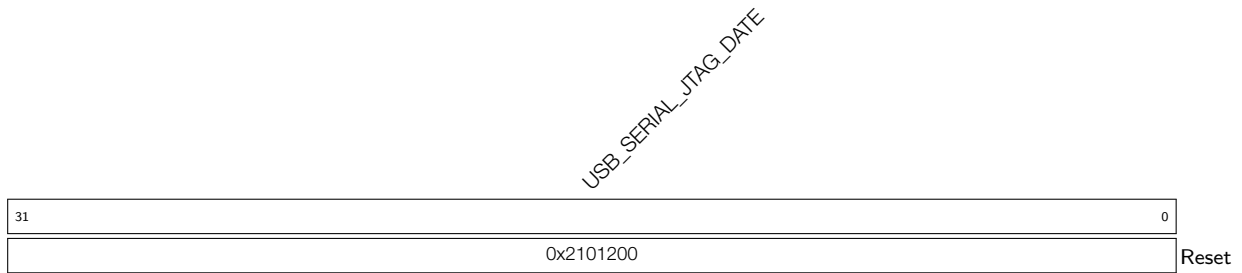
Register 33.20. USB_SERIAL_JTAG_DATE_REG (0x0080)

USB_SERIAL_JTAG_DATE register version. (R/W)

34 SD/MMC Host Controller (SDHOST)

34.1 Overview

The ESP32-S3 memory card interface controller provides a hardware interface between the Advanced Peripheral Bus (APB) and an external memory device. The memory card interface allows the ESP32-S3 to be connected to SDIO memory cards, MMC cards and devices with a CE-ATA interface. It supports two external cards (Card0 and Card1). And all SD/MMC module interface signal only connect to GPIO pad by GPIO matrix.

34.2 Features

This module supports the following features:

- Two external cards
- SD Memory Card standard: V3.0 and V3.01
- MMC: V4.41, V4.5, and V4.51
- CE-ATA: V1.1
- 1-bit, 4-bit, and 8-bit modes

The SD/MMC controller topology is shown in Figure 34-1. The controller supports two peripherals which cannot be functional at the same time.

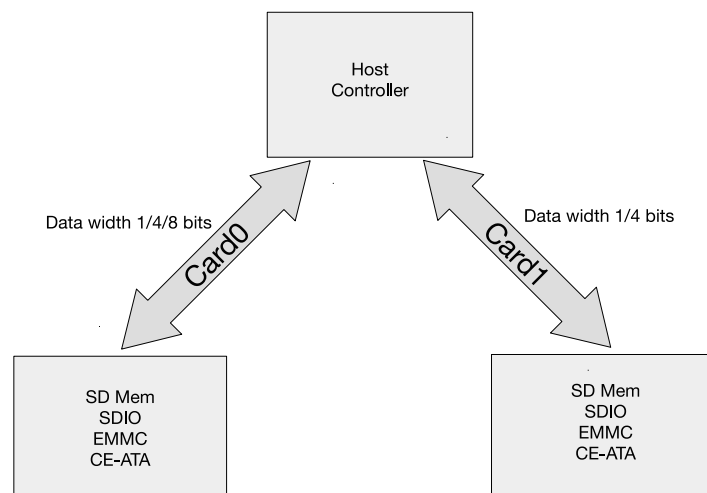

Figure 34-1. SD/MMC Controller Topology

34.3 SD/MMC External Interface Signals

The primary external interface signals, which enable the SD/MMC controller to communicate with an external device, are clock (sdhost_cclk_out_1.eg:card1), command (sdhost_ccmd_out_1) and data signals (sdhost_cdata_in_1[7:0]/sdhost_cdata_out_1[7:0]). Additional signals include the card interrupt, card detect, and write-protect signals. The direction of each signal is shown in Figure 34-2. The direction and description of each pin are listed in Table 34-1.

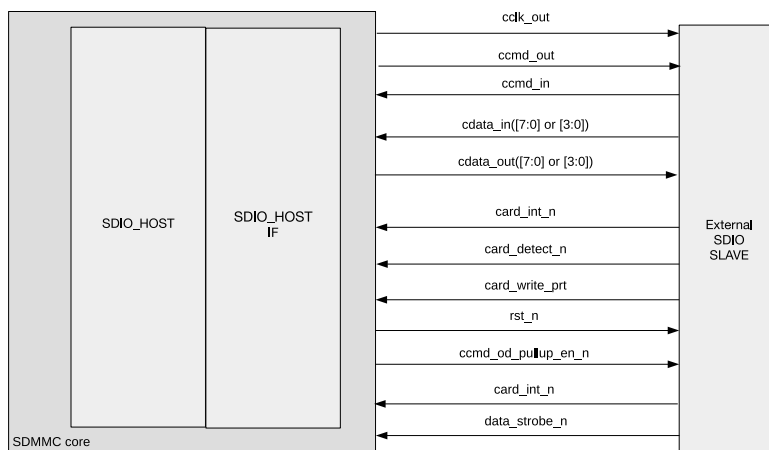

Figure 34-2. SD/MMC Controller External Interface Signals

Table 34-1. SD/MMC Signal Description

Pin	Direction	Description
sdhost_cclk_out	Output	Clock signals for slave device
sdhost_ccmd	Duplex	Duplex command/response lines
sdhost_cdata	Duplex	Duplex data read/write lines
sdhost_card_detect_n	Input	Card detection input line
sdhost_card_write_prt	Input	Card write protection status input
sdhost_rst_n	Output	Hardware reset for MMC4.4 cards
sdhost_ccmd_od_pullup_en_n	output	Card Cmd Open-Drain Pullup
sdhost_card_int_n	Input	Interrupt pin for eSDIO devices
sdhost_data_strobe_n	Input	Card HS400 Data Strobe

34.4 Functional Description

34.4.1 SD/MMC Host Controller Architecture

The SD/MMC host controller consists of two main functional blocks, as shown in Figure 34-3:

- Bus Interface Unit (BIU): It provides APB interfaces for registers, data access method for RMA, and data read and write operation by DMA.
- Card Interface Unit (CIU): It handles external memory card interface protocols. It also provides clock control.

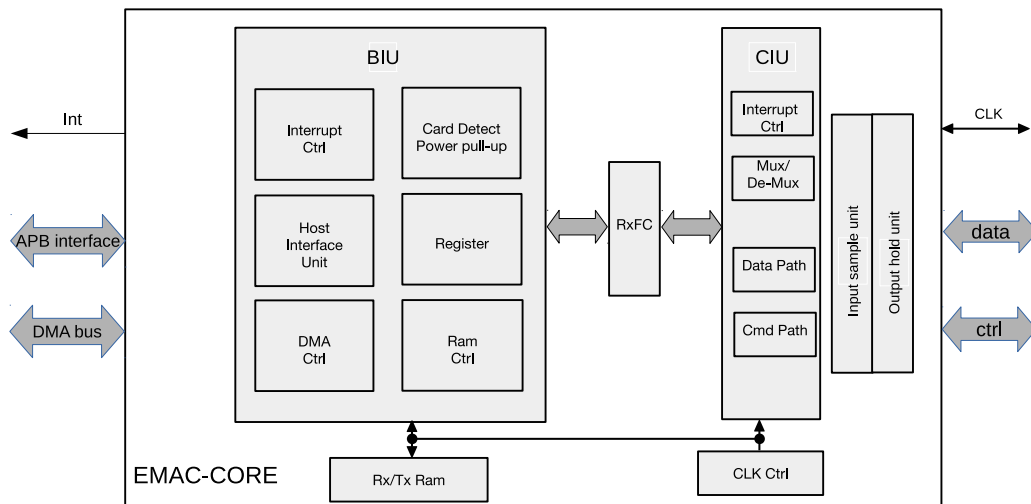

Figure 34-3. SDIO Host Block Diagram

34.4.1.1 Bus Interface Unit (BIU)

The BIU provides the access to registers and RAM data through the Host Interface Unit (HIU). Additionally, it provides a method to access to memory data through a DMA interface. Figure 34-3 illustrates the internal components of the BIU. Figure 34-9 illustrates the clock selection. The BIU provides the following functions:

- Host interface
- DMA interface
- Interrupt control
- Register access
- FIFO access
- Power/pull-up control and card detection

34.4.1.2 Card Interface Unit (CIU)

The CIU module implements the card-specific protocols. Within the CIU, the command path control unit and data path control unit are used to interface with the command and data ports, respectively, of the SD/MMC/CE-ATA cards. The CIU also provides clock control. Figure 34-3 illustrates the internal structure of the CIU, which consists of the following primary functional blocks:

- Command path
- Data path
- SDIO interrupt control
- Clock control
- Mux/De-Mux unit

34.4.2 Command Path

The command path performs the following functions:

- Configures clock parameters
- Configures card command parameters
- Sends commands to card bus (sdhost_ccmd_out line)
- Receives responses from card bus (sdhost_ccmd_in line)
- Sends responses to BIU
- Drives the P-bit on the command line

The command path State Machine is shown in Figure 34-4.

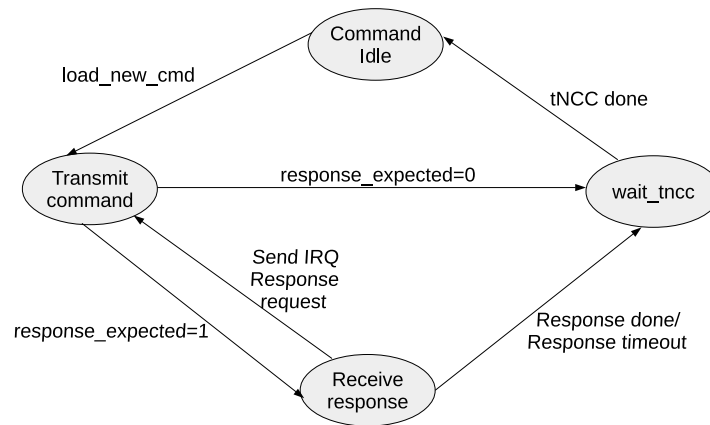

Figure 34-4. Command Path State Machine

34.4.3 Data Path

The data path block pops RAM data and transmits them on sdhost_cdata_out during a write-data transfer, or it receives data on sdhost_cdata_in and pushes them into RAM during a read-data transfer. The data path loads new data parameters, i.e., expected data, read/write data transfer, stream/block transfer, block size, byte count, card type, timeout registers, etc., whenever a data transfer command is not in progress.

If the SDHOST_DATA_EXPECTED bit is set in SDHOST_CMD_REG register, the new command is a data-transfer command and the data path starts one of the following operations:

- Transmitting data if the SDHOST_READ_WRITE bit is 1
- Receiving data if the SDHOST_READ_WRITE bit is 0

34.4.3.1 Data Transmit Operation

The module starts data transmission two clock cycles after a response for the data-write command is received. This occurs even if the command path detects a response error or a cyclic redundancy check (CRC) error in a response. If no response is received from the card until the response timeout, no data are transmitted. Depending on the value of the SDHOST_TRANSFER_MODE bit in SDHOST_CMD_REG register, the data-transmit state machine adds data to the card's data bus in a stream or in block(s). The data transmit state machine is shown in Figure 34-5.

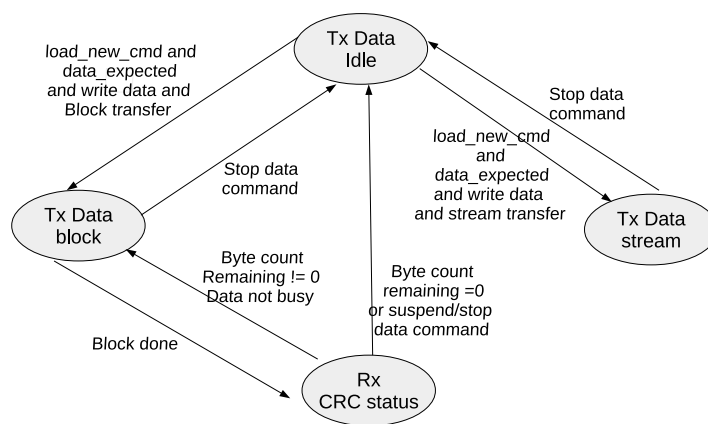

Figure 34-5. Data Transmit State Machine

34.4.3.2 Data Receive Operation

The module receives data two clock cycles after the end bit of a data-read command, even if the command path detects a response error or a CRC error. If no response is received from the card and a response timeout occurs, the BIU does not receive a signal about the completion of the data transfer. If the command sent by the CIU is an illegal operation for the card, it would prevent the card from starting a read-data transfer, and the BIU will not receive a signal about the completion of the data transfer.

If no data is received by the data timeout, the data path signals a data timeout to the BIU, which marks an end to the data transfer. Based on the value of the SDHOST_TRANSFER_MODE bit in `SDHOST_CMD_REG` register, the data-receive state machine gets data from the card's data bus in a stream or block(s). The data receive state machine is shown in Figure 34-6.

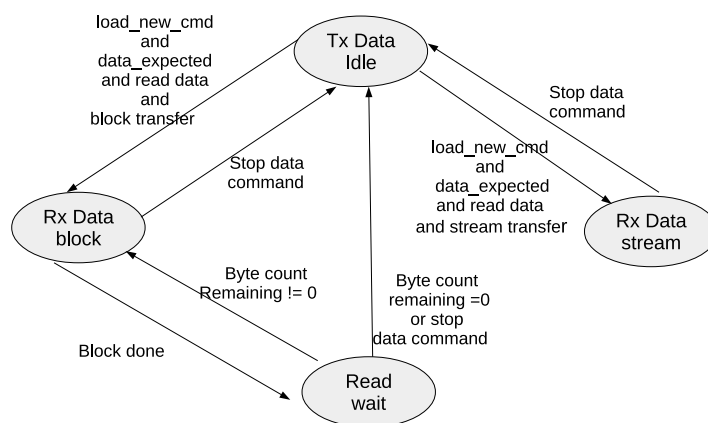

Figure 34-6. Data Receive State Machine

34.5 Software Restrictions for Proper CIU Operation

- Only one card at a time can be selected to execute a command or data transfer. For example, when data are being transferred to or from a card, a new command must not be issued to another card. A new command, however, can be issued to the same card, allowing it to read the device status or stop the transfer.
- Only one command at a time can be issued for data transfers.

- During an open-ended card-write operation, if the card clock is stopped due to RAM being empty, the software must fill RAM with data first, and then start the card clock. Only then can it issue a stop/abort command to the card.
- During an SDIO/Combo card transfer, if the card function is suspended and the software wants to resume the suspended transfer, it must first reset RAM, setting SDHOST_FIFO_RESET bits and then issue the resume command as if it were a new data-transfer command.
- When issuing card reset commands (CMD0, CMD15 or CMD52_reset), while a card data transfer is in progress, the software must set the SDHOST_STOP_ABORT_CMD bit in SDHOST_CMD_REG register, so that the CIU can stop the data transfer after issuing the card reset command.
- When the data's end bit error is set in the SDHOST_RINTSTS_REG register, the CIU does not guarantee SDIO interrupts. In such a case, the software ignores SDIO interrupts and issues a stop/abort command to the card, so that the card stops sending read-data.
- If the card clock is stopped due to RAM being full during a card read, the software will read at least two RAM locations to restart the card clock.
- Only one CE-ATA device at a time can be selected for a command or data transfer. For example, when data are transferred from a CE-ATA device, a new command should not be sent to another CE-ATA device.
- If a CE-ATA device's interrupts are enabled (nIEN=0), a new SDHOST_RW_BLK command should not be sent to the same device if the execution of a SDHODT_RW_BLK command is already in progress. Only the CCSD can be sent while waiting for the CCS.
- If, however, a CE-ATA device's interrupts are disabled (nIEN=1), a new command can be issued to the same device, allowing it to read status information.
- Open-ended transfers are not supported in CE-ATA devices.
- The sdhost_send_auto_stop signal is not supported (software should not set the sdhost_send_auto_stop bit) in CE-ATA transfers.

After configuring the command start bit to 1, the values of the following registers cannot be changed before a command has been issued:

- CMD - command
- CMDARG - command argument
- BYTCNT - byte count
- BLKSIZ - block size
- CLKDIV - clock divider
- CKLENA - clock enable
- CLKSRC - clock source
- TMOUT - timeout
- CTYPE - card type

34.6 RAM for Receiving and Sending Data

The submodule RAM is a buffer area for sending and receiving data. It can be divided into two units: the one is for sending data, and the other is for receiving data. The process of sending and receiving data can also be achieved by the CPU and DMA for reading and writing. The latter method is described in detail in Section 34.8.

34.6.1 TX RAM Module

There are two ways to enable a write operation: DMA and CPU read/write.

If SDIO-sending is enabled, data can be written to the TX RAM module by APB interface. Data will be written to register `SDHOST_BUFFIFO_REG` from the CPU, directly, by an APB interface.

Another way of data transmission is by DMA.

34.6.2 RX RAM Module

There are two ways to enable a read operation: DMA and CPU read/write.

When the data path receives data, the data will be written to the RX RAM. Then, these data can be read with the APB method at the reading end. Register `SDHOST_BUFFIFO_REG` can be read by the APB directly.

Another way of receiving data is by DMA.

34.7 DMA Descriptor Chain

Each linked list module consists of two parts: the linked list itself and a data buffer. In other words, each module points to a unique data buffer and the linked list that follows the module. Figure 34-7 shows the descriptor chain.

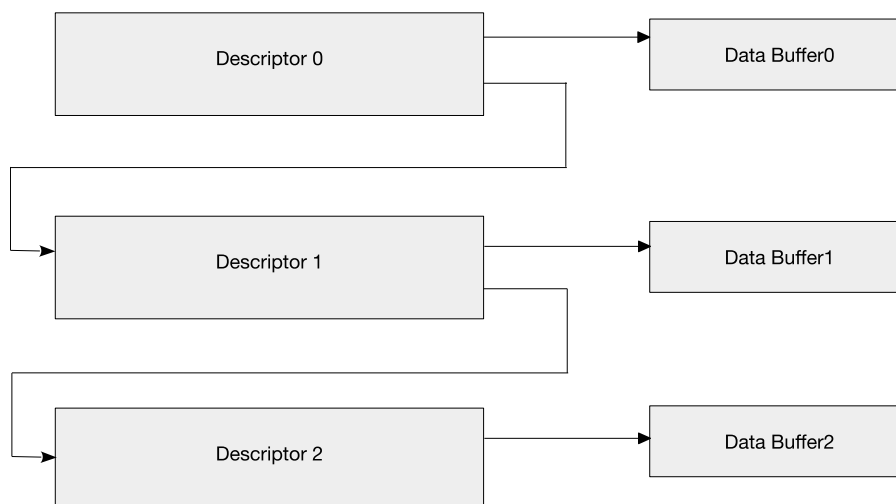

Figure 34-7. Descriptor Chain

34.8 The Structure of DMA descriptor chain

Each linked list consists of four words. As is shown below, Figure 34-8 demonstrates the linked list's structure, and Table 34-2, Table 34-3, Table 34-4, Table 34-5 provide the descriptions of linked lists.

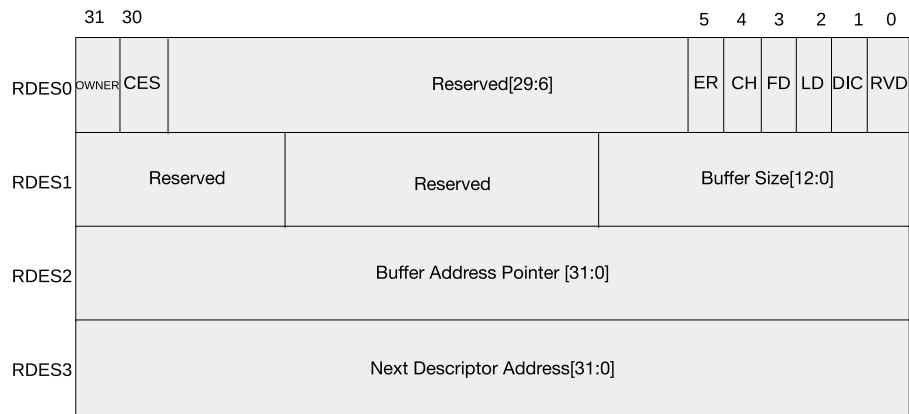

Figure 34-8. The Structure of a Linked List

The DES0 element contains control and status information.

Table 34-2. Word DES0 of SD/MMC GDMA Linked List

Bits	Name	Description
31	OWNER	When set, this bit indicates that the descriptor is owned by the DMA Controller. When reset, it indicates that the descriptor is owned by the Host. The DMA clears this bit when it completes the data transfer.
30	CES (Card Error Summary)	These error bits indicate the status of the transition to or from the card. The following bits are also present in SDHOST_RINTSTS_REG, which indicates their digital logic OR gate. <ul style="list-style-type: none"> • EBE: End Bit Error • RTO: Response Time out • RCRC: Response CRC • SBE: Start Bit Error • DRTO: Data Read Timeout • DCRC: Data CRC for Receive • RE: Response Error
29:6	Reserved	Reserved
5	ER (End of Ring)	When set, this bit indicates that the descriptor list has reached its final descriptor. The DMA Controller then returns to the base address of the list, creating a Descriptor Chain.
4	CH (Second Address Chained)	When set, this bit indicates that the second address in the descriptor is the Next Descriptor address. When this bit is set, BS2 (DES1[25:13]) should be all zeros.

Bits	Name	Description
3	FD (First Descriptor)	When set, this bit indicates that this descriptor contains the first buffer of the data. If the size of the first buffer is 0, the Next Descriptor contains the beginning of the data.
2	LD (Last Descriptor)	This bit is associated with the last block of a DMA transfer. When set, the bit indicates that the buffers pointed by this descriptor are the last buffers of the data. After this descriptor is completed, the remaining byte count is 0. In other words, after the descriptor with the LD bit set is completed, the remaining byte count should be 0.
1	DIC (Disable Interrupt on Completion)	When set, this bit will prevent the setting of the TI/RI bit of the DMA Status Register (IDSTS) for the data that ends in the buffer pointed by this descriptor.
0	Reserved	Reserved

The DES1 element contains the buffer size.

Table 34-3. Word DES1 of SD/MMC GDMA Linked List

Bits	Name	Description
31:26	Reserved	Reserved
25:13	Reserved	Reserved
12:0	BS (Buffer Size)	Indicates the size of the data buffer (in Byte), which must be a multiple of four. In the case where the buffer size is not a multiple of four, the resulting behavior is undefined. This field should not be zero.

The DES2 element contains the address pointer to the data buffer.

Table 34-4. Word DES2 of SD/MMC GDMA Linked List

Bits	Name	Description
31:0	Buffer Address Pointer	These bits indicate the physical address of the data buffer. And the buffer address must be word-aligned.

The DES3 element contains the address pointer to the next descriptor if the present descriptor is not the last one in a chained descriptor structure.

Table 34-5. Word DES3 of SD/MMC GDMA Linked List

Bits	Name	Description
31:0	Next Descriptor Address	If CH (DES0[4]) is set, this bit contains the address pointer to the next descriptor.

Bits	Name	Description
		If this is not the last descriptor in a chained descriptor structure, the address pointer to the next descriptor should be: DES3[1:0] = 0.

34.9 Initialization

34.9.1 DMA Initialization

The DMA Controller initialization should proceed as follows:

1. Write to the DMA Bus Mode Register ([SDHOST_BMOD_REG](#)) will set the Host bus's access parameters.
2. Write to the DMA Interrupt Enable Register ([SDHOST_IDINTEN_REG](#)) will mask any unnecessary interrupt causes.
3. The software driver creates either the inlink or the outlink descriptors. Then, it writes to the DMA Descriptor List Base Address Register ([SDHOST_DBADDR_REG](#)), providing the DMA Controller with the starting address of the list.
4. The DMA Controller engine attempts to acquire descriptors from descriptor lists.

34.9.2 DMA Transmission Initialization

The DMA transmission occurs as follows:

1. The Host sets up the elements (DES0-DES3) for transmission, and sets the OWNER bit (DES0[31]). The Host also prepares the data buffer.
2. The Host programs the write-data command in the CMD register in BIU.
3. The Host also programs the required transmit threshold (SDHOST_TX_WMARK field in [SDHOST_FIFOTH_REG](#) register).
4. The DMA Controller engine fetches the descriptor and checks the OWNER bit. If the OWNER bit is not set, it means that the host owns the descriptor. In this case, the DMA Controller enters a suspend-state and asserts the Descriptor Unable interrupt in the [SDHOST_IDSTS_REG](#) register. In such a case, the host needs to release the DMA Controller by writing any value to [SDHOST_PLDMND_REG](#).
5. It then waits for the Command Done (CD) bit in [DHOST_RINTSTS_REG](#) register and no errors from BIU, which indicates that a transfer has completed.
6. Subsequently, the DMA Controller engine waits for a DMA interface request from BIU. This request will be generated, based on the programmed transmit-threshold value. For the last bytes of data which cannot be accessed using a burst, single transfers are performed on the AHB Master Interface.
7. The DMA Controller fetches the transmit data from the data buffer in the Host memory and transfers them to RAM for transmission to card.
8. When data span across multiple descriptors, the DMA Controller fetches the next descriptor and extends its operation using the following descriptor. The last descriptor bit indicates whether the data span multiple descriptors or not.

9. When data transmission is complete, the status information is updated in the [SDHOST_IDSTS_REG](#) register by setting the SDHOST_IDSTS_TI, if it has already been enabled. Also, the OWNER bit is cleared by the DMA Controller by performing a write transaction to DES0.

34.9.3 DMA Reception Initialization

The DMA reception occurs as follows:

1. The Host sets up the element (DES0-DES3) for reception, and sets the OWNER bit (DES0[31]).
2. The Host programs the read-data command in the CMD register in BIU.
3. Then, the Host programs the required level of the receive-threshold (SDHOST_RX_WMARK field in [SDHOST_FIFOTH_REG](#) register).
4. The DMA Controller engine fetches the descriptor and checks the OWNER bit. If the OWNER bit is not set, it means that the host owns the descriptor. In this case, the DMA enters a suspend-state and asserts the Descriptor Unable interrupt in the [SDHOST_IDSTS_REG](#) register. In such a case, the host needs to release the DMA Controller by writing any value to [SDHOST_PLDMND_REG](#).
5. It then waits for the Command Done (CD) bit and no errors from BIU, which indicates that a reception can be done.
6. The DMA Controller engine then waits for a DMA interface request from BIU. This request will be generated, based on the programmed receive-threshold value. For the last bytes of the data which cannot be accessed using a burst, single transfers are performed on the AHB.
7. The DMA Controller fetches the data from RAM and transfers them to the Host memory.
8. When data span across multiple descriptors, the DMA Controller will fetch the next descriptor and extend its operation using the following descriptor. The last descriptor bit indicates whether the data span multiple descriptors or not.
9. When data reception is complete, the status information is updated in the [SDHOST_IDSTS_REG](#) register by setting SDHOST_IDSTS_RI, if it has already been enabled. Also, the OWNER bit is cleared by the DMA Controller by performing a write-transaction to DES0.

34.10 Clock Phase Selection

If the setup time requirements for the input or output data signal are not met, users can specify the clock phase, as shown in the figure [34-9](#).

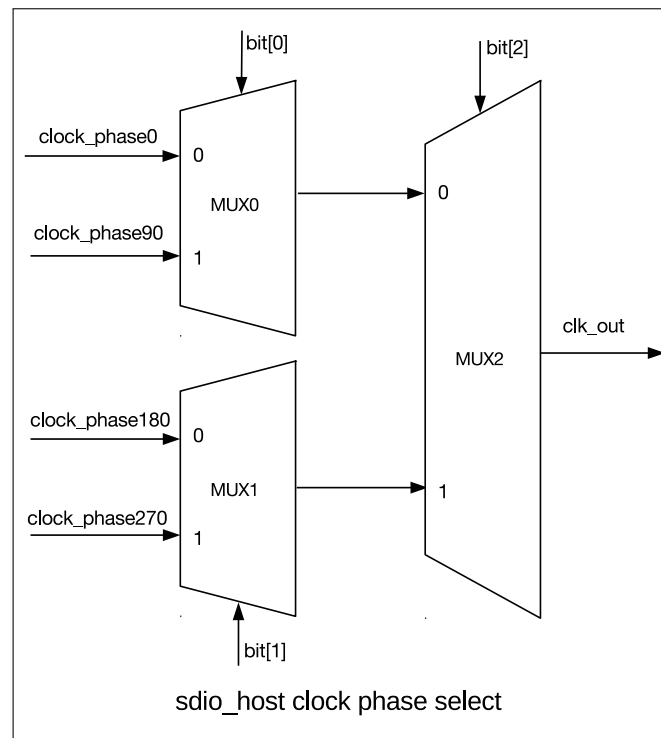

Figure 34-9. Clock Phase Selection

This issue can be fixed by configuring register [SDHOST_CLK_DIV_EDGE_REG](#). For example, set CCLKIN_EDGE_DRV_SEL bit to 0 to drive the output data in phase0, and set the CCLKIN_EDGE_SAM_SEL bit to 1 to select phase90 to sample the data from SDIO slave, if there are still timing issue, please set bit 4 or 6 to use phase180 or phase 270 to sample the data from SDIO slave.

Please find detailed information on the clock phase selection register [SDHOST_CLK_DIV_EDGE_REG](#) in Section Registers.

Table 34-6. SDHOST Clk Phase Selection

Clock phase	phase_select value
0	0
90	1
180	4
270	6

34.11 Interrupt

Interrupts can be generated as a result of various events. The [SDHOST_IDSTS_REG](#) register contains all the bits that might cause an interrupt. The [SDHOST_IDINTEN_REG](#) register contains an enable bit for each of the events that can cause an interrupt.

There are two groups of summary interrupts, "Normal" ones (bit8 [SDHOST_IDSTS_NIS](#)) and "Abnormal" ones (bit9 [SDHOST_IDSTS_AIS](#)), as outlined in the [SDHOST_IDSTS_REG](#) register. Interrupts are cleared by writing 1 to the position of the corresponding bit. When all the enabled interrupts within a group are cleared, the corresponding summary bit is also cleared. When both summary bits are cleared, the interrupt signal connected to CPU is de-asserted (stops signalling).

Interrupts are not queued up, and if a new interrupt-event occurs before the driver has responded to it, no additional interrupts are generated. For example, the SDHOST_IDSTS_RI indicates that one or more data were transferred to the Host buffer.

An interrupt is generated only once for concurrent events. The driver must scan the [SDHOST_IDSTS_REG](#) register for the interrupt cause.

34.12 Register Summary

The addresses in this section are relative to SD/MMC Host Controller base address provided in Table 4-3 in Chapter 4 *System and Memory*.

The abbreviations given in Column **Access** are explained in Section [Access Types for Registers](#).

Name	Description	Address	Access
SDHOST_CTRL_REG	Control register	0x0000	R/W
SDHOST_CLKDIV_REG	Clock divider configuration register	0x0008	R/W
SDHOST_CLKSRC_REG	Clock source selection register	0x000C	R/W
SDHOST_CLKENA_REG	Clock enable register	0x0010	R/W
SDHOST_TMOUT_REG	Data and response timeout configuration register	0x0014	R/W
SDHOST_CTYPE_REG	Card bus width configuration register	0x0018	R/W
SDHOST_BLKSIZE_REG	Card data block size configuration register	0x001C	R/W
SDHOST_BYTCNT_REG	Data transfer length configuration register	0x0020	R/W
SDHOST_INTMASK_REG	SDIO interrupt mask register	0x0024	R/W
SDHOST_CMDARG_REG	Command argument data register	0x0028	R/W
SDHOST_CMD_REG	Command and boot configuration register	0x002C	R/W
SDHOST_RESP0_REG	Response data register	0x0030	RO
SDHOST_RESP1_REG	Long response data register	0x0034	RO
SDHOST_RESP2_REG	Long response data register	0x0038	RO
SDHOST_RESP3_REG	Long response data register	0x003C	RO
SDHOST_MINTSTS_REG	Masked interrupt status register	0x0040	RO
SDHOST_RINTSTS_REG	Raw interrupt status register	0x0044	R/W
SDHOST_STATUS_REG	SD/MMC status register	0x0048	RO
SDHOST_FIFOTH_REG	FIFO configuration register	0x004C	R/W
SDHOST_CDETECT_REG	Card detect register	0x0050	RO
SDHOST_WRTPRT_REG	Card write protection (WP) status register	0x0054	RO
SDHOST_TBCNT_REG	Transferred byte count register	0x005C	RO
SDHOST_TBBCNT_REG	Transferred byte count register	0x0060	RO
SDHOST_DEBNCE_REG	Debounce filter time configuration register	0x0064	R/W
SDHOST_USRID_REG	User ID (scratchpad) register	0x0068	R/W
SDHOST_VERID_REG	Version ID (scratchpad) register	0x006C	RO
SDHOST_HCON_REG	Hardware feature register	0x0070	RO
SDHOST_UHS_REG	UHS-1 register	0x0074	R/W
SDHOST_RST_N_REG	Card reset register	0x0078	R/W
SDHOST_BMOD_REG	Burst mode transfer configuration register	0x0080	R/W
SDHOST_PLDMND_REG	Poll demand configuration register	0x0084	WO
SDHOST_DBADDR_REG	Descriptor base address register	0x0088	R/W
SDHOST_IDSTS_REG	IDMAC status register	0x008C	R/W
SDHOST_IDINTEN_REG	IDMAC interrupt enable register	0x0090	R/W
SDHOST_DSCADDR_REG	Host descriptor address pointer	0x0094	RO
SDHOST_BUFADDR_REG	Host buffer address pointer register	0x0098	RO
SDHOST_CARDTHRCTL_REG	Card Threshold Control register	0x0100	R/W
SDHOST_EMMCDDR_REG	eMMC DDR register	0x010C	R/W

Name	Description	Address	Access
SDHOST_ENSHIFT_REG	Enable Phase Shift register	0x0110	R/W
SDHOST_BUFFIFO_REG	CPU write and read transmit data by FIFO	0x0200	R/W
SDHOST_CLK_DIV_EDGE_REG	Clock phase selection register	0x0800	R/W

34.13 Registers

The addresses in this section are relative to SD/MMC Host Controller base address provided in Table 4-3 in Chapter 4 *System and Memory*.

Register 34.1. SDHOST_CTRL_REG (0x0000)

(reserved)	(reserved)	(reserved)	SDHOST_CEATA_DEVICE_INTERRUPT_STATUS	SDHOST_SEND_AUTO_STOP_CCSD	SDHOST_SEND_CCSD	SDHOST_ABORT_READ_DATA	SDHOST_SEND_IRQ_RESPONSE	(reserved)	SDHOST_INIT_ENABLE	(reserved)	SDHOST_DMA_RESET	SDHOST_FIFO_RESET	SDHOST_CONTROLLER_RESET			
31	25	24	23	12	11	10	9	8	7	6	5	4	3	2	1	0
0x00	1	0x000	0	0	0	0	0	0	0	0	0	0	0	0	0	0

Reset

SDHOST_CEATA_DEVICE_INTERRUPT_STATUS Software should appropriately write to this bit after the power-on reset or any other reset to the CE-ATA device. After reset, the CE-ATA device's interrupt is usually disabled (nIEN = 1). If the host enables the CE-ATA device's interrupt, then software should set this bit. (R/W)

SDHOST_SEND_AUTO_STOP_CCSD Always set SDHOST_SEND_AUTO_STOP_CCSD and SDHOST_SEND_CCSD bits together; SDHOST_SEND_AUTO_STOP_CCSD should not be set independently of send_ccsd. When set, SD/MMC automatically sends an internally-generated STOP command (CMD12) to the CE-ATA device. After sending this internally-generated STOP command, the Auto Command Done (ACD) bit in SDHOST_RINTSTS_REG is set and an interrupt is generated for the host, in case the ACD interrupt is not masked. After sending the Command Completion Signal Disable (CCSD), SD/MMC automatically clears the SDHOST_SEND_AUTO_STOP_CCSD bit. (R/W)

SDHOST_SEND_CCSD When set, SD/MMC sends CCSD to the CE-ATA device. Software sets this bit only if the current command is expecting CCS (that is, RW_BLK), and if interrupts are enabled for the CE-ATA device. Once the CCSD pattern is sent to the device, SD/MMC automatically clears the SDHOST_SEND_CCSD bit. It also sets the Command Done (CD) bit in the SDHOST_RINTSTS_REG register, and generates an interrupt for the host, in case the Command Done interrupt is not masked.

NOTE: Once the SDHOST_SEND_CCSD bit is set, it takes two card clock cycles to drive the CCSD on the CMD line. Due to this, within the boundary conditions the CCSD may be sent to the CE-ATA device, even if the device has signalled CCS. (R/W)

Continued on the next page...

Register 34.1. SDHOST_CTRL_REG (0x0000)

Continued from the previous page...

SDHOST_ABORT_READ_DATA After a suspend-command is issued during a read-operation, software polls the card to find when the suspend-event occurred. Once the suspend-event has occurred, software sets the bit which will reset the data state machine that is waiting for the next block of data. This bit is automatically cleared once the data state machine is reset to idle. (R/W)

SDHOST_SEND_IRQ_RESPONSE Bit automatically clears once response is sent. To wait for MMC card interrupts, host issues CMD40 and waits for interrupt response from MMC card(s). In the meantime, if host wants SD/MMC to exit waiting for interrupt state, it can set this bit, at which time SD/MMC command state-machine sends CMD40 response on bus and returns to idle state. (R/W)

SDHOST_READ_WAIT For sending read-wait to SDIO cards. (R/W)

SDHOST_INT_ENABLE Global interrupt enable/disable bit. 0: Disable; 1: Enable. (R/W)

SDHOST_DMA_RESET To reset DMA interface, firmware should set bit to 1. This bit is auto-cleared after two AHB clocks. (R/W)

SDHOST_FIFO_RESET To reset FIFO, firmware should set bit to 1. This bit is auto-cleared after completion of reset operation.

Note: FIFO pointers will be out of reset after 2 cycles of system clocks in addition to synchronization delay (2 cycles of card clock), after the fifo_reset is cleared. (R/W)

SDHOST_CONTROLLER_RESET To reset controller, firmware should set this bit. This bit is auto-cleared after two AHB and two sdhost_cclk_in clock cycles. (R/W)

Register 34.2. SDHOST_CLKDIV_REG (0x0008)

31	24	23	16	15	8	7	0	
SDHOST_CLK_DIVIDER3			SDHOST_CLK_DIVIDER2			SDHOST_CLK_DIVIDER1		SDHOST_CLK_DIVIDER0
0x000			0x000			0x000		0x000
								Reset

SDHOST_CLK_DIVIDER m Clock divider (m) value. Clock divisor is 2^n , where $n = 0$ bypasses the divider (divisor of 1). For example, a value of 1 means divided by $2^1 = 2$, a value of 0xFF means divided by $2^{255} = 510$, and so on. The range of m is 0 ~ 3. (R/W)

Register 34.3. SDHOST_CLKSRC_REG (0x000C)

(reserved)										SDHOST_CLKSRC_REG				
31											4	3	0	
0x00000000										0x0				Reset

SDHOST_CLKSRC_REG Clock divider source for two SD cards is supported. Each card has two bits assigned to it. For example, bit[1:0] are assigned for card 0, bit[3:2] are assigned for card 1. Card 0 maps and internally routes clock divider[0:3] outputs to cclk_out[1:0] pins, depending on bit value. (R/W)

- 00 : Clock divider 0;
- 01 : Clock divider 1;
- 10 : Clock divider 2;
- 11 : Clock divider 3.

Register 34.4. SDHOST_CLKENA_REG (0x0010)

(reserved)										SDHOST_LP_ENABLE				(reserved)				SDHOST_CCLK_ENABLE				
31											18	17	16	15					2	1	0	
0x0000										0x0				0x0000				0x0				Reset

SDHOST_LP_ENABLE Disable clock when the card is in IDLE state. One bit per card. (R/W)

- 0: clock disabled;
- 1: clock enabled.

SDHOST_CCLK_ENABLE Clock-enable control for two SD card clocks and one MMC card clock is supported. One bit per card. (R/W)

- 0: Clock disabled;
- 1: Clock enabled.

Register 34.5. SDHOST_TMOUT_REG (0x0014)

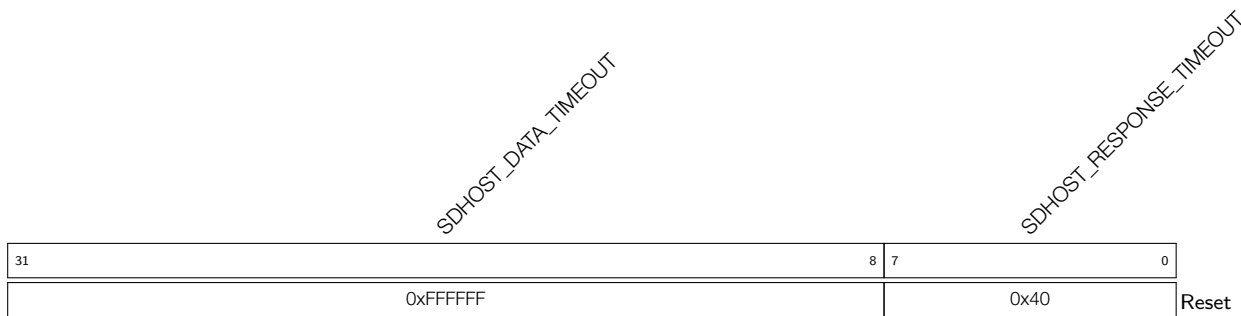

SDHOST_DATA_TIMEOUT Value for card data read timeout. This value is also used for data starvation by host timeout. The timeout counter is started only after the card clock is stopped. This value is specified in number of card output clocks, i.e. `sdhost_cclk_out` of the selected card. (R/W)

NOTE: The software timer should be used if the timeout value is in the order of 100 ms. In this case, read data timeout interrupt needs to be disabled.

SDHOST_RESPONSE_TIMEOUT Response timeout value. Value is specified in terms of number of card output clocks, i.e., `sdhost_cclk_out`. (R/W)

Register 34.6. SDHOST_CTYPE_REG (0x0018)

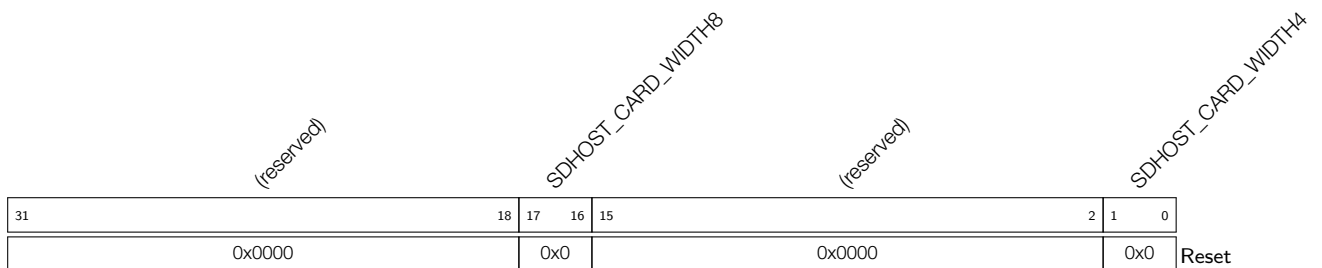

SDHOST_CARD_WIDTH8 One bit per card indicates if card is in 8-bit mode. (R/W)

0: Non 8-bit mode;

1: 8-bit mode.

Bit[17:16] correspond to card[1:0] respectively.

SDHOST_CARD_WIDTH4 One bit per card indicates if card is 1-bit or 4-bit mode. (R/W)

0: 1-bit mode;

1: 4-bit mode.

Bit[1:0] correspond to card[1:0] respectively.

Register 34.7. SDHOST_BLKSIZE_REG (0x001C)

<i>(reserved)</i>																<i>SDHOST_BLOCK_SIZE</i>																																																																																																																
31																16	15															0																																																																																																
0																x																0																0																0																0																0																0x200																Reset

SDHOST_BLOCK_SIZE Block size. (R/W)

Register 34.8. SDHOST_BYTCNT_REG (0x0020)

31																																0
0x200																																Reset

SDHOST_BYTCNT_REG Number of bytes to be transferred, should be an integral multiple of Block Size for block transfers. For data transfers of undefined byte lengths, byte count should be set to 0. When byte count is set to 0, it is the responsibility of host to explicitly send stop/abort command to terminate data transfer. (R/W)

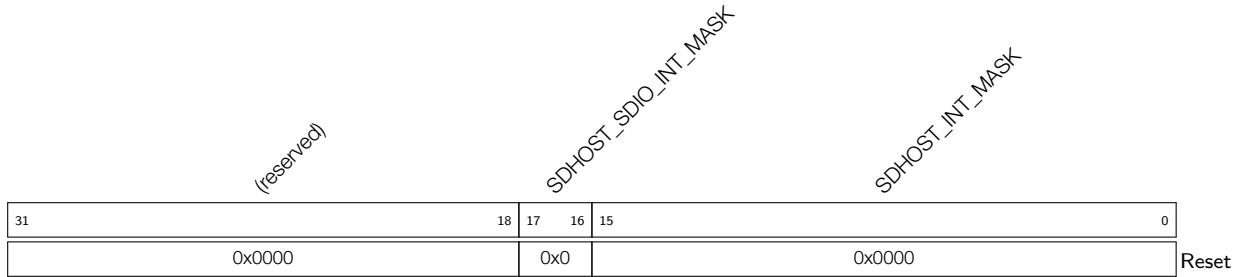
Register 34.9. SDHOST_INTMASK_REG (0x0024)

SDHOST_SDIO_INT_MASK SDIO interrupt mask, one bit for each card. Bit[17:16] correspond to card[15:0] respectively. When masked, SDIO interrupt detection for that card is disabled. 0 masks an interrupt, and 1 enables an interrupt. (R/W)

SDHOST_INT_MASK These bits used to mask unwanted interrupts. A value of 0 masks interrupt, and a value of 1 enables the interrupt. (R/W)

Bit 15 (EBE): End-bit error/no CRC error;

Bit 14 (ACD): Auto command done;

Bit 13 (SBE/BCI): Rx Start Bit Error;

Bit 12 (HLE): Hardware locked write error;

Bit 11 (FRUN): FIFO underrun/overflow error;

Bit 10 (HTO): Data starvation-by-host timeout;

Bit 9 (DRTO): Data read timeout;

Bit 8 (RTO): Response timeout;

Bit 7 (DCRC): Data CRC error;

Bit 6 (RCRC): Response CRC error;

Bit 5 (RXDR): Receive FIFO data request;

Bit 4 (TXDR): Transmit FIFO data request;

Bit 3 (DTO): Data transfer over;

Bit 2 (CD): Command done;

Bit 1 (RE): Response error;

Bit 0 (CD): Card detect.

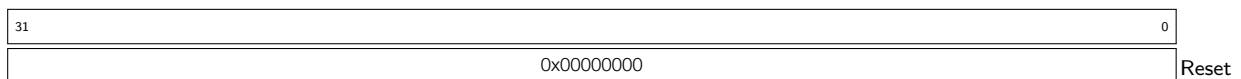
Register 34.10. SDHOST_CMDARG_REG (0x0028)

SDHOST_CMDARG_REG Value indicates command argument to be passed to the card. (R/W)

Register 34.11. SDHOST_CMD_REG (0x002C)

Continued from the previous page...

SDHOST_UPDATE_CLOCK_REGISTERS_ONLY 0: Normal command sequence; 1: Do not send commands, just update clock register value into card clock domain. (R/W)

Following register values are transferred into card clock domain: CLKDIV, CLRSRC, and CLKENA. Changes card clocks (change frequency, truncate off or on, and set low-frequency mode). This is provided in order to change clock frequency or stop clock without having to send command to cards.

During normal command sequence, when `sdhost_update_clock_registers_only = 0`, following control registers are transferred from BIU to CIU: CMD, CMDARG, TMOUT, CTYPE, BLKSIZ, and BYTCNT. CIU uses new register values for new command sequence to card(s). When bit is set, there are no Command Done interrupts because no command is sent to SD_MMC_CEATA cards.

SDHOST_CARD_NUMBER Card number in use. Represents physical slot number of card being accessed. In SD-only mode, up to two cards are supported. (R/W)

SDHOST_SEND_INITIALIZATION 0: Do not send initialization sequence (80 clocks of 1) before sending this command; 1: Send initialization sequence before sending this command. (R/W)

After powered on, 80 clocks must be sent to card for initialization before sending any commands to card. Bit should be set while sending first command to card so that controller will initialize clocks before sending command to card.

SDHOST_STOP_ABORT_CMD 0: Neither stop nor abort command can stop current data transfer. If abort is sent to function-number currently selected or not in data-transfer mode, then bit should be set to 0; 1: Stop or abort command intended to stop current data transfer in progress. (R/W)

When open-ended or predefined data transfer is in progress, and host issues stop or abort command to stop data transfer, bit should be set so that command/data state-machines of CIU can return correctly to idle state.

SDHOST_WAIT_PRVDATA_COMPLETE 0: Send command at once, even if previous data transfer has not completed; 1: Wait for previous data transfer to complete before sending Command. (R/W)

The `SDHOST_WAIT_PRVDATA_COMPLETE = 0` option is typically used to query status of card during data transfer or to stop current data transfer. `SDHOST_CARD_NUMBER` should be same as in previous command.

SDHOST_SEND_AUTO_STOP 0: No stop command is sent at the end of data transfer; 1: Send stop command at the end of data transfer. (R/W)

Continued on the next page...

Register 34.11. SDHOST_CMD_REG (0x002C)

Continued from the previous page ...

SDHOST_TRANSFER_MODE 0: Block data transfer command; 1: Stream data transfer command.
(R/W)

Don't care if no data expected.

SDHOST_READ_WRITE 0: Read from card; 1: Write to card.

Don't care if no data is expected from card. (R/W)

SDHOST_DATA_EXPECTED 0: No data transfer expected; 1: Data transfer expected. (R/W)

SDHOST_CHECK_RESPONSE_CRC 0: Do not check; 1: Check response CRC.

Some of command responses do not return valid CRC bits. Software should disable CRC checks for those commands in order to disable CRC checking by controller. (R/W)

SDHOST_RESPONSE_LENGTH 0: Short response expected from card; 1: Long response expected from card. (R/W)

SDHOST_RESPONSE_EXPECT 0: No response expected from card; 1: Response expected from card. (R/W)

SDHOST_CMD_INDEX Command index. (R/W)

Register 34.12. SDHOST_RESP0_REG (0x0030)

31	0
0x00000000	
Reset	

SDHOST_RESP0_REG Bit[31:0] of response. (RO)

Register 34.13. SDHOST_RESP1_REG (0x0034)

31	0
0x00000000	
Reset	

SDHOST_RESP1_REG Bit[63:32] of long response. (RO)

Register 34.14. SDHOST_RESP2_REG (0x0038)

31	0
0x00000000	
Reset	

SDHOST_RESP2_REG Bit[95:64] of long response. (RO)

Register 34.15. SDHOST_RESP3_REG (0x003C)

31	0
0x00000000	
Reset	

SDHOST_RESP3_REG Bit[127:96] of long response. (RO)

Register 34.16. SDHOST_MINTSTS_REG (0x0040)

<i>(reserved)</i>		<i>SDHOST_SDIO_INTERRUPT_MSK</i>		<i>SDHOST_INT_STATUS_MSK</i>	
31	18	17	16	15	0
0x0000		0x0		0x0000	
Reset					

SDHOST_SDIO_INTERRUPT_MSK Interrupt from SDIO card, one bit for each card. Bit[17:16] correspond to card1 and card0, respectively. SDIO interrupt for card is enabled only if corresponding sdhost_sdio_int_mask bit is set in Interrupt mask register (Setting mask bit enables interrupt). (RO)

SDHOST_INT_STATUS_MSK Interrupt enabled only if corresponding bit in interrupt mask register is set. (RO)

Bit 15 (EBE): End-bit error/no CRC error;

Bit 14 (ACD): Auto command done;

Bit 13 (SBE/BCI): RX Start Bit Error;

Bit 12 (HLE): Hardware locked write error;

Bit 11 (FRUN): FIFO underrun/overflow error;

Bit 10 (HTO): Data starvation by host timeout (HTO);

Bit 9 (DTRO): Data read timeout;

Bit 8 (RTO): Response timeout;

Bit 7 (DCRC): Data CRC error;

Bit 6 (RCRC): Response CRC error;

Bit 5 (RXDR): Receive FIFO data request;

Bit 4 (TXDR): Transmit FIFO data request;

Bit 3 (DTO): Data transfer over;

Bit 2 (CD): Command done;

Bit 1 (RE): Response error;

Bit 0 (CD): Card detect.

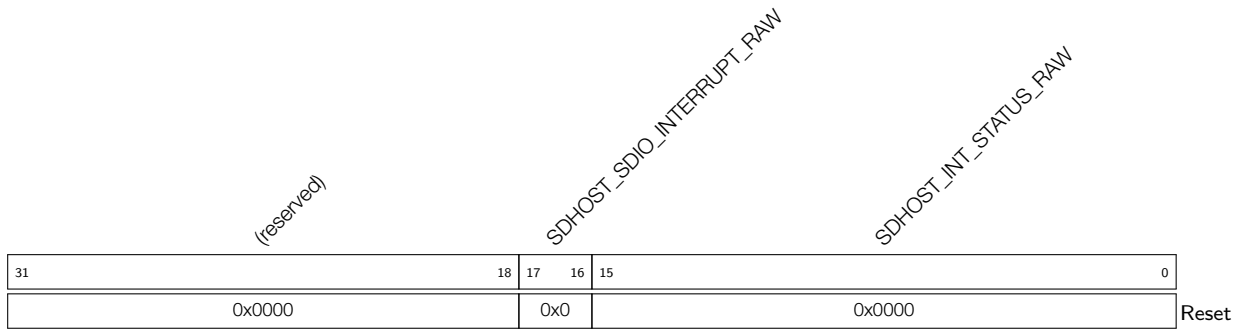
Register 34.17. SDHOST_RINTSTS_REG (0x0044)

SDHOST_SDIO_INTERRUPT_RAW Interrupt from SDIO card, one bit for each card. Bit[17:16] correspond to card1 and card0, respectively. Setting a bit clears the corresponding interrupt bit and writing 0 has no effect. (R/W)

0: No SDIO interrupt from card;

1: SDIO interrupt from card.

SDHOST_INT_STATUS_RAW Setting a bit clears the corresponding interrupt and writing 0 has no effect. Bits are logged regardless of interrupt mask status. (R/W)

Bit 15 (EBE): End-bit error/no CRC error;

Bit 14 (ACD): Auto command done;

Bit 13 (SBE/BCI): RX Start Bit Error;

Bit 12 (HLE): Hardware locked write error;

Bit 11 (FRUN): FIFO underrun/overflow error;

Bit 10 (HTO): Data starvation by host timeout (HTO);

Bit 9 (DTRO): Data read timeout;

Bit 8 (RTO): Response timeout;

Bit 7 (DCRC): Data CRC error;

Bit 6 (RCRC): Response CRC error;

Bit 5 (RXDR): Receive FIFO data request;

Bit 4 (TXDR): Transmit FIFO data request;

Bit 3 (DTO): Data transfer over;

Bit 2 (CD): Command done;

Bit 1 (RE): Response error;

Bit 0 (CD): Card detect.

Register 34.18. SDHOST_STATUS_REG (0x0048)

(reserved)		SDHOST_FIFO_COUNT					SDHOST_RESPONSE_INDEX			SDHOST_DATA_STATE_MC_BUSY		SDHOST_DATA_BUSY		SDHOST_DATA_3_STATUS		SDHOST_COMMAND_FSM_STATES			
31	30	29	17	16	11	10	9	8	7	4	3	2	1	0					
0	0	0x000					0x00			1	1	1	0x1		0	1	1	0	Reset

SDHOST_FIFO_COUNT FIFO count, number of filled locations in FIFO. (RO)

SDHOST_RESPONSE_INDEX Index of previous response, including any auto-stop sent by core. (RO)

SDHOST_DATA_STATE_MC_BUSY Data transmit or receive state-machine is busy. (RO)

SDHOST_DATA_BUSY Inverted version of raw selected sdhost_card_data[0].

0: Card data not busy;

1: Card data busy. (RO)

SDHOST_DATA_3_STATUS Raw selected sdhost_card_data[3], checks whether card is present.

0: card not present;

1: card present. (RO)

SDHOST_COMMAND_FSM_STATES Command FSM states. (RO)

0: Idle;

1: Send init sequence;

2: Send cmd start bit;

3: Send cmd tx bit;

4: Send cmd index + arg;

5: Send cmd crc7;

6: Send cmd end bit;

7: Receive resp start bit;

8: Receive resp IRQ response;

9: Receive resp tx bit;

10: Receive resp cmd idx;

11: Receive resp data;

12: Receive resp crc7;

13: Receive resp end bit;

14: Cmd path wait NCC;

15: Wait, cmd-to-response turnaround.

Continued on the next page...

Register 34.18. SDHOST_STATUS_REG (0x0048)

Continued from the previous page ...

SDHOST_FIFO_FULL FIFO is full status. (RO)

SDHOST_FIFO_EMPTY FIFO is empty status. (RO)

SDHOST_FIFO_TX_WATERMARK FIFO reached Transmit watermark level, not qualified with data transfer. (RO)

SDHOST_FIFO_RX_WATERMARK FIFO reached Receive watermark level, not qualified with data transfer. (RO)

Register 34.19. SDHOST_FIFOTH_REG (0x004C)

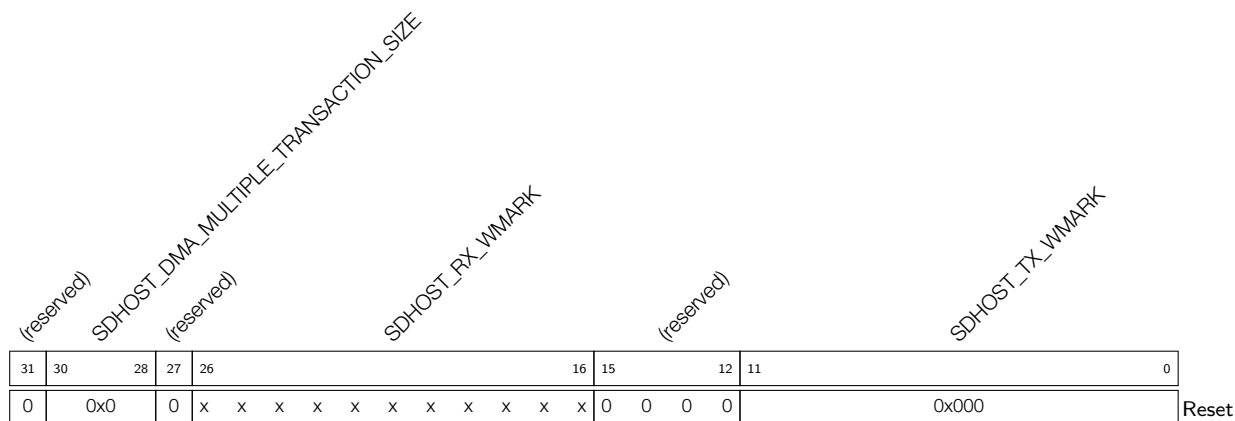

SDHOST_DMA_MULTIPLE_TRANSACTION_SIZE Burst size of multiple transaction, should be programmed same as DMA controller multiple-transaction-size SDHOST_SRC/DEST_MSIZ. (R/W)
 000: 1-byte transfer;
 001: 4-byte transfer;
 010: 8-byte transfer;
 011: 16-byte transfer;
 100: 32-byte transfer;
 101: 64-byte transfer;
 110: 128-byte transfer;
 111: 256-byte transfer.

SDHOST_RX_WMARK FIFO threshold watermark level when receiving data to card. When FIFO data count reaches greater than this number, DMA/FIFO request is raised. During end of packet, request is generated regardless of threshold programming in order to complete any remaining data. In non-DMA mode, when receiver FIFO threshold (RXDR) interrupt is enabled, then interrupt is generated instead of DMA request. During end of packet, interrupt is not generated if threshold programming is larger than any remaining data. It is responsibility of host to read remaining bytes on seeing Data Transfer Done interrupt. In DMA mode, at end of packet, even if remaining bytes are less than threshold, DMA request does single transfers to flush out any remaining bytes before Data Transfer Done interrupt is set. (R/W)

SDHOST_TX_WMARK FIFO threshold watermark level when transmitting data to card. When FIFO data count is less than or equal to this number, DMA/FIFO request is raised. If Interrupt is enabled, then interrupt occurs. During end of packet, request or interrupt is generated, regardless of threshold programming. In non-DMA mode, when transmit FIFO threshold (TXDR) interrupt is enabled, then interrupt is generated instead of DMA request. During end of packet, on last interrupt, host is responsible for filling FIFO with only required remaining bytes (not before FIFO is full or after CIU completes data transfers, because FIFO may not be empty). In DMA mode, at end of packet, if last transfer is less than burst size, DMA controller does single cycles until required bytes are transferred. (R/W)

Register 34.20. SDHOST_CDETECT_REG (0x0050)

31	<i>(reserved)</i>	2	1	0	
0x0000000				0x0	Reset

SDHOST_CARD_DETECT_N Value on sdhost_card_detect_n input ports (1 bit per card), read-only bits. 0 represents presence of card. Only NUM_CARDS number of bits are implemented. (RO)

Register 34.21. SDHOST_WRTPRT_REG (0x0054)

31	<i>(reserved)</i>	2	1	0	
0x0000000				0x0	Reset

SDHOST_WRITE_PROTECT Value on sdhost_card_write_prt input ports (1 bit per card). 1 represents write protection. Only NUM_CARDS number of bits are implemented. (RO)

Register 34.22. SDHOST_TCBCNT_REG (0x005C)

31		0
0x00000000		Reset

SDHOST_TCBCNT_REG Number of bytes transferred by CIU unit to card. (RO)

Register 34.23. SDHOST_TBBCNT_REG (0x0060)

31		0
0x00000000		Reset

SDHOST_TBBCNT_REG Number of bytes transferred between Host/DMA memory and BIU FIFO. (RO)

Register 34.24. SDHOST_DEBNCE_REG (0x0064)

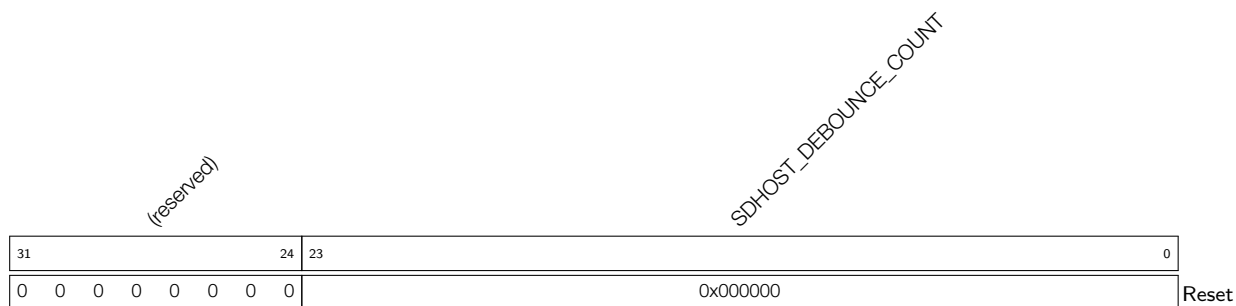

SDHOST_DEBOUNCE_COUNT Number of host clocks (clk) used by debounce filter logic. The typical debounce time is 5 ~ 25 ms to prevent the card instability when the card is inserted or removed. (R/W)

Register 34.25. SDHOST_USRID_REG (0x0068)

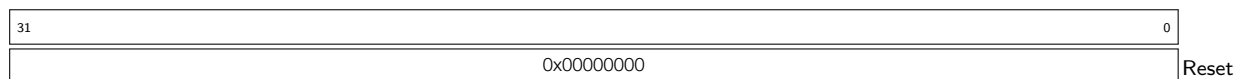

SDHOST_USRID_REG User identification register, value set by user. Can also be used as a scratch-pad register by user. (R/W)

Register 34.26. SDHOST_VERID_REG (0x006C)

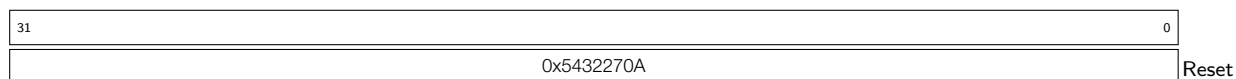

SDHOST_VERSIONID_REG Hardware version register. Can also be read by firmware. (RO)

Register 34.27. SDHOST_HCON_REG (0x0070)

(reserved)				(reserved)				(SDHOST_NUM_CLK_DIV_REG)				(reserved)				(SDHOST_HOLD_REG)				(SDHOST_RAM_INDISE_REG)				(SDHOST_DMA_WIDTH_REG)				(reserved)				(SDHOST_ADDR_WIDTH_REG)				(SDHOST_DATA_WIDTH_REG)				(SDHOST_BUS_TYPE_REG)				(SDHOST_CARD_NUM_REG)				SDHOST_CARD_TYPE_REG			
31	27	26	25	24	23	22	21	20	18	17	16	15	10	9	7	6	5	1	0																																
0x0				0x0				0x3				0x1				0x0				0x1				0x0				0x13				0x1				0x1				0x1				0x1				Reset			

SDHOST_NUM_CLK_DIV_REG Have 4 clk divider in design . (RO)

SDHOST_HOLD_REG Have a hold register in data path . (RO)

SDHOST_RAM_INDISE_REG Inside RAM in SDMMC module. (RO)

SDHOST_DMA_WIDTH_REG DMA data width is 32. (RO)

SDHOST_ADDR_WIDTH_REG Register address width is 32. (RO)

SDHOST_DATA_WIDTH_REG Register data width is 32. (RO)

SDHOST_BUS_TYPE_REG Register config is APB bus. (RO)

SDHOST_CARD_NUM_REG Support card number is 2. (RO)

SDHOST_CARD_TYPE_REG Hardware support SDIO and MMC. (RO)

Register 34.28. SDHOST_UHS_REG (0x0074)

reserved												(SDHOST_DDR_REG)				reserved												
31	18	17	16	15	0																							
0x0000												0x0				0x0000												Reset

SDHOST_DDR_REG DDR mode selecton, 1 bit for each card. (R/W)

0-Non-DDR mode.

1-DDR mode.

Register 34.29. SDHOST_RST_N_REG (0x0078)

(reserved)		SDHOST_RST_CARD_RESET	
31	2	1	0
0x00000000		0x1	
		Reset	

SDHOST_RST_CARD_RESET Hardware reset.

1: Active mode;

0: Reset.

These bits cause the cards to enter pre-idle state, which requires them to be re-initialized. SDHOST_RST_CARD_RESET[0] should be set to 1'b0 to reset card0, SDHOST_RST_CARD_RESET[1] should be set to 1'b0 to reset card1. (R/W)

Register 34.32. SDHOST_DBADDR_REG (0x0088)

31	0
0x00000000	

Reset

SDHOST_DBADDR_REG Start of Descriptor List. Contains the base address of the First Descriptor. The LSB bits [1:0] are ignored and taken as all-zero by the IDMAC internally. Hence these LSB bits may be treated as read-only. (R/W)

Register 34.33. SDHOST_IDSTS_REG (0x008C)

Continued from the previous page...

SDHOST_IDSTS_CES Card Error Summary. Indicates the status of the transaction to/from the card, also present in RINTSTS. Indicates the logical OR of the following bits: (R/W)

EBE : End Bit Error;

RTO : Response Timeout/Boot Ack Timeout;

RCRC : Response CRC;

SBE : Start Bit Error;

DRTO : Data Read Timeout/BDS timeout;

DCRC : Data CRC for Receive;

RE : Response Error.

Writing 1 clears this bit. The abort condition of the IDMAC depends on the setting of this CES bit. If the CES bit is enabled, then the IDMAC aborts on a response error.

SDHOST_IDSTS_DU Descriptor Unavailable Interrupt. This bit is set when the descriptor is unavailable due to OWNER bit = 0 (DES0[31] = 0). Writing 1 clears this bit. (R/W)

SDHOST_IDSTS_FBE Fatal Bus Error Interrupt. Indicates that a Bus Error occurred (IDSTS[12:10]). When this bit is set, the DMA disables all its bus accesses. Writing 1 clears this bit. (R/W)

SDHOST_IDSTS_RI Receive Interrupt. Indicates the completion of data reception for a descriptor. Writing 1 clears this bit. (R/W)

SDHOST_IDSTS_TI Transmit Interrupt. Indicates that data transmission is finished for a descriptor. Writing 1 clears this bit. (R/W)

Register 34.34. SDHOST_IDINTEN_REG (0x0090)

(reserved)										SDHOST_IDINTEN_AI		SDHOST_IDINTEN_NI		(reserved)		SDHOST_IDINTEN_CES		SDHOST_IDINTEN_DU		SDHOST_IDINTEN_FBE		SDHOST_IDINTEN_RI		SDHOST_IDINTEN_TI	
31											10	9	8	7	6	5	4	3	2	1	0				
0										0										0				Reset	

SDHOST_IDINTEN_AI Abnormal Interrupt Summary Enable. When set, an abnormal interrupt is enabled. This bit enables the following bits:

IDINTEN[2]: Fatal Bus Error Interrupt; (R/W)

IDINTEN[4]: DU Interrupt.

SDHOST_IDINTEN_NI Normal Interrupt Summary Enable. When set, a normal interrupt is enabled.

When reset, a normal interrupt is disabled. This bit enables the following bits: (R/W)

IDINTEN[0]: Transmit Interrupt;

IDINTEN[1]: Receive Interrupt.

SDHOST_IDINTEN_CES Card Error summary Interrupt Enable. When set, it enables the Card Interrupt summary. (R/W)

SDHOST_IDINTEN_DU Descriptor Unavailable Interrupt. When set along with Abnormal Interrupt Summary Enable, the DU interrupt is enabled. (R/W)

SDHOST_IDINTEN_FBE Fatal Bus Error Enable. When set with Abnormal Interrupt Summary Enable, the Fatal Bus Error Interrupt is enabled. When reset, Fatal Bus Error Enable Interrupt is disabled. (R/W)

SDHOST_IDINTEN_RI Receive Interrupt Enable. When set with Normal Interrupt Summary Enable, Receive Interrupt is enabled. When reset, Receive Interrupt is disabled. (R/W)

SDHOST_IDINTEN_TI Transmit Interrupt Enable. When set with Normal Interrupt Summary Enable, Transmit Interrupt is enabled. When reset, Transmit Interrupt is disabled. (R/W)

Register 34.35. SDHOST_DSCADDR_REG (0x0094)

31																																0	
0x00000000																																	Reset

SDHOST_DSCADDR_REG Host Descriptor Address Pointer, updated by IDMAC during operation and cleared on reset. This register points to the start address of the current descriptor read by the IDMAC. (RO)

Register 34.36. SDHOST_BUFADDR_REG (0x0098)

31	0
0x00000000	
Reset	

SDHOST_BUFADDR_REG Host Buffer Address Pointer, updated by IDMAC during operation and cleared on reset. This register points to the current Data Buffer Address being accessed by the IDMAC. (RO)

Register 34.37. SDHOST_CARDTHRCTL_REG (0x0100)

<i>(SDHOST_CARDTHRESHOLD_REG)</i>																<i>(reserved)</i>				<i>(SDHOST_CARDWRTHREN_REG)</i>			<i>(SDHOST_CARDCLRINTEN_REG)</i>			<i>(SDHOST_CARDRDTHREN_REG)</i>		
31															16	15				3	2	1	0					
0x000																0x00				0	0	0				Reset		

SDHOST_CARDTHRESHOLD_REG The inside FIFO size is 512, This register is applicable when SDHOST_CARDERTHREN_REG is set to 1 or SDHOST_CARDRDTHREN_REG set to 1. (R/W)

SDHOST_CARDWRTHREN_REG Applicable when HS400 mode is enabled. (R/W)

1'b0-Card write Threshold disabled.

1'b1-Card write Threshold enabled.

SDHOST_CARDCLRINTEN_REG Busy clear interrupt generation: (R/W)

1'b0-Busy clear interrupt disabled.

1'b1-Busy clear interrupt enabled.

SDHOST_CARDRDTHREN_REG Card read threshold enable. (R/W)

1'b0-Card read threshold disabled.

1'b1-Card read threshold enabled.

Register 34.38. SDHOST_EMMC_DDR_REG (0x010C)

(SDHOST_HS400_MODE_REG)		(reserved)										(SDHOST_HALFSTARTBIT_REG)			
31	30											2	1	0	
0x0		0x000000										0x0			Reset

SDHOST_HS400_MODE_REG Set 1 to enable HS400 mode. (R/W)

SDHOST_HALFSTARTBIT_REG Control for start bit detection mechanism duration of start bit. Each bit refers to one slot. Set this bit to 1 for eMMC4.5 and above, set to 0 for SD applications. For eMMC4.5, start bit can be: (R/W)

1'b0-Full cycle.

1'b1-less than one full cycle.

Register 34.39. SDHOST_ENSHIFT_REG (0x0110)

(reserved)										(SDHOST_ENABLE_SHIFT_REG)			
31											4	3	0
0x0000000										0x0			Reset

DHOST_ENABLE_SHIFT_REG Control for the amount of phase shift provided on the default enables in the design. Two bits assigned for each card. (R/W)

2'b00-Default phase shift.

2'b01-Enables shifted to next immediate positive edge.

2'b10-Enables shifted to next immediate negative edge.

2'b11-Reserved.

Register 34.40. SDHOST_BUFFIFO_REG (0x0200)

31																															0	
0x00000000																																Reset

SDHOST_BUFFIFO_REG CPU write and read transmit data by FIFO. This register points to the current Data FIFO. (RO)

Register 34.41. SDHOST_CLK_DIV_EDGE_REG (0x0800)

(reserved)		(SDHOST_CLK_SOURCE_REG)		(reserved)		SDHOST_CCLKIN_EDGE_N		SDHOST_CCLKIN_EDGE_L		SDHOST_CCLKIN_EDGE_H		SDHOST_CCLKIN_EDGE_SLF_SEL		SDHOST_CCLKIN_EDGE_SAM_SEL		SDHOST_CCLKIN_EDGE_DRV_SEL	
32	24	23	22	21	20	17	16	13	12	9	8	6	5	3	2	0	
0x000		0x0	0x0	0x1		0x0		0x1		0x0		0x0		0x0		0x0	Reset

SDHOST_CLK_SOURCE_REG Set to 1 to use 160M PLL clock ,Set to 0 to use 40M XTAL clock.
(R/W)

CCLKIN_EDGE_N This value should be equal to CCLKIN_EDGE_L. (R/W)

CCLKIN_EDGE_L The low level of the divider clock. The value should be larger than CCLKIN_EDGE_H. (R/W)

CCLKIN_EDGE_H The high level of the divider clock. The value should be smaller than CCLKIN_EDGE_L. (R/W)

CCLKIN_EDGE_SLF_SEL It is used to select the clock phase of the internal signal from phase90, phase180, or phase270. (R/W)

CCLKIN_EDGE_SAM_SEL It is used to select the clock phase of the input signal from phase90, phase180, or phase270. (R/W)

CCLKIN_EDGE_DRV_SEL It is used to select the clock phase of the output signal from phase90, phase180, or phase270. (R/W)

Note: SD/MMC use this register to divide the 160M clock(CCLKIN_EDGE_H/CCLKIN_EDGE_L). The output clock connect to sdio slave divider by this register and SDHOST_CLKDIV_REG,there are 4 clock source to selected by SDHOST_CLKSRC_REG register.

35 LED PWM Controller (LEDC)

35.1 Overview

The LED PWM Controller is a peripheral designed to generate PWM signals for LED control. It has specialized features such as automatic duty cycle fading. However, the LED PWM Controller can also be used to generate PWM signals for other purposes.

35.2 Features

The LED PWM Controller has the following features:

- Eight independent PWM generators (i.e. eight channels)
- Four independent timers that support division by fractions
- Automatic duty cycle fading (i.e. gradual increase/decrease of a PWM's duty cycle without interference from the processors) with interrupt generation on fade completion
- Adjustable phase of PWM signal output
- PWM signal output in low-power mode (Light-sleep mode)
- Maximum PWM resolution: 14 bits

Note that the four timers are identical regarding their features and operation. The following sections refer to the timers collectively as Timer x (where x ranges from 0 to 3). Likewise, the eight PWM generators are also identical in features and operation, and thus are collectively referred to as PWM n (where n ranges from 0 to 7).

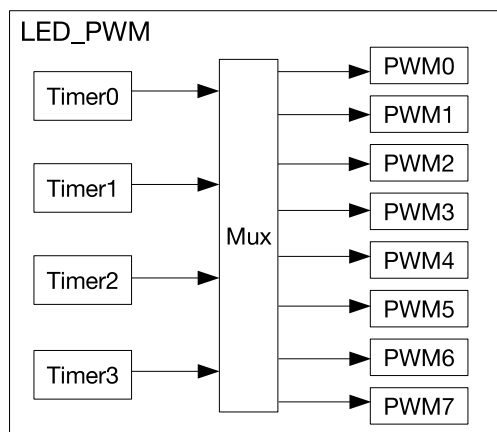

Figure 35-1. LED PWM Architecture

35.3 Functional Description

35.3.1 Architecture

Figure 35-1 shows the architecture of the LED PWM Controller.

The four timers can be independently configured (i.e. clock divider, and counter overflow value) and each internally maintains a timebase counter (i.e. a counter that counts on cycles of a reference clock). Each PWM

generator will select one of the timers and uses the timer's counter value as a reference to generate its PWM signal.

Figure 35-2 illustrates the main functional blocks of the timer and the PWM generator.

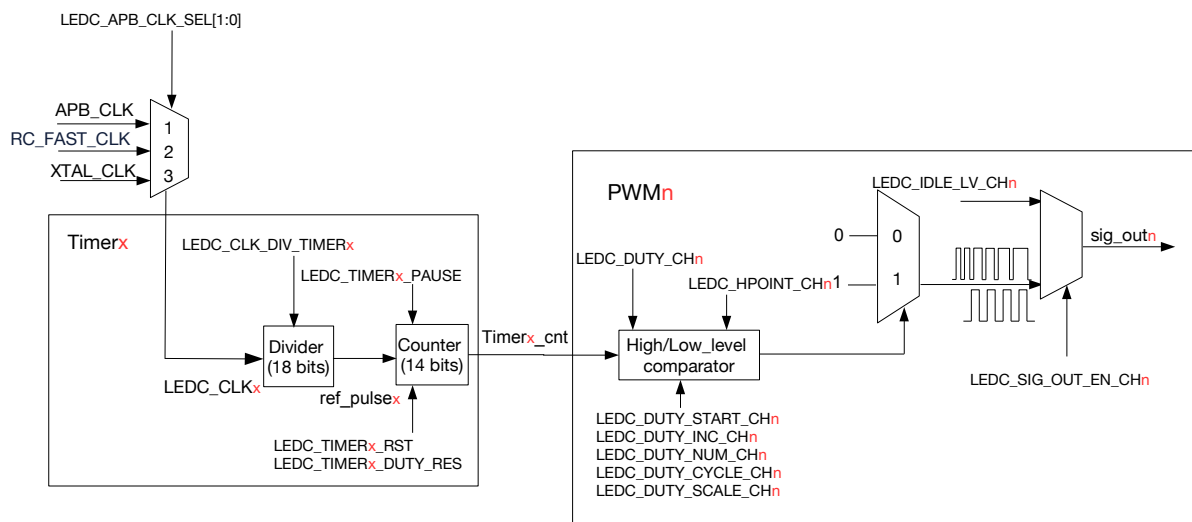

Figure 35-2. LED PWM Generator Diagram

35.3.2 Timers

Each timer in LED PWM Controller internally maintains a timebase counter. Referring to Figure 35-2, this clock signal used by the timebase counter is named `ref_pulsex`. All timers use the same clock source `LEDC_CLKx`, which is then passed through a clock divider to generate `ref_pulsex` for the counter.

35.3.2.1 Clock Source

LED PWM registers configured by software are clocked by `APB_CLK`. For more information about `APB_CLK`, see Chapter 7 *Reset and Clock*. To use the LED PWM peripheral, the `APB_CLK` signal to the LED PWM has to be enabled. The `APB_CLK` signal to LED PWM can be enabled by setting the `SYSTEM_LEDC_CLK_EN` field in the register `SYSTEM_PERIP_CLK_EN0_REG` and be reset via software by setting the `SYSTEM_LEDC_RST` field in the register `SYSTEM_PERIP_RST_EN0_REG`. For more information, please refer to Table 17-1 in Chapter 17 *System Registers (SYSTEM)*.

Timers in the LED PWM Controller choose their common clock source from one of the following clock signals: `APB_CLK`, `RC_FAST_CLK` and `XTAL_CLK` (see Chapter 7 *Reset and Clock* for more details about each clock signal). The procedure for selecting a clock source signal for `LEDC_CLKx` is described below:

- `APB_CLK`: Set `LEDC_APB_CLK_SEL[1:0]` to 1
- `RC_FAST_CLK`: Set `LEDC_APB_CLK_SEL[1:0]` to 2
- `XTAL_CLK`: Set `LEDC_APB_CLK_SEL[1:0]` to 3

The `LEDC_CLKx` signal will then be passed through the clock divider.

35.3.2.2 Clock Divider Configuration

The LEDC_CLK x signal is passed through a clock divider to generate the ref_pulse x signal for the counter. The frequency of ref_pulse x is equal to the frequency of LEDC_CLK x divided by the divisor LEDC_CLK_DIV (see Figure 35-2).

The divisor LEDC_CLK_DIV is a fractional value. Thus, it can be a non-integer divisor. LEDC_CLK_DIV is configured according to the following equation.

$$LEDC_CLK_DIV = A + \frac{B}{256}$$

- A corresponds to the most significant 10 bits of LEDC_CLK_DIV_TIMER x (i.e. LEDC_TIMER x _CONF_REG[21:12])
- The fractional part B corresponds to the least significant 8 bits of LEDC_CLK_DIV_TIMER x (i.e. LEDC_TIMER x _CONF_REG[11:4])

When the fractional part B is zero, LEDC_CLK_DIV is equivalent to an integer divisor (i.e. an integer prescaler). In other words, a ref_pulse x clock pulse is generated after every A number of LEDC_CLK x clock pulses.

However, when B is nonzero, LEDC_CLK_DIV becomes a non-integer divisor. The clock divider implements non-integer frequency division by alternating between A and $(A+1)$ LEDC_CLK x clock pulses per ref_pulse x clock pulse. This will result in the average frequency of ref_pulse x clock pulse being the desired frequency (i.e. the non-integer divided frequency). For every 256 ref_pulse x clock pulses:

- A number of B ref_pulse x clock pulses will consist of $(A+1)$ LEDC_CLK x clock pulses
- A number of $(256-B)$ ref_pulse x clock pulses will consist of A LEDC_CLK x clock pulses
- The ref_pulse x clock pulses consisting of $(A+1)$ pulses are evenly distributed amongst those consisting of A pulses

Figure 35-3 illustrates the relation between LEDC_CLK x clock pulses and ref_pulse x clock pulses when dividing by a non-integer LEDC_CLK_DIV.

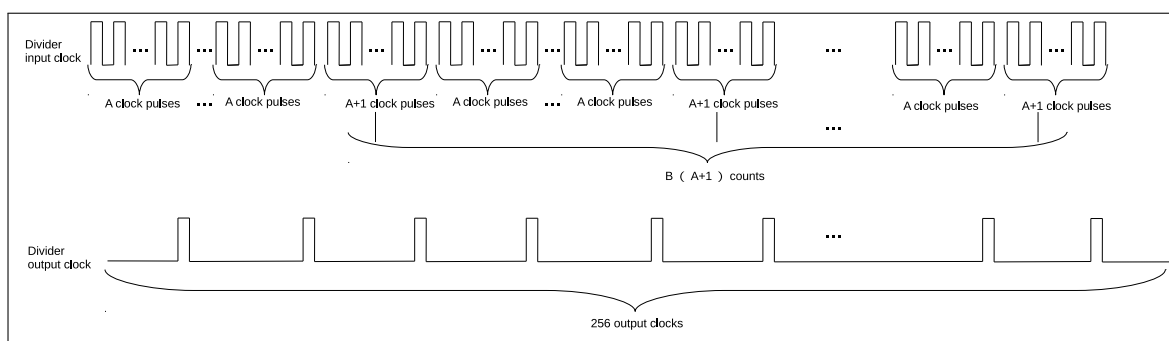

Figure 35-3. Frequency Division When LEDC_CLK_DIV is a Non-Integer Value

To change the timer's clock divisor at runtime, first configure the LEDC_CLK_DIV_TIMER x field, and then set the LEDC_TIMER x _PARA_UP field to apply the new configuration. This will cause the newly configured values to take effect upon the next overflow of the counter. LEDC_TIMER x _PARA_UP field will be automatically cleared by hardware.

35.3.2.3 14-bit Counter

Each timer contains a 14-bit timebase counter that uses `ref_pulsex` as its reference clock (see Figure 35-2). The `LEDC_TIMERx_DUTY_RES` field configures the overflow value of this 14-bit counter. Hence, the maximum resolution of the PWM signal is 14 bits. The counter counts up to $2^{\text{LEDC_TIMER}_x\text{_DUTY_RES}} - 1$, overflows and begins counting from 0 again. The counter's value can be read, reset, and suspended by software.

The counter can trigger `LEDC_TIMERx_OVF_INT` interrupt (generated automatically by hardware without configuration) every time the counter overflows. It can also be configured to trigger `LEDC_OVF_CNT_CHn_INT` interrupt after the counter overflows `LEDC_OVF_NUM_CHn + 1` times. To configure `LEDC_OVF_CNT_CHn_INT` interrupt, please:

1. Configure `LEDC_TIMER_SEL_CHn` as the counter for the PWM generator
2. Enable the counter by setting `LEDC_OVF_CNT_EN_CHn`
3. Set `LEDC_OVF_NUM_CHn` to the number of counter overflows to generate an interrupt, minus 1
4. Enable the overflow interrupt by setting `LEDC_OVF_CNT_CHn_INT_ENA`
5. Set `LEDC_TIMERx_DUTY_RES` to enable the timer and wait for a `LEDC_OVF_CNT_CHn_INT` interrupt

Referring to Figure 35-2, the frequency of a PWM generator output signal (`sig_outn`) is dependent on the frequency of the timer's clock source `LEDC_CLKx`, the clock divisor `LEDC_CLK_DIV`, and the duty resolution (counter width) `LEDC_TIMERx_DUTY_RES`:

$$f_{\text{PWM}} = \frac{f_{\text{LEDC_CLK}_x}}{\text{LEDC_CLK_DIV} \cdot 2^{\text{LEDC_TIMER}_x\text{_DUTY_RES}}}$$

Based on the formula above, the desired duty resolution can be calculated as follows:

$$\text{LEDC_TIMER}_x\text{_DUTY_RES} = \log_2 \left(\frac{f_{\text{LEDC_CLK}_x}}{f_{\text{PWM}} \cdot \text{LEDC_CLK_DIV}} \right)$$

Table 35-1 lists the commonly-used frequencies and their corresponding resolutions.

Table 35-1. Commonly-used Frequencies and Resolutions

LEDC_CLK _x	PWM Frequency	Highest Resolution (bit) ¹	Lowest Resolution (bit) ²
APB_CLK (80 MHz)	1 kHz	14	6
APB_CLK (80 MHz)	5 kHz	13	3
APB_CLK (80 MHz)	10 kHz	12	2
XTAL_CLK (40 MHz)	1 kHz	14	5
XTAL_CLK (40 MHz)	4 kHz	13	3
RC_FAST_CLK (17.5 MHz)	1 kHz	14	4
RC_FAST_CLK (17.5 MHz)	1.75 kHz	13	3

¹ The highest resolution is calculated when the clock divisor `LEDC_CLK_DIV` is 1. If the highest resolution calculated by the formula is higher than the counter's width 14 bits, then the highest resolution should be 14 bits.

² The lowest resolution is calculated when the clock divisor `LEDC_CLK_DIV` is $1023 + \frac{255}{256}$. If the lowest resolution calculated by the formula is lower than 0, then the lowest resolution should be 1.

To change the overflow value at runtime, first set the `LEDC_TIMER x _DUTY_RES` field, and then set the `LEDC_TIMER x _PARA_UP` field. This will cause the newly configured values to take effect upon the next overflow of the counter. If `LEDC_OVF_CNT_EN_CH n` field is reconfigured, `LEDC_PARA_UP_CH n` should be set to apply the new configuration. In summary, these configuration values need to be updated by setting `LEDC_TIMER x _PARA_UP` or `LEDC_PARA_UP_CH n` . `LEDC_TIMER x _PARA_UP` and `LEDC_PARA_UP_CH n` will be automatically cleared by hardware.

35.3.3 PWM Generators

To generate a PWM signal, a PWM generator (PWM n) selects a timer (Timer x). Each PWM generator can be configured separately by setting `LEDC_TIMER_SEL_CH n` to use one of four timers to generate the PWM output.

As shown in Figure 35-2, each PWM generator has a comparator and two multiplexers. A PWM generator compares the timer's 14-bit counter value (Timer x _cnt) to two trigger values Hpoint n and Lpoint n . When the timer's counter value is equal to Hpoint n or Lpoint n , the PWM signal is high or low, respectively, as described below:

- If `Timer x _cnt == Hpoint n` , `sig_out n` is 1.
- If `Timer x _cnt == Lpoint n` , `sig_out n` is 0.

Figure 35-4 illustrates how Hpoint n or Lpoint n are used to generate a fixed duty cycle PWM output signal.

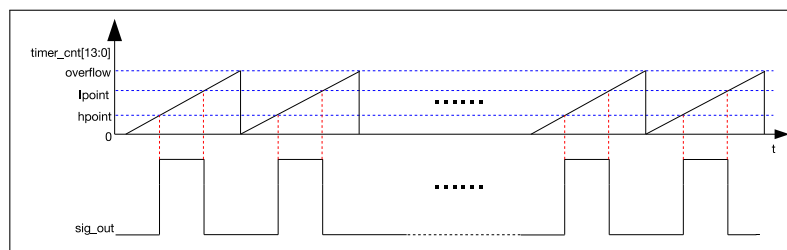

Figure 35-4. LED_PWM Output Signal Diagram

For a particular PWM generator (PWM n), its Hpoint n is sampled from the `LEDC_HPOINT_CH n` field each time the selected timer's counter overflows. Likewise, Lpoint n is also sampled on every counter overflow and is calculated from the sum of the `LEDC_DUTY_CH n [18:4]` and `LEDC_HPOINT_CH n` fields. By setting Hpoint n and Lpoint n via the `LEDC_HPOINT_CH n` and `LEDC_DUTY_CH n [18:4]` fields, the relative phase and duty cycle of the PWM output can be set.

The PWM output signal (`sig_out n`) is enabled by setting `LEDC_SIG_OUT_EN_CH n` . When `LEDC_SIG_OUT_EN_CH n` is cleared, PWM signal output is disabled, and the output signal (`sig_out n`) will output a constant level as specified by `LEDC_IDLE_LV_CH n` .

The bits `LEDC_DUTY_CH n [3:0]` are used to dither the duty cycles of the PWM output signal (`sig_out n`) by periodically altering the duty cycle of `sig_out n` . When `LEDC_DUTY_CH n [3:0]` is set to a non-zero value, then for every 16 cycles of `sig_out n` , `LEDC_DUTY_CH n [3:0]` of those cycles will have PWM pulses that are one timer tick longer than the other (16- `LEDC_DUTY_CH n [3:0]`) cycles. For instance, if `LEDC_DUTY_CH n [18:4]` is set to 10 and `LEDC_DUTY_CH n [3:0]` is set to 5, then 5 of 16 cycles will have a PWM pulse with a duty value of 11 and the rest of the 16 cycles will have a PWM pulse with a duty value of 10. The average duty cycle after 16 cycles is 10.3125.

If fields `LEDC_TIMER_SEL_CH n` , `LEDC_HPOINT_CH n` , `LEDC_DUTY_CH n [18:4]` and `LEDC_SIG_OUT_EN_CH n` are reconfigured, `LEDC_PARA_UP_CH n` must be set to apply the new configuration. This will cause the newly configured values to take effect upon the next overflow of the counter. `LEDC_PARA_UP_CH n` field will be automatically cleared by hardware.

35.3.4 Duty Cycle Fading

The PWM generators can fade the duty cycle of a PWM output signal (i.e. gradually change the duty cycle from one value to another). If Duty Cycle Fading is enabled, the value of `Lpoint n` will be incremented/decremented after a fixed number of counter overflows occurs. Figure 35-5 illustrates Duty Cycle Fading.

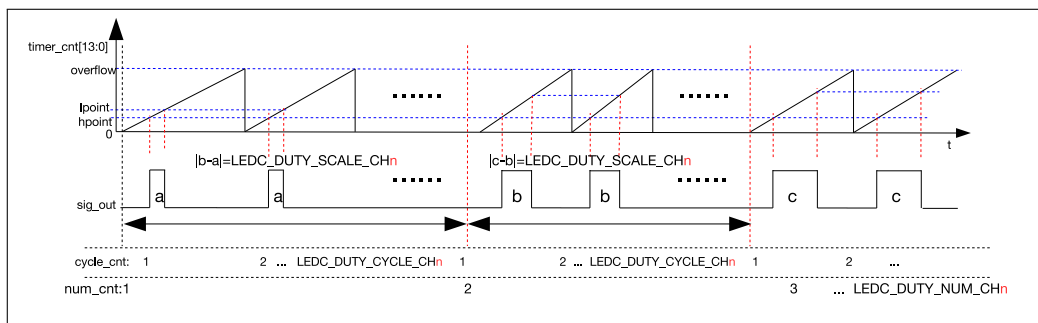

Figure 35-5. Output Signal Diagram of Fading Duty Cycle

Duty Cycle Fading is configured using the following register fields:

- `LEDC_DUTY_CH n` is used to set the initial value of `Lpoint n` .
- `LEDC_DUTY_START_CH n` will enable/disable duty cycle fading when set/cleared.
- `LEDC_DUTY_CYCLE_CH n` sets the number of counter overflow cycles for every `Lpoint n` increment/decrement. In other words, `Lpoint n` will be incremented/decremented after `LEDC_DUTY_CYCLE_CH n` counter overflows.
- `LEDC_DUTY_INC_CH n` configures whether `Lpoint n` is incremented/decremented if set/cleared.
- `LEDC_DUTY_SCALE_CH n` sets the amount that `Lpoint n` is incremented/decremented.
- `LEDC_DUTY_NUM_CH n` sets the maximum number of increments/decrements before duty cycle fading stops.

If the fields `LEDC_DUTY_CH n` , `LEDC_DUTY_START_CH n` , `LEDC_DUTY_CYCLE_CH n` , `LEDC_DUTY_INC_CH n` , `LEDC_DUTY_SCALE_CH n` , and `LEDC_DUTY_NUM_CH n` are reconfigured, `LEDC_PARA_UP_CH n` must be set to apply the new configuration. After this field is set, the values for duty cycle fading will take effect at once. `LEDC_PARA_UP_CH n` field will be automatically cleared by hardware.

35.3.5 Interrupts

- `LEDC_OVF_CNT_CH n _INT`: Triggered when the timer counter overflows for $(LEDC_OVF_NUM_CH n + 1)$ times and the register `LEDC_OVF_CNT_EN_CH n` is set to 1.
- `LEDC_DUTY_CHNG_END_CH n _INT`: Triggered when a fade on an LED PWM generator has finished.
- `LEDC_TIMER x _OVF_INT`: Triggered when an LED PWM timer has reached its maximum counter value.

35.4 Register Summary

The addresses in this section are relative to **LED PWM Controller** base address provided in Table 4-3 in Chapter 4 *System and Memory*.

The abbreviations given in Column **Access** are explained in Section [Access Types for Registers](#).

Name	Description	Address	Access
Configuration Register			
LEDC_CH0_CONF0_REG	Configuration register 0 for channel 0	0x0000	varies
LEDC_CH0_CONF1_REG	Configuration register 1 for channel 0	0x000C	R/W
LEDC_CH1_CONF0_REG	Configuration register 0 for channel 1	0x0014	varies
LEDC_CH1_CONF1_REG	Configuration register 1 for channel 1	0x0020	R/W
LEDC_CH2_CONF0_REG	Configuration register 0 for channel 2	0x0028	varies
LEDC_CH2_CONF1_REG	Configuration register 1 for channel 2	0x0034	R/W
LEDC_CH3_CONF0_REG	Configuration register 0 for channel 3	0x003C	varies
LEDC_CH3_CONF1_REG	Configuration register 1 for channel 3	0x0048	R/W
LEDC_CH4_CONF0_REG	Configuration register 0 for channel 4	0x0050	varies
LEDC_CH4_CONF1_REG	Configuration register 1 for channel 4	0x005C	R/W
LEDC_CH5_CONF0_REG	Configuration register 0 for channel 5	0x0064	varies
LEDC_CH5_CONF1_REG	Configuration register 1 for channel 5	0x0070	R/W
LEDC_CH6_CONF0_REG	Configuration register 0 for channel 6	0x0078	varies
LEDC_CH6_CONF1_REG	Configuration register 1 for channel 6	0x0084	R/W
LEDC_CH7_CONF0_REG	Configuration register 0 for channel 7	0x008C	varies
LEDC_CH7_CONF1_REG	Configuration register 1 for channel 7	0x0098	R/W
LEDC_CONF_REG	Global ledc configuration register	0x00D0	R/W
Hpoint Register			
LEDC_CH0_HPOINT_REG	High point register for channel 0	0x0004	R/W
LEDC_CH1_HPOINT_REG	High point register for channel 1	0x0018	R/W
LEDC_CH2_HPOINT_REG	High point register for channel 2	0x002C	R/W
LEDC_CH3_HPOINT_REG	High point register for channel 3	0x0040	R/W
LEDC_CH4_HPOINT_REG	High point register for channel 4	0x0054	R/W
LEDC_CH5_HPOINT_REG	High point register for channel 5	0x0068	R/W
LEDC_CH6_HPOINT_REG	High point register for channel 6	0x007C	R/W
LEDC_CH7_HPOINT_REG	High point register for channel 7	0x0090	R/W
Duty Cycle Register			
LEDC_CH0_DUTY_REG	Initial duty cycle for channel 0	0x0008	R/W
LEDC_CH0_DUTY_R_REG	Current duty cycle for channel 0	0x0010	RO
LEDC_CH1_DUTY_REG	Initial duty cycle for channel 1	0x001C	R/W
LEDC_CH1_DUTY_R_REG	Current duty cycle for channel 1	0x0024	RO
LEDC_CH2_DUTY_REG	Initial duty cycle for channel 2	0x0030	R/W
LEDC_CH2_DUTY_R_REG	Current duty cycle for channel 2	0x0038	RO
LEDC_CH3_DUTY_REG	Initial duty cycle for channel 3	0x0044	R/W
LEDC_CH3_DUTY_R_REG	Current duty cycle for channel 3	0x004C	RO
LEDC_CH4_DUTY_REG	Initial duty cycle for channel 4	0x0058	R/W
LEDC_CH4_DUTY_R_REG	Current duty cycle for channel 4	0x0060	RO

Name	Description	Address	Access
LEDC_CH5_DUTY_REG	Initial duty cycle for channel 5	0x006C	R/W
LEDC_CH5_DUTY_R_REG	Current duty cycle for channel 5	0x0074	RO
LEDC_CH6_DUTY_REG	Initial duty cycle for channel 6	0x0080	R/W
LEDC_CH6_DUTY_R_REG	Current duty cycle for channel 6	0x0088	RO
LEDC_CH7_DUTY_REG	Initial duty cycle for channel 7	0x0094	R/W
LEDC_CH7_DUTY_R_REG	Current duty cycle for channel 7	0x009C	RO
Timer Register			
LEDC_TIMER0_CONF_REG	Timer 0 configuration	0x00A0	varies
LEDC_TIMER0_VALUE_REG	Timer 0 current counter value	0x00A4	RO
LEDC_TIMER1_CONF_REG	Timer 1 configuration	0x00A8	varies
LEDC_TIMER1_VALUE_REG	Timer 1 current counter value	0x00AC	RO
LEDC_TIMER2_CONF_REG	Timer 2 configuration	0x00B0	varies
LEDC_TIMER2_VALUE_REG	Timer 2 current counter value	0x00B4	RO
LEDC_TIMER3_CONF_REG	Timer 3 configuration	0x00B8	varies
LEDC_TIMER3_VALUE_REG	Timer 3 current counter value	0x00BC	RO
Interrupt Register			
LEDC_INT_RAW_REG	Raw interrupt status	0x00C0	RO
LEDC_INT_ST_REG	Masked interrupt status	0x00C4	RO
LEDC_INT_ENA_REG	Interrupt enable bits	0x00C8	R/W
LEDC_INT_CLR_REG	Interrupt clear bits	0x00CC	WO
Version Register			
LEDC_DATE_REG	Version control register	0x00FC	R/W

Register 35.1. LEDC_CH n _CONF0_REG (n : 0-7) (0x0000+0x14* n)

Continued from the previous page...

LEDC_OVF_NUM_CH n This register is used to configure the maximum times of overflow minus 1. The LEDC_OVF_CNT_CH n _INT interrupt will be triggered when channel n overflows for (LEDC_OVF_NUM_CH n + 1) times. (R/W)

LEDC_OVF_CNT_EN_CH n This bit is used to count the number of times when the timer selected by channel n overflows.(R/W)

LEDC_OVF_CNT_RESET_CH n Set this bit to reset the timer-overflow counter of channel n . (WO)

LEDC_OVF_CNT_RESET_ST_CH n This is the status bit of LEDC_OVF_CNT_RESET_CH n . (RO)

Register 35.2. LEDC_CH n _CONF1_REG (n : 0-7) (0x000C+0x14* n)

LEDC_DUTY_START_CH n LEDC_DUTY_INC_CH n		LEDC_DUTY_NUM_CH n		LEDC_DUTY_CYCLE_CH n		LEDC_DUTY_SCALE_CH n	
31	30	29	20	19	10	9	0
0	1	0x0		0x0		0x0	
							Reset

LEDC_DUTY_SCALE_CH n This register is used to configure the changing step scale of duty on channel n . (R/W)

LEDC_DUTY_CYCLE_CH n The duty will change every LEDC_DUTY_CYCLE_CH n on channel n . (R/W)

LEDC_DUTY_NUM_CH n This register is used to control the number of times the duty cycle will be changed. (R/W)

LEDC_DUTY_INC_CH n This register is used to increase or decrease the duty of output signal on channel n . 1: Increase; 0: Decrease. (R/W)

LEDC_DUTY_START_CH n Other configured fields in LEDC_CH n _CONF1_REG will start to take effect upon the next timer overflow when this bit is set to 1. (R/W)

Register 35.6. LEDC_CH n _DUTY_R_REG (n : 0-7) (0x0010+0x14* n)

(reserved)														LEDC_DUTY_R_CH n																	
31															19	18															0
0 0 0 0 0 0 0 0 0 0 0 0 0 0 0														0x000														Reset			

LEDC_DUTY_R_CH n This register stores the current duty of output signal on channel n . (RO)

Register 35.7. LEDC_TIMER x _CONF_REG (x : 0-3) (0x00A0+0x8* x)

(reserved)														LEDC_TIMER x _PARA_UP				(reserved)				LEDC_TIMER x _RST				LEDC_TIMER x _PAUSE				LEDC_CLK_DIV_TIMER x								LEDC_TIMER x _DUTY_RES			
31							26	25	24	23	22	21									4	3			0																
0 0 0 0 0 0						0	0	0	1	0	0x000								0x0		Reset																				

LEDC_TIMER x _DUTY_RES This register is used to control the range of the counter in timer x . (R/W)

LEDC_CLK_DIV_TIMER x This register is used to configure the divisor for the divider in timer x . The least significant eight bits represent the fractional part. (R/W)

LEDC_TIMER x _PAUSE This bit is used to suspend the counter in timer x . (R/W)

LEDC_TIMER x _RST This bit is used to reset timer x . The counter will show 0 after reset. (R/W)

LEDC_TIMER x _PARA_UP Set this bit to update LEDC_CLK_DIV_TIMER x and LEDC_TIMER x _DUTY_RES. (WO)

Register 35.8. LEDC_TIMER x _VALUE_REG (x : 0-3) (0x00A4+0x8* x)

(reserved)														LEDC_TIMER x _CNT																	
31															14	13															0
0 0 0 0 0 0 0 0 0 0 0 0 0 0 0														0x00														Reset			

LEDC_TIMER x _CNT This register stores the current counter value of timer x . (RO)

Register 35.9. LEDC_INT_RAW_REG (0x00C0)

(reserved)												LEDC_OVF_CNT_CH7_INT_RAW LEDC_OVF_CNT_CH6_INT_RAW LEDC_OVF_CNT_CH5_INT_RAW LEDC_OVF_CNT_CH4_INT_RAW LEDC_OVF_CNT_CH3_INT_RAW LEDC_OVF_CNT_CH2_INT_RAW LEDC_OVF_CNT_CH1_INT_RAW LEDC_DUTY_CHNG_END_CH0_INT_RAW LEDC_DUTY_CHNG_END_CH7_INT_RAW LEDC_DUTY_CHNG_END_CH6_INT_RAW LEDC_DUTY_CHNG_END_CH5_INT_RAW LEDC_DUTY_CHNG_END_CH4_INT_RAW LEDC_DUTY_CHNG_END_CH3_INT_RAW LEDC_DUTY_CHNG_END_CH2_INT_RAW LEDC_DUTY_CHNG_END_CH1_INT_RAW LEDC_TIMER3_OVF_INT_RAW LEDC_TIMER2_OVF_INT_RAW LEDC_TIMER1_OVF_INT_RAW LEDC_TIMER0_OVF_INT_RAW																			
31	20	19	18	17	16	15	14	13	12	11	10	9	8	7	6	5	4	3	2	1	0										
0	0	0	0	0	0	0	0	0	0	0	0	0	0	0	0	0	0	0	0	0	0	0									

Reset

LEDC_TIMER x _OVF_INT_RAW Triggered when the timer x has reached its maximum counter value. (RO)

LEDC_DUTY_CHNG_END_CH n _INT_RAW Interrupt raw bit for channel n . Triggered when the gradual change of duty has finished. (RO)

LEDC_OVF_CNT_CH n _INT_RAW Interrupt raw bit for channel n . Triggered when the ovf_cnt has reached the value specified by LEDC_OVF_NUM_CH n . (RO)

Register 35.10. LEDC_INT_ST_REG (0x00C4)

(reserved)												LEDC_OVF_CNT_CH7_INT_ST LEDC_OVF_CNT_CH6_INT_ST LEDC_OVF_CNT_CH5_INT_ST LEDC_OVF_CNT_CH4_INT_ST LEDC_OVF_CNT_CH3_INT_ST LEDC_OVF_CNT_CH2_INT_ST LEDC_OVF_CNT_CH1_INT_ST LEDC_DUTY_CHNG_END_CH0_INT_ST LEDC_DUTY_CHNG_END_CH7_INT_ST LEDC_DUTY_CHNG_END_CH6_INT_ST LEDC_DUTY_CHNG_END_CH5_INT_ST LEDC_DUTY_CHNG_END_CH4_INT_ST LEDC_DUTY_CHNG_END_CH3_INT_ST LEDC_DUTY_CHNG_END_CH2_INT_ST LEDC_DUTY_CHNG_END_CH1_INT_ST LEDC_TIMER3_OVF_INT_ST LEDC_TIMER2_OVF_INT_ST LEDC_TIMER1_OVF_INT_ST LEDC_TIMER0_OVF_INT_ST																			
31	20	19	18	17	16	15	14	13	12	11	10	9	8	7	6	5	4	3	2	1	0										
0	0	0	0	0	0	0	0	0	0	0	0	0	0	0	0	0	0	0	0	0	0										

Reset

LEDC_TIMER x _OVF_INT_ST This is the masked interrupt status bit for the LEDC_TIMER x _OVF_INT interrupt when LEDC_TIMER x _OVF_INT_ENA is set to 1. (RO)

LEDC_DUTY_CHNG_END_CH n _INT_ST This is the masked interrupt status bit for the LEDC_DUTY_CHNG_END_CH n _INT interrupt when LEDC_DUTY_CHNG_END_CH n _INT_ENAIS set to 1. (RO)

LEDC_OVF_CNT_CH n _INT_ST This is the masked interrupt status bit for the LEDC_OVF_CNT_CH n _INT interrupt when LEDC_OVF_CNT_CH n _INT_ENA is set to 1. (RO)

Register 35.11. LEDC_INT_ENA_REG (0x00C8)

(reserved)												LEDC_OVF_CNT_CH7_INT_ENA LEDC_OVF_CNT_CH6_INT_ENA LEDC_OVF_CNT_CH5_INT_ENA LEDC_OVF_CNT_CH4_INT_ENA LEDC_OVF_CNT_CH3_INT_ENA LEDC_OVF_CNT_CH2_INT_ENA LEDC_OVF_CNT_CH1_INT_ENA LEDC_DUTY_CHNG_END_CH0_INT_ENA LEDC_DUTY_CHNG_END_CH7_INT_ENA LEDC_DUTY_CHNG_END_CH6_INT_ENA LEDC_DUTY_CHNG_END_CH5_INT_ENA LEDC_DUTY_CHNG_END_CH4_INT_ENA LEDC_DUTY_CHNG_END_CH3_INT_ENA LEDC_DUTY_CHNG_END_CH2_INT_ENA LEDC_DUTY_CHNG_END_CH1_INT_ENA LEDC_TIMER3_OVF_INT_ENA LEDC_TIMER2_OVF_INT_ENA LEDC_TIMER1_OVF_INT_ENA LEDC_TIMER0_OVF_INT_ENA																			
31	20	19	18	17	16	15	14	13	12	11	10	9	8	7	6	5	4	3	2	1	0										
0	0	0	0	0	0	0	0	0	0	0	0	0	0	0	0	0	0	0	0	0	0	0									

Reset

LEDC_TIMER x _OVF_INT_ENA The interrupt enable bit for the LEDC_TIMER x _OVF_INT interrupt. (R/W)

LEDC_DUTY_CHNG_END_CH n _INT_ENA The interrupt enable bit for the LEDC_DUTY_CHNG_END_CH n _INT interrupt. (R/W)

LEDC_OVF_CNT_CH n _INT_ENA The interrupt enable bit for the LEDC_OVF_CNT_CH n _INT interrupt. (R/W)

Register 35.12. LEDC_INT_CLR_REG (0x00CC)

(reserved)												LEDC_OVF_CNT_CH7_INT_CLR LEDC_OVF_CNT_CH6_INT_CLR LEDC_OVF_CNT_CH5_INT_CLR LEDC_OVF_CNT_CH4_INT_CLR LEDC_OVF_CNT_CH3_INT_CLR LEDC_OVF_CNT_CH2_INT_CLR LEDC_OVF_CNT_CH1_INT_CLR LEDC_DUTY_CHNG_END_CH0_INT_CLR LEDC_DUTY_CHNG_END_CH7_INT_CLR LEDC_DUTY_CHNG_END_CH6_INT_CLR LEDC_DUTY_CHNG_END_CH5_INT_CLR LEDC_DUTY_CHNG_END_CH4_INT_CLR LEDC_DUTY_CHNG_END_CH3_INT_CLR LEDC_DUTY_CHNG_END_CH2_INT_CLR LEDC_DUTY_CHNG_END_CH1_INT_CLR LEDC_TIMER3_OVF_INT_CLR LEDC_TIMER2_OVF_INT_CLR LEDC_TIMER1_OVF_INT_CLR LEDC_TIMER0_OVF_INT_CLR																			
31	20	19	18	17	16	15	14	13	12	11	10	9	8	7	6	5	4	3	2	1	0										
0	0	0	0	0	0	0	0	0	0	0	0	0	0	0	0	0	0	0	0	0	0										

Reset

LEDC_TIMER x _OVF_INT_CLR Set this bit to clear the LEDC_TIMER x _OVF_INT interrupt. (WO)

LEDC_DUTY_CHNG_END_CH n _INT_CLR Set this bit to clear the LEDC_DUTY_CHNG_END_CH n _INT interrupt. (WO)

LEDC_OVF_CNT_CH n _INT_CLR Set this bit to clear the LEDC_OVF_CNT_CH n _INT interrupt. (WO)

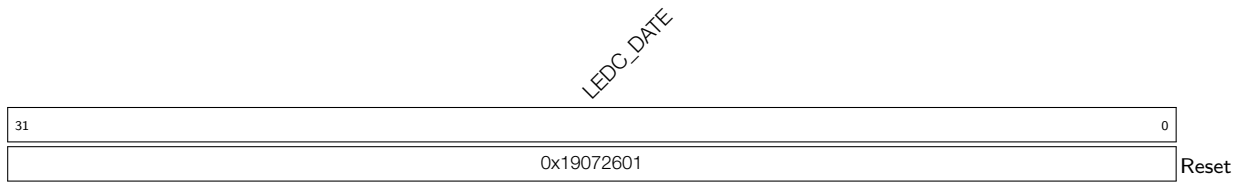
Register 35.13. LEDC_DATE_REG (0x00FC)

LEDC_DATE This is the version control register. (R/W)

36 Motor Control PWM (MCPWM)

36.1 Overview

The **M**otor **C**ontrol **P**ulse **W**idth **M**odulator (MCPWM) peripheral is intended for motor and power control. It provides six PWM outputs that can be set up to operate in several topologies. One common topology uses a pair of PWM outputs driving an H-bridge to control motor rotation speed and rotation direction.

The timing and control resources inside are allocated into two major types of submodules: PWM timers and PWM operators. Each PWM timer provides timing references that can either run freely or be synced to other timers or external sources. Each PWM operator has all necessary control resources to generate waveform pairs for one PWM channel. The MCPWM peripheral also contains a dedicated capture submodule that is used in systems where accurate timing of external events is important.

ESP32-S3 contains two MCPWM peripherals: MCPWM0 and MCPWM1.

36.2 Features

Each MCPWM peripheral has one clock divider (prescaler), three PWM timers, three PWM operators, and a capture module. Figure 36-1 shows the submodules inside and the signals on the interface. PWM timers are used for generating timing references. The PWM operators generate desired waveform based on the timing references. Any PWM operator can be configured to use the timing references of any PWM timers. Different PWM operators can use the same PWM timer's timing references to produce related PWM signals. PWM operators can also use different PWM timers' values to produce the PWM signals that work alone. Different PWM timers can also be synchronized together.

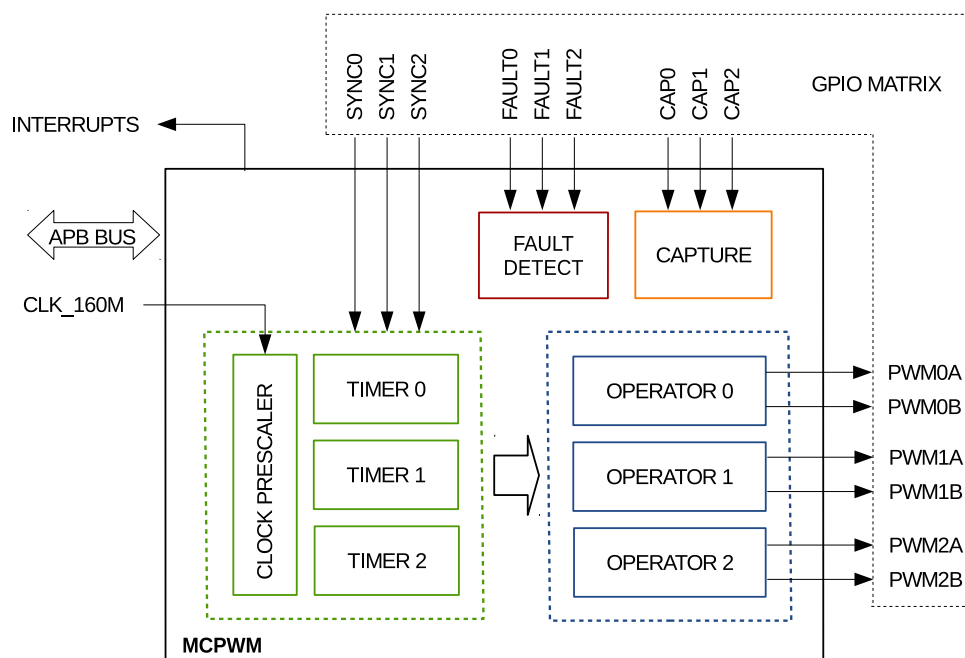

Figure 36-1. MCPWM Module Overview

An overview of the submodules' function in Figure 36-1 is shown below:

- PWM Timers 0, 1 and 2
 - Every PWM timer has a dedicated 8-bit clock prescaler.
 - The 16-bit counter in the PWM timer can work in count-up mode, count-down mode or count-up-down mode.
 - A hardware sync or software sync can trigger a reload on the PWM timer with a phase register. It will also trigger the prescaler's restart, so that the timer's clock can also be synced. The source of the hard sync can come from any GPIO or any other PWM timer's sync_out. The source of the soft sync comes from writing toggle value to the `MCPWM_TIMERx_SYNC_SW` bit.
- PWM Operators 0, 1 and 2
 - Every PWM operator has two PWM outputs: PWMxA and PWMxB. They can work independently, in symmetric and asymmetric configuration.
 - Software, asynchronously override control of PWM signals.
 - Configurable dead-time on rising and falling edges; each set up independently.
 - All events can trigger CPU interrupts.
 - Modulating of PWM output by high-frequency carrier signals, useful when gate drivers are insulated with a transformer.
 - Period, time stamps and important control registers have shadow registers with flexible updating methods.
- Fault Detection Module
 - Programmable fault handling allocated on fault condition in both cycle-by-cycle mode and one-shot mode.
 - A fault condition can force the PWM output to either high or low logic levels.
- Capture Module
 - Speed measurement of rotating machinery (for example, toothed sprockets sensed with Hall sensors)
 - Measurement of elapsed time between position sensor pulses
 - Period and duty-cycle measurement of pulse train signals
 - Decoding current or voltage amplitude derived from duty-cycle-encoded signals of current/voltage sensors
 - Three individual capture channels, each of which has a time-stamp register (32 bits)
 - Selection of edge polarity and prescaling of input capture signal
 - The capture timer can sync with a PWM timer or external signals.
 - Interrupt on each of the three capture channels

36.3 Submodules

36.3.1 Overview

This section lists the configuration parameters of key submodules. For information on adjusting a specific parameter, e.g. synchronization source of PWM timer, please refer to Section 36.3.2 for details.

36.3.1.1 Prescaler Submodule

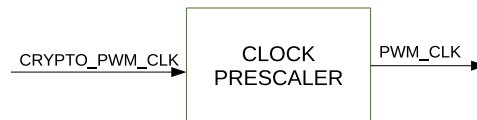

Figure 36-2. Prescaler Submodule

Configuration option:

- Scale the CRYPTO_PWM_CLK.

36.3.1.2 Timer Submodule

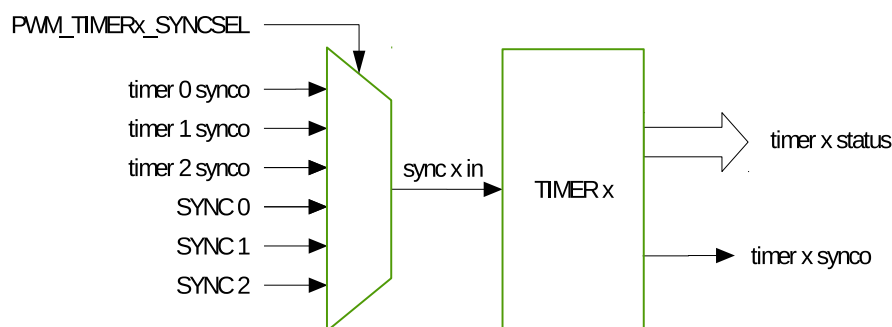

Figure 36-3. Timer Submodule

Configuration options:

- Set the PWM timer frequency or period.
- Configure the working mode for the timer:
 - Count-Up Mode: for asymmetric PWM outputs
 - Count-Down Mode: for asymmetric PWM outputs
 - Count-Up-Down Mode: for symmetric PWM outputs
- Configure the the reloading phase (including the value and the direction) used during software and hardware synchronization.
- Synchronize the PWM timers with each other. Either hardware or software synchronization may be used.
- Configure the source of the PWM timer's the synchronization input to one of the seven sources below:

- The three PWM timer's synchronization outputs.
- Three synchronization signals from the GPIO matrix: PWMn_SYNC0_IN, PWMn_SYNC1_IN, PWMn_SYNC2_IN.
- No synchronization input signal selected
- Configure the source of the PWM timer's synchronization output to one of the four sources below:
 - Synchronization input signal
 - Event generated when value of the PWM timer is equal to zero
 - Event generated when value of the PWM timer is equal to period
 - Event generated when writing toggling value to `MCPWM_TIMERx_SYNC_SW` bit
- Configure the method of period updating.

36.3.1.3 Operator Submodule

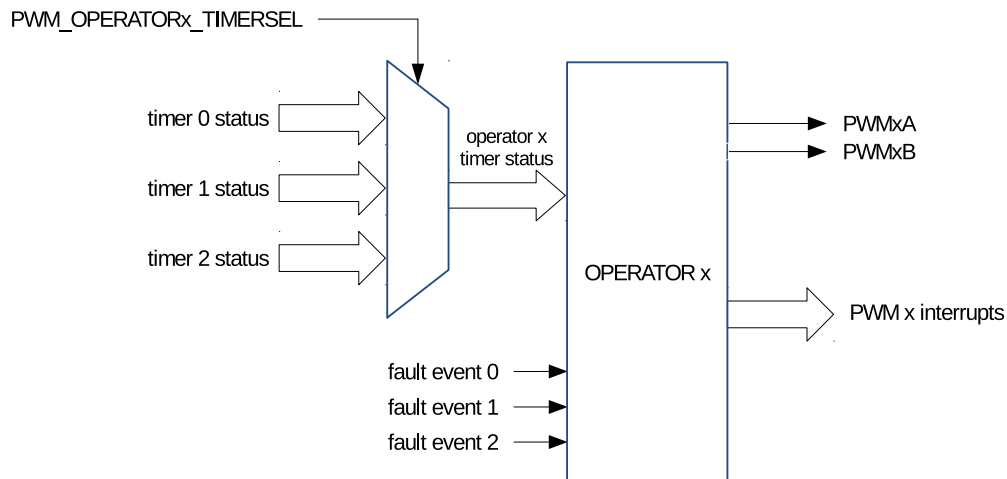

Figure 36-4. Operator Submodule

The configuration parameters of the operator submodule are shown in Table 36-1.

Table 36-1. Configuration Parameters of the Operator Submodule

Submodule	Configuration Parameter or Option
PWM Generator	<ul style="list-style-type: none"> • Set up the PWM duty cycle for PWMxA and/or PWMxB output. • Set up at which time the timing events occur. • Define what action should be taken on timing events: <ul style="list-style-type: none"> – Switch high or low of PWMxA and/or PWMxB outputs – Toggle PWMxA and/or PWMxB outputs – Take no action on outputs • Use direct s/w control to force the state of PWM outputs • Add a dead time to raising edge and/or falling edge on PWM outputs. • Configure update method for this submodule.
Dead Time Generator	<ul style="list-style-type: none"> • Control of complementary dead time relationship between upper and lower switches. • Specify the dead time on rising edge. • Specify the dead time on falling edge. • Bypass the dead time generator module. The PWM waveform will pass through without inserting dead time. • Allow PWMxB phase shifting with respect to the PWMxA output. • Configure updating method for this submodule.
PWM Carrier	<ul style="list-style-type: none"> • Enable carrier and set up carrier frequency. • Configure duration of the first pulse in the carrier waveform. • Set up the duty cycle of the following pulses. • Bypass the PWM carrier module. The PWM waveform will be passed through without modification.
Fault Handler	<ul style="list-style-type: none"> • Configure if and how the PWM module should react the fault event signals. • Specify the action taken when a fault event occurs: <ul style="list-style-type: none"> – Force PWMxA and/or PWMxB high. – Force PWMxA and/or PWMxB low. – Configure PWMxA and/or PWMxB to ignore any fault event. • Configure how often the PWM should react to fault events: <ul style="list-style-type: none"> – One-shot – Cycle-by-cycle • Generate interrupts. • Bypass the fault handler submodule entirely. • Set up an option for cycle-by-cycle actions clearing. • If desired, independently-configured actions can be taken when time-base counter is counting down or up.

36.3.1.4 Fault Detection Submodule

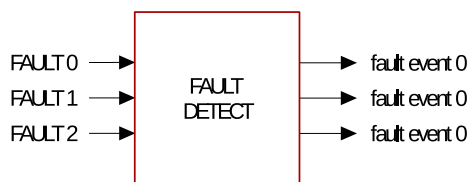

Figure 36-5. Fault Detection Submodule

Configuration options:

- Enable fault event generation and configure the polarity of fault event generation for every fault signal
- Generate fault event interrupts

36.3.1.5 Capture Submodule

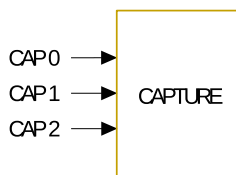

Figure 36-6. Capture Submodule

Configuration options:

- Select the edge polarity and prescaling of the capture input.
- Set up a software-triggered capture.
- Configure the capture timer's sync trigger and sync phase.
- Software syncs the capture timer.

36.3.2 PWM Timer Submodule

Each MCPWM module has three PWM timer submodules. Any of them can determine the necessary event timing for any of the three PWM operator submodules. Built-in synchronization logic allows multiple PWM timer submodules, in one or more MCPWM modules, to work together as a system, when using synchronization signals from the GPIO matrix.

36.3.2.1 Configurations of the PWM Timer Submodule

Users can configure the following functions of the PWM timer submodule:

- Control how often events occur by specifying the PWM timer frequency or period.
- Configure a particular PWM timer to synchronize with other PWM timers or modules.

- Get a PWM timer in phase with other PWM timers or modules.
- Set one of the following timer counting modes: count-up, count-down, count-up-down.
- Change the rate of the PWM timer clock (PT_clk) with a prescaler. Each timer has its own prescaler configured with `MCPWM_TIMERx_PRESCALE` of the register `MCPWM_TIMER0_CFG0_REG`. The PWM timer increments or decrements at a slower pace, depending on the setting of this field.

36.3.2.2 PWM Timer's Working Modes and Timing Event Generation

The PWM timer has three working modes, selected by the PWM x timer mode field:

- **Count-Up Mode:**
In this mode, the PWM timer increments from zero until reaching the value configured in the period field. Once done, the PWM timer returns to zero and starts increasing again. PWM period is equal to the value of the period field + 1.
Note: The period field is `MCPWM_TIMERx_PERIOD` ($x = 0, 1, 2$), i.e., `MCPWM_TIMER0_PERIOD`, `MCPWM_TIMER1_PERIOD`, `MCPWM_TIMER2_PERIOD`.
- **Count-Down Mode:**
The PWM timer decrements to zero, starting from the value configured in the period field. After reaching zero, it is set back to the period value. Then it starts to decrement again. In this case, the PWM period is also equal to the value of period field + 1.
- **Count-Up-Down Mode:**
This is a combination of the two modes mentioned above. The PWM timer starts increasing from zero until the period value is reached. Then, the timer decreases back to zero. This pattern is then repeated. The PWM period is the result of (the value of the period field $\times 2 + 1$).

Figures 36-7 to 36-10 show PWM timer waveforms in different modes, including timer behavior during synchronization events. In Count-Up mode, the counting direction after synchronization is always counting up, while in Count-Down mode, the counting direction after synchronization is always counting down. In Count-Up-Down Mode, the counting direction after synchronization can be chosen by setting the `MCPWM_TIMERx_PHASE_DIRECTION`.

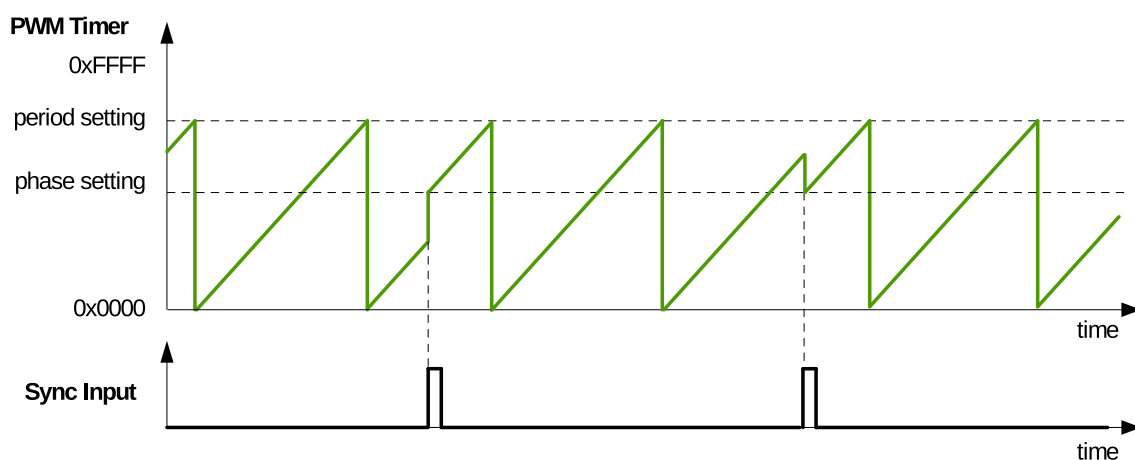

Figure 36-7. Count-Up Mode Waveform

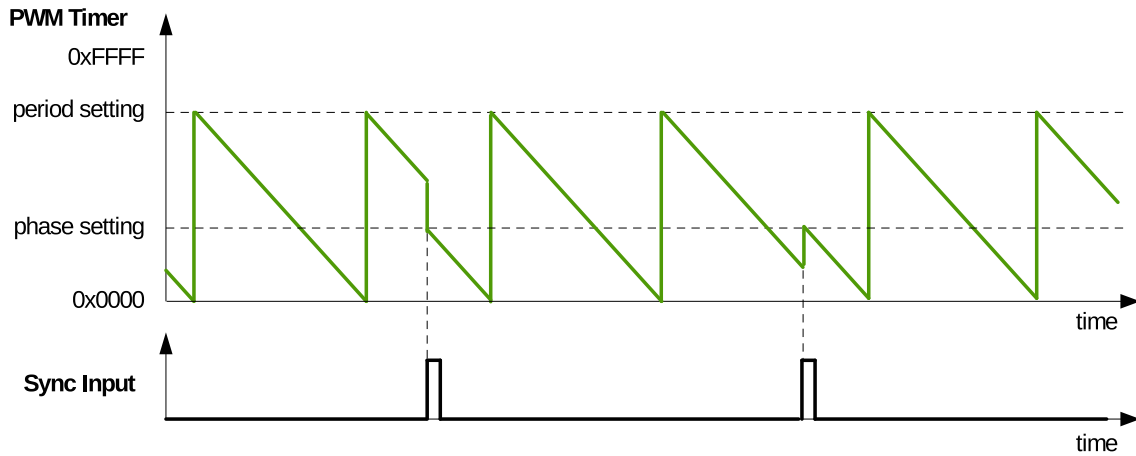

Figure 36-8. Count-Down Mode Waveforms

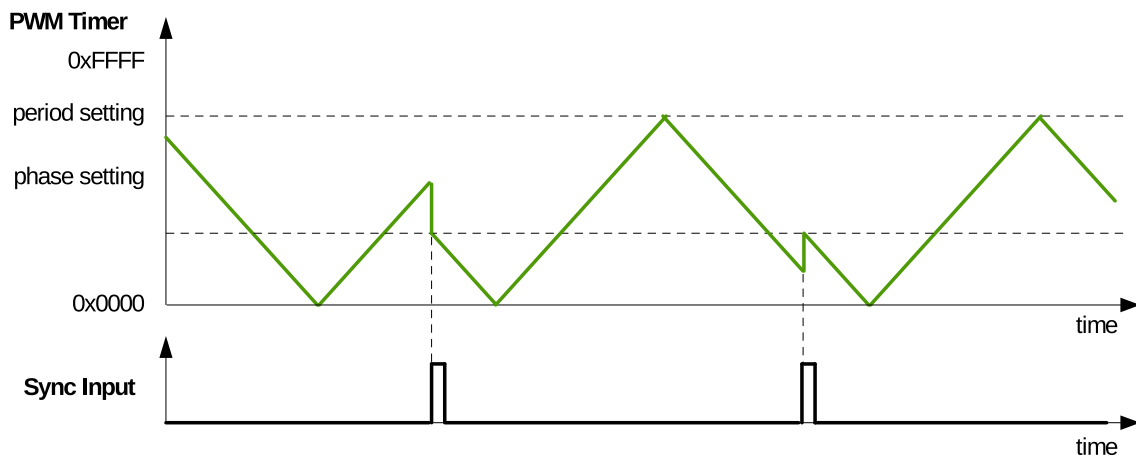

Figure 36-9. Count-Up-Down Mode Waveforms, Count-Down at Synchronization Event

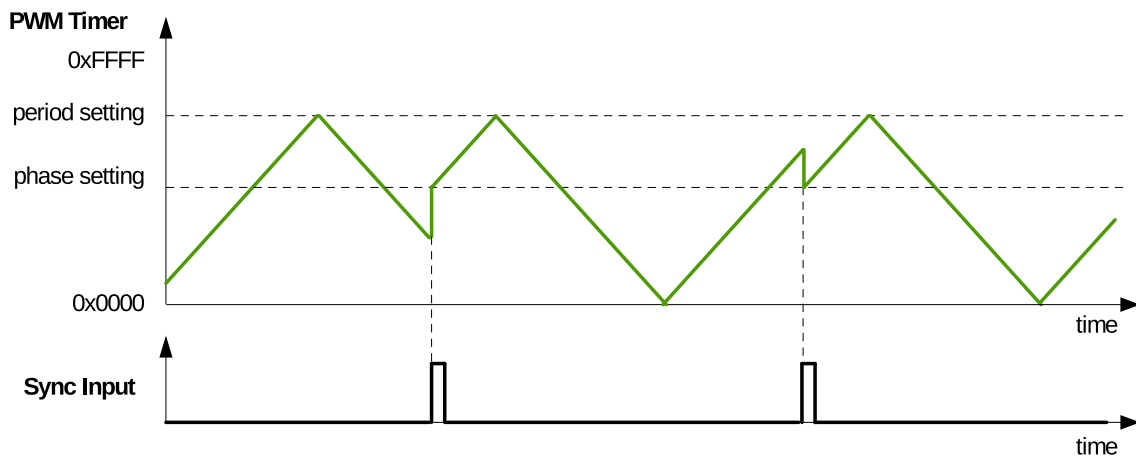

Figure 36-10. Count-Up-Down Mode Waveforms, Count-Up at Synchronization Event

When the PWM timer is running, it generates the following timing events periodically and automatically:

- UTEP
The timing event generated when the PWM timer's value equals to the value of the period field (`MCPWM_TIMERx_PERIOD`) and when the PWM timer is increasing.
- UTEZ
The timing event generated when the PWM timer's value equals to zero and when the PWM timer is increasing.
- DTEP
The timing event generated when the PWM timer's value equals to the value of the period field (`MCPWM_TIMERx_PERIOD`) and when the PWM timer is decreasing.
- DTEZ
The timing event generated when the PWM timer's value equals to zero and when the PWM timer is decreasing.

Figures 36-11 to 36-13 show the timing waveforms of U/DTEP and U/DTEZ.

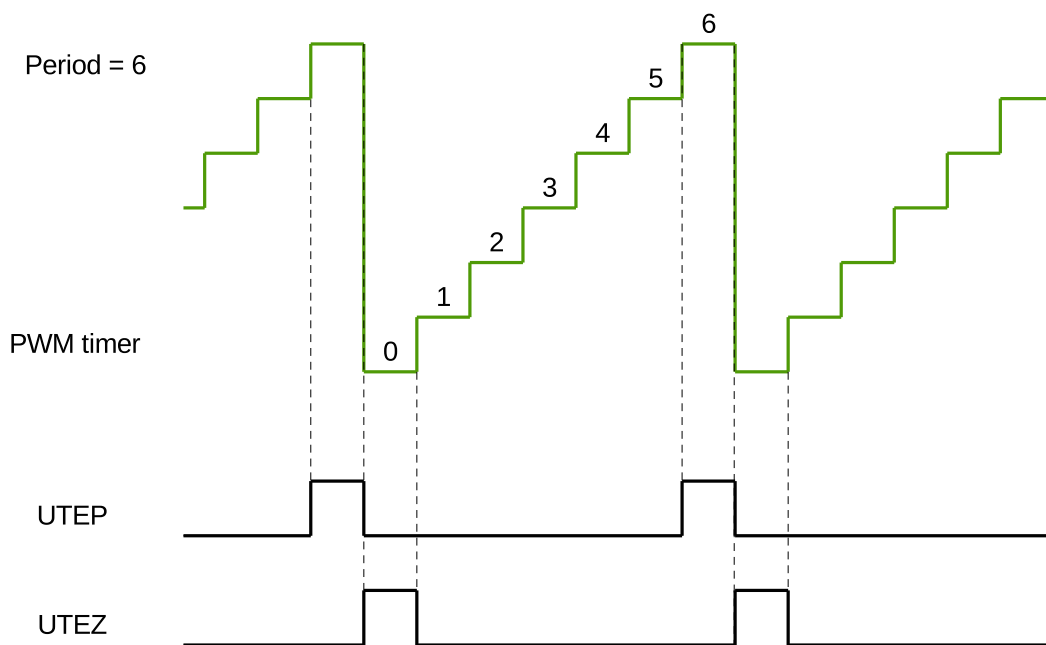

Figure 36-11. UTEP and UTEZ Generation in Count-Up Mode

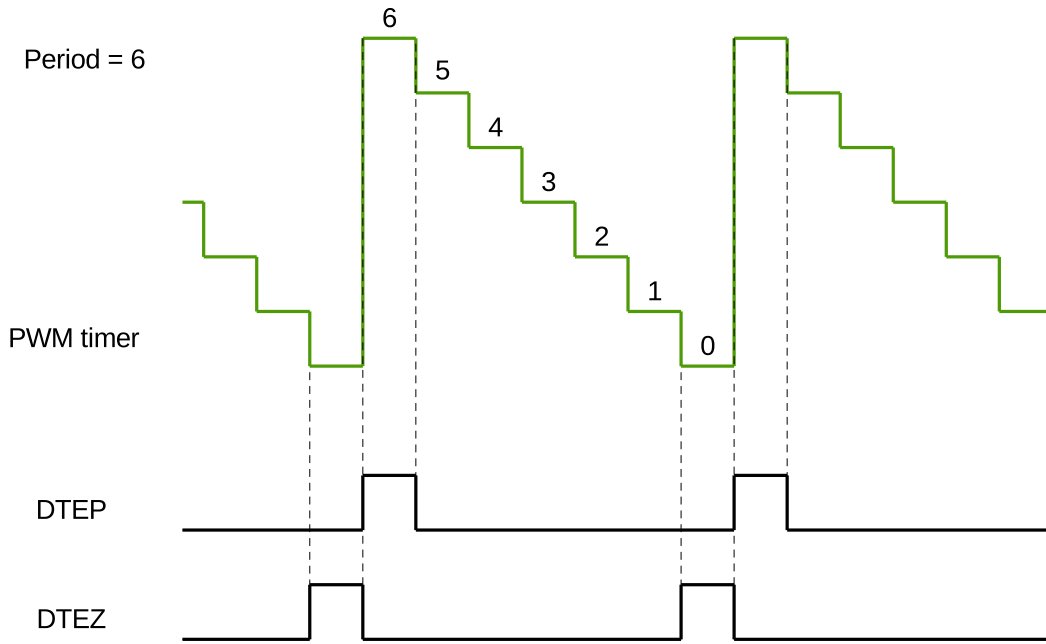

Figure 36-12. DTEP and DTEZ Generation in Count-Down Mode

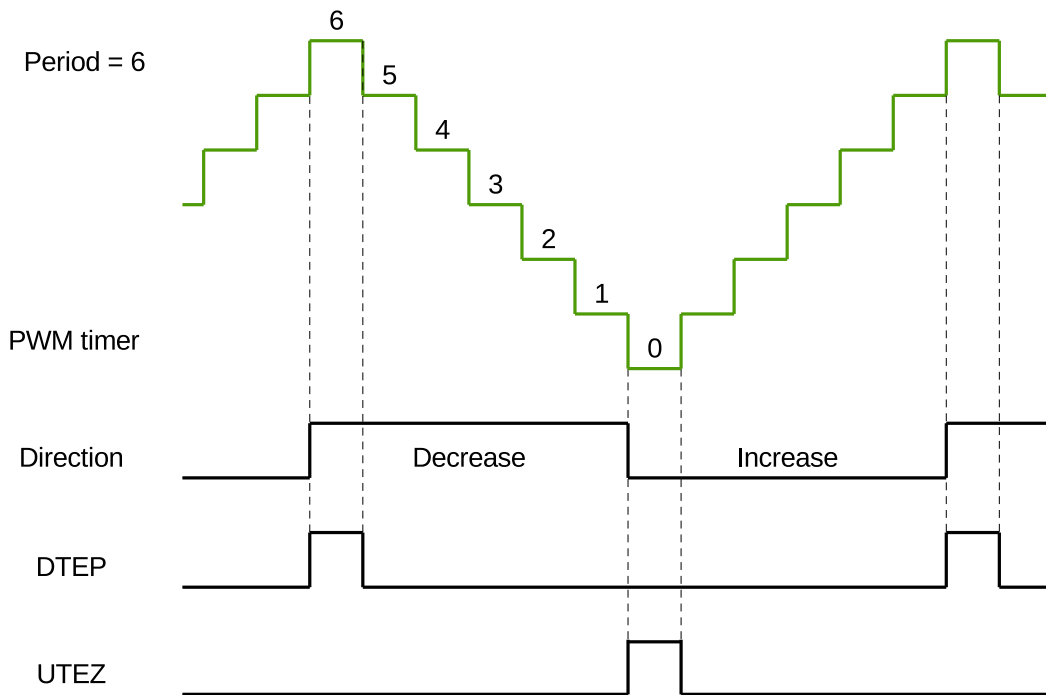

Figure 36-13. DTEP and UTEZ Generation in Count-Up-Down Mode

36.3.2.3 PWM Timer Shadow Register

The PWM timer's period register and the PWM timer's clock prescaler register have shadow registers. The purpose of a shadow register is to save a copy of the value to be written into the active register at a specific moment synchronized with the hardware. Both register types are defined as follows:

- Active Register
This register is directly responsible for controlling all actions performed by hardware.
- Shadow Register
It acts as a temporary buffer for a value to be written to the active register. At a specific, user-configured point in time, the value saved in the shadow register is copied to the active register. Before this happens, the content of the shadow register has no direct effect on the controlled hardware. This helps to prevent spurious operation of the hardware, which may happen when a register is asynchronously modified by software. Both the shadow register and the active register have the same memory address. The software always writes into, or reads from the shadow register.

The moment of updating the clock prescaler's active register is at the time when the timer starts operating. When `MCPWM_GLOBAL_UP_EN` is set to 1, the moment of updating the period active register can be selected by the following ways. By setting the update method register of `MCPWM_TIMERx_PERIOD_UPMETHOD`, the update can start when the PWM timer is equal to zero, when the PWM timer is equal to period, at a synchronization moment, or immediately. Software can also trigger a globally forced update bit `MCPWM_GLOBAL_FORCE_UP` which will prompt all registers in the module to be updated according to shadow registers.

36.3.2.4 PWM Timer Synchronization and Phase Locking

The PWM modules adopt a flexible synchronization method. Each PWM timer has a synchronization input and a synchronization output. The synchronization input can be selected from three synchronization outputs and three synchronization signals from the GPIO matrix. The synchronization output can be generated from the synchronization input signal, when the PWM timer's value is equal to period or zero, or software synchronization. Thus, the PWM timers can be chained together with their phase locked. During synchronization, the PWM timer clock prescaler will reset its counter in order to synchronize the PWM timer clock.

36.3.3 PWM Operator Submodule

The PWM Operator submodule has the following functions:

- Generates a PWM signal pair, based on timing references obtained from the corresponding PWM timer.
- Each signal out of the PWM signal pair includes a specific pattern of dead time.
- Superimposes a carrier on the PWM signal, if configured to do so.
- Handles response under fault conditions.

Figure 36-14 shows the block diagram of a PWM operator.

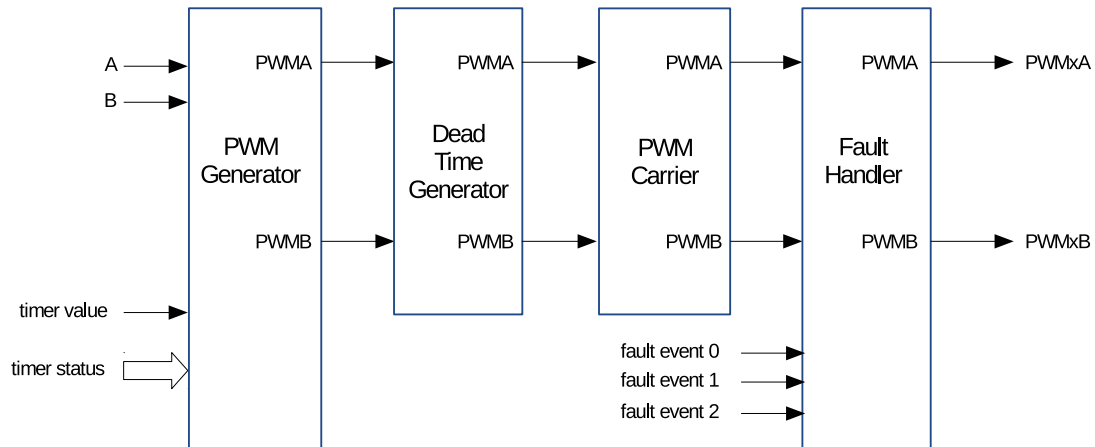

Figure 36-14. Submodules Inside the PWM Operator

36.3.3.1 PWM Generator Submodule

Purpose of the PWM Generator Submodule

In this submodule, important timing events are generated or imported. The events are then converted into specific actions to generate the desired waveforms at the PWMxA and PWMxB outputs.

The PWM generator submodule performs the following actions:

- Generation of timing events based on time stamps configured using the A and B registers. Events happen when the following conditions are satisfied:
 - UTEA: the PWM timer is counting up and its value is equal to register A.
 - UTEB: the PWM timer is counting up and its value is equal to register B.
 - DTEA: the PWM timer is counting down and its value is equal to register A.
 - DTEB: the PWM timer is counting down and its value is equal to register B.
- Generation of U/DT1, U/DT2 timing events based on fault or synchronization events.
- Management of priority when these timing events occur concurrently.
- Qualification and generation of set, clear and toggle actions, based on the timing events.
- Controlling of the PWM duty cycle, depending on configuration of the PWM generator submodule.
- Handling of new time stamp values, using shadow registers to prevent glitches in the PWM cycle.

PWM Operator Shadow Registers

The time stamp registers A and B, as well as action configuration registers `MCPWM_GENx_A_REG` and `MCPWM_GENx_B_REG` are shadowed. Shadowing provides a way of updating registers in sync with the hardware.

When `MCPWM_GLOBAL_UP_EN` is set to 1, the shadow registers can be written to the active register at a

specified time. The update method fields for time stamp registers A and B are [MCPWM_GEN_A_UPMETHOD](#) and [MCPWM_GEN_B_UPMETHOD](#). The update method field for [MCPWM_GENx_A_REG](#) and [MCPWM_GENx_B_REG](#) is [MCPWM_GEN_CFG_UPMETHOD](#). Software can also trigger a globally forced update bit

[MCPWM_GLOBAL_FORCE_UP](#) which will prompt all registers in the module to be updated according to shadow registers. For a description of the shadow registers, please see [36.3.2.3](#).

Timing Events

For convenience, all timing signals and events are summarized in [Table 36-2](#).

Table 36-2. Timing Events Used in PWM Generator

Signal	Event Description	PWM Timer Operation
DTEP	PWM timer value is equal to the period register value	PWM timer counts down.
DTEZ	PWM timer value is equal to zero	
DTEA	PWM timer value is equal to A register	
DTEB	PWM timer value is equal to B register	
DT0 event	Based on fault or synchronization events	
DT1 event	Based on fault or synchronization events	
UTEP	PWM timer value is equal to the period register value	PWM timer counts up.
UTEZ	PWM timer value is equal to zero	
UTEA	PWM timer value is equal to A register	
UTEB	PWM timer value is equal to B register	
UT0 event	Based on fault or synchronization events	
UT1 event	Based on fault or synchronization events	
Software-force event	Software-initiated asynchronous event	N/A

The purpose of a software-force event is to impose non-continuous or continuous changes on the PWMxA and PWMxB outputs. The change is done asynchronously. Software-force control is handled by the [MCPWM_GENx_FORCE_REG](#) registers.

The selection and configuration of T0/T1 in the PWM generator submodule is independent of the configuration of fault events in the fault handler submodule. A particular trip event may or may not be configured to cause trip action in the fault handler submodule, but the same event can be used by the PWM generator to trigger T0/T1 for controlling PWM waveforms.

It is important to know that when the PWM timer is in count-up-down mode, it will always decrement after a TEP event, and will always increment after a TEZ event. So when the PWM timer is in count-up-down mode, DTEP and UTEZ events will occur, while the events UTEP and DTEZ will never occur.

The PWM generator can handle multiple events at the same time. Events are prioritized by the hardware and relevant details are provided in [Table 36-3](#) and [Table 36-4](#). Priority levels range from 1 (the highest) to 7 (the lowest). Please note that the priority of TEP and TEZ events depends on the PWM timer's direction.

If the value of A or B is set to be greater than the period, then U/DTEA and U/DTEB will never occur.

Table 36-3. Timing Events Priority When PWM Timer Increments

Priority Level	Event
1 (highest)	Software-force event
2	UTEP
3	UT0
4	UT1
5	UTEB
6	UTEA
7 (lowest)	UTEZ

Table 36-4. Timing Events Priority when PWM Timer Decrements

Priority level	Event
1 (highest)	Software-force event
2	DTEZ
3	DT0
4	DT1
5	DTEB
6	DTEA
7 (lowest)	DTEP

Notes:

1. UTEP and UTEZ do not happen simultaneously. When the PWM timer is in count-up mode, UTEP will always happen one cycle earlier than UTEZ, as demonstrated in Figure 36-11, so their action on PWM signals will not interrupt each other. When the PWM timer is in count-up-down mode, UTEP will not occur.
2. DTEP and DTEZ do not happen simultaneously. When the PWM timer is in count-down mode, DTEZ will always happen one cycle earlier than DTEP, as demonstrated in Figure 36-12, so their action on PWM signals will not interrupt each other. When the PWM timer is in count-up-down mode, DTEZ will not occur.

PWM Signal Generation

The PWM generator submodule controls the behavior of outputs PWMxA and PWMxB when a particular timing event occurs. The timing events are further qualified by the PWM timer's counting direction (up or down). Knowing the counting direction, the submodule may then perform an independent action at each stage of the PWM timer counting up or down.

The following actions may be configured on outputs PWMxA and PWMxB:

- Set High:
Set the output of PWMxA or PWMxB to a high level.
- Clear Low:
Clear the output of PWMxA or PWMxB by setting it to a low level.
- Toggle:

Change the current output level of PWMxA or PWMxB to the opposite value. If it is currently pulled high, pull it low, or vice versa.

- Do Nothing:
Keep both outputs PWMxA and PWMxB unchanged. In this state, interrupts can still be triggered.

The configuration of actions on outputs is done by using registers `MCPWN_GENx_A_REG` and `MCPWN_GENx_B_REG`. So, the action to be taken on each output is set independently. Also there is great flexibility in selecting actions to be taken on a given output based on events. More specifically, any event listed in Table 36-2 can operate on either output PWMxA or PWMxB. To check out registers for particular generator 0, 1 or 2, please refer to register description in Section 36.4.

Waveforms for Common Configurations

Figure 36-15 presents the symmetric PWM waveform generated when the PWM timer is counting up and down. DC 0%–100% modulation can be calculated via the formula below:

$$Duty = (Period - A) \div Period$$

If A matches the PWM timer value and the PWM timer is incrementing, then the PWM output is pulled up. If A matches the PWM timer value while the PWM timer is decrementing, then the PWM output is pulled low.

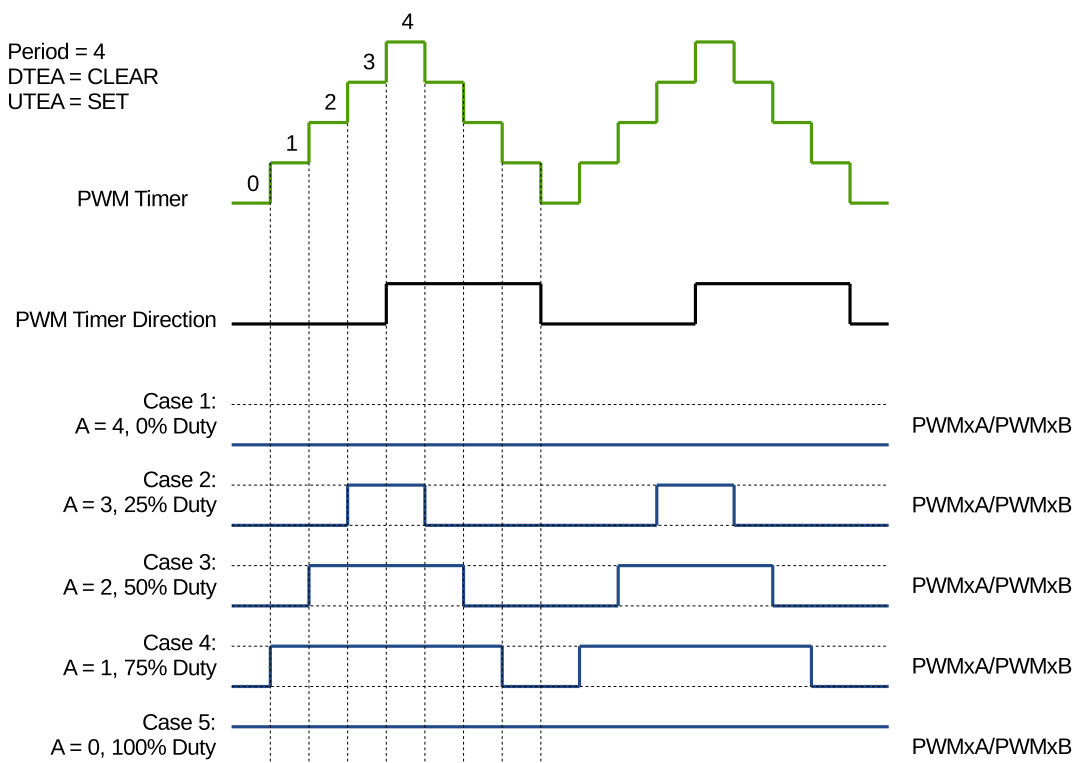

Figure 36-15. Symmetrical Waveform in Count-Up-Down Mode

The PWM waveforms in Figures 36-16 to 36-19 show some common PWM operator configurations. The following conventions are used in the figures:

- Period A and B refer to the values written in the corresponding registers.
- PWMxA and PWMxB are the output signals of PWM Operator x.

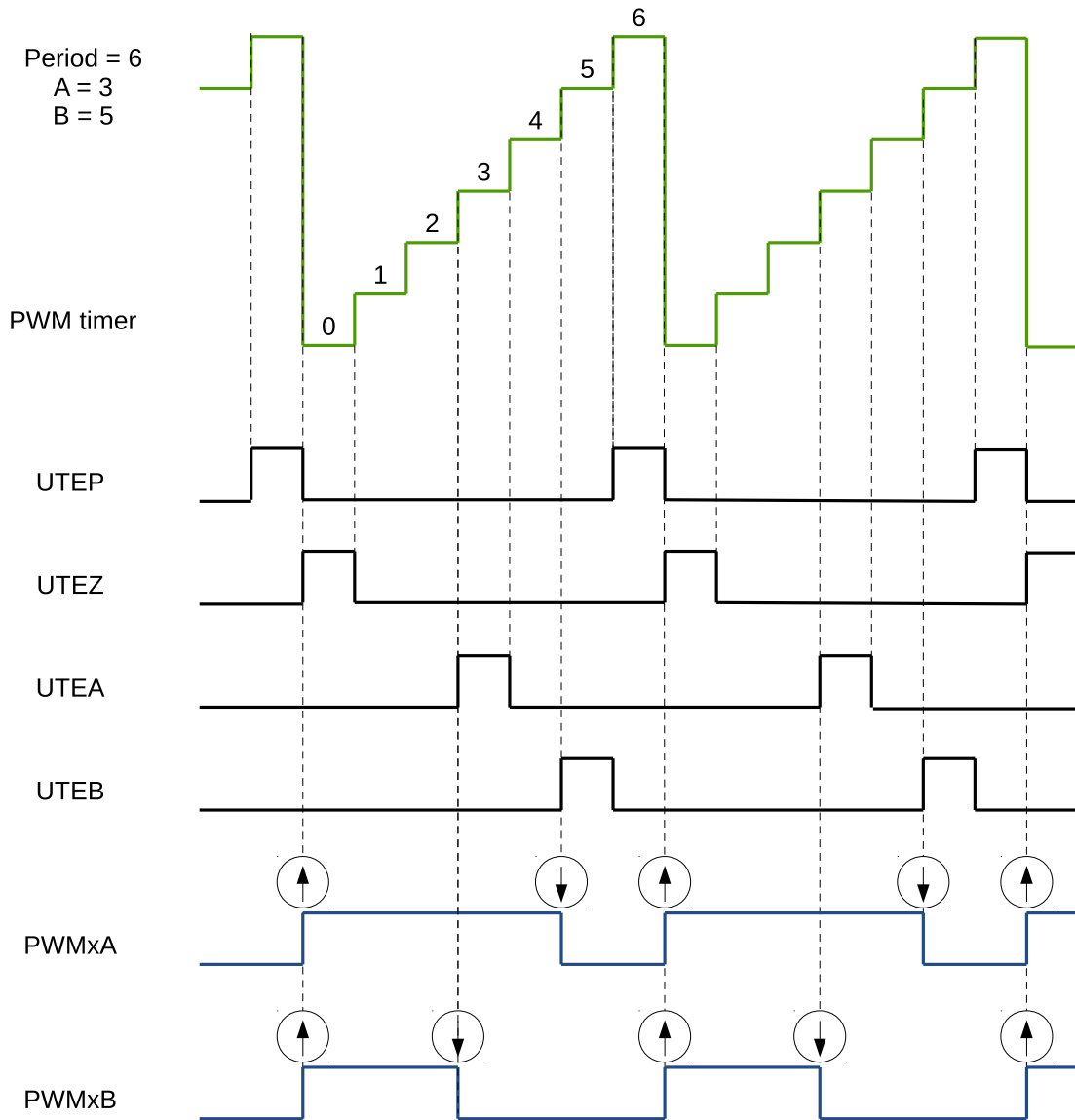

Figure 36-16. Count-Up, Single Edge Asymmetric Waveform, with Independent Modulation on PWMxA and PWMxB – Active High

The duty modulation for PWMxA is set by B, active high and proportional to B.

The duty modulation for PWMxB is set by A, active high and proportional to A.

$$Period = (MCPWM_TIMER_PERIOD + 1) \times T_{PT_clk}$$

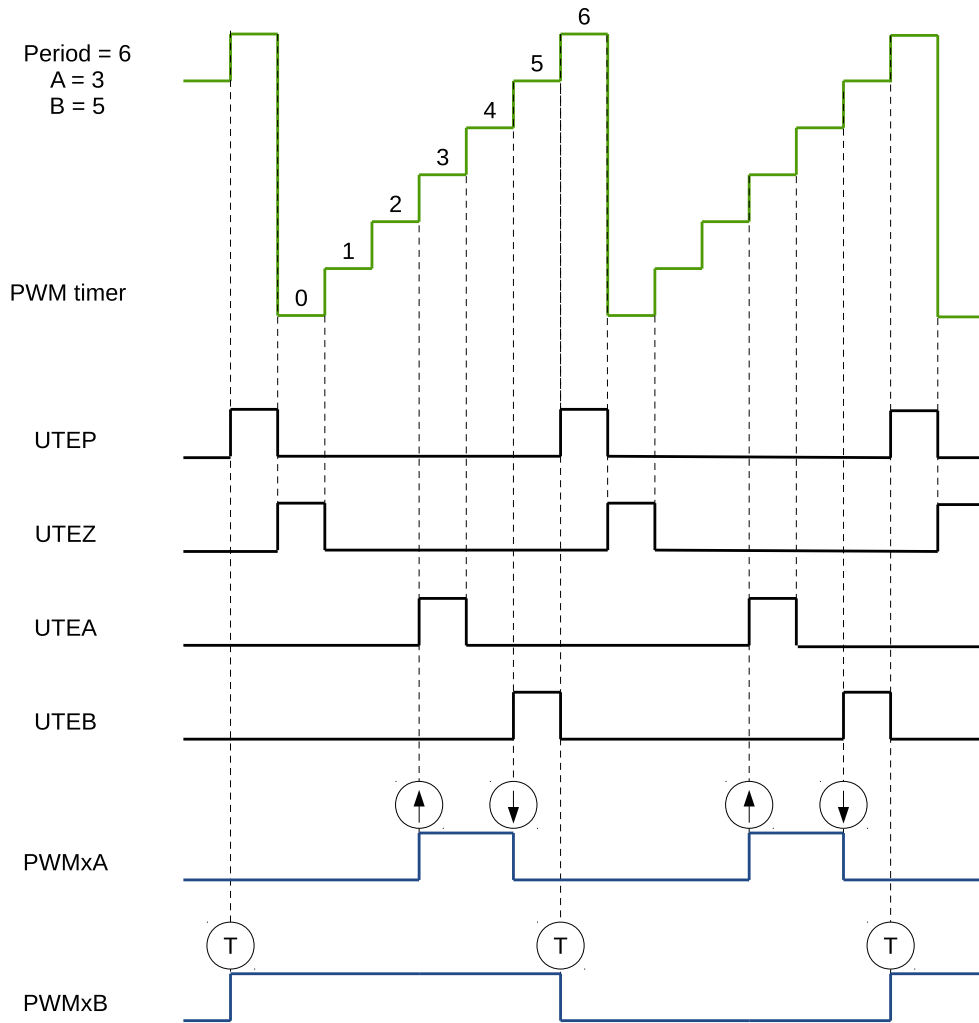

Figure 36-17. Count-Up, Pulse Placement Asymmetric Waveform with Independent Modulation on PWMxA

Pulses may be generated anywhere within the PWM cycle (zero – period).

PWMxA's high time duty is proportional to (B – A).

$$Period = (MCPWM_TIMER_PERIOD + 1) \times T_{PT_clk}$$

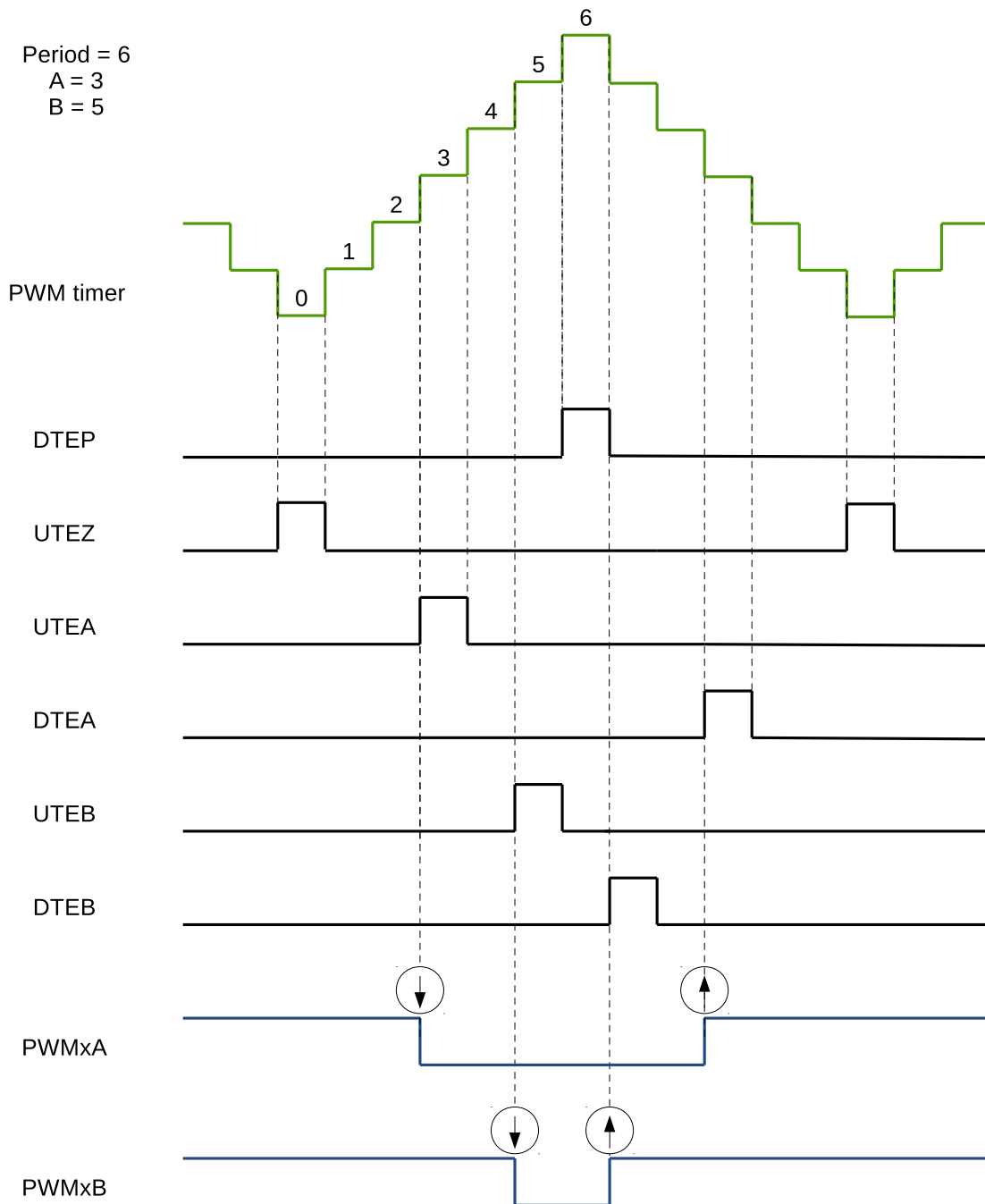

Figure 36-18. Count-Up-Down, Dual Edge Symmetric Waveform, with Independent Modulation on PWMxA and PWMxB – Active High

The duty modulation for PWMxA is set by A, active high and proportional to A.
The duty modulation for PWMxB is set by B, active high and proportional to B.
Outputs PWMxA and PWMxB can drive independent switches.

$$Period = (2 \times MCPWM_TIMER_PERIOD) \times T_{PT_clk}$$

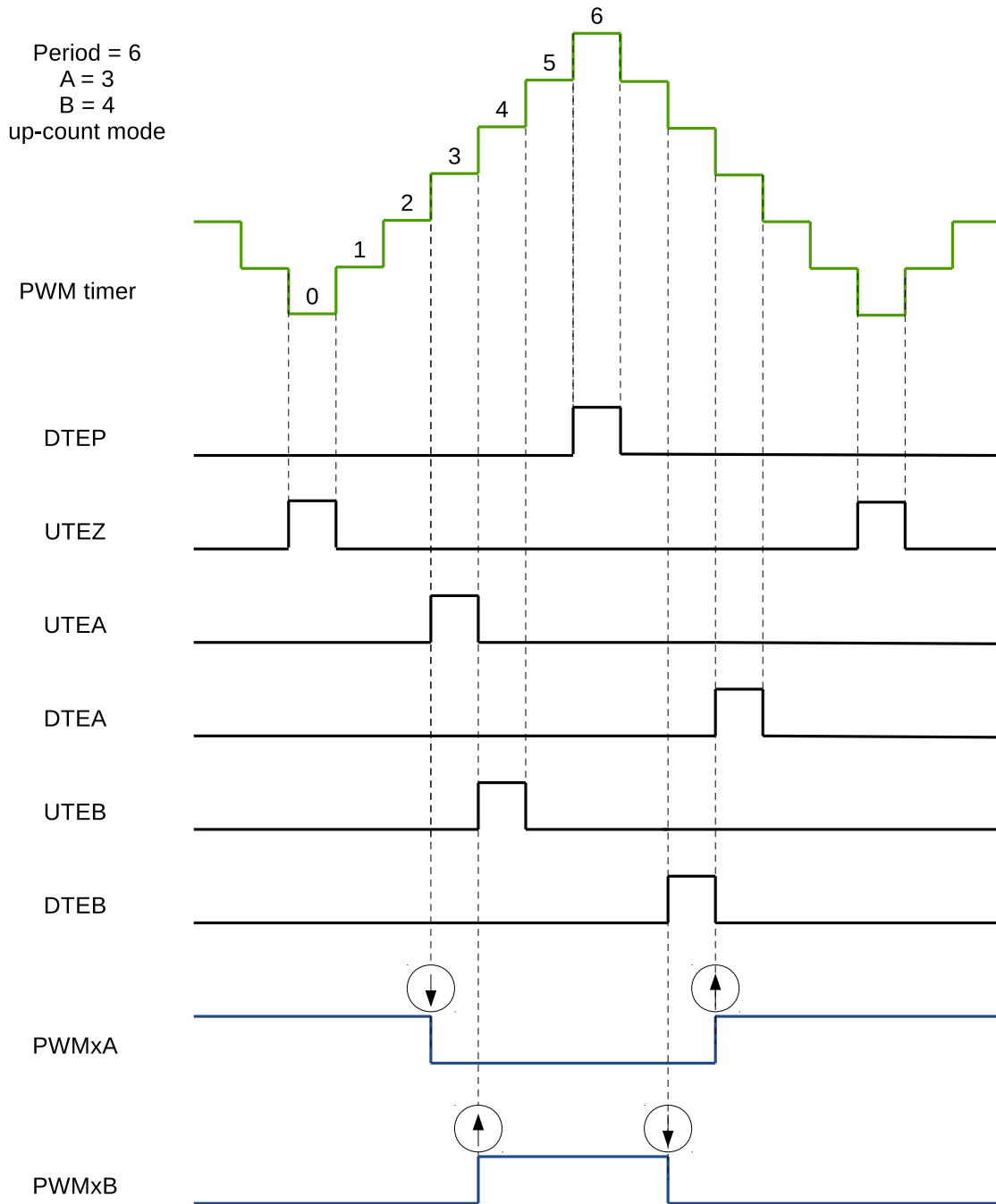

Figure 36-19. Count-Up-Down, Dual Edge Symmetric Waveform, with Independent Modulation on PWMxA and PWMxB – Complementary

The duty modulation of PWMxA is set by A, is active high and proportional to A.

The duty modulation of PWMxB is set by B, is active low and proportional to B.

Outputs PWMx can drive upper/lower (complementary) switches.

Dead-time = B – A; Edge placement is fully programmable by software. Use the dead-time generator module if another edge delay method is required.

$$Period = (2 \times MCPWM_TIMERx_PERIOD) \times T_{PT_clk}$$

Software-Force Events

There are two types of software-force events inside the PWM generator:

- Non-continuous-immediate (NCI) software-force events
Such types of events are immediately effective on PWM outputs when triggered by software. The forcing is non-continuous, meaning the next active timing events will be able to alter the PWM outputs.
- Continuous (CNTU) software-force events
Such types of events are continuous. The forced PWM outputs will continue until they are released by software. The events' triggers are configurable. They can be timing events or immediate events.

Figure 36-20 shows a waveform of NCI software-force events. NCI events are used to force PWMxA output low. Forcing on PWMxB is disabled in this case.

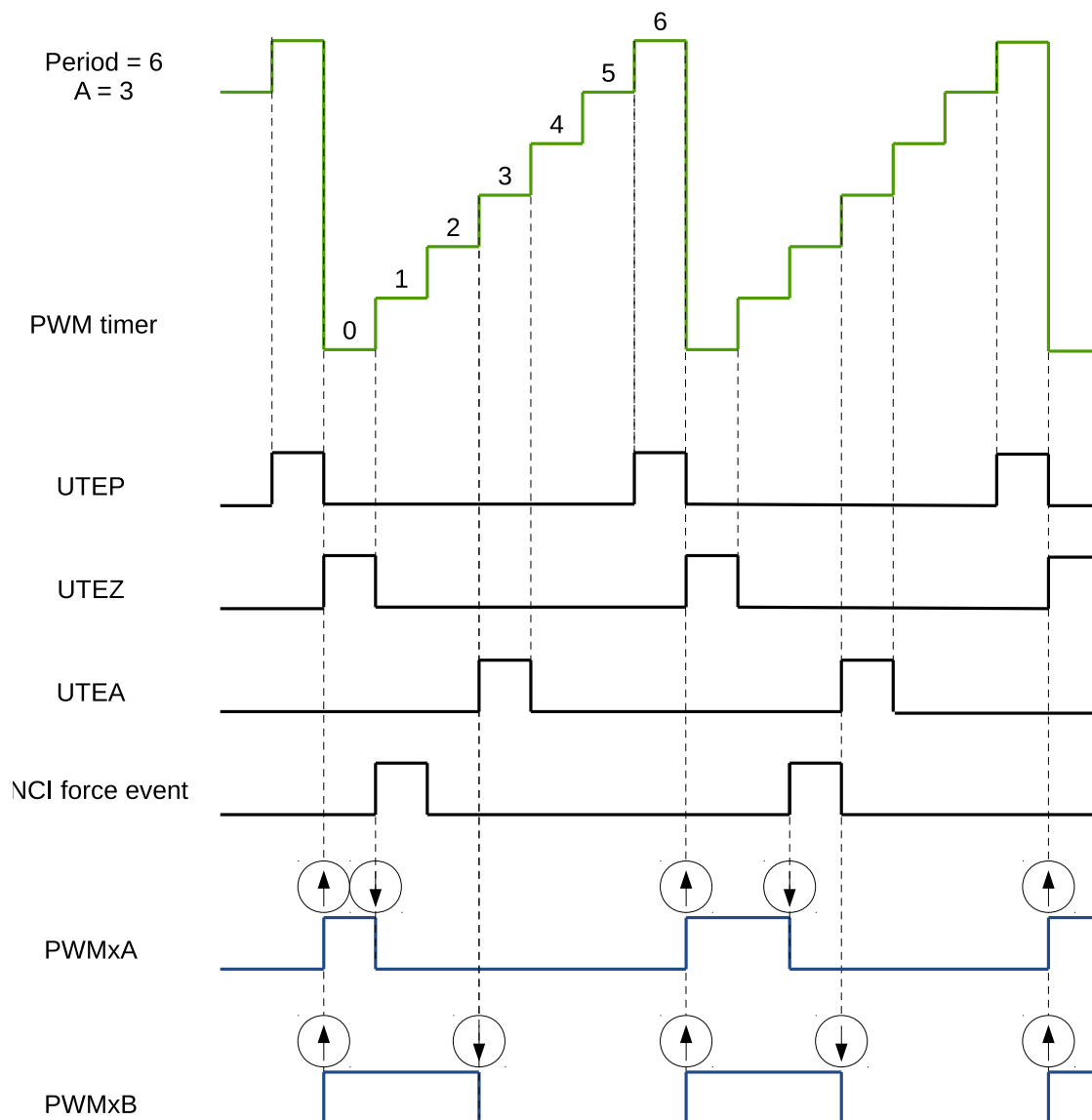

Figure 36-20. Example of an NCI Software-Force Event on PWMxA

Figure 36-21 shows a waveform of CNTU software-force events. UTEZ events are selected as triggers for CNTU software-force events. CNTU is used to force the PWMxB output low. Forcing on PWMxA is disabled.

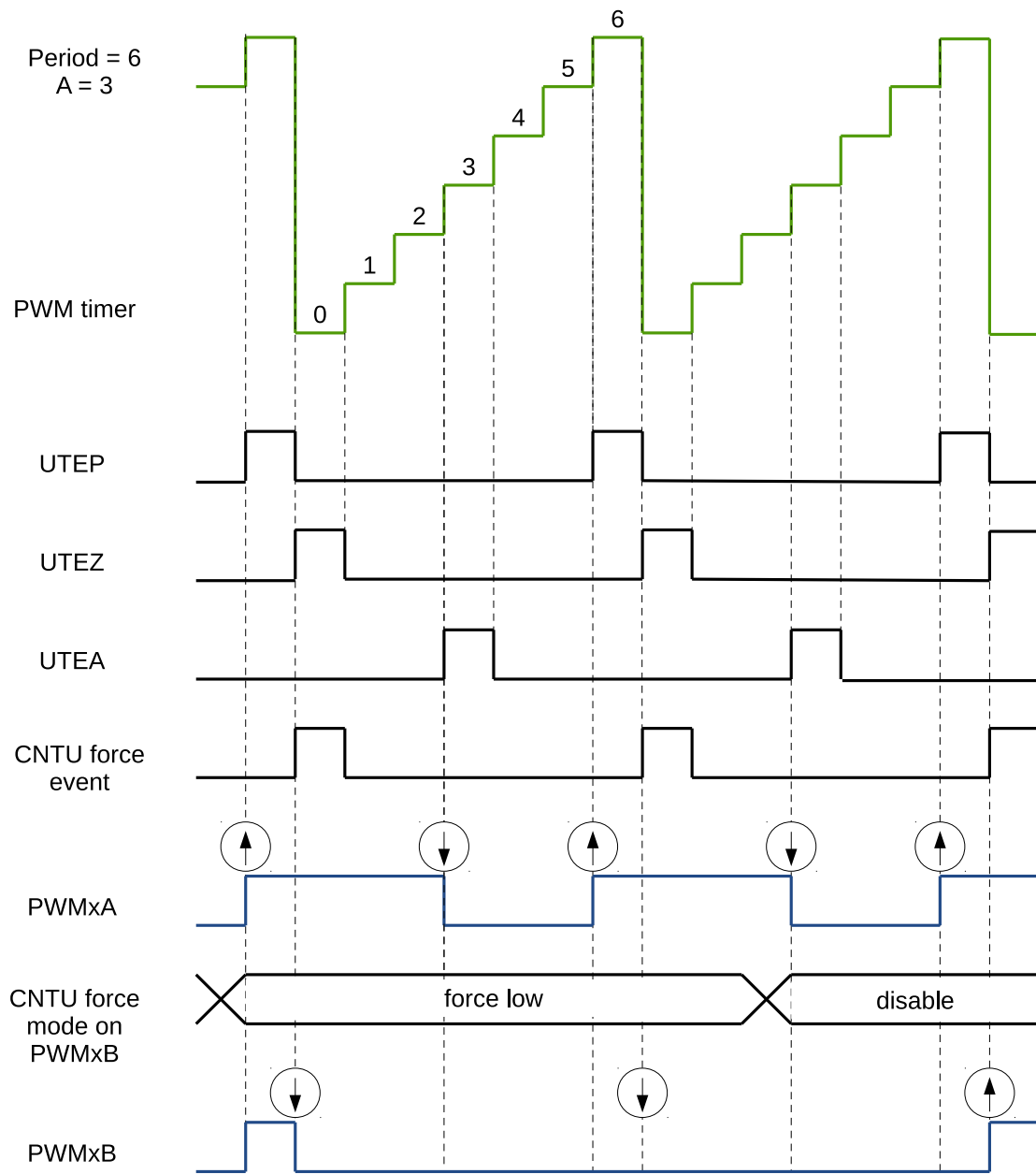

Figure 36-21. Example of a CNTU Software-Force Event on PWMxB

36.3.3.2 Dead Time Generator Submodule

Purpose of the Dead Time Generator Submodule

Several options to generate signals on PWMxA and PWMxB outputs, with a specific placement of signal edges, have been discussed in section 36.3.3.1. The required dead time is obtained by altering the edge placement between signals and by setting the signal's duty cycle. Another option is to control the dead time using a specialized submodule – the Dead Time Generator.

The key functions of the dead time generator submodule are as follows:

- Generating signal pairs (PWMxA and PWMxB) with a dead time from a single PWMxA input
- Creating a dead time by adding delay to signal edges:
 - Rising edge delay (RED)
 - Falling edge delay (FED)
- Configuring the signal pairs to be:
 - Active high complementary (AHC)
 - Active low complementary (ALC)
 - Active high (AH)
 - Active low (AL)
- This submodule may also be bypassed, if the dead time is configured directly in the generator submodule.

Dead Time Generator's Shadow Registers

Delay registers RED and FED are shadowed with registers [MCPWM_DT_x_RED_CFG_REG](#) and [MCPWM_DT_x_FED_CFG_REG](#). When [MCPWM_GLOBAL_UP_EN](#) is set to 1, the shadow registers can be written to the active register at specified time. The update method register for [MCPWM_DT_x_RED_CFG_REG](#) is [MCPWM_DT_RED_UPMETHOD](#). The update method register for [MCPWM_DT_x_FED_CFG_REG](#) is [MCPWM_DT_FED_UPMETHOD](#). The Software can also trigger a globally forced update bit [MCPWM_GLOBAL_FORCE_UP](#) which will prompt all registers in the module to be updated according to shadow registers. For the description of shadow registers, please see section 36.3.2.3.

Highlights for Operation of the Dead Time Generator

Options for setting up the dead-time submodule are shown in Figure 36-22.

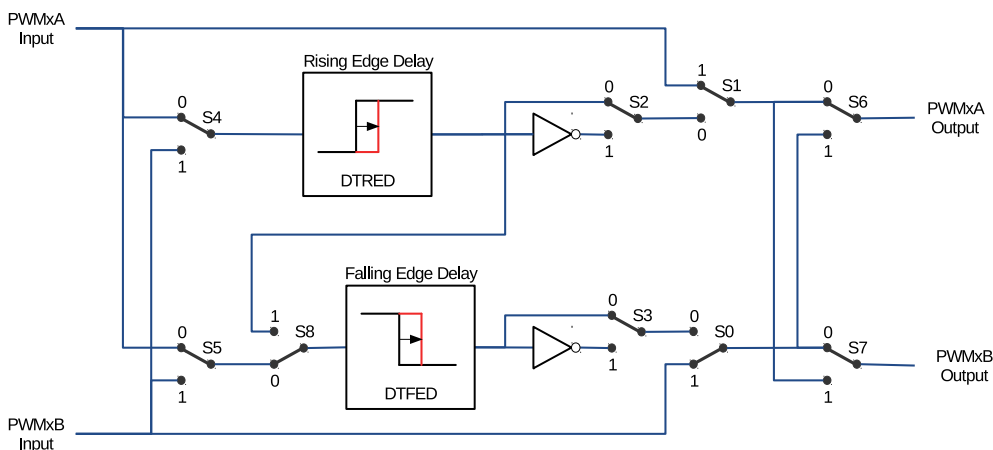

Figure 36-22. Options for Setting up the Dead Time Generator Submodule

S0-S8 in the figure above are switches controlled by fields in register `MCPWM_DT x _CFG_REG` shown in Table 36-5.

Table 36-5. Dead Time Generator Switches Control Fields

Switch	Field
S0	<code>MCPWM_DTx_B_OUTBYPASS</code>
S1	<code>MCPWM_DTx_A_OUTBYPASS</code>
S2	<code>MCPWM_DTx_RED_OUTINVERT</code>
S3	<code>MCPWM_DTx_FED_OUTINVERT</code>
S4	<code>MCPWM_DTx_RED_INSEL</code>
S5	<code>MCPWM_DTx_FED_INSEL</code>
S6	<code>MCPWM_DTx_A_OUTSWAP</code>
S7	<code>MCPWM_DTx_B_OUTSWAP</code>
S8	<code>MCPWM_DTx_DEB_MODE</code>

All switch combinations are supported, but not all of them represent the typical modes of use. Table 36-6 documents some typical dead time configurations. In these configurations the position of S4 and S5 sets PWMxA as the common source of both falling-edge and rising-edge delay. The modes presented in table 36-6 may be categorized as follows:

Table 36-6. Typical Dead Time Generator Operating Modes

Mode	Mode Description	S0	S1	S2	S3
1	PWMxA and PWMxB Pass Through/No Delay	1	1	X	X
2	Active High Complementary (AHC), see Figure 36-23	0	0	0	1
3	Active Low Complementary (ALC), see Figure 36-24	0	0	1	0
4	Active High (AH), see Figure 36-25	0	0	0	0
5	Active Low (AL), see Figure 36-26	0	0	1	1
6	PWMxA Output = PWMxA In (No Delay) PWMxB Output = PWMxA Input with Falling Edge Delay	0	1	0 or 1	0 or 1
7	PWMxA Output = PWMxA Input with Rising Edge Delay PWMxB Output = PWMxB Input with No Delay	1	0	0 or 1	0 or 1

Note:

For all the modes above, the position of the binary switches S4 to S8 is set to 0.

- **Mode 1: Bypass delays on both falling (FED) as well as raising edge (RED)**

In this mode the dead time submodule is disabled. Signals PWMxA and PWMxB pass through without any modifications.

- **Mode 2-5: Classical Dead Time Polarity Settings**

These modes represent typical configurations of polarity and should cover the active-high/low modes in available industry power switch gate drivers. The typical waveforms are shown in Figures 36-23 to 36-26.

- **Modes 6 and 7: Bypass delay on falling edge (FED) or rising edge (RED)**

In these modes, either RED (Rising Edge Delay) or FED (Falling Edge Delay) is bypassed. As a result, the corresponding delay is not applied.

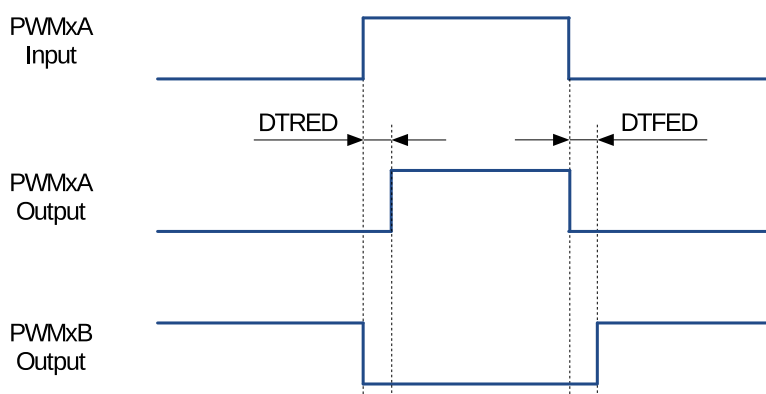

Figure 36-23. Active High Complementary (AHC) Dead Time Waveforms

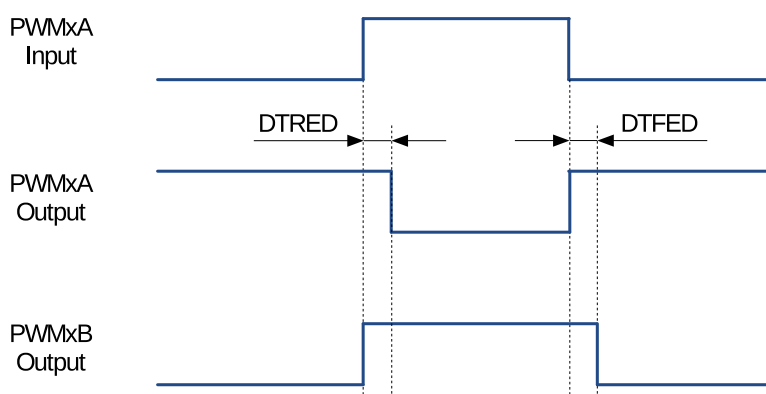

Figure 36-24. Active Low Complementary (ALC) Dead Time Waveforms

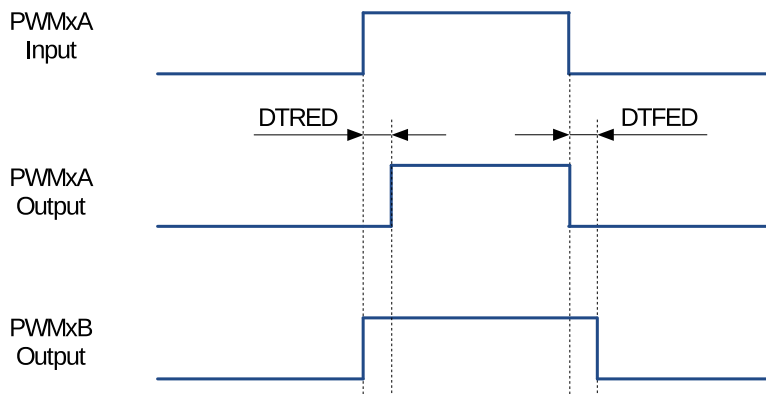

Figure 36-25. Active High (AH) Dead Time Waveforms

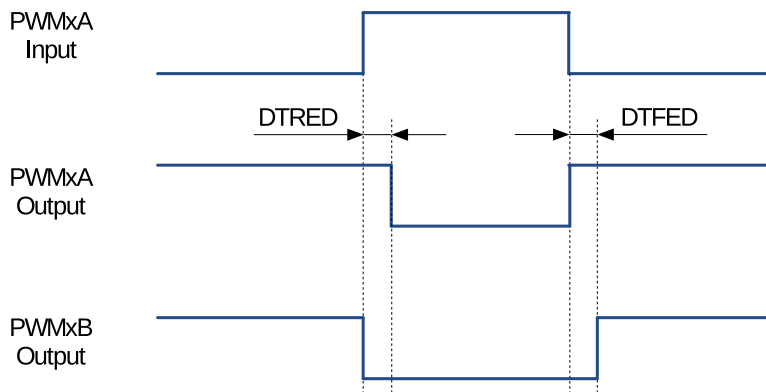

Figure 36-26. Active Low (AL) Dead Time Waveforms

Rising edge (RED) and falling edge (FED) delays may be set up independently. The delay value is programmed using the 16-bit registers `MCPWM_DT x _RED` and `MCPWM_DT x _FED`. The register value represents the number of clock (`DT_clk`) periods by which a signal edge is delayed. `DT_CLK` can be selected from `PWM_clk` or `PT_clk` through register `MCPWM_DT x _CLK_SEL`.

To calculate the delay on falling edge (FED) and rising edge (RED), use the following formulas:

$$FED = MCPWM_DTx_FED \times T_{DT_clk}$$

$$RED = MCPWM_DTx_RED \times T_{DT_clk}$$

36.3.3.3 PWM Carrier Submodule

The coupling of PWM output to a motor driver may need isolation with a transformer. Transformers deliver only AC signals, while the duty cycle of a PWM signal may range anywhere from 0% to 100%. The PWM carrier submodule passes such a PWM signal through a transformer by using a high frequency carrier to modulate the signal.

Function Overview

The following key characteristics of this submodule are configurable:

- Carrier frequency
- Pulse width of the first pulse
- Duty cycle of the second and the subsequent pulses
- Enabling/disabling the carrier function

Operational Highlights

The PWM carrier clock (PC_clk) is derived from PWM_clk. The frequency and duty cycle are configured by the `MCPWM_CARRIERx_PRESCALE` and `MCPWM_CARRIERx_DUTY` bits in the `MCPWM_CARRIERx_CFG_REG` register. The purpose of one-shot pulses is to provide high-energy impulse to reliably turn on the power switch. Subsequent pulses sustain the power-on status. The width of a one-shot pulse is configurable with the `MCPWM_CARRIERx_OSHTWTH` bits. Enabling/disabling of the carrier submodule is done with the `MCPWM_CARRIERx_EN` bit.

Waveform Examples

Figure 36-27 shows an example of waveforms, where a carrier is superimposed on original PWM pulses. This figure do not show the first one-shot pulse and the duty-cycle control. Related details are covered in the following two sections.

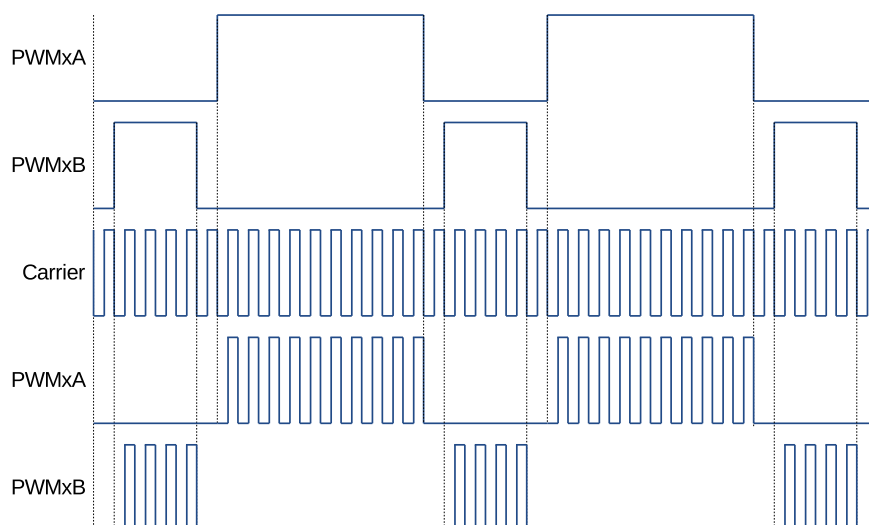

Figure 36-27. Example of Waveforms Showing PWM Carrier Action

One-Shot Pulse

The width of the first pulse is configurable. It may assume one of 16 possible values and is described by the formula below:

$$T_{1stpulse} = T_{PWM_clk} \times 8 \times (MCPWM_CARRIERx_PRESCALE + 1) \times (MCPWM_CARRIERx_OSHTWTH + 1)$$

Where:

- T_{PWM_clk} is the period of the PWM clock (PWM_clk).
- $(MCPWM_CARRIERx_OSHTWTH + 1)$ is the width of the first pulse (whose value ranges from 1 to 16).
- $(MCPWM_CARRIERx_PRESCALE + 1)$ is the PWM carrier clock's (PC_clk) prescaler value.

The first one-shot pulse and subsequent sustaining pulses are shown in Figure 36-28.

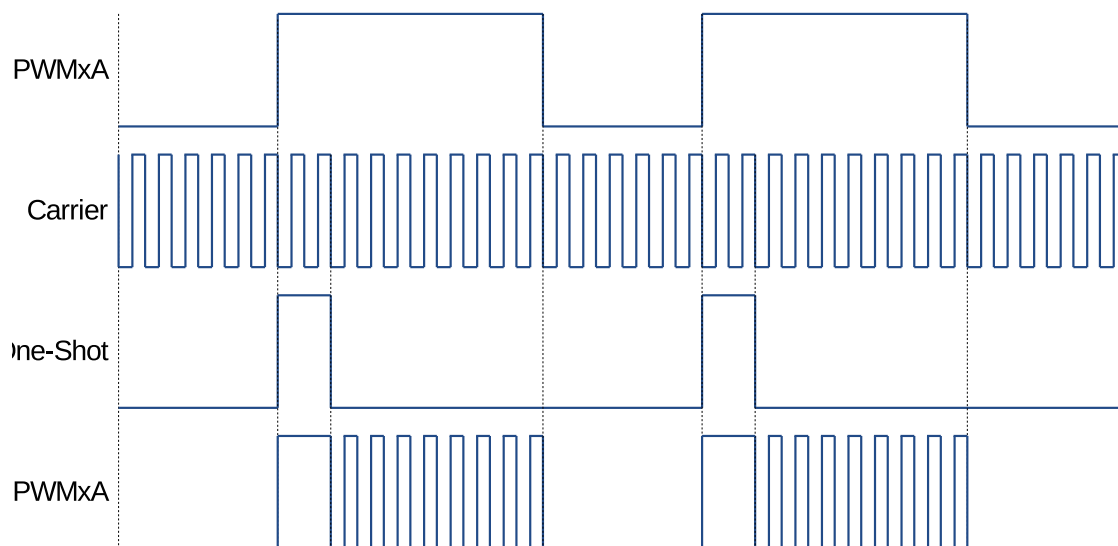

Figure 36-28. Example of the First Pulse and the Subsequent Sustaining Pulses of the PWM Carrier Submodule

Duty Cycle Control

After issuing the first one-shot pulse, the remaining PWM signal is modulated according to the carrier frequency. Users can configure the duty cycle of this signal. Tuning of duty may be required, so that the signal passes through the isolating transformer and can still operate (turn on/off) the motor drive, changing rotation speed and direction.

The duty cycle may be set to one of seven values, using `MCPWM_CARRIERx_DUTY`, or bits [7:5] of register

`MCPWM_CARRIERx_CFG_REG`.

Below is the formula for calculating the duty cycle:

$$Duty = MCPWM_CARRIERx_DUTY \div 8$$

All seven settings of the duty cycle are shown in Figure 36-29.

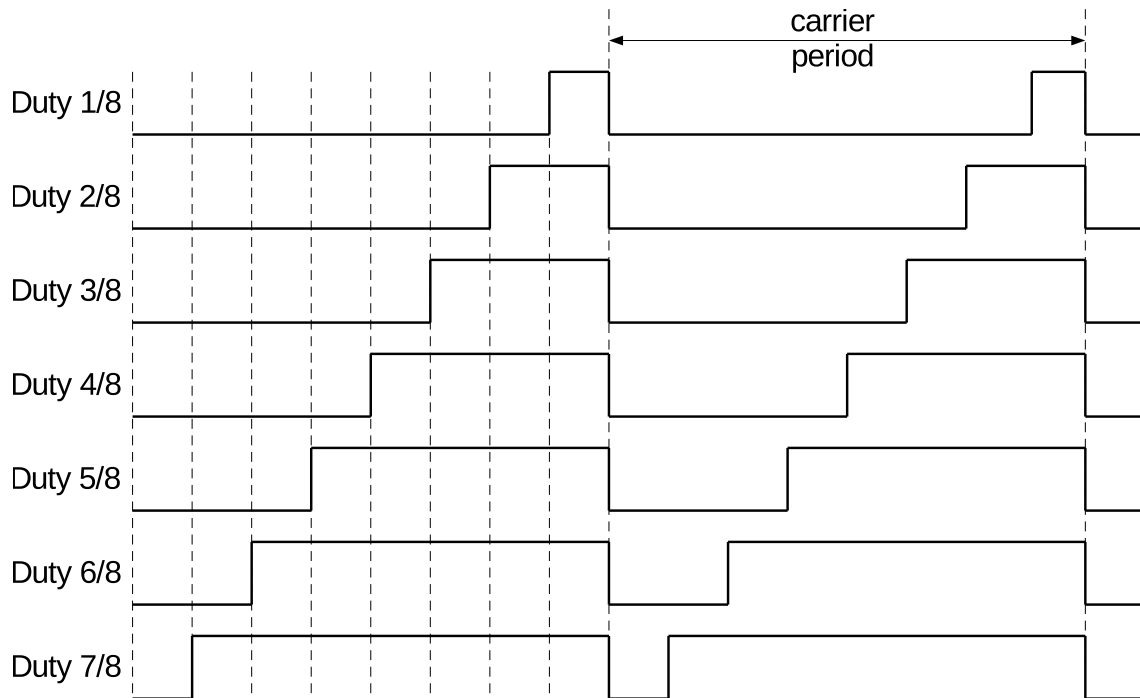

Figure 36-29. Possible Duty Cycle Settings for Sustaining Pulses in the PWM Carrier Submodule

36.3.3.4 Fault Handler Submodule

Each MCPWM peripheral is connected to three fault signals (FAULT0, FAULT1 and FAULT2) which are sourced from the GPIO matrix. These signals are intended to indicate external fault conditions, and may be preprocessed by the fault detection submodule to generate fault events. Fault events can then execute the user code to control MCPWM outputs in response to specific faults.

Function of Fault Handler Submodule

The key actions performed by the fault handler submodule are:

- Forcing outputs PWMxA and PWMxB, upon detected fault, to one of the following states:
 - High
 - Low
 - Toggle
 - No action taken
- Execution of one-shot trip (OST) upon detection of over-current conditions/short circuits.
- Cycle-by-cycle tripping (CBC) to provide current-limiting operation.
- Allocation of either one-shot or cycle-by-cycle operation for each fault signal.
- Generation of interrupts for each fault input.
- Support for software-force tripping.
- Enabling or disabling of submodule function as required.

Operation and Configuration Tips

This section provides the operational tips and set-up options for the fault handler submodule.

Fault signals coming from pins are sampled and synced in the GPIO matrix. In order to guarantee the successful sampling of fault pulses, each pulse duration must be at least two APB clock cycles. The fault detection submodule will then sample fault signals by using PWM_clk. So, the duration of fault pulses coming from GPIO matrix must be at least one PWM_clk cycle. Differently put, regardless of the period relation between APB clock and PWM_clk, the width of fault signal pulses on pins must be at least equal to the sum of two APB clock cycles and one PWM_clk cycle.

Each level of fault signals, FAULT0 to FAULT2, can be used by the fault handler submodule to generate fault events (fault_event0 to fault_event2). Every fault event can be configured individually to provide CBC action, OST action, or none.

- **Cycle-by-Cycle (CBC) action:**

When CBC action is triggered, the state of PWMxA and PWMxB will be changed immediately according to the configuration of fields [MCPWM_FHx_A_CBC_U/D](#) and [MCPWM_FHx_B_CBC_U/D](#). Different actions can be indicted when the PWM timer is incrementing or decrementing. Different CBC action interrupts can be triggered for different fault events. Status field [MCPWM_FHx_CBC_ON](#) indicates whether a CBC action is on or off. When the fault event is no longer present, CBC actions on PWMxA/B will be cleared at a specified point, which is either a D/UTEP or D/UTEZ event. Field [MCPWM_FHx_CBCPULSE](#) determines at which event PWMxA and PWMxB will be able to resume normal actions. Therefore, in this mode, the CBC action is cleared or refreshed upon every PWM cycle.

- **One-Shot (OST) action:**

When OST action is triggered, the state of PWMxA and PWMxB will be changed immediately, depending on the setting of fields [MCPWM_FHx_A_OST_U/D](#) and [MCPWM_FHx_B_OST_U/D](#). Different actions can be configured when PWM timer is incrementing or decrementing. Different OST action interrupts can be triggered from different fault events. Status field [MCPWM_FHx_OST_ON](#) indicates whether an OST action is on or off. The OST actions on PWMxA/B are not automatically cleared when the fault event is no longer present. One-shot actions must be cleared manually by setting the rising edge of the [MCPWM_FHx_CLR_OST](#) bit.

36.3.4 Capture Submodule

36.3.4.1 Introduction

The capture submodule contains three complete capture channels. Channel inputs CAP0, CAP1 and CAP2 are sourced from the GPIO matrix. Thanks to the flexibility of the GPIO matrix, CAP0, CAP1 and CAP2 can be configured from any pin input. Multiple capture channels can be sourced from the same pin input, while prescaling for each channel can be set differently. Also, capture channels are sourced from different pins. This provides several options for handling capture signals by hardware in the background, instead of having them processed directly by the CPU. A capture submodule has the following independent key resources:

- One 32-bit timer (counter) which can be synchronized with the PWM timer, another submodule or software.
- Three capture channels, each equipped with a 32-bit time-stamp and a capture prescaler.
- Independent edge polarity (rising/falling edge) selection for any capture channel.
- Input capture signal prescaling (from 1 to 256).

- Interrupt capabilities on any of the three capture events.

36.3.4.2 Capture Timer

The capture timer is a 32-bit counter incrementing continuously. It is enabled by setting `MCPWM_CAP_TIMER_EN` to 1. Its operating clock source is `APB_CLK`. When `MCPWM_CAP_SYNCI_EN` is configured, the counter will be loaded with phase stored in register `MCPWM_CAP_TIMER_PHASE_REG` at the time of a sync event. Sync events can select from PWM timers sync-out, PWM module sync-in by configuring `MCPWM_CAP_SYNCI_SEL`. Sync event can also generate by setting `MCPWM_CAP_SYNC_SW`. The capture timer provides timing references for all three capture channels.

36.3.4.3 Capture Channel

The capture signal coming to a capture channel will be inverted first, if needed, and then prescaled. Each capture channel has a prescaler register of `MCPWM_CAPx_PRESCALE`. Finally, specified edges of preprocessed capture signal will trigger capture events. Setting `MCPWM_CAPx_EN` to enable a capture channel. The capture event occurs at the time selected by the `MCPWM_CAPx_MODE`. When a capture event occurs, the capture timer's value is stored in time-stamp register `MCPWM_CAP_CHx_REG`. Different interrupts can be generated for different capture channels at capture events. The edge that triggers a capture event is recorded in register `MCPWM_CAPx_EDGE`. The capture event can be also forced by software setting `MCPWM_CAPx_SW`.

36.4 Register Summary

The addresses in this section are relative to Motor Control PWM0 and Motor Control PWM1 base address provided in Table 4-3 in Chapter 4 *System and Memory*.

The abbreviations given in Column **Access** are explained in Section [Access Types for Registers](#).

Name	Description	Address	Access
Prescaler configuration			
MCPWM_CLK_CFG_REG	PWM clock prescaler register	0x0000	R/W
PWM Timer 0 Configuration and status			
MCPWM_TIMER0_CFG0_REG	PWM timer0 period and update method configuration register	0x0004	R/W
MCPWM_TIMER0_CFG1_REG	PWM timer0 working mode and start/stop control configuration register	0x0008	R/W
MCPWM_TIMER0_SYNC_REG	PWM timer0 sync function configuration register	0x000C	R/W
MCPWM_TIMER0_STATUS_REG	PWM timer0 status register	0x0010	RO
PWM Timer 1 Configuration and Status			
MCPWM_TIMER1_CFG0_REG	PWM timer1 period and update method configuration register	0x0014	R/W
MCPWM_TIMER1_CFG1_REG	PWM timer1 working mode and start/stop control configuration register	0x0018	varies
MCPWM_TIMER1_SYNC_REG	PWM timer1 sync function configuration register	0x001C	R/W
MCPWM_TIMER1_STATUS_REG	PWM timer1 status register	0x0020	RO
PWM Timer 2 Configuration and status			
MCPWM_TIMER2_CFG0_REG	PWM timer2 period and update method configuration register	0x0024	R/W
MCPWM_TIMER2_CFG1_REG	PWM timer2 working mode and start/stop control configuration register	0x0028	varies
MCPWM_TIMER2_SYNC_REG	PWM timer2 sync function configuration register	0x002C	R/W
MCPWM_TIMER2_STATUS_REG	PWM timer2 status register	0x0030	RO
Common configuration for PWM timers			
MCPWM_TIMER_SYNCI_CFG_REG	Synchronization input selection for three PWM timers	0x0034	R/W
MCPWM_OPERATOR_TIMERSEL_REG	Select specific timer for PWM operators	0x0038	R/W
PWM Operator 0 Configuration and Status			
MCPWM_GEN0_STMP_CFG_REG	Transfer status and update method for time stamp registers A and B	0x003C	varies
MCPWM_GEN0_TSTMP_A_REG	PWM generator 0 shadow register for timer stamp A	0x0040	R/W
MCPWM_GEN0_TSTMP_B_REG	PWM generator 0 shadow register for timer stamp B	0x0044	R/W
MCPWM_GEN0_CFG0_REG	PWM generator 0 event T0 and T1 handling	0x0048	R/W
MCPWM_GEN0_FORCE_REG	Permissive to force PWM0A and PWM0B outputs by software	0x004C	R/W
MCPWM_GEN0_A_REG	Actions triggered by events on PWM0A	0x0050	R/W

Name	Description	Address	Access
MCPWM_GEN0_B_REG	Actions triggered by events on PWM0B	0x0054	R/W
MCPWM_DT0_CFG_REG	PWM generator 0 dead time type selection and configuration	0x0058	R/W
MCPWM_DT0_FED_CFG_REG	PWM generator 0 shadow register for falling edge delay (FED)	0x005C	R/W
MCPWM_DT0_RED_CFG_REG	PWM generator 0 shadow register for rising edge delay (RED)	0x0060	R/W
MCPWM_CARRIER0_CFG_REG	PWM generator 0 carrier enable and configuration	0x0064	R/W
MCPWM_FH0_CFG0_REG	Actions on PWM0A and PWM0B on trip events	0x0068	R/W
MCPWM_FH0_CFG1_REG	Software triggers for fault handler actions	0x006C	R/W
MCPWM_FH0_STATUS_REG	Status of fault events	0x0070	RO
PWM Operator 1 Configuration and Status			
MCPWM_GEN1_STMP_CFG_REG	Transfer status and update method for time stamp registers A and B	0x0074	varies
MCPWM_GEN1_TSTMP_A_REG	PWM generator 1 shadow register for timer stamp A	0x0078	R/W
MCPWM_GEN1_TSTMP_B_REG	PWM generator 1 shadow register for timer stamp B	0x007C	R/W
MCPWM_GEN1_CFG0_REG	PWM generator 1 event T0 and T1 handling	0x0080	R/W
MCPWM_GEN1_FORCE_REG	Permissive to force PWM1A and PWM1B outputs by software	0x0084	R/W
MCPWM_GEN1_A_REG	Actions triggered by events on PWM1A	0x0088	R/W
MCPWM_GEN1_B_REG	Actions triggered by events on PWM1B	0x008C	R/W
MCPWM_DT1_CFG_REG	PWM generator 1 dead time type selection and configuration	0x0090	R/W
MCPWM_DT1_FED_CFG_REG	PWM generator 1 shadow register for falling edge delay (FED)	0x0094	R/W
MCPWM_DT1_RED_CFG_REG	PWM generator 1 shadow register for rising edge delay (RED)	0x0098	R/W
MCPWM_CARRIER1_CFG_REG	PWM generator 1 carrier enable and configuration	0x009C	R/W
MCPWM_FH1_CFG0_REG	Actions on PWM1A and PWM1B trip events	0x00A0	R/W
MCPWM_FH1_CFG1_REG	Software triggers for fault handler actions	0x00A4	R/W
MCPWM_FH1_STATUS_REG	Status of fault events	0x00A8	RO
PWM Operator 2 Configuration and Status			
MCPWM_GEN2_STMP_CFG_REG	Transfer status and update method for time stamp registers A and B	0x00AC	varies
MCPWM_GEN2_TSTMP_A_REG	PWM generator 2 shadow register for timer stamp A	0x00B0	R/W
MCPWM_GEN2_TSTMP_B_REG	PWM generator 2 shadow register for timer stamp B	0x00B4	R/W
MCPWM_GEN2_CFG0_REG	PWM generator 2 event T0 and T1 handling	0x00B8	R/W

Name	Description	Address	Access
MCPWM_GEN2_FORCE_REG	Permissive to force PWM2A and PWM2B outputs by software	0x00BC	R/W
MCPWM_GEN2_A_REG	Actions triggered by events on PWM2A	0x00C0	R/W
MCPWM_GEN2_B_REG	Actions triggered by events on PWM2B	0x00C4	R/W
MCPWM_DT2_CFG_REG	PWM generator 2 dead time type selection and configuration	0x00C8	R/W
MCPWM_DT2_FED_CFG_REG	PWM generator 2 shadow register for falling edge delay (FED)	0x00CC	R/W
MCPWM_DT2_RED_CFG_REG	PWM generator 2 shadow register for rising edge delay (RED)	0x00D0	R/W
MCPWM_CARRIER2_CFG_REG	PWM generator 2 carrier enable and configuration	0x00D4	R/W
MCPWM_FH2_CFG0_REG	Actions on PWM2A and PWM2B trip events	0x00D8	R/W
MCPWM_FH2_CFG1_REG	Software triggers for fault handler actions	0x00DC	R/W
MCPWM_FH2_STATUS_REG	Status of fault events	0x00E0	RO
Fault Detection Configuration and Status			
MCPWM_FAULT_DETECT_REG	Fault detection configuration and status	0x00E4	varies
Capture Configuration and Status			
MCPWM_CAP_TIMER_CFG_REG	Configure capture timer	0x00E8	varies
MCPWM_CAP_TIMER_PHASE_REG	Phase for capture timer sync	0x00EC	R/W
MCPWM_CAP_CH0_CFG_REG	Capture channel 0 configuration and enable	0x00F0	varies
MCPWM_CAP_CH1_CFG_REG	Capture channel 1 configuration and enable	0x00F4	varies
MCPWM_CAP_CH2_CFG_REG	Capture channel 2 configuration and enable	0x00F8	varies
MCPWM_CAP_CH0_REG	Ch0 capture value status register	0x00FC	RO
MCPWM_CAP_CH1_REG	Ch1 capture value status register	0x0100	RO
MCPWM_CAP_CH2_REG	ch2 capture value status register	0x0104	RO
MCPWM_CAP_STATUS_REG	Edge of last capture trigger	0x0108	RO
Enable update of active registers			
MCPWM_UPDATE_CFG_REG	Enable update	0x010C	R/W
Manage Interrupts			
MCPWM_INT_ENA_REG	Interrupt enable bits	0x0110	R/W
MCPWM_INT_RAW_REG	Raw interrupt status	0x0114	R/WTC /SS
MCPWM_INT_ST_REG	Masked interrupt status	0x0118	RO
MCPWM_INT_CLR_REG	Interrupt clear bits	0x011C	WT
MCPWM APB Configuration Register			
MCPWM_CLK_REG	MCPWM APB configuration register	0x0120	R/W
Version Register			
MCPWM_VERSION_REG	Version control register	0x0124	R/W

36.5 Registers

The addresses in this section are relative to Motor Control PWM0 and Motor Control PWM1 base address provided in Table 4-3 in Chapter 4 *System and Memory*.

Register 36.1. MCPWM_CLK_CFG_REG (0x0000)

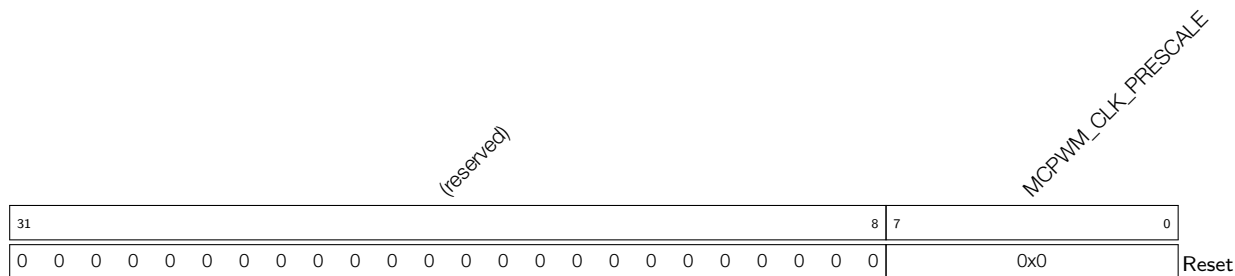

MCPWM_CLK_PRESCALE Period of PWM_clk = 6.25ns * (PWM_CLK_PRESCALE + 1). (R/W)

Register 36.2. MCPWM_TIMER0_CFG0_REG (0x0004)

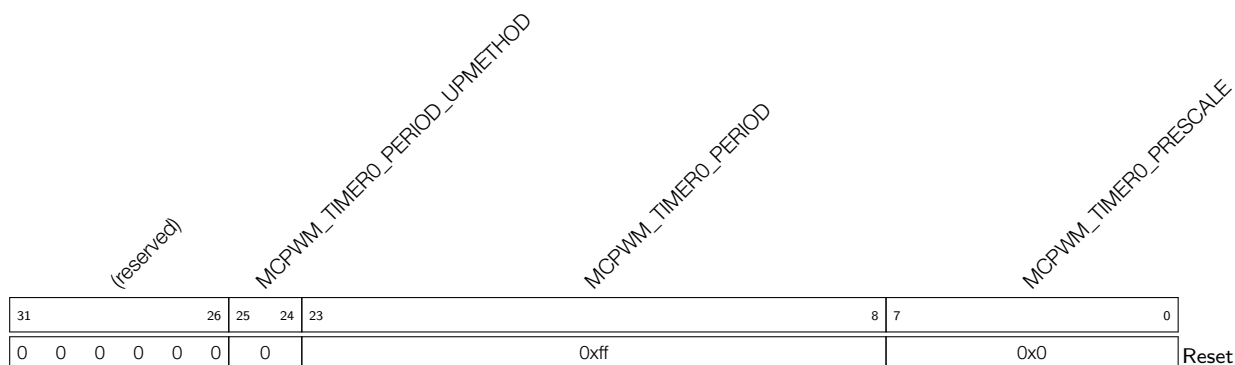

MCPWM_TIMER0_PRESCALE Period of PT0_clk = Period of PWM_clk * (PWM_TIMER0_PRESCALE + 1). (R/W)

MCPWM_TIMER0_PERIOD Period shadow register of PWM timer0. (R/W)

MCPWM_TIMER0_PERIOD_UPMETHOD Update method for active register of PWM timer0 period.
 0: immediate; 1: TEZ; 2: sync; 3: TEZ | sync. TEZ here and below means timer equal zero event.
 (R/W)

Register 36.4. MCPWM_TIMER0_SYNC_REG (0x000C)

(reserved)										MCPWM_TIMER0_PHASE_DIRECTION				MCPWM_TIMER0_PHASE				MCPWM_TIMER0_SYNC_SEL				MCPWM_TIMER0_SYNC_SW				MCPWM_TIMER0_SYNCI_EN				
31											21	20	19					4	3	2	1	0								
0 0 0 0 0 0 0 0 0 0										0				0				0				0				Reset				

MCPWM_TIMER0_SYNCI_EN When set, timer reloading with phase on sync input event is enabled. (R/W)

MCPWM_TIMER0_SYNC_SW Toggling this bit will trigger a software sync. (R/W)

MCPWM_TIMER0_SYNCO_SEL PWM timer0 sync_out selection, 0: sync_in; 1: TEZ; 2: TEP. The sync_out will always generate when toggling the [MCPWM_TIMER0_SYNC_SW](#) bit. (R/W)

MCPWM_TIMER0_PHASE Phase for timer reload on sync event. (R/W)

MCPWM_TIMER0_PHASE_DIRECTION Configure the PWM timer0's direction when timer0 mode is up-down mode. 0: increase; 1: decrease. (R/W)

Register 36.5. MCPWM_TIMER0_STATUS_REG (0x0010)

(reserved)										MCPWM_TIMER0_DIRECTION				MCPWM_TIMER0_VALUE				
31											17	16	15					0
0 0 0 0 0 0 0 0 0 0										0				0				Reset

MCPWM_TIMER0_VALUE Current PWM timer0 counter value. (RO)

MCPWM_TIMER0_DIRECTION Current PWM timer0 counter direction. 0: increment; 1: decrement. (RO)

Register 36.6. MCPWM_TIMER1_CFG0_REG (0x0014)

(reserved)						MCPWM_TIMER1_PERIOD_UPMETHOD						MCPWM_TIMER1_PERIOD						MCPWM_TIMER1_PRESCALE						
31						26	25	24	23							8	7							0
0						0						0xff						0x0						Reset

MCPWM_TIMER1_PRESCALE Period of PT0_clk = Period of PWM_clk * (PWM_timer1_PRESCALE + 1). (R/W)

MCPWM_TIMER1_PERIOD Period shadow register of PWM timer1. (R/W)

MCPWM_TIMER1_PERIOD_UPMETHOD Update method for active register of PWM timer1 period, 0: immediate, 1: TEZ, 2: sync, 3: TEZ | sync. TEZ here and below means timer equal zero event. (R/W)

Register 36.7. MCPWM_TIMER1_CFG1_REG (0x0018)

(reserved)																				MCPWM_TIMER1_MOD				MCPWM_TIMER1_START				
31																					5	4	3	2	0			
0																				0x0				0x0				Reset

MCPWM_TIMER1_START PWM timer1 start and stop control. (R/W/SC)

- 0: if PWM timer1 starts, then stops at TEZ;
- 1: if timer1 starts, then stops at TEP;
- 2: PWM timer1 starts and runs on;
- 3: timer1 starts and stops at the next TEZ;
- 4: timer1 starts and stops at the next TEP.

TEP here and below means the event that happens when the timer equals to period.

MCPWM_TIMER1_MOD PWM timer1 working mode. 0: freeze; 1: increase mode; 2: decrease mode; 3: up-down mode. (R/W)

Register 36.8. MCPWM_TIMER1_SYNC_REG (0x001C)

(reserved)										MCPWM_TIMER1_PHASE_DIRECTION				MCPWM_TIMER1_PHASE				MCPWM_TIMER1_SYNC_SEL				MCPWM_TIMER1_SYNC_SW				MCPWM_TIMER1_SYNCLEN				
31											21	20	19					4	3	2	1	0								
0 0 0 0 0 0 0 0 0 0										0				0				0				Reset								

MCPWM_TIMER1_SYNCI_EN When set, timer reloading with phase on sync input event is enabled. (R/W)

MCPWM_TIMER1_SYNC_SW Toggling this bit will trigger a software sync. (R/W)

MCPWM_TIMER1_SYNCO_SEL PWM timer1 sync_out selection. 0: sync_in; 1: TEZ; 2: TEP. The sync_out will always generate when toggling the reg_timer1_sync_sw bit. (R/W)

MCPWM_TIMER1_PHASE Phase for timer reload on sync event. (R/W)

MCPWM_TIMER1_PHASE_DIRECTION Configure the PWM timer1's direction when timer1 is in up-down mode. 0: increase; 1: decrease. (R/W)

Register 36.9. MCPWM_TIMER1_STATUS_REG (0x0020)

(reserved)										MCPWM_TIMER1_DIRECTION				MCPWM_TIMER1_VALUE							
31											17	16	15					0			
0 0 0 0 0 0 0 0 0 0										0				0				Reset			

MCPWM_TIMER1_VALUE Current value of PWM timer1 counter. (RO)

MCPWM_TIMER1_DIRECTION Current direction of PWM timer1 counter. 0: increment; 1: decrement. (RO)

Register 36.10. MCPWM_TIMER2_CFG0_REG (0x0024)

(reserved)							MCPWM_TIMER2_PERIOD_UPMETHOD							MCPWM_TIMER2_PERIOD								MCPWM_TIMER2_PRESCALE							
31						26	25	24	23								8	7							0				
0	0	0	0	0	0	0	0	0xf							0x0								Reset						

MCPWM_TIMER2_PRESCALE Period of PT0_clk = Period of PWM_clk * (PWM_timer2_PRESCALE + 1). (R/W)

MCPWM_TIMER2_PERIOD Period shadow register of PWM timer2. (R/W)

MCPWM_TIMER2_PERIOD_UPMETHOD Update method for active register of PWM timer2 period.
 0: immediate; 1: TEZ; 2: sync; 3: TEZ | sync. TEZ here and below means timer equal zero event.
 (R/W)

Register 36.11. MCPWM_TIMER2_CFG1_REG (0x0028)

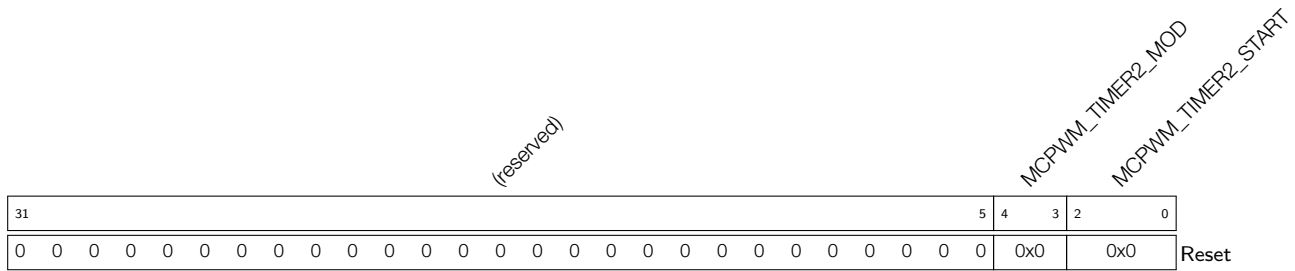

MCPWM_TIMER2_START PWM timer2 start and stop control. (R/W/SC)

- 0: if PWM timer2 starts, then stops at TEZ;
- 1: if timer2 starts, then stops at TEP;
- 2: PWM timer2 starts and runs on;
- 3: timer2 starts and stops at the next TEZ;
- 4: timer2 starts and stops at the next TEP.

TEP here and below means the event that happens when the timer equals to period.

MCPWM_TIMER2_MOD PWM timer2 working mode. (R/W)

- 0: freeze;
- 1: increase mode;
- 2: decrease mode;
- 3: up-down mode.

Register 36.14. MCPWM_TIMER_SYNCI_CFG_REG (0x0034)

(reserved)												MCPWM_EXTERNAL_SYNCI2_INVERT			MCPWM_EXTERNAL_SYNCI1_INVERT			MCPWM_EXTERNAL_SYNCI0_INVERT			MCPWM_TIMER2_SYNCISEL			MCPWM_TIMER1_SYNCISEL			MCPWM_TIMER0_SYNCISEL		
31											12	11	10	9	8			6	5			3	2			0	Reset		
0												0	0	0	0	0	0		0	0	0		0	0	0				

MCPWM_TIMER0_SYNCISEL Select sync input for PWM timer0. (R/W)

- 1: PWM timer0 sync_out;
- 2: PWM timer1 sync_out;
- 3: PWM timer2 sync_out;
- 4: SYNC0 from GPIO matrix;
- 5: SYNC1 from GPIO matrix;
- 6: SYNC2 from GPIO matrix;
- Other values: no sync input selected.

MCPWM_TIMER1_SYNCISEL Select sync input for PWM timer1. (R/W)

- 1: PWM timer0 sync_out;
- 2: PWM timer1 sync_out;
- 3: PWM timer2 sync_out;
- 4: SYNC0 from GPIO matrix;
- 5: SYNC1 from GPIO matrix;
- 6: SYNC2 from GPIO matrix;
- Other values: no sync input selected.

Continued on the next page...

Register 36.16. MCPWM_GEN0_STMP_CFG_REG (0x003C)

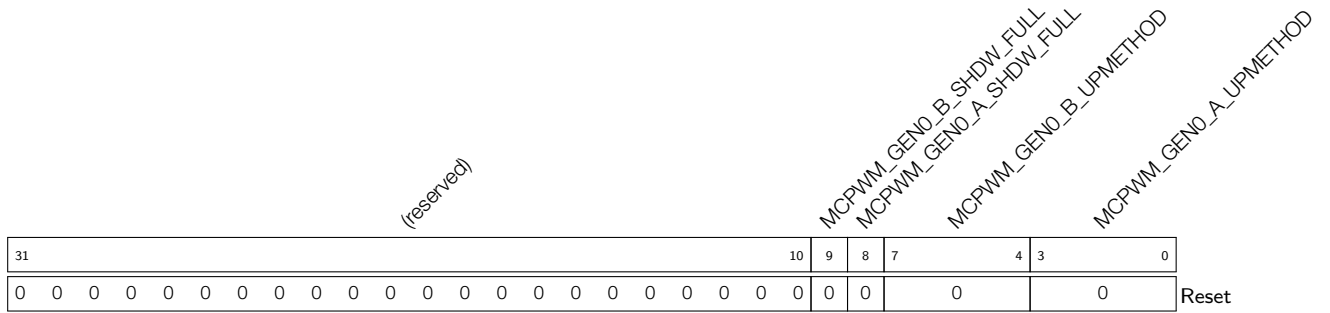

MCPWM_GEN0_A_UPMETHOD Update method for PWM generator 0 time stamp A's active register. When all bits are set to 0: immediately; when bit0 is set to 1: TEZ; when bit1 is set to 1: TEP; when bit2 is set to 1: sync; when bit3 is set to 1: disable the update. (R/W)

MCPWM_GEN0_B_UPMETHOD Update method for PWM generator 0 time stamp B's active register. When all bits are set to 0: immediately; when bit0 is set to 1: TEZ; when bit1 is set to 1: TEP; when bit2 is set to 1: sync; when bit3 is set to 1: disable the update. (R/W)

MCPWM_GEN0_A_SHDW_FULL Set and reset by hardware. If set, PWM generator 0 time stamp A's shadow reg is filled and waiting to be transferred to A's active reg; if cleared, A's active reg has been updated with shadow register latest value. (R/WTC/SC)

MCPWM_GEN0_B_SHDW_FULL Set and reset by hardware. If set, PWM generator 0 time stamp B's shadow reg is filled and waiting to be transferred to B's active reg; if cleared, B's active reg has been updated with shadow register latest value. (R/WTC/SC)

Register 36.17. MCPWM_GEN0_TSTMP_A_REG (0x0040)

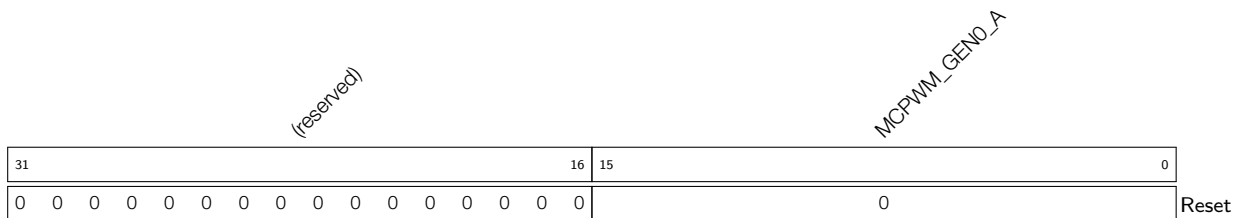

MCPWM_GEN0_A PWM generator 0 time stamp A's shadow register. (R/W)

Register 36.18. MCPWM_GEN0_TSTMP_B_REG (0x0044)

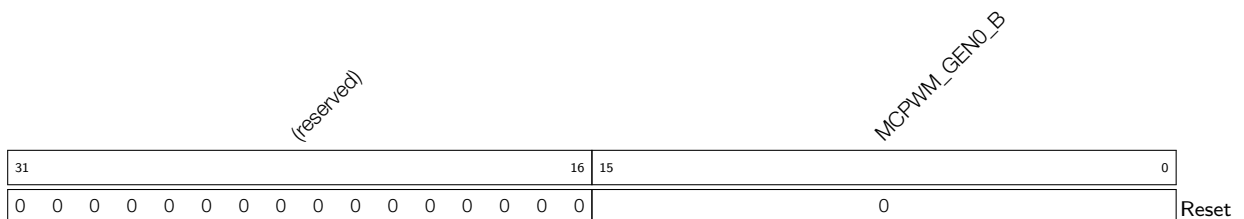

MCPWM_GEN0_B PWM generator 0 time stamp B's shadow register. (R/W)

Register 36.19. MCPWM_GEN0_CFG0_REG (0x0048)

(reserved)										MCPWM_GEN0_T1_SEL		MCPWM_GEN0_T0_SEL		MCPWM_GEN0_CFG_UPMETHOD			
31											10	9	7	6	4	3	0
0 0										0		0		0		Reset	

MCPWM_GEN0_CFG_UPMETHOD Update method for PWM generator 0's active register of configuration. When all bits are set to 0: immediately; when bit0 is set to 1: TEZ; when bit1 is set to 1:TEP; when bit2 is set to 1:sync; when bit3 is set to 1:disable the update. (R/W)

MCPWM_GEN0_T0_SEL Source selection for PWM generator 0 event_t0, take effect immediately, 0: fault_event0, 1: fault_event1, 2: fault_event2, 3: sync_taken, 4: none. (R/W)

MCPWM_GEN0_T1_SEL Source selection for PWM generator 0 event_t1, take effect immediately, 0: fault_event0, 1: fault_event1, 2: fault_event2, 3: sync_taken, 4: none. (R/W)

Register 36.20. MCPWM_GEN0_FORCE_REG (0x004C)

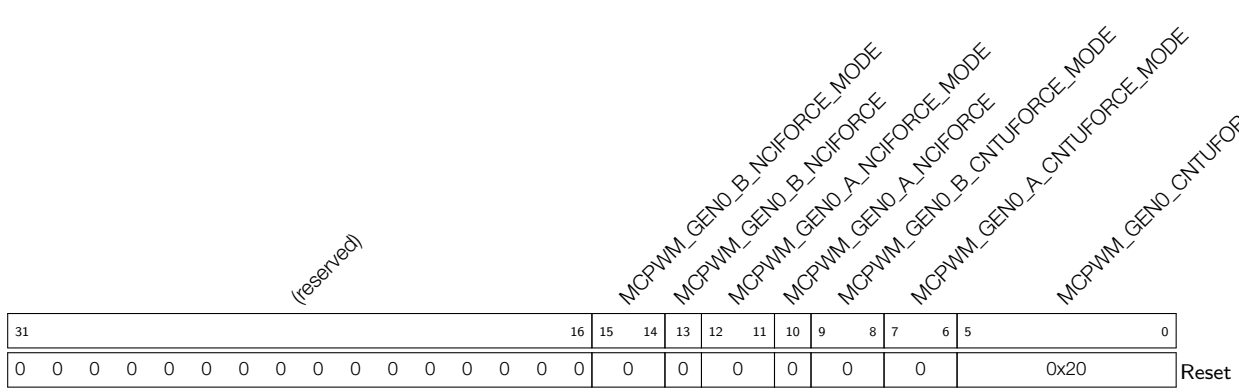

MCPWM_GEN0_CNTUFORCE_UPMETHOD Updating method for continuous software force of PWM generator0. When all bits are set to 0: immediately; when bit0 is set to 1: TEZ; when bit1 is set to 1: TEP; when bit2 is set to 1: TEA; when bit3 is set to 1: TEB; when bit4 is set to 1: sync; when bit5 is set to 1: disable update. (TEA/B here and below means an event generated when the timer’s value equals to that of register A/B.) (R/W)

MCPWM_GEN0_A_CNTUFORCE_MODE Continuous software force mode for PWM0A. 0: disabled, 1: low, 2: high, 3: disabled. (R/W)

MCPWM_GEN0_B_CNTUFORCE_MODE Continuous software force mode for PWM0B. 0: disabled, 1: low, 2: high, 3: disabled. (R/W)

MCPWM_GEN0_A_NCIFORCE Trigger of non-continuous immediate software-force event for PWM0A, a toggle will trigger a force event. (R/W)

MCPWM_GEN0_A_NCIFORCE_MODE Non-continuous immediate software force mode for PWM0A. 0: disabled, 1: low, 2: high, 3: disabled. (R/W)

MCPWM_GEN0_B_NCIFORCE Trigger of non-continuous immediate software-force event for PWM0B, a toggle will trigger a force event. (R/W)

MCPWM_GEN0_B_NCIFORCE_MODE Non-continuous immediate software force mode for PWM0B. 0: disabled, 1: low, 2: high, 3: disabled. (R/W)

Register 36.21. MCPWM_GEN0_A_REG (0x0050)

(reserved)								MCPWM_GEN0_A_DT1	MCPWM_GEN0_A_DT0	MCPWM_GEN0_A_DTEB	MCPWM_GEN0_A_DTEA	MCPWM_GEN0_A_DTEP	MCPWM_GEN0_A_DTEZ	MCPWM_GEN0_A_UT1	MCPWM_GEN0_A_UT0	MCPWM_GEN0_A_UTEB	MCPWM_GEN0_A_UTEA	MCPWM_GEN0_A_UTEP	MCPWM_GEN0_A_UTEZ						
31	24	23	22	21	20	19	18	17	16	15	14	13	12	11	10	9	8	7	6	5	4	3	2	1	0
0	0	0	0	0	0	0	0	0	0	0	0	0	0	0	0	0	0	0	0	0	0	0	0	0	0

Reset

MCPWM_GEN0_A_UTEZ Action on PWM0A triggered by event TEZ when timer increasing. 0: no change, 1: low, 2: high, 3: toggle. (R/W)

MCPWM_GEN0_A_UTEP Action on PWM0A triggered by event TEP when timer increasing. 0: no change, 1: low, 2: high, 3: toggle. (R/W)

MCPWM_GEN0_A_UTEA Action on PWM0A triggered by event TEA when timer increasing. 0: no change, 1: low, 2: high, 3: toggle. (R/W)

MCPWM_GEN0_A_UTEB Action on PWM0A triggered by event TEB when timer increasing. 0: no change, 1: low, 2: high, 3: toggle. (R/W)

MCPWM_GEN0_A_UT0 Action on PWM0A triggered by event_t0 when timer increasing. 0: no change, 1: low, 2: high, 3: toggle. (R/W)

MCPWM_GEN0_A_UT1 Action on PWM0A triggered by event_t1 when timer increasing. 0: no change, 1: low, 2: high, 3: toggle. (R/W)

MCPWM_GEN0_A_DTEZ Action on PWM0A triggered by event TEZ when timer decreasing. 0: no change, 1: low, 2: high, 3: toggle. (R/W)

MCPWM_GEN0_A_DTEP Action on PWM0A triggered by event TEP when timer decreasing. 0: no change, 1: low, 2: high, 3: toggle. (R/W)

MCPWM_GEN0_A_DTEA Action on PWM0A triggered by event TEA when timer decreasing. 0: no change, 1: low, 2: high, 3: toggle. (R/W)

MCPWM_GEN0_A_DTEB Action on PWM0A triggered by event TEB when timer decreasing. 0: no change, 1: low, 2: high, 3: toggle. (R/W)

MCPWM_GEN0_A_DT0 Action on PWM0A triggered by event_t0 when timer decreasing. 0: no change, 1: low, 2: high, 3: toggle. (R/W)

MCPWM_GEN0_A_DT1 Action on PWM0A triggered by event_t1 when timer decreasing. 0: no change, 1: low, 2: high, 3: toggle. (R/W)

Register 36.22. MCPWM_GEN0_B_REG (0x0054)

(reserved)								MCPWM_GEN0_B_DT1	MCPWM_GEN0_B_DT0	MCPWM_GEN0_B_DTEB	MCPWM_GEN0_B_DTEA	MCPWM_GEN0_B_DTEP	MCPWM_GEN0_B_DTEZ	MCPWM_GEN0_B_UT1	MCPWM_GEN0_B_UT0	MCPWM_GEN0_B_UTEA	MCPWM_GEN0_B_UTEB	MCPWM_GEN0_B_UTEA	MCPWM_GEN0_B_UTEZ							
31	24	23	22	21	20	19	18	17	16	15	14	13	12	11	10	9	8	7	6	5	4	3	2	1	0	Reset
0	0	0	0	0	0	0	0	0	0	0	0	0	0	0	0	0	0	0	0	0	0	0	0	0	0	0

MCPWM_GEN0_B_UTEZ Action on PWM0B triggered by event TEZ when timer increasing. 0: no change, 1: low, 2: high, 3: toggle. (R/W)

MCPWM_GEN0_B_UTEA Action on PWM0B triggered by event TEA when timer increasing. 0: no change, 1: low, 2: high, 3: toggle. (R/W)

MCPWM_GEN0_B_UTEB Action on PWM0B triggered by event TEB when timer increasing. 0: no change, 1: low, 2: high, 3: toggle. (R/W)

MCPWM_GEN0_B_UT0 Action on PWM0B triggered by event_t0 when timer increasing. 0: no change, 1: low, 2: high, 3: toggle. (R/W)

MCPWM_GEN0_B_UT1 Action on PWM0B triggered by event_t1 when timer increasing. 0: no change, 1: low, 2: high, 3: toggle. (R/W)

MCPWM_GEN0_B_DTEZ Action on PWM0B triggered by event TEZ when timer decreasing. 0: no change, 1: low, 2: high, 3: toggle. (R/W)

MCPWM_GEN0_B_DTEA Action on PWM0B triggered by event TEA when timer decreasing. 0: no change, 1: low, 2: high, 3: toggle. (R/W)

MCPWM_GEN0_B_DTEB Action on PWM0B triggered by event TEB when timer decreasing. 0: no change, 1: low, 2: high, 3: toggle. (R/W)

MCPWM_GEN0_B_DT0 Action on PWM0B triggered by event_t0 when timer decreasing. 0: no change, 1: low, 2: high, 3: toggle. (R/W)

MCPWM_GEN0_B_DT1 Action on PWM0B triggered by event_t1 when timer decreasing. 0: no change, 1: low, 2: high, 3: toggle. (R/W)

Register 36.25. MCPWM_DT0_RED_CFG_REG (0x0060)

(reserved)																MCPWM_DT0_RED															
31															16	15														0	
0																0															Reset

MCPWM_DT0_RED Shadow register for RED. (R/W)

Register 36.26. MCPWM_CARRIER0_CFG_REG (0x0064)

(reserved)																MCPWM_CARRIER0_IN_INVERT	MCPWM_CARRIER0_OUT_INVERT	MCPWM_CARRIER0_OSHTWTH	MCPWM_CARRIER0_DUTY	MCPWM_CARRIER0_PRESCALE	MCPWM_CARRIER0_EN											
31															14	13	12	11			8	7			5	4			1	0	Reset	
0																0	0	0		0		0		0		0	0	0		0	0	

MCPWM_CARRIER0_EN When set, carrier0 function is enabled. When cleared, carrier0 is bypassed. (R/W)

MCPWM_CARRIER0_PRESCALE PWM carrier0 clock (PC_clk) prescale value. Period of PC_clk = period of PWM_clk * (PWM_CARRIER0_PRESCALE + 1). (R/W)

MCPWM_CARRIER0_DUTY Carrier duty selection. Duty = PWM_CARRIER0_DUTY / 8. (R/W)

MCPWM_CARRIER0_OSHTWTH Width of the first pulse in number of periods of the carrier. (R/W)

MCPWM_CARRIER0_OUT_INVERT When set, invert the output of PWM0A and PWM0B for this submodule. (R/W)

MCPWM_CARRIER0_IN_INVERT When set, invert the input of PWM0A and PWM0B for this submodule. (R/W)

Register 36.27. MCPWM_FH0_CFG0_REG (0x0068)

(reserved)	MCPWM_FH0_B_OST_U	MCPWM_FH0_B_OST_D	MCPWM_FH0_B_CBC_U	MCPWM_FH0_B_CBC_D	MCPWM_FH0_A_OST_U	MCPWM_FH0_A_OST_D	MCPWM_FH0_A_CBC_U	MCPWM_FH0_A_CBC_D	MCPWM_FH0_F0_OST	MCPWM_FH0_F1_OST	MCPWM_FH0_F2_OST	MCPWM_FH0_SW_OST	MCPWM_FH0_F0_CBC	MCPWM_FH0_F1_CBC	MCPWM_FH0_F2_CBC	MCPWM_FH0_SW_CBC										
31	24	23	22	21	20	19	18	17	16	15	14	13	12	11	10	9	8	7	6	5	4	3	2	1	0	
0	0	0	0	0	0	0	0	0	0	0	0	0	0	0	0	0	0	0	0	0	0	0	0	0	0	0

Reset

MCPWM_FH0_SW_CBC Enable register for software force cycle-by-cycle mode action. 0: disable, 1: enable. (R/W)

MCPWM_FH0_F2_CBC event_f2 will trigger cycle-by-cycle mode action. 0: disable, 1: enable. (R/W)

MCPWM_FH0_F1_CBC event_f1 will trigger cycle-by-cycle mode action. 0: disable, 1: enable. (R/W)

MCPWM_FH0_F0_CBC event_f0 will trigger cycle-by-cycle mode action. 0: disable, 1: enable. (R/W)

MCPWM_FH0_SW_OST Enable register for software force one-shot mode action. 0: disable, 1: enable. (R/W)

MCPWM_FH0_F2_OST event_f2 will trigger one-shot mode action. 0: disable, 1: enable. (R/W)

MCPWM_FH0_F1_OST event_f1 will trigger one-shot mode action. 0: disable, 1: enable. (R/W)

MCPWM_FH0_F0_OST event_f0 will trigger one-shot mode action. 0: disable, 1: enable. (R/W)

MCPWM_FH0_A_CBC_D Cycle-by-cycle mode action on PWM0A when fault event occurs and timer is decreasing. 0: do nothing, 1: force low, 2: force high, 3: toggle. (R/W)

MCPWM_FH0_A_CBC_U Cycle-by-cycle mode action on PWM0A when fault event occurs and timer is increasing. 0: do nothing, 1: force low, 2: force high, 3: toggle. (R/W)

MCPWM_FH0_A_OST_D One-shot mode action on PWM0A when fault event occurs and timer is decreasing. 0: do nothing, 1: force low, 2: force high, 3: toggle. (R/W)

MCPWM_FH0_A_OST_U One-shot mode action on PWM0A when fault event occurs and timer is increasing. 0: do nothing, 1: force low, 2: force high, 3: toggle. (R/W)

MCPWM_FH0_B_CBC_D Cycle-by-cycle mode action on PWM0B when fault event occurs and timer is decreasing. 0: do nothing, 1: force low, 2: force high, 3: toggle. (R/W)

MCPWM_FH0_B_CBC_U Cycle-by-cycle mode action on PWM0B when fault event occurs and timer is increasing. 0: do nothing, 1: force low, 2: force high, 3: toggle. (R/W)

MCPWM_FH0_B_OST_D One-shot mode action on PWM0B when fault event occurs and timer is decreasing. 0: do nothing, 1: force low, 2: force high, 3: toggle. (R/W)

MCPWM_FH0_B_OST_U One-shot mode action on PWM0B when fault event occurs and timer is increasing. 0: do nothing, 1: force low, 2: force high, 3: toggle. (R/W)

Register 36.28. MCPWM_FH0_CFG1_REG (0x006C)

(reserved)																				MCPWM_FH0_FORCE_OST MCPWM_FH0_FORCE_CBC MCPWM_FH0_CBCPULSE MCPWM_FH0_CLR_OST					
31																			5	4	3	2	1	0	
0 0 0 0 0 0 0 0 0 0 0 0 0 0 0 0 0 0 0 0																		0	0	0	0	0	0	Reset	

- MCPWM_FH0_CLR_OST** A rising edge will clear on going one-shot mode action. (R/W)
- MCPWM_FH0_CBCPULSE** Cycle-by-cycle mode action refresh moment selection. When bit0 is set to 1: TEZ; when bit1 is set to 1: TEP. (R/W)
- MCPWM_FH0_FORCE_CBC** A toggle triggers a cycle-by-cycle mode action. (R/W)
- MCPWM_FH0_FORCE_OST** A toggle (software negate its value) triggers a one-shot mode action. (R/W)

Register 36.29. MCPWM_FH0_STATUS_REG (0x0070)

(reserved)																				MCPWM_FH0_OST_ON MCPWM_FH0_CBC_ON		
31																			2	1	0	
0 0 0 0 0 0 0 0 0 0 0 0 0 0 0 0 0 0 0 0																		0	0	0	Reset	

- MCPWM_FH0_CBC_ON** Set and reset by hardware. If set, a cycle-by-cycle mode action is on-going. (RO)
- MCPWM_FH0_OST_ON** Set and reset by hardware. If set, an one-shot mode action is on-going. (RO)

Register 36.33. MCPWM_GEN1_CFG0_REG (0x0080)

(reserved)										MCPWM_GEN1_T1_SEL		MCPWM_GEN1_T0_SEL		MCPWM_GEN1_CFG_UPMETHOD				
31											10	9	7	6	4	3	0	
0	0	0	0	0	0	0	0	0	0	0	0	0	0	0	0	0	0	Reset

MCPWM_GEN1_CFG_UPMETHOD Update method for PWM generator 1's active register of configuration. When all bits are set to 0: immediately; when bit0 is set to 1: TEZ; when bit1 is set to 1:sync; when bit3 is set to 1:disable the update. (R/W)

MCPWM_GEN1_T0_SEL Source selection for PWM generator 1 event_t0, take effect immediately, 0: fault_event0, 1: fault_event1, 2: fault_event2, 3: sync_taken, 4: none. (R/W)

MCPWM_GEN1_T1_SEL Source selection for PWM generator 1 event_t1, take effect immediately, 0: fault_event0, 1: fault_event1, 2: fault_event2, 3: sync_taken, 4: none. (R/W)

Register 36.34. MCPWM_GEN1_FORCE_REG (0x0084)

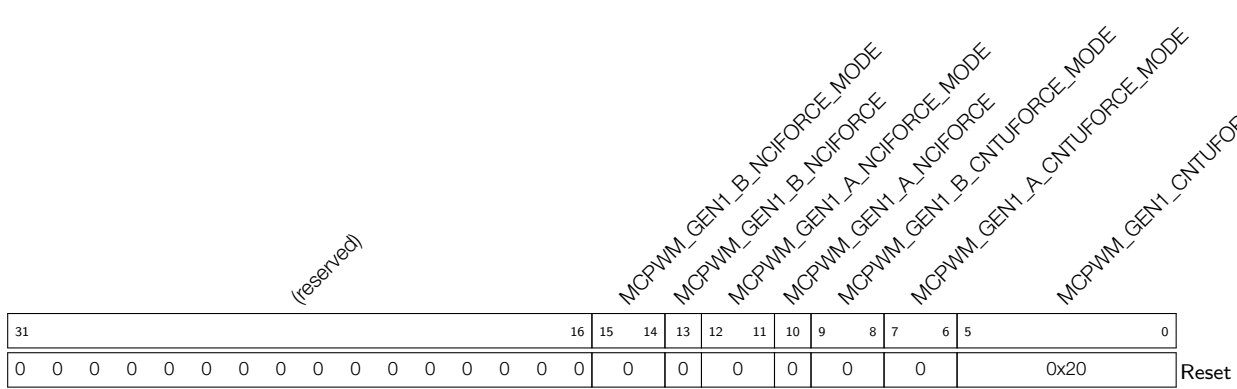

MCPWM_GEN1_CNTUFORCE_UPMETHOD Updating method for continuous software force of PWM generator 1. When all bits are set to 0: immediately; when bit0 is set to 1: TEZ; when bit1 is set to 1: TEP; when bit2 is set to 1: TEA; when bit3 is set to 1: TEB; when bit4 is set to 1: sync; when bit5 is set to 1: disable update. (TEA/B here and below means an event generated when the timer’s value equals to that of register A/B.) (R/W)

MCPWM_GEN1_A_CNTUFORCE_MODE Continuous software force mode for PWM1A. 0: disabled, 1: low, 2: high, 3: disabled. (R/W)

MCPWM_GEN1_B_CNTUFORCE_MODE Continuous software force mode for PWM1B. 0: disabled, 1: low, 2: high, 3: disabled. (R/W)

MCPWM_GEN1_A_NCIFORCE Trigger of non-continuous immediate software-force event for PWM1A, a toggle will trigger a force event. (R/W)

MCPWM_GEN1_A_NCIFORCE_MODE Non-continuous immediate software force mode for PWM1A. 0: disabled, 1: low, 2: high, 3: disabled. (R/W)

MCPWM_GEN1_B_NCIFORCE Trigger of non-continuous immediate software-force event for PWM1B, a toggle will trigger a force event. (R/W)

MCPWM_GEN1_B_NCIFORCE_MODE Non-continuous immediate software force mode for PWM1B. 0: disabled, 1: low, 2: high, 3: disabled. (R/W)

Register 36.35. MCPWM_GEN1_A_REG (0x0088)

(reserved)								MCPWM_GEN1_A_DT1	MCPWM_GEN1_A_DT0	MCPWM_GEN1_A_DTEB	MCPWM_GEN1_A_DTEA	MCPWM_GEN1_A_DTEP	MCPWM_GEN1_A_DTEZ	MCPWM_GEN1_A_UT1	MCPWM_GEN1_A_UT0	MCPWM_GEN1_A_UTEB	MCPWM_GEN1_A_UTEA	MCPWM_GEN1_A_UTEZ								
31	24	23	22	21	20	19	18	17	16	15	14	13	12	11	10	9	8	7	6	5	4	3	2	1	0	
0	0	0	0	0	0	0	0	0	0	0	0	0	0	0	0	0	0	0	0	0	0	0	0	0	0	Reset

MCPWM_GEN1_A_UTEZ Action on PWM1A triggered by event TEZ when timer increasing. 0: no change, 1: low, 2: high, 3: toggle. (R/W)

MCPWM_GEN1_A_UTEA Action on PWM1A triggered by event TEA when timer increasing. 0: no change, 1: low, 2: high, 3: toggle. (R/W)

MCPWM_GEN1_A_UTEB Action on PWM1A triggered by event TEB when timer increasing. 0: no change, 1: low, 2: high, 3: toggle. (R/W)

MCPWM_GEN1_A_UT0 Action on PWM1A triggered by event_t0 when timer increasing. 0: no change, 1: low, 2: high, 3: toggle. (R/W)

MCPWM_GEN1_A_UT1 Action on PWM1A triggered by event_t1 when timer increasing. 0: no change, 1: low, 2: high, 3: toggle. (R/W)

MCPWM_GEN1_A_DTEZ Action on PWM1A triggered by event TEZ when timer decreasing. 0: no change, 1: low, 2: high, 3: toggle. (R/W)

MCPWM_GEN1_A_DTEA Action on PWM1A triggered by event TEA when timer decreasing. 0: no change, 1: low, 2: high, 3: toggle. (R/W)

MCPWM_GEN1_A_DTEB Action on PWM1A triggered by event TEB when timer decreasing. 0: no change, 1: low, 2: high, 3: toggle. (R/W)

MCPWM_GEN1_A_DT0 Action on PWM1A triggered by event_t0 when timer decreasing. 0: no change, 1: low, 2: high, 3: toggle. (R/W)

MCPWM_GEN1_A_DT1 Action on PWM1A triggered by event_t1 when timer decreasing. 0: no change, 1: low, 2: high, 3: toggle. (R/W)

Register 36.36. MCPWM_GEN1_B_REG (0x008C)

(reserved)								MCPWM_GEN1_B_DT1		MCPWM_GEN1_B_DT0		MCPWM_GEN1_B_DTEB		MCPWM_GEN1_B_DTEA		MCPWM_GEN1_B_DTEP		MCPWM_GEN1_B_DTEZ		MCPWM_GEN1_B_UT1		MCPWM_GEN1_B_UT0		MCPWM_GEN1_B_UTEB		MCPWM_GEN1_B_UTEA		MCPWM_GEN1_B_UTEZ					
31								24	23	22	21	20	19	18	17	16	15	14	13	12	11	10	9	8	7	6	5	4	3	2	1	0	
0	0	0	0	0	0	0	0	0	0	0	0	0	0	0	0	0	0	0	0	0	0	0	0	0	0	0	0	0	0	0	0	0	0

Reset

MCPWM_GEN1_B_UTEZ Action on PWM1B triggered by event TEZ when timer increasing. 0: no change, 1: low, 2: high, 3: toggle. (R/W)

MCPWM_GEN1_B_UTEA Action on PWM1B triggered by event TEA when timer increasing. 0: no change, 1: low, 2: high, 3: toggle. (R/W)

MCPWM_GEN1_B_UTEB Action on PWM1B triggered by event TEB when timer increasing. 0: no change, 1: low, 2: high, 3: toggle. (R/W)

MCPWM_GEN1_B_UT0 Action on PWM1B triggered by event_t0 when timer increasing. 0: no change, 1: low, 2: high, 3: toggle. (R/W)

MCPWM_GEN1_B_UT1 Action on PWM1B triggered by event_t1 when timer increasing. 0: no change, 1: low, 2: high, 3: toggle. (R/W)

MCPWM_GEN1_B_DTEZ Action on PWM1B triggered by event TEZ when timer decreasing. 0: no change, 1: low, 2: high, 3: toggle. (R/W)

MCPWM_GEN1_B_DTEA Action on PWM1B triggered by event TEA when timer decreasing. 0: no change, 1: low, 2: high, 3: toggle. (R/W)

MCPWM_GEN1_B_DTEB Action on PWM1B triggered by event TEB when timer decreasing. 0: no change, 1: low, 2: high, 3: toggle. (R/W)

MCPWM_GEN1_B_DT0 Action on PWM1B triggered by event_t0 when timer decreasing. 0: no change, 1: low, 2: high, 3: toggle. (R/W)

MCPWM_GEN1_B_DT1 Action on PWM1B triggered by event_t1 when timer decreasing. 0: no change, 1: low, 2: high, 3: toggle. (R/W)

Register 36.37. MCPWM_DT1_CFG_REG (0x0090)

(reserved)																		MCPWM_DT1_CLK_SEL	MCPWM_DT1_B_OUTBYPASS	MCPWM_DT1_A_OUTBYPASS	MCPWM_DT1_FED_OUTINVERT	MCPWM_DT1_RED_OUTINVERT	MCPWM_DT1_FED_INSEL	MCPWM_DT1_RED_INSEL	MCPWM_DT1_B_OUTSWAP	MCPWM_DT1_A_OUTSWAP	MCPWM_DT1_DEB_MODE	MCPWM_DT1_RED_UPMETHOD	MCPWM_DT1_FED_UPMETHOD																												
31																			18	17	16	15	14	13	12	11	10	9	8	7									4	3	0																
0																		0	0	1	1	0	0	0	0	0	0	0	0	0	0	0	0	0	0	0	0	0	0	0	0	0	0	0	0	0	0	0	0	0	0	0	0	0	0	0	Reset

MCPWM_DT1_FED_UPMETHOD Update method for FED (falling edge delay) active register. 0: immediate; when bit0 is set to 1: tez; when bit1 is set to 1: tep; when bit2 is set to 1: sync; when bit3 is set to 1: disable the update. (R/W)

MCPWM_DT1_RED_UPMETHOD Update method for RED (rising edge delay) active register. 0: immediate; when bit0 is set to 1: tez; when bit1 is set to 1: tep; when bit2 is set to 1: sync; when bit3 is set to 1: disable the update. (R/W)

MCPWM_DT1_DEB_MODE S8 in table 36-5, dual-edge B mode. 0: fed/red take effect on different path separately; 1: fed/red take effect on B path, A out is in bypass or dulpB mode. (R/W)

MCPWM_DT1_A_OUTSWAP S6 in table 36-5. (R/W)

MCPWM_DT1_B_OUTSWAP S7 in table 36-5. (R/W)

MCPWM_DT1_RED_INSEL S4 in table 36-5. (R/W)

MCPWM_DT1_FED_INSEL S5 in table 36-5. (R/W)

MCPWM_DT1_RED_OUTINVERT S2 in table 36-5. (R/W)

MCPWM_DT1_FED_OUTINVERT S3 in table 36-5. (R/W)

MCPWM_DT1_A_OUTBYPASS S1 in table 36-5. (R/W)

MCPWM_DT1_B_OUTBYPASS S0 in table 36-5. (R/W)

MCPWM_DT1_CLK_SEL Dead time generator 1 clock selection. 0: PWM_clk, 1: PT_clk. (R/W)

Register 36.38. MCPWM_DT1_FED_CFG_REG (0x0094)

(reserved)																MCPWM_DT1_FED																				
31																	16	15	0																	
0																0	0	0	0	0	0	0	0	0	0	0	0	0	0	0	0	0	0	0	0	Reset

MCPWM_DT1_FED Shadow register for FED. (R/W)

Register 36.39. MCPWM_DT1_RED_CFG_REG (0x0098)

(reserved)																MCPWM_DT1_RED															
31															16	15														0	
0																0															Reset

MCPWM_DT1_RED Shadow register for RED. (R/W)

Register 36.40. MCPWM_CARRIER1_CFG_REG (0x009C)

(reserved)																MCPWM_CARRIER1_IN_INVERT	MCPWM_CARRIER1_OUT_INVERT	MCPWM_CARRIER1_OSHTWTH	MCPWM_CARRIER1_DUTY	MCPWM_CARRIER1_PRESCALE	MCPWM_CARRIER1_EN													
31															14	13	12	11			8	7			5	4			1	0	Reset			
0																0	0	0		0		0		0		0		0	0	0		0	0	

MCPWM_CARRIER1_EN When set, carrier1 function is enabled. When cleared, carrier1 is bypassed. (R/W)

MCPWM_CARRIER1_PRESCALE PWM carrier1 clock (PC_clk) prescale value. Period of PC_clk = period of PWM_clk * (PWM_CARRIER0_PRESCALE + 1). (R/W)

MCPWM_CARRIER1_DUTY Carrier duty selection. Duty = PWM_CARRIER0_DUTY / 8. (R/W)

MCPWM_CARRIER1_OSHTWTH Width of the first pulse in number of periods of the carrier. (R/W)

MCPWM_CARRIER1_OUT_INVERT When set, invert the output of PWM1A and PWM1B for this submodule. (R/W)

MCPWM_CARRIER1_IN_INVERT When set, invert the input of PWM1A and PWM1B for this submodule. (R/W)

Register 36.41. MCPWM_FH1_CFG0_REG (0x00A0)

(reserved)								MCPWM_FH1_B_OST_U	MCPWM_FH1_B_OST_D	MCPWM_FH1_B_CBC_U	MCPWM_FH1_B_CBC_D	MCPWM_FH1_A_OST_U	MCPWM_FH1_A_OST_D	MCPWM_FH1_A_CBC_U	MCPWM_FH1_A_CBC_D	MCPWM_FH1_F0_OST	MCPWM_FH1_F1_OST	MCPWM_FH1_F2_OST	MCPWM_FH1_SW_OST	MCPWM_FH1_F0_CBC	MCPWM_FH1_F1_CBC	MCPWM_FH1_F2_CBC	MCPWM_FH1_SW_CBC				
31	24	23	22	21	20	19	18	17	16	15	14	13	12	11	10	9	8	7	6	5	4	3	2	1	0	Reset	
0	0	0	0	0	0	0	0	0	0	0	0	0	0	0	0	0	0	0	0	0	0	0	0	0	0	0	0

MCPWM_FH1_SW_CBC Enable register for software force cycle-by-cycle mode action. 0: disable, 1: enable. (R/W)

MCPWM_FH1_F2_CBC event_f2 will trigger cycle-by-cycle mode action. 0: disable, 1: enable. (R/W)

MCPWM_FH1_F1_CBC event_f1 will trigger cycle-by-cycle mode action. 0: disable, 1: enable. (R/W)

MCPWM_FH1_F0_CBC event_f0 will trigger cycle-by-cycle mode action. 0: disable, 1: enable. (R/W)

MCPWM_FH1_SW_OST Enable register for software force one-shot mode action. 0: disable, 1: enable. (R/W)

MCPWM_FH1_F2_OST event_f2 will trigger one-shot mode action. 0: disable, 1: enable. (R/W)

MCPWM_FH1_F1_OST event_f1 will trigger one-shot mode action. 0: disable, 1: enable. (R/W)

MCPWM_FH1_F0_OST event_f0 will trigger one-shot mode action. 0: disable, 1: enable. (R/W)

MCPWM_FH1_A_CBC_D Cycle-by-cycle mode action on PWM1A when fault event occurs and timer is decreasing. 0: do nothing, 1: force low, 2: force high, 3: toggle. (R/W)

MCPWM_FH1_A_CBC_U Cycle-by-cycle mode action on PWM1A when fault event occurs and timer is increasing. 0: do nothing, 1: force low, 2: force high, 3: toggle. (R/W)

MCPWM_FH1_A_OST_D One-shot mode action on PWM1A when fault event occurs and timer is decreasing. 0: do nothing, 1: force low, 2: force high, 3: toggle. (R/W)

MCPWM_FH1_A_OST_U One-shot mode action on PWM1A when fault event occurs and timer is increasing. 0: do nothing, 1: force low, 2: force high, 3: toggle. (R/W)

MCPWM_FH1_B_CBC_D Cycle-by-cycle mode action on PWM1B when fault event occurs and timer is decreasing. 0: do nothing, 1: force low, 2: force high, 3: toggle. (R/W)

MCPWM_FH1_B_CBC_U Cycle-by-cycle mode action on PWM1B when fault event occurs and timer is increasing. 0: do nothing, 1: force low, 2: force high, 3: toggle. (R/W)

MCPWM_FH1_B_OST_D One-shot mode action on PWM1B when fault event occurs and timer is decreasing. 0: do nothing, 1: force low, 2: force high, 3: toggle. (R/W)

MCPWM_FH1_B_OST_U One-shot mode action on PWM1B when fault event occurs and timer is increasing. 0: do nothing, 1: force low, 2: force high, 3: toggle. (R/W)

Register 36.42. MCPWM_FH1_CFG1_REG (0x00A4)

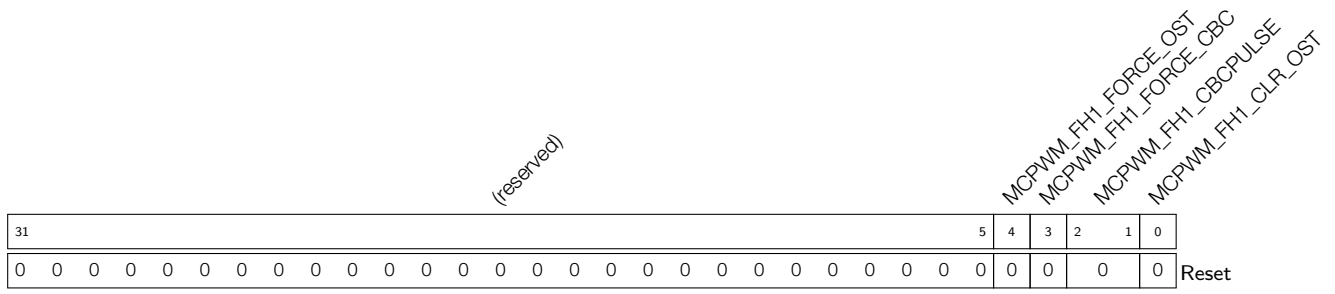

MCPWM_FH1_CLR_OST A rising edge will clear on going one-shot mode action. (R/W)

MCPWM_FH1_CBCPULSE Cycle-by-cycle mode action refresh moment selection. When all bits are 0: refresh disabled; when bit0 is set to 1: TEZ; when bit1 is set to 1: TEP; when all bits are 1: TEZ/TEP. (R/W)

MCPWM_FH1_FORCE_CBC A toggle triggers a cycle-by-cycle mode action. (R/W)

MCPWM_FH1_FORCE_OST A toggle (software negate its value) triggers a one-shot mode action. (R/W)

Register 36.43. MCPWM_FH1_STATUS_REG (0x00A8)

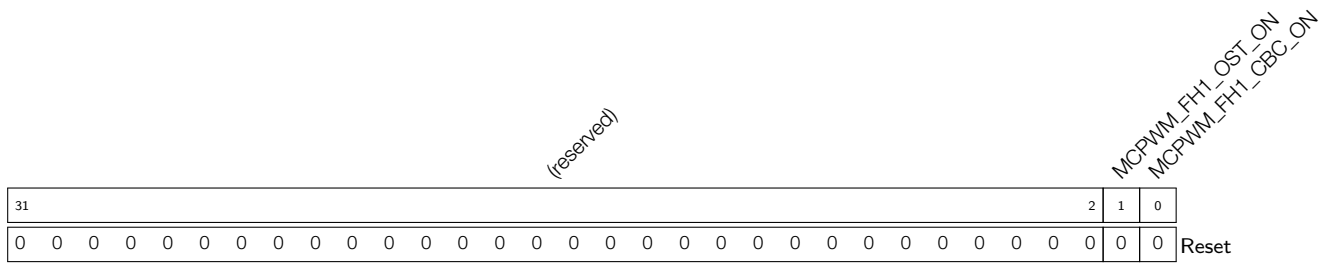

MCPWM_FH1_CBC_ON Set and reset by hardware. If set, a cycle-by-cycle mode action is on-going. (RO)

MCPWM_FH1_OST_ON Set and reset by hardware. If set, an one-shot mode action is on-going. (RO)

Register 36.44. MCPWM_FH2_STATUS_REG (0x00E0)

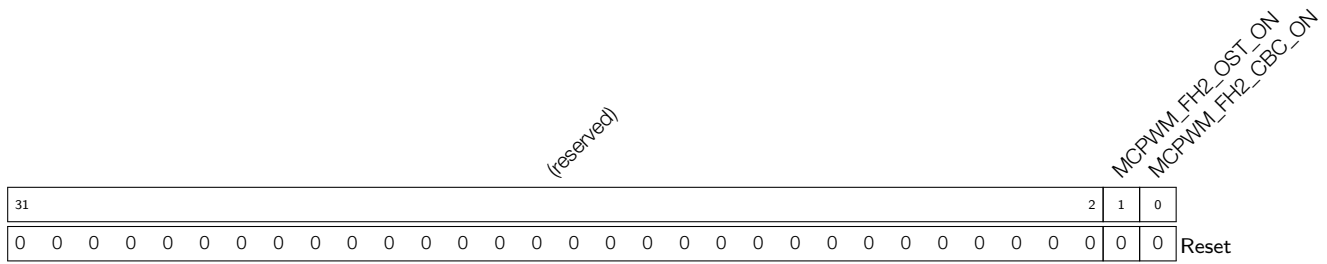

MCPWM_FH2_CBC_ON Set and reset by hardware. If set, a cycle-by-cycle mode action is on-going. (RO)

MCPWM_FH2_OST_ON Set and reset by hardware. If set, an one-shot mode action is on-going. (RO)

Register 36.45. MCPWM_GEN2_STMP_CFG_REG (0x00AC)

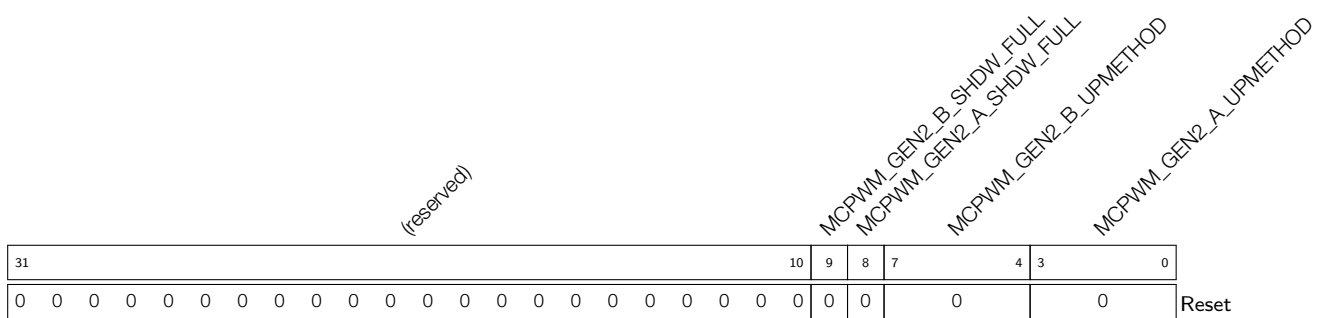

MCPWM_GEN2_A_UPMETHOD Update method for PWM generator 2 time stamp A's active register. When all bits are set to 0: immediately; when bit0 is set to 1: TEZ; when bit1 is set to 1: TEP; when bit2 is set to 1: sync; when bit3 is set to 1: disable the update. (R/W)

MCPWM_GEN2_B_UPMETHOD Update method for PWM generator 2 time stamp B's active register. When all bits are set to 0: immediately; when bit0 is set to 1: TEZ; when bit1 is set to 1: TEP; when bit2 is set to 1: sync; when bit3 is set to 1: disable the update. (R/W)

MCPWM_GEN2_A_SHDW_FULL Set and reset by hardware. If set, PWM generator 2 time stamp A's shadow reg is filled and waiting to be transferred to A's active reg. If cleared, A's active reg has been updated with shadow register latest value. (R/WTC/SC)

MCPWM_GEN2_B_SHDW_FULL Set and reset by hardware. If set, PWM generator 2 time stamp B's shadow reg is filled and waiting to be transferred to B's active reg. If cleared, B's active reg has been updated with shadow register latest value. (R/WTC/SC)

Register 36.46. MCPWM_GEN2_STMP_A_REG (0x00B0)

(reserved)																MCPWM_GEN2_A																	
31																16	15																0
0																0																Reset	

MCPWM_GEN2_A PWM generator 2 time stamp A's shadow register. (R/W)

Register 36.47. MCPWM_GEN2_STMP_B_REG (0x00B4)

(reserved)																MCPWM_GEN2_B																	
31																16	15																0
0																0																Reset	

MCPWM_GEN2_B PWM generator 2 time stamp B's shadow register. (R/W)

Register 36.48. MCPWM_GEN2_CFG0_REG (0x00B8)

(reserved)																MCPWM_GEN2_T1_SEL				MCPWM_GEN2_T0_SEL				MCPWM_GEN2_CFG_UPMETHOD				
31																10	9	7	6	4	3				0			
0																0				0				0				Reset

MCPWM_GEN2_CFG_UPMETHOD Update method for PWM generator 2's active register of configuration. 0: immediately; when bit0 is set to 1: TEZ; when bit1 is set to 1: sync; when bit3 is set to 1: disable the update. (R/W)

MCPWM_GEN2_T0_SEL Source selection for PWM generator 2 event_t0, take effect immediately, 0: fault_event0, 1: fault_event1, 2: fault_event2, 3: sync_taken, 4: none. (R/W)

MCPWM_GEN2_T1_SEL Source selection for PWM generator 2 event_t1, take effect immediately, 0: fault_event0, 1: fault_event1, 2: fault_event2, 3: sync_taken, 4: none. (R/W)

Register 36.49. MCPWM_GEN2_FORCE_REG (0x00BC)

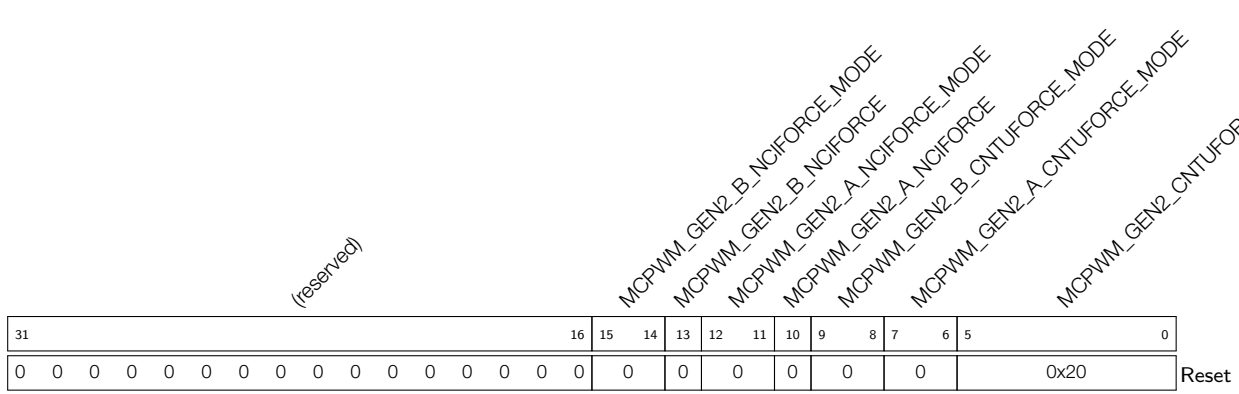

MCPWM_GEN2_CNTUFORCE_UPMETHOD Updating method for continuous software force of PWM generator 2. When all bits are set to 0: immediately; when bit0 is set to 1: TEZ; when bit1 is set to 1: TEP; when bit2 is set to 1: TEA; when bit3 is set to 1: TEB; when bit4 is set to 1: sync; when bit5 is set to 1: disable update. (TEA/B here and below means an event generated when the timer’s value equals to that of register A/B.) (R/W)

MCPWM_GEN2_A_CNTUFORCE_MODE Continuous software force mode for PWM2A. 0: disabled, 1: low, 2: high, 3: disabled. (R/W)

MCPWM_GEN2_B_CNTUFORCE_MODE Continuous software force mode for PWM2B. 0: disabled, 1: low, 2: high, 3: disabled. (R/W)

MCPWM_GEN2_A_NCIFORCE Trigger of non-continuous immediate software-force event for PWM2A, a toggle will trigger a force event. (R/W)

MCPWM_GEN2_A_NCIFORCE_MODE Non-continuous immediate software force mode for PWM2A, 0: disabled, 1: low, 2: high, 3: disabled. (R/W)

MCPWM_GEN2_B_NCIFORCE Trigger of non-continuous immediate software-force event for PWM2B, a toggle will trigger a force event. (R/W)

MCPWM_GEN2_B_NCIFORCE_MODE Non-continuous immediate software force mode for PWM2B. 0: disabled, 1: low, 2: high, 3: disabled. (R/W)

Register 36.50. MCPWM_GEN2_A_REG (0x00C0)

(reserved)								MCPWM_GEN2_A_DT1	MCPWM_GEN2_A_DT0	MCPWM_GEN2_A_DTEB	MCPWM_GEN2_A_DTEA	MCPWM_GEN2_A_DTEP	MCPWM_GEN2_A_DTEZ	MCPWM_GEN2_A_UT1	MCPWM_GEN2_A_UT0	MCPWM_GEN2_A_UTEB	MCPWM_GEN2_A_UTEA	MCPWM_GEN2_A_UTEP	MCPWM_GEN2_A_UTEZ							
31	24	23	22	21	20	19	18	17	16	15	14	13	12	11	10	9	8	7	6	5	4	3	2	1	0	Reset
0	0	0	0	0	0	0	0	0	0	0	0	0	0	0	0	0	0	0	0	0	0	0	0	0	0	0

MCPWM_GEN2_A_UTEZ Action on PWM2A triggered by event TEZ when timer increasing. 0: no change, 1: low, 2: high, 3: toggle. (R/W)

MCPWM_GEN2_A_UTEP Action on PWM2A triggered by event TEP when timer increasing. 0: no change, 1: low, 2: high, 3: toggle. (R/W)

MCPWM_GEN2_A_UTEA Action on PWM2A triggered by event TEA when timer increasing. 0: no change, 1: low, 2: high, 3: toggle. (R/W)

MCPWM_GEN2_A_UTEB Action on PWM2A triggered by event TEB when timer increasing. 0: no change, 1: low, 2: high, 3: toggle. (R/W)

MCPWM_GEN2_A_UT0 Action on PWM2A triggered by event_t0 when timer increasing. 0: no change, 1: low, 2: high, 3: toggle. (R/W)

MCPWM_GEN2_A_UT1 Action on PWM2A triggered by event_t1 when timer increasing. 0: no change, 1: low, 2: high, 3: toggle. (R/W)

MCPWM_GEN2_A_DTEZ Action on PWM2A triggered by event TEZ when timer decreasing. 0: no change, 1: low, 2: high, 3: toggle. (R/W)

MCPWM_GEN2_A_DTEP Action on PWM2A triggered by event TEP when timer decreasing. 0: no change, 1: low, 2: high, 3: toggle. (R/W)

MCPWM_GEN2_A_DTEA Action on PWM2A triggered by event TEA when timer decreasing. 0: no change, 1: low, 2: high, 3: toggle. (R/W)

MCPWM_GEN2_A_DTEB Action on PWM2A triggered by event TEB when timer decreasing. 0: no change, 1: low, 2: high, 3: toggle. (R/W)

MCPWM_GEN2_A_DT0 Action on PWM2A triggered by event_t0 when timer decreasing. 0: no change, 1: low, 2: high, 3: toggle. (R/W)

MCPWM_GEN2_A_DT1 Action on PWM2A triggered by event_t1 when timer decreasing. 0: no change, 1: low, 2: high, 3: toggle. (R/W)

Register 36.51. MCPWM_GEN2_B_REG (0x00C4)

(reserved)								MCPWM_GEN2_B_DT1		MCPWM_GEN2_B_DT0		MCPWM_GEN2_B_DTEB		MCPWM_GEN2_B_DTEA		MCPWM_GEN2_B_DTEP		MCPWM_GEN2_B_DTEZ		MCPWM_GEN2_B_UT1		MCPWM_GEN2_B_UT0		MCPWM_GEN2_B_UTEA		MCPWM_GEN2_B_UTEB		MCPWM_GEN2_B_UTEA		MCPWM_GEN2_B_UTEZ			
31								24	23	22	21	20	19	18	17	16	15	14	13	12	11	10	9	8	7	6	5	4	3	2	1	0	
0	0	0	0	0	0	0	0	0	0	0	0	0	0	0	0	0	0	0	0	0	0	0	0	0	0	0	0	0	0	0	0	0	0

Reset

MCPWM_GEN2_B_UTEZ Action on PWM2B triggered by event TEZ when timer increasing. 0: no change, 1: low, 2: high, 3: toggle. (R/W)

MCPWM_GEN2_B_UTEA Action on PWM2B triggered by event TEA when timer increasing. 0: no change, 1: low, 2: high, 3: toggle. (R/W)

MCPWM_GEN2_B_UTEB Action on PWM2B triggered by event TEB when timer increasing. 0: no change, 1: low, 2: high, 3: toggle. (R/W)

MCPWM_GEN2_B_UT0 Action on PWM2B triggered by event_t0 when timer increasing. 0: no change, 1: low, 2: high, 3: toggle. (R/W)

MCPWM_GEN2_B_UT1 Action on PWM2B triggered by event_t1 when timer increasing. 0: no change, 1: low, 2: high, 3: toggle. (R/W)

MCPWM_GEN2_B_DTEZ Action on PWM2B triggered by event TEZ when timer decreasing. 0: no change, 1: low, 2: high, 3: toggle. (R/W)

MCPWM_GEN2_B_DTEA Action on PWM2B triggered by event TEA when timer decreasing. 0: no change, 1: low, 2: high, 3: toggle. (R/W)

MCPWM_GEN2_B_DTEB Action on PWM2B triggered by event TEB when timer decreasing. 0: no change, 1: low, 2: high, 3: toggle. (R/W)

MCPWM_GEN2_B_DT0 Action on PWM2B triggered by event_t0 when timer decreasing. 0: no change, 1: low, 2: high, 3: toggle. (R/W)

MCPWM_GEN2_B_DT1 Action on PWM2B triggered by event_t1 when timer decreasing. 0: no change, 1: low, 2: high, 3: toggle. (R/W)

Register 36.52. MCPWM_DT2_CFG_REG (0x00C8)

(reserved)																		MCPWM_DT2_CLK_SEL	MCPWM_DT2_B_OUTBYPASS	MCPWM_DT2_A_OUTBYPASS	MCPWM_DT2_FED_OUTINVERT	MCPWM_DT2_RED_OUTINVERT	MCPWM_DT2_FED_INSEL	MCPWM_DT2_RED_INSEL	MCPWM_DT2_B_OUTSWAP	MCPWM_DT2_A_OUTSWAP	MCPWM_DT2_DEB_MODE	MCPWM_DT2_RED_UPMETHOD	MCPWM_DT2_FED_UPMETHOD																												
31																			18	17	16	15	14	13	12	11	10	9	8	7									4	3	0																
0																		0	0	1	1	0	0	0	0	0	0	0	0	0	0	0	0	0	0	0	0	0	0	0	0	0	0	0	0	0	0	0	0	0	0	0	0	0	0	0	Reset

MCPWM_DT2_FED_UPMETHOD Update method for FED (falling edge delay) active register. 0: immediate; when bit0 is set to 1: tez; when bit1 is set to 1: tep; when bit2 is set to 1: sync; when bit3 is set to 1: disable the update. (R/W)

MCPWM_DT2_RED_UPMETHOD Update method for RED (rising edge delay) active register. 0: immediate; when bit0 is set to 1: tez; when bit1 is set to 1: tep; when bit2 is set to 1: sync; when bit3 is set to 1: disable the update. (R/W)

MCPWM_DT2_DEB_MODE S8 in table 36-5, dual-edge B mode. 0: fed/red take effect on different path separately; 1: fed/red take effect on B path, A out is in bypass or dulpB mode. (R/W)

MCPWM_DT2_A_OUTSWAP S6 in table 36-5. (R/W)

MCPWM_DT2_B_OUTSWAP S7 in table 36-5. (R/W)

MCPWM_DT2_RED_INSEL S4 in table 36-5. (R/W)

MCPWM_DT2_FED_INSEL S5 in table 36-5. (R/W)

MCPWM_DT2_RED_OUTINVERT S2 in table 36-5. (R/W)

MCPWM_DT2_FED_OUTINVERT S3 in table 36-5. (R/W)

MCPWM_DT2_A_OUTBYPASS S1 in table 36-5. (R/W)

MCPWM_DT2_B_OUTBYPASS S0 in table 36-5. (R/W)

MCPWM_DT2_CLK_SEL Dead time generator 2 clock selection. 0: PWM_clk, 1: PT_clk. (R/W)

Register 36.53. MCPWM_DT2_FED_CFG_REG (0x00CC)

(reserved)																MCPWM_DT2_FED																				
31																	16	15	0																	
0																0	0	0	0	0	0	0	0	0	0	0	0	0	0	0	0	0	0	0	0	Reset

MCPWM_DT2_FED Shadow register for FED. (R/W)

Register 36.54. MCPWM_DT2_RED_CFG_REG (0x00D0)

(reserved)																MCPWM_DT2_RED															
31															16	15														0	
0																0															Reset

MCPWM_DT2_RED Shadow register for RED. (R/W)

Register 36.55. MCPWM_CARRIER2_CFG_REG (0x00D4)

(reserved)														MCPWM_CARRIER2_IN_INVERT	MCPWM_CARRIER2_OUT_INVERT	MCPWM_CARRIER2_OSHTWTH	MCPWM_CARRIER2_DUTY	MCPWM_CARRIER2_PRESCALE	MCPWM_CARRIER2_EN													
31														14	13	12	11			8	7			5	4			1	0	Reset		
0														0	0	0		0	0	0		0	0	0		0	0	0		0	0	

MCPWM_CARRIER2_EN When set, carrier2 function is enabled. When cleared, carrier2 is bypassed. (R/W)

MCPWM_CARRIER2_PRESCALE PWM carrier2 clock (PC_clk) prescale value. Period of PC_clk = period of PWM_clk * (PWM_CARRIER0_PRESCALE + 1). (R/W)

MCPWM_CARRIER2_DUTY Carrier duty selection. Duty = PWM_CARRIER0_DUTY / 8. (R/W)

MCPWM_CARRIER2_OSHTWTH Width of the first pulse in number of periods of the carrier. (R/W)

MCPWM_CARRIER2_OUT_INVERT When set, invert the output of PWM2A and PWM2B for this submodule. (R/W)

MCPWM_CARRIER2_IN_INVERT When set, invert the input of PWM2A and PWM2B for this submodule. (R/W)

Register 36.56. MCPWM_FH2_CFG0_REG (0x00D8)

(reserved)								MCPWM_FH2_B_OST_U		MCPWM_FH2_B_OST_D		MCPWM_FH2_B_CBC_U		MCPWM_FH2_B_CBC_D		MCPWM_FH2_A_OST_U		MCPWM_FH2_A_OST_D		MCPWM_FH2_A_CBC_U		MCPWM_FH2_A_CBC_D		MCPWM_FH2_F0_OST		MCPWM_FH2_F1_OST		MCPWM_FH2_F2_OST		MCPWM_FH2_SW_OST		MCPWM_FH2_F0_CBC		MCPWM_FH2_F1_CBC		MCPWM_FH2_F2_CBC		MCPWM_FH2_SW_CBC		
31								24	23	22	21	20	19	18	17	16	15	14	13	12	11	10	9	8	7	6	5	4	3	2	1	0								
0	0	0	0	0	0	0	0	0	0	0	0	0	0	0	0	0	0	0	0	0	0	0	0	0	0	0	0	0	0	0	0	0	0	0	0	0	0	0	0	Reset

MCPWM_FH2_SW_CBC Enable register for software force cycle-by-cycle mode action. 0: disable, 1: enable. (R/W)

MCPWM_FH2_F2_CBC event_f2 will trigger cycle-by-cycle mode action. 0: disable, 1: enable. (R/W)

MCPWM_FH2_F1_CBC event_f1 will trigger cycle-by-cycle mode action. 0: disable, 1: enable. (R/W)

MCPWM_FH2_F0_CBC event_f0 will trigger cycle-by-cycle mode action. 0: disable, 1: enable. (R/W)

MCPWM_FH2_SW_OST Enable register for software force one-shot mode action. 0: disable, 1: enable. (R/W)

MCPWM_FH2_F2_OST event_f2 will trigger one-shot mode action. 0: disable, 1: enable. (R/W)

MCPWM_FH2_F1_OST event_f1 will trigger one-shot mode action. 0: disable, 1: enable. (R/W)

MCPWM_FH2_F0_OST event_f0 will trigger one-shot mode action. 0: disable, 1: enable. (R/W)

MCPWM_FH2_A_CBC_D Cycle-by-cycle mode action on PWM2A when fault event occurs and timer is decreasing. 0: do nothing, 1: force low, 2: force high, 3: toggle. (R/W)

MCPWM_FH2_A_CBC_U Cycle-by-cycle mode action on PWM2A when fault event occurs and timer is increasing. 0: do nothing, 1: force low, 2: force high, 3: toggle. (R/W)

MCPWM_FH2_A_OST_D One-shot mode action on PWM2A when fault event occurs and timer is decreasing. 0: do nothing, 1: force low, 2: force high, 3: toggle. (R/W)

MCPWM_FH2_A_OST_U One-shot mode action on PWM2A when fault event occurs and timer is increasing. 0: do nothing, 1: force low, 2: force high, 3: toggle. (R/W)

MCPWM_FH2_B_CBC_D Cycle-by-cycle mode action on PWM2B when fault event occurs and timer is decreasing. 0: do nothing, 1: force low, 2: force high, 3: toggle. (R/W)

MCPWM_FH2_B_CBC_U Cycle-by-cycle mode action on PWM2B when fault event occurs and timer is increasing. 0: do nothing, 1: force low, 2: force high, 3: toggle. (R/W)

MCPWM_FH2_B_OST_D One-shot mode action on PWM2B when fault event occurs and timer is decreasing. 0: do nothing, 1: force low, 2: force high, 3: toggle. (R/W)

MCPWM_FH2_B_OST_U One-shot mode action on PWM2B when fault event occurs and timer is increasing. 0: do nothing, 1: force low, 2: force high, 3: toggle. (R/W)

Register 36.57. MCPWM_FH2_CFG1_REG (0x00DC)

(reserved)																MCPWM_FH2_FORCE_OST MCPWM_FH2_FORCE_CBC MCPWM_FH2_CBCPULSE MCPWM_FH2_CLR_OST						
31																5	4	3	2	1	0	Reset
0																0	0	0	0	0	0	

- MCPWM_FH2_CLR_OST** A rising edge will clear on going one-shot mode action. (R/W)
- MCPWM_FH2_CBCPULSE** Cycle-by-cycle mode action refresh moment selection. When bit0 is set to 1: TEZ; when bit1 is set to 1: TEP. (R/W)
- MCPWM_FH2_FORCE_CBC** A toggle triggers a cycle-by-cycle mode action. (R/W)
- MCPWM_FH2_FORCE_OST** A toggle (software negate its value) triggers a one-shot mode action. (R/W)

Register 36.58. MCPWM_FAULT_DETECT_REG (0x00E4)

(reserved)																MCPWM_EVENT_F2 MCPWM_EVENT_F1 MCPWM_EVENT_F0 MCPWM_F2_POLE MCPWM_F1_POLE MCPWM_F0_POLE MCPWM_F2_EN MCPWM_F1_EN MCPWM_F0_EN										
31																9	8	7	6	5	4	3	2	1	0	Reset
0																0	0	0	0	0	0	0	0	0	0	

- MCPWM_F0_EN** When set, event_f0 generation is enabled. (R/W)
- MCPWM_F1_EN** When set, event_f1 generation is enabled. (R/W)
- MCPWM_F2_EN** When set, event_f2 generation is enabled. (R/W)
- MCPWM_F0_POLE** Set event_f0 trigger polarity on FAULT0 source from GPIO matrix. 0: level low, 1: level high. (R/W)
- MCPWM_F1_POLE** Set event_f1 trigger polarity on FAULT1 source from GPIO matrix. 0: level low, 1: level high. (R/W)
- MCPWM_F2_POLE** Set event_f2 trigger polarity on FAULT2 source from GPIO matrix. 0: level low, 1: level high. (R/W)
- MCPWM_EVENT_F0** Set and reset by hardware. If set, event_f0 is on going. (RO)
- MCPWM_EVENT_F1** Set and reset by hardware. If set, event_f1 is on going. (RO)
- MCPWM_EVENT_F2** Set and reset by hardware. If set, event_f2 is on going. (RO)

Register 36.59. MCPWM_CAP_TIMER_CFG_REG (0x00E8)

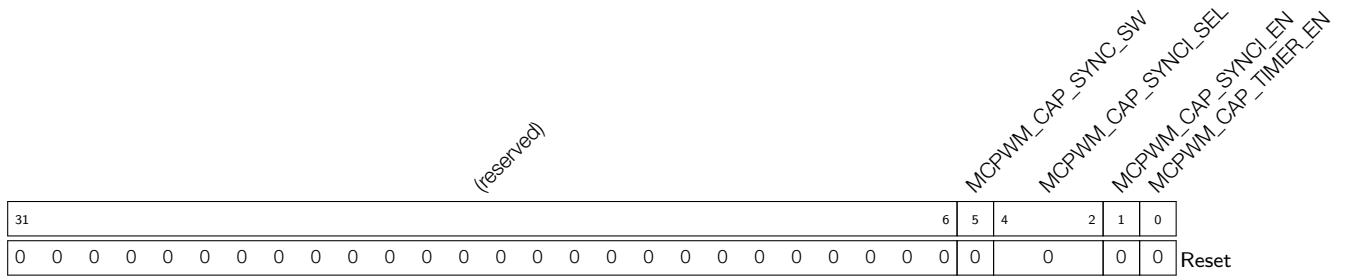

MCPWM_CAP_TIMER_EN When set, capture timer incrementing under APB_clk is enabled. (R/W)

MCPWM_CAP_SYNCI_EN When set, capture timer sync is enabled. (R/W)

MCPWM_CAP_SYNCI_SEL Capture module sync input selection. 0: none, 1: timer0 sync_out, 2: timer1 sync_out, 3: timer2 sync_out, 4: SYNC0 from GPIO matrix, 5: SYNC1 from GPIO matrix, 6: SYNC2 from GPIO matrix. (R/W)

MCPWM_CAP_SYNC_SW When reg_cap_synci_en is 1, write 1 will trigger a capture timer sync, capture timer is loaded with value in phase register. (WT)

Register 36.60. MCPWM_CAP_TIMER_PHASE_REG (0x00EC)

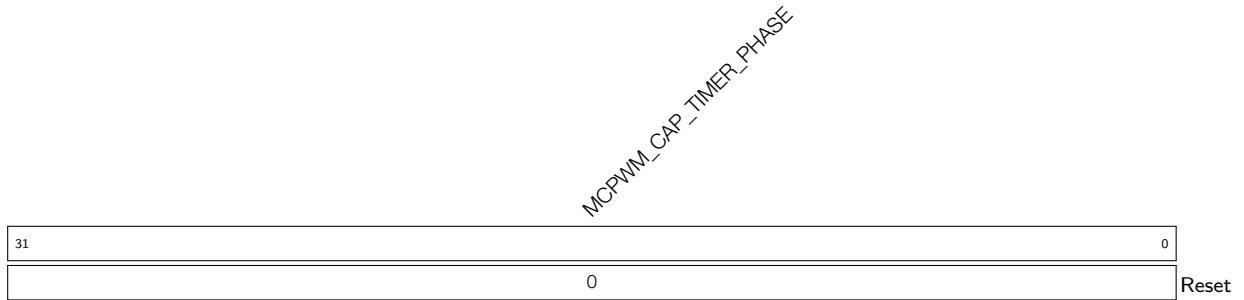

MCPWM_CAP_TIMER_PHASE Phase value for capture timer sync operation. (R/W)

Register 36.63. MCPWM_CAP_CH2_CFG_REG (0x00F8)

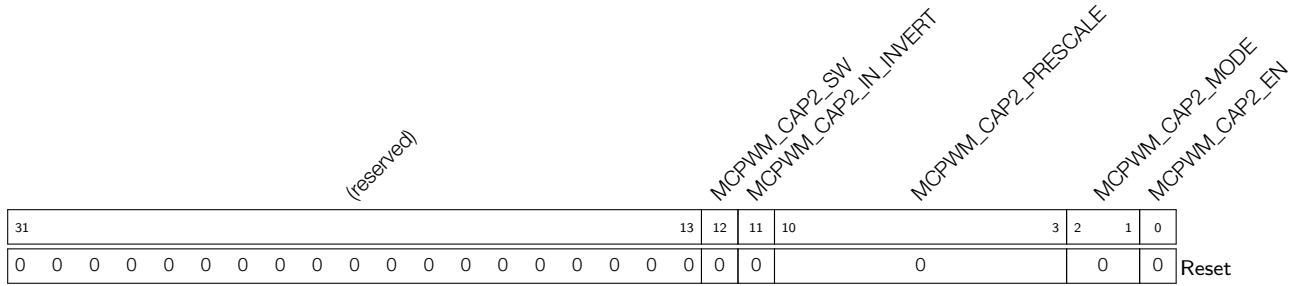

MCPWM_CAP2_EN When set, capture on channel 2 is enabled. (R/W)

MCPWM_CAP2_MODE Edge of capture on channel 2 after prescaling. When bit0 is set to 1: enable capture on the falling edge, When bit1 is set to 1: enable capture on the rising edge. (R/W)

MCPWM_CAP2_PRESCALE Value of prescaling on rising edge of CAP2. Prescale value = PWM_CAP2_PRESCALE + 1. (R/W)

MCPWM_CAP2_IN_INVERT When set, CAP2 form GPIO matrix is inverted before prescale. (R/W)

MCPWM_CAP2_SW Write 1 will trigger a software forced capture on channel 2. (WT)

Register 36.64. MCPWM_CAP_CH0_REG (0x00FC)

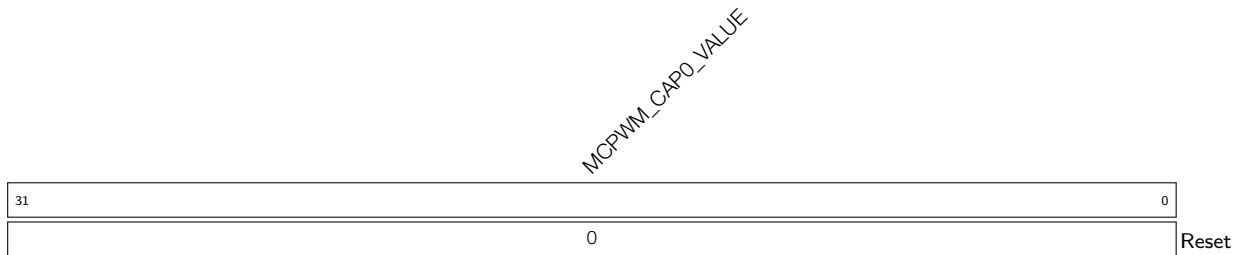

MCPWM_CAP0_VALUE Value of last capture on channel 0. (RO)

Register 36.65. MCPWM_CAP_CH1_REG (0x0100)

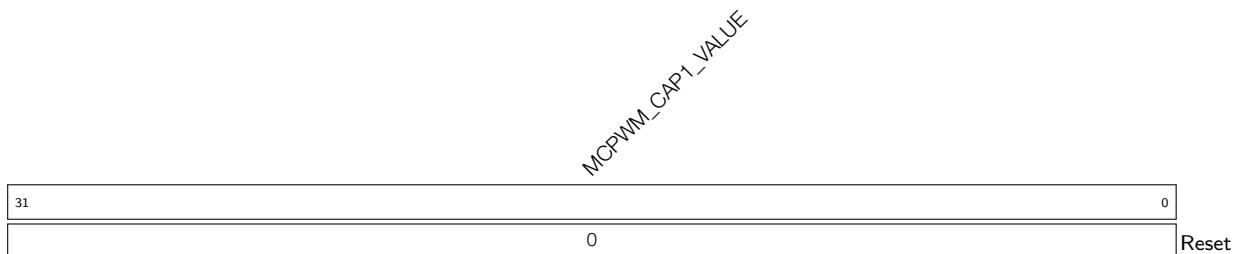

MCPWM_CAP1_VALUE Value of last capture on channel 1. (RO)

Register 36.66. MCPWM_CAP_CH2_REG (0x0104)

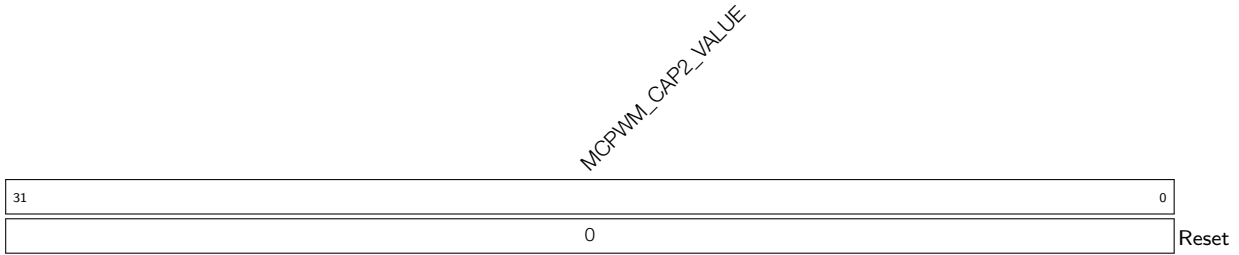

MCPWM_CAP2_VALUE Value of last capture on channel 2. (RO)

Register 36.67. MCPWM_CAP_STATUS_REG (0x0108)

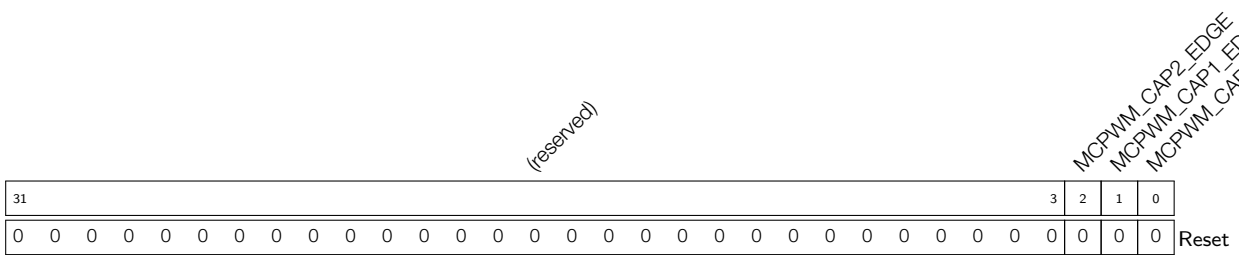

MCPWM_CAP0_EDGE Edge of last capture trigger on channel 0, 0: rising edge, 1: falling edge. (RO)

MCPWM_CAP1_EDGE Edge of last capture trigger on channel 1, 0: rising edge, 1: falling edge. (RO)

MCPWM_CAP2_EDGE Edge of last capture trigger on channel 2, 0: rising edge, 1: falling edge. (RO)

Register 36.68. MCPWM_UPDATE_CFG_REG (0x010C)

(reserved)																<div style="display: flex; justify-content: space-between;"> <div style="writing-mode: vertical-rl; transform: rotate(180deg);">MCPWM_OP2_FORCE_UP</div> <div style="writing-mode: vertical-rl; transform: rotate(180deg);">MCPWM_OP2_UP_EN</div> <div style="writing-mode: vertical-rl; transform: rotate(180deg);">MCPWM_OP1_FORCE_UP</div> <div style="writing-mode: vertical-rl; transform: rotate(180deg);">MCPWM_OP1_UP_EN</div> <div style="writing-mode: vertical-rl; transform: rotate(180deg);">MCPWM_OP0_FORCE_UP</div> <div style="writing-mode: vertical-rl; transform: rotate(180deg);">MCPWM_OP0_UP_EN</div> <div style="writing-mode: vertical-rl; transform: rotate(180deg);">MCPWM_GLOBAL_FORCE_UP</div> <div style="writing-mode: vertical-rl; transform: rotate(180deg);">MCPWM_GLOBAL_UP_EN</div> </div>										
31																8	7	6	5	4	3	2	1	0		
0																0	1	0	1	0	1	0	1	Reset		

MCPWM_GLOBAL_UP_EN The global enable of update of all active registers in MCPWM module. (R/W)

MCPWM_GLOBAL_FORCE_UP A toggle (software invert its value) will trigger a forced update of all active registers in MCPWM module. (R/W)

MCPWM_OP0_UP_EN When set and PWM_GLOBAL_UP_EN is set, update of active registers in PWM operator 0 are enabled. (R/W)

MCPWM_OP0_FORCE_UP A toggle (software invert its value) will trigger a forced update of active registers in PWM operator 0. (R/W)

MCPWM_OP1_UP_EN When set and PWM_GLOBAL_UP_EN is set, update of active registers in PWM operator 1 are enabled. (R/W)

MCPWM_OP1_FORCE_UP A toggle (software invert its value) will trigger a forced update of active registers in PWM operator 1. (R/W)

MCPWM_OP2_UP_EN When set and PWM_GLOBAL_UP_EN is set, update of active registers in PWM operator 2 are enabled. (R/W)

MCPWM_OP2_FORCE_UP A toggle (software invert its value) will trigger a forced update of active registers in PWM operator 2. (R/W)

Register 36.69. MCPWM_INT_ENA_REG (0x0110)

(reserved)	MCPWM_CAP2_INT_ENA	MCPWM_CAP1_INT_ENA	MCPWM_CAP0_INT_ENA	MCPWM_FH2_INT_ENA	MCPWM_FH1_INT_ENA	MCPWM_FH0_OST_INT_ENA	MCPWM_FH0_OST_INT_ENA	MCPWM_FH2_CBC_INT_ENA	MCPWM_FH1_CBC_INT_ENA	MCPWM_FH0_CBC_INT_ENA	MCPWM_OP2_TEB_INT_ENA	MCPWM_OP1_TEB_INT_ENA	MCPWM_OP0_TEB_INT_ENA	MCPWM_OP1_TEA_INT_ENA	MCPWM_OP0_TEA_INT_ENA	MCPWM_FAULT2_INT_ENA	MCPWM_FAULT1_INT_ENA	MCPWM_FAULT0_INT_ENA	MCPWM_TIMER2_INT_ENA	MCPWM_TIMER1_INT_ENA	MCPWM_TIMER0_INT_ENA	MCPWM_TIMER2_TEP_INT_ENA	MCPWM_TIMER1_TEP_INT_ENA	MCPWM_TIMER0_TEP_INT_ENA	MCPWM_TIMER2_TEZ_INT_ENA	MCPWM_TIMER1_TEZ_INT_ENA	MCPWM_TIMER0_TEZ_INT_ENA	MCPWM_TIMER2_STOP_INT_ENA	MCPWM_TIMER1_STOP_INT_ENA	MCPWM_TIMER0_STOP_INT_ENA		
31	30	29	28	27	26	25	24	23	22	21	20	19	18	17	16	15	14	13	12	11	10	9	8	7	6	5	4	3	2	1	0	
0	0	0	0	0	0	0	0	0	0	0	0	0	0	0	0	0	0	0	0	0	0	0	0	0	0	0	0	0	0	0	0	Reset

MCPWM_TIMER0_STOP_INT_ENA The enable bit for the interrupt triggered when the timer 0 stops. (R/W)

MCPWM_TIMER1_STOP_INT_ENA The enable bit for the interrupt triggered when the timer 1 stops. (R/W)

MCPWM_TIMER2_STOP_INT_ENA The enable bit for the interrupt triggered when the timer 2 stops. (R/W)

MCPWM_TIMER0_TEZ_INT_ENA The enable bit for the interrupt triggered by a PWM timer 0 TEZ event. (R/W)

MCPWM_TIMER1_TEZ_INT_ENA The enable bit for the interrupt triggered by a PWM timer 1 TEZ event. (R/W)

MCPWM_TIMER2_TEZ_INT_ENA The enable bit for the interrupt triggered by a PWM timer 2 TEZ event. (R/W)

MCPWM_TIMER0_TEP_INT_ENA The enable bit for the interrupt triggered by a PWM timer 0 TEP event. (R/W)

MCPWM_TIMER1_TEP_INT_ENA The enable bit for the interrupt triggered by a PWM timer 1 TEP event. (R/W)

MCPWM_TIMER2_TEP_INT_ENA The enable bit for the interrupt triggered by a PWM timer 2 TEP event. (R/W)

MCPWM_FAULT0_INT_ENA The enable bit for the interrupt triggered when event_f0 starts. (R/W)

MCPWM_FAULT1_INT_ENA The enable bit for the interrupt triggered when event_f1 starts. (R/W)

MCPWM_FAULT2_INT_ENA The enable bit for the interrupt triggered when event_f2 starts. (R/W)

MCPWM_FAULT0_CLR_INT_ENA The enable bit for the interrupt triggered when event_f0 ends. (R/W)

Continued on the next page...

Register 36.69. MCPWM_INT_ENA_REG (0x0110)

Continued from the previous page...

MCPWM_FAULT1_CLR_INT_ENA The enable bit for the interrupt triggered when event_f1 ends. (R/W)

MCPWM_FAULT2_CLR_INT_ENA The enable bit for the interrupt triggered when event_f2 ends. (R/W)

MCPWM_OP0_TEA_INT_ENA The enable bit for the interrupt triggered by a PWM operator 0 TEA event (R/W)

MCPWM_OP1_TEA_INT_ENA The enable bit for the interrupt triggered by a PWM operator 1 TEA event (R/W)

MCPWM_OP2_TEA_INT_ENA The enable bit for the interrupt triggered by a PWM operator 2 TEA event (R/W)

MCPWM_OP0_TEB_INT_ENA The enable bit for the interrupt triggered by a PWM operator 0 TEB event (R/W)

MCPWM_OP1_TEB_INT_ENA The enable bit for the interrupt triggered by a PWM operator 1 TEB event (R/W)

MCPWM_OP2_TEB_INT_ENA The enable bit for the interrupt triggered by a PWM operator 2 TEB event (R/W)

MCPWM_FH0_CBC_INT_ENA The enable bit for the interrupt triggered by a cycle-by-cycle mode action on PWM0. (R/W)

MCPWM_FH1_CBC_INT_ENA The enable bit for the interrupt triggered by a cycle-by-cycle mode action on PWM1. (R/W)

MCPWM_FH2_CBC_INT_ENA The enable bit for the interrupt triggered by a cycle-by-cycle mode action on PWM2. (R/W)

MCPWM_FH0_OST_INT_ENA The enable bit for the interrupt triggered by a one-shot mode action on PWM0. (R/W)

MCPWM_FH1_OST_INT_ENA The enable bit for the interrupt triggered by a one-shot mode action on PWM1. (R/W)

MCPWM_FH2_OST_INT_ENA The enable bit for the interrupt triggered by a one-shot mode action on PWM2. (R/W)

MCPWM_CAP0_INT_ENA The enable bit for the interrupt triggered by capture on channel 0. (R/W)

MCPWM_CAP1_INT_ENA The enable bit for the interrupt triggered by capture on channel 1. (R/W)

MCPWM_CAP2_INT_ENA The enable bit for the interrupt triggered by capture on channel 2. (R/W)

Register 36.70. MCPWM_INT_RAW_REG (0x0114)

Continued from the previous page...

MCPWM_FAULT1_CLR_INT_RAW The raw status bit for the interrupt triggered when event_f1 ends.
(R/WTC/SS)

MCPWM_FAULT2_CLR_INT_RAW The raw status bit for the interrupt triggered when event_f2 ends.
(R/WTC/SS)

MCPWM_OP0_TEA_INT_RAW The raw status bit for the interrupt triggered by a PWM operator 0
TEA event (R/WTC/SS)

MCPWM_OP1_TEA_INT_RAW The raw status bit for the interrupt triggered by a PWM operator 1
TEA event (R/WTC/SS)

MCPWM_OP2_TEA_INT_RAW The raw status bit for the interrupt triggered by a PWM operator 2
TEA event (R/WTC/SS)

MCPWM_OP0_TEB_INT_RAW The raw status bit for the interrupt triggered by a PWM operator 0
TEB event (R/WTC/SS)

MCPWM_OP1_TEB_INT_RAW The raw status bit for the interrupt triggered by a PWM operator 1
TEB event (R/WTC/SS)

MCPWM_OP2_TEB_INT_RAW The raw status bit for the interrupt triggered by a PWM operator 2
TEB event (R/WTC/SS)

MCPWM_FH0_CBC_INT_RAW The raw status bit for the interrupt triggered by a cycle-by-cycle
mode action on PWM0. (R/WTC/SS)

MCPWM_FH1_CBC_INT_RAW The raw status bit for the interrupt triggered by a cycle-by-cycle
mode action on PWM1. (R/WTC/SS)

MCPWM_FH2_CBC_INT_RAW The raw status bit for the interrupt triggered by a cycle-by-cycle
mode action on PWM2. (R/WTC/SS)

MCPWM_FH0_OST_INT_RAW The raw status bit for the interrupt triggered by a one-shot mode
action on PWM0. (R/WTC/SS)

MCPWM_FH1_OST_INT_RAW The raw status bit for the interrupt triggered by a one-shot mode
action on PWM1. (R/WTC/SS)

MCPWM_FH2_OST_INT_RAW The raw status bit for the interrupt triggered by a one-shot mode
action on PWM2. (R/WTC/SS)

MCPWM_CAP0_INT_RAW The raw status bit for the interrupt triggered by capture on channel 0.
(R/WTC/SS)

MCPWM_CAP1_INT_RAW The raw status bit for the interrupt triggered by capture on channel 1.
(R/WTC/SS)

MCPWM_CAP2_INT_RAW The raw status bit for the interrupt triggered by capture on channel 2.
(R/WTC/SS)

Register 36.71. MCPWM_INT_ST_REG (0x0118)

Continued from the previous page...

MCPWM_FAULT1_CLR_INT_ST The masked status bit for the interrupt triggered when event_f1 ends. (RO)

MCPWM_FAULT2_CLR_INT_ST The masked status bit for the interrupt triggered when event_f2 ends. (RO)

MCPWM_OP0_TEA_INT_ST The masked status bit for the interrupt triggered by a PWM operator 0 TEA event (RO)

MCPWM_OP1_TEA_INT_ST The masked status bit for the interrupt triggered by a PWM operator 1 TEA event (RO)

MCPWM_OP2_TEA_INT_ST The masked status bit for the interrupt triggered by a PWM operator 2 TEA event (RO)

MCPWM_OP0_TEB_INT_ST The masked status bit for the interrupt triggered by a PWM operator 0 TEB event (RO)

MCPWM_OP1_TEB_INT_ST The masked status bit for the interrupt triggered by a PWM operator 1 TEB event (RO)

MCPWM_OP2_TEB_INT_ST The masked status bit for the interrupt triggered by a PWM operator 2 TEB event (RO)

MCPWM_FH0_CBC_INT_ST The masked status bit for the interrupt triggered by a cycle-by-cycle mode action on PWM0. (RO)

MCPWM_FH1_CBC_INT_ST The masked status bit for the interrupt triggered by a cycle-by-cycle mode action on PWM1. (RO)

MCPWM_FH2_CBC_INT_ST The masked status bit for the interrupt triggered by a cycle-by-cycle mode action on PWM2. (RO)

MCPWM_FH0_OST_INT_ST The masked status bit for the interrupt triggered by a one-shot mode action on PWM0. (RO)

MCPWM_FH1_OST_INT_ST The masked status bit for the interrupt triggered by a one-shot mode action on PWM1. (RO)

MCPWM_FH2_OST_INT_ST The masked status bit for the interrupt triggered by a one-shot mode action on PWM2. (RO)

MCPWM_CAP0_INT_ST The masked status bit for the interrupt triggered by capture on channel 0. (RO)

MCPWM_CAP1_INT_ST The masked status bit for the interrupt triggered by capture on channel 1. (RO)

MCPWM_CAP2_INT_ST The masked status bit for the interrupt triggered by capture on channel 2. (RO)

Register 36.72. MCPWM_INT_CLR_REG (0x011C)

(reserved)	MCPWM_CAP2_INT_CLR	MCPWM_CAP1_INT_CLR	MCPWM_CAP0_INT_CLR	MCPWM_FH2_OST_CLR	MCPWM_FH1_OST_CLR	MCPWM_FH0_OST_CLR	MCPWM_FH2_CBC_CLR	MCPWM_FH1_CBC_CLR	MCPWM_FH0_CBC_CLR	MCPWM_OP2_TEB_INT_CLR	MCPWM_OP1_TEB_INT_CLR	MCPWM_Op0_TEB_INT_CLR	MCPWM_OP2_TEA_INT_CLR	MCPWM_OP1_TEA_INT_CLR	MCPWM_Op0_TEA_INT_CLR	MCPWM_FAULT2_CLR_INT_CLR	MCPWM_FAULT1_CLR_INT_CLR	MCPWM_FAULT0_CLR_INT_CLR	MCPWM_FAULT2_INT_CLR	MCPWM_FAULT1_INT_CLR	MCPWM_FAULT0_INT_CLR	MCPWM_TIMER2_TEP_INT_CLR	MCPWM_TIMER1_TEP_INT_CLR	MCPWM_TIMER0_TEP_INT_CLR	MCPWM_TIMER2_TEZ_INT_CLR	MCPWM_TIMER1_TEZ_INT_CLR	MCPWM_TIMER0_TEZ_INT_CLR	MCPWM_TIMER2_STOP_INT_CLR	MCPWM_TIMER1_STOP_INT_CLR	MCPWM_TIMER0_STOP_INT_CLR	
31	30	29	28	27	26	25	24	23	22	21	20	19	18	17	16	15	14	13	12	11	10	9	8	7	6	5	4	3	2	1	0
0	0	0	0	0	0	0	0	0	0	0	0	0	0	0	0	0	0	0	0	0	0	0	0	0	0	0	0	0	0	0	0

Reset

MCPWM_TIMER0_STOP_INT_CLR Set this bit to clear the interrupt triggered when the timer 0 stops. (WT)

MCPWM_TIMER1_STOP_INT_CLR Set this bit to clear the interrupt triggered when the timer 1 stops. (WT)

MCPWM_TIMER2_STOP_INT_CLR Set this bit to clear the interrupt triggered when the timer 2 stops. (WT)

MCPWM_TIMER0_TEZ_INT_CLR Set this bit to clear the interrupt triggered by a PWM timer 0 TEZ event. (WT)

MCPWM_TIMER1_TEZ_INT_CLR Set this bit to clear the interrupt triggered by a PWM timer 1 TEZ event. (WT)

MCPWM_TIMER2_TEZ_INT_CLR Set this bit to clear the interrupt triggered by a PWM timer 2 TEZ event. (WT)

MCPWM_TIMER0_TEP_INT_CLR Set this bit to clear the interrupt triggered by a PWM timer 0 TEP event. (WT)

MCPWM_TIMER1_TEP_INT_CLR Set this bit to clear the interrupt triggered by a PWM timer 1 TEP event. (WT)

MCPWM_TIMER2_TEP_INT_CLR Set this bit to clear the interrupt triggered by a PWM timer 2 TEP event. (WT)

MCPWM_FAULT0_INT_CLR Set this bit to clear the interrupt triggered when event_f0 starts. (WT)

MCPWM_FAULT1_INT_CLR Set this bit to clear the interrupt triggered when event_f1 starts. (WT)

MCPWM_FAULT2_INT_CLR Set this bit to clear the interrupt triggered when event_f2 starts. (WT)

Continued on the next page...

Register 36.72. MCPWM_INT_CLR_REG (0x011C)

Continued from the previous page...

MCPWM_FAULT0_CLR_INT_CLR Set this bit to clear the interrupt triggered when event_f0 ends. (WT)

MCPWM_FAULT1_CLR_INT_CLR Set this bit to clear the interrupt triggered when event_f1 ends. (WT)

MCPWM_FAULT2_CLR_INT_CLR Set this bit to clear the interrupt triggered when event_f2 ends. (WT)

MCPWM_OP0_TEA_INT_CLR Set this bit to clear the interrupt triggered by a PWM operator 0 TEA event (WT)

MCPWM_OP1_TEA_INT_CLR Set this bit to clear the interrupt triggered by a PWM operator 1 TEA event (WT)

MCPWM_OP2_TEA_INT_CLR Set this bit to clear the interrupt triggered by a PWM operator 2 TEA event (WT)

MCPWM_OP0_TEB_INT_CLR Set this bit to clear the interrupt triggered by a PWM operator 0 TEB event (WT)

MCPWM_OP1_TEB_INT_CLR Set this bit to clear the interrupt triggered by a PWM operator 1 TEB event (WT)

MCPWM_OP2_TEB_INT_CLR Set this bit to clear the interrupt triggered by a PWM operator 2 TEB event (WT)

MCPWM_FH0_CBC_INT_CLR Set this bit to clear the interrupt triggered by a cycle-by-cycle mode action on PWM0. (WT)

MCPWM_FH1_CBC_INT_CLR Set this bit to clear the interrupt triggered by a cycle-by-cycle mode action on PWM1. (WT)

MCPWM_FH2_CBC_INT_CLR Set this bit to clear the interrupt triggered by a cycle-by-cycle mode action on PWM2. (WT)

MCPWM_FH0_OST_INT_CLR Set this bit to clear the interrupt triggered by a one-shot mode action on PWM0. (WT)

MCPWM_FH1_OST_INT_CLR Set this bit to clear the interrupt triggered by a one-shot mode action on PWM1. (WT)

MCPWM_FH2_OST_INT_CLR Set this bit to clear the interrupt triggered by a one-shot mode action on PWM2. (WT)

MCPWM_CAP0_INT_CLR Set this bit to clear the interrupt triggered by capture on channel 0. (WT)

MCPWM_CAP1_INT_CLR Set this bit to clear the interrupt triggered by capture on channel 1. (WT)

MCPWM_CAP2_INT_CLR Set this bit to clear the interrupt triggered by capture on channel 2. (WT)

37 Remote Control Peripheral (RMT)

37.1 Overview

The RMT module is designed to send and receive infrared remote control signals. A variety of remote control protocols can be encoded/decoded via software based on the RMT module. The RMT module converts pulse codes stored in the module's built-in RAM into output signals, or converts input signals into pulse codes and stores them in RAM. In addition, the RMT module optionally modulates its output signals with a carrier wave, or optionally demodulates and filters its input signals.

The RMT module has eight channels, numbered from zero to seven. Each channel is able to independently transmit or receive signals.

- Channel 0 ~ 3 (TX channel) are dedicated to sending signals.
- Channel 4 ~ 7 (RX channel) are dedicated to receiving signals.

Each TX/RX channel is controlled by a dedicated set of registers with the same functionality. Channel 3 and channel 7 support DMA access, so the two channels also have a set of DMA-related control and status registers. Registers for each TX channel are indicated by *n* which is used as a placeholder for the channel number, and *m* for each RX channel.

37.2 Features

- Four TX channels
- Four RX channels
- Support multiple channels (programmable) transmitting data simultaneously
- Eight channels share a 384 x 32-bit RAM
- Support modulation on TX pulses
- Support filtering and demodulation on RX pulses
- Wrap TX mode
- Wrap RX mode
- Continuous TX mode
- DMA access for TX mode on channel 3
- DMA access for RX mode on channel 7

37.3 Functional Description

37.3.1 Architecture

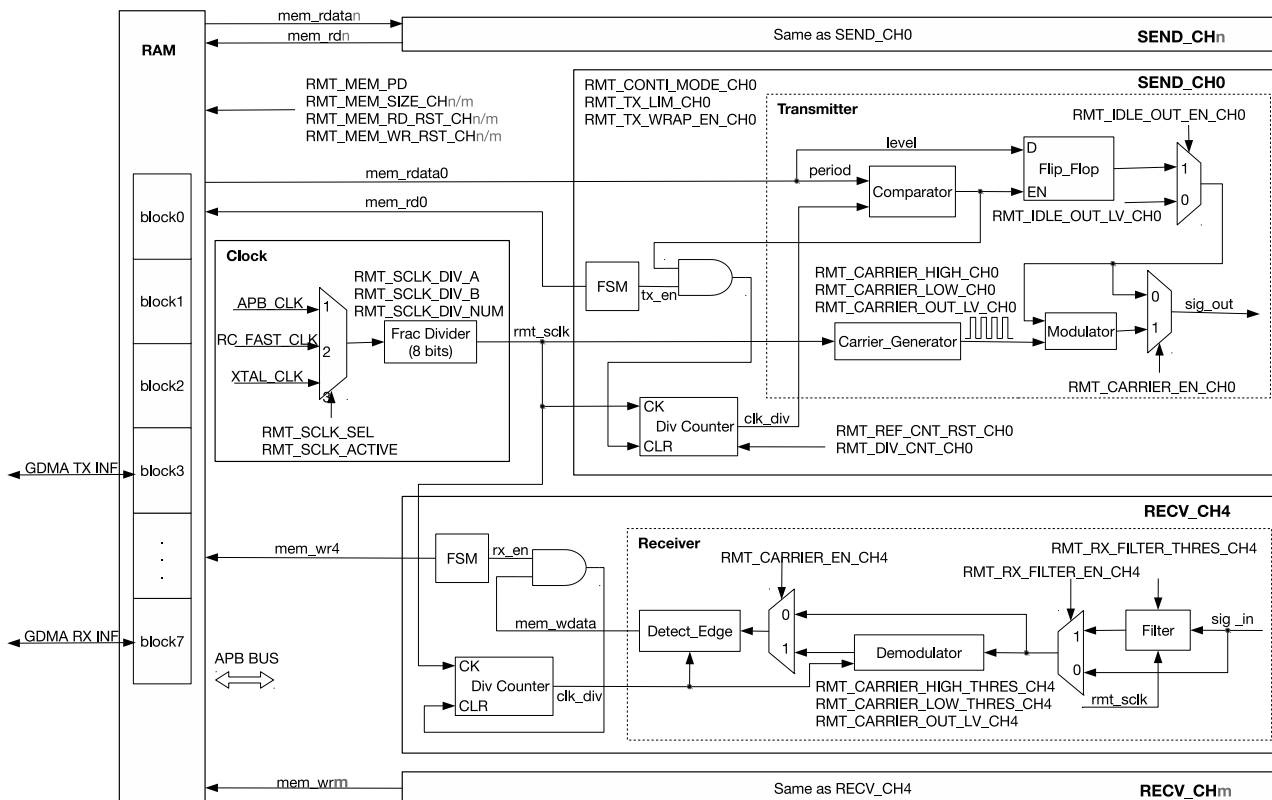

Figure 37-1. RMT Architecture

As shown in Figure 37-1, each TX channel (SEND_CH n) has:

- 1 x clock divider counter (Div Counter)
- 1 x state machine (FSM)
- 1 x transmitter

Each RX channel (RECV_CH m) has:

- 1 x clock divider counter (Div Counter)
- 1 x state machine (FSM)
- 1 x receiver

The eight channels share a 384 x 32-bit RAM.

37.3.2 RAM

37.3.2.1 RAM Architecture

Figure 37-2 shows the format of pulse code in RAM. Each pulse code contains a 16-bit entry with two fields: “level” and “period”. “level” (0 or 1) indicates a low-/high-level value was received or is going to be sent, while “period” points out the number of clock cycles (see Figure 37-1 clk_div) that the level lasts for.

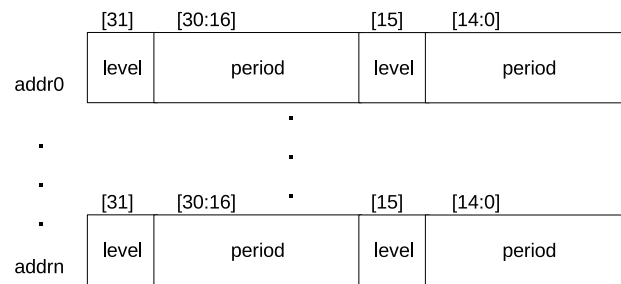

Figure 37-2. Format of Pulse Code in RAM

The minimum value for the period is zero (0) and is interpreted as a transmission end-marker. For a non-zero period (i.e., not an end-marker), its value is limited by APB clock and RMT clock according to the equation below:

$$3 \times T_{apb_clk} + 5 \times T_{rmt_sclk} < period \times T_{clk_div} \quad (1)$$

Note:

According to the equation above and the frequency of `rmt_sclk`, the pulse width (i.e. $period \times T_{clk_div}$) able to be captured by RMT is limited as follows:

- the minimum value of pulse width should be larger than $(3 \times T_{apb_clk} + 5 \times T_{rmt_sclk})$.
- the maximum value of pulse width should be smaller than or equal to (the maximum period \times the maximum T_{clk_div}), i.e., $((2^{15} - 1) \times \text{the maximum } T_{rmt_sclk} \times 256)$.

For more information about `rmt_sclk` frequency, or `APB_CLK` frequency, see Section 37.3.3, or Chapter 7 *Reset and Clock*.

37.3.2.2 Use of RAM

The RAM is divided into eight 48 x 32-bit blocks. By default, each channel uses one block (block 0 for channel 0, block 1 for channel 1, and so on).

If the data size of one single transfer is larger than one block size of TX channel n or RX channel m , users can configure the channel:

- to enable *wrap mode* by setting `RMT_MEM_TX/RX_WRAP_EN_CHn/m`.
- or to use more blocks by configuring `RMT_MEM_SIZE_CHn/m`.

Setting `RMT_MEM_SIZE_CHn/m` > 1 allows channel n/m to use the memory of subsequent channels, block $(n/m) \sim$ block $(n/m + \text{RMT_MEM_SIZE_CHn/m} - 1)$. If so, the subsequent channels $n/m + 1 \sim n/m + \text{RMT_MEM_SIZE_CHn/m} - 1$ can not be used once their RAM blocks are occupied. For example, if channel 0 is configured to use block 0 and block 1, then channel 1 can not be used due to its block being occupied. But channel 2 and channel 3 are not affected, and can be used normally.

Note that the RAM used by each channel is mapped from low address to high address. Under such mapping, channel 0 is able to use the RAM blocks for channels 1, 2 ... and 7 by setting `RMT_MEM_SIZE_CH0`, but channel 7 can not use the blocks for channels 0, 1, ... or 6. Therefore, the maximum value of `RMT_MEM_SIZE_CHn` should not exceed $(8 - n)$ and the maximum of `RMT_MEM_SIZE_CHm` should not exceed $(8 - m)$.

The RMT RAM can be accessed via the APB bus, read by a transmitting channel, and written to by a receiving channel. To avoid any possible access conflict between the receiver writing RAM and the APB bus reading RAM, RMT can be configured to designate the block's owner, be it the receiver or APB bus, by configuring [RMT_MEM_OWNER_CH \$m\$](#) . If this ownership is violated, a flag signal [RMT_MEM_OWNER_ERR_CH \$m\$](#) will be generated.

When the RMT module is inactive, the RAM can be put into low-power mode by setting [RMT_MEM_FORCE_PD](#).

37.3.2.3 RAM Access

APB bus is able to access RAM in FIFO mode and in NONFIFO (Direct Address) mode, depending on the configuration of [RMT_APB_FIFO_MASK](#):

- 1: use NONFIFO mode;
- 0: use FIFO mode.

Channels 3 and 7 also support DMA access.

FIFO Mode

In FIFO mode, the APB reads data from or writes data to RAM via a fixed address stored in [RMT_CH \$n\$ /mDATA_REG](#).

NONFIFO Mode

In NONFIFO mode, the APB writes data to or reads data from a continuous address range.

- The write-starting address of TX channel n is: RMT base address + $0x800 + (n - 1) \times 48$. The access address for the second data and the following data are RMT base address + $0x800 + (n - 1) \times 48 + 0x4$, and so on, incremented by $0x4$.
- The read-starting address of RX channel m is: RMT base address + $0x8c0 + (m - 1) \times 48$. The access address for the second data and the following data are RMT base address + $0x8c0 + (m - 1) \times 48 + 0x4$, and so on, incremented by $0x4$.

DMA Mode

Channel 3 also supports DMA access. If [RMT_DMA_ACCESS_EN_CH3](#) is set, RAM of channel 3 only allows DMA access. FIFO access or NONFIFO access to channel 3 by the APB bus are forbidden, otherwise **unpredictable consequences may occur**.

To ensure correct data transmission,

1. DMA should be started first.
2. RMT can only start sending data after DMA channel gets data ready, otherwise, unexpected data may be sent.

In *normal TX mode*, when the RAM of channel 3 is fully written by DMA, an [RMT_APB_MEM_WR_ERR_CH3](#) interrupt is triggered. Setting [RMT_MEM_TX_WRAP_EN_CH3](#) allows channel 3 to transmit more data than one block can fit, with no software operation needed.

Channel 7 also supports DMA access. If [RMT_DMA_ACCESS_EN_CH7](#) is set, the RAM of channel 7 is allowed to send data to DMA. Note in this mode, channel 7's RAM can also be accessed by APB via NONFIFO mode.

In *normal RX mode*, when the size of data read by DMA from channel 7 is equal to its RAM size, an `RMT_APB_MEM_RD_ERR_CH7` is triggered and the subsequent data is discarded. If `RMT_MEM_RX_WRAP_EN_CH7` is set, data of more than one block size can be received with no software wrap operation needed. If channel 7's RAM is full but the DMA still does not start receiving data from the channel, the newly received data by this channel will replace the previous data.

Note:

When channel 7 receives an end-marker, a DMA `in_suc_eof` interrupt is generated. Two bytes are written to DMA if the `period[14:0]` is 0, and four bytes to DMA if the `period[30:16]` is 0.

37.3.3 Clock

The clock source of RMT can be `APB_CLK`, `RC_FAST_CLK`, or `XTAL_CLK`, depending on the configuration of `RMT_SCLK_SEL`. RMT clock can be enabled by setting `RMT_SCLK_ACTIVE`. RMT working clock is obtained by dividing the selected clock source with a fractional divider, see Figure 37-1. The divider is:

$$RMT_SCLK_DIV_NUM + 1 + RMT_SCLK_DIV_A/RMT_SCLK_DIV_B$$

For more information, see Chapter 7 *Reset and Clock*. `RMT_DIV_CNT_CHn/m` is used to configure the divider coefficient of internal clock divider for RMT channels. The coefficient is normally equal to the value of `RMT_DIV_CNT_CHn/m`, except value 0 that represents divider 256. The clock divider can be reset by setting `RMT_REF_CNT_RST_CHn/m`. The clock generated from the divider can be used by the counter (see Figure 37-1).

37.3.4 Transmitter

Note:

Updating the configuration described in this and subsequent sections requires to set `RMT_CONF_UPDATE_CHn` first, see Section 37.3.6.

37.3.4.1 Normal TX Mode

When `RMT_TX_START_CHn` is set, the transmitter of channel *n* starts reading and sending pulse codes from the starting address of its RAM block. The codes are sent starting from low-address entry. When an end-marker (a zero period) is encountered, the transmitter stops the transmission, returns to idle state and generates an `RMT_CHn_TX_END_INT` interrupt. Setting `RMT_TX_STOP_CHn` to 1 also stops the transmission and immediately sets the transmitter back to idle. The output level of a transmitter in idle state is determined by the “level” field of the end-marker or by the content of `RMT_IDLE_OUT_LV_CHn`, depending on the configuration of `RMT_IDLE_OUT_EN_CHn`:

- 0: the level in idle state is determined by the “level” field of the end-marker.
- 1: the level is determined by `RMT_IDLE_OUT_LV_CHn`.

37.3.4.2 Wrap TX Mode

To transmit more pulse codes than can be fitted in the channel's RAM, users can enable wrap mode by setting `RMT_MEM_TX_WRAP_EN_CHn`. In wrap mode, the transmitter sends the data from RAM in loops till an end-marker is encountered. For example, if `RMT_MEM_SIZE_CHn = 1`, the transmitter starts sending data from the address $48 * n$, and then the data from higher RAM address. Once the transmitter finishes sending the data from $(48 * (n + 1) - 1)$, it continues sending data from $48 * n$ again till encounters an end-marker. Wrap mode is also applicable for `RMT_MEM_SIZE_CHn > 1`.

When the size of transmitted pulse codes is larger than or equal to the value set by `RMT_TX_LIM_CHn`, an `RMT_CHn_TX_THR_EVENT_INT` interrupt is generated. In wrap mode, `RMT_TX_LIM_CHn` can be set to a half or a fraction of the size of the channel's RAM block. When an `RMT_CHn_TX_THR_EVENT_INT` interrupt is detected by software, the already used RAM region can be updated by new pulse codes. In such way, the transmitter can seamlessly send unlimited pulse codes in wrap mode.

Note:

If RAM is accessed by DMA mode, more pulse codes than one block size can be transmitted with no additional operation needed. If accessed by APB bus, wrap mode has to be enabled via software to send more data than one block size.

37.3.4.3 TX Modulation

Transmitter output can be modulated with a carrier wave by setting `RMT_CARRIER_EN_CHn`. The carrier waveform is configurable. In a carrier cycle, the high level lasts for $(RMT_CARRIER_HIGH_CHn + 1)$ `rmt_sclk` cycles, while the low level lasts for $(RMT_CARRIER_LOW_CHn + 1)$ `rmt_sclk` cycles. When `RMT_CARRIER_OUT_LV_CHn` is set, carrier wave is added on the high-level of output signals; while `RMT_CARRIER_OUT_LV_CHn` is cleared, carrier wave is added on the low-level of output signals. Carrier wave can be added on all output signals during modulation, or just added on valid pulse codes (the data stored in RAM), which can be set by configuring `RMT_CARRIER_EFF_EN_CHn`:

- 0: add carrier wave on all output signals.
- 1: add carrier wave only on valid signals.

37.3.4.4 Continuous TX Mode

The continuous TX mode can be enabled by setting `RMT_TX_CONTI_MODE_CHn`. In this mode, the transmitter sends the pulse codes from RAM in loops:

- If an end-marker is encountered, the transmitter starts transmitting from the first data of the channel's RAM again.
- If no end-marker is encountered, the transmitter starts transmitting from the first data again after the last data is transmitted.

If `RMT_TX_LOOP_CNT_EN_CHn` is set, the loop counting is incremented by 1 each time an end-marker is encountered. If the counting reaches the value set by `RMT_TX_LOOP_NUM_CHn`, an `RMT_CHn_TX_LOOP_INT` interrupt is generated. If `RMT_LOOP_STOP_EN_CHn` is set, the transmission stops immediately once an `RMT_CHn_TX_LOOP_INT` interrupt is generated, otherwise, the transmission will continue. In an end-maker, if its `period[14:0]` is 0, then the period of the previous data must satisfy:

$$6 \times T_{apb_clk} + 12 \times T_{rmt_sclk} < period \times T_{clk_div} \quad (2)$$

The period of the other data only need to satisfy [relation \(1\)](#).

37.3.4.5 Simultaneous TX Mode

RMT module supports multiple channels transmitting data simultaneously. To use this function, follow the steps below:

1. Configure [RMT_TX_SIM_CH \$n\$](#) to choose which multiple channels are used to transmit data simultaneously.
2. Set [RMT_TX_SIM_EN](#) to enable this transmission mode.
3. Set [RMT_TX_START_CH \$n\$](#) for each selected channel, to start data transmitting.

The transmission starts once the final channel is configured. RMT module also supports simultaneous transmission of channels 0 ~ 2's RAM accessed by APB bus and channel 3's RAM accessed by DMA.

37.3.5 Receiver

37.3.5.1 Normal RX Mode

The receiver of channel m is controlled by [RMT_RX_EN_CH \$m\$](#) :

- 1: the receiver starts working.
- 0: the receiver stops receiving data.

When the receiver becomes active, it starts counting from the first edge of the signal, detecting signal levels and counting clock cycles the level lasts for. Each cycle count (period) is then written back to RAM together with the level information (level). When the receiver detects no change in a signal level for a number of clock cycles more than the value set by [RMT_IDLE_THRES_CH \$m\$](#) , the receiver will stop receiving data, return to idle state, and generate an [RMT_CH \$m\$ _RX_END_INT](#) interrupt. Please note that [RMT_IDLE_THRES_CH \$m\$](#) should be configured to a maximum value according to your application, otherwise a valid received level may be mistaken as a level in idle state. If the RAM space of this RX channel is used up by the received data, the receiver stops receiving data, and an [RMT_CH \$n\$ _ERR_INT](#) interrupt is triggered by RAM FULL event.

37.3.5.2 Wrap RX Mode

To receive more pulse codes than can be fitted in the channel's RAM, users can enable wrap mode for channel m by configuring [RMT_MEM_RX_WRAP_EN_CH \$m\$](#) . But if RAM is accessed by DMA mode, more pulse codes than one block size can be received with no additional operation needed. If accessed by APB bus, wrap mode has to be enabled to send more data than one block size. In wrap mode, the receiver stores the received data to RAM space of this channel in loops. Receiving ends, when the receiver detects no change in a signal level for a number of clock cycles more than the value set by [RMT_IDLE_THRES_CH \$m\$](#) . The receiver returns to idle state and generates an [RMT_CH \$m\$ _RX_END_INT](#) interrupt. For example, if [RMT_MEM_SIZE_CH \$m\$](#) is set to 1, the receiver starts receiving data and stores the data to address $48 * m$, and then to higher RAM address. When the receiver finishes storing the received data to $(48 * (m + 1) - 1)$, the receiver continues receiving data and storing data to the address $48 * m$ again, no change is detected on a signal level for more than [RMT_IDLE_THRES_CH \$m\$](#) clock cycles. Wrap mode is also applicable for [RMT_MEM_SIZE_CH \$m\$](#) > 1.

An [RMT_CH \$m\$ _RX_THR_EVENT_INT](#) interrupt is generated when the size of received pulse codes is larger than or equal to the value set by [RMT_CH \$m\$ _RX_LIM_REG](#). In wrap mode, [RMT_CH \$m\$ _RX_LIM_REG](#) can be set to a

half or a fraction of the size of the channel's RAM block. When an `RMT_CH m _RX_THR_EVENT_INT` interrupt is detected, the already used RAM region can be updated by subsequent data.

37.3.5.3 RX Filtering

Users can enable the receiver to filter input signals by setting `RMT_RX_FILTER_EN_CH m` for channel m . The filter samples input signals continuously, and detects the signals which remain unchanged for a continuous `RMT_RX_FILTER_THRES_CH m` `rmt_sclk` cycles as valid, otherwise, the signals will be detected as invalid. Only the valid signals can pass through this filter. The filter removes pulses with a length of less than `RMT_RX_FILTER_THRES_CH m` `rmt_sclk` cycles.

37.3.5.4 RX Demodulation

Users can enable RX demodulation on input signals or on filtered signals by setting `RMT_CARRIER_EN_CH m` . RX demodulation can be applied to high-level carrier wave or low-level carrier wave, depending on the configuration of `RMT_CARRIER_OUT_LV_CH m` :

- 1: demodulate high-level carrier wave
- 0: demodulate low-level carrier wave

Users can configure `RMT_CARRIER_HIGH_THRES_CH m` and `RMT_CARRIER_LOW_THRES_CH m` to set the thresholds to demodulate high-level carrier or low-level carrier. If the high-level of a signal lasts for less than `RMT_CARRIER_HIGH_THRES_CH m` `clk_div` cycles, or the low-level lasts for less than `RMT_CARRIER_LOW_THRES_CH m` `clk_div` cycles, such level is detected as a carrier and then is filtered out.

37.3.6 Configuration Update

To update RMT registers configuration, please set `RMT_CONF_UPDATE_CH n / m` for each channel first. All the bits/fields listed in the second column of Table 37-1 should follow this rule.

Table 37-1. Configuration Update

Register	Bit/Field Configuration Update
TX Channel	
<code>RMT_CHnCONF0_REG</code>	<code>RMT_CARRIER_OUT_LV_CHn</code>
	<code>RMT_CARRIER_EN_CHn</code>
	<code>RMT_CARRIER_EFF_EN_CHn</code>
	<code>RMT_DIV_CNT_CHn</code>
	<code>RMT_TX_STOP_CHn</code>
	<code>RMT_IDLE_OUT_EN_CHn</code>
	<code>RMT_TX_CONTI_MODE_CHn</code>
<code>RMT_CHnCARRIER_DUTY_REG</code>	<code>RMT_CARRIER_HIGH_CHn</code>
	<code>RMT_CARRIER_LOW_CHn</code>
<code>RMT_CHn_TX_LIM_REG</code>	<code>RMT_TX_LOOP_CNT_EN_CHn</code>
	<code>RMT_TX_LOOP_NUM_CHn</code>
	<code>RMT_TX_LIM_CHn</code>

Cont'd on next page

Table 37-1 – cont'd from previous page

Register	Bit/Field Configuration Update
RMT_TX_SIM_REG	RMT_TX_SIM_EN
RX Channel	
RMT_CH m CONF0_REG	RMT_CARRIER_OUT_LV_CH m
	RMT_CARRIER_EN_CH m
	RMT_IDLE_THRES_CH m
	RMT_DIV_CNT_CH m
RMT_CH m CONF1_REG	RMT_RX_FILTER_THRES_CH m
	RMT_RX_EN_CH m
RMT_CH m _RX_CARRIER_RM_REG	RMT_CARRIER_HIGH_THRES_CH m
	RMT_CARRIER_LOW_THRES_CH m
RMT_CH m _RX_LIM_REG	RMT_RX_LIM_CH m
RMT_REF_CNT_RST_REG	RMT_REF_CNT_RST_CH m

37.4 Interrupts

- RMT_CH n/m _ERR_INT: triggered when channel n/m does not read or write data correctly. For example, the receiver still tries to write data into RAM when the RAM is full. Or the transmitter still tries to read data from RAM when the RAM is empty.
- RMT_CH n _TX_THR_EVENT_INT: triggered when the amount of data the transmitter has sent matches the value of RMT_CH n _TX_LIM_REG.
- RMT_CH m _RX_THR_EVENT_INT: triggered each time when the amount of data received by the receiver reaches the value set in RMT_CH m _RX_LIM_REG.
- RMT_CH n _TX_END_INT: triggered when the transmitter has finished transmitting signals.
- RMT_CH m _RX_END_INT: triggered when the receiver has finished receiving signals.
- RMT_CH n _TX_LOOP_INT: triggered when the loop counting reaches the value set by RMT_TX_LOOP_NUM _CH n in continuous TX mode.
- RMT_CH3_DMA_ACCESS_FAIL_INT: triggered when the result of (the entries written to channel 3's RAM - the entries transmitted by channel 3) is larger than channel 3's RAM size, but DAM keeps writing data to this channel.
- RMT_CH7_DMA_ACCESS_FAIL_INT: triggered when the result of (the entries received by channel 7's RAM - the entries read by DMA) is larger than channel 7's RAM size, but channel 7 keeps receiving data.

37.5 Register Summary

The addresses in this section are relative to RMT base address provided in Table 4-3 in Chapter 4 *System and Memory*.

The abbreviations given in Column **Access** are explained in Section [Access Types for Registers](#).

Name	Description	Address	Access
FIFO R/W Register			
RMT_CH0DATA_REG	The read and write data register for channel 0 by APB FIFO access	0x0000	RO
RMT_CH1DATA_REG	The read and write data register for channel 1 by APB FIFO access	0x0004	RO
RMT_CH2DATA_REG	The read and write data register for channel 2 by APB FIFO access	0x0008	RO
RMT_CH3DATA_REG	The read and write data register for channel 3 by APB FIFO access	0x000C	RO
RMT_CH4DATA_REG	The read and write data register for channel 4 by APB FIFO access	0x0010	RO
RMT_CH5DATA_REG	The read and write data register for channel 5 by APB FIFO access	0x0014	RO
RMT_CH6DATA_REG	The read and write data register for channel 6 by APB FIFO access	0x0018	RO
RMT_CH7DATA_REG	The read and write data register for channel 7 by APB FIFO access	0x001C	RO
Configuration Registers			
RMT_CH0CONF0_REG	Configuration register 0 for channel 0	0x0020	varies
RMT_CH1CONF0_REG	Configuration register 0 for channel 1	0x0024	varies
RMT_CH2CONF0_REG	Configuration register 0 for channel 2	0x0028	varies
RMT_CH3CONF0_REG	Configuration register 0 for channel 3	0x002C	varies
RMT_CH4CONF0_REG	Configuration register 0 for channel 4	0x0030	R/W
RMT_CH4CONF1_REG	Configuration register 1 for channel 4	0x0034	varies
RMT_CH5CONF0_REG	Configuration register 0 for channel 5	0x0038	R/W
RMT_CH5CONF1_REG	Configuration register 1 for channel 5	0x003C	varies
RMT_CH6CONF0_REG	Configuration register 0 for channel 6	0x0040	R/W
RMT_CH6CONF1_REG	Configuration register 1 for channel 6	0x0044	varies
RMT_CH7CONF0_REG	Configuration register 0 for channel 7	0x0048	R/W
RMT_CH7CONF1_REG	Configuration register 1 for channel 7	0x004C	varies
RMT_CH4_RX_CARRIER_RM_REG	Demodulation register for channel 4	0x0090	R/W
RMT_CH5_RX_CARRIER_RM_REG	Demodulation register for channel 5	0x0094	R/W
RMT_CH6_RX_CARRIER_RM_REG	Demodulation register for channel 6	0x0098	R/W
RMT_CH7_RX_CARRIER_RM_REG	Demodulation register for channel 7	0x009C	R/W
RMT_SYS_CONF_REG	Configuration register for RMT APB	0x00C0	R/W
RMT_REF_CNT_RST_REG	Reset register for RMT clock divider	0x00C8	WT
Status Registers			
RMT_CH0STATUS_REG	Channel 0 status register	0x0050	RO
RMT_CH1STATUS_REG	Channel 1 status register	0x0054	RO
RMT_CH2STATUS_REG	Channel 2 status register	0x0058	RO
RMT_CH3STATUS_REG	Channel 3 status register	0x005C	RO
RMT_CH4STATUS_REG	Channel 4 status register	0x0060	RO
RMT_CH5STATUS_REG	Channel 5 status register	0x0064	RO

Name	Description	Address	Access
RMT_CH6STATUS_REG	Channel 6 status register	0x0068	RO
RMT_CH7STATUS_REG	Channel 7 status register	0x006C	RO
Interrupt Registers			
RMT_INT_RAW_REG	Raw interrupt status register	0x0070	R/WTC/SS
RMT_INT_ST_REG	Masked interrupt status register	0x0074	RO
RMT_INT_ENA_REG	Interrupt enable register	0x0078	R/W
RMT_INT_CLR_REG	Interrupt clear register	0x007C	WT
Carrier Wave Duty Cycle Registers			
RMT_CH0CARRIER_DUTY_REG	Duty duty configuration register for channel 0	0x0080	R/W
RMT_CH1CARRIER_DUTY_REG	Duty duty configuration register for channel 1	0x0084	R/W
RMT_CH2CARRIER_DUTY_REG	Duty duty configuration register for channel 2	0x0088	R/W
RMT_CH3CARRIER_DUTY_REG	Duty duty configuration register for channel 3	0x008C	R/W
TX Event Configuration Registers			
RMT_CH0_TX_LIM_REG	Configuration register for channel 0 TX event	0x00A0	varies
RMT_CH1_TX_LIM_REG	Configuration register for channel 1 TX event	0x00A4	varies
RMT_CH2_TX_LIM_REG	Configuration register for channel 2 TX event	0x00A8	varies
RMT_CH3_TX_LIM_REG	Configuration register for channel 3 TX event	0x00AC	varies
RMT_TX_SIM_REG	RMT simultaneous TX register	0x00C4	R/W
RX Event Configuration Registers			
RMT_CH4_RX_LIM_REG	Configuration register for channel 4 RX event	0x00B0	R/W
RMT_CH5_RX_LIM_REG	Configuration register for channel 5 RX event	0x00B4	R/W
RMT_CH6_RX_LIM_REG	Configuration register for channel 6 RX event	0x00B8	R/W
RMT_CH7_RX_LIM_REG	Configuration register for channel 7 RX event	0x00BC	R/W
Version Register			
RMT_DATE_REG	Version control register	0x00CC	R/W

37.6 Registers

The addresses in this section are relative to RMT base address provided in Table 4-3 in Chapter 4 *System and Memory*.

Register 37.1. RMT_CH n DATA_REG (n : 0-3) (0x0000+0x4* n)



RMT_CH n DATA Read and write data for channel n via APB FIFO. (RO)

Register 37.2. RMT_CH m DATA_REG (m = 4, 5, 6, 7) (0x0010, 0x0014, 0x0018, 0x001C)

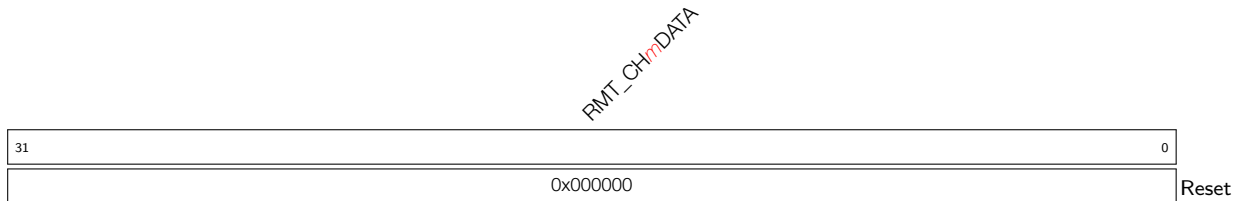

RMT_CH m DATA Read and write data for channel m via APB FIFO. (RO)

Register 37.3. RMT_CH n CONF0_REG (n : 0-3) (0x0020+0x4* n)

Continued from the previous page...

RMT_CARRIER_EN_CH n This is the carrier modulation enable-bit for channel n . 1: Add carrier modulation on the output signal. 0: No carrier modulation is added on output signal. (R/W)

RMT_CARRIER_OUT_LV_CH n This bit is used to configure the position of carrier wave for channel n . (R/W)

1'h0: add carrier wave on low level.

1'h1: add carrier wave on high level.

RMT_CONF_UPDATE_CH n Synchronization bit for channel n (WT)

RMT_DMA_ACCESS_EN_CH3 (Reserved for channel 0 - 2) DMA access enable bit for channel 3. (R/W)

Register 37.4. RMT_CH m CONF0_REG ($m = 4, 5, 6, 7$) (0x0030, 0x0038, 0x0040, 0x0048)

(reserved)		RMT_CARRIER_OUT_LV_CH m		RMT_CARRIER_EN_CH m		RMT_MEM_SIZE_CH m		RMT_DMA_ACCESS_EN_CH7(reserved for $m:4-6$)		RMT_IDLE_THRES_CH m		RMT_DIV_CNT_CH m	
31	30	29	28	27	24	23	22	8	7	0			
0	0	1	1	0x1		0	0x7fff		0x2		Reset		

RMT_DIV_CNT_CH m This field is used to configure the clock divider of channel m . (R/W)

RMT_IDLE_THRES_CH m This field is used to configure RX threshold. When no edge is detected on the input signal for continuous clock cycles longer than this field value, the receiver stops receiving data. (R/W)

RMT_DMA_ACCESS_EN_CH7 (Reserved for channel 4 - 6) DMA access enable bit for channel 7. (R/W)

RMT_MEM_SIZE_CH m This field is used to configure the maximum number of memory blocks allocated to channel m . (R/W)

RMT_CARRIER_EN_CH m This is the carrier demodulation enable-bit for channel m . 1: enable carrier demodulation for input signal. 0: disable carrier modulation for input signal. (R/W)

RMT_CARRIER_OUT_LV_CH m This bit is used to configure the position of carrier demodulation for channel m . (R/W)

1'h0: demodulate low-level carrier wave.

1'h1: demodulate high-level carrier wave.

Register 37.5. RMT_CH m CONF1_REG ($m = 4, 5, 6, 7$) (0x0034, 0x003C, 0x0044, 0x004C)

(reserved)																RMT_CONF_UPDATE_CH m			(reserved)			RMT_MEM_RX_WRAP_EN_CH m			RMT_RX_FILTER_THRES_CH m			RMT_RX_FILTER_EN_CH m			RMT_MEM_OWNER_CH m			RMT_APB_MEM_RST_CH m			RMT_MEM_WR_RST_CH m			RMT_RX_EN_CH m		
31																16	15	14	13	12							5	4	3	2	1	0										
0																0			0			0xf			0			1			0			0			Reset					

RMT_RX_EN_CH m Set this bit to enable the receiver to start receiving data on channel m . (R/W)

RMT_MEM_WR_RST_CH m Set this bit to reset RAM write address accessed by the receiver for channel m . (WT)

RMT_APB_MEM_RST_CH m Set this bit to reset RAM W/R address accessed by APB FIFO for channel m . (WT)

RMT_MEM_OWNER_CH m This bit marks the ownership of channel m 's RAM block. (R/W/SC)

1'h1: Receiver is using the RAM.

1'h0: APB bus is using the RAM.

RMT_RX_FILTER_EN_CH m Set this bit to enable the receiver's filter for channel m . (R/W)

RMT_RX_FILTER_THRES_CH m When receiving data, the receiver ignores the input pulse when its width is shorter than this register value in units of rmt_sclk cycles. (R/W)

RMT_MEM_RX_WRAP_EN_CH m Set this bit to enable wrap RX mode for channel m . In this mode, if the RX data size is larger than channel m 's RAM block size, the receiver stores the RX data from the first address to the last address in loops. (R/W)

RMT_CONF_UPDATE_CH m Synchronization bit for channel m . (WT)

Register 37.6. RMT_CH m _RX_CARRIER_RM_REG ($m = 4, 5, 6, 7$) (0x0090, 0x0094, 0x0098, 0x009C)

RMT_CARRIER_LOW_THRES_CH m The low level period in a carrier modulation mode is (RMT_CARRIER_LOW_THRES_CH m + 1) for channel m . (R/W)

RMT_CARRIER_HIGH_THRES_CH m The high level period in a carrier modulation mode is (RMT_CARRIER_HIGH_THRES_CH m + 1) for channel m . (R/W)

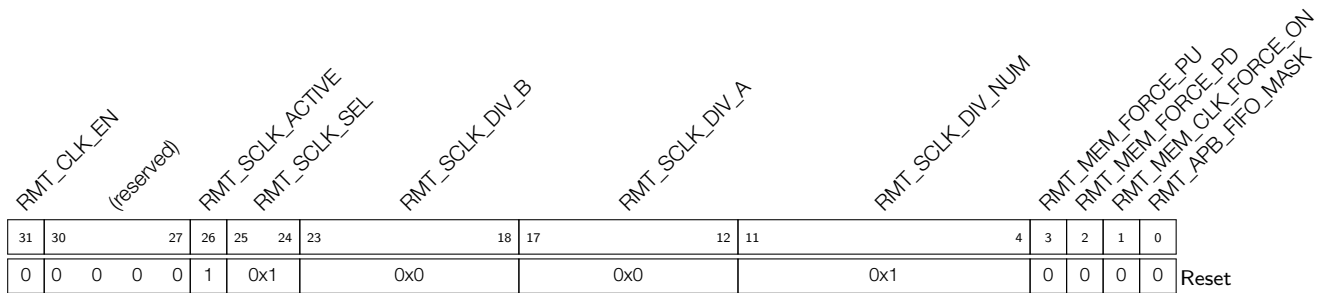
Register 37.7. RMT_SYS_CONF_REG (0x00C0)

RMT_APB_FIFO_MASK 1'h1: Access memory directly (NONFIFO mode). 1'h0: Access memory by FIFO (FIFO mode). (R/W)

RMT_MEM_CLK_FORCE_ON Set this bit to enable the clock for RMT memory. (R/W)

RMT_MEM_FORCE_PD Set this bit to power down RMT memory. (R/W)

RMT_MEM_FORCE_PU 1: Disable the power-down function of RMT memory in Light-sleep. 0: Power down RMT memory when RMT is in Light-sleep mode. (R/W)

RMT_SCLK_DIV_NUM The integral part of the fractional divider. (R/W)

RMT_SCLK_DIV_A The numerator of the fractional part of the fractional divider. (R/W)

RMT_SCLK_DIV_B The denominator of the fractional part of the fractional divider. (R/W)

RMT_SCLK_SEL Choose the clock source of rmt_sclk. 1: APB_CLK; 2: RC_FAST_CLK; 3: XTAL_CLK. (R/W)

RMT_SCLK_ACTIVE rmt_sclk switch. (R/W)

RMT_CLK_EN The enable signal of RMT register clock gate. 1: Power up the drive clock of registers. 0: Power down the drive clock of registers. (R/W)

Register 37.10. RMT_CH m STATUS_REG ($m = 4, 5, 6, 7$) (0x0060, 0x0064, 0x0068, 0x006C)

(reserved)				RMT_APB_MEM_RD_ERR_CH m				RMT_APB_MEM_RADDR_CH m				(reserved)				RMT_MEM_WADDR_EX_CH m			
31	28	27	26	25	24	22	21	20	11	10	9	0							
0	0	0	0	0	0	0	0	0	0xc0		0	0xc0							

Reset

RMT_MEM_WADDR_EX_CH m This field records the memory address offset when receiver of channel m is using the RAM. (RO)

RMT_APB_MEM_RADDR_CH m This field records the memory address offset when reads RAM over APB bus. (RO)

RMT_STATE_CH m This field records the FSM status of channel m . (RO)

RMT_MEM_OWNER_ERR_CH m This status bit will be set when the ownership of memory block is wrong. (RO)

RMT_MEM_FULL_CH m This status bit will be set if the receiver receives more data than the memory can fit. (RO)

RMT_APB_MEM_RD_ERR_CH m This status bit will be set if the offset address is out of memory size (overflows) when reads RAM via APB bus. (RO)

Register 37.11. RMT_INT_RAW_REG (0x0070)

(reserved)	RMT_CH7_DMA_ACCESS_FAIL_INT_RAW	RMT_CH3_DMA_ACCESS_FAIL_INT_RAW	RMT_CH7_RX_THR_EVENT_INT_RAW	RMT_CH6_RX_THR_EVENT_INT_RAW	RMT_CH5_RX_THR_EVENT_INT_RAW	RMT_CH4_RX_THR_EVENT_INT_RAW	RMT_CH7_ERR_INT_RAW	RMT_CH6_ERR_INT_RAW	RMT_CH5_ERR_INT_RAW	RMT_CH4_ERR_INT_RAW	RMT_CH7_RX_END_INT_RAW	RMT_CH6_RX_END_INT_RAW	RMT_CH5_RX_END_INT_RAW	RMT_CH4_RX_END_INT_RAW	RMT_CH8_TX_END_INT_RAW	RMT_CH2_TX_LOOP_INT_RAW	RMT_CH1_TX_LOOP_INT_RAW	RMT_CH0_TX_LOOP_INT_RAW	RMT_CH3_TX_THR_EVENT_INT_RAW	RMT_CH2_TX_THR_EVENT_INT_RAW	RMT_CH1_TX_THR_EVENT_INT_RAW	RMT_CH0_TX_THR_EVENT_INT_RAW	RMT_CH3_ERR_INT_RAW	RMT_CH2_ERR_INT_RAW	RMT_CH1_ERR_INT_RAW	RMT_CH0_ERR_INT_RAW	RMT_CH3_TX_END_INT_RAW	RMT_CH2_TX_END_INT_RAW	RMT_CH1_TX_END_INT_RAW	RMT_CH0_TX_END_INT_RAW	Reset			
31	30	29	28	27	26	25	24	23	22	21	20	19	18	17	16	15	14	13	12	11	10	9	8	7	6	5	4	3	2	1	0			
0	0	0	0	0	0	0	0	0	0	0	0	0	0	0	0	0	0	0	0	0	0	0	0	0	0	0	0	0	0	0	0	0	0	

RMT_CH n _TX_END_INT_RAW ($n = 0-3$) The interrupt raw bit of [RMT_CH \$n\$ _TX_END_INT](#). (R/WTC/SS)

RMT_CH n _ERR_INT_RAW ($n = 0-3$) The interrupt raw bit of [RMT_CH \$n\$ _ERR_INT](#). (R/WTC/SS)

RMT_CH n _TX_THR_EVENT_INT_RAW ($n = 0-3$) The interrupt raw bit of [RMT_CH \$n\$ _TX_THR_EVENT_INT](#). (R/WTC/SS)

RMT_CH n _TX_LOOP_INT_RAW ($n = 0-3$) The interrupt raw bit of [RMT_CH \$n\$ _TX_LOOP_INT](#). (R/WTC/SS)

RMT_CH m _RX_END_INT_RAW ($m = 4-7$) The interrupt raw bit of [RMT_CH \$m\$ _RX_END_INT](#). (R/WTC/SS)

RMT_CH m _ERR_INT_RAW ($m = 4-7$) The interrupt raw bit of [RMT_CH \$m\$ _ERR_INT](#). (R/WTC/SS)

RMT_CH m _RX_THR_EVENT_INT_RAW ($m = 4-7$) The interrupt raw bit of [RMT_CH \$m\$ _RX_THR_EVENT_INT](#). (R/WTC/SS)

RMT_CH3_DMA_ACCESS_FAIL_INT_RAW The interrupt raw bit of [RMT_CH3_DMA_ACCESS_FAIL_INT](#). (R/WTC/SS)

RMT_CH7_DMA_ACCESS_FAIL_INT_RAW The interrupt raw bit of [RMT_CH7_DMA_ACCESS_FAIL_INT](#). (R/WTC/SS)

Register 37.13. RMT_INT_ENA_REG (0x0078)

(reserved)																														
RMT_CH7_DMA_ACCESS_FAIL_INT_ENA																														
RMT_CH3_DMA_ACCESS_FAIL_INT_ENA																														
RMT_CH7_RX_THR_EVENT_INT_ENA																														
RMT_CH6_RX_THR_EVENT_INT_ENA																														
RMT_CH5_RX_THR_EVENT_INT_ENA																														
RMT_CH4_RX_THR_EVENT_INT_ENA																														
RMT_CH7_ERR_INT_ENA																														
RMT_CH6_ERR_INT_ENA																														
RMT_CH5_ERR_INT_ENA																														
RMT_CH4_ERR_INT_ENA																														
RMT_CH7_RX_END_INT_ENA																														
RMT_CH5_RX_END_INT_ENA																														
RMT_CH4_RX_END_INT_ENA																														
RMT_CH3_TX_END_INT_ENA																														
RMT_CH2_TX_END_INT_ENA																														
RMT_CH1_TX_LOOP_INT_ENA																														
RMT_CH0_TX_LOOP_INT_ENA																														
RMT_CH3_TX_LOOP_INT_ENA																														
RMT_CH2_TX_LOOP_INT_ENA																														
RMT_CH1_TX_THR_EVENT_INT_ENA																														
RMT_CH0_TX_THR_EVENT_INT_ENA																														
RMT_CH3_ERR_INT_ENA																														
RMT_CH2_ERR_INT_ENA																														
RMT_CH1_ERR_INT_ENA																														
RMT_CH0_ERR_INT_ENA																														
RMT_CH3_TX_END_INT_ENA																														
RMT_CH2_TX_END_INT_ENA																														
RMT_CH1_TX_END_INT_ENA																														
RMT_CH0_TX_END_INT_ENA																														

31	30	29	28	27	26	25	24	23	22	21	20	19	18	17	16	15	14	13	12	11	10	9	8	7	6	5	4	3	2	1	0
0	0	0	0	0	0	0	0	0	0	0	0	0	0	0	0	0	0	0	0	0	0	0	0	0	0	0	0	0	0	0	0

Reset

RMT_CH n _TX_END_INT_ENA ($n = 0-3$) The interrupt enable bit of [RMT_CH \$n\$ _TX_END_INT](#). (R/W)

RMT_CH n _ERR_INT_ENA ($n = 0-3$) The interrupt enable bit of [RMT_CH \$n\$ _ERR_INT](#). (R/W)

RMT_CH n _TX_THR_EVENT_INT_ENA ($n = 0-3$) The interrupt enable bit of [RMT_CH \$n\$ _TX_THR_EVENT_INT](#). (R/W)

RMT_CH n _TX_LOOP_INT_ENA ($n = 0-3$) The interrupt enable bit of [RMT_CH \$n\$ _TX_LOOP_INT](#). (R/W)

RMT_CH m _RX_END_INT_ENA ($m = 4-7$) The interrupt enable bit of [RMT_CH \$m\$ _RX_END_INT](#). (R/W)

RMT_CH m _ERR_INT_ENA ($m = 4-7$) The interrupt enable bit of [RMT_CH \$m\$ _ERR_INT](#). (R/W)

RMT_CH m _RX_THR_EVENT_INT_ENA ($m = 4-7$) The interrupt enable bit of [RMT_CH \$m\$ _RX_THR_EVENT_INT](#). (R/W)

RMT_CH3_DMA_ACCESS_FAIL_INT_ENA The interrupt enable bit of [RMT_CH3_DMA_ACCESS_FAIL_INT](#). (R/W)

RMT_CH7_DMA_ACCESS_FAIL_INT_ENA The interrupt enable bit of [RMT_CH7_DMA_ACCESS_FAIL_INT](#). (R/W)

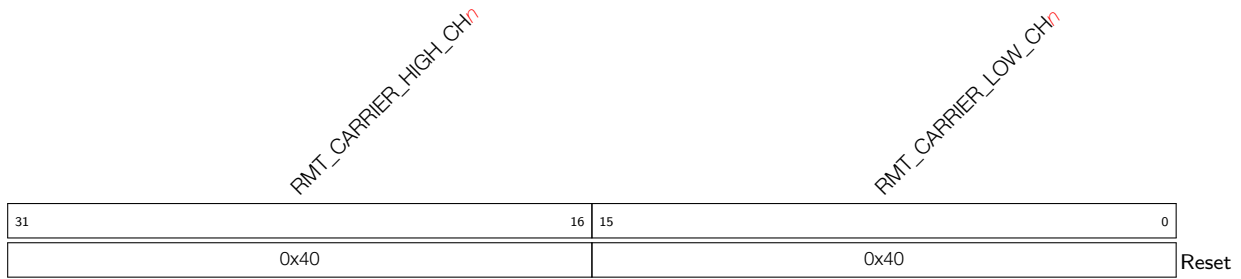
Register 37.15. RMT_CH n CARRIER_DUTY_REG (n : 0-3) (0x0080+0x4* n)

RMT_CARRIER_LOW_CH n This field is used to configure carrier wave's low level clock period for channel n . (R/W)

RMT_CARRIER_HIGH_CH n This field is used to configure carrier wave's high level clock period for channel n . (R/W)

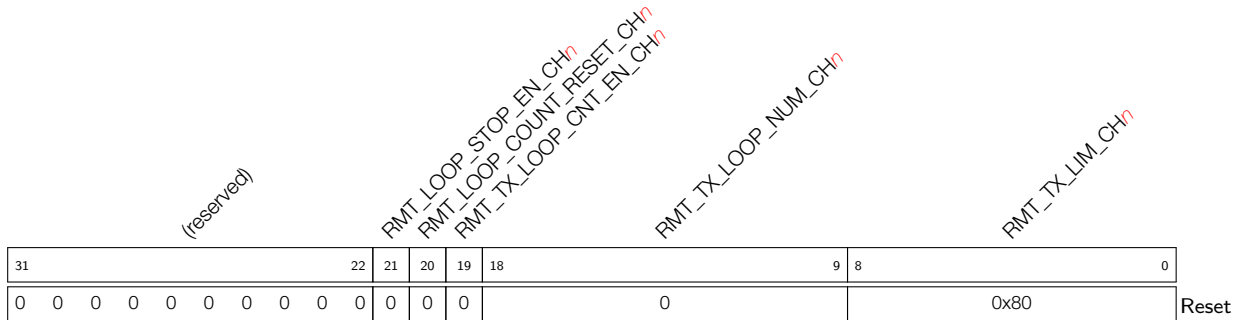
Register 37.16. RMT_CH n _TX_LIM_REG (n : 0-3) (0x00A0+0x4* n)

RMT_TX_LIM_CH n This field is used to configure the maximum entries that channel n can send out. (R/W)

RMT_TX_LOOP_NUM_CH n This field is used to configure the maximum loop count when continuous TX mode is enabled. (R/W)

RMT_TX_LOOP_CNT_EN_CH n This bit is the enable bit for loop counting. (R/W)

RMT_LOOP_COUNT_RESET_CH n This bit is used to reset the loop count when continuous TX mode is enabled. (WT)

RMT_LOOP_STOP_EN_CH n Set this bit, if the loop counting reaches the value set in RMT_TX_LOOP_CNT_EN_CH n , continuous TX mode will be stopped. (R/W)

Register 37.17. RMT_TX_SIM_REG (0x00C4)

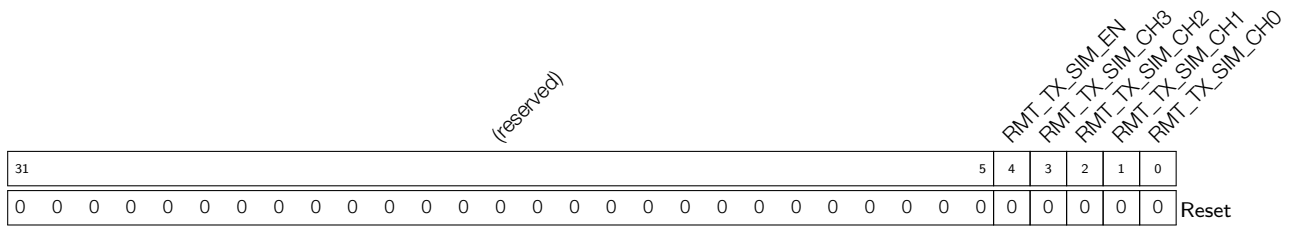

RMT_TX_SIM_CH n ($n = 0-3$) Set this bit to enable channel n to start sending data simultaneously with other enabled channels. (R/W)

RMT_TX_SIM_EN This bit is used to enable multiple channels to start sending data simultaneously. (R/W)

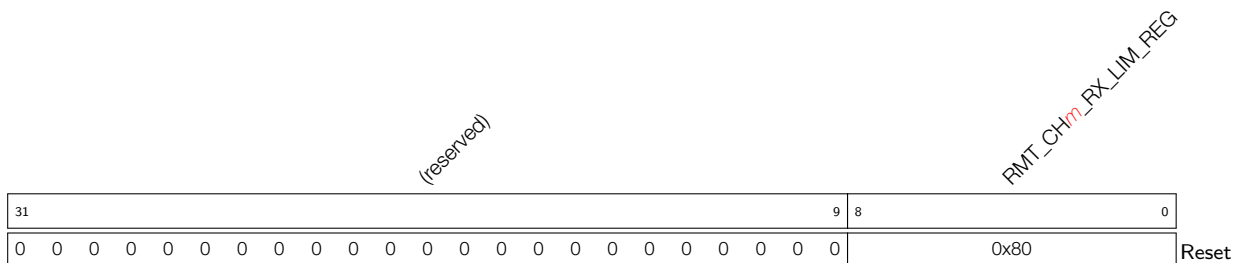
Register 37.18. RMT_CH m _RX_LIM_REG ($m = 4, 5, 6, 7$) (0x00B0, 0x00B4, 0x00B8, 0x00BC)

RMT_CH m _RX_LIM_REG This field is used to configure the maximum entries that channel m can receive. (R/W)

Register 37.19. RMT_DATE_REG (0x00CC)

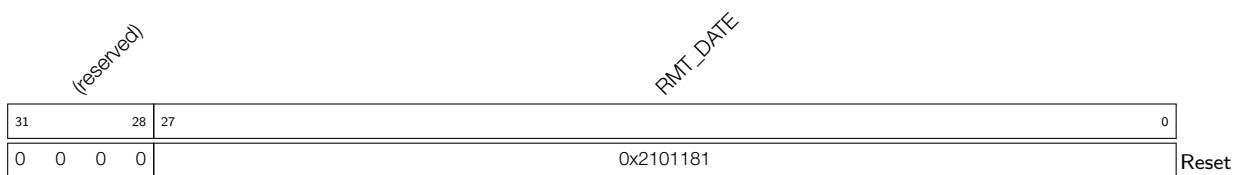

RMT_DATE Version control register. (R/W)

38 Pulse Count Controller (PCNT)

The pulse count controller (PCNT) is designed to count input pulses. It can increment or decrement a pulse counter value by keeping track of rising (positive) or falling (negative) edges of the input pulse signal. The PCNT has four independent pulse counters called units, which have their groups of registers. There is only one clock in PCNT, which is APB_CLK. In this chapter, n denotes the number of a unit from 0 ~ 3.

Each unit includes two channels (ch0 and ch1) which can independently increment or decrement its pulse counter value. The remainder of the chapter will mostly focus on channel 0 (ch0) as the functionality of the two channels is identical.

As shown in Figure 38-1, each channel has two input signals:

1. One input pulse signal (e.g. sig_ch0_un, the input pulse signal for ch0 of unit n ch0)
2. One control signal (e.g. ctrl_ch0_un, the control signal for ch0 of unit n ch0)

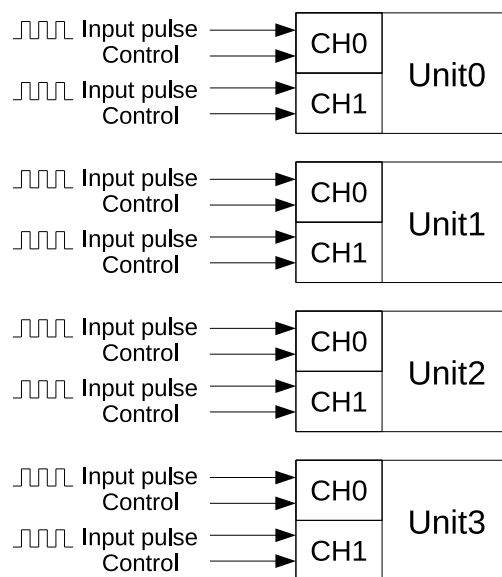

Figure 38-1. PCNT Block Diagram

38.1 Features

A PCNT has the following features:

- Four independent pulse counters (units) that count from 1 to 65535
- Each unit consists of two independent channels sharing one pulse counter
- All channels have input pulse signals (e.g. sig_ch0_un) with their corresponding control signals (e.g. ctrl_ch0_un)
- Independently filter glitches of input pulse signals (sig_ch0_un and sig_ch1_un) and control signals (ctrl_ch0_un and ctrl_ch1_un) on each unit
- Each channel has the following parameters:
 1. Selection between counting on positive or negative edges of the input pulse signal

2. Configuration to Increment, Decrement, or Disable counter mode for control signal's high and low states

- Maximum frequency of pulses: 40 MHz

38.2 Functional Description

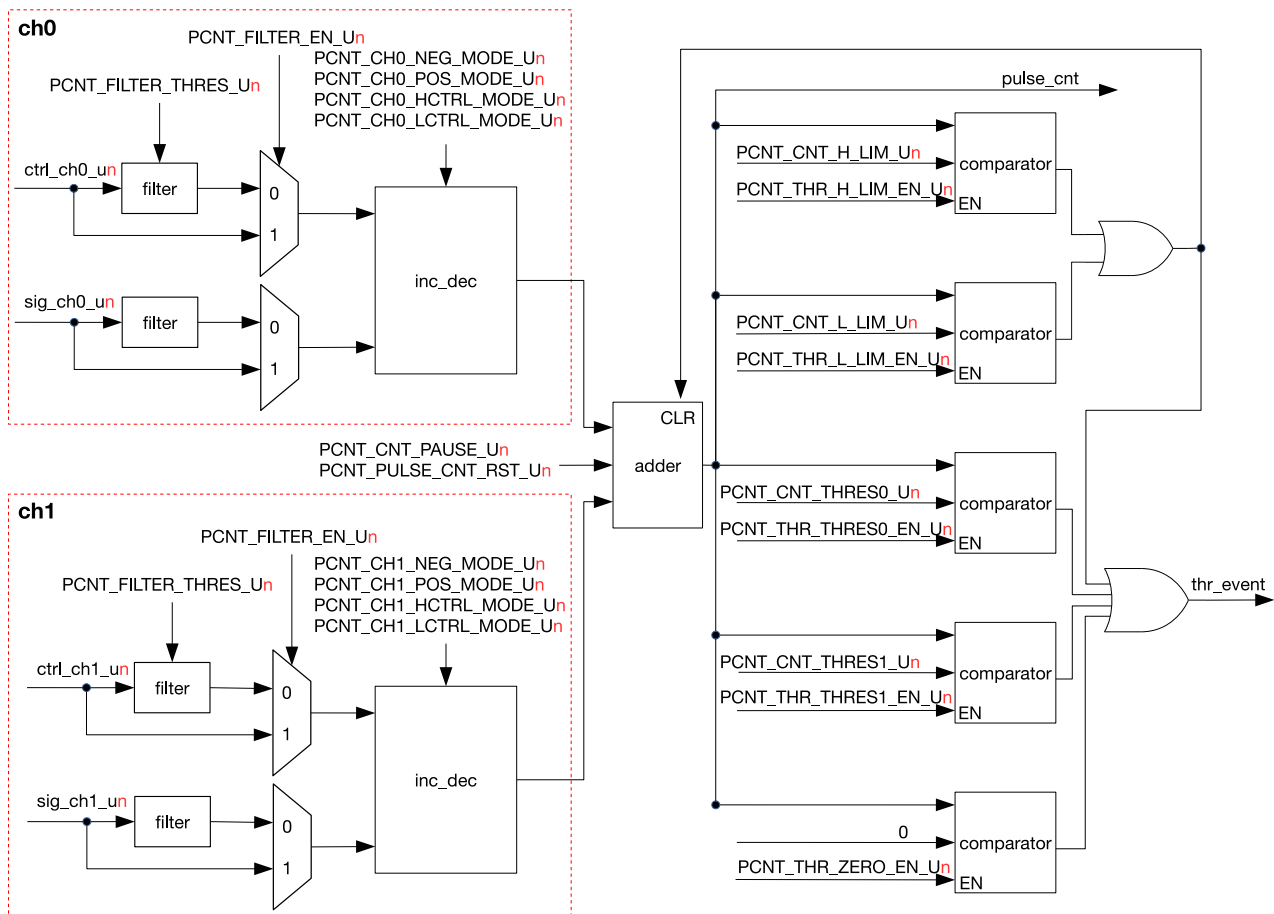

Figure 38-2. PCNT Unit Architecture

Figure 38-2 shows PCNT's architecture. As stated above, `ctrl_ch0_un` is the control signal for ch0 of unit n . Its high and low states can be assigned different counter modes and used for pulse counting of the channel's input pulse signal `sig_ch0_un` on negative or positive edges. The available counter modes are as follows:

- Increment mode: When a channel detects an active edge of `sig_ch0_un` (can be configured by software), the counter value `pulse_cnt` increases by 1. Upon reaching `PCNT_CNT_H_LIM_Un`, `pulse_cnt` is cleared. If the channel's counter mode is changed or if `PCNT_CNT_PAUSE_Un` is set before `pulse_cnt` reaches `PCNT_CNT_H_LIM_Un`, then `pulse_cnt` freezes and its counter mode changes.
- Decrement mode: When a channel detects an active edge of `sig_ch0_un` (can be configured by software), the counter value `pulse_cnt` decreases by 1. Upon reaching `PCNT_CNT_L_LIM_Un`, `pulse_cnt` is cleared. If the channel's counter mode is changed or if `PCNT_CNT_PAUSE_Un` is set before `pulse_cnt` reaches `PCNT_CNT_H_LIM_Un`, then `pulse_cnt` freezes and its counter mode changes.
- Disable mode: Counting is disabled, and the counter value `pulse_cnt` freezes.

Table 38-1 to Table 38-4 provide information on how to configure the counter mode for channel 0.

Table 38-1. Counter Mode. Positive Edge of Input Pulse Signal. Control Signal in Low State

PCNT_CH0_POS_MODE_U _n	PCNT_CH0_LCTRL_MODE_U _n	Counter Mode
1	0	Increment
	1	Decrement
	Others	Disable
2	0	Decrement
	1	Increment
	Others	Disable
Others	N/A	Disable

Table 38-2. Counter Mode. Positive Edge of Input Pulse Signal. Control Signal in High State

PCNT_CH0_POS_MODE_U _n	PCNT_CH0_HCTRL_MODE_U _n	Counter Mode
1	0	Increment
	1	Decrement
	Others	Disable
2	0	Decrement
	1	Increment
	Others	Disable
Others	N/A	Disable

Table 38-3. Counter Mode. Negative Edge of Input Pulse Signal. Control Signal in Low State

PCNT_CH0_NEG_MODE_U _n	PCNT_CH0_LCTRL_MODE_U _n	Counter Mode
1	0	Increment
	1	Decrement
	Others	Disable
2	0	Decrement
	1	Increment
	Others	Disable
Others	N/A	Disable

Table 38-4. Counter Mode. Negative Edge of Input Pulse Signal. Control Signal in High State

PCNT_CH0_NEG_MODE_U _n	PCNT_CH0_HCTRL_MODE_U _n	Counter Mode
1	0	Increment
	1	Decrement
	Others	Disable
2	0	Decrement
	1	Increment
	Others	Disable
Others	N/A	Disable

Each unit has one filter for all its control and input pulse signals. A filter can be enabled with the bit `PCNT_FILTER_EN_Un`. The filter monitors the signals and ignores all the noise, i.e. the glitches with pulse widths shorter than `PCNT_FILTER_THRES_Un` APB clock cycles in length.

As previously mentioned, each unit has two channels which process different input pulse signals and increase or decrease values via their respective inc_dec modules, then the two channels send these values to the adder module which has a 16-bit wide signed register. This adder can be suspended by setting `PCNT_CNT_PAUSE_Un`, and cleared by setting `PCNT_PULSE_CNT_RST_Un`.

The PCNT has five watchpoints that share one interrupt. The interrupt can be enabled or disabled by interrupt enable signals of each individual watchpoint.

- Maximum count value: When pulse_cnt reaches `PCNT_CNT_H_LIM_Un`, a high limit interrupt is triggered and `PCNT_CNT_THR_H_LIM_LAT_Un` is high.
- Minimum count value: When pulse_cnt reaches `PCNT_CNT_L_LIM_Un`, a low limit interrupt is triggered and `PCNT_CNT_THR_L_LIM_LAT_Un` is high.
- Two threshold values: When pulse_cnt equals either `PCNT_CNT_THRES0_Un` or `PCNT_CNT_THRES1_Un`, an interrupt is triggered and either `PCNT_CNT_THR_THRES0_LAT_Un` or `PCNT_CNT_THR_THRES1_LAT_Un` is high respectively.
- Zero: When pulse_cnt is 0, an interrupt is triggered and `PCNT_CNT_THR_ZERO_LAT_Un` is valid.

38.3 Applications

In each unit, channel 0 and channel 1 can be configured to work independently or together. The three subsections below provide details of channel 0 incrementing independently, channel 0 decrementing independently, and channel 0 and channel 1 incrementing together. For other working modes not elaborated in this section (e.g. channel 1 incrementing/decrementing independently, or one channel incrementing while the other decrementing), reference can be made to these three subsections.

38.3.1 Channel 0 Incrementing Independently

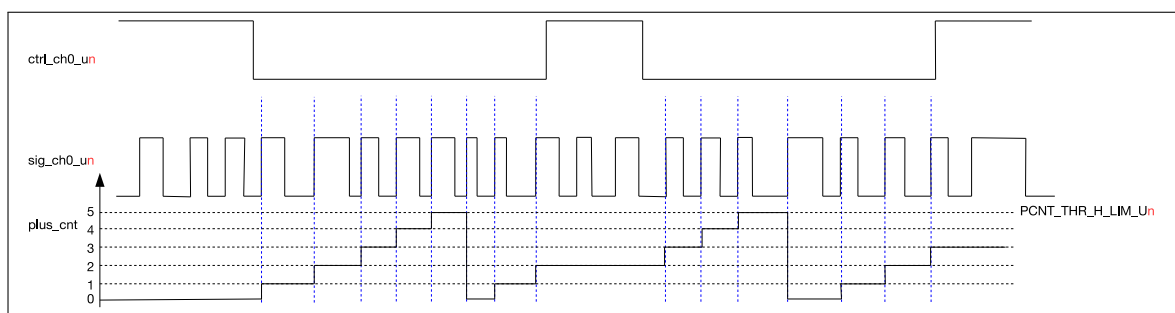

Figure 38-3. Channel 0 Up Counting Diagram

Figure 38-3 illustrates how channel 0 is configured to increment independently on the positive edge of `sig_ch0_un` while channel 1 is disabled (see subsection 38.2 for how to disable channel 1). The configuration of channel 0 is shown below.

- `PCNT_CH0_LCTRL_MODE_Un=0`: When `ctrl_ch0_un` is low, the counter mode specified for the low state turns on, in this case it is Increment mode.

- **PCNT_CH0_HCTRL_MODE_Un=2**: When `ctrl_ch0_un` is high, the counter mode specified for the low state turns on, in this case it is Disable mode.
- **PCNT_CH0_POS_MODE_Un=1**: The counter increments on the positive edge of `sig_ch0_un`.
- **PCNT_CH0_NEG_MODE_Un=0**: The counter idles on the negative edge of `sig_ch0_un`.
- **PCNT_CNT_H_LIM_Un=5**: When `pulse_cnt` counts up to **PCNT_CNT_H_LIM_Un**, it is cleared.

38.3.2 Channel 0 Decrementing Independently

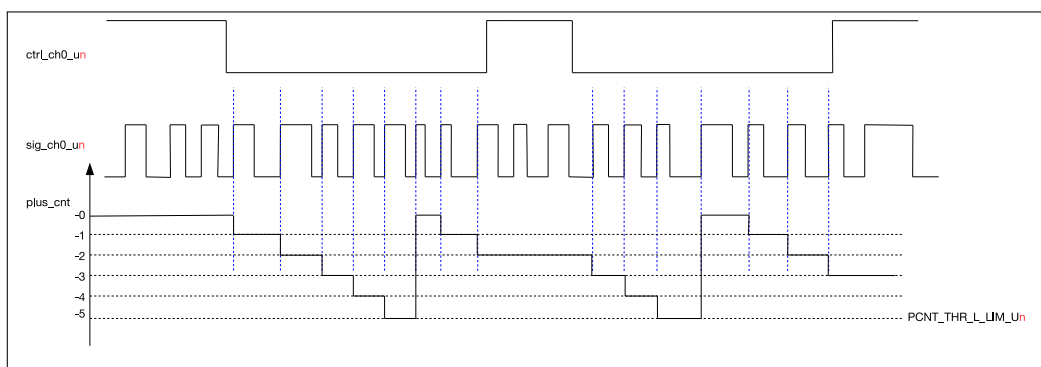

Figure 38-4. Channel 0 Down Counting Diagram

Figure 38-4 illustrates how channel 0 is configured to decrement independently on the positive edge of `sig_ch0_un` while channel 1 is disabled. The configuration of channel 0 in this case differs from that in Figure 38-3 in the following aspects:

- **PCNT_CH0_POS_MODE_Un=2**: the counter decrements on the positive edge of `sig_ch0_un`.
- **PCNT_CNT_L_LIM_Un=-5**: when `pulse_cnt` counts down to **PCNT_CNT_L_LIM_Un**, it is cleared.

38.3.3 Channel 0 and Channel 1 Incrementing Together

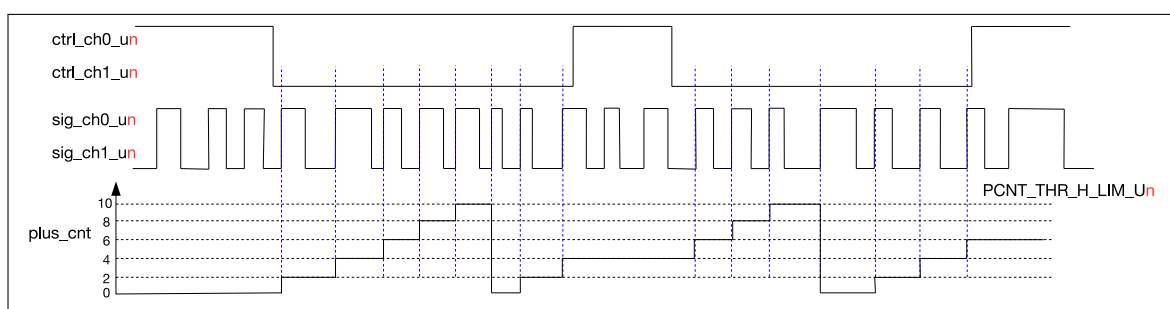

Figure 38-5. Two Channels Up Counting Diagram

Figure 38-5 illustrates how channel 0 and channel 1 are configured to increment on the positive edge of `sig_ch0_un` and `sig_ch1_un` respectively at the same time. It can be seen in Figure 38-5 that control signal `ctrl_ch0_un` and `ctrl_ch1_un` have the same waveform, so as input pulse signal `sig_ch0_un` and `sig_ch1_un`. The configuration procedure is shown below.

- For channel 0:

- `PCNT_CH0_LCTRL_MODE_Un=0`: When `ctrl_ch0_un` is low, the counter mode specified for the low state turns on, in this case it is Increment mode.
- `PCNT_CH0_HCTRL_MODE_Un=2`: When `ctrl_ch0_un` is high, the counter mode specified for the low state turns on, in this case it is Disable mode.
- `PCNT_CH0_POS_MODE_Un=1`: The counter increments on the positive edge of `sig_ch0_un`.
- `PCNT_CH0_NEG_MODE_Un=0`: The counter idles on the negative edge of `sig_ch0_un`.
- For channel 1:
 - `PCNT_CH1_LCTRL_MODE_Un=0`: When `ctrl_ch1_un` is low, the counter mode specified for the low state turns on, in this case it is Increment mode.
 - `PCNT_CH1_HCTRL_MODE_Un=2`: When `ctrl_ch1_un` is high, the counter mode specified for the low state turns on, in this case it is Disable mode.
 - `PCNT_CH1_POS_MODE_Un=1`: The counter increments on the positive edge of `sig_ch1_un`.
 - `PCNT_CH1_NEG_MODE_Un=0`: The counter idles on the negative edge of `sig_ch1_un`.
- `PCNT_CNT_H_LIM_Un=10`: When `pulse_cnt` counts up to `PCNT_CNT_H_LIM_Un`, it is cleared.

38.4 Register Summary

The addresses in this section are relative to **Pulse Count Controller** base address provided in Table 4-3 in Chapter 4 *System and Memory*.

The abbreviations given in Column **Access** are explained in Section [Access Types for Registers](#).

Name	Description	Address	Access
Configuration Register			
PCNT_U0_CONF0_REG	Configuration register 0 for unit 0	0x0000	R/W
PCNT_U0_CONF1_REG	Configuration register 1 for unit 0	0x0004	R/W
PCNT_U0_CONF2_REG	Configuration register 2 for unit 0	0x0008	R/W
PCNT_U1_CONF0_REG	Configuration register 0 for unit 1	0x000C	R/W
PCNT_U1_CONF1_REG	Configuration register 1 for unit 1	0x0010	R/W
PCNT_U1_CONF2_REG	Configuration register 2 for unit 1	0x0014	R/W
PCNT_U2_CONF0_REG	Configuration register 0 for unit 2	0x0018	R/W
PCNT_U2_CONF1_REG	Configuration register 1 for unit 2	0x001C	R/W
PCNT_U2_CONF2_REG	Configuration register 2 for unit 2	0x0020	R/W
PCNT_U3_CONF0_REG	Configuration register 0 for unit 3	0x0024	R/W
PCNT_U3_CONF1_REG	Configuration register 1 for unit 3	0x0028	R/W
PCNT_U3_CONF2_REG	Configuration register 2 for unit 3	0x002C	R/W
PCNT_CTRL_REG	Control register for all counters	0x0060	R/W
Status Register			
PCNT_U0_CNT_REG	Counter value for unit 0	0x0030	RO
PCNT_U1_CNT_REG	Counter value for unit 1	0x0034	RO
PCNT_U2_CNT_REG	Counter value for unit 2	0x0038	RO
PCNT_U3_CNT_REG	Counter value for unit 3	0x003C	RO
PCNT_U0_STATUS_REG	PNCT UNIT0 status register	0x0050	RO
PCNT_U1_STATUS_REG	PNCT UNIT1 status register	0x0054	RO
PCNT_U2_STATUS_REG	PNCT UNIT2 status register	0x0058	RO
PCNT_U3_STATUS_REG	PNCT UNIT3 status register	0x005C	RO
Interrupt Register			
PCNT_INT_RAW_REG	Interrupt raw status register	0x0040	RO
PCNT_INT_ST_REG	Interrupt status register	0x0044	RO
PCNT_INT_ENA_REG	Interrupt enable register	0x0048	R/W
PCNT_INT_CLR_REG	Interrupt clear register	0x004C	WO
Version Register			
PCNT_DATE_REG	PCNT version control register	0x00FC	R/W

38.5 Registers

The addresses in this section are relative to **Pulse Count Controller** base address provided in Table 4-3 in Chapter 4 *System and Memory*.

Register 38.1. PCNT_U_n_CONF0_REG (n: 0-3) (0x0000+0xC*n)

<i>PCNT_CH1_LCTRL_MODE_U0</i>		<i>PCNT_CH1_HCTRL_MODE_U0</i>		<i>PCNT_CH1_POS_MODE_U0</i>		<i>PCNT_CH1_NEG_MODE_U0</i>		<i>PCNT_CH0_LCTRL_MODE_U0</i>		<i>PCNT_CH0_HCTRL_MODE_U0</i>		<i>PCNT_CH0_POS_MODE_U0</i>		<i>PCNT_CH0_NEG_MODE_U0</i>		<i>PCNT_THR_THRES1_EN_U0</i>		<i>PCNT_THR_THRES0_EN_U0</i>		<i>PCNT_THR_L_LIM_EN_U0</i>		<i>PCNT_THR_H_LIM_EN_U0</i>		<i>PCNT_THR_ZERO_EN_U0</i>		<i>PCNT_FILTER_THRES_U0</i>	
31	30	29	28	27	26	25	24	23	22	21	20	19	18	17	16	15	14	13	12	11	10	9					0
0x0		0x0		0x0		0x0		0x0		0x0		0x0		0x0		0	0	1	1	1	1	0x10				Reset	

PCNT_FILTER_THRES_U_n This sets the maximum threshold, in APB_CLK cycles, for the filter.

Any pulses with width less than this will be ignored when the filter is enabled. (R/W)

PCNT_FILTER_EN_U_n This is the enable bit for unit *n*'s input filter. (R/W)

PCNT_THR_ZERO_EN_U_n This is the enable bit for unit *n*'s zero comparator. (R/W)

PCNT_THR_H_LIM_EN_U_n This is the enable bit for unit *n*'s thr_h_lim comparator. (R/W)

PCNT_THR_L_LIM_EN_U_n This is the enable bit for unit *n*'s thr_l_lim comparator. (R/W)

PCNT_THR_THRES0_EN_U_n This is the enable bit for unit *n*'s thres0 comparator. (R/W)

PCNT_THR_THRES1_EN_U_n This is the enable bit for unit *n*'s thres1 comparator. (R/W)

PCNT_CH0_NEG_MODE_U_n This register sets the behavior when the signal input of channel 0 detects a negative edge.

1: Increase the counter; 2: Decrease the counter; 0, 3: No effect on counter (R/W)

PCNT_CH0_POS_MODE_U_n This register sets the behavior when the signal input of channel 0 detects a positive edge.

1: Increase the counter; 2: Decrease the counter; 0, 3: No effect on counter (R/W)

PCNT_CH0_HCTRL_MODE_U_n This register configures how the CH_n_POS_MODE/CH_n_NEG_MODE settings will be modified when the control signal is high.

0: No modification; 1: Invert behavior (increase -> decrease, decrease -> increase); 2, 3: Inhibit counter modification (R/W)

Continued on the next page...

Register 38.1. PCNT_UN_CONF0_REG ($n: 0-3$) (0x0000+0xC*n)

Continued from the previous page...

PCNT_CH0_LCTRL_MODE_UN This register configures how the CH n _POS_MODE/CH n _NEG_MODE settings will be modified when the control signal is low.

0: No modification; 1: Invert behavior (increase -> decrease, decrease -> increase); 2, 3: Inhibit counter modification (R/W)

PCNT_CH1_NEG_MODE_UN This register sets the behavior when the signal input of channel 1 detects a negative edge.

1: Increment the counter; 2: Decrement the counter; 0, 3: No effect on counter (R/W)

PCNT_CH1_POS_MODE_UN This register sets the behavior when the signal input of channel 1 detects a positive edge.

1: Increment the counter; 2: Decrement the counter; 0, 3: No effect on counter (R/W)

PCNT_CH1_HCTRL_MODE_UN This register configures how the CH n _POS_MODE/CH n _NEG_MODE settings will be modified when the control signal is high.

0: No modification; 1: Invert behavior (increase -> decrease, decrease -> increase); 2, 3: Inhibit counter modification (R/W)

PCNT_CH1_LCTRL_MODE_UN This register configures how the CH n _POS_MODE/CH n _NEG_MODE settings will be modified when the control signal is low.

0: No modification; 1: Invert behavior (increase -> decrease, decrease -> increase); 2, 3: Inhibit counter modification (R/W)

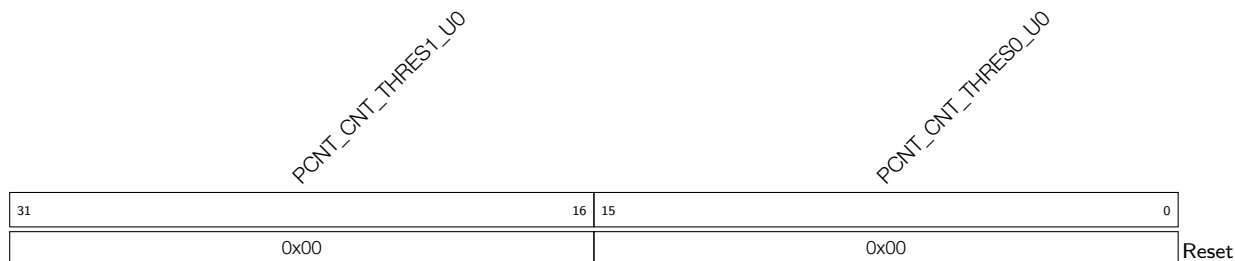
Register 38.2. PCNT_UN_CONF1_REG ($n: 0-3$) (0x0004+0xC*n)

PCNT_CNT_THRES0_UN This register is used to configure the thres0 value for unit n . (R/W)

PCNT_CNT_THRES1_UN This register is used to configure the thres1 value for unit n . (R/W)

Register 38.7. PCNT_INT_RAW_REG (0x0040)

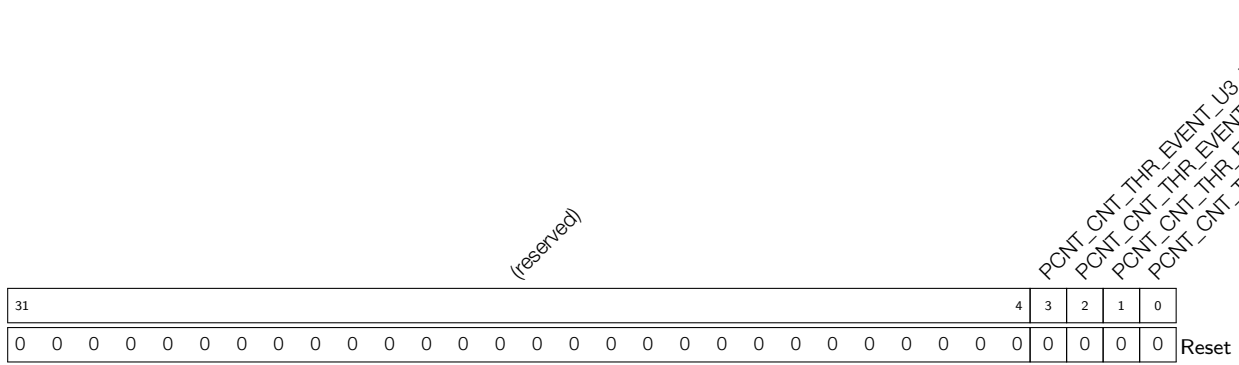

PCNT_CNT_THR_EVENT_U n _INT_RAW The raw interrupt status bit for the PCNT_CNT_THR_EVENT_U n _INT interrupt. (RO)

Register 38.8. PCNT_INT_ST_REG (0x0044)

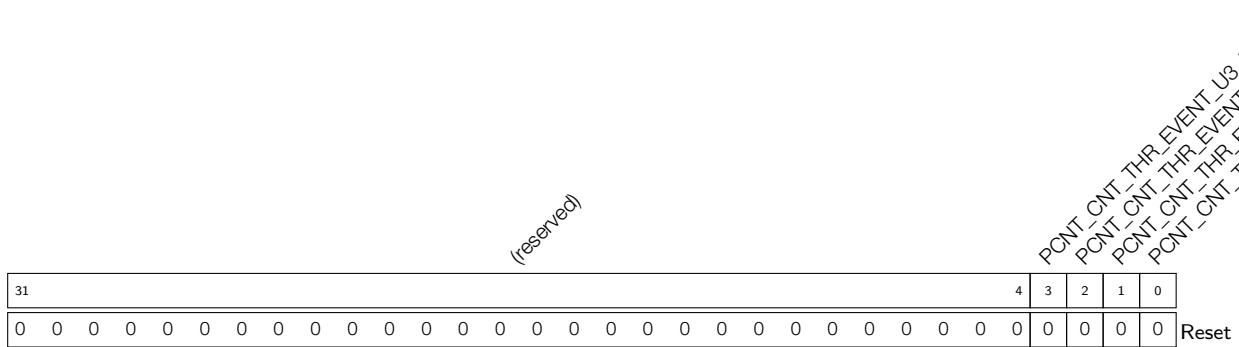

PCNT_CNT_THR_EVENT_U n _INT_ST The masked interrupt status bit for the PCNT_CNT_THR_EVENT_U n _INT interrupt. (RO)

Register 38.9. PCNT_INT_ENA_REG (0x0048)

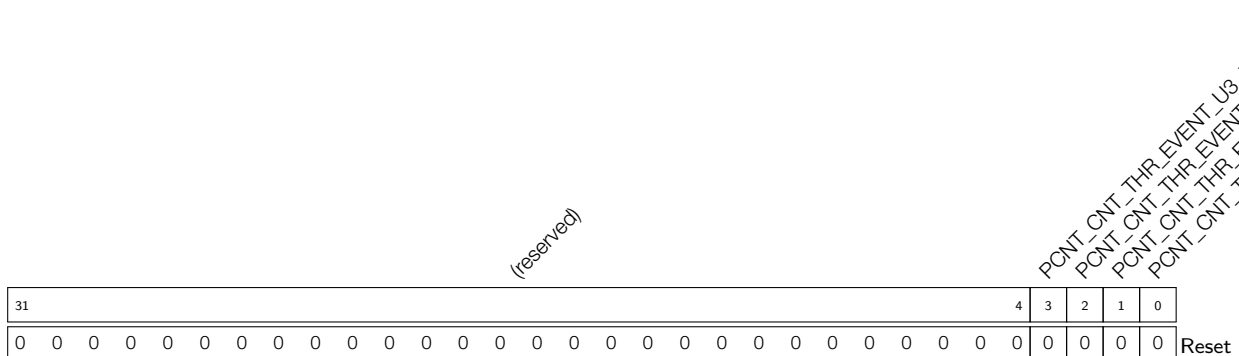

PCNT_CNT_THR_EVENT_U n _INT_ENA The interrupt enable bit for the PCNT_CNT_THR_EVENT_U n _INT interrupt. (R/W)

Register 38.10. PCNT_INT_CLR_REG (0x004C)

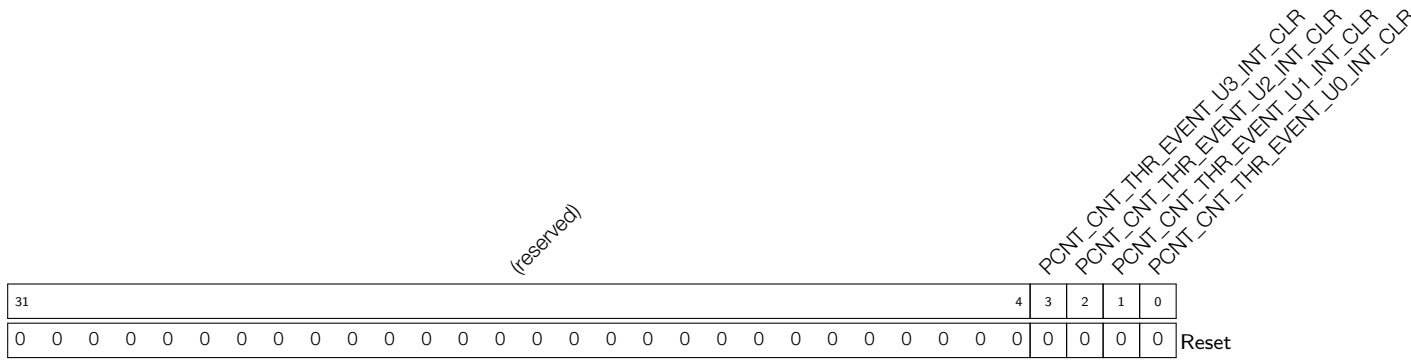

PCNT_CNT_THR_EVENT_U_nINT_CLR Set this bit to clear the PCNT_CNT_THR_EVENT_U_nINT interrupt. (WO)

Register 38.11. PCNT_DATE_REG (0x00FC)

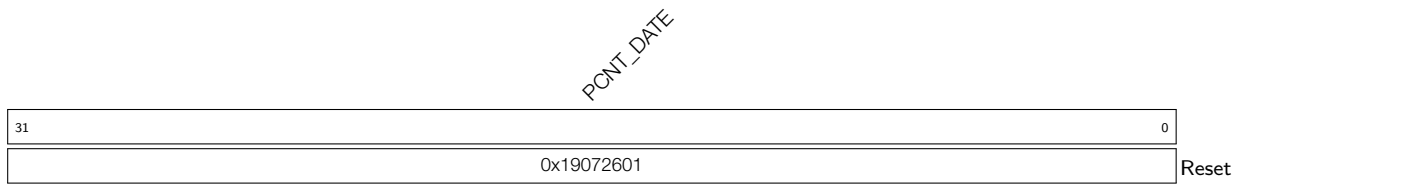

PCNT_DATE This is the PCNT version control register. (R/W)

39 On-Chip Sensors and Analog Signal Processing

39.1 Overview

ESP32-S3 provides the following on-chip sensors and signal processing peripherals:

- Fourteen [capacitive touch sensors](#) that can be used to detect finger touches from 14 channels. The touch sensors can also be configured to be moisture tolerant, and support Water Rejection capabilities. A proximity sensing mode is also supported.
- One temperature sensor for measuring the internal temperature of the ESP32-S3 chip.
- Two 12-bit Successive Approximation ADCs (SAR ADCs) controlled by five dedicated controllers that can input analog signals from total of 20 channels. The SAR ADCs can operate in a high-performance mode or a low-power mode.

39.2 Capacitive Touch Sensors

39.2.1 Terminology

To better illustrate the functions of capacitive touch sensors, the following terms are used in this section.

- Touch pin: GPIO pins provided by ESP32-S3 with touch sensing feature.
- Touch sensor: touch-related internal sensing circuitry integrated in ESP32-S3.
- Touch panel: the external device connected to touch sensor via channel (touch pin) to detect finger touch.
- Touch sensor system: ESP32-S3 capacitive touch sensing system, consisting of touch sensor, touch pin, traces, and touch panel.

Note:

In subsequent description, “touch panel is sampled/scanned/measured” indicates the same action to touch pin, i.e. “touch pin is sampled/scanned/measured”.

39.2.2 Overview

ESP32-S3 provides built-in touch sensors, which can be connected to external touch panel via touch pin (GPIO pin) to constitute a touch sensor system. Such system can be applied in human-computer interaction scenarios to detect finger touch or proximity.

A touch panel consists of the following components:

- An electrode that will have a change in capacitance when touched by a finger.
- Substrate (base material) on which the protective cover, electrode, and the electrode’s connector to the channel are built.
- A protective cover to physically separate the other components from the external environment.

When developing applications using the touch sensing feature, users should decide on the placement, the material, or the arrangement of the touch panel(s) during mechanical design. For more information about the design guidelines, please refer to [Touch Sensor Application Note](#).

Touch panel can be connected to ESP32-S3 touch sensor via touch pin (channel), see Figure 39-1.

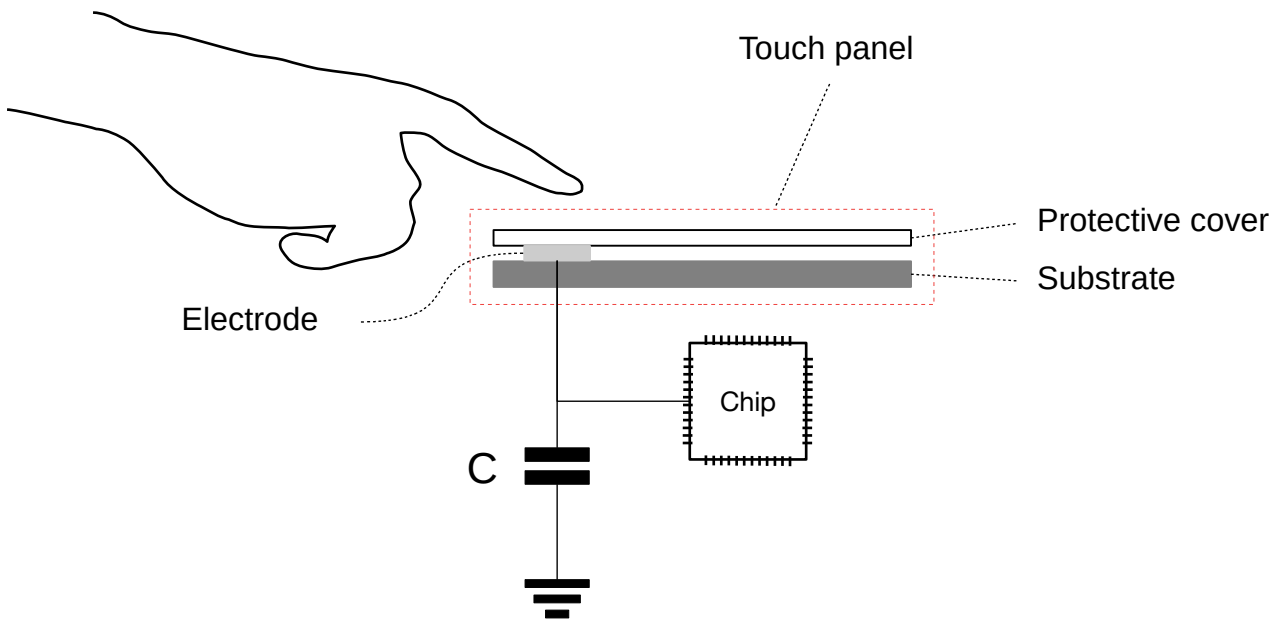

Figure 39-1. Touch Sensor

When users touch the protective cover, the capacitance of the electrode will increase. If the electrode is connected to one of the ESP32-S3 touch sensors (via a channel), the touch sensor will be able to detect the electrode's change in capacitance. If the change of capacitance exceeds a certain threshold (configurable), the touch sensor can trigger an interrupt.

39.2.3 Features

- 14 touch sensors (T1 ~ T14) each with a dedicated channel that can be connected to an external touch panel. An additional touch sensor (T0) that does not have a channel is provided for noise detection purposes (see Section 39.2.8).
- The touch sensors are controlled by a Touch Finite State Machine (Touch FSM). The Touch FSM can be triggered by software or a dedicated hardware timer to conduct a measurement (i.e., take a sample) on a particular touch pin.
- The Touch FSM can be configured to measure multiple touch pins in a sequential manner (scan). Scanning can be useful when multiple touch pins need to be monitored simultaneously.
- Up to three channels can be configured with proximity mode.
- To determine whether a touch pin has been touched, the following touch-detection methods are supported:
 - Polling of touch sensor samples via software.
 - Built-in hardware algorithm.
- Touch sensors can operate whilst the CPU is in sleep mode.
- Support ESP32-S3 low-power operation in the following scenarios:
 - Touch pins can be configured as a wakeup source when the CPU is in Deep-sleep (see [RTC_CNTL_TOUCH_SLP_PAD](#)).

- Touch pins can be controlled by the ULP coprocessor. The ULP coprocessor can be programmed to scan multiple touch pins. If a particular touch threshold is reached, the ULP coprocessor can wake up the main CPU.
- Moisture tolerance (mitigate the effect of small water droplets).
- Water Rejection (detect if the sensor array surface is covered in water and trigger a shut down).
- Support internal noise filtering

Note:

ESP32-S3 Touch Sensor has not passed the Conducted Susceptibility (CS) test for now, and thus has limited application scenarios.

39.2.4 Capacitive Touch Pins

ESP32-S3 provides 14 capacitive touch sensors (T1 ~ T14), each of which is connected to the chip's pin to monitor finger touch from the external environment. T0 is not connected to the external environment, and is used to detect noise inside the chip (see section 39.2.8). The touch sensor to chip pin mappings are shown in Table 39-1.

Table 39-1. ESP32-S3 Capacitive Touch Pins

Touch Sensing Signal	Pin
T0	Internal channel, not connect to a GPIO
T1	GPIO1
T2	GPIO2
T3	GPIO3
T4	GPIO4
T5	GPIO5
T6	GPIO6
T7	GPIO7
T8	GPIO8
T9	GPIO9
T10	GPIO10
T11	GPIO11
T12	GPIO12
T13	GPIO13
T14	GPIO14

39.2.5 Touch Sensors Operating Principle and Signals

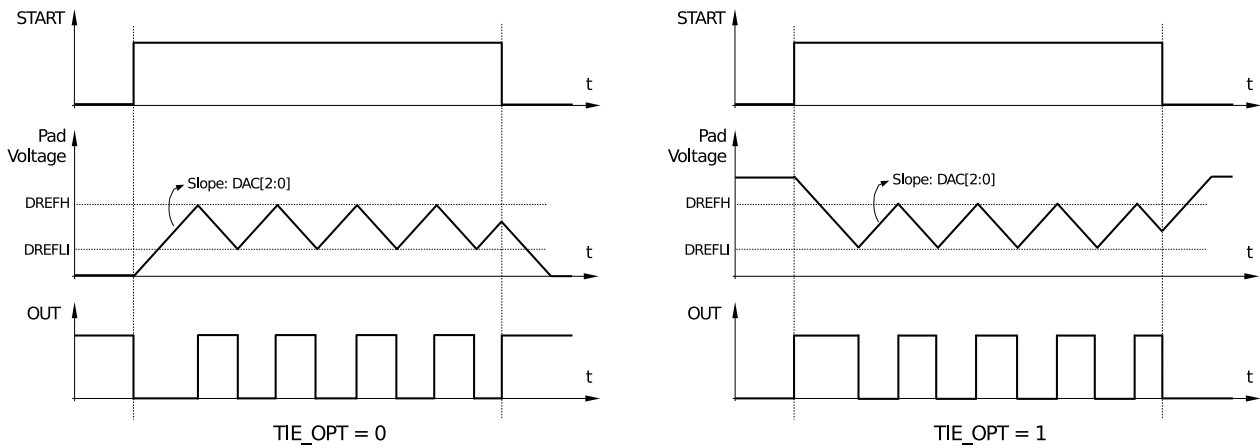

Figure 39-2. Touch Sensor Operating Principle

Figure 39-2 illustrates the operating principle of a touch sensor. When a touch pin is touched (or positioned proximate to finger), the capacitance of the touch pin will increase. A touch sensor is able to detect a change in capacitance of a touch pin.

To measure a change in capacitance in the touch pin, a touch sensor will rapidly charge and discharge the touch pin between a high and low voltage (named “DREFH” and “DREFL” respectively) using a fixed current source. If the touch pin is touched, the touch pin’s capacitance will increase thus will take longer to charge and discharge. By measuring the time taken to charge/discharge the touch pin a fixed number of cycles, it can be deduced whether the touch pin is touched or not.

Each touch sensor will output an “OUT” signal that consists of pulses generated on each voltage swing. A single measurement primarily consists of a touch sensor charging/discharging the touch pin a fixed “N” cycles, and measuring the time taken for “OUT” signal to generate “N” pulses.

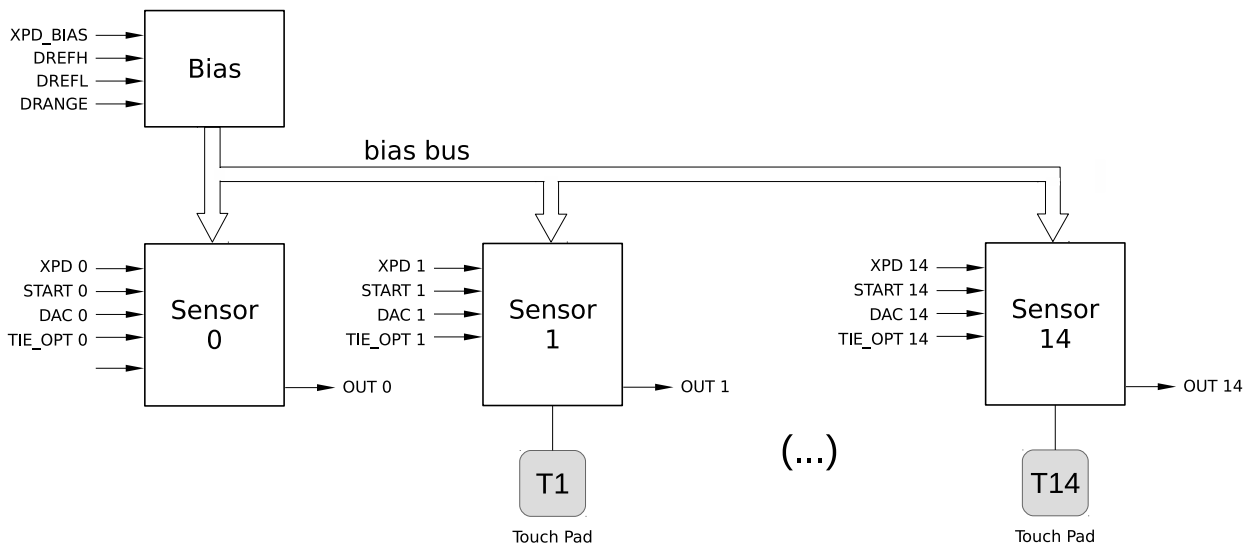

Figure 39-3. Touch Sensor Structure

Figure 39-3 illustrates the internal structure of the touch sensors. Each of the touch sensors has a set of

input/output signals, some of which are connected to the Touch FSM (see section 39.2.6).

- The “START” signal is generated by the Touch FSM to control a touch sensor to start a measurement. A measurement ends when the Touch FSM de-asserts the “START” signal.
- The “OUT” signal is output by a touch sensor to the Touch FSM. The Touch FSM will count the number of pulses in the “OUT” signal, and measure the time taken for N pulses to occur.
- The “TIE_OPT” signal controls a touch sensor’s initial voltage level in a measurement (DREFH or DREFL). “TIE_OPT” is sourced from `RTCIO_TOUCH_PADn_TIE_OPT`.
- The “DAC” signal controls charge/discharge speed (slope), which can be configured in `RTC_CNTL_TOUCH_PADn_DAC`.
- The “XPD” signal controls touch sensor power on, and can be configured in `RTCIO_TOUCH_PADn_XPD`.

39.2.6 Touch FSM

The Touch FSM is responsible for carrying out a measurement by selecting a touch sensor, and controlling the necessary signals to/from a touch sensor. Figure 39-4 shows the Touch FSM’s internal structure. The Touch FSM is clocked by the `RTC_FAST_CLK`. For more information about the `RTC_FAST_CLK`, see Chapter 7 *Reset and Clock*.

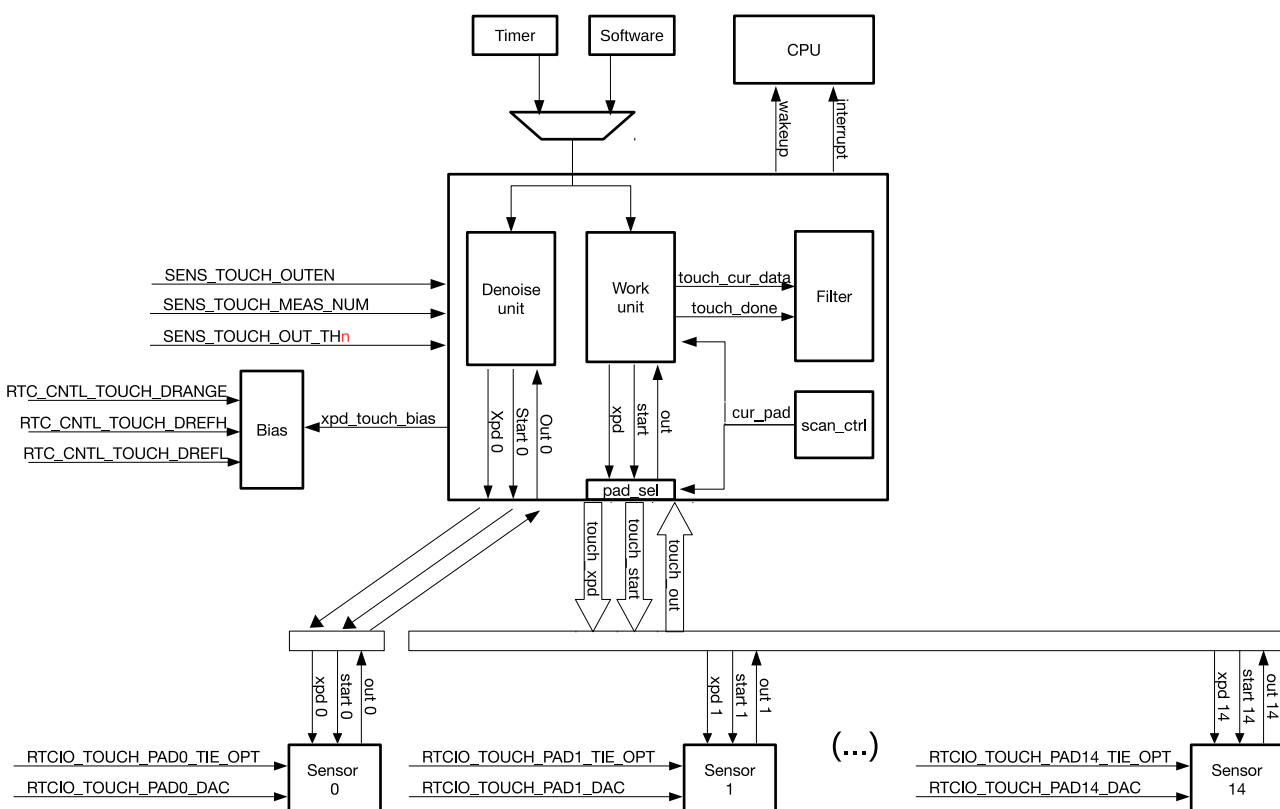

Figure 39-4. Touch FSM Structure

The following points describe the various modules of the Touch FSM.

- `SCAN_CTRL`: selects the touch pin to measure when in scan mode.
- `WORK_UNIT`: drives a selected touch pin during a measurement.

- **DENOISE_UNIT**: has a nearly identical structure to the **WORK_UNIT**, but is connected to an internal touch sensor (T0). The measurements from T0 can be used by the other touch sensors to correct for noise (see section 39.2.8).
- **Filter module**: if enabled, each touch sensor can filter a series of measurements via an infinite impulse response (IIR) filter. The filtered value will be returned as the sampled value instead (see section 39.2.7.1).

39.2.6.1 Measurement Process

A single measurement of a touch pin involves the following process:

1. The Touch FSM selects the touch sensor to be measured. The relevant signals are routed to that touch sensor.
2. The Touch FSM drives the “START” signal to the touch sensor initiating the measurement. Internally, the Touch FSM starts an internal “touch counter” to time the duration of the measurement.
3. A “pulse counter” in the Touch FSM will increment on each pulse received from the touch sensor’s “OUT” signal.
4. When the pulse counter reaches the count threshold set in **RTC_CNTL_TOUCH_MEAS_NUM**, the measurement is complete. The “START” signal is de-asserted, and the touch counter is stopped. The value of the stopped touch counter indicates the time taken to charge/discharge the touch pin **RTC_CNTL_TOUCH_MEAS_NUM** number of cycles.

The sampled value (result of the measurement) is the value of the touch counter, and is referred to as “touch_raw_data”. “touch_raw_data” can be read from **SENS_TOUCH_PAD_n_DATA**. However, depending on the configuration of **SENS_TOUCH_DATA_SEL**, the value returned by **SENS_TOUCH_PAD_n_DATA** could also be filtered versions of “touch_raw_data” (namely “touch_smooth_data” and “benchmark”). See section 39.2.7.1 for details regarding the various types of sample values, and how they are used to detect a touch.

Note: If the pulse counter does not reach its count threshold after a prolonged period of time, the touch counter will reach the timeout threshold set in **RTC_CNTL_TOUCH_TIMEOUT_NUM**. This will trigger a **TOUCH_TIME_OUT_INT** timeout interrupt and indicates a circuit exception.

39.2.6.2 Measurement Trigger Source

The Touch FSM initiates a measurement by sending a “START” signal. This “START” signal can either be triggered by software, or by a dedicated hardware timer known as the “touch timer”. Using the touch timer allows for measurements to be conducted periodically without software intervention.

The touch timer is clocked by **RTC_SLOW_CLK** and should be configured with a period (in number of **RTC_SLOW_CLK** cycles). The “START” signal will be generated when the touch timer expires. When the measurement completes, the touch timer will be reset and begin counting towards the next expiry time.

- To configure the “START” signal to be triggered by software:
 - Set **RTC_CNTL_TOUCH_START_FORCE**.
 - Once configured, setting **RTC_CNTL_TOUCH_START_EN** by software will generate the “START” signal to initiate a measurement.
- To configure the “START” signal to be triggered by the touch timer:

- Clear `RTC_CNTL_TOUCH_START_FORCE`.
- Configure the touch timer's period (in `RTC_SLOW_CLK`) cycles in `RTC_CNTL_TOUCH_SLEEP_CYCLES`.
- Set `RTC_CNTL_TOUCH_SLP_TIMER_EN` to enable the touch timer.

39.2.6.3 Scan Mode

Scan mode involves the Touch FSM taking measurements of multiple touch sensors in sequential order. On every “START” signal, a new touch sensor is selected for measurement, thus allowing multiple touch pins to be monitored. The scan process is illustrated in Figure 39-5.

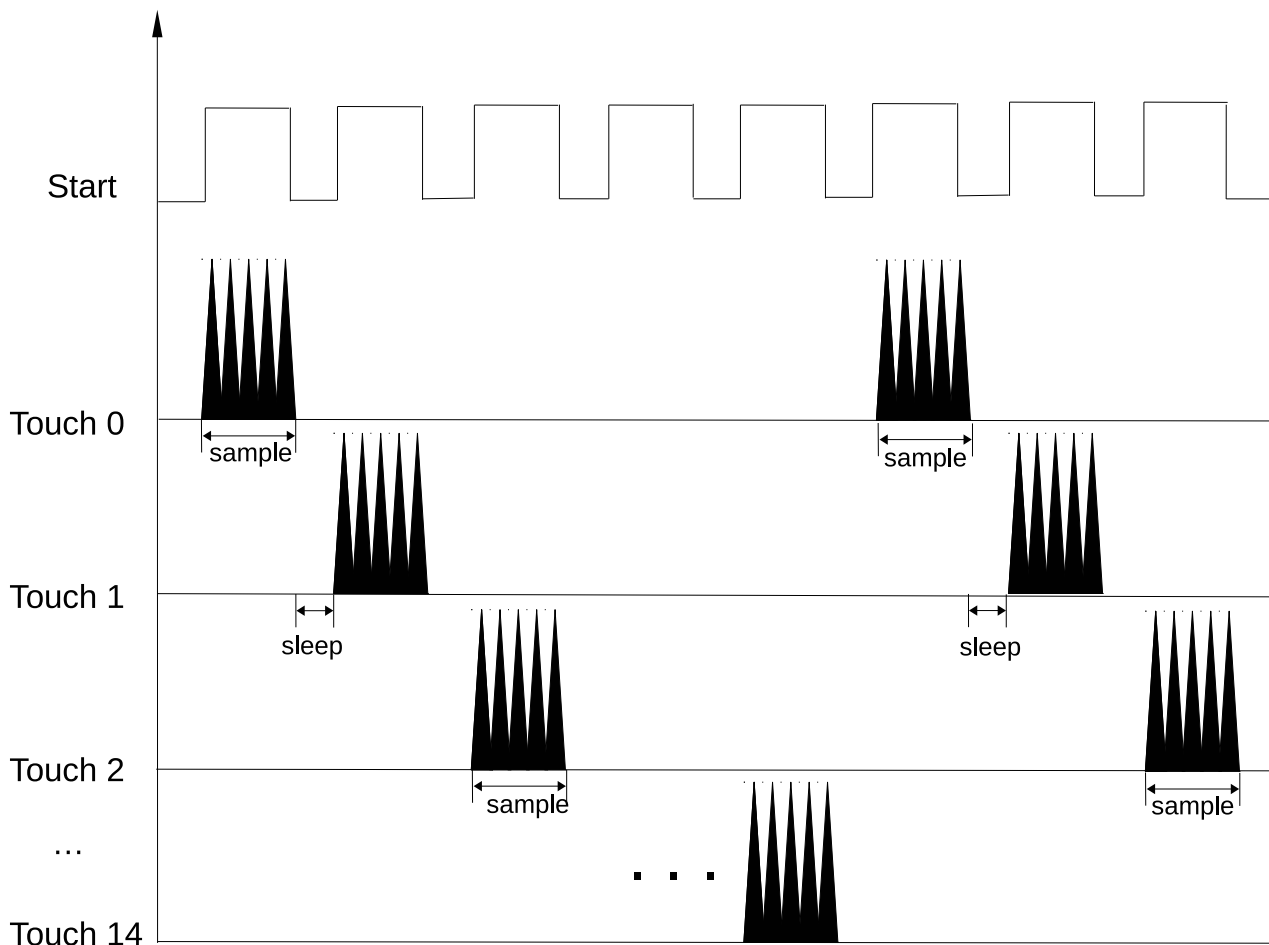

Figure 39-5. Timing Diagram of Touch Scan

To enable scan mode, specify the bit map of enabled touch pins in `RTC_CNTL_TOUCH_SCAN_PAD_MAP`. The Touch FSM will select one touch pin from the bit map of enabled touch pins in turn to measure per “START” signal (i.e., only one measurement is conducted per “START” signal). Over multiple “START” signals, the Touch FSM will cycle through the enabled touch pins in sequential order.

Note that if the touch timer is used to generate the “START” signal, then the scanning can be conducted without software intervention.

39.2.7 Touch Detection

39.2.7.1 Sampled Values

As described in section 39.2.6.1, the sampled value of a measurement can be read from `SENS_TOUCH_PAD n _DATA`. However, the type of sampled value stored in `SENS_TOUCH_PAD n _DATA` is dependent on the configuration of `SENS_TOUCH_DATA_SEL`. The following types of sampled values are supported:

touch_raw_data is the value of the touch counter at the end of the measurement, and indicates the time taken (in `RTC_SLOW_CLK` cycles) to charge/discharge the touch pin a fixed number of times.

touch_smooth_data is generated by inputting a series of `touch_raw_data` values from a single touch sensor through an IIR filter (moving average). `touch_smooth_data` is less prone to noise spikes or outlier samples, thus is the value used for hardware touch detection. The IIR filter that generates `touch_smooth_data` is configured via `RTC_CNTL_TOUCH_SMOOTH_LVL` (see Table 39-2).

benchmark is also generated from `touch_raw_data` values through an IIR filter. However, the moving average window for benchmark is much wider. Thus, benchmark value is intended to represent the stable reading of a touch pin without the effect from a touch action. The IIR filter that generates benchmark is configured via `RTC_CNTL_TOUCH_FILTER_MODE` (see Table 39-3).

Table 39-2. Smooth Algorithm

<code>RTC_CNTL_TOUCH_SMOOTH_LVL</code>	TYPE	FORMULA
0	-	<code>touch_raw_data</code>
1	IIR 1/2	$1/2 \text{ touch_raw_data} + 1/2 \text{ touch_smooth_data}$
2	IIR 1/4	$1/4 \text{ touch_raw_data} + 3/4 \text{ touch_smooth_data}$
3	IIR 1/8	$1/8 \text{ touch_raw_data} + 7/8 \text{ touch_smooth_data}$

Table 39-3. Benchmark Algorithm

<code>RTC_CNTL_TOUCH_FILTER_MODE</code>	TYPE	FORMULA
0	IIR 1/2	$1/2 \text{ touch_raw_data} + 1/2 \text{ benchmark}$
1	IIR 1/4	$1/4 \text{ touch_raw_data} + 3/4 \text{ benchmark}$
2	IIR 1/8	$1/8 \text{ touch_raw_data} + 7/8 \text{ benchmark}$
3	IIR 1/16	$1/16 \text{ touch_raw_data} + 15/16 \text{ benchmark}$
4	IIR 1/32	$1/32 \text{ touch_raw_data} + 31/32 \text{ benchmark}$
5	IIR 1/64	$1/64 \text{ touch_raw_data} + 63/64 \text{ benchmark}$
6	IIR 1/128	$1/128 \text{ touch_raw_data} + 127/128 \text{ benchmark}$
7	JITTER	<code>touch_raw_data</code> +/- <code>RTC_CNTL_TOUCH_JITTER_STEP</code>

39.2.7.2 Hardware Touch Detection

Hardware touch detection can detect the conditions of touch or release, and trigger an interrupt. This removes the need to specify a software algorithm for touch detection and constantly poll for samples.

Hardware touch detection requires a **finger_threshold** and **active_noise_threshold** to be defined. When touch_

smooth_data exceeds or falls short of these values the finger_threshold plus or minus **hysteresis**, a touch interrupt will be triggered. Both finger_threshold and active_noise_threshold are defined as offsets with respect to benchmark rather than an absolute threshold. This prevents the detection of false touches due to a gradual drift of touch_raw_data (which can be caused by various environmental factors such as temperature, power supply, or noise).

- finger_threshold is configured via [SENS_TOUCH_OUT_TH \$n\$](#) .
- active_noise_threshold is configured via [RTC_CNTL_TOUCH_NOISE_THRES](#), see Table 39-4.
- hysteresis is configured via [RTC_CNTL_TOUCH_CONFIG3](#), see Table 39-5.

Table 39-4. Noise Algorithm

RTC_CNTL_TOUCH_NOISE_THRES	FORMULA
0	4/8 finger_threshold
1	3/8 finger_threshold
2	2/8 finger_threshold
3	1/8 finger_threshold

Table 39-5. Hysteresis Algorithm

RTC_CNTL_TOUCH_CONFIG3	FORMULA
0	1/8 finger_threshold
1	3/32 finger_threshold
2	1/32 finger_threshold
3	0

39.2.8 Noise Detection

Touch sensor 0 is not connected to any GPIO (i.e., not connected to an external touch panel). Therefore, any fluctuations in the capacitance measured by touch sensor 0 will represent the internal noise. The Noise Detection feature allows touch sensor 0 to be used as a noise reference. When touch sensor N (1 ~ 14) takes a measurement, touch sensor 0 will simultaneously measure as well. The sampled value of touch sensor 0 can be subtracted from the sampled value of touch sensor N automatically to decrease the effect of noise.

The following points describe the Noise Detection feature:

- Configure the drive strength of touch sensor 0 by adjusting its reference capacitance via [RTC_CNTL_TOUCH_REFC](#).
- Set [RTC_CNTL_TOUCH_DENOISE_EN](#) to 1. Once set, when another touch sensor N starts a measurement, touch sensor 0 will start a measurement simultaneously.
- The final sampled value will be $DATA(TOUCH[N]) - DATA(TOUCH0)$. $DATA(TOUCH[N])$ is the value sampled by touch sensor N, and $DATA(TOUCH0)$ are the least significant bits of the value sampled by touch sensor 0. $DATA(TOUCH0)$ can be 12/10/8/4 bits of the sampled value of touch sensor 0, depending on the configuration of [RTC_CNTL_TOUCH_DENOISE_RES](#).

39.2.9 Proximity Mode

When an object (e.g., a finger) is placed proximate (but not touching) a touch pin, a small change in capacitance will occur on the touch pin (much smaller compared to a physical touch). Proximity mode allows for the detection of these small changes.

- The maximum detection distance (d) is 16 cm with a sensing area of 20 cm² (S), where d is positively correlated with S as shown in Figure 39-6.
- Up to three touch pins can be configured to operate in proximity mode.

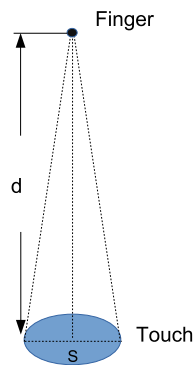

Figure 39-6. Sensing Area

When operating in proximity mode, a touch sensor will take a fixed number of samples and accumulate those sampled values. If the final accumulated value exceeds a configured threshold, this indicates the detection of a proximate object and an interrupt will be triggered. Note that due to the accumulation of samples, a touch sensor operating in proximity mode will not generate the same values mentioned in section 39.2.7.1 (i.e., touch_raw_data, touch_smooth_data, and benchmark).

To operate in proximity mode:

- Configure a touch sensor to operate in proximity mode by setting `SENS_TOUCH_APPROACH_PAD0`, `SENS_TOUCH_APPROACH_PAD1`, or `SENS_TOUCH_APPROACH_PAD2`.
- Set `RTC_CNTL_TOUCH_APPROACH_MEAS_TIME` to adjust the number of samples taken to generate the accumulated value. The touch sensor maintains an internal sample counter to track the number of samples taken.
- Set the threshold value via `SENS_TOUCH_OUT_TH n` .
- When the sample counter reaches `RTC_CNTL_TOUCH_APPROACH_MEAS_TIME`:
 - If the accumulated value is larger than the threshold value, an interrupt will be triggered.
 - The sample counter and the accumulated value are reset to 0. The touch sensor will begin accumulating samples again.

39.2.10 Moisture Tolerance and Water Rejection

The presence of water droplets can lead to the detection of false touches. The **Moisture tolerance** feature can mitigate the effect of water droplets.

If the sensor array becomes wet (i.e., the majority of the sensor array is covered by water), the touch pads will no longer be able to detect finger touches. The **Water Rejection** feature can detect if the sensor array is wet and shut down the sensor array.

39.2.10.1 Moisture Tolerance

The presence of water droplets on the touch pads can cause adjacent touch pads to be electrically coupled (if the water droplets are large enough to physically bridge two more adjacent touch pads). Coupled touch pads will lead to the false detection of touches due to the capacitance caused by the coupling.

To configure moisture tolerance:

- Set the drive strength of touch sensor 14 by [RTC_CNTL_TOUCH_BUFDRV](#).
- Enable touch sensor 14 to be used for moisture tolerance feature by setting [RTC_CNTL_TOUCH_SHIELD_PAD_EN](#).

39.2.10.2 Water Rejection

When the sensor array becomes wet, most (if not all) of the touch pads will become unusable due to the false detection of touches.

Configure [RTC_CNTL_TOUCH_OUT_RING](#) to select one of the touch pads to be used for water rejection feature.

39.3 SAR ADCs

39.3.1 Overview

ESP32-S3 integrates two 12-bit SAR ADCs, which are able to measure analog signals from up to 20 pins. It is also possible to measure internal signals. See Figure [39-7](#).

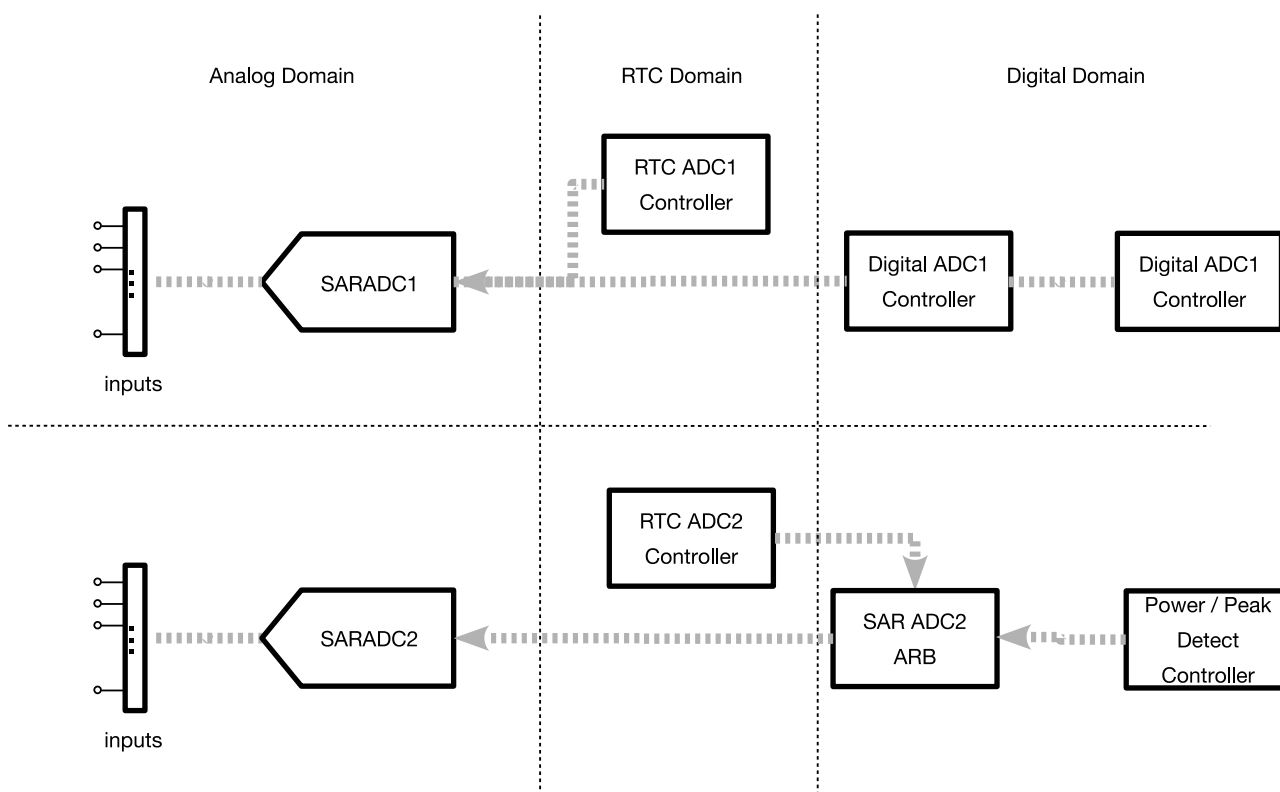

Figure 39-7. SAR ADC Overview

As shown in Figure 39-7, the SAR ADCs are managed by four dedicated controllers:

- One digital controller: digital ADC1 controller (DIG ADC1 controller), designed for high-performance multi-channel scanning and DMA continuous conversion.
- Two RTC controllers: RTC ADC1 controller and RTC ADC2 controller, designed for single conversion mode and low power mode.
- One internal controller: Power/Peak Detect Controller (PWDET controller), designed to monitor RF power. Note this controller is only for RF internal use.

Note:

The DIG ADC2 controller of ESP32-S3 doesn't work properly and related information has been deleted in this chapter. For more information, please refer to [ESP32-S3 Series SoC Errata](#).

39.3.2 Features

The SAR ADC module has the following features:

- Each SAR ADC controller has its own ADC Reader module. See Figure 39-8.
- Support DIG ADC1 controller and RTC ADC1 controller to get the control of SAR ADC1 via software.
- Support RTC ADC2 controller and PWDET controller to get the control of SAR ADC2 by the specified arbitration method via the arbiter.
- Support 12-bit sampling resolution

- Support sampling the analog voltages from up to 20 pins
- RTC ADC1/2 controllers, with the following features:
 - Support single conversion mode
 - Support working in low power mode, such as in Deep-sleep mode
 - Configurable by the ULP coprocessor
- DIG ADC1 controller, with the following features:
 - Support multi-channel scanning
 - Provide a mode control module, supporting single SAR ADC sampling mode
 - Configurable scanning sequence in multi-channel scanning mode
 - Provide two filters with configurable coefficient
 - Support threshold monitoring. An interrupt will be triggered when the sampled value is greater than the pre-set high threshold or less than the pre-set low threshold.
 - Support DMA
- PWDET controller: monitor RF power. Note this controller is only for RF internal use.

39.3.3 SAR ADC Architecture

The major components of SAR ADCs and their interconnections are shown in Figure 39-8.

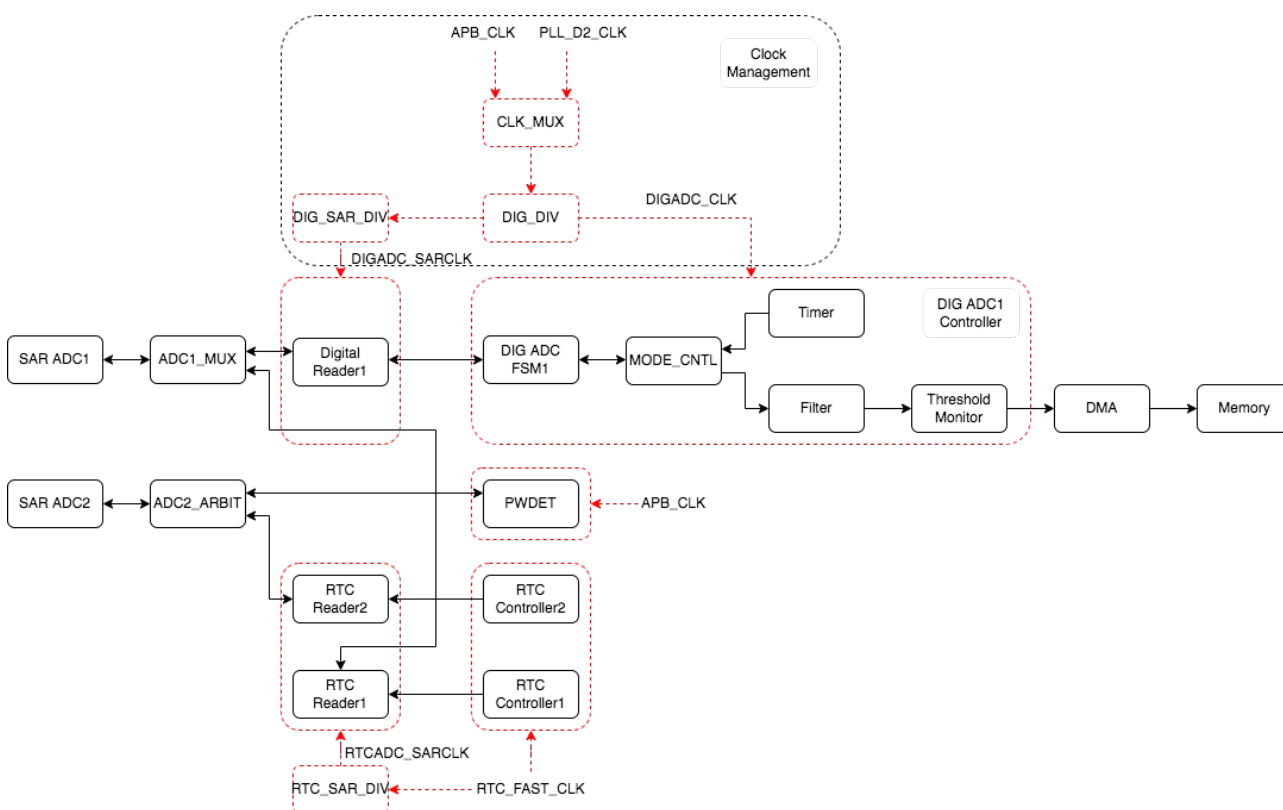

Figure 39-8. SAR ADC Architecture

- -->: clock signals
- : clock divider, clock mux, and the blocks the clock works for

As shown in Figure 39-8, the SAR ADC module consists of the following components:

- SAR ADC1: measures voltages from up to 10 channels.
- SAR ADC2: measures the voltage from 10 channels, or measures the internal signal.
- Clock management: selects clock sources and their dividers:
 - Clock sources of DIG ADC1 controller: APB_CLK or PLL_D2_CLK
 - Divided clocks of DIG ADC1 controller:
 - * DIGADC_SARCLK: operating clock for SAR ADC1, SAR ADC2, and Digital Reader1. Note that the divider (DIG_SAR_DIV) must be no less than 2, and the frequency of DIGADC_SARCLK must not exceed 5 MHz. See [APB_SARADC_SAR_CLK_DIV](#).
 - * DIGADC_CLK: operating clock for DIG ADC FSM1.
 - Clock source of RTC ADC1/2 controllers: RTC_FAST_CLK
 - Divided clock of RTC ADC1/2 controllers:
 - * RTCADC_SARCLK: operating clock for SAR ADC1, SAR ADC2, RTC Reader1, and RTC Reader2. Note that the divider (RTC_SAR_DIV) must be no less than 2, and the frequency of RTCADC_SARCLK must not exceed 5 MHz.
- Arbiter (ADC2_ARBIT): this arbiter determines which controller is selected as the RTC ADC2 controller or PWDET controller. The arbiter also selects working clock for SAR ADC2 according to the authorized controller.
- Timer: the dedicated timer for DIG ADC1 controller, to initiate a sampling enable signal.
- DIG ADC FSM1: is used to
 - receive the sampling enable signal from the timer.
 - generate ADC configuration according to the pattern table.
 - drive the Digital Reader1 module to read ADC sampling value.
 - transfer the sampling value to the filter, and then to memory.
- Filter: the filter0/1 will automatically filter the sampled ADC data for the configured channel.
- Threshold Monitor: the monitor0/1 will trigger a interrupt when the sampled value is greater than the pre-set high threshold or less than the pre-set low threshold.
- Mode control (MODE CNTL): filter the sampling signals triggered by the timer, supporting single SAR-ADC sampling.
- Digital Reader1 (driven by DIG ADC FSM1): reads data from SAR ADC1.
- RTC Controller1/2: provides sampling enable signal, drives the RTC Reader1/2 to read the sampling values from ADC, then stores the sampling data to memory.
- RTC Reader1/2 (driven by RTC Controller1/2): reads data from SAR ADC1/2.

39.3.4 Input Signals

In order to sample an analog signal, an SAR ADC must first select the analog pin or internal signal to measure via an internal multiplexer. A summary of all the analog signals that may be sent to the SAR ADC1 or SAR ADC2 for processing are presented in Table 39-6.

Table 39-6. SAR ADC Input Signals

Pin/Signal	Channel	ADC Selection
GPIO1	0	SAR ADC1
GPIO2	1	
GPIO3	2	
GPIO4	3	
GPIO5	4	
GPIO6	5	
GPIO7	6	
GPIO8	7	
GPIO9	8	
GPIO10	9	
GPIO11	0	SAR ADC2
GPIO12	1	
GPIO13	2	
GPIO14	3	
GPIO15	4	
GPIO16	5	
GPIO17	6	
GPIO18	7	
GPIO19	8	
GPIO20	9	
Internal voltage	n/a	

39.3.5 ADC Conversion and Attenuation

When the SAR ADCs convert an analog voltage, the resolution (12-bit) of the conversion spans voltage range from 0 mV to V_{ref} . V_{ref} is the SAR ADC's internal reference voltage. The output value of the conversion (data) is mapped to analog voltage V_{data} using the following formula:

$$V_{data} = \frac{V_{ref}}{4095} \times data$$

In order to convert voltages larger than V_{ref} , input signals can be attenuated before being input into the SAR ADCs. The attenuation can be configured to 0 dB, 2.5 dB, 6 dB, and 12 dB.

39.3.6 RTC ADC Controller

The RTC ADC1/2 controllers are powered in the RTC power domain, thus allow the SAR ADCs to conduct measurements at a low frequency with minimal power consumption. The overview of a single RTC ADC controller's function is shown in Figure 39-9.

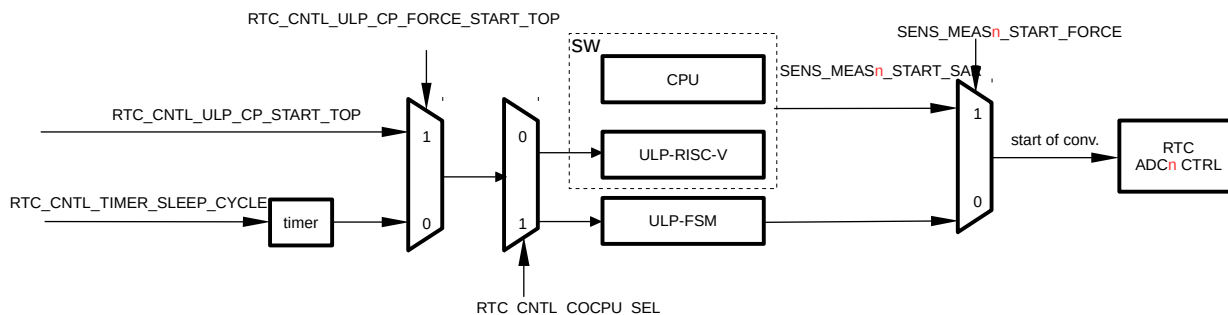

Figure 39-9. RTC ADC Controller Overview

Conversion is triggered by `SENS_SAR_MEAS n _START_SAR`, and then the conversion result is stored to `SENS_SAR_MEAS n _DATA_SAR`.

The RTC ADC1/2 controllers are intertwined with the ULP coprocessor, as the ULP coprocessor has a built-in instruction to start an ADC conversion. In many cases, the controllers need to cooperate with the ULP coprocessor, e.g.:

- When the controllers periodically monitor a channel during Deep-sleep, ULP coprocessor is the only source to trigger ADC sampling by configuring RTC registers.
- Continuous scanning or DMA is not supported by the controllers. However, it is possible with the help of ULP coprocessor to scan channels continuously in a sequence.

There are two ways to set the sampling channels:

- Configure `SENS_SAR1/2_EN_PAD` to select sampling channels.
- If the ULP instruction is used to trigger a sampling, clear `SENS_SAR1/2_EN_PAD_FORCE`, to enable sampling channels by ULP instruction.

39.3.7 DIG ADC Controller

The clock of the DIG ADC1 controller is quite fast, thus the sample rate is high. For more information, see Section ADC Characteristics in [ESP32-S3 Series Datasheet](#).

The DIG ADC1 controller support:

- up to 12-bit sampling resolution
- timer-triggered multi-channel scanning

To use this timer-triggered multi-channel scanning, follow the configuration below. Note that in this mode, the scan sequence is performed according to the configuration in pattern table.

- Configure `APB_SARADC_TIMER_TARGET` to set the trigger target for DIG ADC timer. When the timer counting reaches two times of the pre-configured cycle number, a sampling operation is triggered. For the working clock of the timer, see Section [39.3.7.1](#).
- Configure `APB_SARADC_TIMER_EN` to enable the timer.
- When the timer times out, it drives DIG ADC FSM1 to start sampling according to the pattern table.

- Sampled data is automatically stored in memory via DMA. An interrupt is triggered once the scan is completed.

39.3.7.1 DIG ADC Clock

Two clocks can be used as the clock source for DIG ADC1 controller, depending on the configuration of [APB_SARADC_CLK_SEL](#):

- 0: clock off;
- 1: Select PLL_D2_CLK as the clock source. Then its divided clock DIGADC_CLK is used as the working clock for DIG ADC1 controller;
- 2: Select APB_CLK as the clock source.

If DIGADC_CLK is selected, users can configure the divider by [APB_SARADC_CLKM_DIV_NUM](#).

Note that due to speed limits of SAR ADCs, the operating clock of Digital Reader1 and SAR ADC1 is DIGADC_SARCLK, the frequency of which affects the sampling precision. When the frequency of DIGADC_SARCLK is higher than 5 MHz, the sampling precision will be lowered. DIGADC_SARCLK is divided from DIGADC_CLK. The divider coefficient is configured by [APB_SARADC_SAR_CLK_DIV](#).

The ADC needs 25 DIGADC_SARCLK clock cycles per sample, so the maximum sampling rate is limited by the DIGADC_SARCLK frequency.

39.3.7.2 DMA Support

DIG ADC1 controller support direct memory access via peripheral DMA, which is triggered by DIG ADC timer. Users can switch the DMA data path to DIG ADC by configuring [APB_SARADC_APB_ADC_TRANS](#) via software. For specific DMA configuration, please refer to Chapter 3 *GDMA Controller (GDMA)*.

39.3.7.3 DIG ADC FSM

DIG ADC FSM1 drive SAR ADC1 to sample voltage in cycles according to the order and channel No. specified in the pattern table.

- DIG ADC FSM1 receive the sampling enable signal from the timer.
- Then initiate a sampling request to SAR ADC1 according to the channel and attenuation configuration specified in the current pattern table entry pointed by the pointer (PR).
- Update the PR once the sampling is done.
 - If the PR reaches to the entry length configured in [APB_SARADC_SAR1_PATT_LEN](#), then the PR is reset, and restarts from the first entry of the pattern table.
 - Otherwise, the PR goes to the next entry.

39.3.7.4 Pattern Table

DIG ADC FSM1 contain a separate pattern table configured by [APB_SARADC_SAR1_PATT_TAB_x_REG](#), where *x* represents the register No. (1 ~ 4) of the pattern table, as shown below:

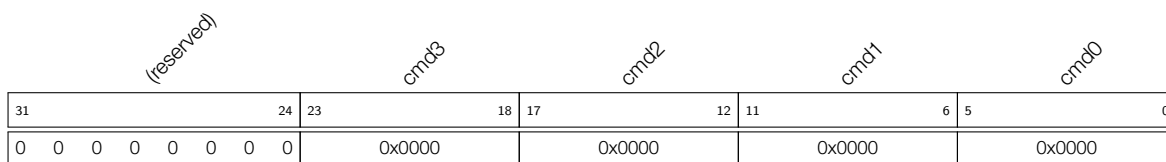

cmd *n* (*n* = 0 - 3) represents pattern table entries 0 ~ 3.

Figure 39-10. APB_SARADC_SAR1_PATT_TAB1_REG and Pattern Table Entry 0 - Entry 3

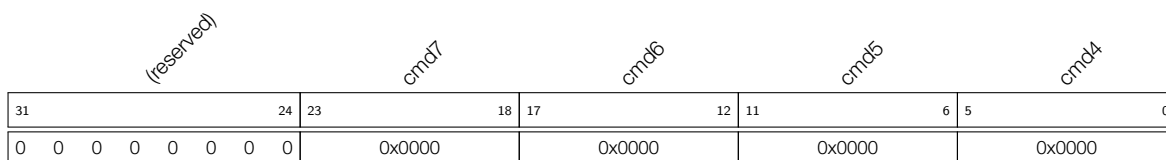

cmd *n* (*n* = 4 - 7) represents pattern table entries 4 ~ 7.

Figure 39-11. APB_SARADC_SAR1_PATT_TAB2_REG and Pattern Table Entry 4 - Entry 7

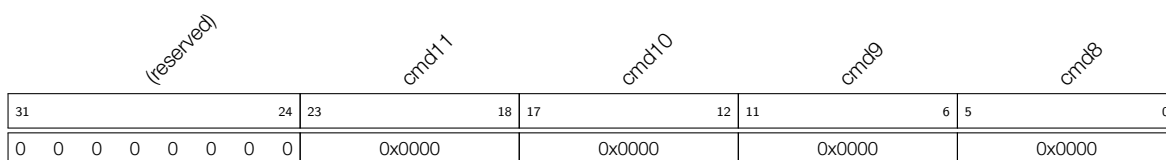

cmd *n* (*n* = 8 - 11) represents pattern table entries 8 ~ 11.

Figure 39-12. APB_SARADC_SAR1_PATT_TAB3_REG and Pattern Table Entry 8 - Entry 11

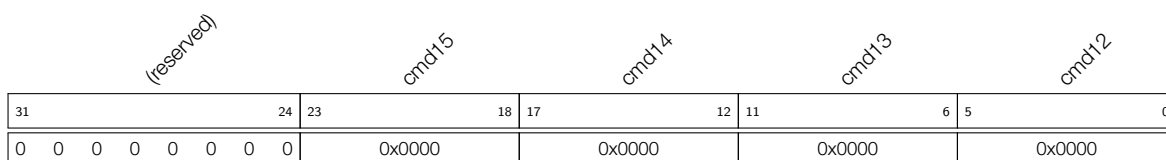

cmd *n* (*n* = 12 - 15) represents pattern table entries 12 ~ 15.

Figure 39-13. APB_SARADC_SAR1_PATT_TAB4_REG and Pattern Table Entry 12 - Entry 15

Each register consists of four 6-bit pattern table entries. Each entry is composed of two fields that contain ADC channel and attenuation information, as shown in Table 39-14.

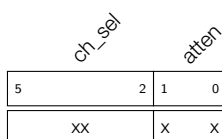

Figure 39-14. Pattern Table Entry

atten Attenuation. 0: 0 dB; 1: 2.5 dB; 2: 6 dB; 3: 12 dB.

ch_sel ADC channel, see Table 39-6.

39.3.7.5 Configuration Example for Multi-Channel Scanning

In this example, the following channels are selected for multi-channel scanning for SAR ADC1:

- Channel 2, with the attenuation of 12 dB. See Figure 39-15.
- Channel 0, with the attenuation of 2.5 dB. See Figure 39-16.

The detailed configuration is as follows:

- Configure SAR ADC1:
 - Configure the first pattern table entry (cmd0, `APB_SARADC_SAR1_PATT_TAB1_REG[5:0]`):

ch_sel		atten	
5	2	1	0
2		3	

Figure 39-15. SAR ADC1 cmd0 Configuration

atten write the value of 3 to this field, to set the attenuation to 12 dB.

ch_sel write the value of 2 to this field, to select channel 2 (see Table 39-6).

- Configure the second pattern table entry (cmd1, `APB_SARADC_SAR1_PATT_TAB1_REG[11:6]`):

ch_sel		atten	
5	2	1	0
0		1	

Figure 39-16. SAR ADC1 cmd1 Configuration

atten write the value of 1 to this field, to set the attenuation to 2.5 dB.

ch_sel write the value of 0 to this field, to select channel 0 (see Table 39-6).

- Configure `APB_SARADC_SAR1_PATT_LEN` to 1, i.e., set pattern table length to (this value + 1 = 2). Then pattern table entries cmd0 and cmd1 for SAR ADC1 will be used.
- Enable the timer, then DIG ADC1 controller start scanning the channel 2 and channel 0 of SAR ADC1 in cycles, as configured in the pattern table entries.

39.3.7.6 DMA Data Format

The SAR ADCs eventually pass 32-bit data to the DMA, see the figure below.

reserved										ch_sel			reserved										data															
32																17	15			13	12	11																0
xx															xxx			x	x																x			

Figure 39-17. DMA Data Format

data SAR ADC data, 12-bit

ch_sel Channel, 3-bit

39.3.7.7 ADC Filters

The DIG ADC1 controller provide two filters for automatic filtering of sampled ADC data. Both filters can be configured to any two channels of SAR ADC and then filter the sampled data for the target channel. The filter's formula is shown below:

$$data_{cur} = \frac{(k-1)data_{prev}}{k} + \frac{data_{in}}{k} - 0.5$$

- $data_{cur}$: the filtered data value.
- $data_{in}$: the sampled data value from the SAR ADC.
- $data_{prev}$: the last filtered data value.
- k : the filter coefficient.

The filters are configured as follows:

- Configure `APB_SARADC_FILTER_CHANNELx` to select the SAR ADC channel for filter x ;
- Configure `APB_SARADC_FILTER_FACTORx` to set the coefficient for filter x .

Note that x is used here as the placeholder of filter index. 0: filter 0; 1: filter 1.

39.3.7.8 Threshold Monitoring

DIG ADC1 controller contain two threshold monitors that can be configured to monitor on any channel of SAR ADC1. A high threshold interrupt is triggered when the ADC sample value is larger than the pre-configured high threshold, and a low threshold interrupt is triggered if the sample value is lower than the pre-configured low threshold.

The configuration of threshold monitoring is as follows:

- Set `APB_SARADC_THRESx_EN` to enable threshold monitor x .
- Configure `APB_SARADC_THRESx_LOW` to set a low threshold.
- Configure `APB_SARADC_THRESx_HIGH` to set a high threshold.
- Configure `APB_SARADC_THRESx_CHANNEL` to select the SAR ADC and the channel to monitor.

Note that x is used here as the placeholder of monitor index. 0: monitor 0; 1: monitor 1.

39.3.8 SAR ADC2 Arbiter

SAR ADC2 can be controlled by two controllers, namely, RTC ADC2 controller and PWDET controller. To avoid any possible conflicts and to improve the efficiency of SAR ADC2, ESP32-S3 provides an arbiter for SAR ADC2. The arbiter supports fair arbitration and fixed priority arbitration.

- Fair arbitration mode (cyclic priority arbitration) can be enabled by clearing `APB_SARADC_ADC_ARB_FIX_PRIORITY`.
- In fixed priority arbitration, users can set `APB_SARADC_ADC_ARB_RTC_PRIORITY` (for RTC ADC2 controller) or `APB_SARADC_ADC_ARB_WIFI_PRIORITY` (for PWDET controller), to configure the priorities for these controllers. A larger value indicates a higher priority.

The arbiter ensures that a higher priority controller can always start a conversion (sample) when required, regardless of whether a lower priority controller already has a conversion in progress. If a higher priority controller starts a conversion whilst the ADC already has a conversion in progress from a lower priority controller, the conversion in progress will be interrupted (stopped). The higher priority controller will then start its conversion. A lower priority controller will not be able to start a conversion whilst the ADC has a conversion in progress from a higher priority controller.

Therefore, certain data flags are embedded into the output data value to indicate whether the conversion is valid or not.

- The data flag for RTC ADC2 controller is the higher two bits of [SENS_MEAS2_DATA_SAR](#).
 - 2'b10: Conversion is interrupted.
 - 2'b01: Conversion is not started.
 - 2'b00: The data is valid.
- The data flag for PWDET controller is the higher two bits of the sampling result.
 - 2'b10: Conversion is interrupted.
 - 2'b01: Conversion is not started.
 - 2'b00: The data is valid.

Users can configure [APB_SARADC_ADC_ARB_GRANT_FORCE](#) to mask the arbiter, and set [APB_SARADC_ADC_ARB_WIFI_FORCE](#) or [APB_SARADC_ADC_ARB_RTC_FORCE](#) to authorize corresponding controllers.

Note:

- When the arbiter is masked, only one of the above [APB_SARADC_ADC_ARB_XXX_FORCE](#) bits can be set to 1.
- The arbiter uses [APB_CLK](#) as its clock source. When the clock frequency is 8 MHz or lower, the arbiter must be masked.
- In sleep mode, the [SENS_SAR2_RTC_FORCE](#) in register [SENS_SAR_MEAS2_MUX_REG](#) should be set to 1, masking the arbiter and all the signals from controllers except the RTC controllers.

39.4 Temperature Sensor

39.4.1 Overview

ESP32-S3 provides a temperature sensor to monitor temperature changes inside the chip in real time.

39.4.2 Features

The temperature sensor has the following features:

- Monitored in real time by ULP coprocessor when in low-power mode
- Triggered by software or by ULP coprocessor
- Configurable temperature offset based on the environment, to improve the accuracy
- Adjustable measurement range

39.4.3 Functional Description

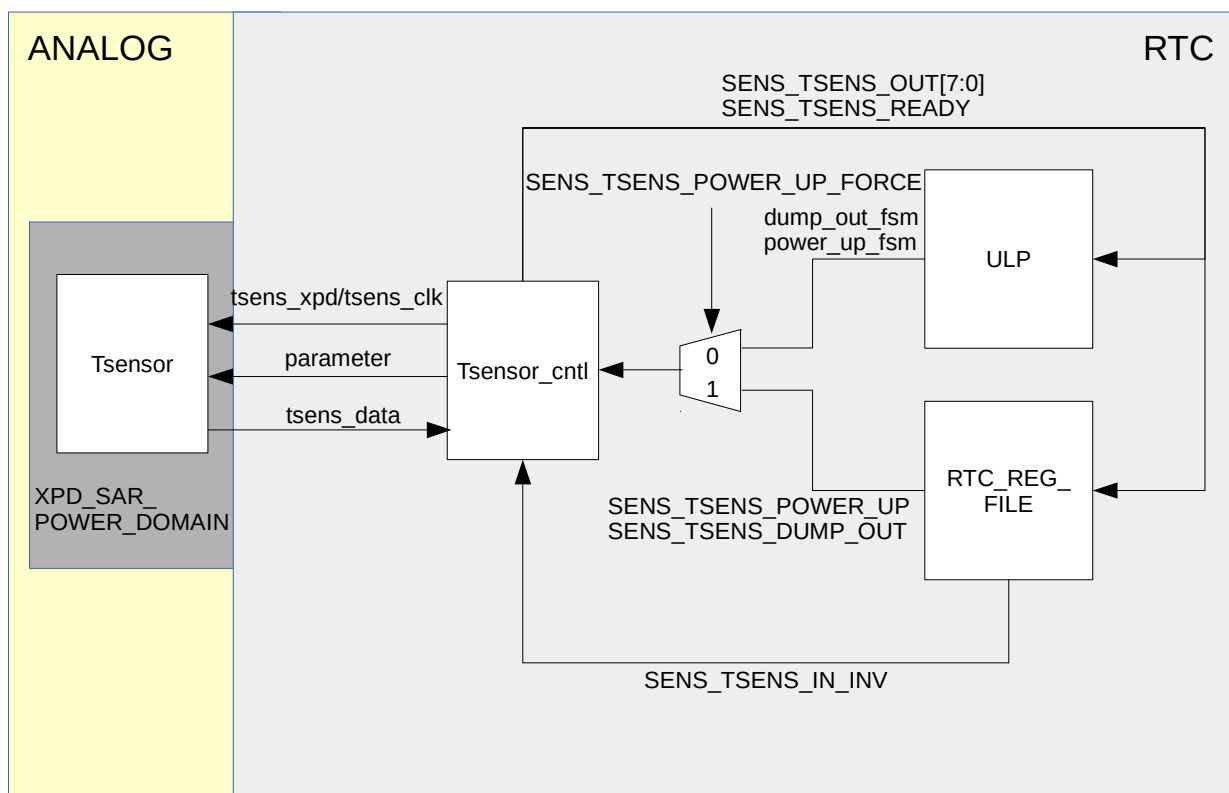

Figure 39-18. Temperature Sensor Overview

As shown in Figure 39-18, the temperature sensor can be started by software or by ULP coprocessor:

- Started by software, i.e. by CPU or ULP-RISC-V configuring related registers:
 - Set `SENS_TSENS_POWER_UP_FORCE` and `SENS_TSENS_POWER_UP` to enable the temperature sensor.
 - Set `SENS_FORCE_XPD_SAR` to force SAR ADC power on, and set `SENS_TSENS_CLK_EN` to enable temperature sensor clock.
 - Wait for a while, then configure `SENS_TSENS_DUMP_OUT`. The output value gradually approaches the actual temperature linearly as the measurement time increases.
 - Wait for `SENS_TSENS_READY`, and read the conversion result from `SENS_TSENS_OUT`.
- Started by ULP-FSM:
 - Clear `SENS_TSENS_POWER_UP_FORCE`.
 - ULP-FSM has a built-in instruction for temperature sampling. Executing the instruction can easily complete temperature sampling, see Chapter 2 *ULP Coprocessor (ULP-FSM, ULP-RISC-V)*.

The actual temperature (°C) can be obtained by converting the output of temperature sensor via the following formula:

$$T(^{\circ}\text{C}) = 0.4386 * \text{VALUE} - 27.88 * \text{offset} - 20.52$$

VALUE in the formula is the output of the temperature sensor, and the offset is determined by the temperature offset. The temperature offset varies in different actual environment (the temperature range). For details, refer to Table 39-7.

Table 39-7. Temperature Offset

Measurement Range (°C)	Temperature Offset (°C)
50 ~ 110	-2
20 ~ 100	-1
-10 ~ 80	0
-15 ~ 50	1
-20 ~ 20	2

39.5 Interrupts

- APB_SARADC_THRES_x_HIGH_INT: Triggered when the sampling value is higher than the high threshold of monitor *x*.
- APB_SARADC_THRES_x_LOW_INT: Triggered when the sampling value is lower than the low threshold of monitor *x*.
- APB_SARADC_ADC1_DONE_INT: Triggered when SAR ADC1 completes one data conversion.

For the interrupts routed to ULP-RISC-V, please refer to Section ULP-RISC-V Interrupts in Chapter 2 *ULP Coprocessor (ULP-FSM, ULP-RISC-V)*.

39.6 Register Summary

- SENSOR (ALWAYS_ON) represents the registers, which will not be reset due to the power down of RTC_PERI domain. See Chapter 10 *Low-power Management (RTC_CNTL)*.
- SENSOR (RTC_PERI) represents the registers, which will be reset due to the power down of RTC_PERI domain. See Chapter 10 *Low-power Management (RTC_CNTL)*.
- SENSOR (DIG_PERI) represents the registers, which will be reset due to the power down of digital domain. See Chapter 10 *Low-power Management (RTC_CNTL)*.

39.6.1 SENSOR (ALWAYS_ON) Register Summary

The addresses in this section are relative to the [Low Power Management] base address provided in Table 4-3 in Chapter 4 *System and Memory*.

Name	Description	Address	Access
Touch control register			
RTC_CNTL_TOUCH_CTRL1_REG	Touch control register 1	0x0108	R/W
RTC_CNTL_TOUCH_CTRL2_REG	Touch control register 2	0x010C	R/W
RTC_CNTL_TOUCH_SCAN_CTRL_REG	Configure touch scanning settings	0x0110	R/W
RTC_CNTL_TOUCH_SLP_THRES_REG	Configure the setting of touch sleep pin	0x0114	R/W
RTC_CNTL_TOUCH_APPROACH_REG	Configure touch proximity settings	0x0118	varies
RTC_CNTL_TOUCH_FILTER_CTRL_REG	Configure touch filter settings	0x011C	R/W

Name	Description	Address	Access
RTC_CNTL_TOUCH_TIMEOUT_CTRL_REG	Configure touch filter timeout settings	0x0124	R/W
RTC_CNTL_TOUCH_DAC_REG	Touch sensor configuration register for charge/discharge speed (slope)	0x014C	R/W
RTC_CNTL_TOUCH_DAC1_REG	Touch sensor configuration register 1 for charge/discharge speed (slope)	0x0150	R/W

39.6.2 SENSOR (RTC_PERI) Register Summary

The addresses in this section are relative to the [Low Power Management base address + 0x800] provided in Table 4-3 in Chapter 4 *System and Memory*.

The abbreviations given in Column **Access** are explained in Section [Access Types for Registers](#).

Name	Description	Address	Access
Configuration register			
SENS_SAR_READER1_CTRL_REG	SAR ADC1 data and sampling control	0x0000	R/W
SENS_SAR_MEAS1_CTRL2_REG	Control SAR ADC1 conversion and status	0x000C	varies
SENS_SAR_MEAS1_MUX_REG	Select the controller for SAR ADC1	0x0010	R/W
SENS_SAR_ATTEN1_REG	Configure SAR ADC1 attenuation	0x0014	R/W
SENS_SAR_READER2_CTRL_REG	SAR ADC2 data and sampling control	0x0024	R/W
SENS_SAR_MEAS2_CTRL2_REG	Control SAR ADC2 conversion and status	0x0030	varies
SENS_SAR_MEAS2_MUX_REG	Select the controller for SAR ADC2	0x0034	R/W
SENS_SAR_ATTEN2_REG	Configure SAR ADC2 attenuation	0x0038	R/W
SENS_SAR_POWER_XPD_SAR_REG	SAR ADC power control	0x003C	R/W
SENS_SAR_TSENS_CTRL_REG	Temperature sensor data control	0x0050	varies
SENS_SAR_TOUCH_CONF_REG	Touch sensor configuration register	0x005C	varies
SENS_SAR_TOUCH_DENOISE_REG	Denoise data register	0x0060	RO
SENS_SAR_TOUCH_THRES1_REG	Touch detection threshold for pin 1	0x0064	R/W
SENS_SAR_TOUCH_THRES2_REG	Touch detection threshold for pin 2	0x0068	R/W
SENS_SAR_TOUCH_THRES3_REG	Touch detection threshold for pin 3	0x006C	R/W
SENS_SAR_TOUCH_THRES4_REG	Touch detection threshold for pin 4	0x0070	R/W
SENS_SAR_TOUCH_THRES5_REG	Touch detection threshold for pin 5	0x0074	R/W
SENS_SAR_TOUCH_THRES6_REG	Touch detection threshold for pin 6	0x0078	R/W
SENS_SAR_TOUCH_THRES7_REG	Touch detection threshold for pin 7	0x007C	R/W
SENS_SAR_TOUCH_THRES8_REG	Touch detection threshold for pin 8	0x0080	R/W
SENS_SAR_TOUCH_THRES9_REG	Touch detection threshold for pin 9	0x0084	R/W
SENS_SAR_TOUCH_THRES10_REG	Touch detection threshold for pin 10	0x0088	R/W
SENS_SAR_TOUCH_THRES11_REG	Touch detection threshold for pin 11	0x008C	R/W
SENS_SAR_TOUCH_THRES12_REG	Touch detection threshold for pin 12	0x0090	R/W
SENS_SAR_TOUCH_THRES13_REG	Touch detection threshold for pin 13	0x0094	R/W
SENS_SAR_TOUCH_THRES14_REG	Touch detection threshold for pin 14	0x0098	R/W
SENS_SAR_TOUCH_CHN_ST_REG	Get touch channel status	0x009C	varies
SENS_SAR_PERI_CLK_GATE_CONF_REG	Clock gate of RTC peripherals	0x0104	R/W
SENS_SAR_PERI_RESET_CONF_REG	Reset register of RTC peripherals	0x0108	R/W
Status register			

Name	Description	Address	Access
SENS_SAR_TOUCH_STATUS0_REG	Get touch scan status	0x00A0	RO
SENS_SAR_TOUCH_STATUS1_REG	Channel status of touch pin 1	0x00A4	RO
SENS_SAR_TOUCH_STATUS2_REG	Channel status of touch pin 2	0x00A8	RO
SENS_SAR_TOUCH_STATUS3_REG	Channel status of touch pin 3	0x00AC	RO
SENS_SAR_TOUCH_STATUS4_REG	Channel status of touch pin 4	0x00B0	RO
SENS_SAR_TOUCH_STATUS5_REG	Channel status of touch pin 5	0x00B4	RO
SENS_SAR_TOUCH_STATUS6_REG	Channel status of touch pin 6	0x00B8	RO
SENS_SAR_TOUCH_STATUS7_REG	Channel status of touch pin 7	0x00BC	RO
SENS_SAR_TOUCH_STATUS8_REG	Channel status of touch pin 8	0x00C0	RO
SENS_SAR_TOUCH_STATUS9_REG	Channel status of touch pin 9	0x00C4	RO
SENS_SAR_TOUCH_STATUS10_REG	Channel status of touch pin 10	0x00C8	RO
SENS_SAR_TOUCH_STATUS11_REG	Channel status of touch pin 11	0x00CC	RO
SENS_SAR_TOUCH_STATUS12_REG	Channel status of touch pin 12	0x00D0	RO
SENS_SAR_TOUCH_STATUS13_REG	Channel status of touch pin 13	0x00D4	RO
SENS_SAR_TOUCH_STATUS14_REG	Channel status of touch pin 14	0x00D8	RO
SENS_SAR_TOUCH_STATUS15_REG	Channel status of sleep pin	0x00DC	RO
SENS_SAR_TOUCH_APPR_STATUS_REG	Channel status of touch pins in proximity mode	0x00E0	RO

39.6.3 SENSOR (DIG_PERI) Register Summary

The addresses in this section are relative to the [ADC controller base address] provided in Table 4-3 in Chapter 4 *System and Memory*.

The abbreviations given in Column **Access** are explained in Section [Access Types for Registers](#).

Name	Description	Address	Access
Configure register			
APB_SARADC_CTRL_REG	Configuration register for DIG ADC controller	0x0000	R/W
APB_SARADC_CTRL2_REG	Configuration register for DIG ADC controller	0x0004	R/W
APB_SARADC_FILTER_CTRL1_REG	Configuration register 1 for SAR ADC filter	0x0008	R/W
APB_SARADC_SAR1_PATT_TAB1_REG	Pattern table register 1 for SAR ADC1	0x0018	R/W
APB_SARADC_SAR1_PATT_TAB2_REG	Pattern table register 2 for SAR ADC1	0x001C	R/W
APB_SARADC_SAR1_PATT_TAB3_REG	Pattern table register 3 for SAR ADC1	0x0020	R/W
APB_SARADC_SAR1_PATT_TAB4_REG	Pattern table register 4 for SAR ADC1	0x0024	R/W
APB_SARADC_APB_ADC_ARB_CTRL_REG	Configuration register for SAR ADC2 arbiter	0x0038	R/W
APB_SARADC_FILTER_CTRL0_REG	Configuration register 0 for SAR ADC filter	0x003C	R/W
APB_SARADC_THRES0_CTRL_REG	Sampling threshold control register 0	0x0044	R/W
APB_SARADC_THRES1_CTRL_REG	Sampling threshold control register 1	0x0048	R/W
APB_SARADC_THRES_CTRL_REG	Threshold monitor enable register	0x0058	R/W
APB_SARADC_DMA_CONF_REG	DMA configuration register for SAR ADC	0x006C	R/W
APB_SARADC_APB_ADC_CLKM_CONF_REG	Configure SAR ADC clock	0x0070	R/W
Status register			

Name	Description	Address	Access
APB_SARADC_APB_SARADC1_DATA_STATUS_REG	Get SAR ADC1 sample data	0x0040	RO
APB_SARADC_APB_SARADC2_DATA_STATUS_REG	Get SAR ADC2 sample data	0x0078	RO
interrupt register			
APB_SARADC_INT_ENA_REG	Enable SAR ADC interrupts	0x005C	R/W
APB_SARADC_INT_RAW_REG	SAR ADC interrupt raw bits	0x0060	RO
APB_SARADC_INT_ST_REG	SAR ADC interrupt status	0x0064	RO
APB_SARADC_INT_CLR_REG	Clear SAR ADC interrupts	0x0068	WO
Version register			
APB_SARADC_APB_CTRL_DATE_REG	Version control register	0x03FC	R/W

39.7 Registers

39.7.1 SENSOR (ALWAYS_ON) Registers

The addresses in this section are relative to the [Low Power Management] base address provided in Table 4-3 in Chapter 4 *System and Memory*.

Register 39.1. RTC_CNTL_TOUCH_CTRL1_REG (0x0108)

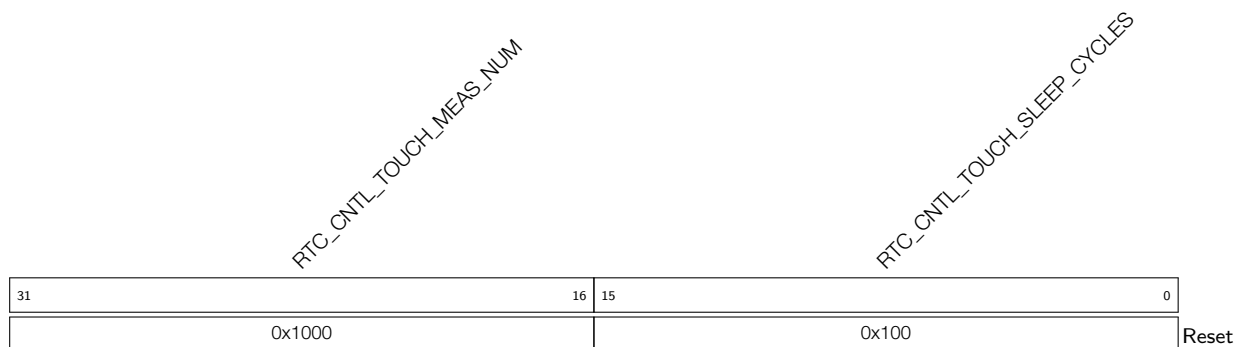

RTC_CNTL_TOUCH_SLEEP_CYCLES Set sleep cycles for touch timer. Clock: RTC_SLOW_CLK.
(R/W)

RTC_CNTL_TOUCH_MEAS_NUM Configure measurement duration expressed in number of charge/discharge cycles. (R/W)

Register 39.2. RTC_CNTL_TOUCH_CTRL2_REG (0x010C)

RTC_CNTL_TOUCH_CLKGATE_EN				RTC_CNTL_TOUCH_TIMER_FORCE_DONE				RTC_CNTL_TOUCH_XPD_WAIT				RTC_CNTL_TOUCH_START_FORCE				RTC_CNTL_TOUCH_TIMER_EN				RTC_CNTL_TOUCH_XPD_BIAS				RTC_CNTL_TOUCH_REF_C				RTC_CNTL_TOUCH_XPD_BIAS				RTC_CNTL_TOUCH_DREFH				RTC_CNTL_TOUCH_DREFL				(reserved)			
31	30	29	28	27	26	25	24	17	16	15	14	13	12	11	9	8	7	6	5	4	3	2	1	0	Reset																		
0	0	0	0	0	0	0x4							0	0	1	0	0	0x0	0	3	0	3	0	0	0																		

RTC_CNTL_TOUCH_DRANGE Touch attenuation. (R/W)

RTC_CNTL_TOUCH_DREFL Touch reference voltage low. (R/W)

- 0: 0.5 V
- 1: 0.6 V
- 2: 0.7 V
- 3: 0.8 V

RTC_CNTL_TOUCH_DREFH Touch reference voltage high. (R/W)

- 0: 2.4 V
- 1: 2.5 V
- 2: 2.6 V
- 3: 2.7 V

RTC_CNTL_TOUCH_XPD_BIAS Touch bias power switch. (R/W)

RTC_CNTL_TOUCH_REF_C Touch pin 0 reference capacitance. (R/W)

RTC_CNTL_TOUCH_DBIAS 1: Use self bias. 0: Use bandgap bias. (R/W)

RTC_CNTL_TOUCH_SLP_TIMER_EN Touch timer enable bit. (R/W)

RTC_CNTL_TOUCH_START_FSM_EN 1: TOUCH_START and TOUCH_XPD are controlled by touch FSM. 0: TOUCH_START and TOUCH_XPD are controlled by software. (R/W)

RTC_CNTL_TOUCH_START_EN 1: Start touch FSM, only valid when RTC_CNTL_TOUCH_START_FORCE = 1. (R/W)

RTC_CNTL_TOUCH_START_FORCE 1: Start touch FSM by software. 0: Start touch FSM by timer. (R/W)

RTC_CNTL_TOUCH_XPD_WAIT The waiting cycles between TOUCH_START and TOUCH_XPD. Clock: RTC_FAST_CLK. (R/W)

Continued on the next page...

Register 39.4. RTC_CNTL_TOUCH_SLP_THRES_REG (0x0114)

RTC_CNTL_TOUCH_SLP_PAD		RTC_CNTL_TOUCH_SLP_APPROACH_EN		RTC_CNTL_TOUCH_SLP_TH			
31	27	26	25	22	21		
0xf		0	0	0	0	0x0000	
							Reset

RTC_CNTL_TOUCH_SLP_TH Set the threshold for sleep touch pin. (R/W)

RTC_CNTL_TOUCH_SLP_APPROACH_EN Enable the proximity mode of touch sleep pin. (R/W)

RTC_CNTL_TOUCH_SLP_PAD Select sleep pin. (R/W)

Register 39.5. RTC_CNTL_TOUCH_APPROACH_REG (0x0118)

RTC_CNTL_TOUCH_APPROACH_MEAS_TIME		RTC_CNTL_TOUCH_SLP_CHANNEL_CLR		(reserved)			
31	24	23	22				
80		0	0	0	0	0	0
							Reset

RTC_CNTL_TOUCH_SLP_CHANNEL_CLR Clear touch sleep channel. (WO)

RTC_CNTL_TOUCH_APPROACH_MEAS_TIME Set the total measurement times for the pins in proximity mode. Range: 0 ~ 255. (R/W)

Register 39.6. RTC_CNTL_TOUCH_FILTER_CTRL_REG (0x011C)

RTC_CNTL_TOUCH_FILTER_EN		RTC_CNTL_TOUCH_FILTER_MODE		(reserved)		RTC_CNTL_TOUCH_CONFIG3		RTC_CNTL_TOUCH_NOISE_THRES		RTC_CNTL_TOUCH_CONFIG2		RTC_CNTL_TOUCH_CONFIG1		RTC_CNTL_TOUCH_JITTER_STEP		RTC_CNTL_TOUCH_SMOOTH_LVL		(reserved)				
31	30	28	27	25	24	23	22	21	20	19	18	15	14	11	10	9	8			0		
1	1	3		1	1	1	5					1	0	0	0	0	0	0	0	0	0	0

Reset

RTC_CNTL_TOUCH_SMOOTH_LVL Smooth filter factor. 0: Raw data. 1: IIR1/2. 2: IIR1/4. 3: IIR1/8. (R/W)

RTC_CNTL_TOUCH_JITTER_STEP Touch jitter step. Range: 0 ~ 15. (R/W)

RTC_CNTL_TOUCH_CONFIG1 Internal configuration field. (R/W)

RTC_CNTL_TOUCH_CONFIG2 Internal configuration field. (R/W)

RTC_CNTL_TOUCH_NOISE_THRES Active noise threshold. (R/W)

RTC_CNTL_TOUCH_CONFIG3 Internal configuration field. (R/W)

RTC_CNTL_TOUCH_FILTER_MODE Set filter mode. (R/W)

- 0: IIR 1/2
- 1: IIR 1/4
- 2: IIR 1/8
- 3: IIR 1/16
- 4: IIR 1/32
- 5: IIR 1/64
- 6: IIR 1/128
- 7: Jitter

RTC_CNTL_TOUCH_FILTER_EN Enable touch filter. (R/W)

Register 39.8. RTC_CNTL_TOUCH_DAC_REG (0x014C)

RTC_CNTL_TOUCH_PAD0_DAC		RTC_CNTL_TOUCH_PAD1_DAC		RTC_CNTL_TOUCH_PAD2_DAC		RTC_CNTL_TOUCH_PAD3_DAC		RTC_CNTL_TOUCH_PAD4_DAC		RTC_CNTL_TOUCH_PAD5_DAC		RTC_CNTL_TOUCH_PAD6_DAC		RTC_CNTL_TOUCH_PAD7_DAC		RTC_CNTL_TOUCH_PAD8_DAC		RTC_CNTL_TOUCH_PAD9_DAC		(reserved)	
31	29	28	26	25	23	22	20	19	17	16	14	13	11	10	8	7	5	4	2	1	0
0		0		0		0		0		0		0		0		0		0		0	0

Reset

RTC_CNTL_TOUCH_PAD9_DAC Configure the charge/discharge speed (slope) for touch sensor 9.
(R/W)

RTC_CNTL_TOUCH_PAD8_DAC Configure the charge/discharge speed (slope) for touch sensor 8.
(R/W)

RTC_CNTL_TOUCH_PAD7_DAC Configure the charge/discharge speed (slope) for touch sensor 7.
(R/W)

RTC_CNTL_TOUCH_PAD6_DAC Configure the charge/discharge speed (slope) for touch sensor 6.
(R/W)

RTC_CNTL_TOUCH_PAD5_DAC Configure the charge/discharge speed (slope) for touch sensor 5.
(R/W)

RTC_CNTL_TOUCH_PAD4_DAC Configure the charge/discharge speed (slope) for touch sensor 4.
(R/W)

RTC_CNTL_TOUCH_PAD3_DAC Configure the charge/discharge speed (slope) for touch sensor 3.
(R/W)

RTC_CNTL_TOUCH_PAD2_DAC Configure the charge/discharge speed (slope) for touch sensor 2.
(R/W)

RTC_CNTL_TOUCH_PAD1_DAC Configure the charge/discharge speed (slope) for touch sensor 1.
(R/W)

RTC_CNTL_TOUCH_PAD0_DAC Configure the charge/discharge speed (slope) for touch sensor 0.
(R/W)

Register 39.13. SENS_SAR_ATTEN1_REG (0x0014)

SENS_SAR1_ATTEN 2-bit attenuation for each pin of SAR ADC1. [1:0] is used for channel 0, [3:2] is used for channel 1, etc. (R/W)

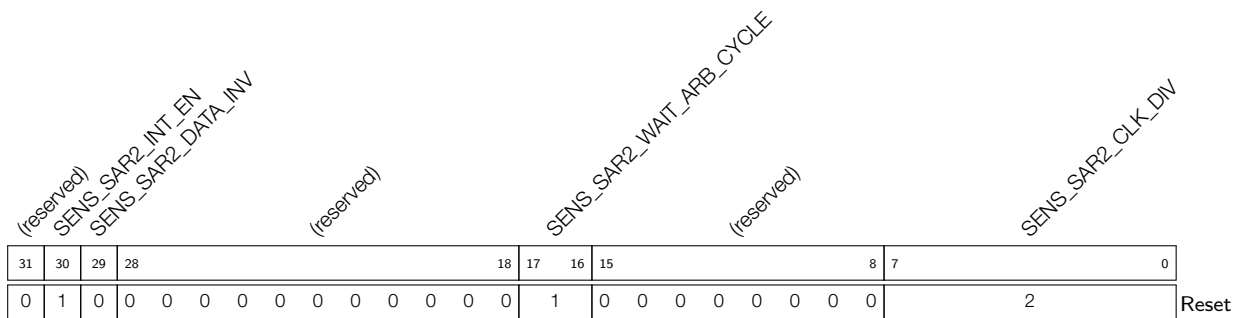
Register 39.14. SENS_SAR_READER2_CTRL_REG (0x0024)

SENS_SAR2_CLK_DIV Clock divider. (R/W)

SENS_SAR2_WAIT_ARB_CYCLE Wait arbiter stable after SAR_DONE. (R/W)

SENS_SAR2_DATA_INV Invert SAR ADC2 data. (R/W)

SENS_SAR2_INT_EN Enable SAR ADC2 to send out interrupt. (R/W)

Register 39.17. SENS_SAR_ATTEN2_REG (0x0038)

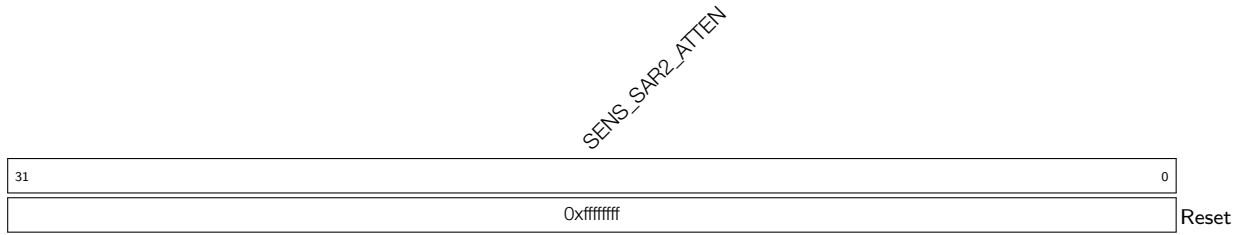

SENS_SAR2_ATTEN 2-bit attenuation for each pin of SAR ADC2. [1:0] is used for channel 0, [3:2] is used for channel 1, etc. (R/W)

Register 39.18. SENS_SAR_POWER_XPD_SAR_REG (0x003C)

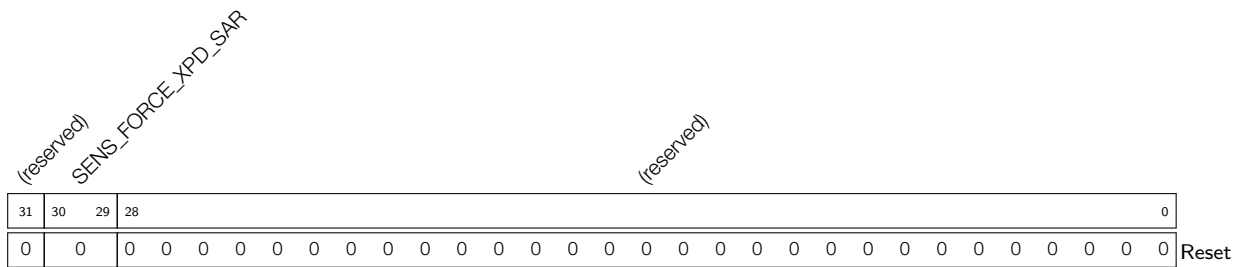

SENS_FORCE_XPD_SAR Configures whether to enable force power up/down the SAR ADC.

- 0/1: Disable force power up/down function
- 2: Enable force power up
- 3: Enable force power down

(R/W)

Register 39.20. SENS_SAR_TOUCH_CONF_REG (0x005C)

<i>SENS_TOUCH_APPROACH_PAD0</i>										<i>SENS_TOUCH_APPROACH_PAD1</i>					<i>SENS_TOUCH_APPROACH_PAD2</i>					<i>SENS_TOUCH_UNIT_END</i>					<i>SENS_TOUCH_DENOISE_END</i>					<i>SENS_TOUCH_DATA_SEL</i>					<i>SENS_TOUCH_STATUS_CLR</i>					<i>SENS_TOUCH_OUTEN</i>									
31	28	27	24	23	20	19	18	17	16	15	14																			0																			
0xf										0xf					0xf					0					0					0					0x7fff										Reset				

SENS_TOUCH_OUTEN Enable touch controller output. (R/W)

SENS_TOUCH_STATUS_CLR Clear all touch active status. (WO)

SENS_TOUCH_DATA_SEL Select touch data mode. (R/W)

- 0 and 1: raw_data
- 2: benchmark
- 3: smooth data

SENS_TOUCH_DENOISE_END Touch denoise done. (RO)

SENS_TOUCH_UNIT_END Indicate the completion of sampling. (RO)

SENS_TOUCH_APPROACH_PAD2 Indicate which pin is selected as proximity pin 2. (R/W)

SENS_TOUCH_APPROACH_PAD1 Indicate which pin is selected as proximity pin 1. (R/W)

SENS_TOUCH_APPROACH_PAD0 Indicate which pin is selected as proximity pin 0. (R/W)

Register 39.21. SENS_SAR_TOUCH_DENOISE_REG (0x0060)

<i>(reserved)</i>										<i>SENS_TOUCH_DENOISE_DATA</i>																				
31											22	21											0							
0										0										0										Reset

SENS_TOUCH_DENOISE_DATA Denoise value measured from touch sensor 0. (RO)

Register 39.22. SENS_SAR_TOUCH_THRES1_REG (0x0064)

<i>(reserved)</i>										<i>SENS_TOUCH_OUT_TH1</i>																																				
31																					22	21																								0
0										0										0x0000										Reset																

SENS_TOUCH_OUT_TH1 Finger threshold for touch pin 1. (R/W)

Register 39.23. SENS_SAR_TOUCH_THRES2_REG (0x0068)

<i>(reserved)</i>										<i>SENS_TOUCH_OUT_TH2</i>																																							
31																					22	21																											0
0										0										0x0000										Reset																			

SENS_TOUCH_OUT_TH2 Finger threshold for touch pin 2. (R/W)

Register 39.24. SENS_SAR_TOUCH_THRES3_REG (0x006C)

<i>(reserved)</i>										<i>SENS_TOUCH_OUT_TH3</i>																																							
31																					22	21																											0
0										0										0x0000										Reset																			

SENS_TOUCH_OUT_TH3 Finger threshold for touch pin 3. (R/W)

Register 39.25. SENS_SAR_TOUCH_THRES4_REG (0x0070)

31	(reserved)	22	21	SENS_TOUCH_OUT_TH4	0
0 0 0 0 0 0 0 0 0 0 0			0x0000		
Reset					

SENS_TOUCH_OUT_TH4 Finger threshold for touch pin 4. (R/W)

Register 39.26. SENS_SAR_TOUCH_THRES5_REG (0x0074)

31	(reserved)	22	21	SENS_TOUCH_OUT_TH5	0
0 0 0 0 0 0 0 0 0 0 0			0x0000		
Reset					

SENS_TOUCH_OUT_TH5 Finger threshold for touch pin 5. (R/W)

Register 39.27. SENS_SAR_TOUCH_THRES6_REG (0x0078)

31	(reserved)	22	21	SENS_TOUCH_OUT_TH6	0
0 0 0 0 0 0 0 0 0 0 0			0x0000		
Reset					

SENS_TOUCH_OUT_TH6 Finger threshold for touch pin 6. (R/W)

Register 39.28. SENS_SAR_TOUCH_THRES7_REG (0x007C)

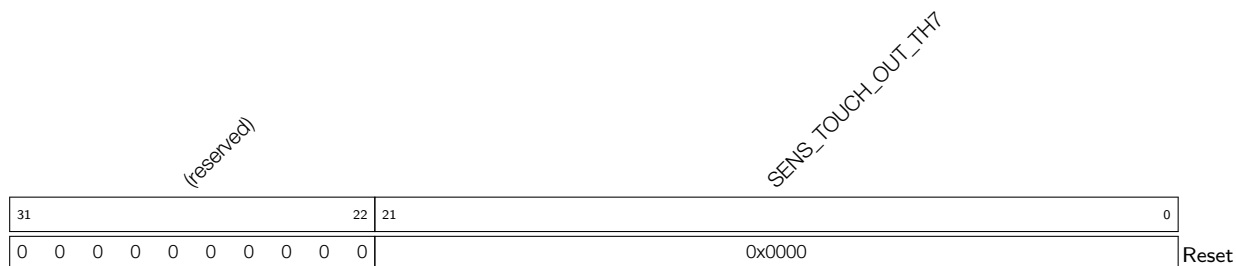

SENS_TOUCH_OUT_TH7 Finger threshold for touch pin 7. (R/W)

Register 39.29. SENS_SAR_TOUCH_THRES8_REG (0x0080)

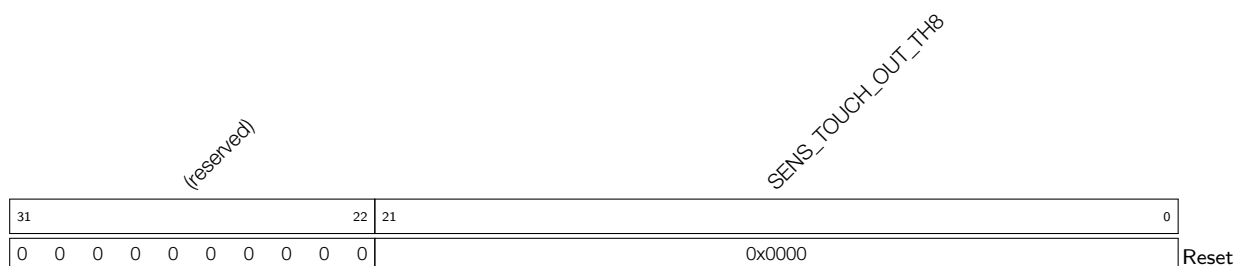

SENS_TOUCH_OUT_TH8 Finger threshold for touch pin 8. (R/W)

Register 39.30. SENS_SAR_TOUCH_THRES9_REG (0x0084)

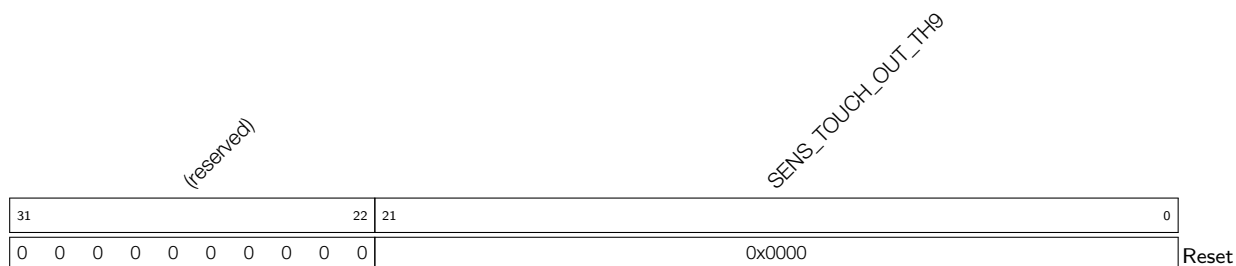

SENS_TOUCH_OUT_TH9 Finger threshold for touch pin 9. (R/W)

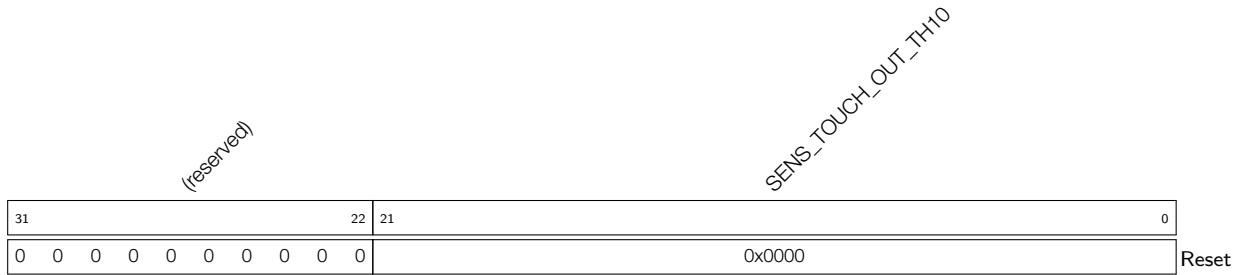
Register 39.31. SENS_SAR_TOUCH_THRES10_REG (0x0088)

SENS_TOUCH_OUT_TH10 Finger threshold for touch pin 10. (R/W)

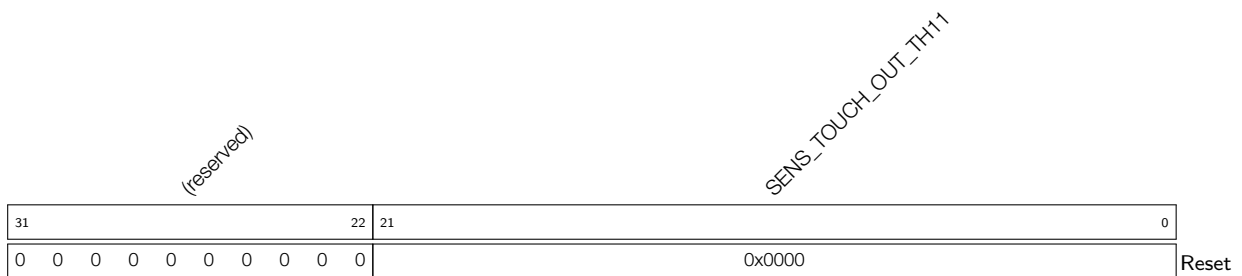
Register 39.32. SENS_SAR_TOUCH_THRES11_REG (0x008C)

SENS_TOUCH_OUT_TH11 Finger threshold for touch pin 11. (R/W)

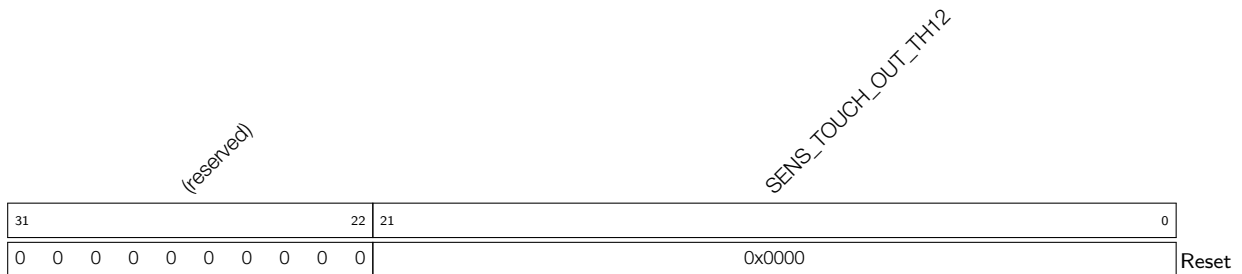
Register 39.33. SENS_SAR_TOUCH_THRES12_REG (0x0090)

SENS_TOUCH_OUT_TH12 Finger threshold for touch pin 12. (R/W)

Register 39.34. SENS_SAR_TOUCH_THRES13_REG (0x0094)

(reserved)										SENS_TOUCH_OUT_TH13												
31										22	21											0
0	0	0	0	0	0	0	0	0	0	0x0000											Reset	

SENS_TOUCH_OUT_TH13 Finger threshold for touch pin 13. (R/W)

Register 39.35. SENS_SAR_TOUCH_THRES14_REG (0x0098)

(reserved)										SENS_TOUCH_OUT_TH14												
31										22	21											0
0	0	0	0	0	0	0	0	0	0	0x0000											Reset	

SENS_TOUCH_OUT_TH14 Finger threshold for touch pin 14. (R/W)

Register 39.36. SENS_SAR_TOUCH_CHN_ST_REG (0x009C)

SENS_TOUCH_MEAS_DONE (reserved)			SENS_TOUCH_CHANNEL_CLR												SENS_TOUCH_PAD_ACTIVE						
31	30	29												15	14						0
0	0		0											0					Reset		

SENS_TOUCH_PAD_ACTIVE Touch active status. (RO)

SENS_TOUCH_CHANNEL_CLR Clear touch channel. (WO)

SENS_TOUCH_MEAS_DONE Touch measurement done. (RO)

Register 39.40. SENS_SAR_TOUCH_STATUS1_REG (0x00A4)

(reserved)		(reserved)						SENS_TOUCH_PAD1_DATA																	
31	29	28							22	21															0
0	0 0 0 0 0 0 0						0x0000														Reset				

SENS_TOUCH_PAD1_DATA The data of touch pin 1, depending on the setting of [SENS_TOUCH_DATA_SEL](#). (RO)

Register 39.41. SENS_SAR_TOUCH_STATUS2_REG (0x00A8)

(reserved)		(reserved)						SENS_TOUCH_PAD2_DATA																	
31	29	28							22	21															0
0	0 0 0 0 0 0 0						0x0000														Reset				

SENS_TOUCH_PAD2_DATA The data of touch pin 2, depending on the setting of [SENS_TOUCH_DATA_SEL](#). (RO)

Register 39.42. SENS_SAR_TOUCH_STATUS3_REG (0x00AC)

(reserved)		(reserved)						SENS_TOUCH_PAD3_DATA																	
31	29	28							22	21															0
0	0 0 0 0 0 0 0						0x0000														Reset				

SENS_TOUCH_PAD3_DATA The data of touch pin 3, depending on the setting of [SENS_TOUCH_DATA_SEL](#). (RO)

Register 39.43. SENS_SAR_TOUCH_STATUS4_REG (0x00B0)

(reserved)		(reserved)						SENS_TOUCH_PAD4_DATA																	
31	29	28							22	21															0
0	0 0 0 0 0 0 0						0x0000														Reset				

SENS_TOUCH_PAD4_DATA The data of touch pin 4, depending on the setting of [SENS_TOUCH_DATA_SEL](#). (RO)

Register 39.44. SENS_SAR_TOUCH_STATUS5_REG (0x00B4)

(reserved)		(reserved)						SENS_TOUCH_PAD5_DATA																	
31	29	28							22	21															0
0	0 0 0 0 0 0 0						0x0000														Reset				

SENS_TOUCH_PAD5_DATA The data of touch pin 5, depending on the setting of [SENS_TOUCH_DATA_SEL](#). (RO)

Register 39.45. SENS_SAR_TOUCH_STATUS6_REG (0x00B8)

(reserved)		(reserved)						SENS_TOUCH_PAD6_DATA																	
31	29	28							22	21															0
0	0 0 0 0 0 0 0						0x0000														Reset				

SENS_TOUCH_PAD6_DATA The data of touch pin 6, depending on the setting of [SENS_TOUCH_DATA_SEL](#). (RO)

Register 39.46. SENS_SAR_TOUCH_STATUS7_REG (0x00BC)

(reserved)		(reserved)						SENS_TOUCH_PAD7_DATA																	
31	29	28							22	21															0
0	0 0 0 0 0 0 0						0x0000														Reset				

SENS_TOUCH_PAD7_DATA The data of touch pin 7, depending on the setting of [SENS_TOUCH_DATA_SEL](#). (RO)

Register 39.47. SENS_SAR_TOUCH_STATUS8_REG (0x00C0)

(reserved)		(reserved)						SENS_TOUCH_PAD8_DATA																	
31	29	28							22	21															0
0	0 0 0 0 0 0 0						0x0000														Reset				

SENS_TOUCH_PAD8_DATA The data of touch pin 8, depending on the setting of [SENS_TOUCH_DATA_SEL](#). (RO)

Register 39.48. SENS_SAR_TOUCH_STATUS9_REG (0x00C4)

(reserved)		(reserved)						SENS_TOUCH_PAD9_DATA																	
31	29	28							22	21															0
0	0 0 0 0 0 0 0						0x0000														Reset				

SENS_TOUCH_PAD9_DATA The data of touch pin 9, depending on the setting of [SENS_TOUCH_DATA_SEL](#). (RO)

Register 39.49. SENS_SAR_TOUCH_STATUS10_REG (0x00C8)

(reserved)		(reserved)						SENS_TOUCH_PAD10_DATA														0			
31	29	28							22	21															0
0	0 0 0 0 0 0 0						0x0000														0				

Reset

SENS_TOUCH_PAD10_DATA The data of touch pin 10, depending on the setting of [SENS_TOUCH_DATA_SEL](#). (RO)

Register 39.50. SENS_SAR_TOUCH_STATUS11_REG (0x00CC)

(reserved)		(reserved)						SENS_TOUCH_PAD11_DATA														0			
31	29	28							22	21															0
0	0 0 0 0 0 0 0						0x0000														0				

Reset

SENS_TOUCH_PAD11_DATA The data of touch pin 11, depending on the setting of [SENS_TOUCH_DATA_SEL](#). (RO)

Register 39.51. SENS_SAR_TOUCH_STATUS12_REG (0x00D0)

(reserved)		(reserved)						SENS_TOUCH_PAD12_DATA														0			
31	29	28							22	21															0
0	0 0 0 0 0 0 0						0x0000														0				

Reset

SENS_TOUCH_PAD12_DATA The data of touch pin 12, depending on the setting of [SENS_TOUCH_DATA_SEL](#). (RO)

Register 39.52. SENS_SAR_TOUCH_STATUS13_REG (0x00D4)

(reserved)		(reserved)						SENS_TOUCH_PAD13_DATA												0			
31	29	28							22	21													Reset
0	0 0 0 0 0 0 0						0x0000																

SENS_TOUCH_PAD13_DATA The data of touch pin 13, depending on the setting of [SENS_TOUCH_DATA_SEL](#). (RO)

Register 39.53. SENS_SAR_TOUCH_STATUS14_REG (0x00D8)

(reserved)		(reserved)						SENS_TOUCH_PAD14_DATA												0			
31	29	28							22	21													Reset
0	0 0 0 0 0 0 0						0x0000																

SENS_TOUCH_PAD14_DATA The data of touch pin 14, depending on the setting of [SENS_TOUCH_DATA_SEL](#). (RO)

Register 39.54. SENS_SAR_TOUCH_STATUS15_REG (0x00DC)

(reserved)		(reserved)						SENS_TOUCH_SLP_DATA												0			
31	29	28							22	21													Reset
0	0 0 0 0 0 0 0						0x0000																

SENS_TOUCH_SLP_DATA The data of touch sleep pin, depending on the setting of [SENS_TOUCH_DATA_SEL](#). (RO)

Register 39.55. SENS_SAR_TOUCH_APPR_STATUS_REG (0x00E0)

<i>SENS_TOUCH_SLP_APPROACH_CNT</i>				<i>SENS_TOUCH_APPROACH_PAD0_CNT</i>				<i>SENS_TOUCH_APPROACH_PAD1_CNT</i>				<i>SENS_TOUCH_APPROACH_PAD2_CNT</i>							
31				24	23				16	15				8	7				0
0				0				0				0				Reset			

SENS_TOUCH_APPROACH_PAD2_CNT Touch count of proximity pin 2. (RO)

SENS_TOUCH_APPROACH_PAD1_CNT Touch count of proximity pin 1. (RO)

SENS_TOUCH_APPROACH_PAD0_CNT Touch count of proximity pin 0. (RO)

SENS_TOUCH_SLP_APPROACH_CNT Touch count of sleep pin in proximity mode. (RO)

39.7.3 SENSOR (DIG_PERI) Registers

The addresses in this section are relative to the [ADC controller base address] provided in Table 4-3 in Chapter 4 *System and Memory*.

Register 39.56. APB_SARADC_CTRL_REG (0x0000)

APB_SARADC_WAIT_ARB_CYCLE (reserved)		APB_SARADC_XPD_SAR_FORCE (reserved)		APB_SARADC_SAR1_PATT_P_CLEAR (reserved)		APB_SARADC_SAR1_PATT_LEN		APB_SARADC_SAR_CLK_DIV		APB_SARADC_SAR_CLK_GATED (reserved)		APB_SARADC_START (reserved)		APB_SARADC_START_FORCE (reserved)								
31	30	29	28	27	26	25	24	23	22	19	18	15	14	7	6	5	4	3	2	1	0	
1	0	0	0	0	0	0	0	0	0	15	15	4	4	1	0	0	0	0	0	0	0	Reset

APB_SARADC_START_FORCE 0: SAR ADC is started by FSM. 1: SAR ADC is started by software.

(R/W)

APB_SARADC_START Start SAR ADC by software, only valid when APB_SARADC_START_FORCE

= 1. (R/W)

APB_SARADC_SAR_CLK_GATED Enable SAR ADC clock gate when SAR ADC is in idle. (R/W)

APB_SARADC_SAR_CLK_DIV SAR clock divider. (R/W)

APB_SARADC_SAR1_PATT_LEN Configure how many pattern table entries will be used for SAR ADC1. If this field is set to 1, then pattern table entries (cmd0) and (cmd1) will be used. (R/W)

APB_SARADC_SAR1_PATT_P_CLEAR Clear the pointer of pattern table entry for DIG ADC1 controller. (R/W)

APB_SARADC_XPD_SAR_FORCE Force select XPD SAR. (R/W)

APB_SARADC_WAIT_ARB_CYCLE The clock cycles of waiting arbitration signal stable after SAR_DONE. (R/W)

Register 39.57. APB_SARADC_CTRL2_REG (0x0004)

(reserved)								APB_SARADC_TIMER_EN				APB_SARADC_TIMER_TARGET				(reserved)				APB_SARADC_SAR2_INV				APB_SARADC_SAR1_INV				APB_SARADC_MAX_MEAS_NUM				APB_SARADC_MEAS_NUM_LIMIT			
31								25	24	23								12	11	10	9	8								1	0				
0	0	0	0	0	0	0	0	0	10							0	0	0	255							0									

Reset

APB_SARADC_MEAS_NUM_LIMIT Enable the limitation of SAR ADCs maximum conversion times.

(R/W)

APB_SARADC_MAX_MEAS_NUM The SAR ADCs maximum conversion times. (R/W)

APB_SARADC_SAR1_INV Write 1 here to invert the data to DIG ADC1 controller. (R/W)

APB_SARADC_SAR2_INV Write 1 here to invert the data to DIG ADC2 controller. (R/W)

APB_SARADC_TIMER_TARGET Set SAR ADC timer target. (R/W)

APB_SARADC_TIMER_EN Enable SAR ADC timer trigger. (R/W)

Register 39.58. APB_SARADC_FILTER_CTRL1_REG (0x0008)

APB_SARADC_FILTER_FACTOR0										APB_SARADC_FILTER_FACTOR1										(reserved)												
31								29	28	26	25																					0
0	0							0	0	0																				0		

Reset

APB_SARADC_FILTER_FACTOR1 The filter coefficient for SAR ADC filter 1. (R/W)

APB_SARADC_FILTER_FACTOR0 The filter coefficient for SAR ADC filter 0. (R/W)

Register 39.59. APB_SARADC_SAR1_PATT_TAB1_REG (0x0018)

(reserved)								APB_SARADC_SAR1_PATT_TAB1	
31	24	23							0
0	0	0	0	0	0	0	0	0	0x0000
									Reset

APB_SARADC_SAR1_PATT_TAB1 Entries 0 ~ 3 for pattern table 1. Each entry is 6-bit. (R/W)

Register 39.60. APB_SARADC_SAR1_PATT_TAB2_REG (0x001C)

(reserved)								APB_SARADC_SAR1_PATT_TAB2	
31	24	23							0
0	0	0	0	0	0	0	0	0	0x0000
									Reset

APB_SARADC_SAR1_PATT_TAB2 Entries 4 ~ 7 for pattern table 1. Each entry is 6-bit. (R/W)

Register 39.61. APB_SARADC_SAR1_PATT_TAB3_REG (0x0020)

(reserved)								APB_SARADC_SAR1_PATT_TAB3	
31	24	23							0
0	0	0	0	0	0	0	0	0	0x0000
									Reset

APB_SARADC_SAR1_PATT_TAB3 Entries 8 ~ 11 for pattern table 1. Each entry is 6-bit. (R/W)

Register 39.64. APB_SARADC_FILTER_CTRL0_REG (0x003C)

APB_SARADC_FILTER_RESET		(reserved)		APB_SARADC_FILTER_CHANNEL0		APB_SARADC_FILTER_CHANNEL1		(reserved)	
31	30	24	23	19	18	14	13	0	
0	0	0	0	0	0	0	0	0	0
				0xd		0xd		0 0 0 0 0 0 0 0 0 0	
Reset									

APB_SARADC_FILTER_CHANNEL1 Configure the filter channel for SAR ADC filter 1. (R/W)

APB_SARADC_FILTER_CHANNEL0 Configure the filter channel for SAR ADC filter 0. (R/W)

APB_SARADC_FILTER_RESET Reset SAR ADC filter. (R/W)

Register 39.65. APB_SARADC_THRES0_CTRL_REG (0x0044)

(reserved)		APB_SARADC_THRES0_LOW		APB_SARADC_THRES0_HIGH		APB_SARADC_THRES0_CHANNEL	
31	30	18	17	5	4	0	
0	0			0x1fff		13	
Reset							

APB_SARADC_THRES0_CHANNEL Configure the channel for SAR ADC threshold monitor 0. (R/W)

APB_SARADC_THRES0_HIGH Set the high threshold for SAR ADC threshold monitor 0. (R/W)

APB_SARADC_THRES0_LOW Set the low threshold for SAR ADC threshold monitor 0. (R/W)

Register 39.68. APB_SARADC_DMA_CONF_REG (0x006C)

APB_SARADC_APB_ADC_TRANS		(reserved)														APB_SARADC_APB_ADC_EOF_NUM				
31	30	29															16	15	0	
0	0	0	0	0	0	0	0	0	0	0	0	0	0	0	0	0	0	255	Reset	

APB_SARADC_APB_ADC_EOF_NUM DMA_IN_SUC_EOF is generated when the sample count is equal to apb_adc_eof_num. (R/W)

APB_SARADC_APB_ADC_RESET_FSM Reset DIG ADC controller status. (R/W)

APB_SARADC_APB_ADC_TRANS When this bit is set, DIG ADC controller uses DMA. (R/W)

Register 39.69. APB_SARADC_APB_ADC_CLKM_CONF_REG (0x0070)

(reserved)							APB_SARADC_CLK_SEL				(reserved)				APB_SARADC_CLKM_DIV_A				APB_SARADC_CLKM_DIV_B				APB_SARADC_CLKM_DIV_NUM				
31							23	22	21	20	19			14	13			8	7			4	0				
0	0	0	0	0	0	0	0	0	0	0	0	0	0x0	0x0	0x0	0x0	0x0	0x0	0x0	0x0	4	0	Reset				

APB_SARADC_CLKM_DIV_NUM The integer part of ADC clock divider. Divider value = APB_SARADC_CLKM_DIV_NUM + APB_SARADC_CLKM_DIV_B/APB_SARADC_CLKM_DIV_A. (R/W)

APB_SARADC_CLKM_DIV_B The numerator value of fractional clock divider. (R/W)

APB_SARADC_CLKM_DIV_A The denominator value of fractional clock divider. (R/W)

APB_SARADC_CLK_SEL Select clock source. 0: clock off. 1: select PLL_D2_CLK as the clock source. 2: select APB_CLK as the clock source. (R/W)

Register 39.70. APB_SARADC_APB_SARADC1_DATA_STATUS_REG (0x0040)

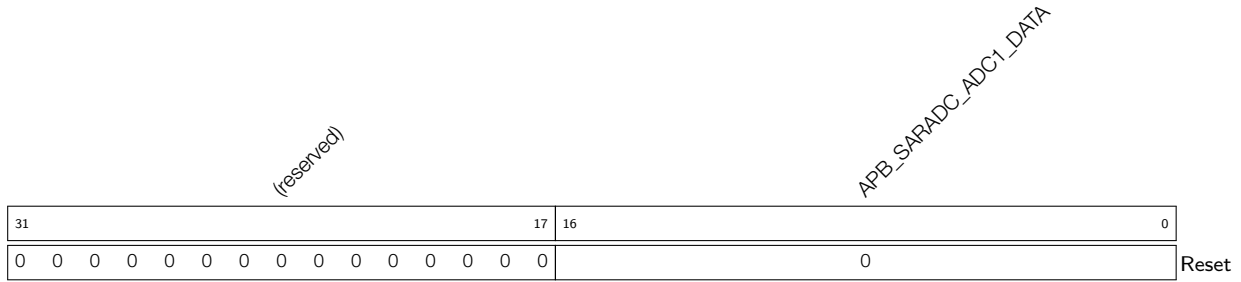

APB_SARADC_ADC1_DATA Raw sample data from SAR ADC1. (RO)

Register 39.71. APB_SARADC_APB_SARADC2_DATA_STATUS_REG (0x0078)

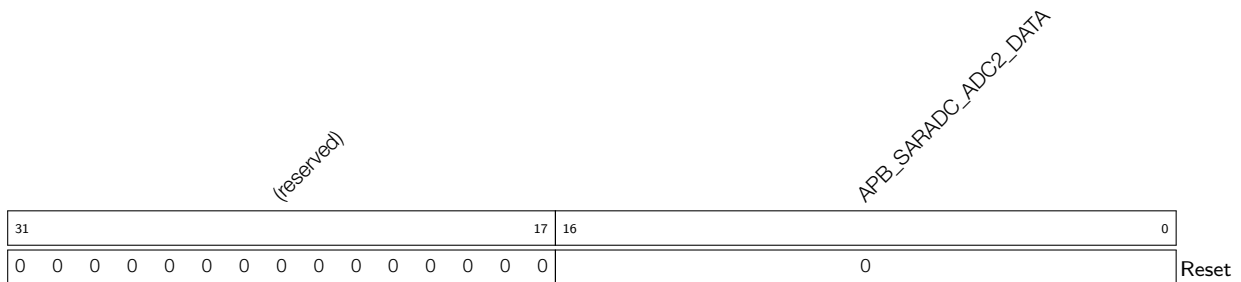

APB_SARADC_ADC2_DATA Raw sample data from SAR ADC2. (RO)

Register 39.72. APB_SARADC_INT_ENA_REG (0x005C)

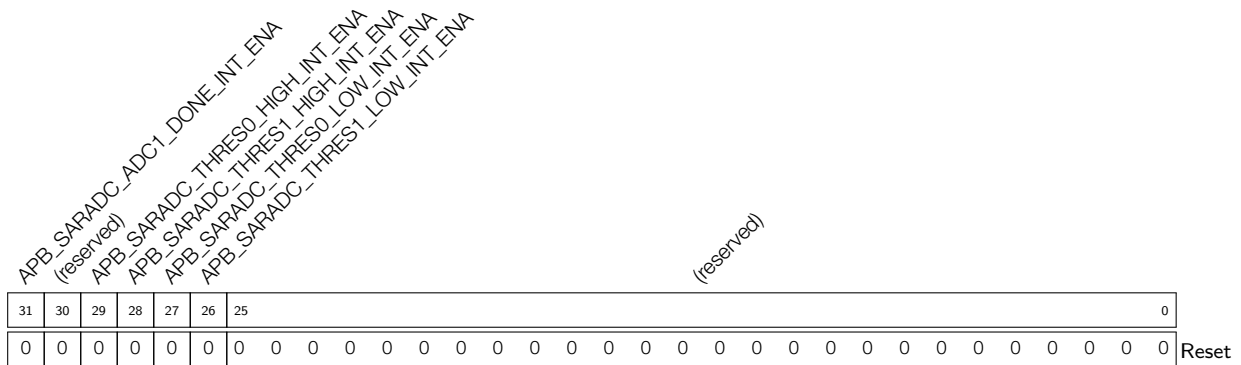

- APB_SARADC_THRES1_LOW_INT_ENA** Enable bit of [APB_SARADC_THRES1_LOW_INT](#). (R/W)
- APB_SARADC_THRES0_LOW_INT_ENA** Enable bit of [APB_SARADC_THRES0_LOW_INT](#). (R/W)
- APB_SARADC_THRES1_HIGH_INT_ENA** Enable bit of [APB_SARADC_THRES1_HIGH_INT](#). (R/W)
- APB_SARADC_THRES0_HIGH_INT_ENA** Enable bit of [APB_SARADC_THRES0_HIGH_INT](#). (R/W)
- APB_SARADC_ADC1_DONE_INT_ENA** Enable bit of [APB_SARADC_ADC1_DONE_INT](#). (R/W)

40 Related Documentation and Resources

Related Documentation

- [ESP32-S3 Series Datasheet](#) – Specifications of the ESP32-S3 hardware.
- [ESP32-S3 Hardware Design Guidelines](#) – Guidelines on how to integrate the ESP32-S3 into your hardware product.
- [ESP32-S3 Series SoC Errata](#) – Descriptions of known errors in ESP32-S3 series of SoCs.
- *Certificates*
<https://espressif.com/en/support/documents/certificates>
- *ESP32-S3 Product/Process Change Notifications (PCN)*
<https://espressif.com/en/support/documents/pcns?keys=ESP32-S3>
- *ESP32-S3 Advisories* – Information on security, bugs, compatibility, component reliability.
<https://espressif.com/en/support/documents/advisories?keys=ESP32-S3>
- *Documentation Updates and Update Notification Subscription*
<https://espressif.com/en/support/download/documents>

Developer Zone

- [ESP-IDF Programming Guide for ESP32-S3](#) – Extensive documentation for the ESP-IDF development framework.
- *ESP-IDF* and other development frameworks on GitHub.
<https://github.com/espressif>
- *ESP32 BBS Forum* – Engineer-to-Engineer (E2E) Community for Espressif products where you can post questions, share knowledge, explore ideas, and help solve problems with fellow engineers.
<https://esp32.com/>
- *The ESP Journal* – Best Practices, Articles, and Notes from Espressif folks.
<https://blog.espressif.com/>
- See the tabs *SDKs and Demos, Apps, Tools, AT Firmware*.
<https://espressif.com/en/support/download/sdk-demos>

Products

- *ESP32-S3 Series SoCs* – Browse through all ESP32-S3 SoCs.
<https://espressif.com/en/products/socs?id=ESP32-S3>
- *ESP32-S3 Series Modules* – Browse through all ESP32-S3-based modules.
<https://espressif.com/en/products/modules?id=ESP32-S3>
- *ESP32-S3 Series DevKits* – Browse through all ESP32-S3-based devkits.
<https://espressif.com/en/products/devkits?id=ESP32-S3>
- *ESP Product Selector* – Find an Espressif hardware product suitable for your needs by comparing or applying filters.
<https://products.espressif.com/#/product-selector?language=en>

Contact Us

- See the tabs *Sales Questions, Technical Enquiries, Circuit Schematic & PCB Design Review, Get Samples* (Online stores), *Become Our Supplier, Comments & Suggestions*.
<https://espressif.com/en/contact-us/sales-questions>

Glossary

Abbreviations for Peripherals

AES	AES (Advanced Encryption Standard) Accelerator
BOOTCTRL	Chip Boot Control
DS	Digital Signature
DMA	DMA (Direct Memory Access) Controller
eFuse	eFuse Controller
HMAC	HMAC (Hash-based Message Authentication Code) Accelerator
I2C	I2C (Inter-Integrated Circuit) Controller
I2S	I2S (Inter-IC Sound) Controller
LEDC	LED Control PWM (Pulse Width Modulation)
MCPWM	Motor Control PWM (Pulse Width Modulation)
PCNT	Pulse Count Controller
RMT	Remote Control Peripheral
RNG	Random Number Generator
RSA	RSA (Rivest Shamir Adleman) Accelerator
SDHOST	SD/MMC Host Controller
SHA	SHA (Secure Hash Algorithm) Accelerator
SPI	SPI (Serial Peripheral Interface) Controller
SYSTIMER	System Timer
TIMG	Timer Group
TWAI	Two-wire Automotive Interface
UART	UART (Universal Asynchronous Receiver-Transmitter) Controller
ULP Coprocessor	Ultra-low-power Coprocessor
USB OTG	USB On-The-Go
WDT	Watchdog Timers

Abbreviations Related to Registers

REG	Register.
SYSREG	System registers are a group of registers that control system reset, memory, clocks, software interrupts, power management, clock gating, etc.
ISO	Isolation. If a peripheral or other chip component is powered down, the pins, if any, to which its output signals are routed will go into a floating state. ISO registers isolate such pins and keep them at a certain determined value, so that the other non-powered-down peripherals/devices attached to these pins are not affected.
NMI	Non-maskable interrupt is a hardware interrupt that cannot be disabled or ignored by the CPU instructions. Such interrupts exist to signal the occurrence of a critical error.

- W1TS Abbreviation added to names of registers/fields to indicate that such register/field should be used to set a field in a corresponding register with a similar name. For example, the register `GPIO_ENABLE_W1TS_REG` should be used to set the corresponding fields in the register `GPIO_ENABLE_REG`.
- W1TC Same as *W1TS*, but used to clear a field in a corresponding register.

Access Types for Registers

Sections *Register Summary* and *Register Description* in TRM chapters specify access types for registers and their fields.

Most frequently used access types and their combinations are as follows:

- RO
- WT
- R/W
- WL
- R/W/SC
- R/W/SS
- R/W/SS/SC
- R/WC/SS
- R/WC/SC
- R/WC/SS/SC
- R/WS/SC
- R/WS/SS
- R/WS/SS/SC
- R/SS/WTC
- R/SC/WTC
- R/SS/SC/WTC
- RF/WF
- R/SS/RC

Descriptions of all access types are provided below.

- R **Read.** User application can read from this register/field; usually combined with other access types.
- RO **Read only.** User application can only read from this register/field.
- HRO **Hardware Read Only.** Only hardware can read from this register/field; used for storing default settings for variable parameters.
- W **Write.** User application can write to this register/field; usually combined with other access types.
- WO **Write only.** User application can only write to this register/field.
- SS **Self set.** On a specified event, hardware automatically writes 1 to this register/field; used with 1-bit fields.
- SC **Self clear.** On a specified event, hardware automatically writes 0 to this register/field; used with 1-bit and multi-bit fields.
- SM **Self modify.** On a specified event, hardware automatically writes a specified value to this register/field; used with multi-bit fields.
- RS **Read to set.** If user application reads from this register/field, hardware automatically writes 1 to it.
- RC **Read to clear.** If user application reads from this register/field, hardware automatically writes 0 to it.
- RF **Read from FIFO.** If user application writes new data to FIFO, the register/field automatically reads it.
- WF **Write to FIFO.** If user application writes new data to this register/field, it automatically passes the data to FIFO via APB bus.
- WS **Write any value to set.** If user application writes to this register/field, hardware automatically sets this register/field.
- W1S **Write 1 to set.** If user application writes 1 to this register/field, hardware automatically sets this register/field.
- W0S **Write 0 to set.** If user application writes 0 to this register/field, hardware automatically sets this register/field.
- WC **Write any value to clear.** If user application writes to this register/field, hardware automatically clears this register/field.

- W1C **Write 1 to clear.** If user application writes 1 to this register/field, hardware automatically clears this register/field.
- W0C **Write 0 to clear.** If user application writes 0 to this register/field, hardware automatically clears this register/field.
- WT **Write 1 to trigger an event.** If user application writes 1 to this field, this action triggers an event (pulse in the APB bus) or clears a corresponding WTC field (see WTC).
- WTC **Write to clear.** Hardware automatically clears this field if user application writes 1 to the corresponding WT field (see WT).
- W1T **Write 1 to toggle.** If user application writes 1 to this field, hardware automatically inverts the corresponding field; otherwise - no effect.
- W0T **Write 0 to toggle.** If user application writes 0 to this field, hardware automatically inverts the corresponding field; otherwise - no effect.
- WL **Write if a lock is deactivated.** If the lock is deactivated, user application can write to this register/field.

Revision History

Date	Version	Release notes
2023-03-02	v1.2	<p>Updated the following chapters:</p> <ul style="list-style-type: none"> • Chapter 4 <i>System and Memory</i>: Updated the description for Internal ROM 1 in Section 4.3.2 <i>Internal Memory</i> • Chapter 10 <i>Low-power Management (RTC_CNTL)</i>: Removed UART as a reject to sleep cause • Chapter 12 <i>Timer Group (TIMG)</i>: Updated the procedures to read the timer's value • Chapter 17 <i>System Registers (SYSTEM)</i>: Added descriptions about the <code>SYSTEM_PERIP_RST_EN0_REG</code> and <code>SYSTEM_PERIP_CLK_EN0_REG</code> registers • Chapter 26 <i>UART Controller (UART)</i>: Added descriptions about the break condition • Chapter 33 <i>USB Serial/JTAG Controller (USB_SERIAL_JTAG)</i>: Added descriptions about IO pad state change in USB-OTG download mode • Chapter 35 <i>LED PWM Controller (LEDC)</i>: Added the formula to calculate duty cycle resolution and Table <i>Commonly-used Frequencies and Resolutions</i> • Chapter 39 <i>On-Chip Sensors and Analog Signal Processing</i>: Added descriptions about the <code>APB_SARADC_APB_SARADC1_DATA_STATUS_REG</code> register, updated the description about the <code>SENS_FORCE_XPD_SAR</code> field, and added a note about the touch sensor limitation <p>Other minor updates</p>
2022-10-31	v1.1	<p>Updated the following chapters:</p> <ul style="list-style-type: none"> • Chapter 1 <i>Processor Instruction Extensions (PIE)</i> • Chapter 5 <i>eFuse Controller</i> • Chapter 39 <i>On-Chip Sensors and Analog Signal Processing</i> <p>Updated the Glossary section</p>
2022-09-08	v1.0	<p>Added the following chapter:</p> <ul style="list-style-type: none"> • Chapter 1 <i>Processor Instruction Extensions (PIE)</i> <p>Updated the following chapters:</p> <ul style="list-style-type: none"> • Chapter 9 <i>Interrupt Matrix (INTERRUPT)</i> • Chapter 5 <i>eFuse Controller</i> • Chapter 10 <i>Low-power Management (RTC_CNTL)</i> • Chapter 25 <i>Random Number Generator (RNG)</i> • Chapter 32 <i>USB On-The-Go (USB)</i>

Cont'd on next page

Cont'd from previous page

Date	Version	Release notes
2022-08-04	v0.8	Added the following chapters: <ul style="list-style-type: none"> • Chapter 28 I2S Controller (I2S) • Chapter 30 SPI Controller (SPI) Updated the following chapters: <ul style="list-style-type: none"> • Chapter 5 eFuse Controller • Chapter 10 Low-power Management (RTC_CNTL)
2022-06-30	v0.7	Added the following chapters: <ul style="list-style-type: none"> • Chapter 39 On-Chip Sensors and Analog Signal Processing • Chapter 10 Low-power Management (RTC_CNTL) Updated the following chapters: <ul style="list-style-type: none"> • Chapter 4 System and Memory • Updated clock names: <ul style="list-style-type: none"> – FOSC_CLK: renamed as RC_FAST_CLK – FOSC_DIV_CLK: renamed as RC_FAST_DIV_CLK – RTC_CLK: renamed as RC_SLOW_CLK – SLOW_CLK: renamed as RTC_SLOW_CLK – FAST_CLK: renamed as RTC_FAST_CLK – PLL_80M_CLK: renamed as PLL_F80M_CLK – PLL_160M_CLK: renamed as PLL_F160M_CLK – PLL_240M_CLK: renamed as PLL_D2_CLK
2022-06-01	v0.6	Updated the following chapters: <ul style="list-style-type: none"> • Chapter 3 GDMA Controller (GDMA) • Chapter 5 eFuse Controller • Chapter 8 Chip Boot Control
2022-04-06	v0.5	Added the following chapters: <ul style="list-style-type: none"> • Chapter 15 Permission Control (PMS) • Chapter 16 World Controller (WCL) Updated the following chapter: <ul style="list-style-type: none"> • Chapter 4 System and Memory
2022-02-24	v0.4	Added Chapter 29 LCD and Camera Controller (LCD_CAM) Updated the following chapters: <ul style="list-style-type: none"> • Chapter 2 ULP Coprocessor (ULP-FSM, ULP-RISC-V) • Chapter 5 eFuse Controller • Chapter 6 IO MUX and GPIO Matrix (GPIO, IO MUX) • Chapter 7 Reset and Clock • Chapter 8 Chip Boot Control • Chapter 32 USB On-The-Go (USB)

Cont'd on next page

Cont'd from previous page

Date	Version	Release notes
2021-12-16	v0.3	<p>Added the following chapters:</p> <ul style="list-style-type: none"> • Chapter 2 <i>ULP Coprocessor (ULP-FSM, ULP-RISC-V)</i> • Chapter 3 <i>GDMA Controller (GDMA)</i> • Chapter 11 <i>System Timer (SYSTIMER)</i> • Chapter 24 <i>Clock Glitch Detection</i> • Chapter 27 <i>I2C Controller (I2C)</i> • Chapter 36 <i>Motor Control PWM (MCPWM)</i> • Chapter 37 <i>Remote Control Peripheral (RMT)</i> <p>Updated the following chapters:</p> <ul style="list-style-type: none"> • Chapter 5 <i>eFuse Controller</i> • Chapter 20 <i>RSA Accelerator (RSA)</i> • Chapter 21 <i>HMAC Accelerator (HMAC)</i> • Chapter 22 <i>Digital Signature (DS)</i>
2021-09-30	v0.2	<p>Added the following chapters:</p> <ul style="list-style-type: none"> • Chapter 17 <i>System Registers (SYSTEM)</i> • Chapter 21 <i>HMAC Accelerator (HMAC)</i> • Chapter 23 <i>External Memory Encryption and Decryption (XTS_AES)</i> • Chapter 26 <i>UART Controller (UART)</i> • Chapter 33 <i>USB Serial/JTAG Controller (USB_SERIAL_JTAG)</i> <p>Updated the following Chapters:</p> <ul style="list-style-type: none"> • Chapter 5 <i>eFuse Controller</i> • Chapter 31 <i>Two-wire Automotive Interface (TWAI®)</i>
2021-07-09	v0.1	Preliminary release



www.espressif.com

Disclaimer and Copyright Notice

Information in this document, including URL references, is subject to change without notice.

ALL THIRD PARTY'S INFORMATION IN THIS DOCUMENT IS PROVIDED AS IS WITH NO WARRANTIES TO ITS AUTHENTICITY AND ACCURACY.

NO WARRANTY IS PROVIDED TO THIS DOCUMENT FOR ITS MERCHANTABILITY, NON-INFRINGEMENT, FITNESS FOR ANY PARTICULAR PURPOSE, NOR DOES ANY WARRANTY OTHERWISE ARISING OUT OF ANY PROPOSAL, SPECIFICATION OR SAMPLE.

All liability, including liability for infringement of any proprietary rights, relating to use of information in this document is disclaimed. No licenses express or implied, by estoppel or otherwise, to any intellectual property rights are granted herein.

The Wi-Fi Alliance Member logo is a trademark of the Wi-Fi Alliance. The Bluetooth logo is a registered trademark of Bluetooth SIG.

All trade names, trademarks and registered trademarks mentioned in this document are property of their respective owners, and are hereby acknowledged.

Copyright © 2023 Espressif Systems (Shanghai) Co., Ltd. All rights reserved.