

Type-C TO UART

FLASH

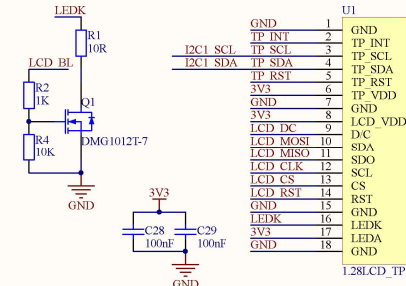

RP2040-Touch-LCD-1.28 PCB: 1.0mm

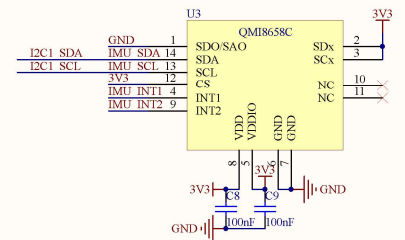
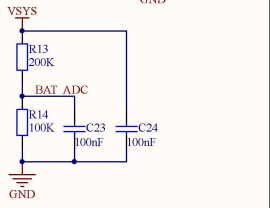
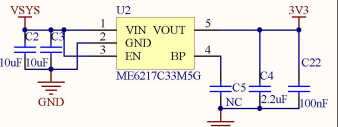
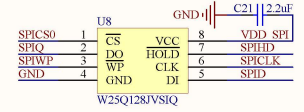
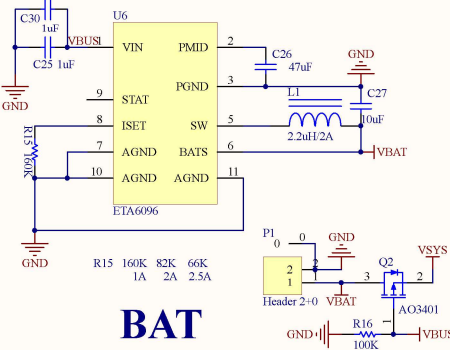
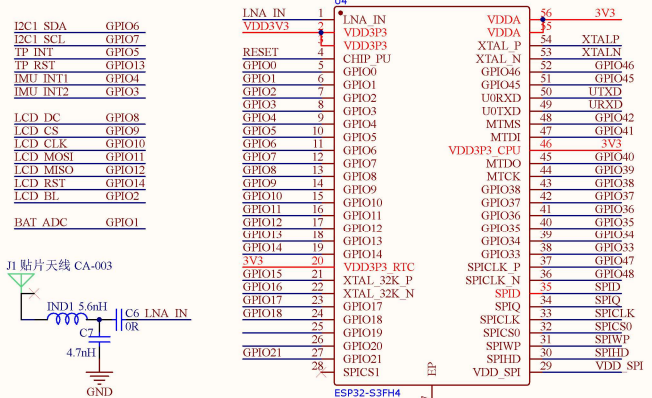
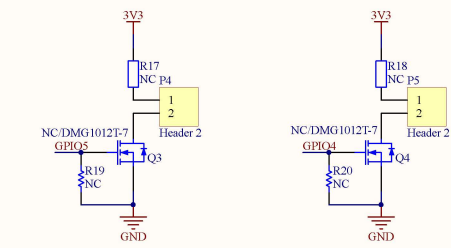

BAT

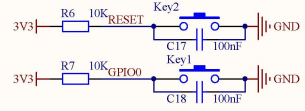

XTAL

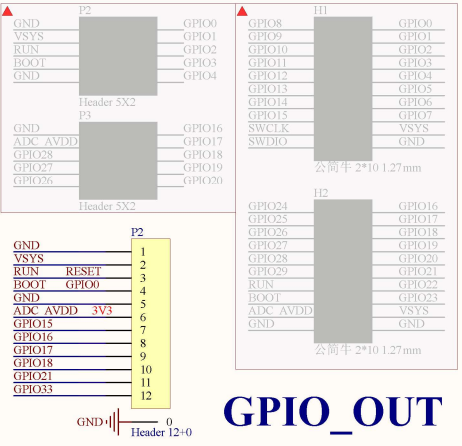
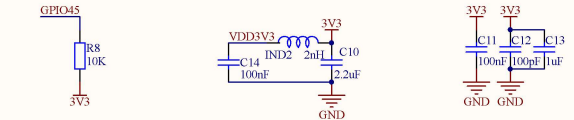
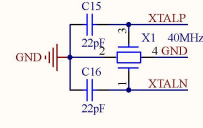

GPIO_OUT

ESP32-S3-Touch-LCD-1.28

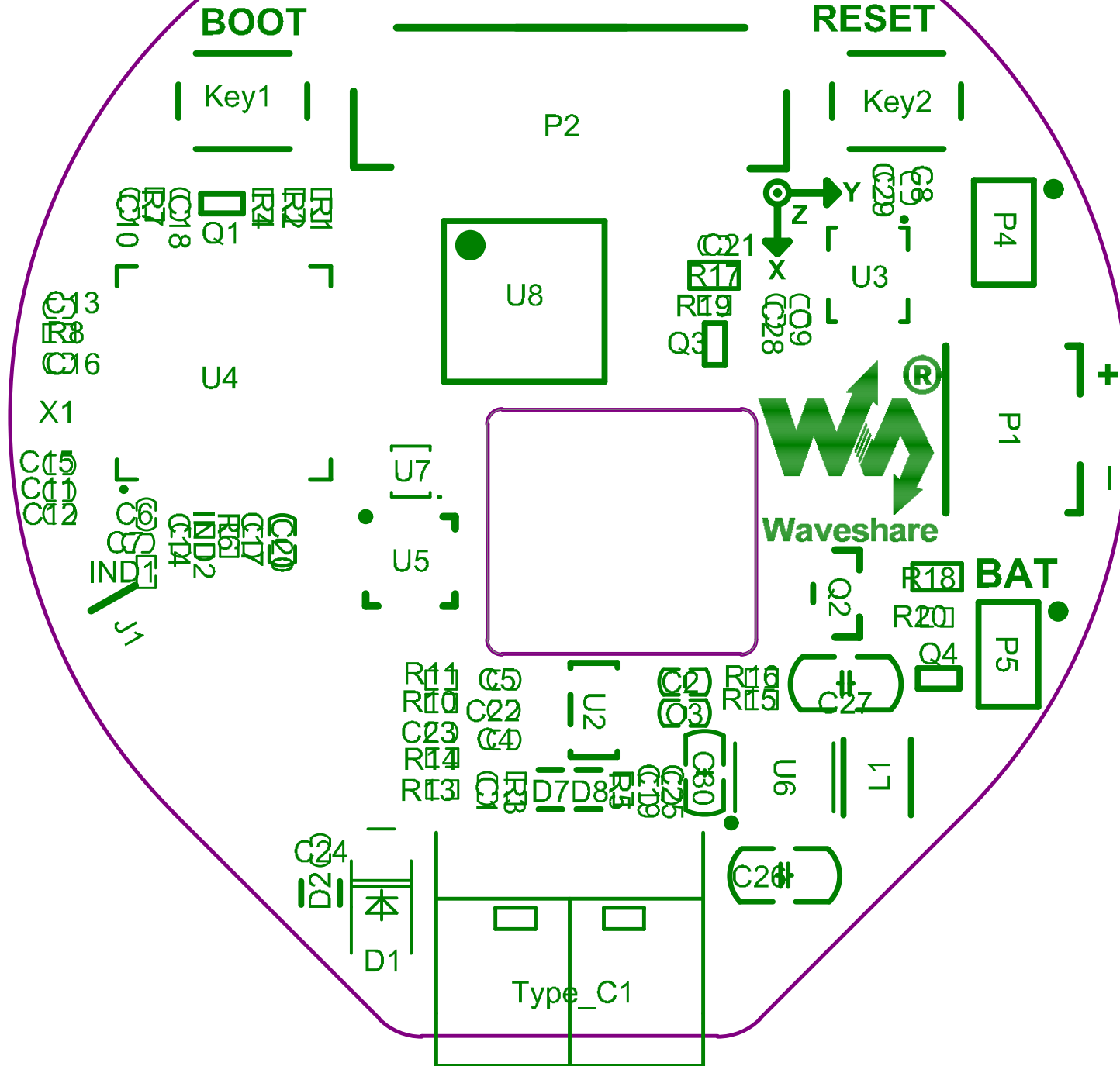

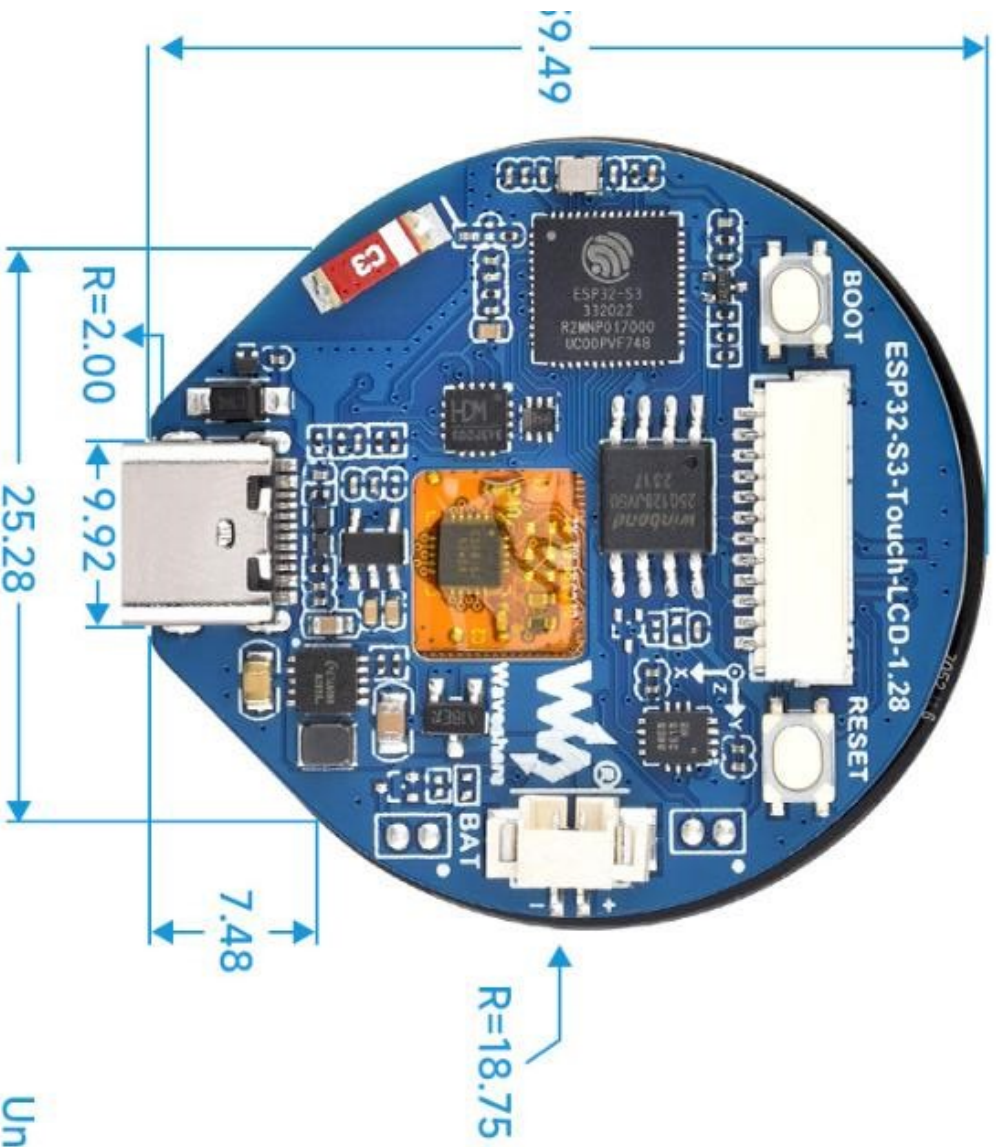
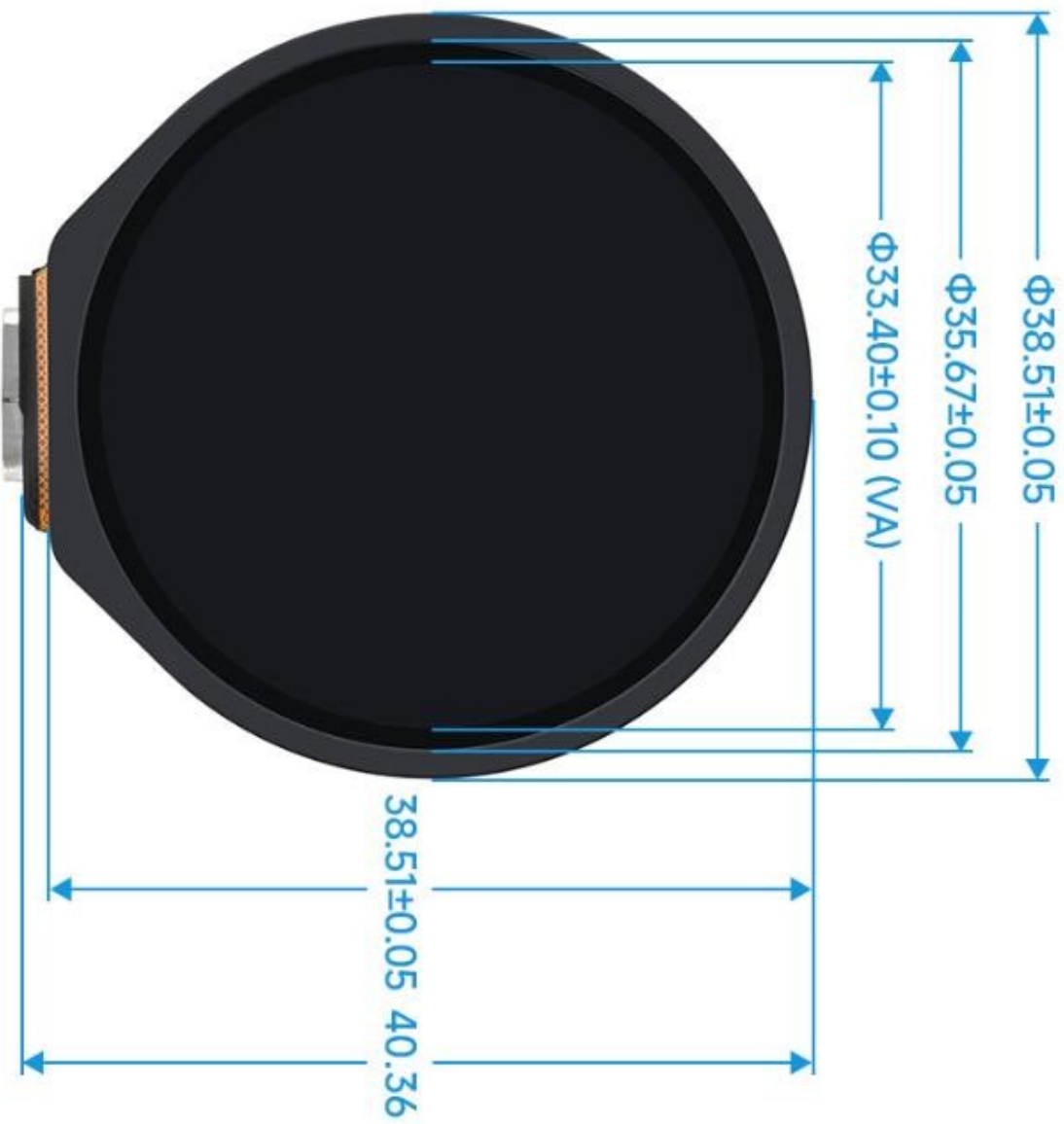

Unit:mm