

USB

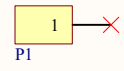

Thermal USB Camera

Type_C1

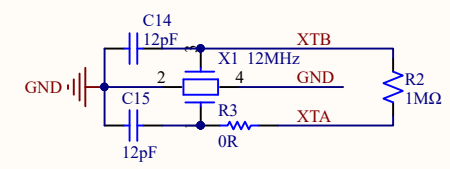
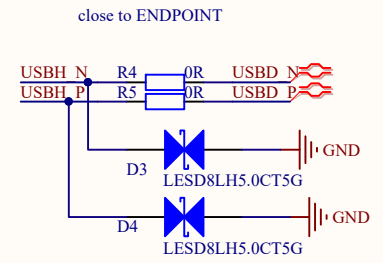
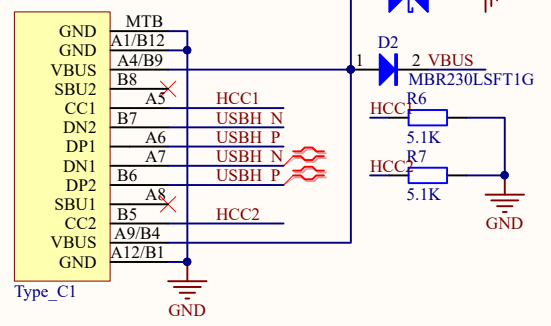

D11
D31
D41

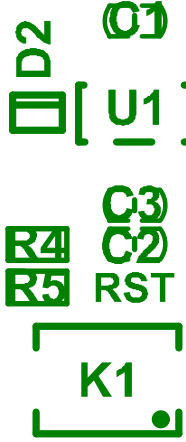

R4
R5
RST



C2
C3

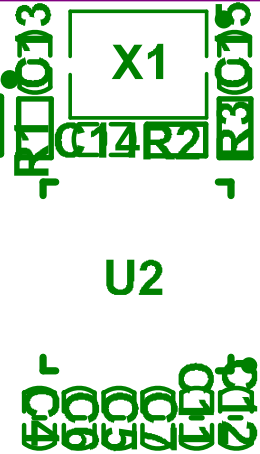

X1

C14
R2

R3
R15

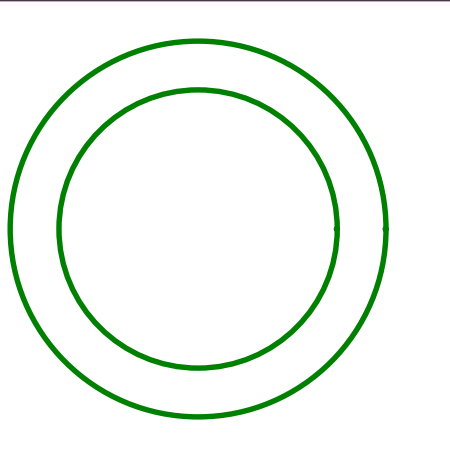

P1



C8
FB1
C9
C10

FPC1



