

USB Connector

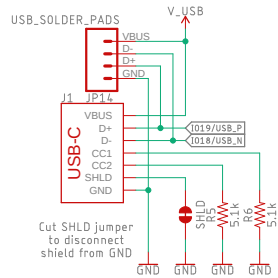

USB Differential Lines:
Width: 9.5mils
Spacing: 5mils
Conductor Height: 8.3mils
ZDifferential: 90 Ohms

3v3 Regulator – RT9080

Voltage Input Max: 5.5V
Current Max: 600mA

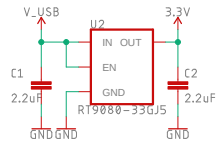

WiFi Module – ESP32–C3 MINI–1

VDD Range:
3.0V – 3.6V

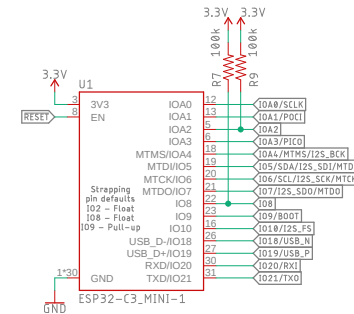

Castellated Headers

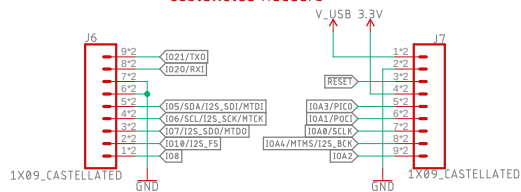

Buttons

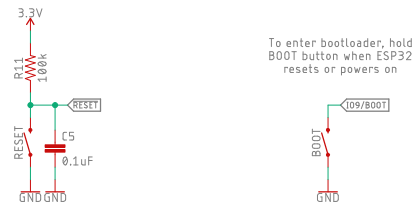

I2C Pullups

Cut I2C jumper to remove pull up resistors

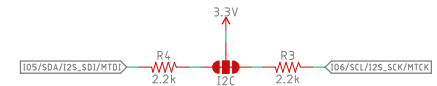

Qwiic Connector

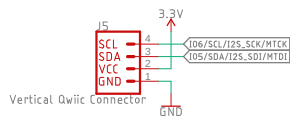

LED

Cut PWR or STAT jumper to remove Power or Stat LEDs respectively.

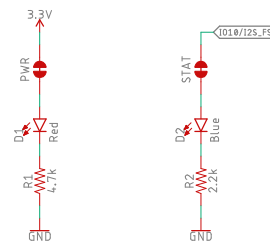

JTAG Connection Points

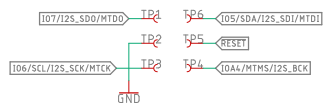

Released under the Creative Commons Attribution Share-Alike 4.0 License
<https://creativecommons.org/licenses/by-sa/4.0/>

TITLE: SparkFun_Dev_ESP32_C3_MINI

Design by: Elias Santistevan

REV:
v10

Date: 12/1/2023 2:17 PM

Sheet: 1/1