

e-Paper

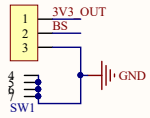

BS	VCC	GND
Interface	3-line SPI	4-line SPI

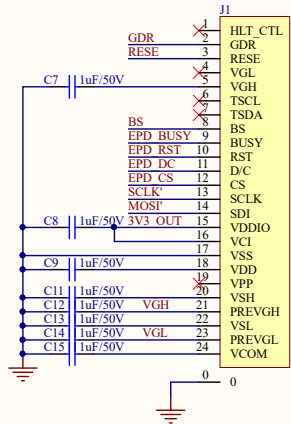

Level conversion

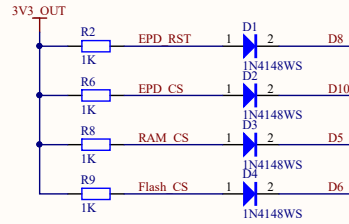
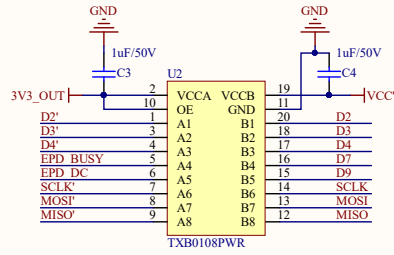

SPI RAM

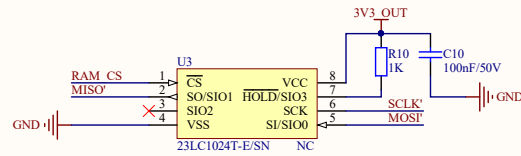

Flash

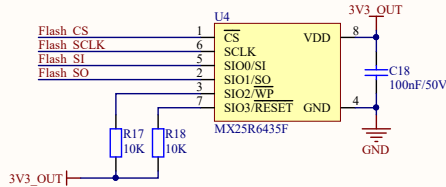
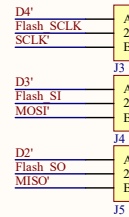

Power

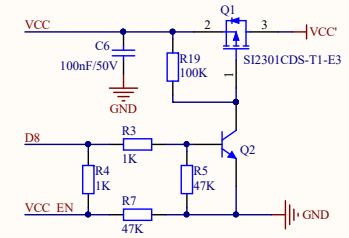
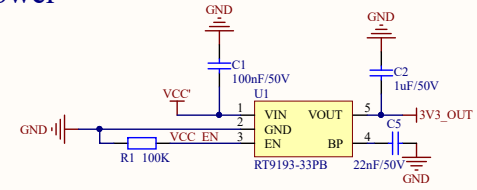

Waveshare e-Paper Shield (B)

Interface

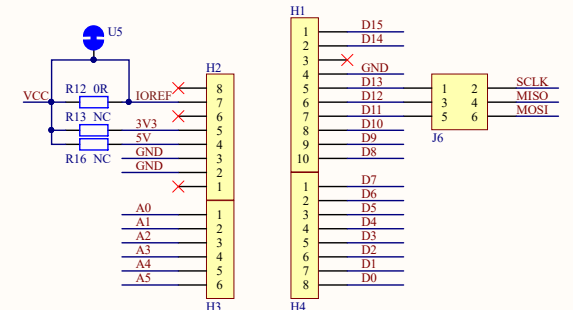
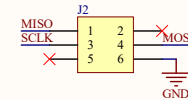

A

B

C

D

A

B

C

D

e-Paper Shield (B)

NC
IOREF
NRST
3V3
5V
GND
GND
VIN
A0
A1
A2
A3
A4
A5

D15
D14
AVDD
GND
D13
D12
D11
D10
D9
D8
D7
D6
D5
D4
D3
D2
D1
D0

A B



1 0



A	3R
B	0.47R

1	3-line SPI
0	4-line SPI





D13
D12
D11

0	Flash config	1
D4'	Flash_SCLK	SCLK'
D3'	Flash_SI	MOSI'
D2'	Flash_SO	MISO'



ICSP

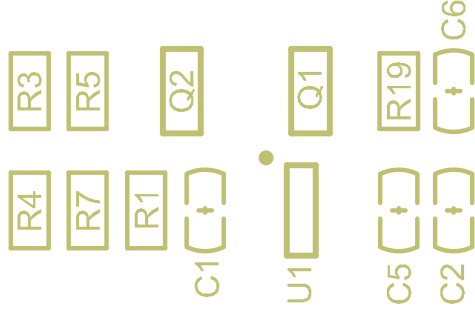

VCC
 U5
 R12 IOREF
 R13 3.3V
 R16 5V

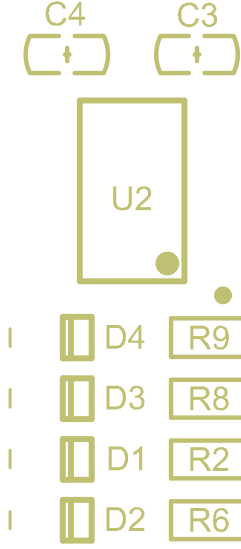

Flash config

