

Pin Port

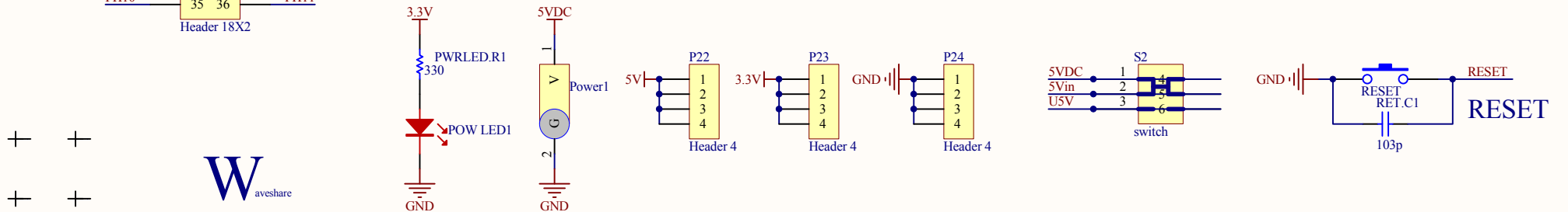

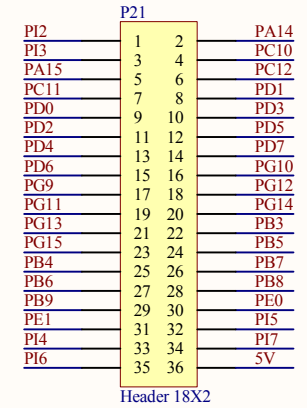

SPI2 SPI1

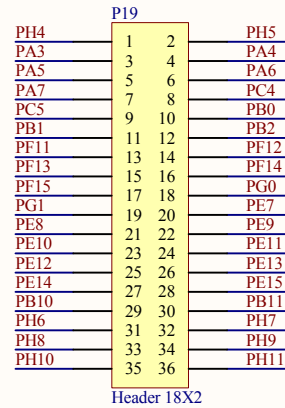
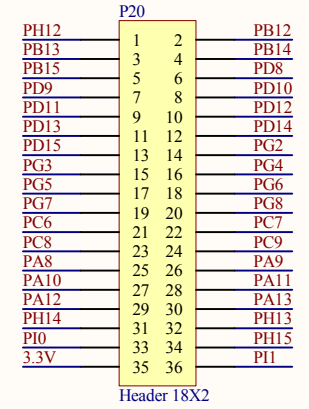
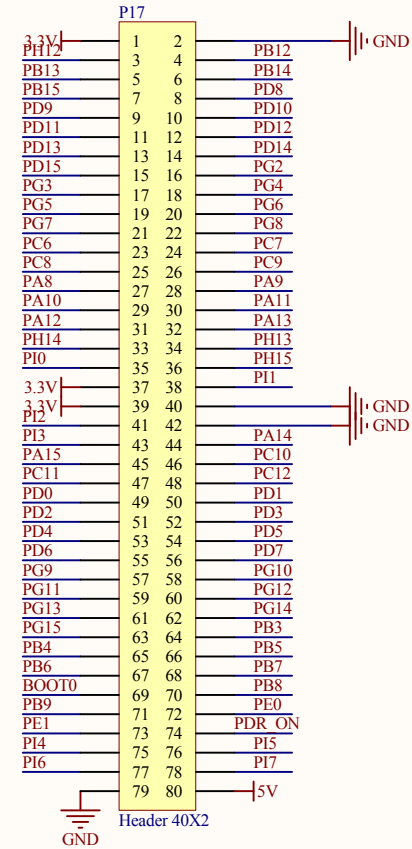
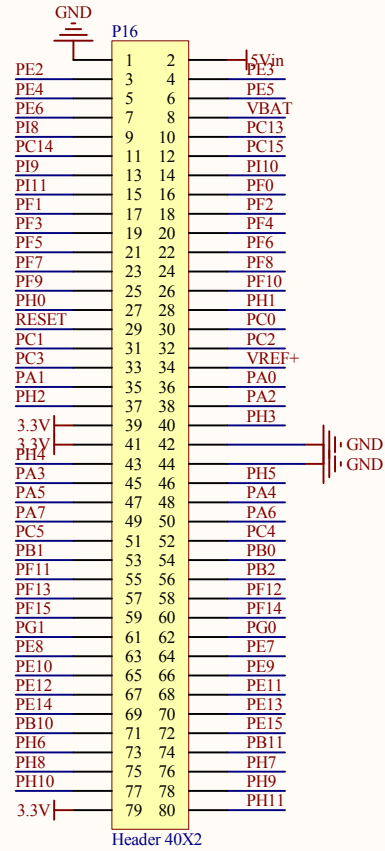
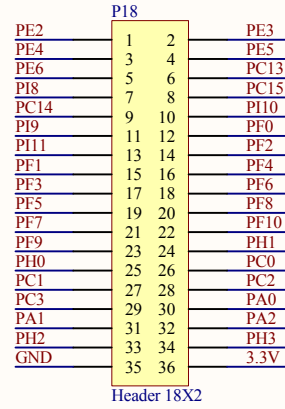
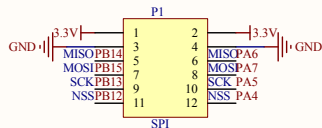
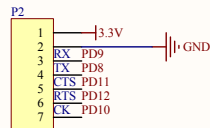

USART3

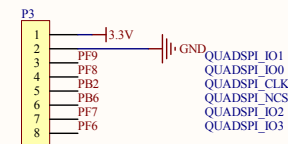

QUADSPI

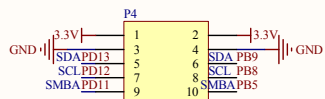

I2C2 I2C1

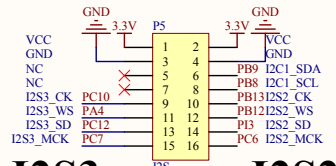

I2S3 I2S2

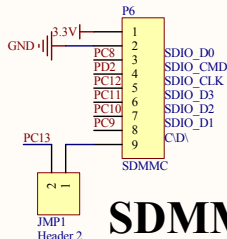

SDMMC

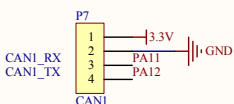

CAN1

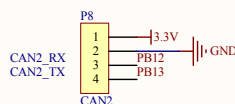

CAN2

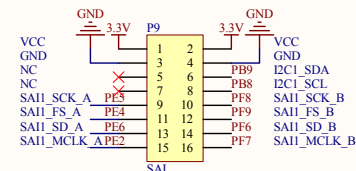

SAI_A SAI_B

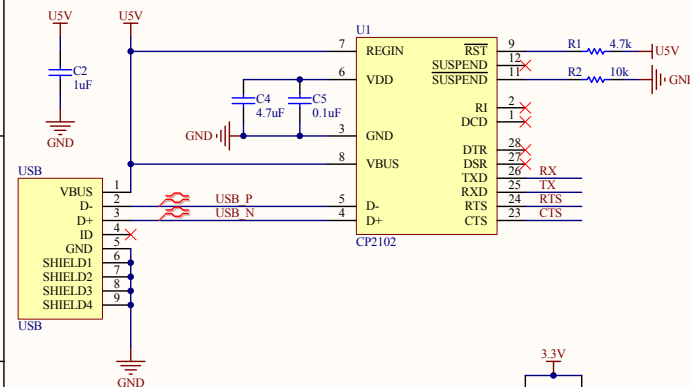

UART1

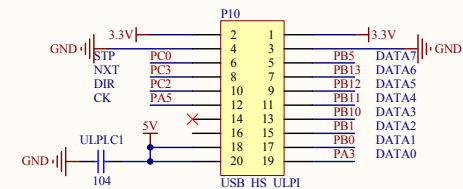

USB HS ULPI

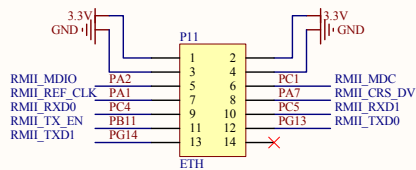

ETH

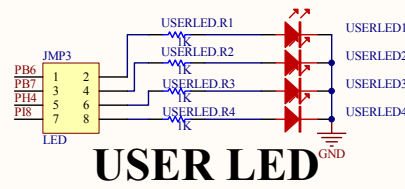

USER LED

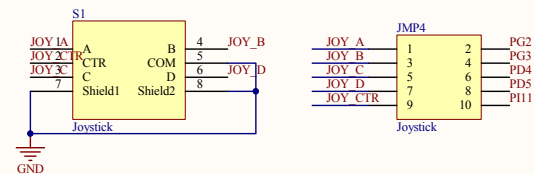

Joystick

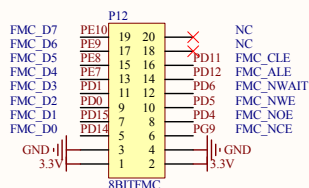

NAND FLASH

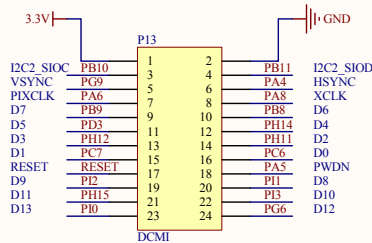

DCMI

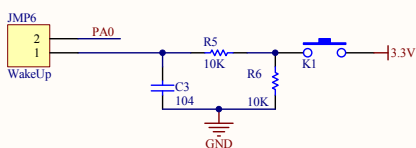

WakeUp Button

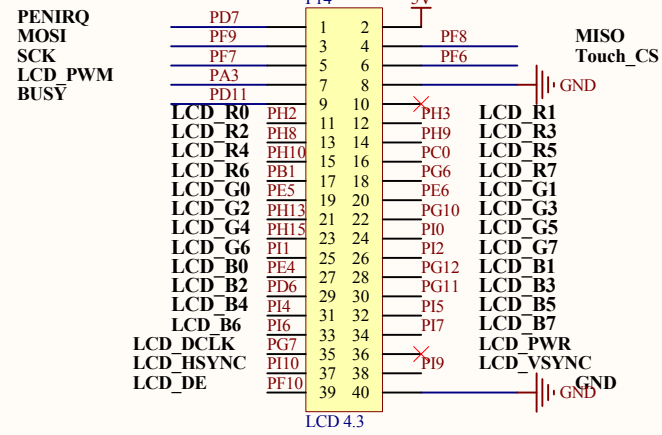

LCD 4.3inch

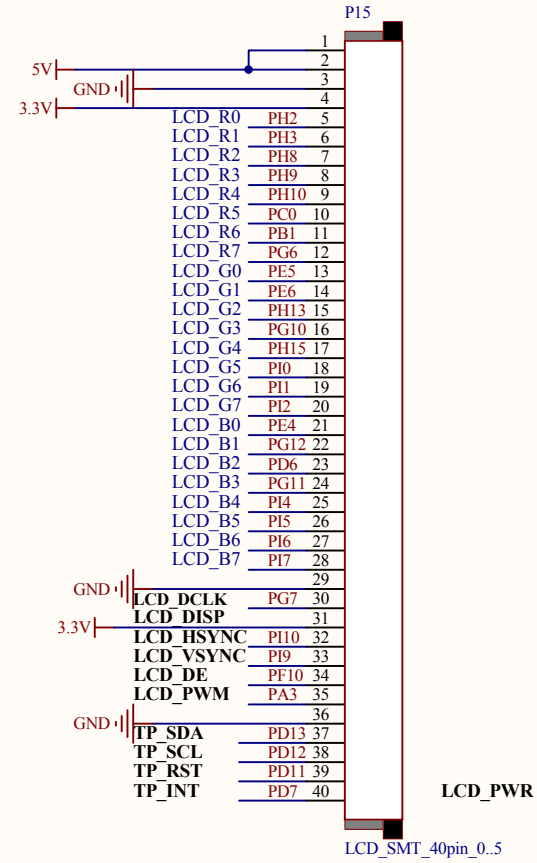

LCD 7inch

