



RS232/485 TO WIFI ETH (B)

User Manual



Figure RS232/485 TO WIFI ETH (B)

1. OVERVIEW

Features:

- Support 802.11b/g/n wireless standard.
- Supports fast networking protocol.
- Support router and bridge modes.
- Supports communication via RS232/485 to WiFi and Ethernet interfaces.
- Rich status indicator: PWR, LINK, RXD, TXD.
- Wide-range voltage DC 6-36V input, supporting screw terminals and power supply methods.
- The operating modes can be selected as transparent transmission mode, serial command mode, HTTP Client Mode, Modbus mode, and AT command mode.
- Support registering MAC, transparent cloud, and customized registration packets.
- Supports custom heartbeat packets, socket distribution protocols, and Modbus polling functions.
- Support timeout reboot, timed reboot function and so on.
- Support MQTT function, can access Ali cloud and other IoT cloud platforms.
- Support hardware watchdog, making the system more stable.
- Supports serial port free framing and automatic framing, resulting in higher forwarding efficiency.
- Support Websocket function to achieve real-time interaction between serial ports and web pages.
- Support four parameter configuration methods: web page, software settings, serial AT command, and network AT command.
- Supports one click (pressing the RELOAD button for more than 5 seconds) to restore factory settings.
- Long communication distance, with two serial servers transmitting 150 meters to each other.
- Guide rail design for easy and convenient installation.

CATALOGUE

1. Overview	2
2. Quick get start	6
2.1 Hardware Connection	6
2.2 network connections	7
2.3 Data transmission test	9
3. Overview	10
3.1 Introduction	10
3.2 electrical parameter	10
3.3 Product appearance	12
3.4 Operating indicator and key	12
3.5 Interface description	13
3.6 Outline dimensions	14
3.7 Application scenarios	15
4. Product Parameters Setting	16
4.1 Web management page	16
4.1.1 Open the management page	16
4.1.2 Quick configuration page	17
4.1.3 Mode selection page	18
4.1.4 Wireless access point settings page	18
4.1.5 Wireless terminal settings page	19
4.1.6 Serial port and network settings page	20
4.1.7 Ethernet function settings	22
4.1.8 HTTPDClient mode page	22
4.1.9 MQTT function settings page	24
4.1.10 Module Management Page	25
4.2 Software configuration	26
4.2.1 Download link	26
4.2.2 Software introduction	26

5. Product networking application	28
5.1 Wireless networking settings	28
5.2 Wireless networking applications	30
5.2.1 Wireless Networking Applications (AP)	30
5.2.2 Wireless networking application (STA)	31
5.2.3 Wireless networking application (AP+STA)	32
5.2.4 Wireless networking application (AP, STA)	34
5.3 Wired networking setup	35
5.4 Wired networking application	37
5.4.1 Wired networking application (APLAN)	37
5.4.2 Wired networking application (APWAN)	38
5.4.3 Wired networking application (routing)	39
5.4.4 Wired networking application (bridge)	40
6. Product function description	41
6.1 Working mode	41
6.1.1 Transparent transmission mode	41
6.1.2 Serial command mode	42
6.1.3 HTTPDCLIENT mode	44
6.1.4 ModbusTCP<=>ModbusRTU conversion mode	54
6.2 Wireless characteristics	55
6.2.1 Automatic frequency selection function	55
6.2.2 Security mechanism	55
6.2.3 STA joins the routing function	56
6.2.4 STA address binding function	56
6.3 Socket communication	56
6.4 UART framing mechanism	57
6.4.1 Serial Parameters	57
6.4.2 UART Free-Frame Mode	58
6.4.3 UART automatic framing mode	59

6.5 Password authentication when TCP establishes connection	60
6.6 Description of RFC2217 protocol	61
6.7 Fast Networking Protocol	62
6.8 Local area network search	65
6.9 Registration packet function	66
6.10 Customized heartbeat packets	67
6.11 Socket distribution function	69
6.12 Timeout reboot function	72
6.13 Timed reboot function	72
6.14 MOD BUS polling	72
6.15 KeepALIVE Function	73
6.16 Websocket function	73
6.17 MQTT function	73
6.17.1 MQTT function introduction	73
6.17.2 RS232/485 TO WIFI ETH (B) Parameter Configuration	74

2. QUICK GET START

The RS232/485 TO WIFI ETH (B) serial server supports the functions of UART to WIFI, UART to Ethernet, and Ethernet to WIFI. It can convert the RS485 serial port into a TCP/IP network interface and achieve bidirectional transparent data transmission between the RS485 serial port and WIFI/Ethernet.

This chapter provides a quick start introduction for the RS232/485 to WiFi Ethernet (B) serial server. We recommend users to seriously read this chapter and follow the instructions step by step. This will give you a comprehensive understanding of the product. Users can also choose to read specific chapters based on their interests and needs. For specific details and explanations, please refer to the following chapters.

This section primarily provides a quick start guide for the RS232/485 TO WIFI ETH (B) device in AP mode.

The following software is involved: [SSCOM.exe](#): Serial Debugging Assistant.

2.1 HARDWARE CONNECTION

The default configuration for RS232/485 to WiFi Ethernet (B) is as follows:



Figure RS232/485 TO WIFI ETH (B) default configuration

In order to test the communication conversion of RS232/485 to WiFi/Ethernet, we will connect the serial port of the RS232/485 to WiFi Ethernet (B) serial server to the serial port of the computer.

Additionally, the WiFi of the serial server will be connected to the WiFi of the computer. If the desktop does not have its own serial port and WiFi, it can be replaced by USB TO RS232/485/422/TTL and wireless network card. Hardware connection diagram as shown below:

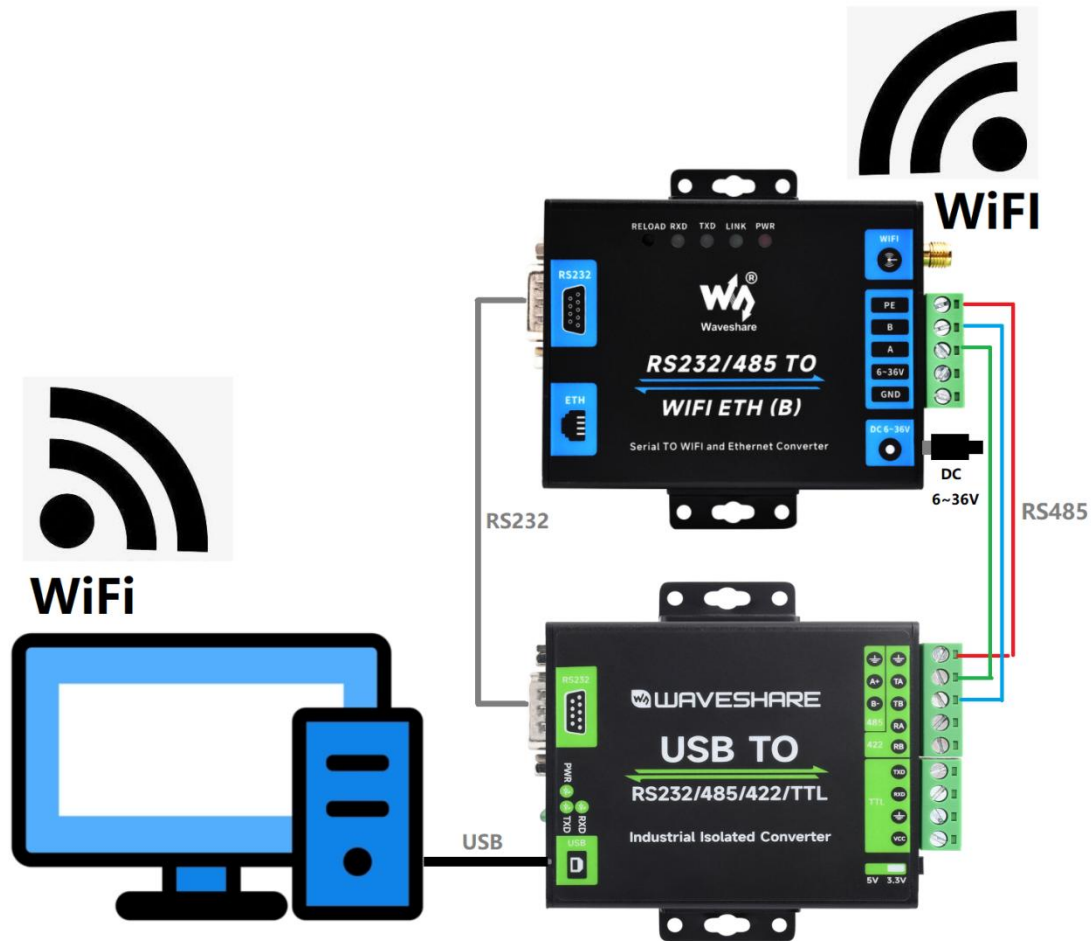

Figure Hardware Connection

According to the above figure, simply connect the antenna, power supply, and RS232 or RS485 cable to the serial server interface according to the label instructions.

2.2 NETWORK CONNECTIONS

Let's take WiFi connection as an example to introduce the network connection process.

Open the wireless network connection and search for the network. As shown in the figure below, "Waveshareuxxxx" (xxxx is the last four digits of the MAC address) is the default network name (SSID) for the serial server.

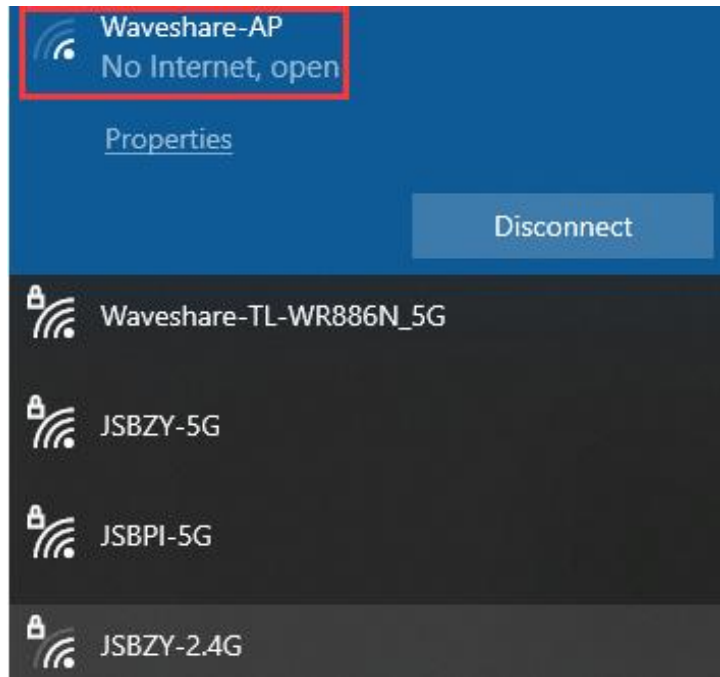

Figure Wireless Network SSID Search

Join the network, choose to automatically obtain IP, RS232/485 TO WIFI ETH (B) serial port server supports DHCP Server function and is enabled by default.

🏠 Waveshare_A690

Set as metered connection
 Off

If you set a data limit, Windows will set the metered connection setting for you to help you stay under your limit.

[Set a data limit to help control data usage on this network](#)

IP settings

IP assignment: Automatic (DHCP)

Properties

SSID:	Waveshare_A690
Protocol:	Wi-Fi 4 (802.11n)
Security type:	Open
Network band:	2.4 GHz
Network channel:	11
Link speed (Receive/Transmit):	72/72 (Mbps)
Link-local IPv6 address:	fe80::e484:b0f9:8849:c2ef%5
IPv4 address:	10.10.100.100
IPv4 DNS servers:	10.10.100.254
Manufacturer:	Realtek Semiconductor Corp.
Description:	Realtek 8811CU Wireless LAN 802.11ac USB NIC
Driver version:	1030.38.712.2019
Physical address (MAC):	90-DE-80-30-17-50

Figure Wireless Network Connection

At this point, the Link indicator on the module changes from flashing once every 1 second to flashing once every 2 seconds.

2.3 DATA TRANSMISSION TEST

The initial parameters for RS232/485 to WiFi Ethernet (B) are as follows:

- The default SSID is "Waveshare_ xxxx" ("xxxx" represents the last four digits of the module's MAC address).
- The default encryption method is "open" and "none".
- The default user serial parameters: 57600,8,1,None ;
- The default value of network parameters: TCP,Server,8899,10.10.100.254 ;
- Local IP address: 10.10.100.254

We just need to follow the appropriate parameter settings for network communication, and then bidirectional communication between the serial port and Wi-Fi can be achieved. The operation steps are as follows:

Open the testing software "SSCOM.exe". Connect to the computer's COM5 (select the appropriate port based on your situation). Choose the RS232/485 TO WIFI ETH (B) serial server's default baud rate of 57600, and click "Open Port".

Open another instance of "SSCOM.exe". In the network settings section, choose TCP Client mode. Enter the server IP address as 10.10.100.254, which is the default IP address of the module. Enter the server port number as 8899, which is the default TCP port number the module listens on. Click "Connect" to establish a TCP connection.

By now, we can test data transmission between the serial ports and network:

Data flow from the serial port to the network:

- Computer serial port → RS232/485 TO WIFI ETH (B) serial port → WiFi/Ethernet of RS232/485 TO WIFI ETH (B) → Computer network.

The data flow from the network to the serial port is:

- Computer network -> RS232/485 TO WIFI ETH (B) WiFi/Ethernet -> RS232/485 TO WiFi ETH (B) serial port -> Computer serial port. The specific demonstration is shown in the following figure:

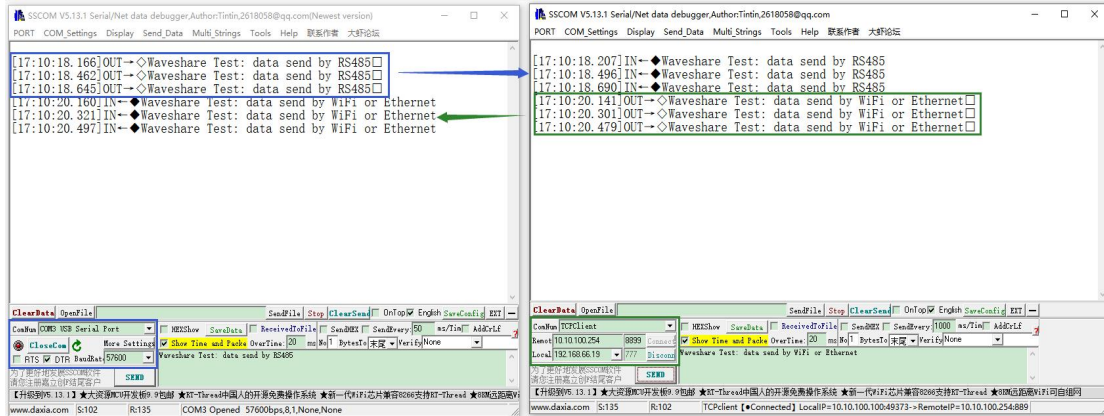

Figure Serial port/network transmission test

3. OVERVIEW

3.1 INTRODUCTION

The RS232/485 TO WIFI ETH (B) serial server supports UART-to-Wi-Fi, allowing you to convert a serial port (RS232 or RS485) into a TCP/IP network port. This enables bidirectional transparent data transmission between the serial interface (RS232 or RS485) and Wi-Fi. This enables serial devices to immediately have TCP/IP network interface functions, connect to the network for data communication, greatly expanding the communication distance of serial devices, as shown in the following figure:

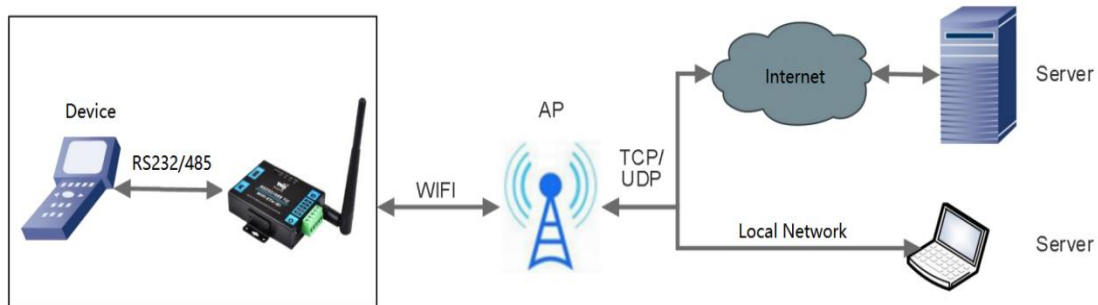

Figure Basic functions of serial server

Users do not need to worry about specific details. The module completes protocol conversion internally, and can achieve bidirectional data transmission between the serial port and WIFI through simple settings.

3.2 ELECTRICAL PARAMETER

Table Electrical Parameters

Name	Item	Index
WIRELESS SPECIFICATION	Wireless standards	802.11b/g/n
	Frequency range	2.412GHz-2.484GHz
	Transmitting power	802.11b:+19dBm (Max. @11Mbps)
		802.11g:+18dBm (Max. @54Mbps)
		+17dBm (Max. @HT20, MCS7)
		+17dBm (Max. @HT40, MCS7)
		Configured by users
	Receiving sensitivity	802.11b:-89dBm (@11Mbps)
		802.11g:-81dBm (@54Mbps)
		802.11n:-73dBm (@HT20, MCS7)
-71dBm (@HT40, MCS7)		

Data port	RS232, RS485: 300~460.8Kbps
	RS232 port (ESD/EFT protection)
	RS232 port (ESD/EFT/surge protection)
Network port	Ethernet: 10Mbps/100Mbps
Operating voltage	DC6~36V
Operating temperature	-40℃~85℃
Dimensions	109.66*28*64.71mm (L*W*H)
Wireless network	Station/AP/AP+Station mode
Security mechanism	WPA PSK/WPA2 PSK
Encryption type	TKIP/AES
Operating mode	transparent transmission mode, protocol transmission mode
Command setting	AT+Command Structure
Protocol	TCP/UDP/ARP/ICMP/DHCP/DNS/HTTP/MQTT
Maximum TCP connections	24
User Configuration	Web Server+AT Command Configuration
Customer application software	Support customer customization of application software

3.3 PRODUCT APPEARANCE

The following image shows the appearance of RS232/485 TO WIFI ETH (B):



Figure Product Appearance

3.4 OPERATING INDICATOR AND KEY

There are 4 indicator on the device, from left to right they are:

Indicator	Function	Note
RXD	Receiving data	Blinks when the serial port of the device receives data
TXD	Sending data	The device flashes when sending data through the serial port.
LINK	Operating indicator Network connection	The green indicator remains off and blinks once every 1 second. During firmware upgrades, it blinks once every 0.5 seconds. Once a WiFi connection is established, the blinking pattern changes to once every 2 seconds.
PWR	Power indicator	Always on when power input is correct

RELOAD key:

This button is the Factory Reset button. To perform a factory reset while the device is in its normal operational state (indicated by the flashing Link LED), press and hold the button for at least 5

seconds, then release it. Wait for about 10 seconds, and the RS232/485 TO WIFI ETH (B) device will automatically complete the reset process. During this process, all indicator lights except the PWR indicator will turn off, and then the Link LED will begin flashing again. This will indicate that the device's settings have been restored to their factory configuration.

3.5 INTERFACE DESCRIPTION

The hardware interfaces are as follows:

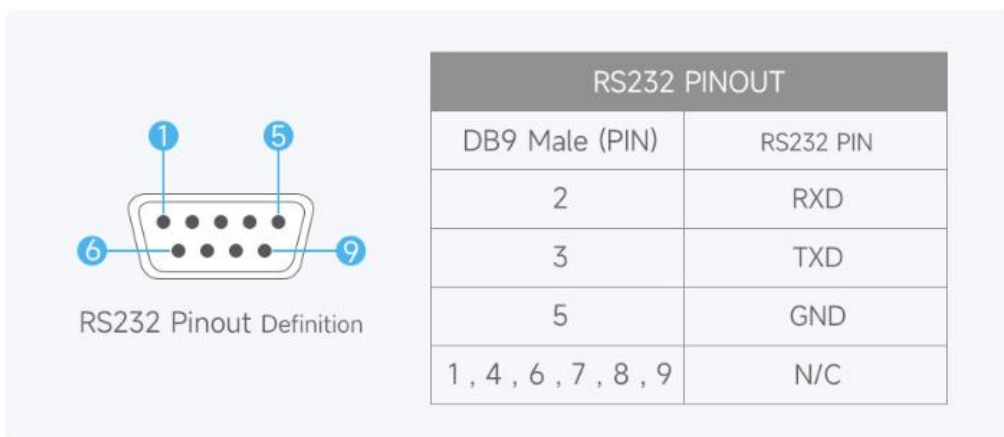
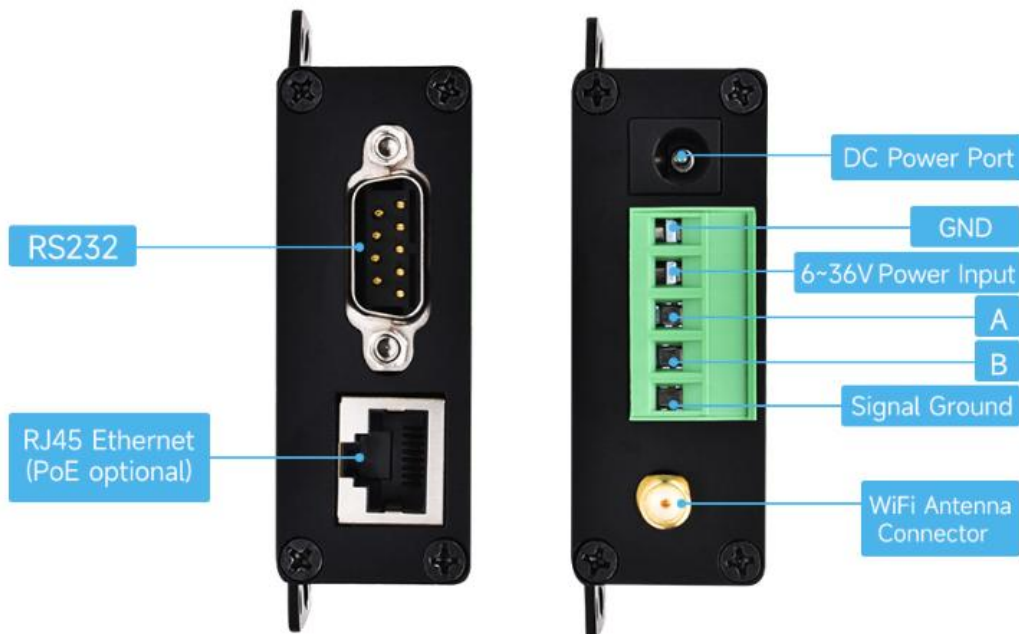

- Antenna connector: 3dbi antenna.
- Ethernet port: RJ45 interface, RS232/485 TO WIFI ETH (B) is the version without PoE function.

- RS232 interface: DB9 male interface. See the above figure for the cable sequence.
- RS485 interface: RS485 interface, which is A, B and G from right to left according to the logo.
- Power interface (terminal): 5.08*2P terminal power interface. The product power input has TVS and anti-reverse connection protection, and supports wide voltage range: 6~36V power supply.
- Power interface (DC jack): DC 5.5 jack, supporting wide voltage range: 6~36V power supply.
- RJ45 network port:

The connection of the network port, the network port of the module is 10M/100M adaptive, supporting AUTOMDI/MDIX, which means that you can use the direct network cable to directly connect with the computer for testing. The RS232/485 TO WIFI ETH (B) serial server disables the network port by default, and can be enabled by AT command or webpage setting if it is necessary to use the network port.

3.6 OUTLINE DIMENSIONS



Figure Outline dimensions

3.7 APPLICATION SCENARIOS

The application scenarios of RS232/485 to WiFi/Ethernet is as shown below:

- The serial port (RS232/485) to WiFi ETH (B) are as follows:
- WiFi remote control/monitor, TCP/IP AND WiFi co-processor.
- WIFI remote control in the field of toys such as airplanes and cars.
- WIFI network radio, camera, digital photo frame.
- Medical instrument, data acquisition device, handheld devices.
- Wi-Fi body fat scale, smart card terminal and smart home.
- Instruments and meters, equipment parameter monitoring, wireless POS machine;
- Other wireless related secondary development and application in modern agriculture and military fields;
- Smart factories, smart homes, smart medical care and other fields.

4. PRODUCT PARAMETERS SETTING

The RS232/485 TO WIFI ETH (B) serial server supports AT command and Web parameter setting. For the setting of AT command, please refer to the chapter of "AT instruction set" in the document. This chapter mainly explains how to set up the Web.

4.1 WEB MANAGEMENT PAGE

When using RS232/485 TO WIFI ETH (B) serial server for the first time, it is necessary to configure the WIFI serial server. You can connect the AP interface of RS232/485 TO WIFI ETH (B) through a PC and configure it with a web management page.

By default, the AP interface SSID of RS232/485 TO WIFI ETH (B) is Waveshare_xxxx, and the IP address, user name and password are as follows:

Table Network Default Settings

Specifications	Default
SSID	Waveshare_xxxx
IP Address	10.10.100.254
subnet mask	255.255.255.0
user name	admin
password	admin

4.1.1 OPEN THE MANAGEMENT PAGE

Firstly, connect RS232/485 TO WIFI ETH (B) with the wireless network card of PC, and the SSID is Waveshare_xxxx. When connected, open the browser, enter 10.10.100.254 in the address bar and press enter. Fill in the user name and password in the pop-up dialog box, and then "confirm".

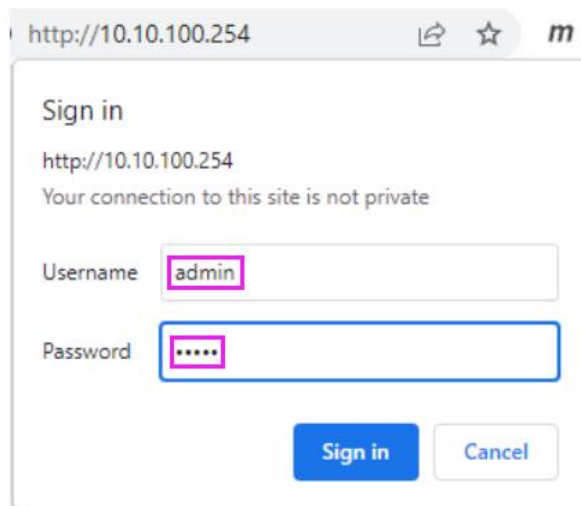
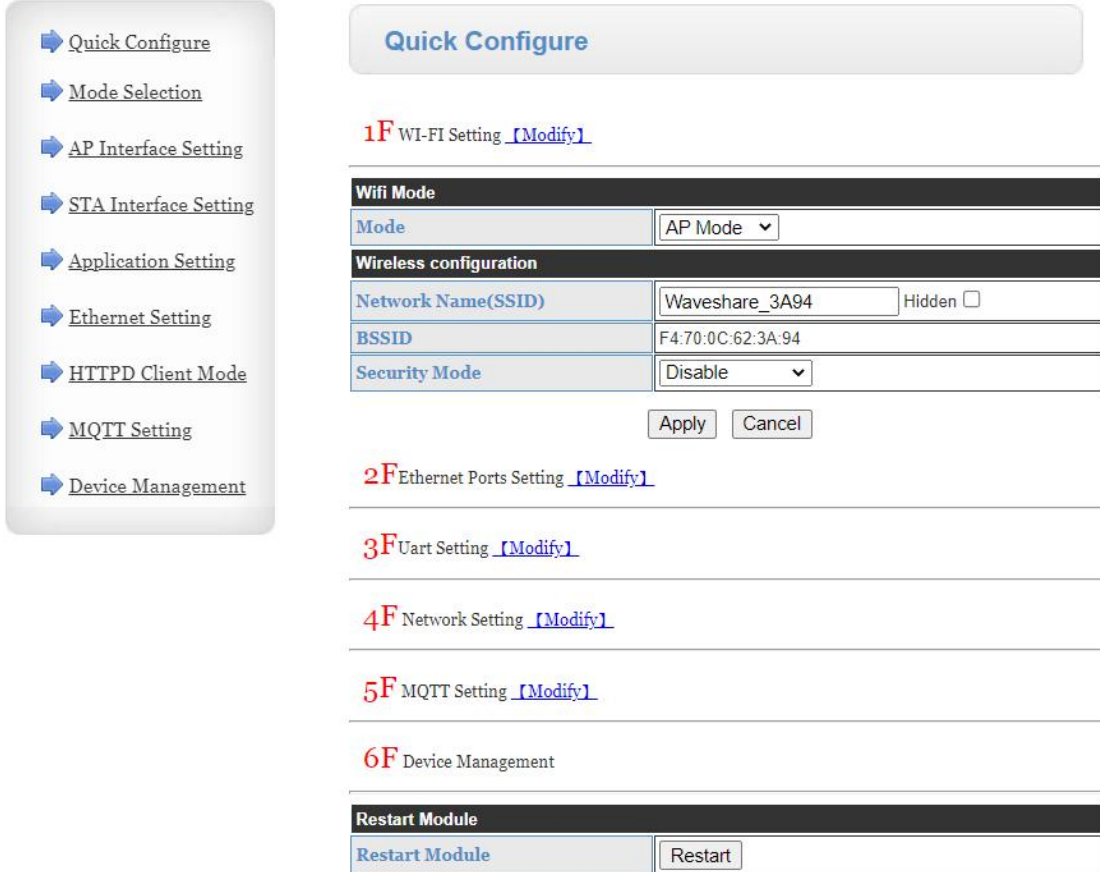

Figure the second step of opening the management web page

Then; The RS232/485 TO WIFI ETH (B) management page supports Chinese and English, and can be set in the upper right corner. It is divided into 9 pages, namely, quick configuration, mode selection,

wireless access point settings, wireless terminal settings, serial port and network settings, Ethernet function settings, HTTPDClient mode, advanced settings and module management.

4.1.2 QUICK CONFIGURATION PAGE



Quick Configure

1F [WI-FI Setting](#) [\[Modify\]](#)

Wifi Mode	
Mode	AP Mode ▾
Wireless configuration	
Network Name(SSID)	Waveshare_3A94 <input type="checkbox"/> Hidden
BSSID	F4:70:0C:62:3A:94
Security Mode	Disable ▾
<input type="button" value="Apply"/> <input type="button" value="Cancel"/>	

2F [Ethernet Ports Setting](#) [\[Modify\]](#)

3F [Uart Setting](#) [\[Modify\]](#)

4F [Network Setting](#) [\[Modify\]](#)

5F [MQTT Setting](#) [\[Modify\]](#)

6F Device Management

Restart Module	
Restart Module	<input type="button" value="Restart"/>

Figure Quick Setup Page

The quick configuration page provides a method for users to quickly configure RS232/485 TO WIFI ETH (B) serial server. After configuring the parameters according to the steps on the page and restarting the WIFI serial server, the WIFI serial server can work normally, which reduces the steps and time of configuration. Of course, there are fewer options on this page, and the detailed configuration should be configured on the corresponding page.

This page has five options to configure and a restart item, which are explained below:

- Wireless configuration: configure the working mode of WIFI, AP or STA mode.
- Ethernet setting: Enable/disable Ethernet port and set corresponding working mode.
- Serial port configuration: configure serial port parameters, including serial port baud rate, parity bit, 485 function and so on.
- Network configuration: configure network parameters, only related parameters of SocketA.
- MQTT setting: configure MQTT enabling and MQTT connection server related parameters.

- Device management: When all the above parameters are configured, click Restart to restart the module.

4.1.3 MODE SELECTION PAGE

The first page of the Web can be set to select RS232/485 TO WIFI ETH (B) serial server to work in AP mode or STA mode.

"Data transmission mode" the working modes of WIFI serial server are transparent transmission mode, serial command mode, HTTPDClient mode and ModbusTCP<=>ModbusRTU mode.

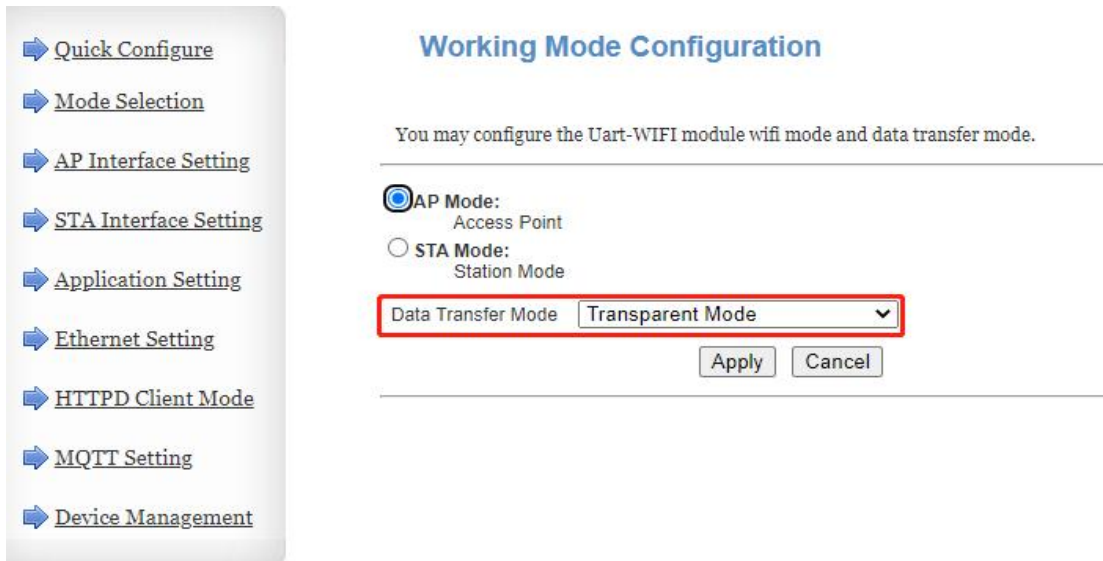

Figure wireless mode settings

4.1.4 WIRELESS ACCESS POINT SETTINGS PAGE

RS232/485 TO WIFI ETH (B) supports AP interface, through which the WIFI serial server can be managed very conveniently, and the self-organizing network can be realized. The management page is shown below. Including the setting of SSID, wireless network mode and wireless security, and the setting of local area network composed of AP.

- [Quick Configure](#)
- [Mode Selection](#)
- [AP Interface Setting](#)
- [STA Interface Setting](#)
- [Application Setting](#)
- [Ethernet Setting](#)
- [HTTPD Client Mode](#)
- [MQTT Setting](#)
- [Device Management](#)

AP Interface Setting

AP Interface Setting such as SSID, Security...

Wireless Network	
Network Mode	11b/g/n mixed mode ▼
Network Name(SSID)	Waveshare_3A94 <input type="checkbox"/> Hidden
BSSID	F4:70:0C:62:3A:94
Frequency (Channel)	AutoSelect ▼

Waveshare_3A94	
Security Mode	Disable ▼

LAN Setup	
IP Address(Default DHCP Gateway)	10.10.100.254
Subnet Mask	255.255.255.0
DHCP Type	Server ▼

Figure Access point settings

4.1.5 WIRELESS TERMINAL SETTINGS PAGE

Wireless terminal interface, also known as STA interface. RS232/485 TO WIFI ETH (B) can be connected to other wireless networks through the STA interface, as shown in the following figure:

The settings on this page include two tables. The top one is the wireless settings for STA, including the SSID of the AP to be connected, security settings, etc. The following table shows the network connection mode settings, including DHCP and static connection mode.

- [Quick Configure](#)
- [Mode Selection](#)
- [AP Interface Setting](#)
- [STA Interface Setting](#)
- [Application Setting](#)
- [Ethernet Setting](#)
- [HTTPD Client Mode](#)
- [MQTT Setting](#)
- [Device Management](#)

STA Interface Setting

You could configure STA interface parameters and turn on/off AP+STA here.

STA Interface Parameters	
AP's SSID	Waveshare_3A94 <input type="text" value="Search..."/>
MAC Address (Optional)	<input type="text"/>
Security Mode	OPEN ▾
Encryption Type	NONE ▾
<input type="button" value="Apply"/> <input type="button" value="Cancel"/>	

AP+STA settings	
AP+STA	off ▾
<input type="button" value="Apply"/> <input type="button" value="Cancel"/>	

WAN Connection Type:

DHCP Mode	
Hostname(Optional)	Waveshare_3A94 <input type="text"/>
<input type="button" value="Apply"/> <input type="button" value="Cancel"/>	

Figure Wireless Terminal Interface Settings

4.1.6 SERIAL PORT AND NETWORK SETTINGS PAGE

Application program settings refer to the settings of WIFI to serial port application parameters, including serial port parameter settings, automatic framing settings, Ethernet function settings, device registration package settings, and network protocol settings.

- [Quick Configure](#)
- [Mode Selection](#)
- [AP Interface Setting](#)
- [STA Interface Setting](#)
- [Application Setting](#)
- [Ethernet Setting](#)
- [HTTPD Client Mode](#)
- [MQTT Setting](#)
- [Device Management](#)

Wifi-Uart Setting

You could configure the Uart parameters and network parameters of the wifi-uart application.

Uart Setting	
Baudrate	57600 ▾
Data Bits	8 ▾
Parity	None ▾
Stop	1 ▾
Baudrate adaptive (RFC2117)	Enable ▾
<input type="button" value="Apply"/> <input type="button" value="Cancel"/>	

UART AutoFrame Setting	
UART AutoFrame	Disable ▾
<input type="button" value="Apply"/> <input type="button" value="Cancel"/>	

Registered Package Setting	
Registered Package Type	off ▾
<input type="button" value="Apply"/> <input type="button" value="Cancel"/>	

Upload Manner: first: Module send registration packet when connection established; every: Send registration packet every time when module send data

Serial Port and Network Parameter Settings

- ➔ [Quick Configure](#)
- ➔ [Mode Selection](#)
- ➔ [AP Interface Setting](#)
- ➔ [STA Interface Setting](#)
- ➔ [Application Setting](#)
- ➔ [Ethernet Setting](#)
- ➔ [HTTPD Client Mode](#)
- ➔ [MQTT Setting](#)
- ➔ [Device Management](#)

Custom heartbeat packet settings

Custom Heartbeat

Apply Cancel

Socket Distribution settings

Socket Distribution

Apply Cancel

Modbus Polling settings

Modbus Polling

Apply Cancel

Httpdclient Mode settings

Httpdclient Mode

Apply Cancel

485 Switch Settings

485 selector switch

Switching interval(1-350)(us)

Apply Cancel

Figure Serial port and network parameters setting

<Note>:

Network parameters can be set in four modes: TCP Server, TCP Client, UDP Server, and UDP Client.

When the RS232/485 TO WIFI ETH (B) serial server is configured as a UDPServer, the RS232/485 TO WIFI ETH (B) serial server will remember the UDPClient end of the last communication and communicate with the last UDPClient end. The UDPClient mode only communicates with the target IP and port. When set to TCP Server, there is no need to enter an IP address. For other settings, it is necessary to fill in the IP address of the other party that needs to be connected. Fill in the protocol port number at the port, and the port numbers on both ends of the communication must be the same.

SocketB communicates with the server as the TCPClient and UDPClient.

TCP connection password verification: When RS232/485 TO WIFI ETH (B) is working in TCP Server mode, perform password verification on the connected TCPClient.

Note: This verification only works when the RS232/485 TO WIFI ETH (B) serial server is used as the TCP Server. When enabled, TCPClient connects to the TCPServer of the WIFI serial port server, the first data sent to RS232/485 TO WIFI ETH (B) serial server is password plus carriage return. The password is the password when logging in to the webpage, and the default is "admin". For example, the first data sent by default should be "0x610x640x6D0x690x6E0x0D0x0A" (hexadecimal).

4.1.7 ETHERNET FUNCTION SETTINGS

This page is used to set the Ethernet port of the module, which can be enabled or disabled. Moreover, it can be used as a WAN port, so that the module can be used as a secondary router, which is convenient for users to network. The specific settings page is as follows:

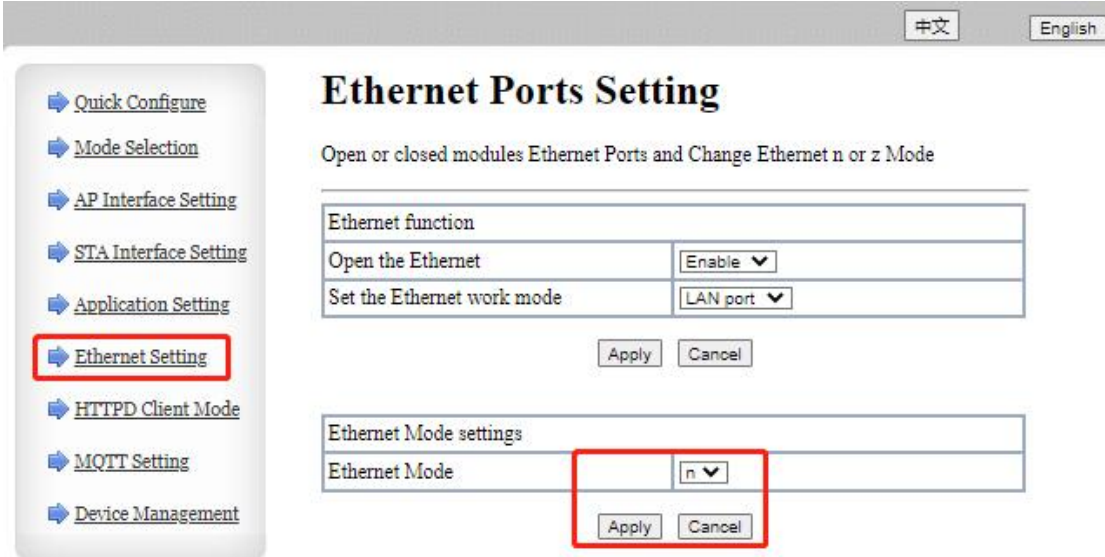

中文 English

Ethernet Ports Setting

Open or closed modules Ethernet Ports and Change Ethernet n or z Mode

Ethernet function	
Open the Ethernet	Enable ▾
Set the Ethernet work mode	LAN port ▾

Apply Cancel

Ethernet Mode settings	
Ethernet Mode	n ▾

Apply Cancel

Figure Ethernet function settings page

4.1.8 HTTPDCLIENT MODE PAGE

This webpage sets the contents of HTTP protocol header in HTTPDClient mode, including: server address, server port, request type, protocol header path, protocol header Connection and protocol header User-Agent. The size of the transmitted data is 1000 bytes. For details about data transmission method, you can refer to “HTTPDClient” chapter in this user manual.

中文 English

- ➔ Quick Configure
- ➔ Mode Selection
- ➔ AP Interface Setting
- ➔ STA Interface Setting
- ➔ Application Setting
- ➔ Ethernet Setting
- ➔ HTTPD Client Mode
- ➔ MQTT Setting
- ➔ Device Management

HTTPD-Client Mode

In HTTPD_Client mode, set the relevant parameters of HTTP

Note: HTTPD Client mode is used to communicate with HTTP Server. It encapsulate the serial data to be HTTP protocol data, then send to HTTP Server.

HTTPD Header Set Mode	new ▼
HTTPD Server address	pico.wiki
HTTPD Server port	80
HTTPD Request Type	GET ▼
HTTPD Header path	/get-data.php?

Custom HTTP Header

Content-type: text/html; charset=utf-8

when HTTPD header set to be "old", use old setting method, that is to fill each header. When set to be "new", use new setting method, the header can be user-defined(There can't have "enter" at the end).

Figure Web Page Setting HTTPDClient Mode

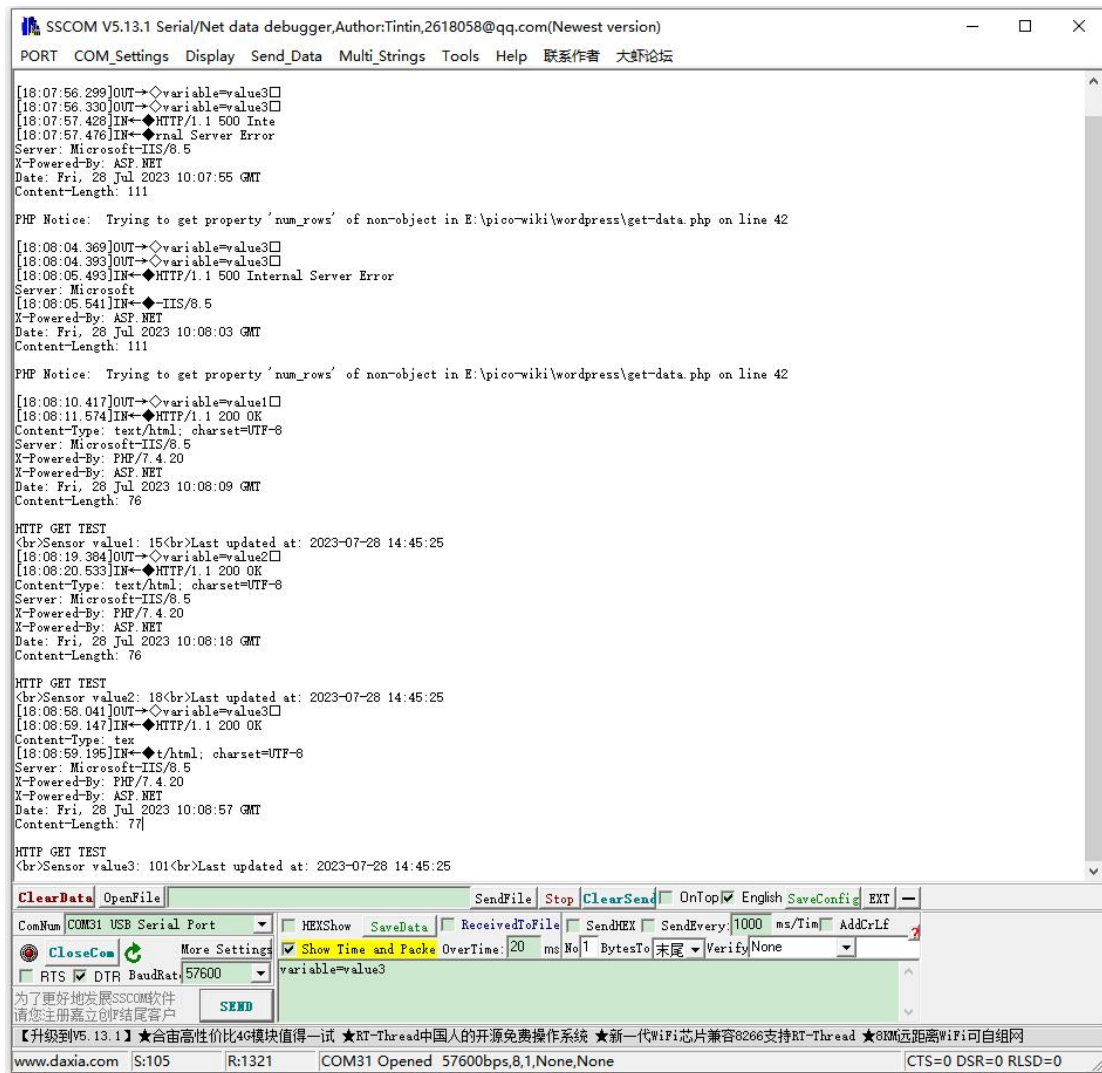

Figure Example of Webpage HTTPDClient Mode Test Settings

4.1.9 MQTT FUNCTION SETTINGS PAGE

This webpage sets MQTT function related parameters, including server parameters to connect to, publish topic parameters, and subscribe topic parameters. For specific usage of MQTT functions, please refer to the relevant chapters of this manual titled "MQTT Functions".

- ▶ Quick Configure
- ▶ Mode Selection
- ▶ AP Interface Setting
- ▶ STA Interface Setting
- ▶ Application Setting
- ▶ Ethernet Setting
- ▶ HTTPD Client Mode
- ▶ MQTT Setting
- ▶ Device Management

MQTT Setting

Set MQTT Function

MQTT Setting	
Open the MQTT	ON ▼
Version(3.1.1)	V3.1.1 ▼
Server Address	broker.emqx.io
Server Port	1883
Heart Beat(o-65535/o means off)	60
Client ID(Can be empty)	12345678
Username(Can be empty)	admin
Password(Can be empty)	admin
Pub Mode	mode1(Pure transparent transmission mode) ▼
Sub Mode	mode1(Pure transparent transmission mode) ▼
Open the Will	OFF ▼

MQTT Pub Topic

Delete Topic

Special Symbol(Can be empty)	1
Topic Name	txd485
QOS	QOS0 ▼
Retained	OFF ▼

Delete Topic

Special Symbol(Can be empty)	2
Topic Name	topic2
QOS	QOS1 ▼
Retained	OFF ▼

Delete Topic

Special Symbol(Can be empty)	3
Topic Name	topic3
QOS	QOS2 ▼
Retained	OFF ▼

MQTT Sub Topic

Figure Webpage MQTT function settings

4.1.10 MODULE MANAGEMENT PAGE

Module management includes username/password settings, factory reset, and software upgrade functions.

- ➔ [Quick Configure](#)
- ➔ [Mode Selection](#)
- ➔ [AP Interface Setting](#)
- ➔ [STA Interface Setting](#)
- ➔ [Application Setting](#)
- ➔ [Ethernet Setting](#)
- ➔ [HTTPD Client Mode](#)
- ➔ [MQTT Setting](#)
- ➔ [Device Management](#)

Device Management

C002880-2-V1.0.2(V7.04T.07)

You may configure administrator account and password, load default setting or update firmware.

Administrator Settings

Account	<input type="text" value="admin"/>
Password	<input type="text" value="admin"/>

Restart Module

Restart Module	<input type="button" value="Restart"/>
----------------	--

Load Factory Defaults

Load Default Button	<input type="button" value="Load Default"/>
---------------------	---

Timeout Reboot Setting

Timeout Function	<input type="text" value="off"/>
------------------	----------------------------------

Reboot time Setting

Reboot Function	<input type="text" value="off"/>
-----------------	----------------------------------

Update Firmware

Location:	<input type="button" value="Choose File"/> No file chosen
-----------	---

Figure Module Management Page

<Note>:

"Restart Module" Button: After users have configured parameters on various pages and clicked "OK" to confirm the settings, these changes will only take effect after the user clicks "Restart" on the module management page. After clicking "Reboot", the RS232/485 TO WIFI ETH (B) serial server reset and reboot, refreshing the previous configuration information stored in the memory.

4.2 SOFTWARE CONFIGURATION

4.2.1 DOWNLOAD LINK

WiFi high-performance series configuration software download link:

4.2.2 SOFTWARE INTRODUCTION

The serial server parameter can be queried and configured through a serial connection or by connecting to the same local network.

This can be done without accessing the web page or manually send AT commands frequently.

The device supports features like one-click firmware upgrades and batch parameter configuration.

The interface might look like the following figure:

26

www.waveshare.com

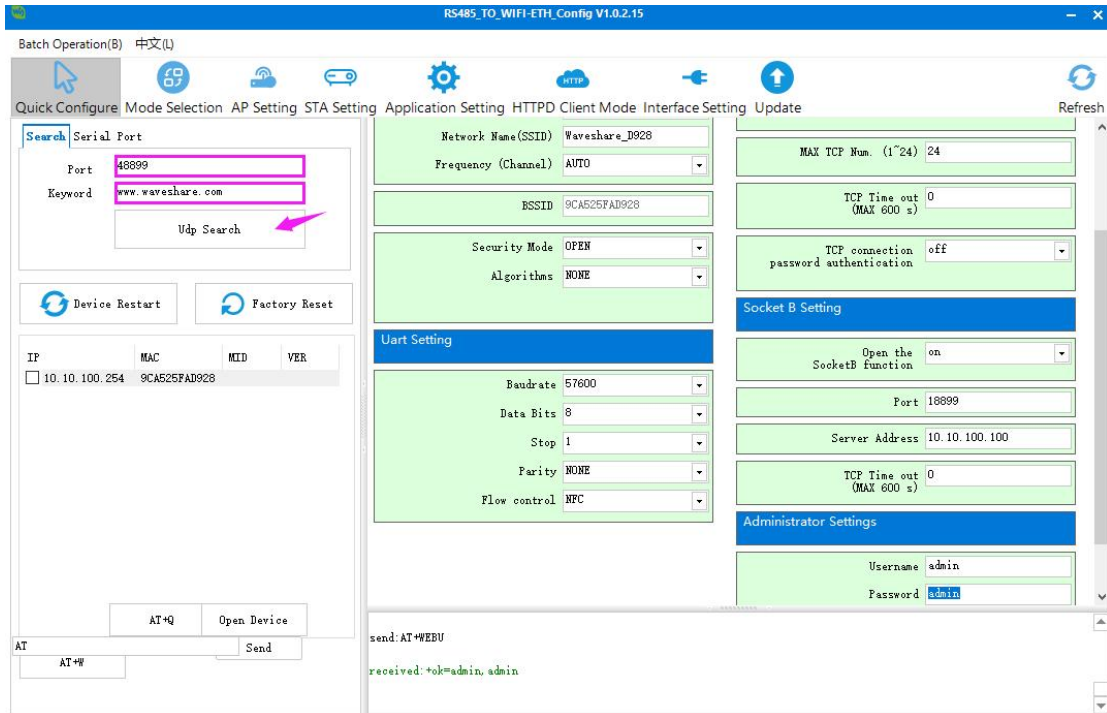

Figure Serial Port and Network Parameter Settings

Batch parameter configuration setting and firmware upgrade interface as shown below:

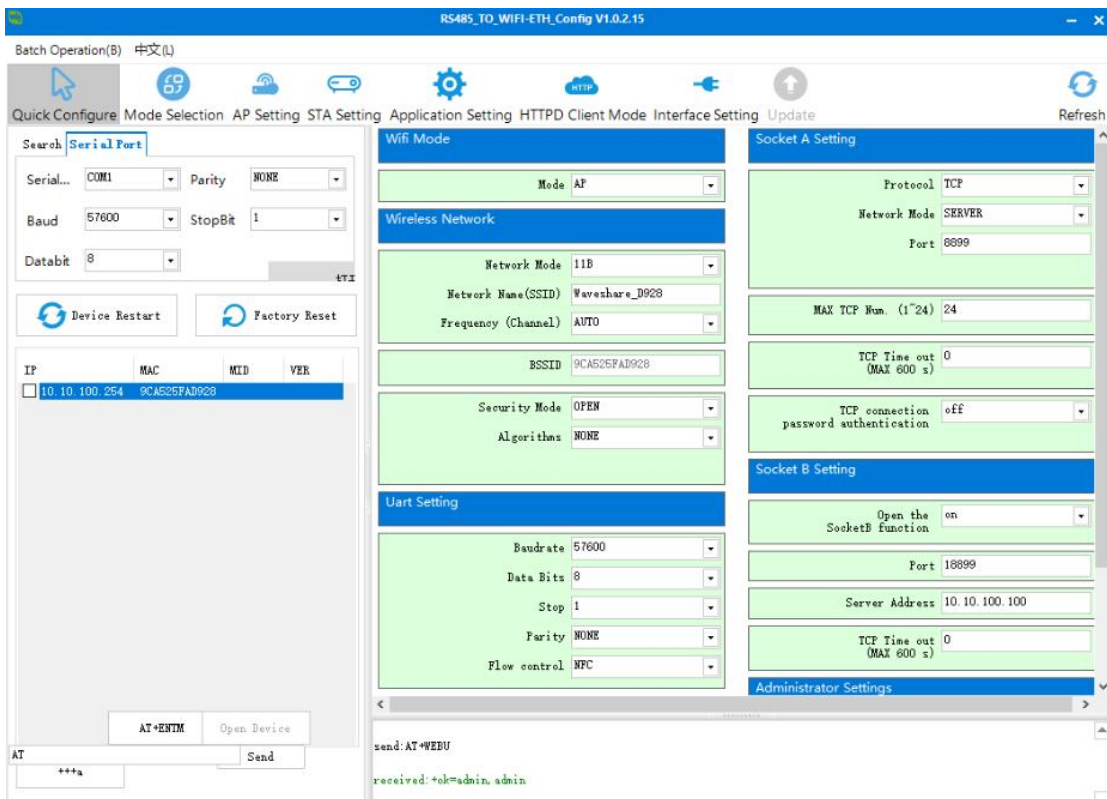

Figure Batch Parameter Configuration Page

5. PRODUCT NETWORKING APPLICATION

The RS232/485 TO WIFI ETH (B) serial server can be configured as either a wireless STA or an AP. So RS232/485 TO WIFI ETH (B) logically supports two wireless interfaces, one as an STA and the other as an AP. Other STAs can be connected to the wireless network through the AP interface of this serial server. At the same time, the RS232/485 TO WIFI ETH (B) serial port server provides a 100M Ethernet interface, through which users can achieve interworking of WIFI, serial port, and Ethernet port. In terms of networking, RS232/485 TO WIFI ETH (B) serial server supports bridging mode and routing mode to correspond to different specific applications.

The RS232/485 TO WIFI ETH (B) serial server supports two communication methods: wireless WIFI and wired Ethernet, providing a very flexible networking method and network topology.

<Note>:

AP: Wireless access point, which is the central node of a wireless network. The commonly used wireless router is an AP, and other wireless terminals can connect to each other through the AP.

STA: refers to a wireless station, which is a terminal of a wireless network. Such as notebook computer, PDA, etc.

5.1 WIRELESS NETWORKING SETTINGS

The relevant AT commands are as follows:

Table wireless networking AT command list

	Item	Note
1	WMODE	Set/query WIFI operation mode (AP, STA)
2	WSSID	Set/query the SSID of the associated AP.
3	WSKEY	Set/query the encryption parameters in WIFISTA mode.
4	WANN	Set/query the network parameters of STA.
5	WSLK	Query the wireless connection status of STA
6	WAP	Set/query parameters in WIFIAP mode.
7	WAKEY	Set/query the encryption parameters in WIFIAP mode.
8	LANN	Set/query module IP in AP mode
9	FAPSTA	Enable/disable module AP+STA mode

Table Socket related AT command list

	Item	Note
1	NETP	Set/query network protocol parameters for TCPA
2	TCPB	Enable/disable TCPB function

3	TCPPTB	Set/query the port number of TCPB
4	TCPADDB	Set/query TCPB servers

The webpage configuration is as follows:

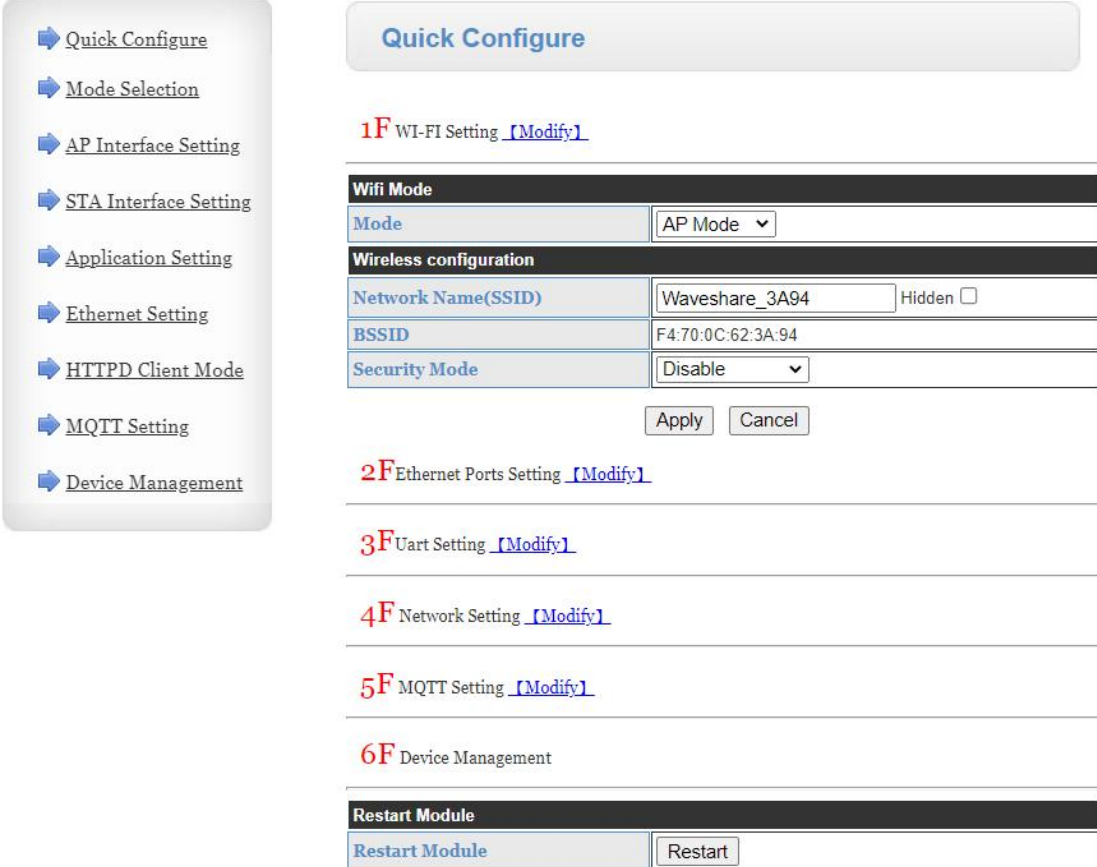

The screenshot shows a web interface for configuring the device. On the left is a sidebar menu with options: Quick Configure, Mode Selection, AP Interface Setting, STA Interface Setting, Application Setting, Ethernet Setting, HTTPD Client Mode, MQTT Setting, and Device Management. The main content area is titled 'Quick Configure' and contains several sections:

- 1F WI-FI Setting** [Modify]: A section for wireless configuration. It includes a 'Wifi Mode' section with a 'Mode' dropdown set to 'AP Mode'. Below it is a 'Wireless configuration' section with fields for 'Network Name(SSID)' (Waveshare_3A94), a 'Hidden' checkbox, 'BSSID' (F4:70:0C:62:3A:94), and 'Security Mode' (Disable). 'Apply' and 'Cancel' buttons are at the bottom.
- 2F Ethernet Ports Setting** [Modify]: A section for Ethernet port configuration.
- 3F Uart Setting** [Modify]: A section for UART configuration.
- 4F Network Setting** [Modify]: A section for network configuration.
- 5F MQTT Setting** [Modify]: A section for MQTT configuration.
- 6F Device Management**: A section for device management, including a 'Restart Module' section with a 'Restart' button.

Figure Wireless Networking Settings webpage

The RS232/485 TO WIFI ETH (B) serial port server can be configured as either a wireless STA or an AP. There are AT commands and web page settings that can be set, as follows:

(1) AT command setting mode: it can be set by AT+WMODE, which can be set as AP or STA.

Example: Set the WIFI serial server to STA mode, and after entering AT command mode, send the following command:

Set WIFI serial port server to STA mode.

```
AT+WMODE=STA
```

```
restart
```

```
AT+Z
```

After restarting, the serial server works in STA mode.

(2) The webpage is set as follows:

For example, log in to the built-in webpage of the serial port server, enter the mode selection page, and select the Station mode (set the WIFI serial port server to STA mode), as follows:

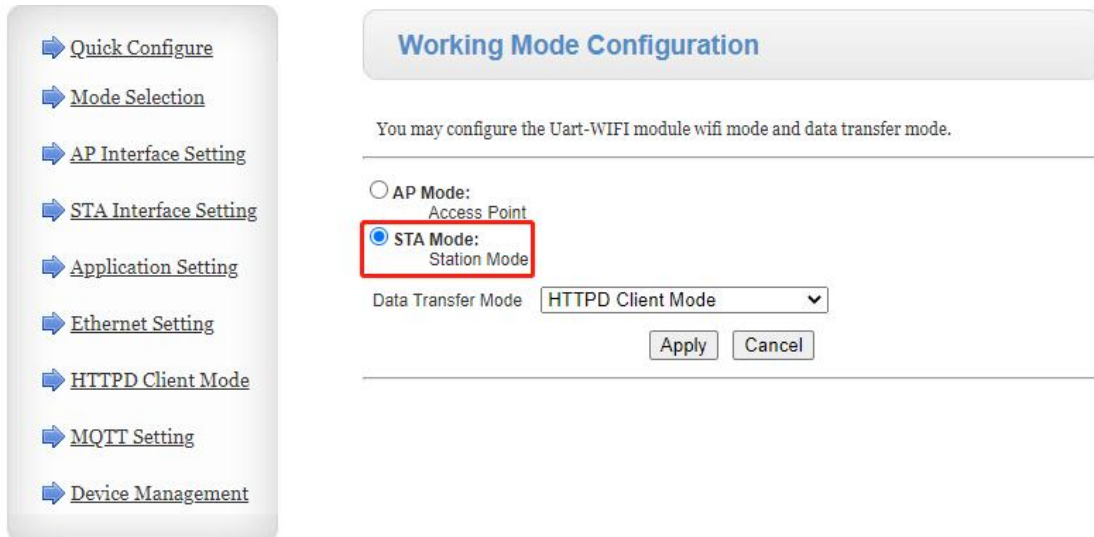

Figure Webpage Mode Setting WIFI Mode

After clicking OK, enter the module management page and restart to complete the work mode settings.

The module enables the AP+STA function, which can be set through the AT command (AT+FAPSTA) or customized to the factory default.

5.2 WIRELESS NETWORKING APPLICATIONS

5.2.1 WIRELESS NETWORKING APPLICATIONS (AP)

The WIFI serial server is used as an AP, and other WIFI serial servers and computers can be connected to this WIFI serial server as STA. At the same time, it can also be connected through the UART interface to the user device, as shown in the following figure:

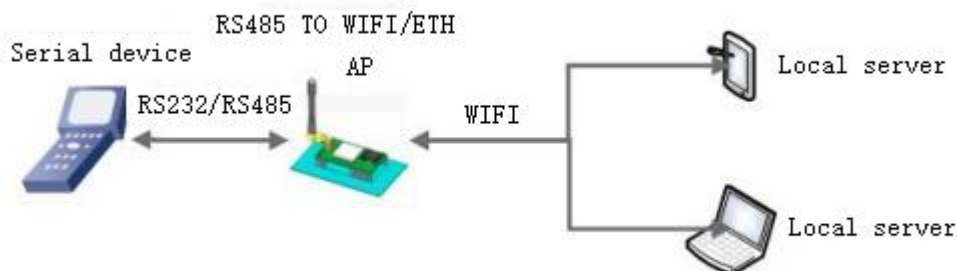

Figure Access Point (AP)

The WIFI serial server operates in AP mode, and the above application can be set using the following AT command:

- (1) Set the WIFI serial port server to AP mode

```
AT+WMODE=AP
```

(2) Parameters under the WiFi serial server's Access Point (AP) mode can be selected and configured based on your requirements or you can use the default parameters. Here's an example of parameter settings:

```
At+WAP = 11bgn, waveshare-test, auto (optional)
```

```
AT+WKEY=WPA2PSK,AES,12345678 (optional)
```

- (3) Restart the WIFI serial server:

```
AT+Z
```

Complete the parameter setting.

Note:

1. All settings set to the AT command need to enter the AT command mode (please refer to "RS232/485 TO WIFI ETH (B) AT instruction set" for details).
2. After the parameters are set, they need to be "restarted" to take effect, so as to refresh the original configuration information in the memory and restart the operation, which will not be described in detail later.

5.2.2 WIRELESS NETWORKING APPLICATION (STA)

RS232/485 TO WIFI ETH (B) serial server is connected to other AP (such as routing in local area network) as a STA to form a wireless network. All STAs regard this AP as the center of the wireless network, and the mutual communication between STAs is completed through the AP, as shown in the following figure:

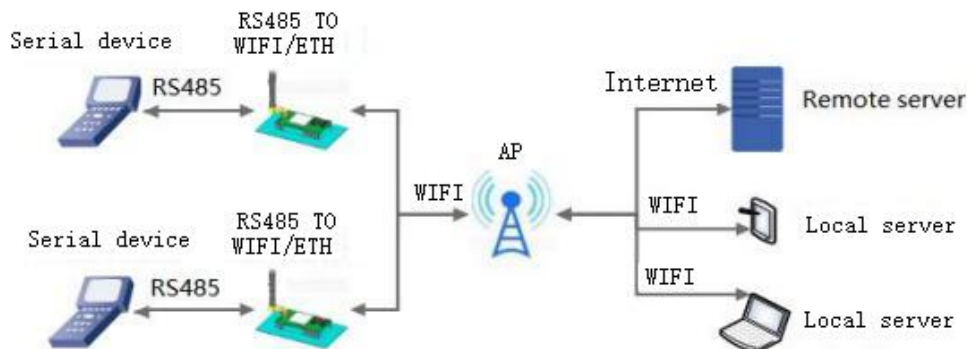

Figure Wireless networking application (STA)

The parameters of WIFI serial server are set as follows:

(1) Set the working mode of the WIFI serial server:

```
AT+WMODE=STA
```

(2) Set the SSID, encryption mode algorithm and password of the router to be connected

(assuming that the routing SSID in the above figure is: **Waveshare-TEST**, encryption mode algorithm: **WPA2PSK,AES**, password: **Waveshare**), set as follows:

```
AT+WSSSID=Waveshare-TEST
```

```
AT+WSKEY=WPA2PSK,AES,Waveshare
```

(3) Restart the WIFI serial server:

```
AT+Z
```

Complete the parameter setting.

5.2.3 WIRELESS NETWORKING APPLICATION (AP+STA)

The RS232/485 TO WIFI ETH (B) serial server can support both an AP interface and an STA interface. When the AP+STA function is enabled, both the STA and AP interfaces are available. The STA interface of the serial server is connected with the router and connected with the server in the network through TCPB; At the same time, the AP interface can be connected by mobile phone /PAD (through TCPA connection). In this way, the servers in the network, such as TCPServer and mobile phone /PAD, can control the serial devices connected to the RS232/485 TO WIFI ETH (B) serial server or set the parameters of the serial server itself, as shown in the following figure:

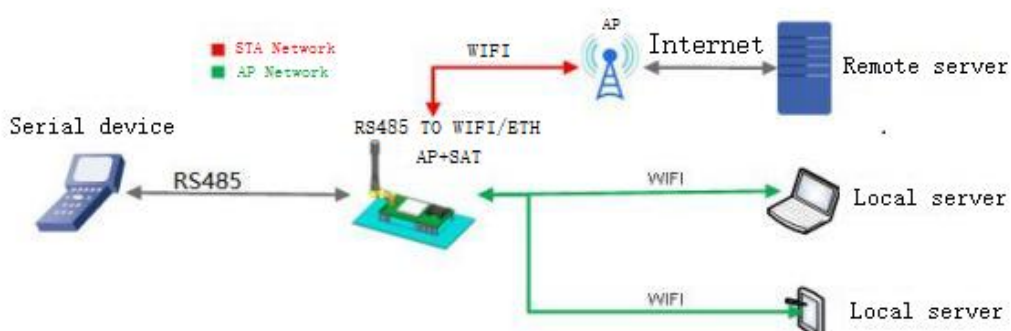

Figure Wireless networking application (AP+STA)

The parameters of WIFI serial server are set as follows:

- (1) Enable WIFI serial server AP+STA function

```
AT+FAPSTA=on
```

- (2) Effective after restoring factory settings

```
AT+RELD
```

(3) Set the WIFI serial server to STA mode, and at this time, the WIFI serial server AP interface is still valid:

```
AT+WMODE=STA
```

(4) Set the parameters for the WIFI serial server to connect to the route (assuming the route SSID in the figure above is WAVESHARE-WIFI-TEST, the encryption mode algorithm is WPA2PSK, AES, and the password is www.waveshare.com), as follows:

```
AT+WSSSID=WAVESHARE-WIFI-TEST
```

```
AT+WSKEY=WPA2PSK, AES, www.waveshare.com
```

- (5) Set up SocketA and SocketB

Example of SocketA settings:

```
AT+NETP=TCP, Server, 8899,10.10.100.100.100
```

Set the IP and port number of the server to connect to (based on actual parameters)

SocketB settings example:

```
AT+TCPADDB=192.168.1.100
```

```
AT+TCPPTB=18899
```

- (6) Restart the WIFI serial server:

```
AT+Z
```

Complete parameter settings.

Precautions:

When the AP+STA function is enabled, the STA port needs to be connected to other routers. Otherwise, the STA port will constantly scan the router, which will have a certain impact on the AP port, such as data loss. If the user determines that the STA cannot connect to the AP at this time, he can use the command to stop scanning the STA port:

```
AT+STTC=on/off
```

“On” means to scan the router, and “off” means not to scan. This command will not be saved after restarting.

```
AT+FSTTC=on/off
```

This command can be saved and will take effect after restarting.

The whole AP+STA application can also refer to our official website
 FAQ:<http://www.waveshare.com/Faq/45.html>

Web Page Configuration: Access the built-in web page, navigate to the wireless terminal settings page, and enable the AP+STA functionality to configure AP+STA settings.

As shown in the figure:

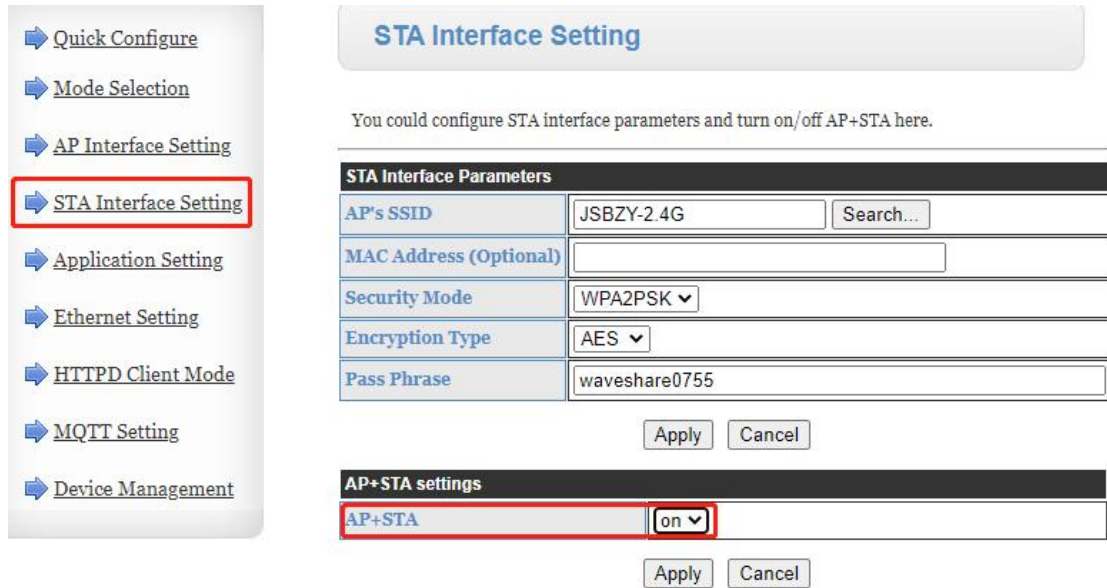
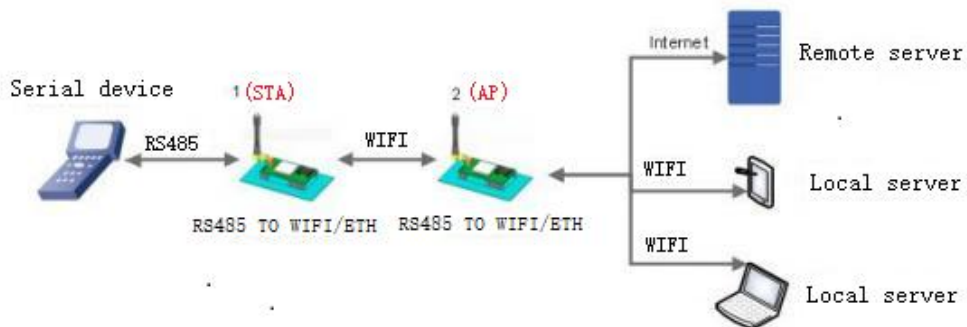

Figure Wireless networking application (AP+STA)

5.2.4 WIRELESS NETWORKING APPLICATION (AP, STA)

The RS232/485 TO WIFI ETH (B) device's wireless functionality can be configured in two modes: as a wireless Station (STA) or as an Access Point (AP). Logically, it supports two wireless interfaces: one acting as a STA to connect to an existing wireless network, and the other interface serving as an AP, allowing other STAs to connect to the wireless network through this device.



AT+TCPPTB=18899

(6) Restart the WIFI serial server:

The No.1 WIFI serial server works in STA mode and No. 2 works in AP mode:

(1) set the No.1 WiFi serial server as STA.

```
AT+WMODE=STA
```

✦ For No.2 WIFI serial server, set it as AP.

```
AT+WMODE=AP
```

(3) No.1 WIFI serial server is connected to AP(WIFI serial server 2) as a STA, so the SSID and password to be connected to WIFI serial server 1 are the AP parameters of WIFI serial server 2.

The SSID and password of No.2 WIFI serial server can be queried by using the following AT instructions:

```
AT+WAP
```

```
AT+WAKEY
```

You can also choose settings as required, or use default parameters. Examples of parameter settings for WIFI serial server 2 are as follows:

```
AT+WAP = 11bgn, waveshare-test, auto (optional)
```

```
AT+WAKEY=WPA2PSK,AES,12345678 (optional)
```

An example of parameter setting for No.1 WIFI serial server is as follows (set the SSID and password of WIFI serial server 2 corresponding to the connected AP parameters), as follows:

```
AT+WSSSID=RS232/485 TO WIFI ETH (B)-TEST
```

```
AT+WSKEY=WPA2PSK,AES,12345678
```

Consistent with the parameter setting example of WIFI serial server 2.

(4) Restart the WIFI serial server:

```
AT+Z
```

Complete the parameter setting.

5.3 WIRED NETWORKING SETUP

Related AT commands are as follows:

Table related AT command list

	Item	Note
1	WMODE	Set/query WIFI operation mode (AP, STA)
2	WSSSID	Set/query the SSID of the associated AP
3	WSKEY	Set/query the encryption parameters in WIFISTA mode

4	WANN	Set/query STA network parameters
5	WSLK	Query STA wireless connection status
6	WAP	Set/query the parameters in WIFI AP mode
7	WAKEY	Set/query the encryption parameters in WIFIAP mode
8	LANN	Set/query module IP in AP mode
9	FEPHY	Enable/disable the module Ethernet port
10	FVER	Set/query module software version (N-Ver, Z-Ver)

Table Socket related RT command list

	Item	Note
1	NETP	Set/query TCPA network protocol parameters
2	TCPB	Enable/disable TCPB function
3	TCPPTB	Set/query TCPB port number:
4	TCPADDB	Set/query TCPB server

Webpage configuration as follows:

- [Quick Configure](#)
- [Mode Selection](#)
- [AP Interface Setting](#)
- [STA Interface Setting](#)
- [Application Setting](#)
- [Ethernet Setting](#)
- [HTTPD Client Mode](#)
- [MQTT Setting](#)
- [Device Management](#)

Quick Configure

1F [WI-FI Setting](#) [\[Modify\]](#)

Wifi Mode	
Mode	AP Mode <input type="button" value="v"/>
Wireless configuration	
Network Name(SSID)	Waveshare_3A94 <input type="checkbox"/> Hidden
BSSID	F4:70:0C:62:3A:94
Security Mode	Disable <input type="button" value="v"/>

2F [Ethernet Ports Setting](#) [\[Modify\]](#)

3F [Uart Setting](#) [\[Modify\]](#)

4F [Network Setting](#) [\[Modify\]](#)

5F [MQTT Setting](#) [\[Modify\]](#)

6F [Device Management](#)

Restart Module	
Restart Module	<input type="button" value="Restart"/>

Figure Enable/disable module Ethernet interface

The RS232/485 TO WIFI ETH (B) serial server offers a 100M Ethernet interface that allows users to achieve bi-directional communication between WiFi, serial, and Ethernet interfaces. Through this 100M Ethernet interface, seamless interaction is possible among the three interfaces, enabling effective data exchange. In terms of networking, the RS232/485 TO WIFI ETH (B) serial server's Ethernet port can be configured as either a LAN port or a WAN port. Additionally, it supports both bridge mode and router mode to cater to different specific applications.

5.4 WIRED NETWORKING APPLICATION

5.4.1 WIRED NETWORKING APPLICATION (APLAN)

When RS232/485 TO WIFI ETH (B) is used as AP, other computers or devices can be connected to the serial port server as STA through RJ45 (i.e. network cable) and wireless mode, and a network is formed centering on the serial port server. The IP addresses of all devices in the network work in the same network segment and can communicate with each other, as shown in the following figure:

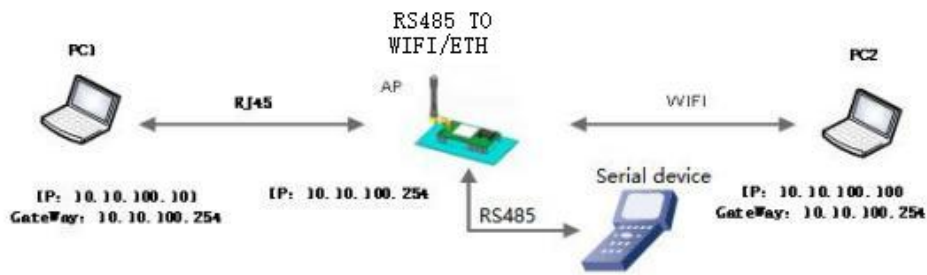

Figure Attached Private Local Area Network (APLAN)

Serial server parameter setting:

(1) Enable Ethernet port

AT+FEPHY=on

(2) Restore the factory settings to make the above settings take effect.

AT+RELD

Note that the AT+RELD command will not restore the above settings.

(3) Set the serial port server as AP

AT+WMODE=AP

(4) LAN parameters of serial port server need not be set by default, and IP address (DHCP gateway) and subnet mask of serial port server can also be modified as needed. The default values are used here:

AT+LANN=10.10.100.254,255.255.255.0

(5) Restart the serial server to complete the parameter setting.

5.4.2 WIRED NETWORKING APPLICATION (APWAN)

The RS232/485 TO WIFI ETH (B) serial server is used as AP, Ethernet port is set as WAN port, and it is connected to the route that can access the external network, so the DHCP server function is enabled. The serial server is used as a secondary router, and a PC or other smart handheld device can access the Internet by connecting to the serial server AP. At this time, the default AP of the serial port server is usually RS232/485 TO WIFI ETH (B)_xxxx, which has no encryption and can be set through web pages or at commands.

After the serial server is connected to the AP, it obtains the IP address from the AP (as shown in Figure 192.168.1.10). The serial server itself forms a subnet (default is 10.10.100.254), and the devices on the Ethernet port are assigned addresses by the serial server (as shown in Figure 10.10.100.100, as shown below):

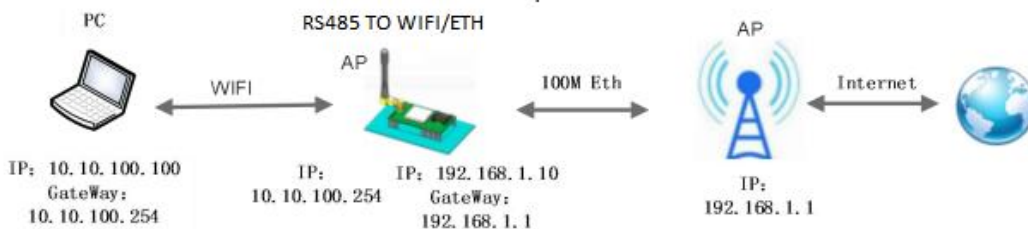

Figure Attached Private Wide Area Network (APWAN)

Serial server parameter setting:

(1) Enable Ethernet port

AT+FEPHY=on

(2) Set the serial server Ethernet port to work in WAN port mode

AT+FVEW=enable

(3) Restore factory settings for the above settings to take effect

AT+RELD

Note: The AT+RELD command will not restore the above settings.

(4) The serial server is operating in AP mode and DHCP is enabled (default, select settings).

AT+WMODE=ap

AT+DHCPDEN=on

(5) Considering security, you can modify the AP name and encryption parameters (optional).

AT+WAP=11BGN,B2-WIFI-TEST,Auto (select setting)

AT+WKEY=WPA2PSK,AES,waveshare (select setting)

(5) You can choose to set the LAN parameters of the serial server, including IP address (DHCP gateway) and subnet mask (optional).

AT+LANN=192.168.2.1,255.255.255.0

Note: it is necessary to ensure that the set LANIP address cannot be in the same network segment as the WANIP address obtained by the serial server from the AP!

(6) Restart the serial server to complete the parameter setting.

5.4.3 WIRED NETWORKING APPLICATION (ROUTING)

The RS232/485 TO WIFI ETH (B) serial server as STA, and the serial server works in router mode. After the serial server is connected to the AP, it obtains the IP address from the AP (as shown in Figure 192.168.1.101). The serial server itself constitutes a subnet (10.10.100.254 by default), and the devices on the Ethernet interface are assigned addresses by the serial server (as shown in Figure 10.10.100.101). As shown in this figure, PC1 is in the subnet (NAT), so the connection can be initiated from PC1 and connected to PC2 (because RS232/485 TO WIFI ETH (B) works in routing mode), but PC2 cannot actively connect to PC1.

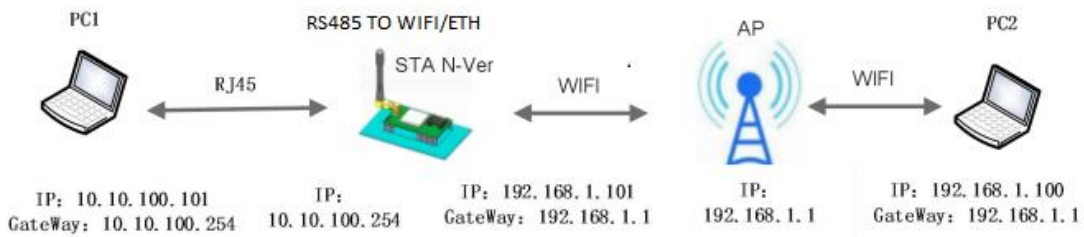

Figure Wired and Wireless Networking Application (Routing)

Serial server parameter setting:

(1) Set the serial server software version to N-Ver.

AT+FVER=n

(2) Enable Ethernet interface.

AT+FEPHY=on

(3) Restore factory settings for the above settings to take effect.

AT+RELD

Note that the AT+RELD command will not restore the above settings.

(4) Set the serial server to STA

AT+WMODE=STA

(5) Set the SSID and password of the route to be connected to the serial server (according to the actual parameters of the route).

Example: AT+WSSSID=WAVESHARE-WIFI-TEST

AT+WSKEY=WPA2PSK,AES,www.waveshare.com

(6) Set the serial server LAN parameters, IP address (DHCP gateway) and subnet mask.

Inquire about the IP obtained by the serial port server from the AP:

AT+WANN

Set the LAN parameters of the serial server to ensure that the LANIP address cannot be in the same network segment as the WAN IP address obtained by the serial server from the AP. In this case, since it is not in the same network segment, you can use the default instead of setting it.

AT+LANN=10.10.100.254,255.255.255.0 (optional)

(7) Restart the serial server to finish the parameter setting.

Web Page Configuration: Access the built-in web page of the server, enter the Ethernet functional settings page, and within the Ethernet port mode configuration, set the Ethernet port mode to 'n'.

As shown below:

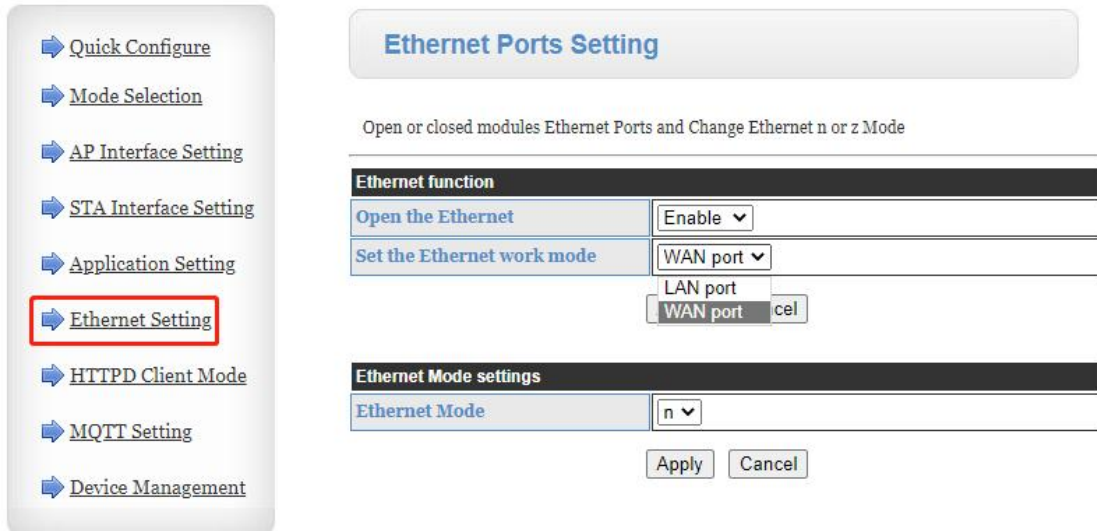

The screenshot shows the 'Ethernet Ports Setting' web page. On the left, a navigation menu lists various settings, with 'Ethernet Setting' highlighted in red. The main content area is titled 'Ethernet Ports Setting' and includes the following configuration options:

- Ethernet function:**
 - Open the Ethernet: Enable (dropdown)
 - Set the Ethernet work mode: WAN port (dropdown)
 - LAN port: WAN port (dropdown)
 - LAN port: cel (text input)
- Ethernet Mode settings:**
 - Ethernet Mode: n (dropdown)

Buttons for 'Apply' and 'Cancel' are located at the bottom of the configuration area.

Figure Network Port Mode Setting

After click "OK", it reboots.

5.4.4 WIRED NETWORKING APPLICATION (BRIDGE)

The serial server of RS232/485 TO WIFI ETH (B) is STA, and works in bridge mode. After the serial server connecting to AP, the device of the Ethernet port gets the IP address from the AP (as shown in

Figure 192.168.1.101). At this point, the entire network treats the serial server as if it were a transparent device. Communication between PC1 and PC2 is possible without any constraints, as if the serial server doesn't introduce any limitations or obstacles in their interaction. However, for the RS232/485 TO WIFI ETH (B) serial server to communicate with other devices, it requires a static LAN IP address to be configured, such as the example address 192.168.1.10.

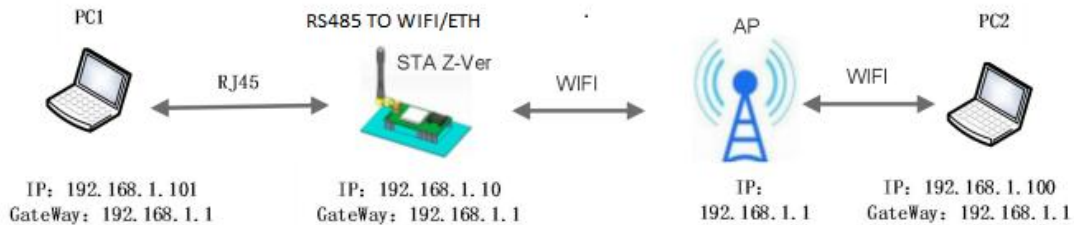

Figure Wired and Wireless Networking Application (Bridging):

6. PRODUCT FUNCTION DESCRIPTION

6.1 WORKING MODE

RS232/485 TO WIFI ETH (B) has five working modes:

- (1) Transparent transmission mode
- (2) Serial Command Mode
- (3) HTTPDClient mode
- (4) ModbusTCP<=>ModbusRTU mode.
- (5) AT Command Mode

Upon power-up, the serial server enters a pre-configure mode. By default, it enters transparent transmission mode. Switching between modes (1) to (4) can be configured using the serial server's built-in web page or the AT command AT+TMODE.

In modes (1), (2), (3), and (4), the serial port sends "+++" followed by "a". Once the serial server receives these sequences, it sequentially responds with acknowledgment codes "a" and "+ok". This indicates the transition into mode (5), the AT command mode. To return from AT command mode to the original operational mode, the command AT+ENTM (with a carriage return) can be used.

Specific timing requirements for entering the AT command mode can be found in the "RS232/485 TO WIFI ETH (B) AT Command Set" documentation.

6.1.1 TRANSPARENT TRANSMISSION MODE

RS232/485 TO WIFI ETH (B) supports the serial port transparent transmission mode. In this mode, all the data that need to be sent and received are transparently transmitted between the serial port

and WIFI/ Ethernet, without any parsing, so as to realize the data transmission between universal serial port devices and network devices.

In the transparent transmission mode, it can be completely compatible with the user's original software platform. User equipment can basically support wireless data transmission without making software changes, as shown in the following figure:

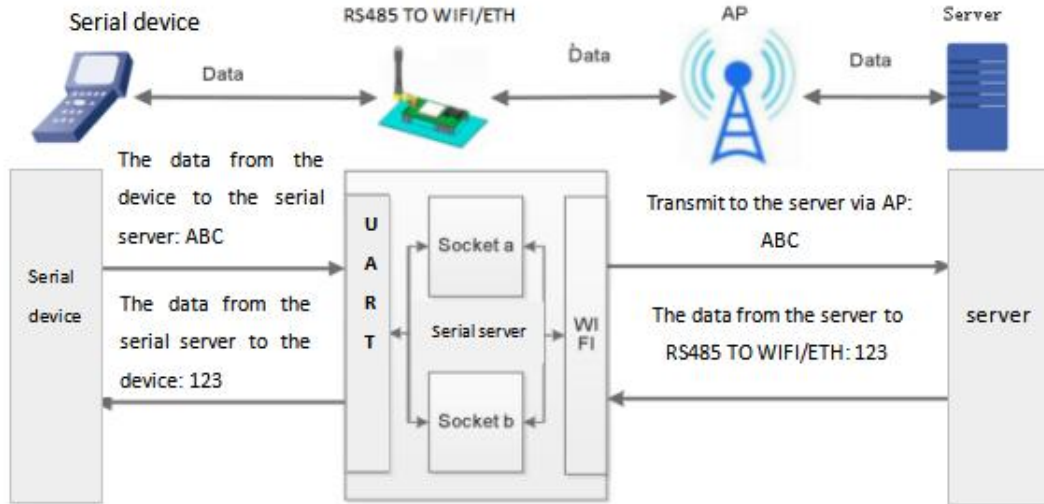

Figure Transparent transmission function block diagram

6.1.2 SERIAL COMMAND MODE

In this mode, users can send data to servers according to our protocol, and can send data to different servers without restarting.

In this mode, when the RS232/485 TO WIFI ETH (B) serial server is used as UDPClient or TCPClient, users are allowed to send serial data to different servers, regardless of the number of Socket.

The client's MCU only needs to send data packets according to the format specified by our company, and the serial server will parse the received data. If the data conforms to the protocol, the serial server will send the parsed data to the designated server. If the data does not conform to the protocol, it will be treated as a waste package without sending it to the server.

The client MCU sends the data packet according to the following format, and after the WIFI serial server finishes parsing, only N bytes of data are sent to the target address. When data is returned, the data is directly output from the serial port without parsing.

Table Serial command mode protocol

Header	Length	Function code	Reserved parameter area:	Target port	Target address	Data	Checksum
2	2 (n+m+5)	1	2	2	m	n	1

Header:

Always 0x550xaa

Length:

The sum of all bytes from the start of the function code to the checksum (excluding the checksum). **Note: The high byte comes first.**

Function code:

Bit0: (UDP: 0; TCP: 1)

Bit1: (Long connection: 0) **Note: Only long connections are supported at present.**

Bit2: (IP: 0; Domain name: 1)

Bit7: (Simplified Protocol: 0; Full Protocol: 1) **Note: Currently, only the simplified protocol is supported.**

Note:

- For Bit1, long connection, after sending data, the connection will be maintained until the target address is changed again.
- For Bit2, it represents whether the target address is IP or domain name, and if it is IP, the target address is 4 bytes; If it is a domain name, the length of the target address is the length of the entire domain name string (where the last byte of the target address is 0x00, that is, the end of the string, and the length of the domain name is indefinite).
- For Bit7, under the simplified protocol, the reply frame only contains data; Under the full protocol, the reply frame will have frame formats such as sending failure, waiting timeout, and responding device IP under UDP broadcast.

Reserved parameter area:

First byte: long connection, here 0x00.

Second byte: reserved

Target port:

Little-endian format, with the low byte first. For example, the port number 33 would be represented here as 2100.

Target address:

If it is IP, it is 4 bytes, for example, 192.168.0.133 means 8500A8C0; If it is a domain name, the length of the address is uncertain, ending with '\0'.

Data:

The length is variable, and the maximum is 4*1024 bytes.

Checksum:

Starting from the function code and continuing until the byte just before the checksum byte, perform a summation checksum.

The following are specific application examples:

Send data: 55aa000a00000021008500A8C0010f

Length byte 000a: The length is n+m+5, here it is 10.

Function code 00: UDP mode

The destination IP address is 8500A8C0: 192.168.0.133.

Data area 00: length is 1,

Checksum calculation: $0x00+0x00+0x21+0x00+0x85+0x00+0xA8+0xC0+0x01 = 0x0F$.

Note: The serial command mode is a data transmission mode, so please pay attention to distinguish it from the AT command mode which can query or set the parameters of the serial server!

6.1.3 HTTPCLIENT MODE

In this mode, the user can send the data to the designated HTTP server, and RS232/485 TO WIFI ETH (B) will automatically add an HTTP protocol header in front of the sent data, and the specific content of the protocol header can be set through AT instruction or webpage.

This mode is used for RS232/485 TO WIFI ETH (B) to transmit data to or obtain data from the HTTP server. After the user sets the specific content of HTTP header with AT command or webpage. Every time data is sent, RS232/485 TO WIFI ETH (B) will automatically package the sent data into HTTP protocol data and send it to the designated HTTP server. The data received from the server will be directly transmitted to the serial port without any processing. RS232/485 TO WIFI ETH (B) handles the complicated HTTP protocol, which is convenient for users to program the serial port without considering too many HTTP issues. The maximum size of data sent is 1000 bytes.

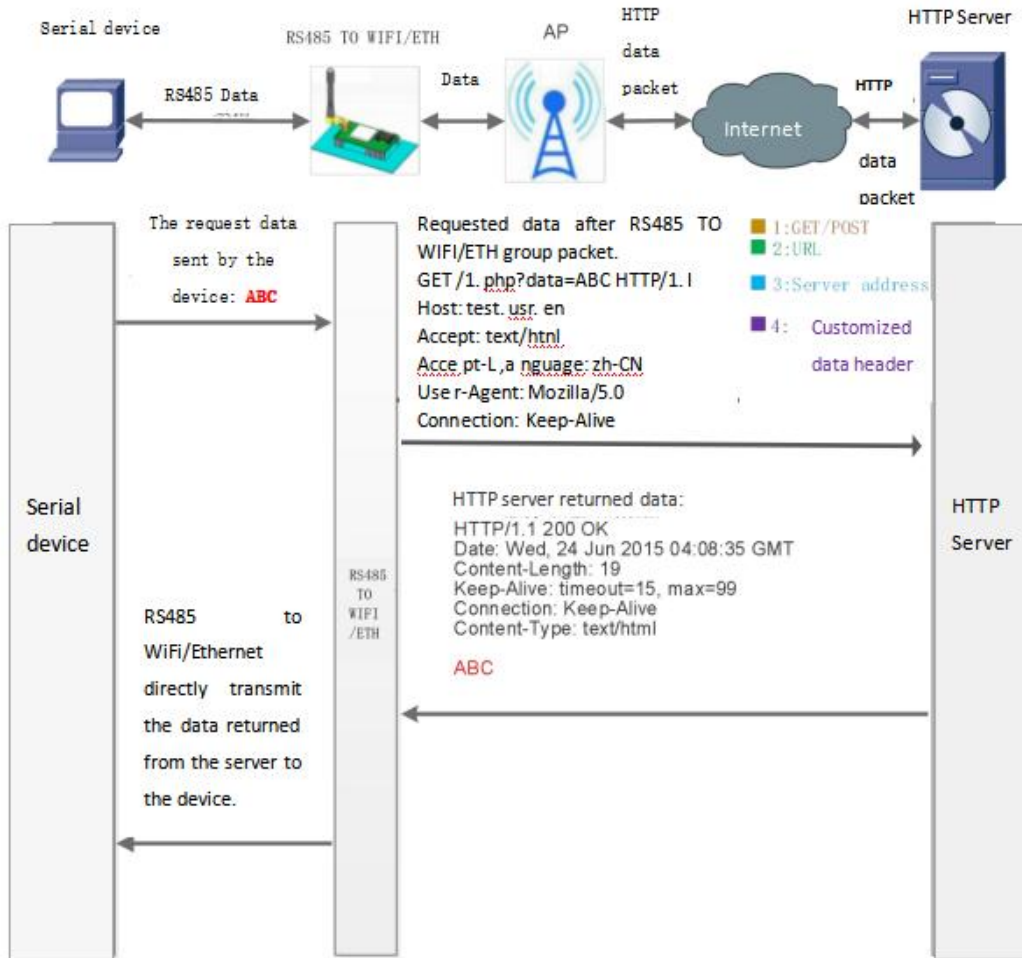

Figure HTTPClient functional block diagram

In GET mode, after the serial server receives the user's serial data packet, the packaging format is as follows:

GET mode package format

```
GET /1.php?data=ABC HTTP/1.1
Host: test.usr.cn
Accept: text/html
Accept-Language: zh-CN
User-Agent: Mozilla/5.0
Connection: Keep-Alive
```

- 1: GET
- 2: URL
- 3: UART Data
- 4: Server address
- 5: Customized data header

In POST mode, after the serial server receives the user serial data packet, the packaging format is as follows:

POST mode package format

```
POST /2.php? HTTP/1.1
Host: test.usr.cn
Connection: Keep-Alive
Content-length: 3
ABC
```

- 1: POST
- 2: URL
- 3: Server address
- 4: Customized data header
- 5: UART Data

Figure POST type data packaging mode

AT command setting:

Table HTTPDClient instruction list

No.	Command	Note
1	HTPMODE	Switching between new and old versions of HTTP header settings (HTTPDClient)
2	HTTPURL	Set/query the IP and port of HTTP servers in old version
3	HTTPTP	Set/query the HTTP protocol request in old version:
4	HTTPPH	Set/query the HTTP protocol header path in old version:
5	HTTPCN	To set/query the HTTP protocol header Connection in old version:
6	HTTPUA	To set/query the HTTP protocol header User-Agent in old version:
7	HTPSV	Set/query server address and IP (HTTPDClient) in new version
8	HTPTP	Set/query the request method (HTTPDClient) in new version
9	HTPURL	Setup/query request path (HTTPDClient) in new version
10	HTPHEAD	Set/query HTTP header (HTTPDClient) in new version.
11	HTTPSCEN	Set/query the connection mode of HTTPClient (long/short)
12	HTTPSCT	Set/query HTTPDClient short connection timeout (3-65535s)

The following are examples of specific applications:

First, use AT command to set the related parameters of HTTP:

If the data sent is 1234, Then the 80 port of test.waveshare.com will get the following data:

POST/2.php?HTTP/1.1

Connection:keep-alive

User-Agent:lwip1.3.2

Content-Length:4

Host:test.waveshare.com:80

1234

If the HTTP type is GET, the data received on port 80 of test.waveshare.com is

GET/1.php ? data=1234HTTP/1.1

Connection:keep-alive

User-Agent:lwip1.3.2

Host:test.waveshare.com:80

When the request mode is POST or PUT, the serial data will be added to the position behind the HTTP protocol header; When the request method is GET, the serial data will be added to the back of the protocol header path.

Users can customize the content of HTTP headers in the new definition mode, and can add, delete and modify the content of each HTTP header at will according to their own needs (if the HTTP request type is POST/PUT, RS232/485 TO WIFI ETH (B) will automatically add the Content-Length). The set instructions include AT+HTPMODE, AT+HTPSV, AT+HTPTP, AT+HTPURL and AT+HTPHEAD. Please refer to the chapter of AT Command Set for the specific command setting process. Similarly, there is a corresponding setting page in the webpage.

Note: The above definition method is called the old version definition method. In the new version of the setting mode, a new definition mode of HTTP header is added. If the HTTP header is set with AT command, please use "< < CRLF > >" instead of carriage return, and the carriage return problem is not needed when setting the built-in webpage.

The webpage settings are as follows:

- (1) set the HTTPDClient request type:

中文 English

- ➔ Quick Configure
- ➔ Mode Selection
- ➔ AP Interface Setting
- ➔ STA Interface Setting
- ➔ Application Setting
- ➔ Ethernet Setting
- ➔ **HTTPD Client Mode**
- ➔ MQTT Setting
- ➔ Device Management

HTTPD-Client Mode

In HTTPD_Client mode, set the relevant parameters of HTTP

Note: HTTPD Client mode is used to communicate with HTTP Server. It encapsulate the serial data to be HTTP protocol data, then send to HTTP Server.

HTTPD Header Set Mode	new ▾
HTTPD Server address	pico.wiki
HTTPD Server port	80
HTTPD Request Type	GET ▾
HTTPD Header path	/get-data.php?
Custom HTTP Header	Content-type: text/html; charset=utf-8

when HTTPD header set to be "old", use old setting method, that is to fill each header. When set to be "new", use new setting method, the header can be user-defined(There can't have "enter" at the end).

Apply Cancel

Figure HTTPD Client request type

(2) Under the serial port and network configuration page, select the HTTPDClient mode as long/short.

If it is set to the short connection state, you can set the timeout of 3-65535(s).

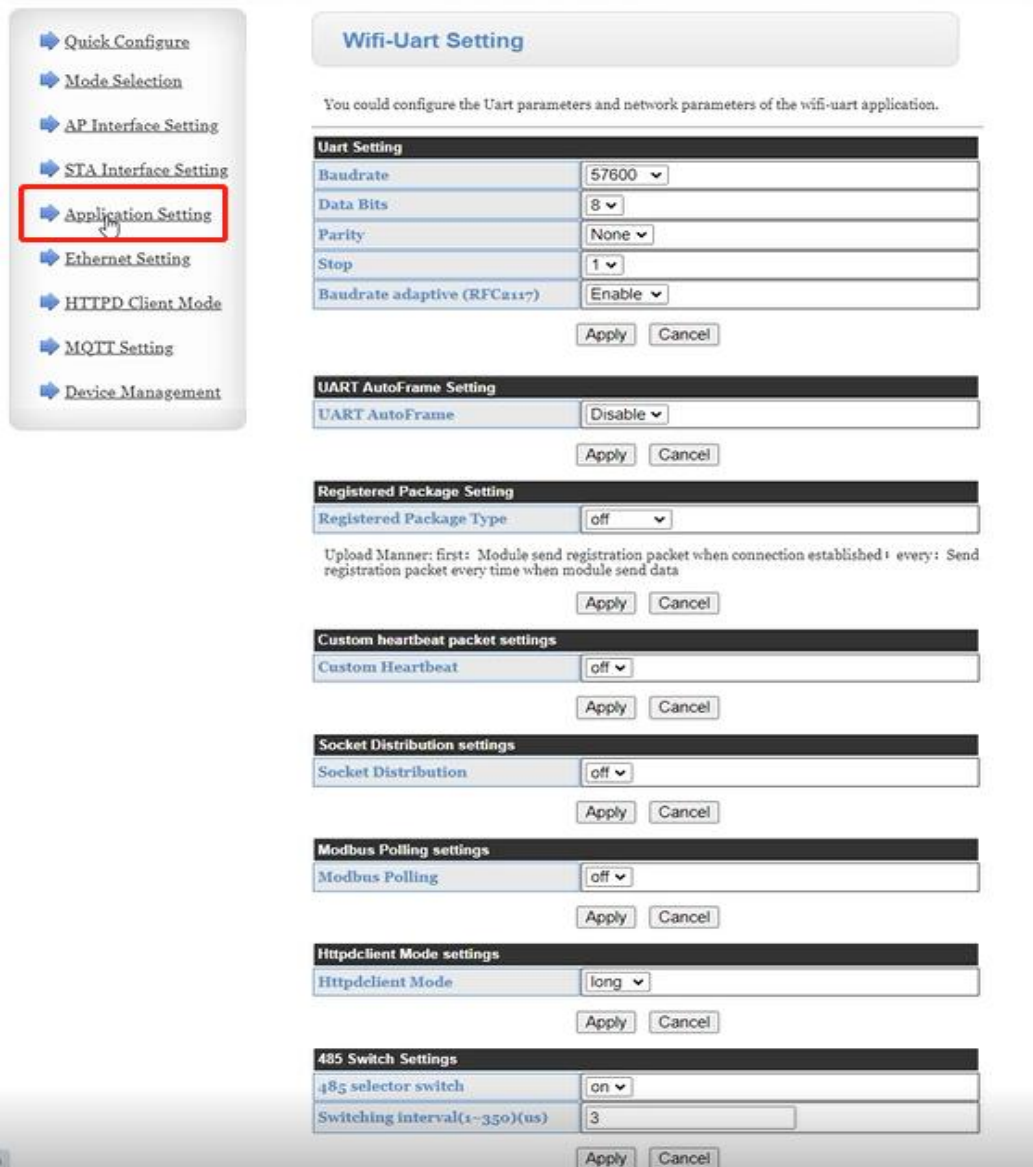

Wifi-Uart Setting

You could configure the Uart parameters and network parameters of the wifi-uart application.

Uart Setting

Baudrate	57600
Data Bits	8
Parity	None
Stop	1
Baudrate adaptive (RFC2117)	Enable

Apply Cancel

UART AutoFrame Setting

UART AutoFrame	Disable
----------------	---------

Apply Cancel

Registered Package Setting

Registered Package Type	off
-------------------------	-----

Upload Manner: first: Module send registration packet when connection established; every: Send registration packet every time when module send data

Apply Cancel

Custom heartbeat packet settings

Custom Heartbeat	off
------------------	-----

Apply Cancel

Socket Distribution settings

Socket Distribution	off
---------------------	-----

Apply Cancel

Modbus Polling settings

Modbus Polling	off
----------------	-----

Apply Cancel

Httpdclient Mode settings

Httpdclient Mode	long
------------------	------

Apply Cancel

485 Switch Settings

485 selector switch	on
Switching interval(1-350)(us)	3

Apply Cancel

Figure HTTPDClient Short Connection Timeout Settings

The user can also set it through the AT command.

(1) Set/query long/short connection of HTTPDClient, taking short connection as an example;

AT+HTTPSCEN=short

(2) Set/query timeout interval (3-65535) seconds in short connection mode; Take 3 seconds as an example;

AT+HTTPST=3

HTTPD POST measured demonstration:

(1) Set the HTTPD Client POST parameter through the web page:

中文 English

- ➔ Quick Configure
- ➔ Mode Selection
- ➔ AP Interface Setting
- ➔ STA Interface Setting
- ➔ Application Setting
- ➔ Ethernet Setting
- ➔ HTTPD Client Mode
- ➔ MQTT Setting
- ➔ Device Management

HTTPD-Client Mode

In HTTPD_Client mode, set the relevant parameters of HTTP

Note: HTTPD Client mode is used to communicate with HTTP Server. It encapsulate the serial data to be HTTP protocol data, then send to HTTP Server.

HTTPD Header Set Mode	old ▾
HTTPD Server address	pico.wiki
HTTPD Server port	80
HTTPD Request Type	POST ▾
HTTPD Header path	/post-data-json.php
HTTPD Header Connection	keep-alive
HTTP Header User-Agent	lwip1.3.2
HTTP Header Content-type	application/json

when HTTPD header set to be "old", use old setting method, that is to fill each header. When set to be "new", use new setting method, the header can be user-defined(There can't have "enter" at the end).

Apply Cancel

(2) Open SSCOM serial communication assistant and send Json format through RS232/485 interface:

```
{
  "apikey": "tPmAT5Ab3j888",
  "value1": "33",
  "value2": "3",
  "value3": "22"
}
```

(3) After sending successfully, the prompt in the red box will be returned:

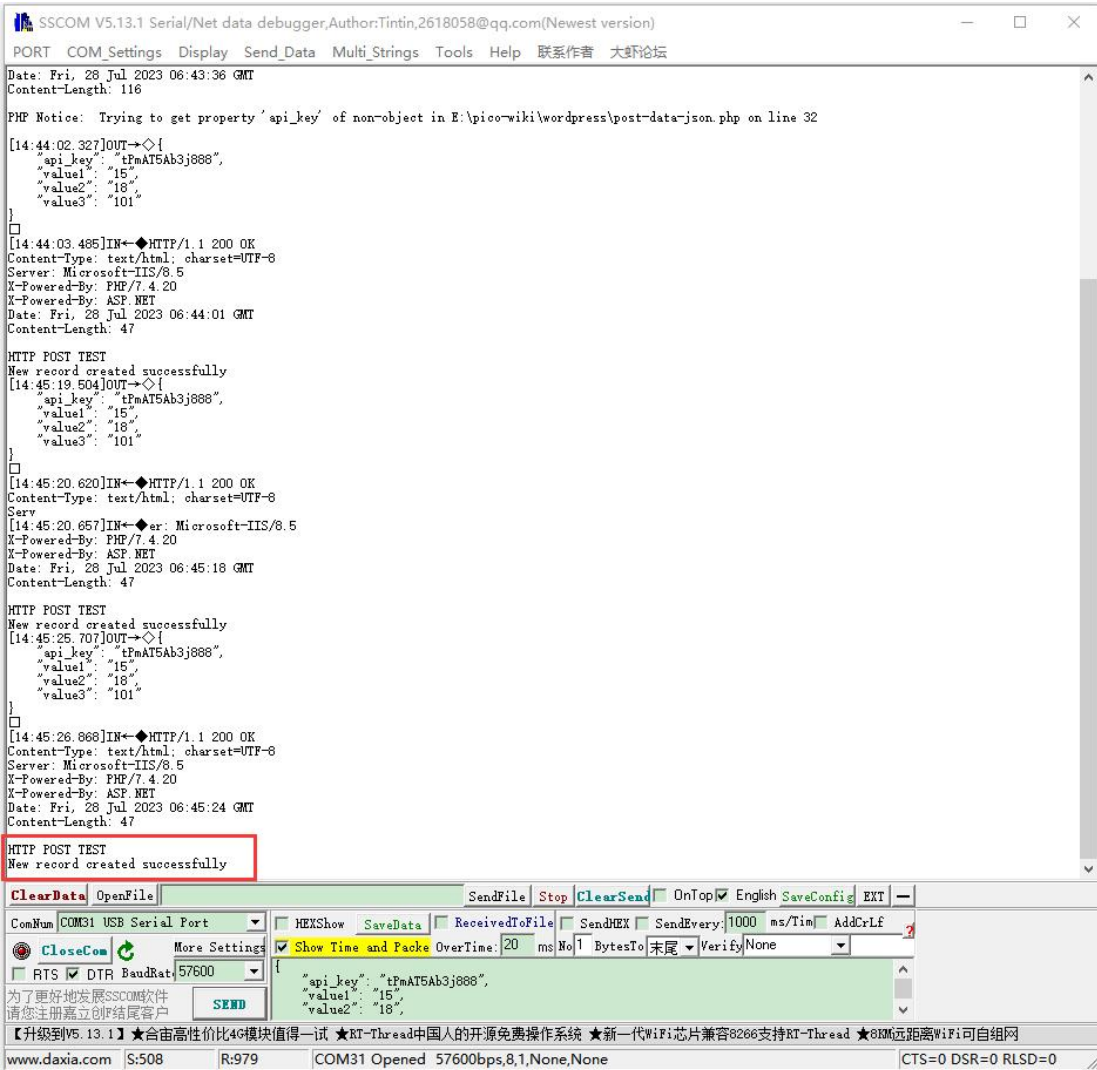

```

SSSCOM V5.13.1 Serial/Net data debugger,Author:Tintin,2618058@qq.com(Newest version)
PORT COM_Settings Display Send_Data Multi_Strings Tools Help 联系作者 大虾论坛
Date: Fri, 28 Jul 2023 06:43:36 GMT
Content-Length: 116
PHP Notice: Trying to get property 'api_key' of non-object in E:\pico-wiki\wordpress\post-data-json.php on line 32
[14:44:02.327]OUT->◇{
  "api_key": "tPmAT5Ab3j888",
  "value1": "15",
  "value2": "18",
  "value3": "101"
}
[14:44:03.485]IN<-◆HTTP/1.1 200 OK
Content-Type: text/html; charset=UTF-8
Server: Microsoft-IIS/8.5
X-Powered-By: PHP/7.4.20
X-Powered-By: ASP.NET
Date: Fri, 28 Jul 2023 06:44:01 GMT
Content-Length: 47
HTTP POST TEST
New record created successfully
[14:45:19.504]OUT->◇{
  "api_key": "tPmAT5Ab3j888",
  "value1": "15",
  "value2": "18",
  "value3": "101"
}
[14:45:20.620]IN<-◆HTTP/1.1 200 OK
Content-Type: text/html; charset=UTF-8
Server: Microsoft-IIS/8.5
X-Powered-By: PHP/7.4.20
X-Powered-By: ASP.NET
Date: Fri, 28 Jul 2023 06:45:18 GMT
Content-Length: 47
HTTP POST TEST
New record created successfully
[14:45:25.707]OUT->◇{
  "api_key": "tPmAT5Ab3j888",
  "value1": "15",
  "value2": "18",
  "value3": "101"
}
[14:45:26.868]IN<-◆HTTP/1.1 200 OK
Content-Type: text/html; charset=UTF-8
Server: Microsoft-IIS/8.5
X-Powered-By: PHP/7.4.20
X-Powered-By: ASP.NET
Date: Fri, 28 Jul 2023 06:45:24 GMT
Content-Length: 47
HTTP POST TEST
New record created successfully

```

ClearData OpenFile SendFile Stop ClearSend OnTop English SaveConfig EXT

ComNum COM31 USB Serial Port HEXShow SaveData ReceivedToFile SendHEX SendEvery 1000 ms/Time AddCrLf

CloseCom More Settings Show Time and Packs OverTime: 20 ms No 1 BytesTo 末尾 VerifyNone

RTS DTR BaudRate 57600

为了更好地发展SSSCOM软件
请您注册嘉立创结尾客户

SEND

【升级到V5.13.1】★合宙高性价比4G模块值得一试 ★RT-Thread中国人的开源免费操作系统 ★新一代WiFi芯片兼容8286支持RT-Thread ★8106远距离WiFi可自组网

www.daxia.com | S:508 | R:979 | COM31 Opened 57600bps,8,1,None,None | CTS=0 DSR=0 RLSD=0

(4) Open a web page:<https://pico.wiki/esp-chart.php> , you can see the POST to the server data chart, as shown in the figure below:

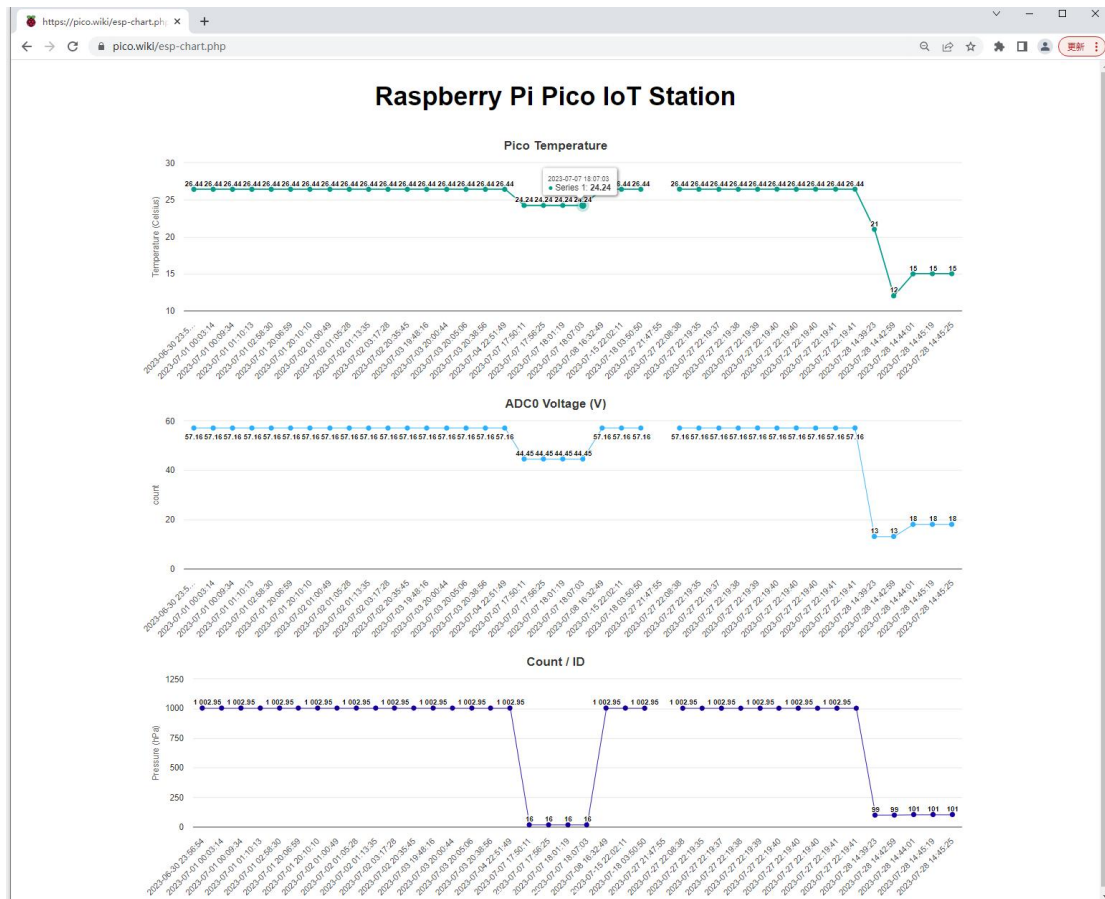

HTTPD GET measured demonstration:

- (1) Set the HTTPD Client GET parameter through the web page:

中文 English

- ➔ Quick Configure
- ➔ Mode Selection
- ➔ AP Interface Setting
- ➔ STA Interface Setting
- ➔ Application Setting
- ➔ Ethernet Setting
- ➔ **HTTPD Client Mode**
- ➔ MQTT Setting
- ➔ Device Management

HTTPD-Client Mode

In HTTPD_Client mode, set the relevant parameters of HTTP

Note: HTTPD Client mode is used to communicate with HTTP Server. It encapsulate the serial data to be HTTP protocol data, then send to HTTP Server.

HTTPD Header Set Mode	new ▾
HTTPD Server address	pico.wiki
HTTPD Server port	80
HTTPD Request Type	GET ▾
HTTPD Header path	/get-data.php?
Custom HTTP Header	Content-type: text/html; charset=utf-8

when HTTPD header set to be "old", use old setting method, that is to fill each header. When set to be "new", use new setting method, the header can be user-defined(There can't have "enter" at the end).

Apply Cancel

(2) Open SSCOM serial communication assistant and send it through RS232/485 interface. You need to get the latest value of a certain value on the webpage, for example, to get the latest value of value3:

variable=value3

(3) After sending successfully, the following is returned:

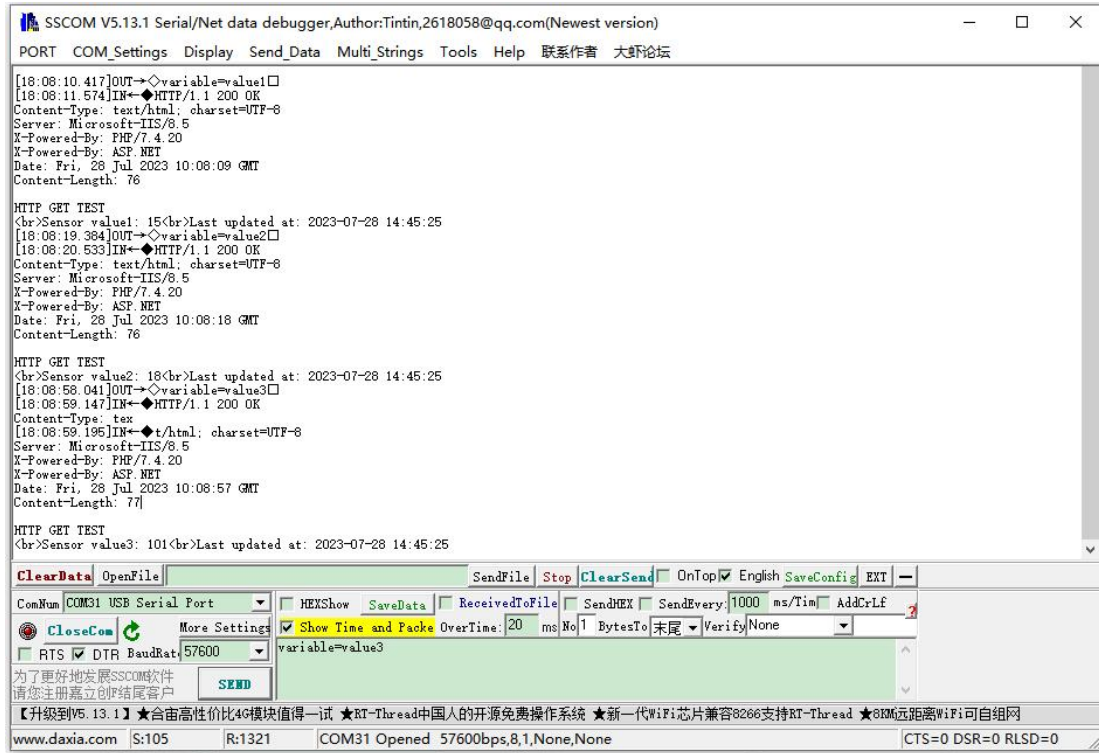

(4) It is the same as that obtained through a web browser, as shown in the following figure:

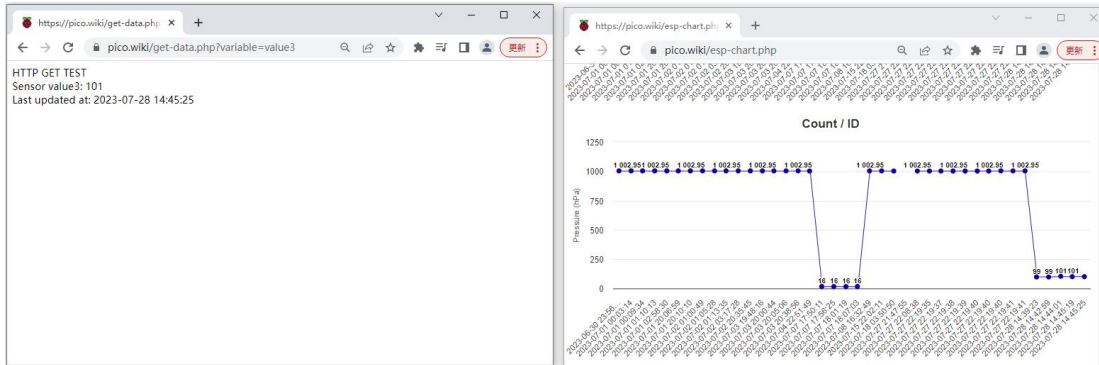

6.1.4 MODBUS TCP<=>MODBUS RTU CONVERSION MODE

This serial server supports ModbusTCP to ModbusRTU (ModbusASCII is not supported); The network parameters of the module should correspond to those of the application software, the TCPserver should correspond to the TCPclient, and the ports should be configured the same, and the working mode should be ModbusTCP<=>ModbusRTU.

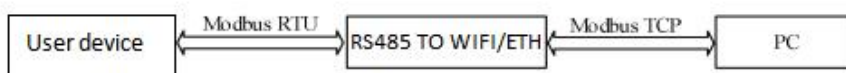
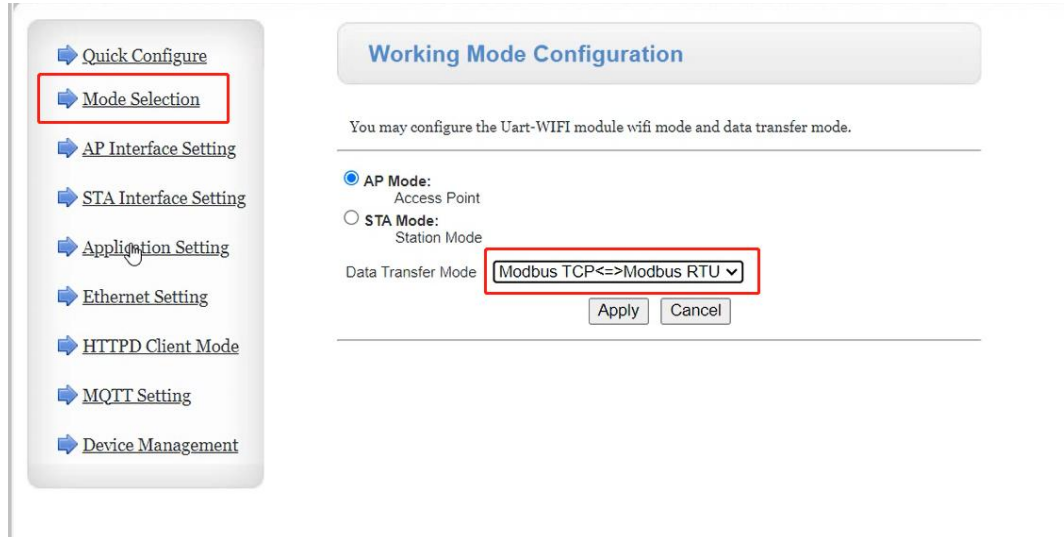

Figure Modbus RTU<=>Modbus TCP

Set by AT command:

AT+TMODE=modbus

There are also corresponding settings pages in the webpage:



6.1.5 AT Command Mode

In AT command mode, users can query the current status of WIFI serial server or set the parameters of WIFI serial server by sending AT command.

6.2 WIRELESS CHARACTERISTICS

6.2.1 AUTOMATIC FREQUENCY SELECTION FUNCTION

When RS232/485 TO WIFI ETH (B) works in STA mode, RS232/485 TO WIFI ETH (B) will automatically adjust to the same channel as AP according to the wireless channel of AP, and access it.

When RS232/485 TO WIFI ETH (B) works in AP mode, it can be set to automatic frequency selection mode, so when RS232/485 TO WIFI ETH (B) is started, a better wireless channel will be selected according to the surrounding environment.

6.2.2 SECURITY MECHANISM

The RS232/485 TO WIFI ETH (B) serial server supports a variety of wireless network encryption methods, which can fully guarantee the safe transmission of data, including:

- 1.WPA-PSK/TKIP
- 2.WPA-PSK/AES
- 3.WPA2-PSK/TKIP

4.WPA2-PSK/AES

Note: The passwords of WPA-PSK and WPA2-PSK are 8-63 digits.

6.2.3 STA JOINS THE ROUTING FUNCTION

The working mode of RS232/485 TO WIFI ETH (B) is set to Station mode. Click the "Search" button in the "Wireless Terminal Settings" page, and a window will pop up to display the information of the surrounding AP. After selecting the router, you will return to the original page. At this time, the encryption mode and encryption algorithm have been filled in, and you only need to write the password as prompted.

6.2.4 STA ADDRESS BINDING FUNCTION

RS232/485 TO WIFI ETH (B) supports the function of binding the BSSID of the destination network during the networking process (as STA, during the AP connection process). According to the 802.11 protocol, different wireless networks can have the same network name (i.e. SSID/ESSID), but must correspond to a unique BSSID address (i.e. MAC address). Because illegal intruders can establish wireless networks with the same SSID/ESSID to connect STAs in the network to illegal APs, resulting in network leakage. So by binding BSSID addresses, STA can be prevented from accessing illegal networks, thereby improving the security of wireless networks.

6.3 SOCKET COMMUNICATION

The working methods of SocketA include: TCP Server, TCP Client, UDP Server, and UDP Client. Currently, SocketB supports TCP client and UDP Client.

When SocketA is configured as TCPServer, it can support up to a maximum of 24 TCP client connections in the TCP link. In a multi TCP link connection, data transmitted from TCP will be forwarded one by one to the serial port. The data coming from the serial port will be duplicated and forwarded to each TCP connection, resulting in multiple copies being sent to each connected TCP link. The specific data flow chart is shown as follows:



Figure multi-TCP link data transmission diagram

SocketA settings: AT+NETP/AT+TCPTO/AT+TCPLK/AT+TCPDIS.

Table SocketA related AT command list

	Item	Note
1	NETP	Set/query the network protocol parameters of TCPA
2	TCPLK	Query whether the TCP link is established.
3	TCPTO	Set/query TCP timeout
4	TCPDIS	Connect/disconnect TCP (valid only for TCPClient)

SocketB setting: AT+TCPB/AT+TCPPTB/TCPADDB/TCPTOB/TCPLKB/TCPDIS

Table Socket B Related AT command list

	Item	Note
1	TCPB	Enable/disable TCPB function.
2	TCPPTB	Set/query the port number of TCPB
3	TCPADDB	Set/query the server address of TCPB.
4	TCPTOB	Set/query TCPB timeout
5	TCPLKB	Query whether the TCPB link has been established
6	TCPDIS	Connect/Disconnect TCP

Please refer to the section "4.3.4. AT Command Set" in this manual for specific AT command related parameters.

6.4 UART FRAMING MECHANISM

6.4.1 SERIAL PARAMETERS

Table Serial Parameters

Item	Parameters
Baudrate	300, 600, 1200, 1800, 2400, 4800, 9600, 19200, 38400, 57600, 115200, 230400, 345600, 460800
Data bit	5, 6, 7, 8
Stop bit	1, 2
Checksum byte	None, Even, Odd
485	NFC: No hardware flow control

Web page settings

Log in to the built-in webpage and set the serial port parameters on the "Serial Port and Network Settings" page, as follows:

- [Quick Configure](#)
- [Mode Selection](#)
- [AP Interface Setting](#)
- [STA Interface Setting](#)
- [Application Setting](#)
- [Ethernet Setting](#)
- [HTTPD Client Mode](#)
- [MQTT Setting](#)
- [Device Management](#)

Wifi-Uart Setting

You could configure the Uart parameters and network parameters of the wifi-uart application.

Uart Setting	
Baudrate	57600 ▾
Data Bits	8 ▾
Parity	None ▾
Stop	1 ▾
Baudrate adaptive (RFC2117)	Enable ▾

UART AutoFrame Setting	
UART AutoFrame	Disable ▾

Registered Package Setting	
Registered Package Type	off ▾

Upload Manner: first: Module send registration packet when connection established; every: Send registration packet every time when module send data

Figure Webpage Sets Serial Parameters

AT Command Settings

If you need to change the WiFi serial server baud rate to 115200bps, use the following command:

```
AT+UART=115200,8,1,None,NFC
```

6.4.2 UART FREE-FRAME MODE

The default interval time for two bytes in the WiFi serial server is 10ms, which means that when the interval time is greater than 10ms, a frame is considered complete.

Using the example of sending data from a serial device to a serial server, let me explain the process of free-frame assembling in a WiFi serial server:

Assuming that n is the interval for free-frame assembling, measured in milliseconds, where $T1 > n$, $T2 < n$, $T3 < n$, $T4 < n$, $T5 < n$, $T6 > n$, then Byte1 to Byte5 are treated as a single frame of data, as illustrated

below:

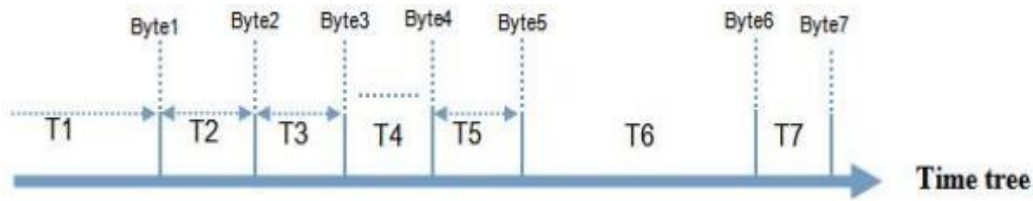

Figure Switch commands timing order

The default interval time for two bytes in the WiFi serial server is 10ms, which means that when the interval time is greater than 10ms, a frame is considered complete. This interval time can be configured to 50ms using the following AT command to meet the customer's requirements for serial port forwarding efficiency:

```
AT+FUARTTE=normal
```

After the setting is completed, it is necessary to enable the above settings with the command of Restore Factory Settings:

```
AT+RELD
```

Note that the AT+RELD command will not restore the above setting.

After testing, if it is set to 10ms, the time delay from WIFI->UART->WIFI loop is about 40 ~ 50ms if the data volume is not large.

However, if the interval time is set to 10ms and the client's MCU cannot guarantee sending the next byte within 10ms, the serial data might be fragmented.

To restore the default free framing interval of 10ms, you can use the following AT command:

```
AT+FUARTTE=fast
```

After the setting is completed, you also need to use the Restore Factory Settings command to enable the above settings.

For specific UART automatic framing operations, please refer to the "AT Command Set" section of this manual, which provides information on the UARTF/UARTFT/UARTFL commands.

6.4.3 UART AUTOMATIC FRAMING MODE

For fixed-length data frames on the serial port, you can enable the UART automatic framing function, and set the automatic framing trigger time and trigger frame length. RS232/485 TO WIFI ETH (B) will send the data from the serial port.

The received data is automatically framed and forwarded to the network.

1. Automatic framing trigger frame length: refers to RS232/485 TO WIFI ETH (B) receiving the specified number of bytes from the serial port, composing a data frame and forwarding it to the network.

2. Automatic framing trigger time: It means that RS232/485 TO WIFI ETH (B) will forward the received data to the network if the data received from the serial port is less than the length of the automatic framing trigger frame within the trigger time.

The time of automatic framing starts from the first byte received by the WIFI serial port server from the serial port. As shown in the figure below:

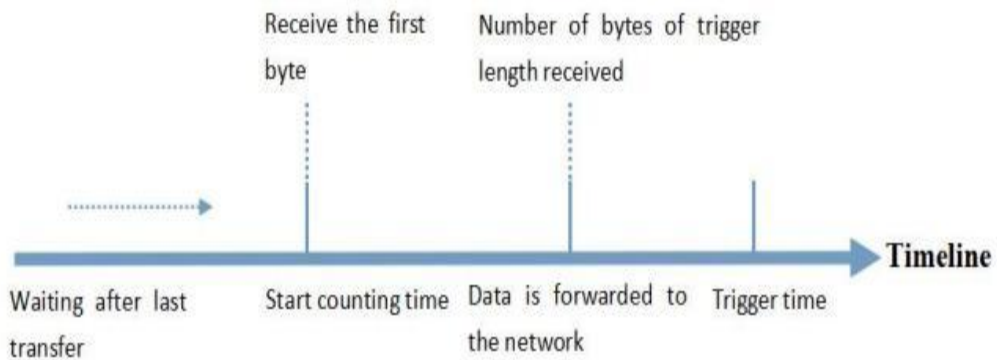

Figure automatic framing trigger frame length

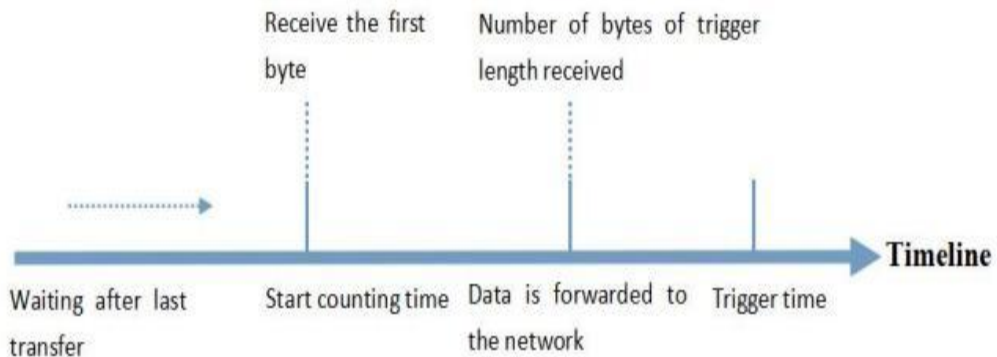

Figure automatic framing departure time

The specific UART automATIC framing operATIOn can be set through the "serial port and network settings-> serial port automATIC framing settings" section of the built-in webpage of WIFI serial port server or by using the at command. For the at command settings, please refer to the introduction of UARTF/UARTFT/UARTFL commands in the "at command set" chapter of this manual.

6.5 PASSWORD AUTHENTICATION WHEN TCP ESTABLISHES CONNECTION

This function is only applicable to RS232/485 TO WIFI ETH (B) as a TCPServer. When the TCPClient connects to RS232/485 TO WIFI ETH (B), RS232/485 TO WIFI ETH (B) will authenticate every connected TCP.

After connecting via TCPClient, the first data to be sent should be the web password of the RS232/485 TO WIFI ETH (B), followed by a carriage return and line feed. By default, the password of RS232/485 TO WIFI ETH (B) is admin, so the first data sent by TCPClient should be "0x610x640x6D0x690x6e0x0D0x0A" (hexadecimal). If the password is correct, RS232/485 TO WIFI ETH (B) returns "OK", otherwise returns "NO" and disconnects.

This function can be enabled or disabled in "TCP connection password verification" in the webpage.

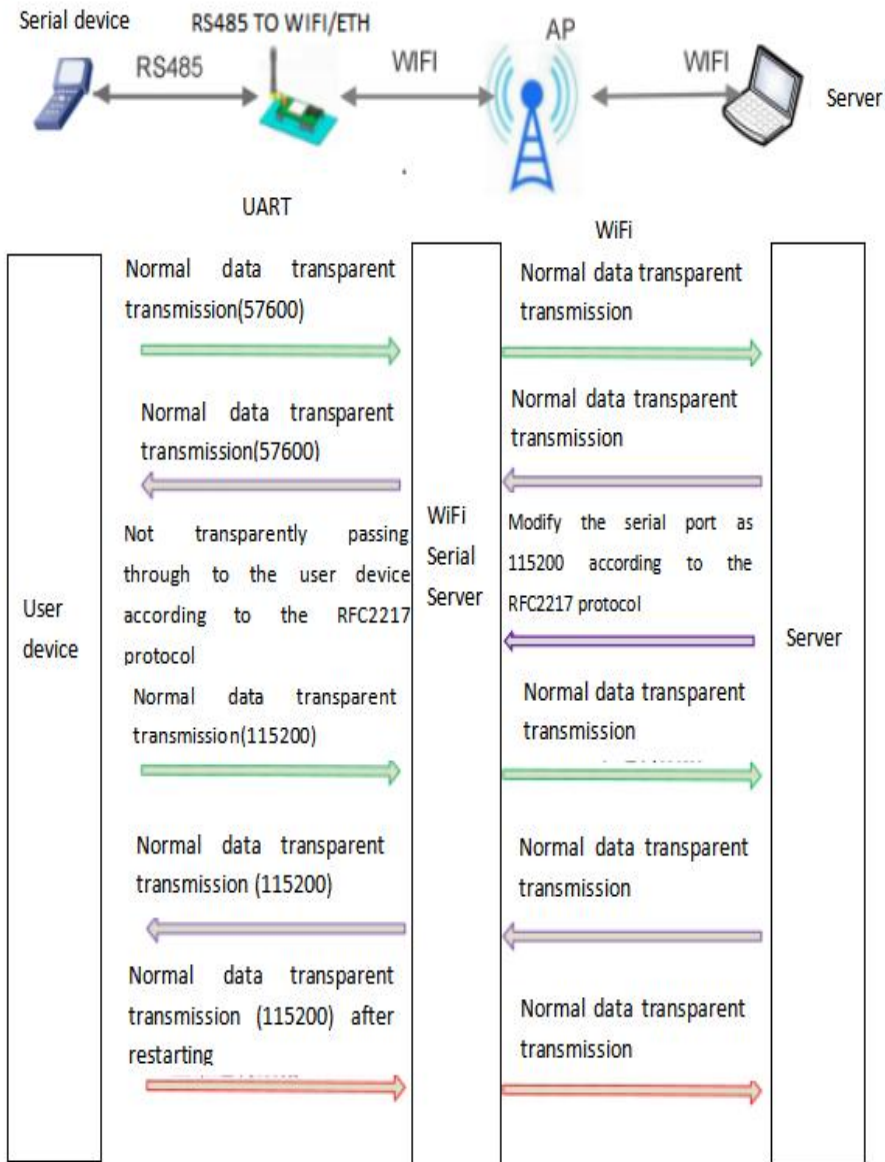

Figure RFC2217 automatic baud rate

6.6 DESCRIPTION OF RFC2217 PROTOCOL

The length of the protocol is 8 bytes, and the specific content of the protocol is as follows. The numerical value of the example is in HEX format:

Attachment: Explanation of the meaning of serial port parameter bit.

Table Query Instructions

Name	Header	Baudrate	Bits	Checksum
Bytes	3	3	1	1
Note	Reduce false positives by three bytes	Three bytes represent a baud rate value, with the high byte first	Different bits represent different meanings, See attached table	The checksum of the first four bytes, ignoring any carry-over
Example (115200, N, 8,1)	55AA55	01C200	83	46
Example (9600,N,8,1)	55AA55	002580	83	28

Form query reply instruction

No.	Name	Bytes	Note
1	Header	1	Fixed value 0xFF
2	Length	2	The total number of bytes after the length (excluding the length itself) and before the checksum byte (excluding the checksum byte).
3	Command code	1	Command type, and the reply instruction corresponding to the query instruction is 0x81.
4	AP number	1	Number of currently detected APs
5	SSID1	Indefinite length	The SSID of router 1.
6	Terminator	1	The SSID terminator for router 1, with a fixed value of 0x00.
7	Signal strength 1	1	The signal strength of router 1 network, ranging from 0 to 100, corresponds to an actual value of 0% to 100%.
8	Terminator	2	Terminator of signal strength 1, 0x0D, 0x0A.
...
M	SSIDn	Indefinite length	The SSID of router n.
M+1	end mark	1	SSID terminator of router n, fixed value 0x00.
M+2	Signal strength n	1	The signal strength of router N network ranges from 0 to 100, and the corresponding actual value is 0% to 100%.
M+3	Terminator	2	The terminator of signal strength n, 0x0D, 0x0A.
M+4	Checksum Bit	1	The cumulative sum of all bytes after the header (excluding the header) and before the checksum (excluding the checksum).

6.7 FAST NETWORKING PROTOCOL

When the WIFI serial server is operating in AP mode, it will open a UDP port for receiving fast networking protocol commands, with a port number of 49000. The mobile phone can be directly

connected to the WIFI network of the WIFI serial port server, and can query the SSID information list and set the router SSID and password through the commands under UDP protocol. After the setting is completed, the WIFI serial server will automatically restart and connect to the router, and it will work in STA mode at this time.

Protocol format description:

Table query instruction

No.	Name	Number of bytes	Note
1	Header	1	Fixed value 0xFF
2	Length	2	The number of bytes after the length (excluding the length) and before the checksum (excluding the checksum).
3	Command code	1	Command type, 0x01 is a query instruction
4	Checksum byte	1	The cumulative sum of all bytes after the header (excluding the header) and before the checksum (excluding the checksum).

Table Query Reply Instructions

No.	Name	Bytes	Note
1	Header	1	Fixed value 0xFF
2	Length	2	All bytes after the length (excluding the length) and before the checksum byte (excluding the checksum byte)
3	Command code	1	Command type, and the reply instruction corresponding to the query instruction is 0x81
4	AP number	1	The number of APS currently searched
5	SSID1	Indefinite length	The SSID of router 1
6	end character	1	Router 1' s SSID terminator, fixed value 0x00
7	Signal strength 1	1	The signal strength of router 1 network ranges from 0 to 100, and the corresponding actual value is 0% to 100%
8	End character	2	Terminator of signal strength 1, 0x0D, 0x0A
...
M	SSIDn	Indefinite length	The SSID of router n
M+1	End character	1	SSID terminator of router n, fixed value 0x00
M+2	Signal strength n	1	The signal strength of router N network ranges from 0 to 100, and the corresponding actual value is 0% to 100%
M+3	End Character	2	The end character of signal strength n, 0x0D, 0x0A
M+4	Checksum	1	The cumulative sum of all bytes after the header (excluding the

	byte		header) and before the checksum byte (excluding the checksum byte).
--	------	--	---

Example:

Mobile phone sent to WIFI serial server (hexadecimal number): FF0010102.

WIFI serial server returns to mobile phone (hexadecimal number):

FF00148102544553543100400D0A 544553543200370D0A1F

Note: The mobile phone sends a query instruction to the WIFI serial server to query the router related information. The information returned by the WIFI serial server to the mobile phone is: there are two routers, the SSID of router 1 is "TEST1" and the signal strength is 64%; Router 2 has an SSID of "TEST2" and a signal strength of 55%.

Note: The router information replied by the WIFI serial server is sorted according to the signal strength.

Table setting instruction

No.	Name	Bytes	Note
1	Header	1	Fixed value 0xFF
2	Length	2	The number of bytes after the length (excluding the length) and before the checksum (excluding the checksum).
3	Command code	1	Command type, 0x02 is the setting command.
4	Reserved byte	1	The default is 0x00.
5	SSID	Indefinite length	The SSID of the router.
6	Separator	2	SSID terminator, fixed values 0x0D, 0x0A.
7	Password	Indefinite length	The password of the router.
8	Checksum byte	1	The cumulative sum of all bytes after the header (excluding the header) and before the checksum byte (excluding the checksum byte).

Table setting reply instruction

No.	Name	Bytes	Note
1	Header	1	Fixed value 0xFF
2	Length	2	All bytes after the length (excluding the length) and before the checksum byte (excluding the checksum byte).
3	Command code	1	Command type, 0x82 is the reply instruction corresponding to the setting instruction.
4	Checksum value	1	The checksum result of SSID, if the network value corresponding to this SSID can be found, is 0x00, if not, the value is 0x00.
5	Checksum	1	The checksum result of the password, if the password format is correct,

	value		the value is 0x00, if it is incorrect, the value is 0x00.
6	Checksum Byte	1	The cumulative sum of all bytes after the header (excluding the header) and before the checksum byte (excluding the checksum byte).

Example:

The mobile phone is sent to the WIFI serial server (hexadecimal number):
ff00f020054455354310d0a313233343536ce.

WIFI serial server returns to mobile phone (hexadecimal number): FF000382010187.

Note: The mobile phone sends a setting instruction to the WIFI serial server, setting the SSID as "TEST1" and the password as "123456". The information returned by the WIFI serial server to the mobile phone is that there is a network with the SSID of "TEST1" and the password format is correct.

6.8 LOCAL AREA NETWORK SEARCH

RS232/485 TO WIFI ETH (B) supports local network search functionality. This means that when RS232/485 TO WIFI ETH (B) is connected to a wireless router, users can obtain the IP address of the current local network serial port server for RS232/485 TO WIFI ETH (B) by sending a UDP broadcast to a specific fixed port. This enables device discovery and communication within the local network.

You can also directly connect the AP of RS232/485 TO WIFI ETH (B) to send the search instruction, as shown in the following figure:

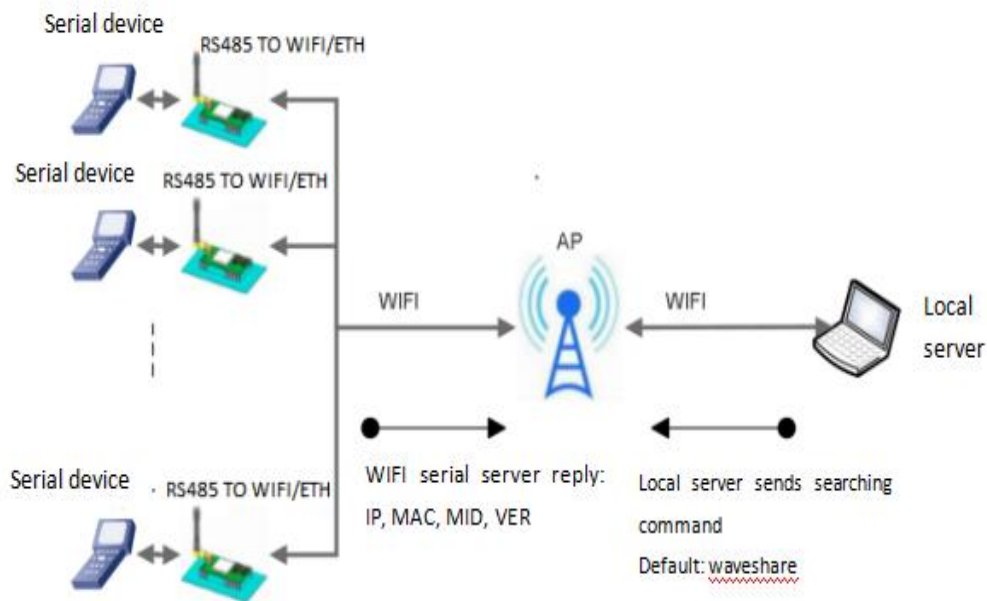

Figure LAN search block diagram

Search protocol process:

1. On another device in the local area network, send the search instruction "www.waveshare.com" through UDP broadcast (broadcast address: xx.xx.255, port: 48899).
2. After RS232/485 TO WIFI ETH (B) receiving the password, if the password is correct, RS232/485 TO WIFI ETH (B) enters the configuration mode and sends IP,MAC,MID and VER to the address (unicast, source port).

Table search reply content

Item	Content
IP address	xxx. xxx. xxx. xxx
MAC address	xxxxxxxxxxxxxxxx
MID	
Version number	

If no setting command is received within 30 seconds after RS232/485 TO WIFI ETH (B) enters configuration mode, RS232/485 TO WIFI ETH (B) will exit configuration mode, and the user needs to resend the search command word to enter configuration mode.

3. Users can set and read parameters/states by sending network AT commands to this port. The AT command format is the same as the serial port AT command.

Note: The search tool and RS232/485 TO WIFI ETH (B) must be on the same LAN. If multiple STAs are connected to a router, the computer running the search tool is also connected to that router. This search tool can find all the STAs.

6.9 REGISTRATION PACKET FUNCTION

This function only applies to RS232/485 TO WIFI ETH (B) as TCPClient.

The function of registered CLOUD is to send a registration package consisting of device ID and communication password when RS232/485 TO WIFI ETH (B) is connected to the server, and the registration package information is correct, and the server returns.

Registration success information, RS232/485 TO WIFI ETH (B) access to transparent cloud platform.

The USR (User-defined Registration Package) function allows users to customize the content of the registration package, and the length is limited to 40 characters (supported in UDPClient mode, and the user-defined registration package is added before each data packet is sent).

There are two ways to register MAC function: one is to send registration information when connecting to the server for the first time; The other is to add registration information in front of the data sent each time.

There is only one way to register CLOUD, that is, when connecting to the server, send a registration package to join Transparent Cloud.



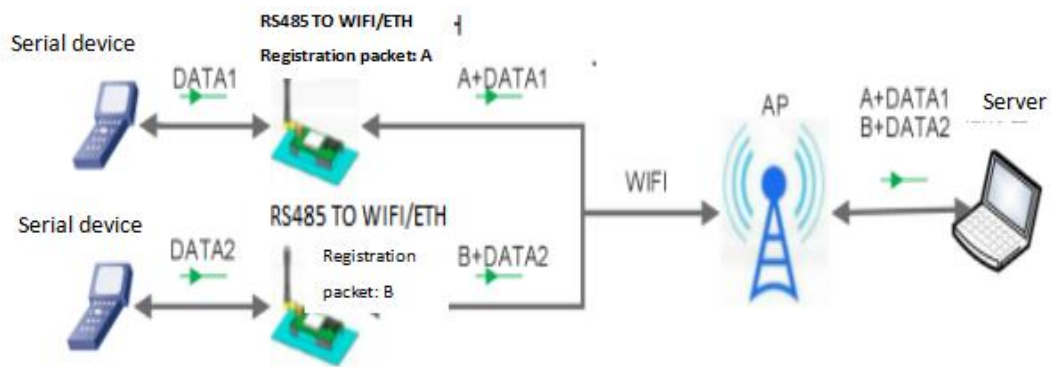

Figure data carrying registration package diagram

Parameters related to this function are set in the "serial port and other settings" section of the webpage, which is disabled by default.

The relevant instruction settings are as follows:

Table Registration Package Command List

No.	Command	Note
1	REGEN	Set registration packet type
2	REGTCP	Registration packet setting
3	REGCLOUD	Set/query transparent cloud account and password
4	REGUSR	Set/query user-defined registration package content

6.10 CUSTOMIZED HEARTBEAT PACKETS

In the network transparent transmission mode, users can choose to turn on the custom heartbeat packet function, and heartbeat packet can choose to send it to the network server or the serial port device. The schematic block diagram is as follows:

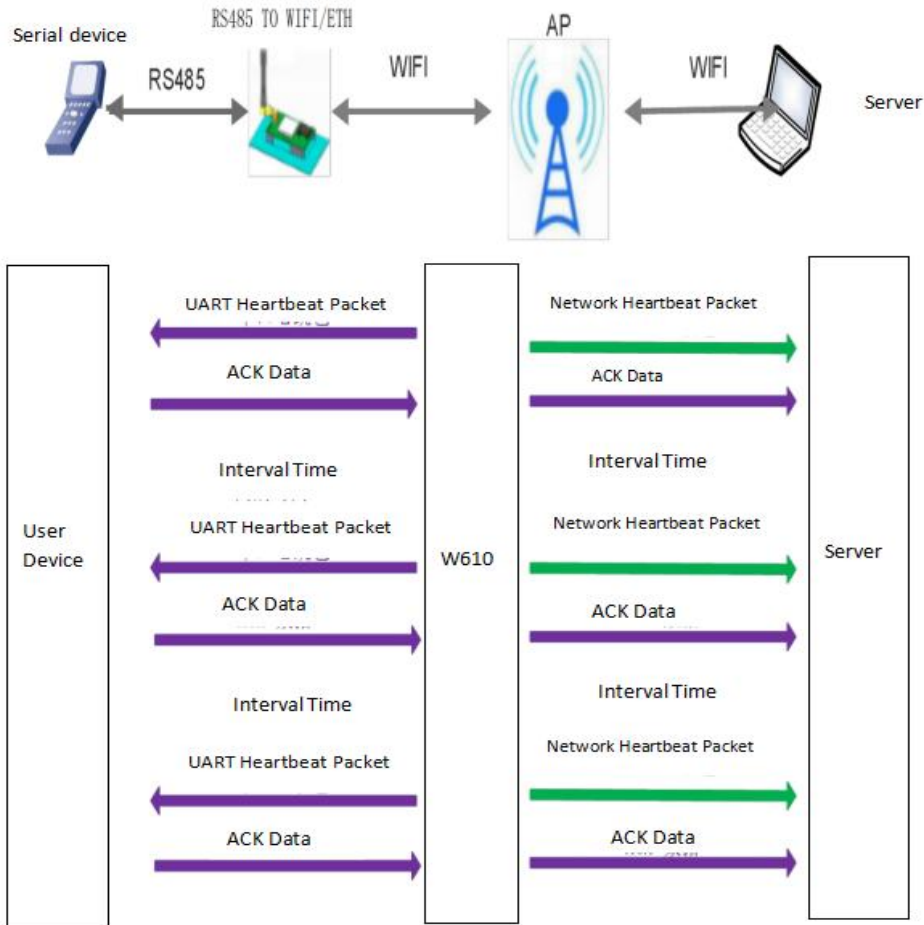

Figure Custom heartbeat packet Functional Block Diagram

The main purpose of sending to the network is to keep the connection with the server, and at the same time, let the server that has been idle for a long time (not sending data to the server for a long time) check whether the current connection status is valid.

In applications where servers send fixed query instructions to devices, in order to reduce frequent interaction, users can choose to send heartbeat packets (query instructions) to the serial device end instead of sending query instructions from the server.

To enable the custom heartbeat packet function, the AT command setting steps are as follows:

(1) Enable the function of sending heartbeat packets

```
AT+HEARTEN=on
```

(2) Set the type of heartbeat packet sending direction (NET or COM), for example, set the heartbeat packet to be sent to the network server.

```
AT+HEARTTP=NET
```

(3) Set the heartbeat packet data (up to 40 bytes), for example, to set the data to the string www.waveshare.com, you need to first convert it to a hexadecimal string as

```
7777772E7761766573686172652E636F6D。
```

```
AT+HEARTDT=7777772E7761766573686172652E636F6D
```

(4) Set the interval time for sending heartbeat packets, with a range of 1-65535s and a default of 30s. For example, set the transmission interval to 30 seconds.

AT+HEARTTM=30

In addition to the above settings, you should also set the network connections such as socketA and socketB, please refer to Section 2.4. After setting, restart the serial server. When the socket or socket is connected to the server, if there is no data transmission in the serial port of the device within 30 seconds, the serial server will send the string www.waveshare.com to the server.

The related instructions are set as follows:

Table heartbeat packet instruction list

No.	Command	Note
1	HEARTEN	Query/set whether to turn on heartbeat packet function.
2	HEARTTP	Query/set heartbeat packet sending method.
3	HEARTDT	Query/Set heartbeat packet Data
4	HEARTTM	Query/Set the sending heartbeat packet interval.

6.11 SOCKET DISTRIBUTION FUNCTION

In transparent transmission mode, the socket distribution function is enabled, and the client's MCU only needs to send data packets according to this protocol format, and the serial server will parse the received data packets. If it meets the protocol format, the serial server will send the parsed data to the specified socket connection; If the data does not conform to the protocol format, the corresponding error code will be returned and will not be sent to the specified socket connection. At the same time, the data sent by the network will be packaged by the serial server according to the protocol format and sent to the serial device.

(1) serial device to module data format

The client MCU sends data packets according to the following format. After the module is parsed, only N bytes of data are sent to the specified Socket connection. When data is returned, the data is directly output from the serial port without parsing.

Table Serial port sending format

Header	Length	Parameter area	Data	Checksum
3	2(n+2)	2	n	1

Header:

Always 0x550xFD0xAA

Length:

The sum of all bytes from the parameter area (including the parameter area) to the checksum (excluding the checksum). High byte first

Parameter area:

The first byte: common parameter area, which is the connection serial number (SocketA or SocketB); If the serial number is 0x61, it represents all the connection objects sent to SocketA, and if it is 0x62, it represents the connection objects sent to SocketB.

Second byte: spare parameter area, which is 0x00 by default.

The common parameter area is in front, and the spare parameter area is in the back.

Data:

The length is variable, and the length of the whole data packet is not more than 4096 bytes.

Checksum:

Starting from the parameter area (including the parameter area), and counting up to the byte before the checksum byte, calculate the sum and take the last byte as the checksum byte.

The following are specific application examples:

55FDAA00036100CC2D (Hex)

Among them,

Length byte 0003: length is 3.

Parameter byte: 6100: Send data to socketA connection.

Data area CC: The data sent is "0xCC".

Checksum calculation: 61+00+CC=2D.

(2) Data format from module to serial port device

When data (n bytes) is sent from the network, the module sends the data packet to the serial device according to the following format; In addition, when the serial device sends data to the module, if there is an error in sending, it will also reply to the serial device according to this format.

Table Serial Port Sending Format

Header	Length	Parameter area	Data	Parity bit
3	2(n+2)	2	n	1

Header

Always 0xAA0xFD0x55

Length:

The sum of all bytes from the parameter area (including the parameter area) to the sum check (excluding the sum check). High byte first

Parameter area:

The first byte: common parameter area, which is the connection serial number (socket or socket b); The data returned for SocketA is 0x61, and the data returned for SocketB is 0x62.

The second byte: spare parameter area, and the seventh bit indicates whether the reply frame is data returned by the network or the module. (1: module returns data; 0: network returns data). Data:

If it is network data, copy the data directly to the location; The length is variable, and the length of the whole data packet is not more than 4096 bytes.

If it is the data replied by the module, the corresponding operation reply code is returned. The specific operation reply code is as follows:

Table Operation reply code

No.	Return code	Description	Note
1	0x00	Header error	
2	0x01	Data length error	
3	0x02	Parameter error	
4	0x04	Checksum error	
5	0x10	Sending failed (parameters correct but sending failed)	

Checksum:

Starting from the parameter area (including the parameter area) and before the checksum byte, add and take the last byte as the checksum byte.

The following is a specific application example: AAFD5500036100CC2D (Hex)

- Among them, length byte 0004: is length 4
- Reference number 6100:61- SocketA data
- 00- Network sends to serial devices
- Data area CC: Data sent from network socket A
- Checksum calculation: 61+00+CC=2D

Taking Socket as an example, the serial port device sends abc to Socket, and the network-side Socket sends data 123 to the serial port device, as shown below:

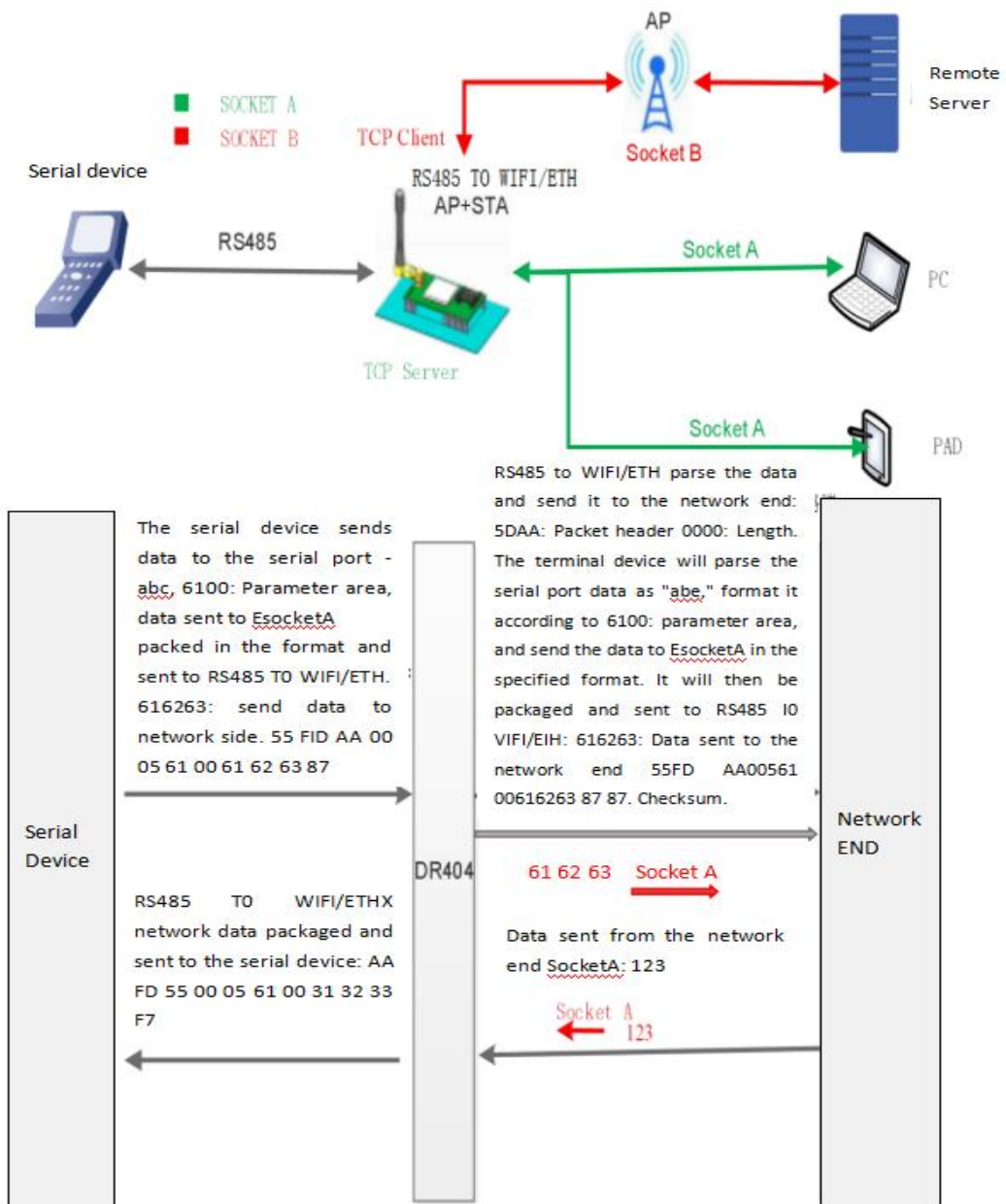

Figure Socket Distribution Protocol

6.12 TIMEOUT REBOOT FUNCTION

The "timeout reboot" here means no data restart. In transparent transmission mode, when the timeout restart feature is enabled, if the module's WiFi is not connected or if WiFi is connected but there is no communication within the set time frame, the module will be restarted. To enable the timeout restart feature, follow these AT command setup steps:

- (1) Enable timeout reboot function

```
AT+TIMEOUTEN=on
```

- (2) Set the timeout reboot time, which can be set in the range of 60-65535s, and the default is 3600s. Take 100s as an example;

```
AT+TIMEOUTT=100
```

Parameter settings are complete, and they will take effect after the module is restarted.

For example: After setting AT+TIMEOUTT=100, if the module remains without a WiFi connection within 100 seconds or if there's a WiFi connection but no communication, the module will reboot. If communication occurs or there is a connection within the 100 seconds, the timer will reset.

Table Timeout Reboot Command List

No.	Command	Note
1	TIMEOUTEN	Enable/disable timeout reboot function
2	TIMEOUTT	Query/set timeout reboot time

6.13 TIMED REBOOT FUNCTION

"Timed reboot is equivalent to "reboot after set time", in non-serial command mode, when this function is enabled, the module will use the internal clock to time, and the module will reboot forcibly after the set time.

Turn on the timed reboot function. The AT command setting steps are as follows:

- (1) Turn on the timed reboot function

```
AT+REBOOTEN=on
```

- (2) Set the timed reboot time, which can be set from 1 to 720 h, and the default is 24 h;

- (3) For example: set 200h and restart the module once, with the following command.

The AT+REBOOTT=200 parameter setting is finished and takes effect after the module restarts.

After taking effect, the module restarts every 200 hours.

Table Scheduled Reboot Command List

No.	Command	Note
1	REBOOTEN	Enable/Disable the scheduled reboot function
2	REBOOTT	Query/Set the scheduled reboot time

6.14 MOD BUS POLLING

(1) The webpage configuration is shown below:

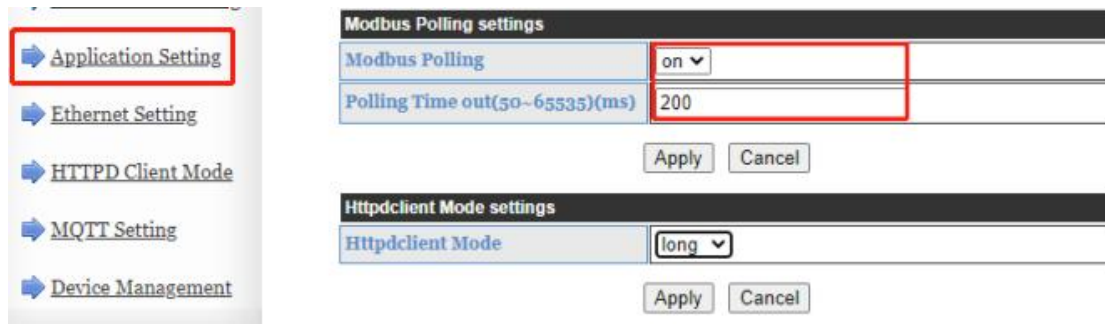

Figure Modbus Polling Web Page Configuration Screenshot

(2) AT commands setting:

Enable or disable the Modbus polling feature, and enable the Modbus polling function.

AT+MODBPOLLEN=on/off

Set the polling interval for querying (50~65535) milliseconds, using 200ms as an example.

AT+MODBPOLLT=200

6.15 KEEPALIVE FUNCTION

With the addition of a Keepalive mechanism during TCP connections, RS232/485 TO WIFI ETH (B) can promptly detect network anomalies and disconnect when there's a network issue. Once the network is restored, it can swiftly reconnect to the server.

6.16 WEBSOCKET FUNCTION

This WIFI serial server can realize the function of websocketserver. It can make the serial port of WIFI serial server interact with the web page in real time, instead of the earlier HTTPGET, POST and PUT modes, and the response speed is faster. This WIFI serial server provides a corresponding websocket test page for users to test, and the specific page is as follows: (The address of this page is 10.10.100.254/websocket.html).

6.17 MQTT FUNCTION

6.17.1 MQTT FUNCTION INTRODUCTION

MQTT is a protocol for message publishing//subscribe transmission based on the client servers.

The MQTT protocol is lightweight, simple, open, and easy to implement, which makes it highly versatile and applicable in a wide range of scenarios.

The MQTT function settings of RS232/485 TO WIFI ETH (B) are highly flexible, allowing you to configure almost all MQTT protocol-related connection parameters, publish topic parameters, and subscribe topic parameters.

RS232/485 TO WIFI ETH (B) MQTT's publish topic modes include Pure Transparent Publish Mode (serial port can transparently publish data to all topics), Special Identifier Publish Mode (serial port can transparently publish data to specific topics using identifiers), and Custom Topic Publish Mode (serial port can transparently publish data to specified topics).

RS232/485 TO WIFI ETH (B) MQTT's subscribe topic modes include Pure Transparent Subscribe Mode (subscribed topic data transparently transmitted to the serial port) and Topic-Carrying Subscribe Mode (subscribed topic data carrying the topic is transparently transmitted to the serial port).

6.17.2 RS232/485 TO WIFI ETH (B) PARAMETER CONFIGURATION

The AT command settings are as follows in the table below:

Table MQTT-related commands

Command	Note
MQTTEN	Turn MQTT function on/off
MQTTVER	Query/set MQTT version number
MQTTSVR	Query/set MQTT server information
MQTTID	Query/set MQTT client ID
MQTTUSR	Query/set MQTT authentication user name
MQTTPWD	Query/set MQTT authentication password
MQTTHEART	Query/set MQTT heartbeat interval
MQTTWILLEN	Query/set MQTT last will status
MQTTWILL	Query/Set the MQTT last will message.
MQTTLINK	Query the MQTT connection status.
MQTTPUBMOD	Query/Set the MQTT topic publishing mode.
MQTTPUBLS	Query the list of preconfigured MQTT publish topics.
MQTTPUBADD	Add a new topic to the preconfigured publish topics.
MQTTPUBDEL	Delete the topic with that name from the preconfigured publish topics.
MQTTPUBCLR	Clear the preconfigured publish topics.
MQTTSUBMOD	Query/Set MQTT Topic Subscription Mode
MQTTSUBLS	Query MQTT preconfigured subscription topic list
MQTTSUBADD	Add a new topic to a preconfigured subscription topic
MQTTSUBDEL	Delete a topic with that name from the preconfigured subscription topics.
MQTTSUBCLR	Clean preconfigured subscription topics

Web page settings

On the "MQTT Function Settings" page, configure the MQTT function parameters as follows:

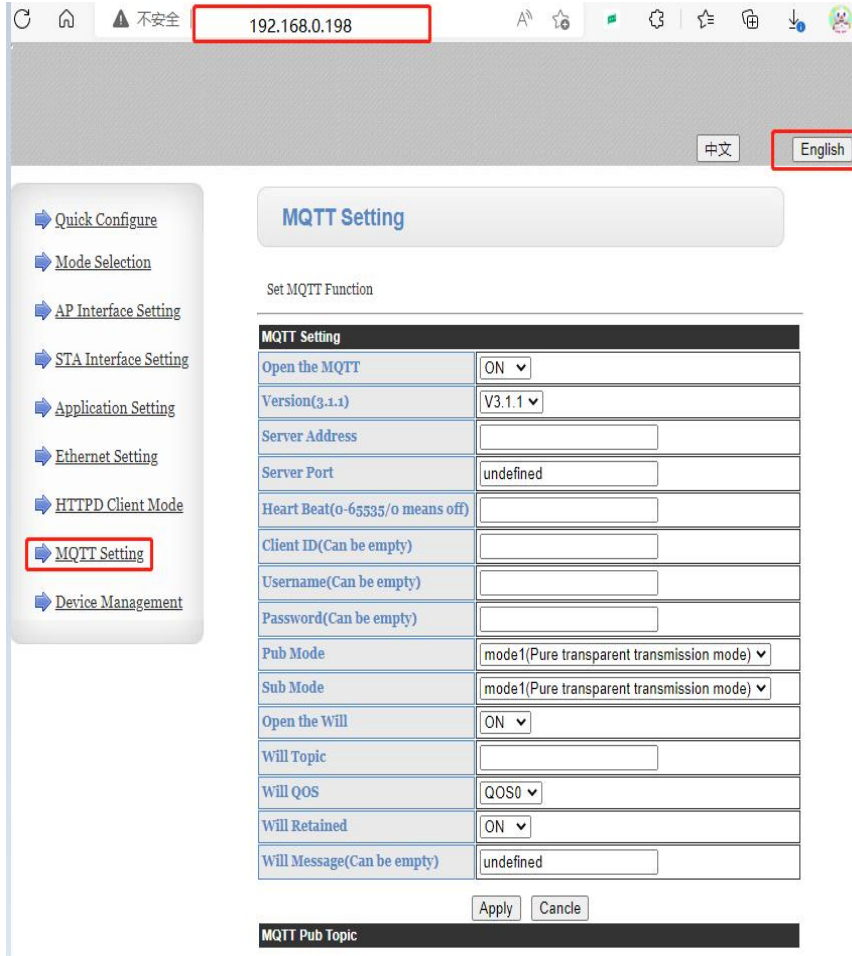

MQTT Setting

Set MQTT Function

MQTT Setting	
Open the MQTT	ON
Version(3.1.1)	V3.1.1
Server Address	
Server Port	undefined
Heart Beat(0-65535/0 means off)	
Client ID(Can be empty)	
Username(Can be empty)	
Password(Can be empty)	
Pub Mode	mode1(Pure transparent transmission mode)
Sub Mode	mode1(Pure transparent transmission mode)
Open the Will	ON
Will Topic	
Will QOS	QOS0
Will Retained	ON
Will Message(Can be empty)	undefined

Apply Cance

MQTT Pub Topic

Figure MQTT function settings page