

User's Guide

HDM3000 Digital Multimeter

Version: 1.07

Contents

Guaranty and Declaration	1
Safety Requirement.....	1
General Safety Summary	1
Safety Terms and Symbols	5
Maintenance and Cleaning.....	6
Environmental Matters Need Attention	6
Chapter 1 Quick Start.....	7
General inspection	8
Adjust the handle.....	9
The front panel	10
The rear panel	17
Models and Options	19
First use of the multimeter.....	20
Measuring connection	21
Chapter 2 Features and Functions.....	23
Measurement.....	24
Triggers and Reading.....	42
Probe Hold.....	45
Mathematics - Introduction	46
Display - Introduction.....	52
Utility Menu - Introduction.....	60
Chapter 3 Measurement Guidance.....	67
Precautions for DC measurement	68
Noise Rejection	69
Precautions for resistance measurement	70
True RMS AC measurement.....	72
Capacitance.....	74

Chapter 4 Calibration and adjustment steps	76
The calibration process	77
The calibration procedure.....	80
Chapter 5 Remote Control	87
Chapter 6 Appendix	95
Appendix A: HDM3000 Digital Multimeter Annex	95
Appendix B: Warranty Summary.....	96

Guaranty and Declaration

Copyright

Qingdao Hantek Electronic Co., Ltd reserves all rights.

Notices

- Hantek products are protected by patent law in and outside of P.R.C.
- Our Company reserves the rights to change the specifications and prices.
- The information in this publication supersede all information provided by any materials previously published.
- Qingdao Hantek Electronic Co., Ltd shall not be liable for all possible errors in this manual, or for any information provided in this manual, or for any incidental or consequential loss arising from the use of this manual.
- No part of this manual is allowed to be copied or adapted without the prior written permission of Qingdao Hantek Electronic Co., Ltd.

Product Certification

Qingdao Hantek Electronic Co., Ltd guarantees that the product conforms to the Chinese National Product Standards and the Industrial Product Standards in China as well as the ISO9001:2015 Standards and ISO14001:2004 Standards. Other international standard conformance certification is in progress.

Contact Us

If you encounter any problems or requirements in the process of using the product or the manual, please contact us by e-mail:

support@hantek.com

Safety Requirement

General Safety Summary

Be aware of the following safety precautions to avoid injury and prevent damage to the product or any product connected to this product. To avoid possible hazards, be sure to use this product in accordance with the regulations.

Use the correct power cord.

You are only allowed to use the specified power cord approved by the country you are currently in.

Ground the product.

This product is grounded through the protective grounding wire of the power cable. To avoid electric shock, please ensure that the grounding terminal of the

power cable is connected to the protective grounding terminal reliably before connecting to any input or output terminals of the product.

View all terminal ratings.

To avoid fire and excessive current shock, please check all the ratings and markings on the product and consult the product manual for details of the ratings before connecting the product.

Use appropriate overvoltage protection.

Ensure that no overvoltage (such as voltage caused by lightning) reaches to this product. Or else the operator may expose to danger of electric shock.

Do not open the lid while operating.

Do not operate the product with the machine case open.

Use appropriate fuse.

Only specified fuses are allowed.

Avoid exposed circuits.

After powering on, do not touch exposed splices and components.

Do not operate if the product is suspected to be out of order.

If you suspect there is something wrong with the product, please contact maintenance personnel authorized by Hantek for testing. Any maintenance, adjustment or replacement of components must be performed by repairmen authorized by Hantek.

Maintain good ventilation.

Poor ventilation may cause the temperature of the instrument rising and then lead to damage to it. Good ventilation should be maintained when using, and the vents and fans should be checked regularly.

Do not use in a humid environment.

To avoid short circuit and electric shock, do not operate the instrument in damp environment. This instrument is designed to operate at a temperature of 0°C to 50°C, with a maximum relative temperature of 80% at 40°C, with full accuracy in a non-condensing environment. The upper limit of the operating altitude of this instrument is 2000, and the storage temperature of this instrument is -40.°C to 70 °C.

Do not operate in a flammable and explosive environment.

In order to avoid damage to the instrument or personal injury, do not operate the instrument in a flammable and explosive environment.

Please keep the surface of the product clean and dry.

To avoid dust and moisture in the air affecting the performance of the instrument, please keep the surface of the product clean and dry.

Anti-static protection.

Static electricity may cause damage to the instrument. It would be better to test the instrument in anti-static area. Before connecting the cable to the instrument, the inner and outer conductors should be grounded briefly to release the static electricity.

Pay attention to carrying safety.

To avoid the instrument sliding in the process of carrying, causing damage to the keys on the panel, the knobs or interfaces, please pay attention to carrying safety. This instrument is about 3.78 kg (without packaging), is about 265cm in length, 110cm in height, and 310cm in width. The size is an approximate measurement value and there will be some deviation.

Interference tests for all models comply with Class A standards, based on EN 61326:1997 +A1+A2+A3

Input terminal protection limits.

The protection limits are defined for the input terminals:

1. Main input (HI and LO) terminals.

The HI and LO input terminals are used for voltage, resistance, capacitance, connectivity, frequency, and diode test measurements. These two terminals define the following two protection limits:

- 1) HI to LO protection limit. The HI to LO protection limit is 1000 VDC or 750 VAC, which is also the maximum measurable voltage. This limit can also be expressed as a maximum of 1000 VPK.
- 2) Lo to the ground protection limit. LO input terminals can safely "float" to a maximum of 500 Vpk relative to the ground.

The HI terminal protection limit is up to 1000 VPK relative to the ground. Therefore, the sum of the "floating" voltage and the measured voltage must not exceed 1000 VPK.

2. Sampling terminal.

- 1) The HI and LO Sense terminals are used for DCV proportional measurements, four-wire resistance and temperature measurements. The measurement limit for all terminal pairs is 200 Vpk: LO Sense to LO input, HI Sense to LO input, HI Sense to LO Sense.

3. Current input terminal.

The measurement limit is 10.5A (DC or AC) when using the 10A-current-input terminal and the LO terminal. The measurement limit is 3.1A (DC or AC) when using 3A-current-input terminal and the LO terminal.

Note:

To avoid blowing the fuse or damaging the multimeter, please follow the instructions below to use the current input terminals.

- 1) When performing current test measurements, be sure to select an appropriate current input terminal according to the expected current size before switching on the multimeter power.
- 2) The maximum current input to 10A terminal shall not exceed 10.5A, otherwise, the internal fuse will be blown; The maximum current input to 3A terminal shall not exceed 3.1A, otherwise, the rear panel current input fuse will be blown.

IEC measurement class II overvoltage protection.

To avoid electric shock, the HDM3000 digital multimeter provides overvoltage protection for line-voltage mains connections meeting both of the following conditions:

1. The HI and LO input terminals are connected to the mains under Measurement Category II conditions, defined below.
2. The maximum line voltage of the power mains is 300 VAC.

Warning: IEC II includes electrical devices connected to a mains at an outlet on a branch circuit. These devices include most small appliances, test equipment, and other devices plugged into branch sockets.

The HDM3000 can be used to make measurements where the HI and LO input terminals are connected to power mains (up to 300 VAC) in these devices, or to branch sockets themselves. However, the HI and LO input terminals of the HDM3000 cannot be connected to power mains in permanently installed electrical devices, such as main circuit breaker switchboards, sub-panel disconnected box nor wired motors. These devices and circuits are prone to be in excess of the HDM3000 protection limit.

Note: Voltages over 300 VAC can only be measured in circuits that are disconnected from the main power line. However, there are also transient overvoltages in circuits that are disconnected from the mains. The HDM3000 can safely withstand occasional transient overvoltage up to 1500 Vpk. Do not use the device to measure circuits whose transient overvoltage may exceed this value.

Safety Terms and Symbols

Terms used in this manual. The following terms may appear in this manual:



Warning

A warning statement indicates conditions and actions that may endanger the operator.



Attention

The attention statement indicates conditions and actions that may cause damage to or loss of data.



CAT I (1000V)

IEC measurement Category I. The maximum measurable voltage of the Hi-Lo terminal is 1000 Vpk.



CAT II (300V)

IEC measurement Category II. In case of Category II overvoltage, the input may be connected to the power mains (up to 300 VAC).

Terms on the product. The following terms may appear on the product:

Danger

It indicates that this action may cause immediate harm to you.

Warning

It indicates that this action may cause potential harm to you.

Attention

It indicates that this action may cause damage to the product or other equipment connected to this product.

Symbols on the product. The following symbols may appear on the product:



High voltage



Safety warning



Protective earthing terminal



Shell ground terminal



Measuring ground terminal

Maintenance and Cleaning

Maintenance

Do not place the instrument in a place exposed to sunlight for a long time.

Cleaning

Please clean the instrument frequently according to the condition of the instrument. To clean the exterior surface, perform the following steps:

1. Turn off the power.
2. Wipe the dust outside the instrument with a soft cloth that is damp but not dripping (can use a mild detergent or water). When cleaning the instrument with LCD screen, please be careful not to scratch the LCD protection screen.



Attention

Do not let any corrosive liquid touch the instrument, so as not to damage the instrument.



Warning

Before re-energizing, make sure the instrument is dry enough to avoid electrical short circuit or even personal injury.

Environmental Matters Need Attention

The following sign indicates that the product complies with the European Union requirements set out in Directive 2002/96/EC on Waste Electrical and Electronic Equipment (WEEE).



Recycling equipment

Some of the substances contained in this product may be harmful to the environment or human health. In order to avoid the harm these substances may cause to the environment or human, it is recommended that appropriate methods be used to recycle this product to ensure that most of the materials can be reused or recycled appropriately. For information on disposal or recycling, contact your local authority.

Chapter 1 Quick Start

Format conventions in the document:

Keys:

For functional keys on the front panel of the instrument, a key icon is used in this book.

For example: The DC voltage measurement function key is represented by .

This chapter guides the user to quickly know the basic information of the multimeter such as the front and rear panels, the user interface and measuring connections.

Chapter 1 outline:

- General inspection
- Adjust the handle
- The front panel
- The rear panel
- Models and options
- First use of the multimeter
- Measuring connections

General inspection

Check the transport package.

If the transport package is damaged, please retain the damaged packaging or shock proof material until the good have been fully inspected and the equipment has passed the electrical and mechanical tests.

If the instrument is damaged due to transportation, the consigner or carrier shall be liable for the damage to the instrument. Qingdao Hantek Electronic Co., LTD. will not carry out free repair or replacement.

Check the whole instrument.

If there is any mechanical damage, any parts missing, or the instrument does not pass the electrical and mechanical tests, please contact Qingdao Hantek Electronics Co., Ltd.

Check the attachments.

Please check the attachments according to the packing list. If there is any damage or anything missing, please contact Qingdao Hantek Electronics Co., Ltd.

Adjust the handle.

To adjust the handle of the digital multimeter, hold the handles on both sides and pull them outward. Then rotate the handle to the desired position. The operation is shown in the following picture.

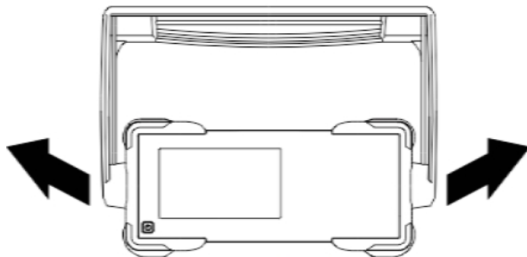

Fig. 1-1 Adjusting the handle

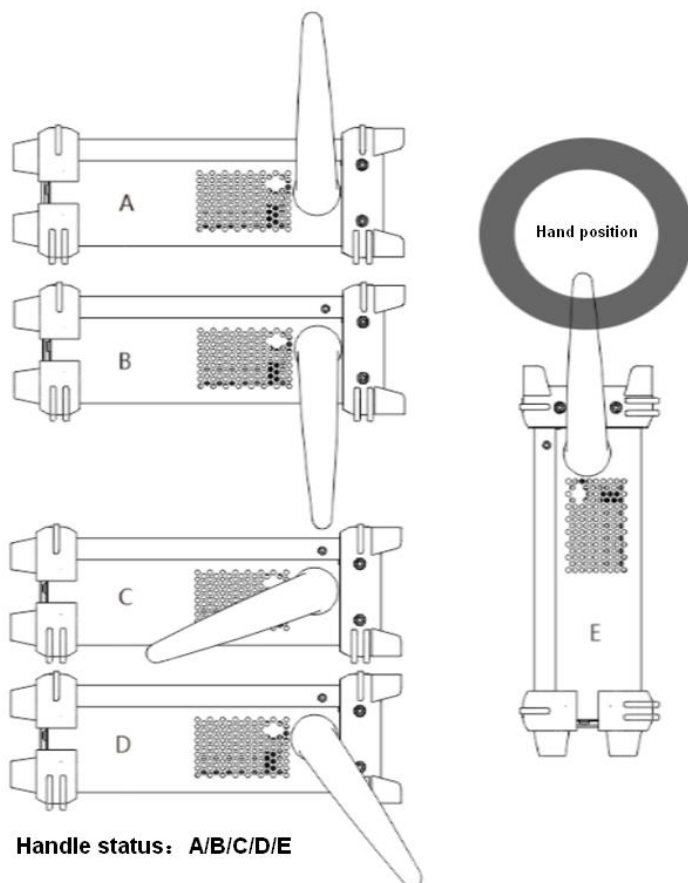

Fig. 1-2 Placing the instrument

The front panel



HDM3000 front panel sketch map

Attachments	Descriptions
1	USB port
2	Help key
3	Preset/Default key
4	Display
5	Measuring configuration and operation key
6	Connecting terminal
7	Front/Rear switch
8	Soft key
9	Power key

Note: Text is provided on some front panel keys. This indicates that the key has a function that you can access by pressing and releasing [Shift] before pressing the key. For example, if you press and release [Shift] before pressing [Display], you will access

the [Utility] function:

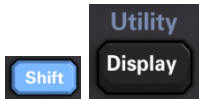







The front panel menu references







The following table summarizes the front panel keys and menu structure.



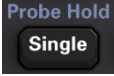

Keys	Application
	Configure DC voltage measurement, including DCV ratio measurement: Range: Automatically adjust range (default), 100 mV, 1 V, 10 V, 100 V or 1000V Aperture PLC: 0.02, 0.2, 1, 10, 100. Default value: 10 Auto Zero: Off or On (default) Input Z: 10 M Ω (default) or Auto Ω (> 1 G) DCV ratio: Off (default) or On
	Configure DC current measurement: Terminals: 3 A or 10 A Range: Auto, 100 μ A, 1 mA, 10 mA, 100 mA, 1 A, 3 A or 10 A (Terminals set to 10 A). Aperture PLC: 0.02, 0.2, 1, 10, 100. Default value: 10 Auto Zero: Off or On (default)
	Configure AC voltage measurement: Range: Automatically adjust range (default), 100 mV, 1 V, 10 V, 100 V or 750 V AC Filter: >3 Hz, >20 Hz, >200 Hz
	Configure AC current measurement: Terminals: 3 A or 10 A Range: Auto, 100 μ A, 1 mA, 10 mA, 100 mA, 1 A, 3 A or 10 A (terminal set to 10 A) AC Filter: >3 Hz, >20 Hz, >200 Hz

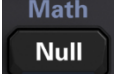
	<p>Configure 2-wire resistance measurement:</p> <p>Range: 100 Ω, 1 kΩ, 10 kΩ, 100 kΩ, 1 MΩ, 10 MΩ or 100 MΩ</p> <p>Note: The approximate current sourced for each range (for example, ~1mA) is shown on each range softkey.</p> <p>Aperture PLC: 0.02, 0.2, 1, 10, 100. Default value: 10</p> <p>Auto Zero: Off or On (default)</p>
---	---

Keys	Application
	<p>Configure 4 wire resistance measurement.</p> <p>Range: 100 Ω, 1 kΩ, 10 kΩ, 100 kΩ, 1 MΩ, 10 MΩ or 100 MΩ.</p> <p>Note: The approximate current sourced for each range (for example, ~1mA) is shown on each range softkey.</p> <p>Aperture PLC: 0.02, 0.2, 1, 10, 100. Default value: 10</p>
	<p>Configure frequency and period measurements. Parameters include range, AC filter, and gate time.</p> <p>Range: 100 mV, 1 V, 10 V, 100 V, 750 V, Auto (default)</p> <p>AC Filter: >3 Hz, >20 Hz, >200 Hz</p> <p>Gating time: 10 ms, 100 ms(default) or 1 s</p> <p>Timeout: 1 s(default) or Auto</p>
	<p>Configure capacitance measurement:</p> <p>Range: 1 nF, 10 nF, 100 nF, 1μF, 10μF, 100μF or Auto (default)</p>
	<p>Configure continuity measurement:</p> <p>Beeper: Close or On (default)</p>
	<p>Configure diode measurement:</p> <p>Beeper: Close or On (default)</p>

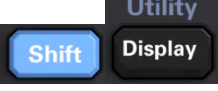
	<p>Configure 2-wire and 4-wire temperature measurements.</p> <p>Probe types: RTD2W, RTD4W (default), Thermis2W, Thermis4W</p> <p>Settings of RTD 2W or RTD 4W:</p> <p>R0: R0 is an RTD nominal resistor at 0 °C. The default value is 100 Ω</p> <p>Aperture PLC: 0.02, 0.2, 1, 10, 100. Default value: 10</p> <p>Units: °C, °F, or K</p> <p>Settings of Thermis2W and Thermis4W:</p> <p>Aperture PLC: 0.02, 0.2, 1, 10, 100. Default value: 10</p> <p>Auto Zero: Off or On (Default) (2-wire measurement only; Not suitable for 4-wire measurement)</p> <p>Units: °C, °F, or K</p>
---	--

Keys	Application
	Run and stop the measurement.
	Save function.
	Take a single measurement.
	Take one or more hand-free measurement.
	Take a null measurement.
	Configure null functions, statistics, and limits.

	Configure the text and graphics that appear on the display and secondary measurements.
	Store and invoke instrument state and preferences. Configure the I/O interface Perform system administration tasks, including calibration. Configure user preferences. Perform file management activities
	Learn about the instrument, see the most recent error message, or clear the error message.
	Select manual or Auto range. Press  to manually increase the range, press  to manually reduce the range.

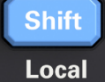
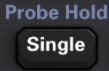
Keys	Application
	Return to instrument local control (when in Remote mode), or indicate that the next front panel key will be "shifted", for example,  instead of [Single].

[Acquire] Key



Soft keys	Description
Trigger setting	Configure the trigger.
VMC output	Set the voltmeter to complete the output slope.
Save readings	Save the reading to a file.

[Math] Key

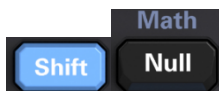

The availability of Math soft keys varies by measurement function.

Soft keys	Description
Null	Enable/disable use of null values and specify null value to use.
dB / dBm	Configure dB, dBm.
Statistical information	Enable, disable, and clear statistics.
Limiting value	Enables or disables upper and lower limits.

[Display] Key



Soft keys	Description
Display	Choose what to display: number, bar meter, histogram, or trend chart.
Label	Enables or disables display messages.
Label Text	Edit the text displayed when the soft key LABEL is on.
2nd Meas	Choose auxiliary measurement
Digit Mask	Set the number of digits displayed in the measurement.

[Utility] Key



Soft keys	Description
Store/Recall	Store and recall status and preference files, set boot default values.
Manage Files	Perform basic file management tasks and screen capture.
I/O Config	Configure LAN.
Test/Admin	Perform self – test, calibration, firmware update tasks
System Setup	Set user preferences, date, and time.

The rear panel

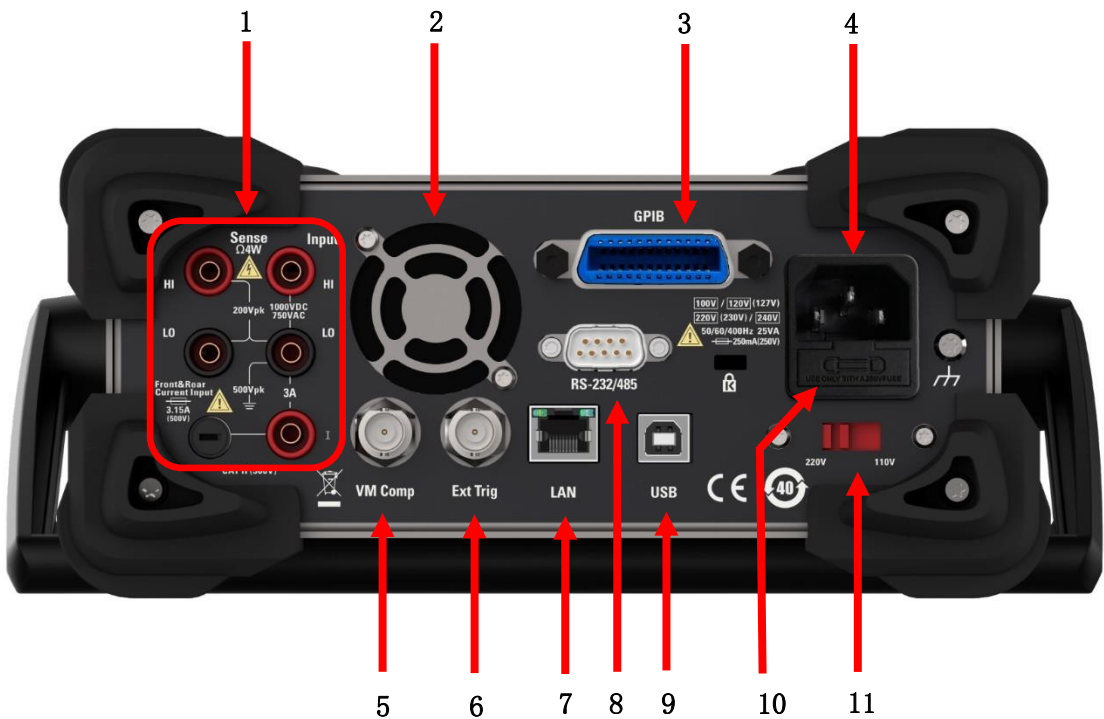

1. Connect the terminals and the current input fuse.

The multimeter uses two types of fuses to provide input protection for small and large current ranges. The internal fuse provides the maximum protection limit of 10.5A for the input of large current range. The fuse will be blown when the input current exceeds 10.5A. The rear panel current input fuse provides the maximum protection limit of 3.1A for small current range input, and the fuse will be blown when the input current exceeds 3.1A. The multimeter is equipped with a high current input fuse when leaving the factory. If you need to replace the small current fuse, please do it in the following way:

- 1) Turn off the power of the multimeter and unplug the power cord.
- 2) Use the straight screwdriver to push in slightly and rotate along the direction shown in the picture to pull out the fuse holder.
- 3) Replace specified fuses.
- 4) Put the fuse holder into the card slot.

Note: the large current input fuse is located inside the instrument and is not allowed to be replaced by the user. If needing replacement, please contact Qingdao Hantek Electronic Co., Ltd.

2. The fan

3. The GPIB interface (non-standard)

This interface can be configured using the Keysight IO Libraries Connection Expert utility.

4. Power jack

This multimeter can input two specifications of AC power supply. Connect alternating current to the multimeter through the socket using the power cord provided in the attachment.

Note: Please select the correct voltage range (using voltage selector) before connecting AC.

5. VM Comp

You can use the VMC OUT soft key to set the edge slope of the VM Comp (voltmeter complete) output on the rear panel of the instrument. This connector emits a signal whenever completing a measurement, allowing you to send signals to other devices in the measurement system.

6. External trigger input

You can trigger a multimeter by adding a trigger pulse to the [Ext Trig] connector. At this point, you need to select an external trigger source.

7. LAN interface

Through this interface, the multimeter is connected to the network for remote control.

8. The RS232 interface

Through this interface, the computer is connected to the multimeter. You can control the multimeter remotely using the SCPI command or PC software.

9. USB Device interface

Through this interface, the computer is connected to the multimeter. You can control the multimeter remotely using the SCPI command or PC software.

10. The power fuse

The multimeter leaves the factory with a power fuse installed. If needing to replace the fuse, please do it in the following way:

- 1) Turn off the power of the multimeter and unplug the power cord.
- 2) Use the screwdriver to press the tongue, and then pull out the fuse seat.

- 3) Select the correct voltage range at the voltage selector.
- 4) Replace the specified specification of the fuse.
- 5) Put the fuse holder into the card slot.



Attention

To avoid electric shock or fire, use the specified fuse and ensure that the fuse bracket is not short-circuited.

11. Voltage selector

Select the correct voltage range according to the AC specification you are using. Two AC input voltage ranges are available: 110 V and 220 V.

Models and Options

Model	Reading resolution	Maximum reading rate	Dc voltage accuracy	11 kinds of measurements	Standard interface
HDM3055	5½	30Krdgs/s	150ppm	AC/DC voltage/ AC/DC current/ 2&4wire resistance/ frequency/ period/ diode/ conductance/ thermocouple/ temperature	USB,232,485(front single panel input)
HDM3055S	5½	30Krdgs/s	150ppm		USB,232,485(rear single panel input)
HDM3055A	5½	30Krdgs/s	150ppm		USB,232,485
HDM3055B	5½	30Krdgs/s	150ppm		USB,232,485,LAN
HDM3055H	5½	30Krdgs/s	150ppm		USB,232,485,LAN,GPIB
HDM3065	6½	30Krdgs/s	35ppm		USB,232,485(front single panel input)
HDM3065S	6½	30Krdgs/s	35ppm		USB,232,485(rear single panel input)
HDM3065A	6½	30Krdgs/s	35ppm		USB,232,485
HDM3065B	6½	30Krdgs/s	35ppm		USB,232,485,LAN
HDM3065H	6½	30Krdgs/s	35ppm		USB,232,485,LAN,GPIB

First use of the multimeter

When using the multimeter for the first time, refer to the steps below to start the multimeter.

1. Connect the AC power supply.
 - 1) Adjust the power supply voltage selector on the rear panel according to your power supply voltage.
 - 2) Connect the multimeter to the AC power supply using the power cord.
2. Start the multimeter.

Press the power button on the front panel to start the instrument.
3. Start-up process
Normal startup: Display the user interface.
4. If the instrument does not start normally, please follow the following steps to check.
 1. Check whether the power cord is in good connection.
 2. If the instrument is still not started after checking without error, please check whether the power fuse has been blown. If necessary, please replace the fuse.
 3. If the instrument is still not started after the above check, please contact Qingdao Hantek Electronic Co., Ltd.

Measuring connection

This multimeter provides a variety of measuring functions. After selecting the required measuring function, connect the measured signal (device) to the multimeter as shown in the following figure. In the process of measurement, do not switch the measuring function at will, otherwise it may damage the multimeter. For example, do not use the measuring lead to measure AC voltage when it is connected to the current terminals.

DCV measurement

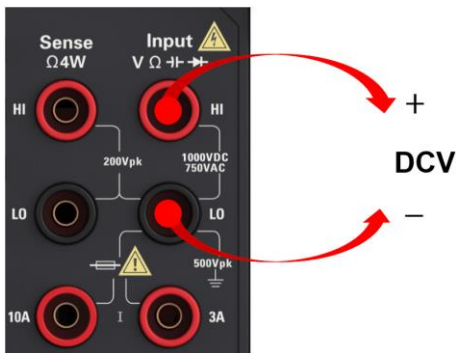

ACV measurement

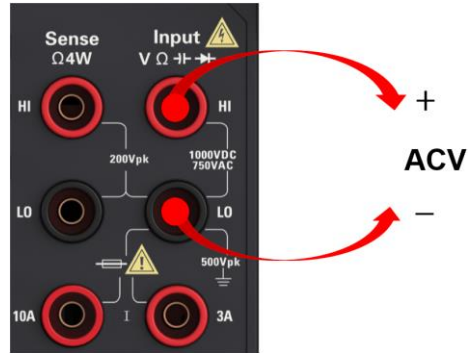

DCI/ACI measurement (Small current)

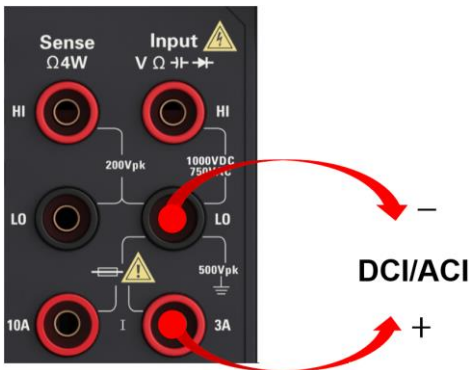

DCI/ACI measurement(Large current)

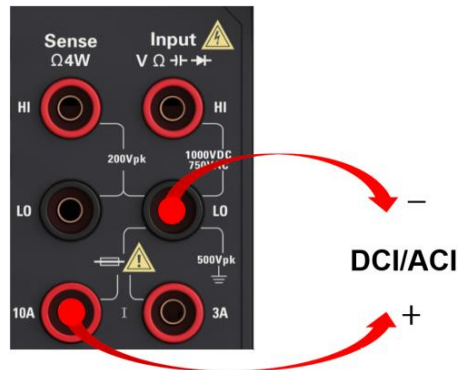

Note: To avoid damaging the multimeter, be sure to follow the instructions below for DC/AC current measurements.

1. When measuring the current, make sure to select the correct current input terminal according to the expected current size before switching on the multimeter power.

Resistance Measurement (2-wire)

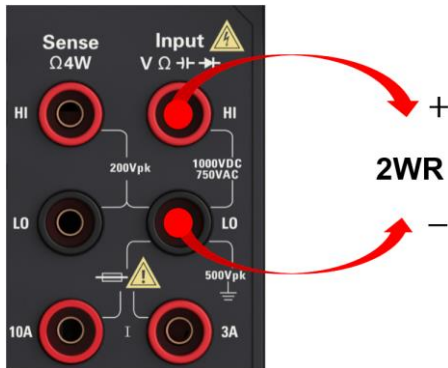

Resistance Measurement (4-wire)

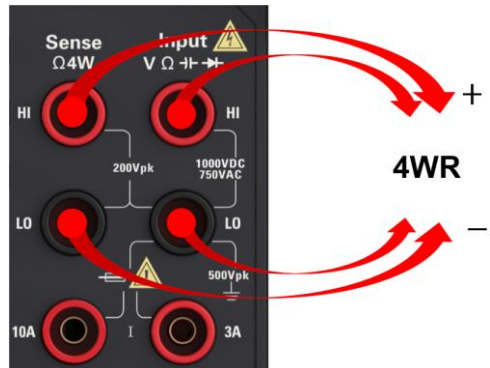

Capacitance Measurement

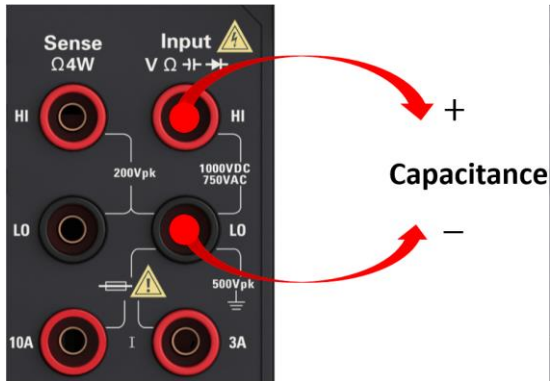

Frequency/Period Measurement

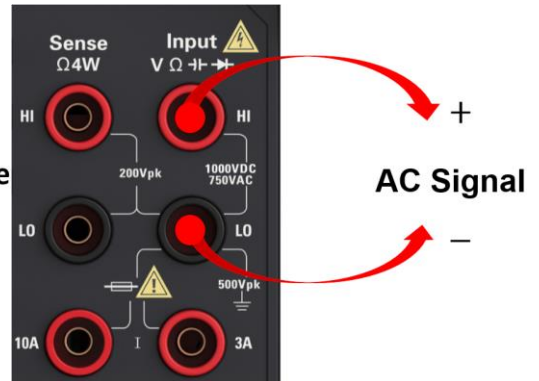

Continuity Measurement

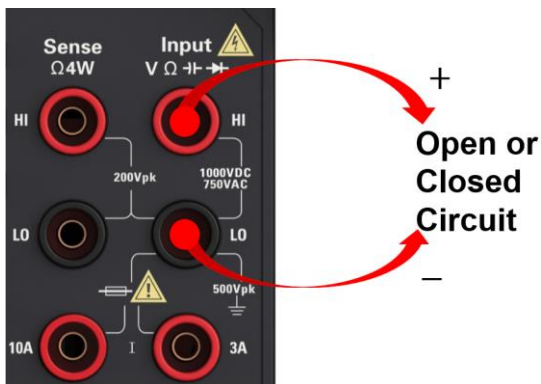

Diode Measurement

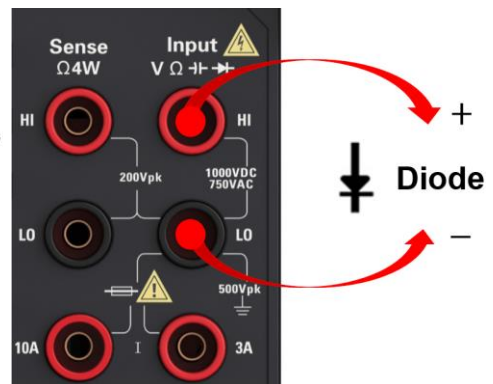

Chapter 2 Features and Functions

This section contains detailed information about instrument features.

This chapter outline:

- Measurement
- Triggering and Readings
- Probe hold
- Mathematics introduction
- Display introduction
- Utility Menu Introduction

Measurement

HDM3000 DMM supports many common measurements:

The DC voltage

The AC voltage

The DC current

The AC current

The resistance

The temperature

The capacitance

The continuity

The diode

Frequency and period

Auxiliary measurement

The DC voltage

This section describes how to configure DC voltage measurements from the front panel, including DCV proportional measurements.

Step 1: Configure the test leads, as shown below.

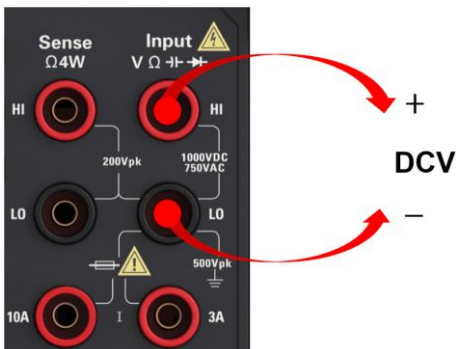

Step 2: Press [DCV] on the front panel.

Step 3:

- For **HDM3000**, Press **Aperture** and select the number of power line cycle (PLC) for measurement. Only 1, 10 and 100 PLCs provide normal mode (line frequency)

noise) suppression. Choose 100 PLC to provide the best noise suppression, but the slowest measurement speed:

Range Auto	Aperture 10 PLC	Auto Zero Off On	Input Z 10M Auto	DCV Ratio Off On
---------------	--------------------	---------------------	---------------------	---------------------

Select # of Power Line Cycles				
100 PLC	10 PLC	1 PLC	0.2 PLC	0.02 PLC

- For the **HDM3000**, by default **Aperture NPLC=10PLC**, use the Up/Down arrow keys to specify the integration time in the Power Line Cyclings (PLC) for measurement. 1, 10 and 100 PLCs provide normal mode (line frequency noise) rejection. Choose 100 PLC to provide the best noise rejection, but the slowest measurement speed.

Step 4:

Select a Range for measurement by pressing **Range**. You can also use the [+], [-], and [Range] keys on the front panel to select ranges. **Auto (adjusting the range automatically) based on input**. Compared with manual range, automatic range adjustment is more convenient, but can lead to slower measurement. Automatic range adjustment can turn the range up to 120% of the current range and down to less than 10% of the current range.

Select DC Voltage Range					
Auto	100mV	1V	10V	100V	1000V

Step 5: Auto Zero: Auto Zero provides the most accurate measurement, but requires additional time to perform the reset-to-zero measurement. With Auto Zero enabled (ON), the DMM makes an internal measurement of the offset after each measurement. Then the offset value is subtracted from the previous reading.

This prevents the offset voltage on the DMM input circuit from affecting the measurement accuracy. With Auto Zero disabled (OFF), the DMM makes a measurement of the offset and subtracts the offset from all subsequent measured parameters. Each time you change a function, range, or integration time, the DMM makes a new offset measurement. (There is no Auto zero setting for 4-wire measurement.)

Step 6: Specify the input impedance (Input Z) of the test lead. This will specify the measuring terminal input impedance and can be auto or 10 M Ω . Auto mode chooses high impedance (HighZ) and can be applicable to 100 mV, 1 V and 10 V ranges while 10 M Ω applies to 100 V and 1000 V ranges. In most cases, 10 M Ω is high enough to not load most of the circuit, but also low enough, to stabilize the reading of the high impedance circuit. It will cause the noise included in readings below HighZ option, this option is suitable for 10M Ω a large load.

DCV Ratio

The DCV Ratio key enables or disables DCV Ratio measurement. Note that the Auto Zero soft key will disappear when DCV proportional measurement is enabled. This is because Auto Zero cannot be disabled during DCV Ratio.

This ratio is the ratio of the voltage at the input terminal to the reference voltage. The reference voltage is the difference between two separate measurements. These measurements are the DC voltage from the HI sensing terminal to the LO input terminal and from the LO sensing terminal to the LO input terminal. Both measurements must be within the ± 12 VDC range. The reference voltage is always automatically adjusted, and the range used for both measurements is based on the larger result of the two measurements.

Configure DCV Ratio measurements, as shown below:

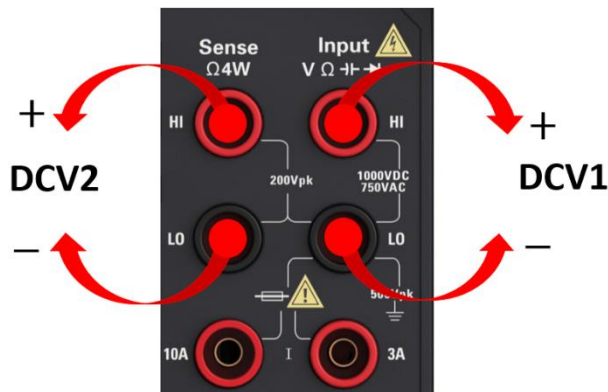

The AC voltage

This section describes how to configure AC voltage measurement from the front panel.

NOTE

Select the default delay to give the correct first reading for most measurements. For the most accurate measurements, the input that prevents the RC time constant must be stabilized to 1/50 of the AC signal level.

Signals greater than 300 V (RMS) will cause self-heating of the signal regulator. These errors are included in the instrument specification. Changes in internal temperature due to self-heating may cause additional errors in other functions or ranges. The extra error usually disappears within a few minutes.

Step 1: Configure the test leads, as shown below.

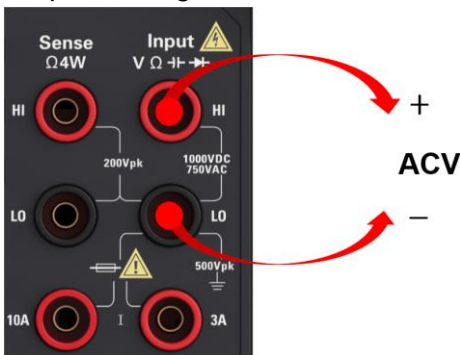

Step 2: Press [ACV] on the front panel.



Step 3: Press **Range** to choose a range for measurement. **Auto (auto range adjustment)** selects range for measurement based on input. Compared with

manually selected range, auto range adjustment is more convenient but can lead to slower measurement. **Auto** range adjustment can turn the range up to 120% of the current range and down to less than 10% of the current range.



Step 4: Press AC Filter and select Filter for measurement. The instrument uses three different AC filters, allowing you to optimize low frequency accuracy. The three filters are 3 Hz, 20 Hz, and 200 Hz, and in general, you should choose the highest frequency filter whose frequency is less than the frequency of the signal you are measuring, because a higher frequency filter results in a faster measurement. For example, it's better to use a 20 Hz filter when measuring a signal in the 20 to 200 Hz range.

If measurement speed is not an issue, choosing a lower frequency filter will result in a quieter measurement, depending on the signal you are measuring.



NOTE To accurately display statistics for AC measurements in the front panel mode, you must use the default manual trigger Delay ([Acquire] >Delay Man).

The DC current

This section describes how to configure a DC current measurement from the front panel.

Step 1: Configure the test leads, as shown below.

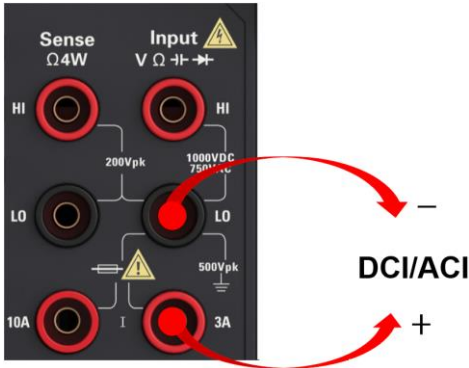

On the HDM3000, you can also configure the measurement using the 10A terminal, which is recommended when measuring currents greater than 3A:

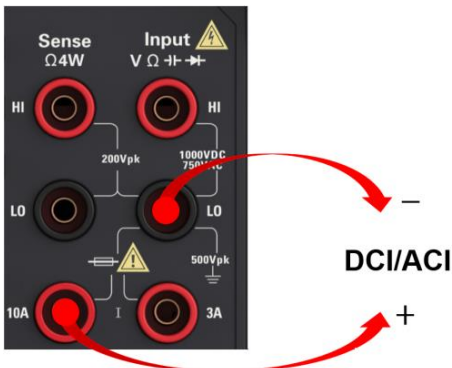

Step 2: Press [DCI] on the front panel.



Step 3: For the HDM3000, with Aperture NPLC=10PLC by default, use the Up/Down arrow keys to specify the integration time in the Power Line Cycle Number (PLC) for measurement. 1, 10 and 100 PLCs provide normal mode (line frequency noise) suppression.

Choose 100 PLC to provide the best noise suppression but the slowest measurement speed:

Step 4: By default, the instrument selects 3A terminal. Use the **Terminals** soft keys to switch between the 3A and 10A input terminals. When you change it to 10 A, the

measurement range automatically changes to 10 A.

Step 5: Press **Range** to choose a range for measurement. You can also use the [+], [-] keys on the front panel to select the range. **Auto** (auto range adjustment)

automatically select range for measurement based on input. Compared with manually adjusted range, automatic range adjustment is more convenient but can lead to slower measurement. Auto range adjustment can turn the range up to 120% of the current range and down to less than 10% of the current range. Press **More** to toggle between the two pages of settings.

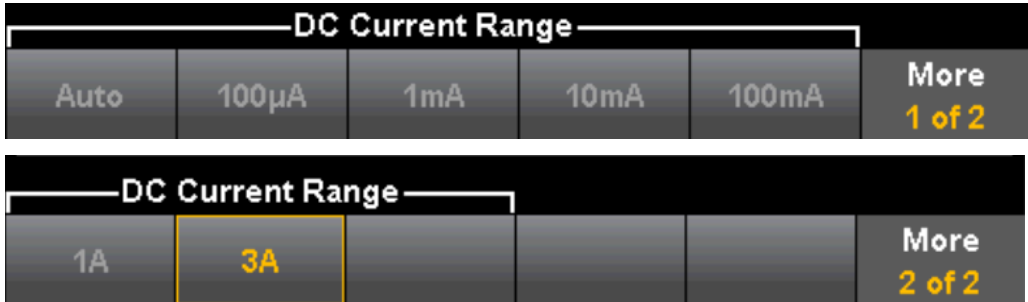

Step 6: Auto Zero: Auto Zero provides the most accurate measured value but requires additional time to perform the reset-to-zero measurement. With Auto Zero enabled (ON), the DMM makes an internal measurement of the offset after each measurement and then the offset value is subtracted from the previous reading.

This prevents the offset voltage on the DMM input circuit from affecting the measurement accuracy. With Auto Zero disabled (OFF), the DMM makes a measurement of the offset and subtracts the offset from all subsequent measured parameters.

The AC current

This section describes how to configure AC current measurement from the front panel.

Step 1: Configure the test leads, as shown below.

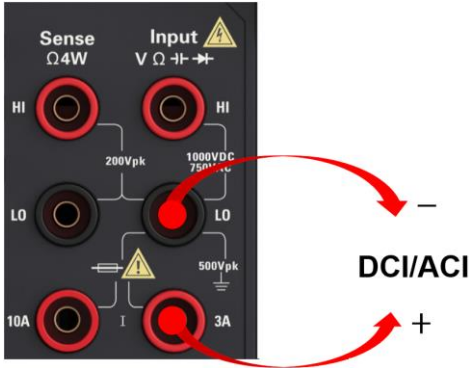

On the HDM3000, you can also configure the measurement using the 10A terminal, which is recommended when measuring currents greater than 3.0A:

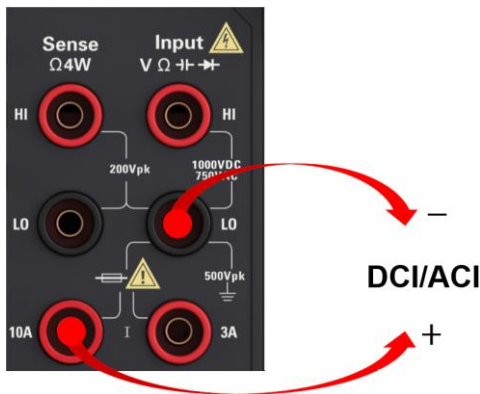

Step 2: Press [ACI] on the front panel.



Step 3: By default, the instrument selects 3A terminal. Use the Terminals soft keys to switch between the 3A and 10A input terminals. When you change it to 10 A, the measurement range automatically changes to 10 A.

Note: When measuring with 10A terminal, the presence of a signal at 3A terminal may cause significant error.

Step 4: Press **Range** to choose a range for measurement. You can also use the [+], [-] keys on the front panel to select the range. **Auto** (auto range adjustment) automatically select range for measurement based on input. Compared with

manually adjusted range, automatic range adjustment is more convenient but can lead to slower measurement. Auto range adjustment can turn the range up to 120% of the current range and down to less than 10% of the current range. Press **More** to toggle between the two pages of settings.

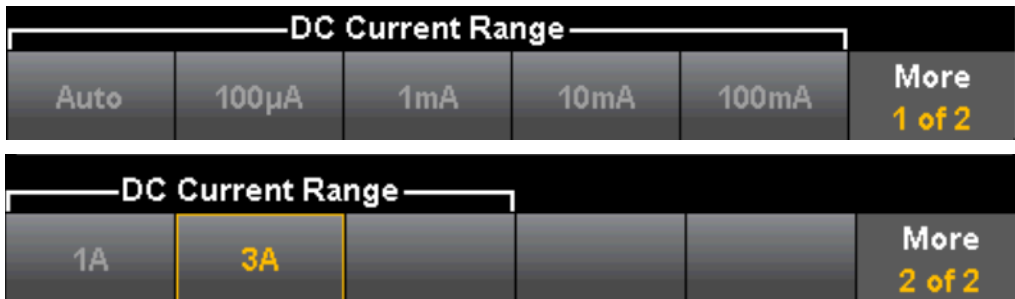

Step 5: Press **AC Filter** and select Filter for measurement. The instrument uses three different AC filters, allowing you to optimize low-frequency accuracy or shorten AC stabilization time after changing the amplitude of the input signal.

The three filters are 3 Hz, 20 Hz, and 200 Hz, and in general, you should choose the highest frequency filter whose frequency is less than the frequency of the signal you are measuring, because a higher frequency filter results in a faster measurement. For example, it's better to use a 20 Hz filter when measuring a signal in the 20 to 200 Hz range.

If measurement speed is not an issue, choosing a lower frequency filter will result in a quieter measurement, depending on the signal you are measuring.



Note: To accurately display statistics for AC measurements in front panel mode, you must use the default manual trigger Delay ([Acquire] >Delay Man).

Resistance

This section describes how to configure 2 and 4-wire resistance measurements from the front panel.

Step 1: Configure the test leads, as shown below.

2 wire resistance:

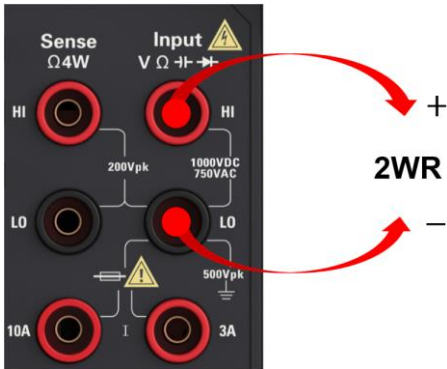

4 wire resistance:

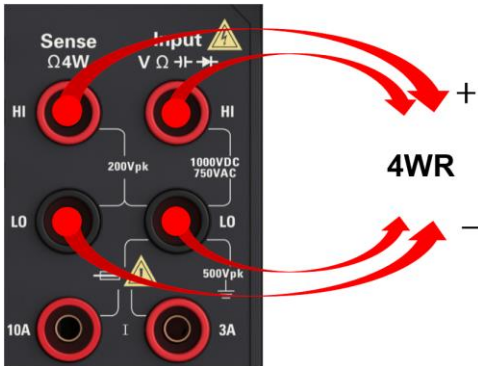

Step 2: press the front panel [Ω 2 w] or [Ω 4 w]. The following menu appears.

(Ω 4W menu does not include **Auto Zero**)



Step 3: For the HDM3000, use the Up/Down arrow keys to specify the integration time in the Power Line Cycle Number (PLC) for measurement with Aperture NPLC=10PLC by default. 1, 10 and 100 PLCs provide normal mode (line frequency noise)

suppression.

Choose 100 PLC to provide the best noise suppression but the slowest measurement speed:

4: Press **Range** to choose a range for measurement. You can also use the [+], [-] keys on the front panel to select the range. **Auto** (auto range adjustment)

automatically select range for measurement based on input. Compared with manually adjusted range, automatic range adjustment is more convenient but can lead to slower measurement. Auto range adjustment can turn the range up to 120% of the current range and down to less than 10% of the current range. Press **More** to toggle between the two pages of settings.

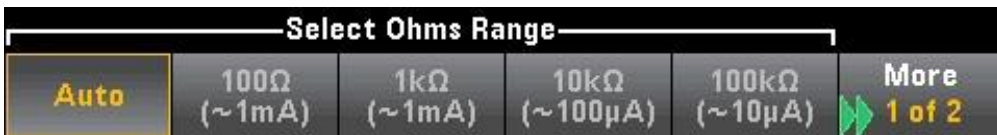

Note that the test current provided by each range is displayed. After selecting the range, the main resistance menu will be displayed.

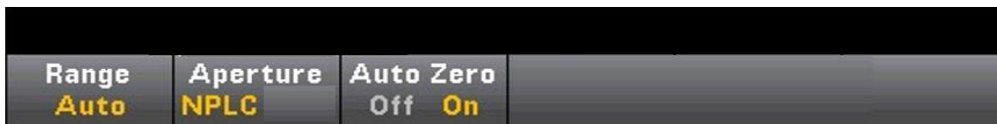

Step 5: **Auto Zero**: Auto Zero provides the most accurate measured value but requires additional time to perform the reset-to-zero measurement. With Auto Zero enabled (ON), the DMM makes an internal measurement of the offset after each measurement and then the offset value is subtracted from the previous reading.

This prevents the offset voltage on the DMM input circuit from affecting the measurement accuracy. With Auto Zero disabled (OFF), the DMM makes a measurement of the offset and subtracts the offset from all subsequent measured parameters. Each time you change a function, range, or integration time, the DMM makes a new offset measurement. (There is no Auto Zero setting for 4-wire measurement)

Negative resistance measurement:

In some cases, the instrument may report a negative resistance measurement. These conditions can occur with 2 - and 4-wire resistance measurements or with continuous measurements.

Conditions that may cause negative resistance (ohms) values include:

- Front/rear switch contact resistance changes
- Invert the Sense HI and LO leads
- Circuit connections with external bias or thermal voltage.

- Measurements of connection changes after null operation

The temperature

This section describes how to configure 2 and 4-wire temperature measurements on the front panel.

Step 1: Configure the test leads, as shown below.

2-wire temperature:

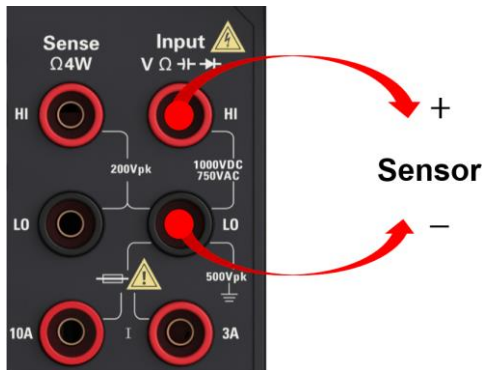

4-wire temperature:

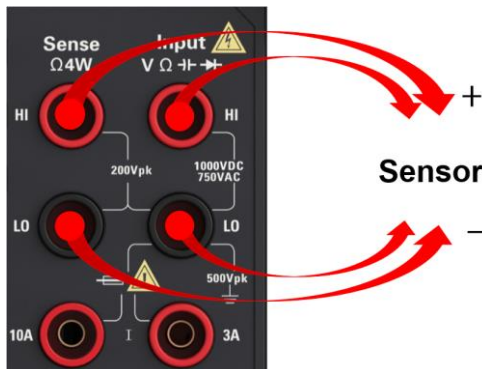

Step 2: Press [Temp] on the front panel. The following menu will appear.



Step 3: Press **Probe** to select the probe type. If you choose to use an RTD, the menu will have a soft key specifying the resistance of the RTD at 0°C (R0).



Step 4: For 2-line measurements, the Auto Zero soft key is available.

Auto Zero: Auto Zero provides the most accurate measured value but requires additional time to perform the reset-to-zero measurement. With Auto Zero enabled (ON), the DMM makes an internal measurement of the offset after each measurement and then the offset value is subtracted from the previous reading. This prevents the offset voltage on the DMM input circuit from affecting the measurement accuracy. With Auto Zero disabled (OFF), the DMM makes a measurement of the offset and subtracts the offset from all subsequent measured parameters.

Step 5: Press **Aperture** and select the number of power cord circulation (PLC) for measurement. Only 1, 10 and 100 PLCs provide normal mode (line frequency noise) suppression. Choose 100 PLC to provide the best noise suppression and resolution, but the slowest measurement speed:

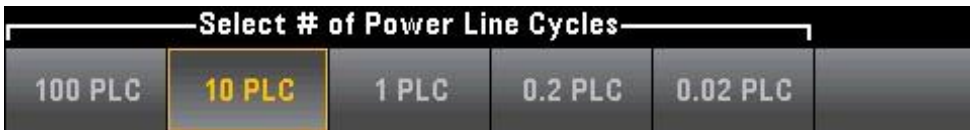



Step 6: Use the **Units** soft key to display the Celsius, Fahrenheit, or Kelvin temperature.

The capacitance

This section describes how to configure capacitance measurements from the front panel.

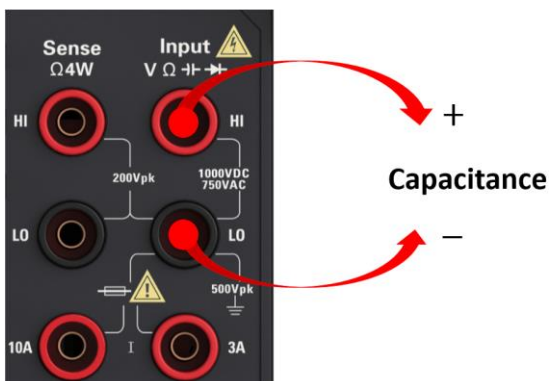
Step 1: Configure the test leads, as shown below.



Step 2: Press the one on the front panel .

Step 3: To remove the test lead capacitance, do the following operations:

- Disconnect the probe end of the positive and negative test leads from the test circuit and leave it open.
- Press **Null**. The **DMM** subtracts this null value from the capacitance measurement.

Step 4: Press **Range** to choose a range for measurement. You can also use the [+], [-] keys on the front panel to select the range. Automatically select range for measurement based on input. Compared with manually selected range, auto range adjustment is more convenient, but can lead to slower measurement. Automatic adjustment range can be adjusted down to less than 10% of the range, can also be adjusted up to more than 120% of the range. When the auto range adjustment range is off, the instrument will not report "overload" if the reading exceeds 120% of the range (capacitance measurements only). Overload occurs only when the algorithm timeouts because the applied capacitance is too large to make measurements. In capacitance measurement mode, if you apply a DC voltage or short connection to the input terminal, the instrument will report an "overload".

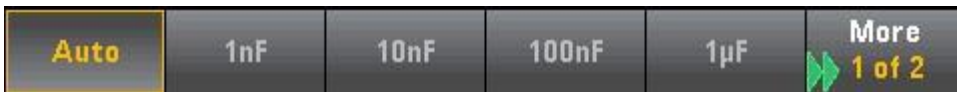

Continuity

This section describes how to configure continuity tests from the front panel.

Step 1: Configure the test leads, as shown below.

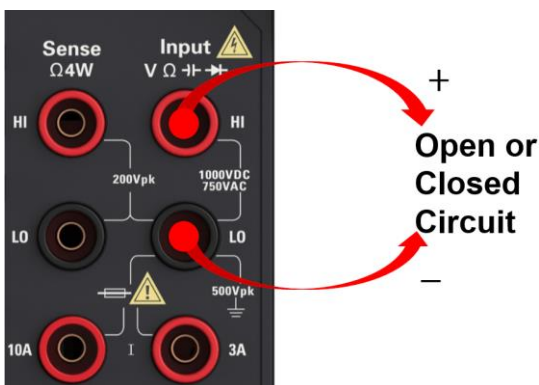

Step 2: Press **[Cont]** on the front panel to open a menu. You can use this menu to choose to use buzzer or disable buzzer.



The continuous measurement method is as follows:

$\leq 10 \Omega$	Display measured resistance and buzzer (if buzzer is enabled.)
10 Ω to 1.2 k	Display measured resistance, no buzzing
$> 1.2 \text{ k } \Omega$	Display OPEN, no buzzing

The diode

This section describes how to configure diode tests on the front panel.

Step 1: Configure the test leads, as shown below.

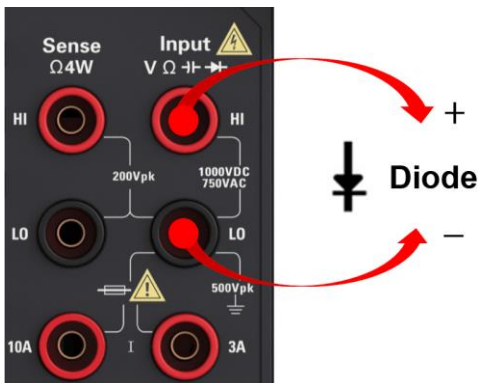

Step 2: Press the one  on the front panel to open a menu which specifies whether the DMM will ring to indicate a successful diode test.



The diode measurement method is as follows:

0 to 4.9 V	The voltage is displayed on the front panel and the instrument beeps when the signal is converted to a threshold of 0.3 to 0.8V. (if beeping is enabled.)
$> 5 \text{ V}$	The front panel shows Open

Frequency and period

This section describes how to configure frequency and period measurements from the front panel.

Step 1: Configure the test leads, as shown below.

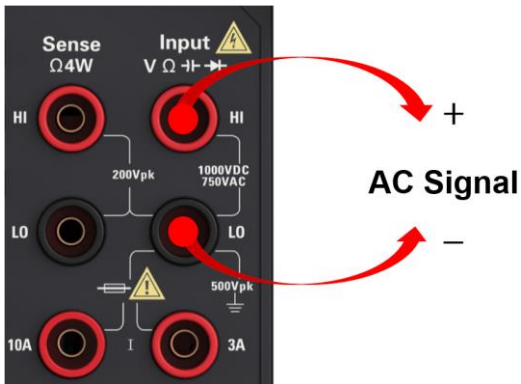

Step 2: Press **[Freq]** on the front panel, then use the first soft key to select a frequency or period measurement.



Step 3: Press **Range** to choose a range for measurement. **Auto** (Auto range adjustment) selects range for measurement based on input. Compared with manually selected range, auto range adjustment is more convenient, but can lead to slower measurement. Automatically adjusted range can turn up to 120% of the current range and down to less than 10% of the current range.



Step 4: Press **AC Filter** and select filter for measurement. The instrument uses three different AC filters, allowing you to optimize low-frequency accuracy or shorten AC stabilization time after changing the amplitude of the input signal.

The three filters are 3 Hz, 20 Hz, and 200 Hz, and in general, you should choose the highest frequency filter whose frequency is less than the frequency of the signal you are measuring, because a higher frequency filter results in a faster measurement. For example, it is better to use a 20 Hz filter when measuring a signal in the 20 to 200 Hz range.

If measurement speed is not an issue, choosing a lower frequency filter will result in a quieter measurement, depending on the signal you are measuring.



Step 5: Press **Gate Time** and select a measurement gap of 10 ms, 100 ms(default), or 1 s(integral Time).



Step 6: **Timeout** can be used to control the frequency or period that the instrument waits before the Timeout when there is no signal to measure the time. If it sets to 1 s, the instrument will wait 1 second before time-out. If it sets to AUTO, the wait time will vary with the different AC filter bandwidths. The faster the bandwidth, the less time the instrument has to wait before timeout and returning 0.0. This facilitates the manufacture of test systems, where DUT failure may result in no signal. In this case, the fault can be found more quickly and the overall test speed can be improved.

Note: To accurately display statistics for AC measurements in front panel mode, you must use the default manual trigger Delay ([Acquire] >Delay Man).

Auxiliary Measurement

Most measurement functions can be used to select and display auxiliary measurement functions. Auxiliary measurements can only be displayed on digital and bar meter displays.

For example, thermistor temperature measurements (primary) and resistance measurements made on thermistors (auxiliary) are as follows:



To select Auxiliary measurements from the front panel, first select the primary measurement function and then press **Display**:



Press **2nd Meas** and select Auxiliary Measurement.

The main measurement functions of each digital multimeter model and their related auxiliary measurements include:

Main measurement function	HDM3000 Auxiliary Measuring function
DCV	ACV
ACV	frequency
DCI	ACI
ACI	frequency
frequency	cycle
cycle	frequency
The temperature	The sensor

Among them:

- Sensor - original sensor value. The voltage value and the resistance value of the thermistor /RTD.
- After making one or more primary measurements (lasting approximately 4 seconds), the digital multimeter makes an auxiliary measurement.

Triggers and Reading

The trigger mode and large reading memory on HDM3000 series digital multimeters provide a wide range of applications for them.

Instrument trigger mode

The result of the trigger is that the measurement results are collected on a digital multimeter. This section describes how to configure triggers for continuous measurement mode.

Click **[Acquire]** to open the following menu:



The main purpose of the above menu is to allow you to configure the measurement trigger, you can also use the VMC Out soft key to set the edge slope of the VM Comp (voltmeter complete) output on the rear panel of the instrument. This connector emits a signal whenever the voltmeter completes a measurement, allowing you to send signals to other devices in the measurement system.

Note: To accurately display statistics for AC measurements in front panel mode, you must use the default manual trigger Delay ([Acquire] >Delay Man).

You can select one of the following three trigger sources from the (Trg Src) menu:



Auto - This instrument makes continuous measurements and will automatically emit a new trigger as soon as a measurement is completed.

SINGLE - This instrument will emit a trigger every time the [SINGLE] key on the front panel is pressed.

EXT - This instrument will emit a trigger each time the appropriate slope reaches the EXT Trig connector on the rear panel. You can specify the slope on the soft key menu that will be displayed when Trg Src is set to Ext.

In Single, Ext mode, you can use the Samples/Trigger soft key to specify the number of Samples to be sampled per Trigger.

Both Single and Ext modes can be buffered to a trigger, which means that if you press [Single] or receive an external trigger while making a series of measurements, the instrument will complete the series of measurements and then immediately start a new series of measurements based on the trigger.

If multiple [Single] or external triggers are emitted during a series of measurements, all of them will be received after the first trigger is dropped.

The [Acquire] menu can also configure the delay that occurs before each measurement, regardless of the trigger mode (Auto, Single, or Ext). This can be automatic (select the delay based on the steady time of the digital multimeter) or manual (user specified delay time).

Finally, the **Run/Stop** and **Single** keys on the front panel. In auto trigger mode, press **[Run/Stop]** to Stop and resume measurement, and press [Single] to switch the instrument to Single trigger mode. In Single and Ext modes, press [Run/Stop] to Stop the reading if it is in progress, or switch this mode to "Auto" if it has stopped.

Trigger delay and multiple sampling

The instrument can insert a trigger delay between the occurrence of the trigger and the first measurement. When using AUTO (Delay Auto soft key), the instrument will automatically determine the delay according to the function, range and integral time. For more information, see Automatic Trigger Delays. However, for measurements using long cables and measurements of high capacitance or high impedance signals, you may need to manually set a delay longer than the automatic delay (the Delay Man soft key) to make the input stable, and then make a burst measurement.

If you configure the instrument to sample multiple times per Trigger (Samples/Trigger soft key), in all cases, the first sample will be taken after a Trigger delay. In addition, the sampling time depends on whether you choose to immediately sample (Sample Immediate soft key, default) or use the sample timer (Sample Timer soft key) as shown below.

- Sample Immediate - After triggering, the first Sample will be taken after a trigger delay time, and then the trigger delay time will be inserted between successive samples:

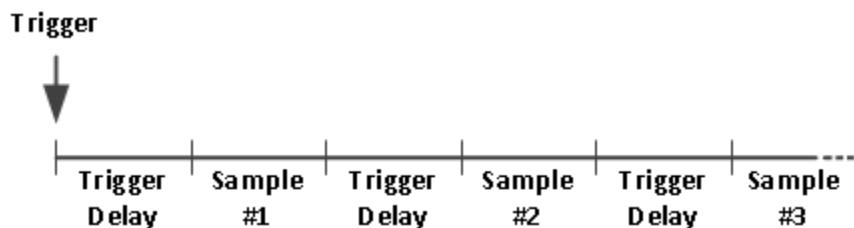

In this configuration, timed sampling is not deterministic because a delay time is inserted after each sampling is completed. The actual time required to perform each sample is related to the integration time and the automatic range adjustment time.

Store and erase readings

You can store up to 1,000 measurements in the HDM3000 reading memory. The readings are stored in a first-in, first-out (FIFO) buffer. If the reading memory is full, the data stored the longest will be lost when new readings are taken.

In Local mode, the instrument will collect readings, statistics, trend charts, and histogram information in the background, so that the user can view the data if they select any of these options. In Remote mode, the instrument does not collect this data by default.

Switching the instrument from LOCAL to REMOTE does not erase any readings from memory. Switching the instrument from Remote to Local does not erase any readings from memory.

In general, you can press [Run/Stop] to turn the measured readings on and off, as described above. You can also press [Single] to get one or a specified number of readings.

To Save Readings, click [Acquire] > Save Readings. Then use the appearing menu to configure the location where you want to save the reading:

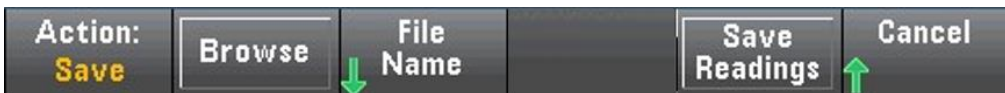

Press Save Readings to save readings in memory to a file.

Clear reading memory

The following operations can clear the reading memory:

- Change the measurement function
- Press any Clear Readings soft key
- Turn in or turn out of Probe Hold
- Change of temperature unit
- Change any dB/dBm parameter
- Change any histogram bar parameters
- Change the temperature probe or R0
- Call stored state
- Calibrate the instrument
- Switch between 3A and 10A inputs
- Change the position of the front/rear switch
- Convert from Remote mode to Local mode
- Turn NULL on or off, or change NULL values

These operations will not remove reading memory:

- Change measurement parameters (such as range and aperture).
- Turn the limit on or off, or adjust the limit
- Press [Run/Stop] in front panel auto-trigger mode
- Change sampling frequency or trigger delay for each trigger
- Change display mode
- Change the VM COMP output polarity
- Change number masking
- Change histogram, bar diagram or trend chart scaling
- Change user preferences
- Perform self-inspection

Probe Hold

Because detecting small areas requires concentration, it is difficult to read what is displayed on the instrument's display screen when making measurements. Therefore, there is a [Probe Hold] key on the front panel of the instrument that allows you to take readings without looking at the display. You can generate up to eight readings and keep them on the display for later review. These readings may be of different measurement types, and you can clear the readings displayed at any time.

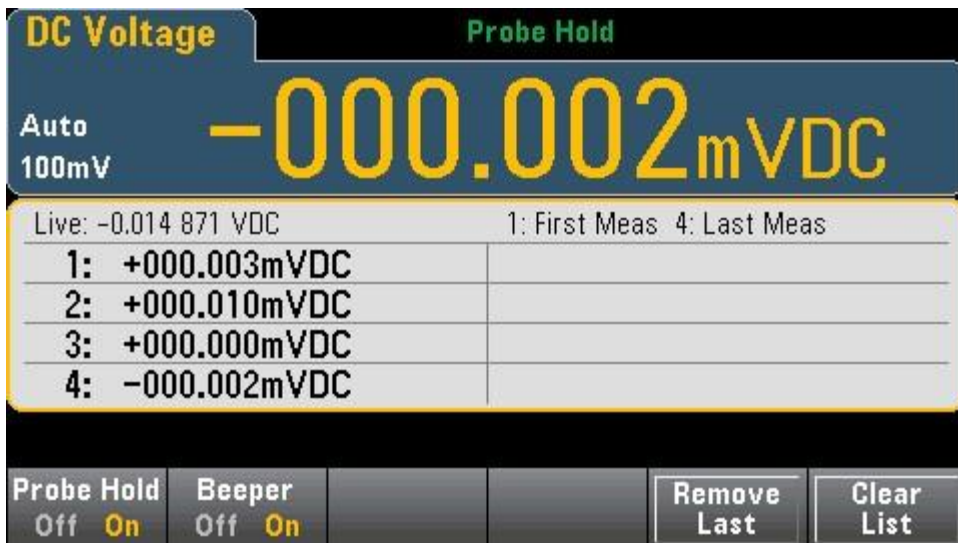

In the Probe Hold mode, the measuring settings can be optimized in order to reliably

detect stable signal (when exiting Probe Hold, these settings will restore to their original values). When detecting signal, the instrument will beep (if the buzzer is enabled), and automatically record the measured results when discovering a series of stable readings. You can get additional readings without having to press [Probe Hold] again.

Press Remove Last to remove the last reading in the list. Click Clear List to delete all the readings in the List.

Because the Probe Hold display is optimized to display Probe Hold readings, it cannot be combined with other display modes, such as histograms, bar charts, trend charts, or statistics.

Probe Hold function is available on the front panel only. Readings recorded in Probe Hold mode cannot be remotely accessed.

Mathematics - Introduction

The [Math] key is the conversion key for [Null] :



The following mathematical functions are available for the HDM3000:



- Null
- DB/dBm scaling
- statistics
- limit

Mathematics - Null function

A null reading is a value that is subtracted from all subsequent measurements. This value is specific to the current function, even when you exit the function and return to use it.

A common use of this function is to remove lead resistors from resistance

measurements. To do this, simply short-circuit the test lead and press [Null]. For other measurement functions, place the probe into the null value circuit before pressing [Null].

You can also specify a null Value by pressing [Math], changing the first soft key to Value, and using the arrow key to enter the value. To turn off null function, press [Null] again, or press [Math], and then set the first soft key to OFF.

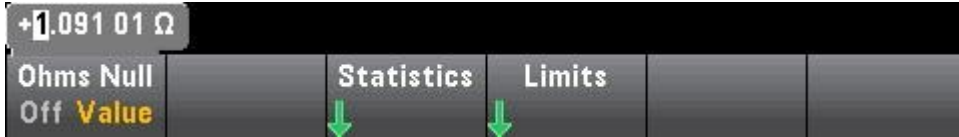

Mathematical operations - dB/dBm scaling

The DB and DBM scaling functions are only applicable to ACV and DCV measurements. With this function you can make scaling measurements relative to the reference values.

NOTE When you change the measurement function (for example, from DCV to ACV), the scaling is set to OFF. You must re-enable scaling after changing the measurement function.

The front panel menu

DB and DBM functions can be accessed through the second soft key in the [Math] menu.



When the first soft key in the dB/dBm menu is enabled (as shown below), you will see one of the following menus: When the function is dB:



When the function is dBm:



The dB scaling

Each dB measurement is the difference between the input signal and the stored reference value (both converted into dBm) : $\text{dB} = \text{reading in dBm} - \text{reference value in dBm}$

The relative value must be between -200 and +200 dBm (default is 0). You can Measure the Value by measuring Ref Value, or you can enter a specified Value.

dBm scaling

The dBm function is a logarithmic expression that compares the amount of electricity transferred to the reference resistor, relative to 1 mW:

$$\text{dBm} = 10 \times \log_{10}(\text{reading}^2 / \text{reference resistance} / 1 \text{ mW})$$

Reference resistance values (Ref R) can be 50, 75, 93, 110, 124, 125, 135, 150, 250, 300, 500, 600(default), 800,900, 1000, 1200 or 8000 Ω . Press Ref R and use the up and down arrows on the front panel to select.

Mathematical Operations - Statistics

When the instrument takes measurements, it automatically calculates statistics for those measurements.

The statistics menu can be accessed from the front panel menu through the third soft key in the [Math] menu.



Note: To accurately display statistics for AC measurements in front panel mode, you must use the default manual trigger Delay ([Acquire] >Delay Man).

The first soft key on this menu (shown below) can hide or show statistics below the data display.



If DB or DBM scaling is used, the mean and standard deviation are not shown.
note

- **Span is the value of Max minus Min.**
- Press Clear Readings to clear the reading memory and restart statistical calculations.

Mathematical Operations - Limit

The limit check indicates how many times the sample has exceeded the specified limit and also indicates when this limit has been exceeded.

The front panel menu

The limit menu can be accessed through the [Math] menu.



The first soft key enables or disables the limit. The second and third soft keys specify the limits to be high and low values, or as a range at either end of the middle value. For example, a Low limit value of -4 V and a High limit value of +7 V correspond to a Center value of 1.5 V and a Span value of 11 V.

The Beeper soft key enables or disables beeping when limits are exceeded.

The Clear Condition can reset the limit boundary as described below. Limit indicator display screen uses color to indicate limit and exceeding limit.

The trend chart

The limit area is shown in light red on the figure. When the limit is not exceeded, the limit boundary is shown in green (as shown below).

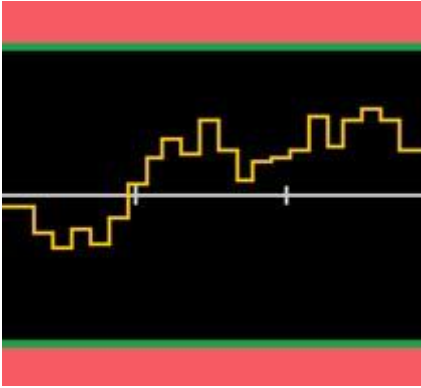

When the limit is exceeded, the boundary turns red. In the following image, the upper boundary is still green, but the lower boundary has turned red because the trend line has entered the lower limit area.

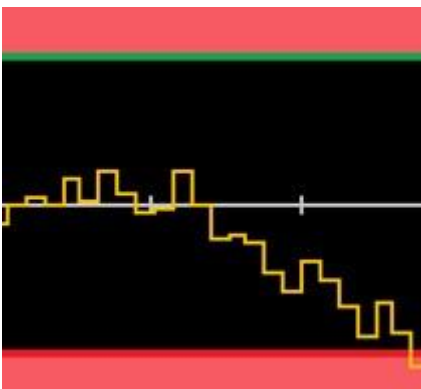

Even when the trend line moves out of the limit area, the boundary remains red. When the trend line is within the limit, you can reset the boundary to green by pressing Clear Condition.

Also note that the newly displayed measured number (under +09.994 VDC) indicates whether the measurement is within the limit. Because the limit is 10 V, the 9.994 VDC value is displayed in the standard background.

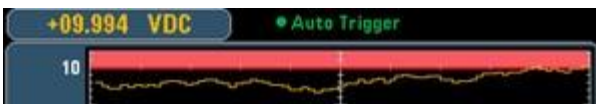

In contrast, the 11.083 VDC reading is highlighted in red to indicate that it has exceeded its limit.

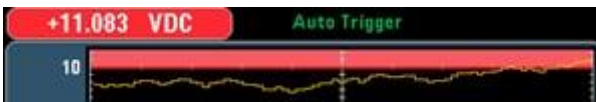

Histogram

The same color scheme applies to histograms. In the image below, the green vertical line separates the black histogram background from the pale red limit area, indicating

that the limit has not been exceeded.



In the image below, the low (left) limit boundary is red, indicating that the lower limit has been exceeded. (The reading in the upper left corner (-01.68487VDC) is within the limit, so it is not red).

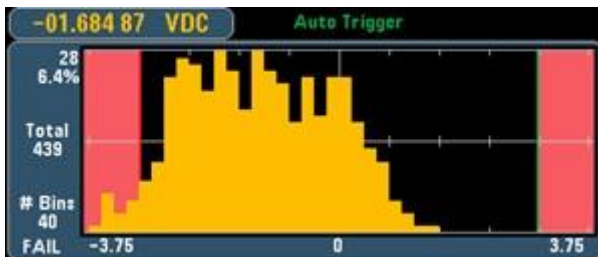

The bar meter

The bar meter (below) uses the same color scheme. The green limit boundary on the left indicates that the lower limit has not been exceeded, while the red limit boundary on the right indicates that the upper limit has been exceeded. The numbers 0 to 259 below the pale red limit area indicate the number of times each limit has been exceeded, and the word FAIL indicates that the limit has been exceeded.



The number of

The bright red color (as shown below) indicates that the measured value displayed exceeds the limit. The Number display also indicates the Number of times the limit was exceeded.



Display - Introduction

By default, the instrument displays the reading in digital form. You can also select bar meter, trend chart or histogram display:



For "digital" and "bar meter" displays, many of the main measurement functions allow the display of auxiliary measurement results.

Select Display

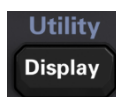

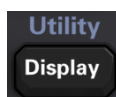
Press the  Key, and then press the Display soft key to select the Display type:



The table below summarizes all display types for each measurement mode.

Display type				
model	digital	The bar meter	Trend chart histogram	Remarks/Uses
Continuous	Be selected by default when booting. Display the measured results on the display screen.	Digits + Bar chart. Display the measured results on the display screen.	Measurement results spanning a specified length of time. Displays as a bar chart (trend Potential) or histogram. The accurate measured value cannot be obtained on the front panel.	Show trend and the histogram data only. There is no readings on the front panel.

The number

By default, the instrument displays readings in digital form:



Add tables

You can use the Label soft key to add a large text label to the screen. For example, you can use it to represent measurements being made using the DMM.



Enter the text, and then press Label Text, after that use the soft keys and the arrow keys on the front panel to modify the label (as shown in the figure below). Then press Done. Label fonts will automatically shrink to accommodate longer labels.



Select an auxiliary measurement

Press 2nd Meas to select and display auxiliary measurements. For example, for the DCV measurement function, you can choose ACV as the auxiliary measurement function. If ACV is selected as the auxiliary measurement, the DCV measurement results will be displayed on the top of the display, while

ACV measurement results will be displayed at the bottom of the display screen:



For more information about auxiliary measurements that can be used in each measurement function, see Auxiliary measurements.

The display digit soft key can select the digits displayed by the multimeter.



For example, the figure below shows 6½ bits.



By comparison, this figure shows 4½ bits.



The AUTO soft key specifies that the number of bits to be displayed is based on other specific function settings, such as measurement aperture, NPLC Settings. The measurement will be rounded, not truncated.

The bar meter

The bar meter (shown below) adds a move bar below the standard digital.

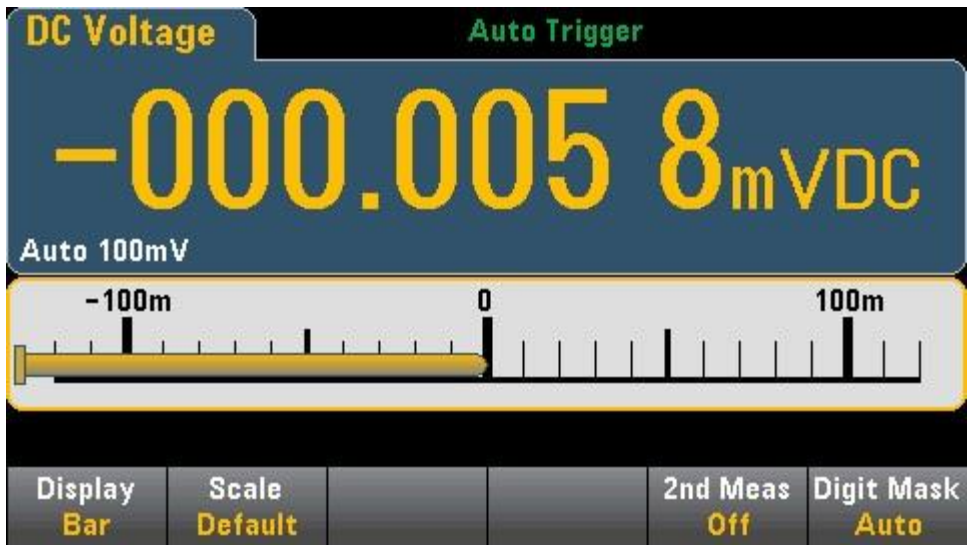

The Display and Digit Mask soft keys work just as they do in a digital display.





The Scale soft key specifies the horizontal scale:



- Default sets the scale equal to the measurement range.
- **Manual** allows you to configure demarcations, either as High and Low values, or as Span values around the Center value. For example, a scale of **-500 Ω Low** value and **1000 Ω High** value can be specified to **250 Ω Center** value with **1500 Ω Span**.



Select an auxiliary measurement

Press 2nd Meas to select and display auxiliary measurements. For example, for the DCV measurement function, you can select the ACV as the auxiliary measurement function. If ACV is selected as the auxiliary measurement, the DCV measurement results will be displayed as a number at the top of the display, the DCV will be displayed in the bar meter, and the ACV measurement results will be displayed above the bar meter:

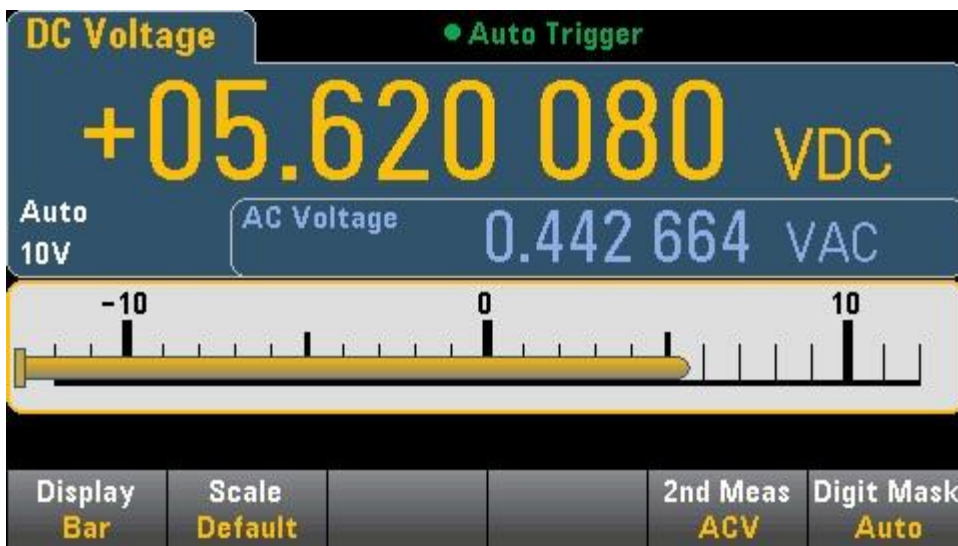

Trend Chart (Continuous Measurement Mode)

To select a trend chart, press [DISPLAY] and then the DISPLAY soft key:



In continuous measurement mode, the trend chart shows the trend of the data over a period of time:

The data will be collected and displayed in a pixel bars, as shown below.

Recent/All

The Recent/ALL softkey can display all data in the trend chart (ALL) or only the recent data (Recent). Neither will clear the reading memory.

In All mode, the trend chart will display all the readings taken, arranged from left to right. After the display is filled, the data on the left side of the display is compressed as new data is added to the right side of the display.

In Recent mode, the trend chart will display readings taken over a specified time period.

The Scaling

The Vertical Scale soft key specifies how to determine the current Vertical Scale.



Press Vertical to change scaling:

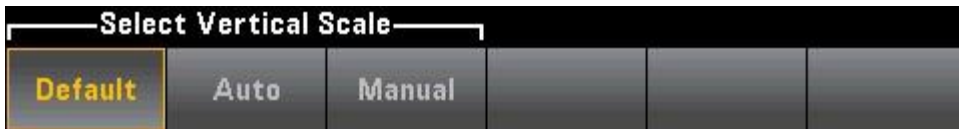

- Default sets the scale equal to the measurement range.
- Auto can automatically adjust the scaling to fit as much as possible the line currently displayed on the screen.
- Manual allows you to configure demarcations, either as High and Low values, or as Span values around the Center value. For example, scaling from a 0 V Low value to a 5 V High value is equivalent to a 2.5 V Span and a 5 V Center.



If you have enabled Limits, the (Limits) soft key will also appear. This sets the vertical scaling to match the limit value.

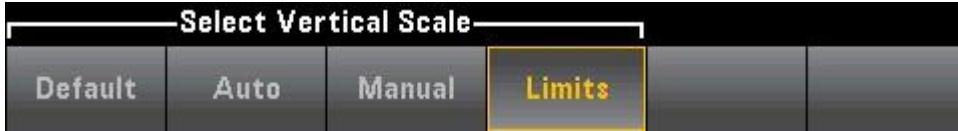

Histogram

Histogram shows the measurement data in the form of a graphical representation of the distribution of the measurement data. In a histogram display, data is grouped in bars represented by vertical bars.

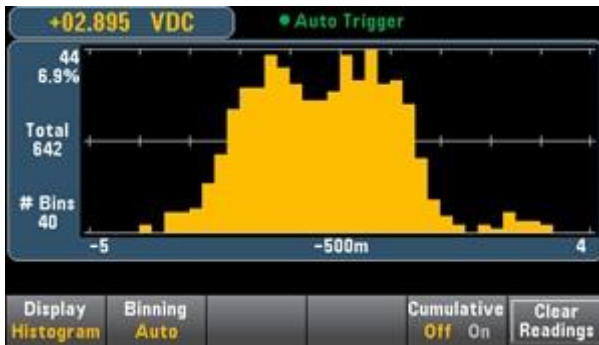

Note: When measuring repeated signals across multiple ranges, automatic range adjustment can adversely affect the histogram display. To avoid this, select a fixed range when using histogram displays.

Select display

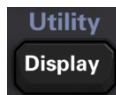

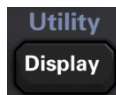
Press the  Key, and then press the Display soft key to select the Display type:



Binning

You can use the Binning soft key to allow the instrument to control the histogram bar handling (automatic bar handling).

For Binning Auto, the algorithm is started by continuously readjusting the histogram span based on the incoming readings and re-performing full barsar processing on the data when the new value exceeds the current span. After a large number of readings are taken, new readings beyond this range cause the bars to compress by these two

factors so that the new bars range covers the new reading. The number of bars shown is a function of the number of readings received: 0 to 100 readings = 10 bars, 101 to 500 readings = 20 bars, 501 to 1000 readings = 40 bars, 1001 to 5000 readings = 100 bars, 5001 to 10000 readings = 200 bars, >10000 readings = 400 bars. If the NPLC setting is less than 1 PLC, the maximum number of bars is 100.

For the Binning Manual, you can set the bar number to 10, 20, 40, 100, 200, or 400. You can specify the bar range as Low and High values, or as the Center value of the Span value. For example, the above histogram range (from -5 to 4 V) can be specified as -5 V Low value and 4 V High value, or -0.5 V Span value and 9 V Center value.

The histogram main menu also includes a Cumulative soft key, which can hide or display a line representing the Cumulative distribution of histogram data. Note that this line represents all data only when the external bars is displayed; If the external bars is not displayed, this line does not represent the external bars data. On vertical scaling, the cumulative distribution line always ranges from 0 to 100%, regardless of histogram scaling.

Histogram with statistical information

Displaying Statistics (Shift > Math > Statistics) is especially useful for histogram display. For example, in the figure below, the thick blue line is the mean, and each thin blue line represents one standard deviation from that mean.

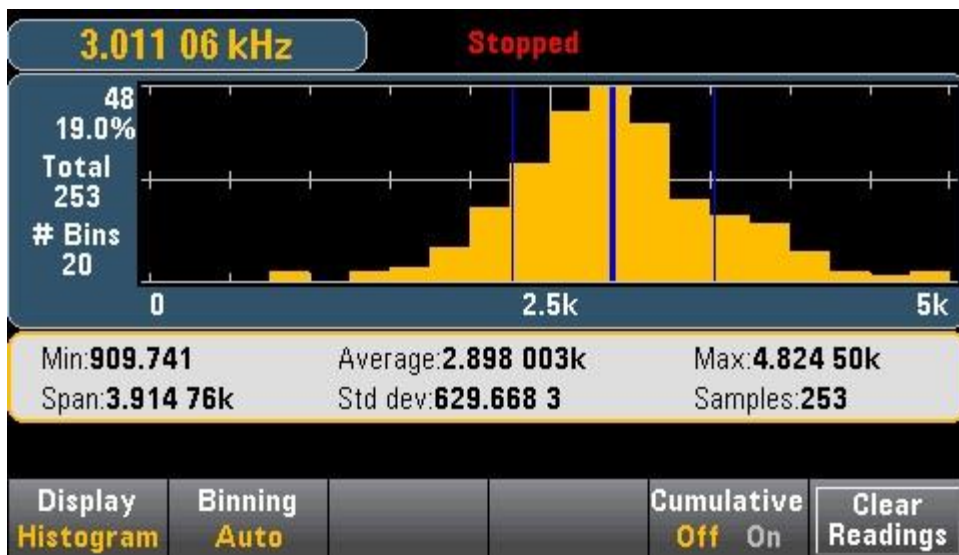

Utility Menu - Introduction

The [Utility] key is the conversion key to the [Display] key:



Utility provides the following functions:



Utility – Store and recall the status and preference files.

The "Utility" menu is shown below.



Press Store/Recall to store and recall the status and preference files. In general, the status file stores volatile Settings associated with the measurement. Preferences are instrument-related non-volatile parameters, but not any particular measurement value.



Store Settings

You can use the Store Settings to browse to a directory and specify a filename, then select whether you want to Store a status file or a preference file.



Store the specified file by pressing Store State (as shown above) or Store Pref (the label of the soft key, if you are storing preferences). You can store a file or create a new folder through Action.



Recall Settings

You can use Recall Settings to browse to the file to be recalled. Use the arrow keys to navigate to the desired status file (*.sta) or preference file (*.prf).



Power On

Power On selects the loaded state when powered On. This may be the state when the power is switched off (Last), or the state selected by the User (User Defined), or the Factory Defaults.



Set to Defaults

Set to Defaults loads the factory default state or preference Settings of the instrument.

Utility menu - Manage files

You can use the **Manage Files** soft keys to create, copy, delete, and rename files and folders on the instrument's internal flash memory or in the USB drive connected to the front panel. You can also use it to capture the current screen and save it as a bitmap (*.bmp) or portable network graphics (*.png) file. This is the default option, as shown below.



Action

Action specifies the Action to be performed. When you press [Shift] to the [Utility] menu, press Capture Display to save a screen capture of the display.



Delete - To Delete a file or folder, press Delete and Browse to browse to the

folder or file you want to Delete. Press Select >Perform Delete >Done

Folder - To create a folder, press Browse to browse to the internal or external location of the Folder, press File Name to enter the folder name, then press Done.Press Create Folder > Done.

Copy- To copy a file or folder, press Copy. Press Browse to browse to the folder or file you want to copy, and then press Select.

Press Copy Path and select an internal or external path to copy. Press Perform Copy> Done.

Rename - To Rename a file or folder, press Rename. Press Browse to browse to the folder or file you want to rename, and then press Select.Press New Name to enter a new name, then press Done. Press Perform Rename > Done.

Browse

Browse selects the file or folder to use to perform the operation.

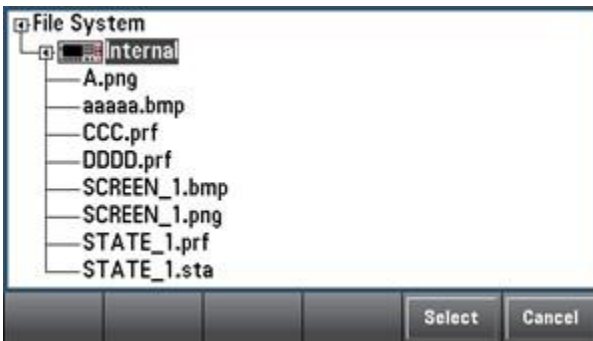

Use the front panel arrow and the [Select] key to navigate the list, then press Select or Cancel to exit the browsing window. Use the left and right arrows to close or expand folders to hide or show files in them.

The file name

With File Name, you can use the front panel arrow, the [Select] key, and the soft key to enter the file name. Use the front panel arrow to point to a letter, and use Previous Char and Next Char to move the cursor over the area where you want to enter the name. In the figure below, there is no Next CHAR soft key because the cursor is at the end.

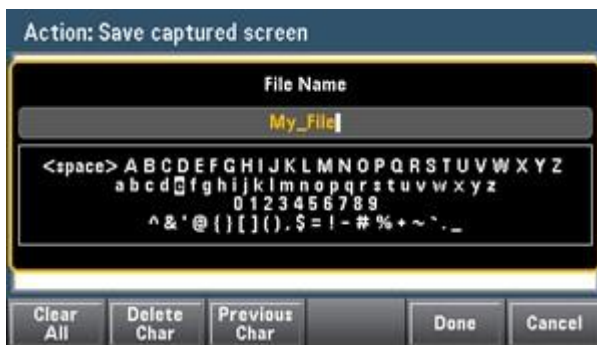

Press [Done] or [Cancel] to end the input.

Utility menu - I/O configuration

I/O Config is used to configure the I/O parameters for remote operation over a LAN, GPIB(optional) interfaces.



LAN RESET resets the LAN with its current settings and enables DHCP and MDNs.

LAN Settings

LAN Settings opens the menu shown below.



After enabling or disabling one or more services, press Apply. You must then turn the power off and back on for the new Settings to take effect.

IP Mode enables DHCP or Manual assignment of the instrument's IP address.

The acronym DHCP stands for Dynamic Host Configuration Protocol, a protocol for assigning dynamic IP addresses to networked devices. With dynamic addressing, a device can have a different IP address every time it connects to the network.

IP Mode is DHCP, instrument tries to obtain an IP address from a DHCP server. If a DHCP server is found, it assigns a dynamic IP address, Subnet Mask, and Default Gateway to the instrument. If a DHCP LAN address is not assigned by a DHCP server, then return "Map IP address failed!" and not change the original IP address.

IP Mode is Static: instrument uses the static IP address, Subnet Mask, and Default Gateway during power-on.

GPIB Settings(optional)

GPIB Settings allows you to set the instrument's GPIB interface.

You can also set the GPIB address to any value from 2 to 30.



Utility menu - Test/Admin

Test/Admin can be used to access self-check, calibration, and administration functions:



The Self - Test (Self)

Self-Test verifies that the instrument is running normally.

The calibration

Calibrate provides access to the instrument calibration process.

The firmware update

Firmware Update allows you to update the instrument's firmware to a new version.

Utility menu - System Settings

System Setup allows you to configure user preferences and set the date and time.



User Settings

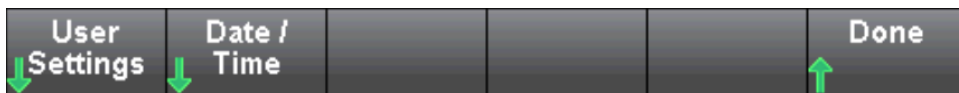

User Settings can specify user preferences that control how you interact with the instrument. These Settings are stored in nonvolatile memory.



Help language

Help Lang can select the help language used in the front panel: English. All messages, contextual help, and help topics are displayed in the language of your choice.

Voice



When pressing keys on the front panel or soft keys, you can hear the disabled or enabled card tower sound.

You can also enable or disable sounds (Beeper On or Off) associated with the following functions:

Display options

Display Options can be configured to display.



You can enable or disable the display and adjust the brightness (10 to 100%). If you turn off the display, press any of the keys on the front panel to turn it on again.

By default, after eight hours of inactivity, the screensaver turns off and the display does not display.

The display will be automatically enabled when the power is turned off and on again, after the instrument is reset, or when returning to local operation (front panel). Press the [Local] key or from the remote interface to return to the local state.

Date/Time

Date/Time allows you to set the real-time clock of the instrument. The clock is always in 24-hour format (00:00:00 to 23:59:59). There are no automatic date and time settings, such as daytime time-saving adjustments. Use the front panel arrow keys to set the year, month, day, hour, and minute.

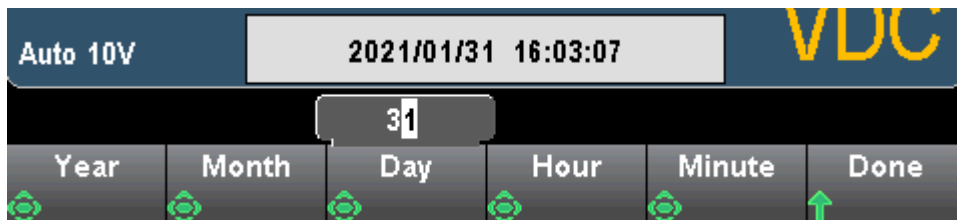

Chapter 3 Measurement Guidance

Instructs you on how to eliminate possible errors in measurement to obtain accurate measurement results. This chapter reads as follows:

- Precautions for DC measurement
- Noise suppression
- Precautions for resistance measurement
- True RMS AC measurement
- Precautions for capacitance measurement

Precautions for DC measurement

Thermoelectric EMF error

Thermoelectric voltage is the most common error source in low level DC voltage measurement. Thermal voltages are generated by connecting circuits using heterogeneous metals at different temperatures. Each connection between the metals will form a thermocouple which will generate a voltage proportional to the connection temperature as shown in the table below. You should minimize thermocouple voltage and temperature variations during low level voltage measurements. The best connection can be made by pressing the copper wire to the copper wire.

Load error (DC voltage)

Measurement load errors occur when the resistance of the device-under-test (DUT) is a significant proportion of the input resistance of the multimeter itself. The following figure is a schematic diagram of this error source.

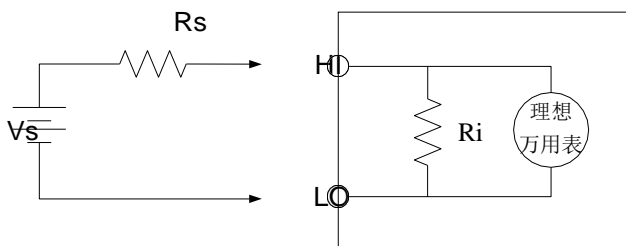

V_S = ideal DUT voltage

RS = DUT source resistance

Ri = multimeter input resistance (10MΩ or >10GΩ)

$$\text{Error (\%)} = \frac{100 \times R_s}{R_s + R_i}$$

If you want to reduce the load error effect and reduce the noise interference, for 100 mVDC, 1VDC and 10 VDC range, the input impedance of a multimeter can be set to "> 10 G Ω", for 100 VDC and 1000 VDC range, will remain at 10 M Ω input resistance.

Noise Rejection

Rejecting power line noise voltage

One of the advantages of the integrated analog-to-digital (A/D) converter is its ability to reject the power line related noise that exists in the DC input signal. This feature is known as normal noise rejection, or NMR. The multimeter realizes normal noise rejection by integrating the average DC input over a fixed time period. If the integration time is set to integer multiples of the power supply line period (PLC), these errors (and their harmonics) will be averaged close to zero.

The multimeter offers three integral options (1, 10 and 100 PLC) for normal noise suppression. The multimeter first measures the power supply frequency (50 Hz or 60 Hz) and then determines the corresponding integration time. A complete list of normal noise suppression, increased RMS noise approximation, read rate, and resolution for each integral setting.

Common Mode Rejection (CMR)

Ideally, the multimeter is completely isolated from the ground - based circuit. However, there is some resistance between the multimeter input LO terminal and the ground, as shown in the figure below. This creates an error in measuring the low voltage floating with respect to the ground.

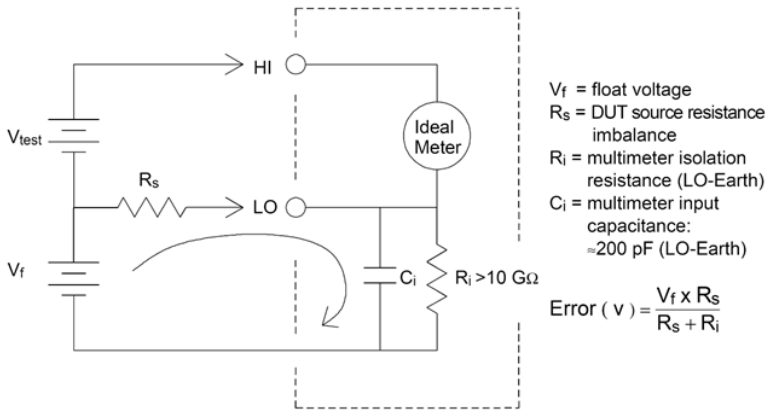

Noise caused by ground loop

If the multimeter and the device under test are connected to the same common ground point, measuring the voltage in this circuit will form a "ground loop". As shown below, any voltage difference (V_{ground}) between two ground reference points will cause current to flow through the measuring lead. This results in noise and offset voltage (usually associated with the power supply line), which is added to the measured voltage.

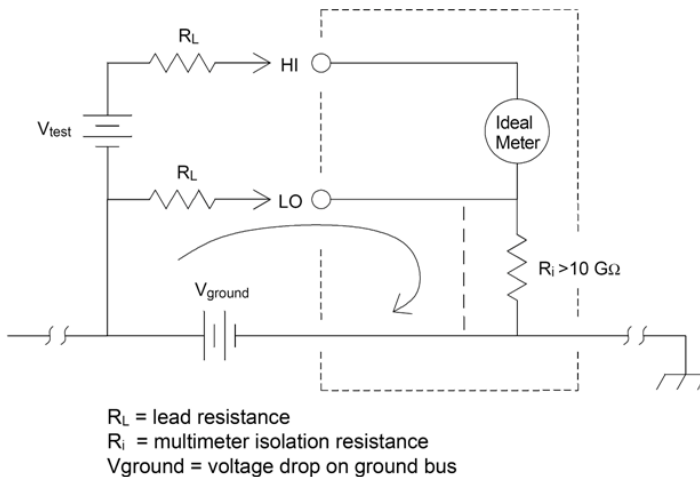

The best way to eliminate the ground loop is to isolate the multimeter from the ground by not grounding the input terminals. If the multimeter must be ground-based, connect it to a common ground point with the device under test. If possible, also connect the multimeter and the device under test to the same power outlet.

Precautions for resistance measurement

The multimeter provides two resistance measurements: 2-wire and 4-wire resistance measurement. In both methods, the test current flows from the high end of the input to the resistance under test. For 2-wire resistors, the voltage across the measured resistor will be internally induced to the multimeter. Therefore, the resistance of the test lead is also measured. For 4-wire resistors, separate "induction" connections are required. Since no current flows through the induction leads, the resistance in these leads does not cause measurement errors.

Measuring small resistances using the 4-wire method gives the most accurate results because it reduces the resistance of the test leads and contacts. This method is usually used to automated tests where there is impedance and/or a long cable, a large number of connections or switches between the multimeter and the DUT. The recommended 4-wire resistance measuring wiring is shown below.

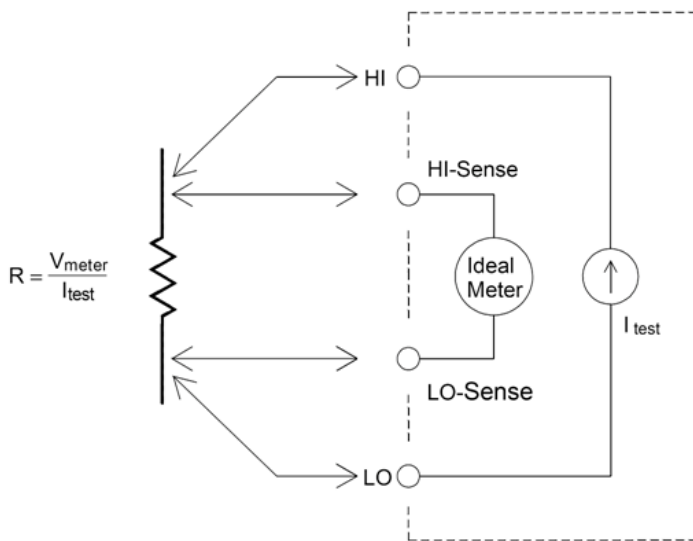

Eliminate test lead resistance errors

To eliminate the offset error associated with the test lead resistance in the 2-wire resistance measurement, follow these steps:

Short the two ends of the test lead together and then read the resistance of the test lead shown.

Press Null. The multimeter saves the test lead resistance as the null value of the 2-wire resistance and subtracts this value from future measurements.

Minimize the power impact

When measuring resistors for temperature measurement (or resistors with large

temperature coefficients, be aware that the multimeter will dissipate some power on the device under test.



If power consumption is a problem, a higher fixed range should be chosen (all multimeter models). In low power mode, the test current applied for each measurement range for the standard resistance measurement is less than the normally applied test current to reduce power consumption and self-heating in the DUT.

True RMS AC measurement

The AC measurement of **HDM3000** has true RMS response. The average heating power of a resistor over a period of time is proportional to the square of the effective value of the voltage applied to the resistor over that period of time, have nothing to do with the waveform. If the energy outside the effective bandwidth of the multimeter is negligible in the voltage or current waveform, the **HDM3000** can accurately measure its RMS. **The HDM3000** has an effective AC voltage bandwidth of 300 kHz and an effective AC current bandwidth of 10 kHz.

The AC voltage and AC current functions of the multimeter measure "AC coupling" true RMS, i.e., the RMS of the measured AC component of the signal (the DC component is filtered out). As shown in the table below, since sine, triangular, and square waves (50% duty cycle) do not contain a DC offset, their AC RMS are equal to AC+DC RMS.

Table: True RMS AC measurement of sine wave, triangle wave and square wave

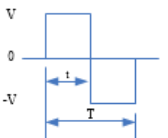
Waveform	Crest Factor (C.F.)	AC RMS	AC+DC RMS
 <p>A sine wave plotted on a coordinate system with vertical axis 'V' and horizontal axis '0'. The wave oscillates symmetrically above and below the zero line.</p>	$\sqrt{2}$	$\frac{V}{\sqrt{2}}$	$\frac{V}{\sqrt{2}}$
 <p>A triangular wave plotted on a coordinate system with vertical axis 'V' and horizontal axis '0'. The wave has a positive peak and a negative peak of equal magnitude, forming a triangle.</p>	$\sqrt{3}$	$\frac{V}{\sqrt{3}}$	$\frac{V}{\sqrt{3}}$
 <p>A square wave plotted on a coordinate system with vertical axis 'V' and horizontal axis '0'. The wave alternates between a positive level 'V' and a negative level '-V'. The pulse width is labeled 't' and the period is labeled 'T'.</p>	1	$\frac{V}{C.F.}$	$\frac{V}{C.F.}$

Asymmetric waveforms, such as pulse trains, contain DC components that are filtered out by AC-coupled true RMS measurements.

AC coupled true RMS measurements are ideal for measuring small AC signals with DC offset, such as AC ripple measurements in DC power supply output. However, in some cases it is necessary to measure AC+DC RMS values. At this point, the DC and AC components of the signal can be measured respectively using the DC and AC voltage functions, and then the AC+DC RMS can be calculated according to the following formula. DC voltage measurements need to use 6.5 bit accuracy to achieve the best AC suppression.

$$RMS_{(AC+DC)} = \sqrt{AC^2 + DC^2}$$

True RMS accuracy and high frequency signal components

A common misconception is that because the AC multimeter measures true RMS, its sine wave accuracy index applies to all waveforms. In fact, the waveform of the input signal can have a significant impact on the measurement accuracy of any multimeter, especially when the input signal contains high-frequency instrument bandwidth.

For example, consider the waveform that is most challenging for a multimeter, the pulse train. The pulse width of the waveform largely determines the high frequency component. The spectrum of a single pulse is determined by its Fourier integral. The spectrum of the pulse train is a Fourier series sampled along the Fourier integral at a frequency multiple of the input pulse repetition frequency (PRF).

The following figure shows the Fourier integral of two very different pulses: one has a wide band width (200 μ s); The other has narrow bandwidth (including 6.7 μ s). The bandwidth of ACV path in digital multimeter is 300 kHz. Therefore, frequency components above 300 kHz cannot be measured.

Note that the spectrum sine (π fT)/ π fT of the narrow pulse is clearly beyond the effective bandwidth of the instrument. Therefore, the accuracy of the final measurement results of the narrow high-frequency pulse is low.

In contrast, the spectrum of the wide pulses is significantly reduced to the 300kHz (approximate) bandwidth of the multimeter, so the measurement of such pulses is more accurate.

Reducing PRF can increase the line density in the Fourier spectrum and increase the proportion of the input signal spectrum energy in the bandwidth of the multimeter, thus improving the accuracy.

In summary, when there is a large input signal energy at frequencies above the bandwidth of the multimeter, the error in the RMS measurement will increase.

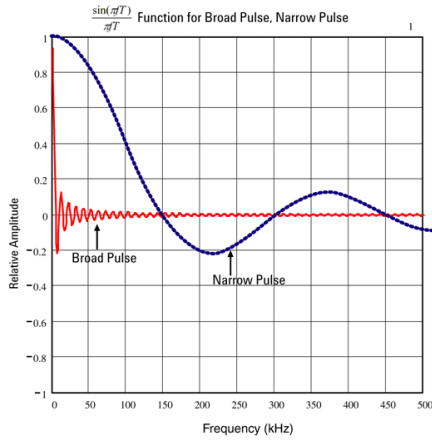

Capacitance

As shown in the figure below, the multimeter measures capacitance by applying a known current to charge the capacitor and then discharging the capacitor by applying a resistor:

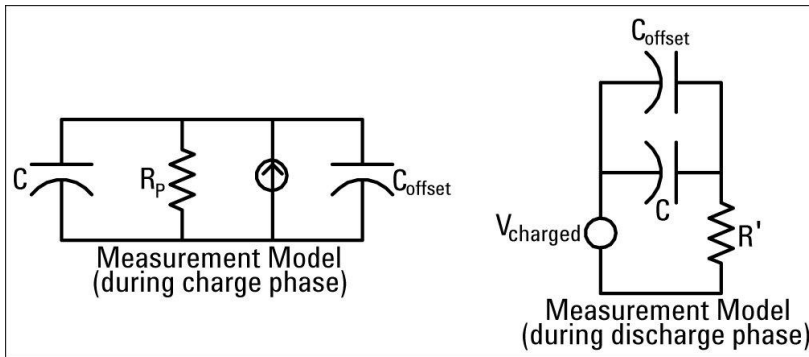

The response curve during charging is shown as follows:

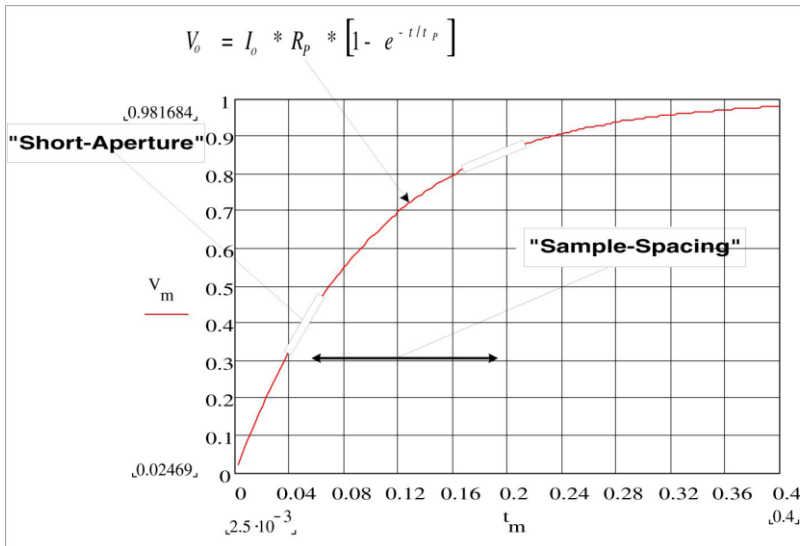

The capacitance is calculated by measuring the voltage change (DV) that occurs during the "short aperture" period (Dt). The measurement was repeated at two different time periods during which the exponential rise occurred. The algorithm extracts data from these four points and calculates the exact capacitance value by linearizing the exponential rise that occurs during the "short aperture" period.

The measurement cycle consists of two parts: the charging stage (as shown in the figure) and the discharge stage. The time constant in the discharge stage is larger because of the protective resistor in the measuring loop. The time constant plays an important role in the resulting read rate (measurement time). To minimize noise and increase reading accuracy, the increment time (or "sampling time") and the width of the "short aperture" vary with the range.

For maximum accuracy, a zeroing measurement should be performed using an open probe to eliminate capacitance in the test lead prior to connecting the probe to the capacitor under test.

Precautions for capacitance measurement

Capacitors with high power factor or other non-ideal characteristics can affect capacitance measurements. Capacitors with a high power factor can make a difference in the measurement when using a multimeter and some other single-frequency methods of LCR meters. The single-frequency method can also be used to detect additional variations in different frequencies. For example, some inexpensive capacitance replacement boxes measured using the multimeter will have a difference of about 5% compared to the same capacitance measured using the single-frequency method of an LCR meter. **LCR** meters will display different values at different frequencies.

Capacitors with a large time constant (dielectric absorption) will slow down the measurement stability and take several seconds to stabilize. You may find this when the

capacitor is first connected or when the measured delay time changes. In general, high quality thin film capacitors have the lowest probability of this condition, electrolytic capacitors have the highest probability, and ceramic capacitors generally have the probability of this condition in between.

Chapter 4 Calibration and adjustment steps

Instructs you how to implement calibration adjustments to obtain

accurate measurement results. This chapter is as follows

- The calibration process
- The calibration procedure

The calibration process

This section covers the procedure for adjusting (calibrating) the performance of the instrument.

Note: It is not possible to calibrate the diode or continuity separately because these functions are based on calibrated resistance measurements. In addition, there is no way to calibrate the gate timing because this function is controlled by digital logic. Capacitance gain cannot be calibrated.

Precautions for Testing

During self-testing, an error may be raised if an AC signal appears on the input lead. If the

test lead is too long, it can also cause AC signal display.

To optimize performance:

- Ensure that the calibration ambient temperature (TCAL) is constant and between 18 °C and 28 °C. The ideal calibration temperature should be 23 °C, fluctuating 2 °C.
- Ensure that the ambient relative humidity is below 80%.
- The connecting copper cable requires a preheating time of 90 minutes.
- Connect the input cable shields to the ground. Connect the calibrator LO source to the ground in addition to the where noted in the procedures. It is important to avoid a ground loop by connecting the LO to the ground at only one point in the circuit.

Because the instrument is capable of very precise evaluation, you must be extra careful to ensure that the calibration standards and test procedures used do not cause other errors. Ideally, the criteria used to validate and adjust equipment should be more accurate than the error specifications for equipment of all sizes.

For 2-wire resistance measurements, take a null measurement with a short-circuited lead or high precision 4 terminal low thermal short-circuit to remove wire resistance. For zero offset calibration, a 4 terminal low thermal short circuit is required.

Recommended testing equipment

The recommended testing equipment for performance verification and calibration is listed below. If the required equipment is not available, replace it with a calibration standard with the same accuracy.

application	Recommended equipment
Zero calibration	High precision 4 terminal low thermal short-circuit
The DC voltage	Fluke5720A
The DC current	Fluke5720A
resistance	Fluke5720A
The AC voltage	Fluke5720A
The AC current	Fluke5720A
frequency	Fluke5720A
High current	Fluke5725A
Capacitance (optional)	Sca-1uf capacitor standard

Gain and flatness calibration adjustment overview

The instrument will store the new flatness correction constant whenever this procedure is executed. The flatness constant adjusts the digital multimeter for AC voltage and AC current measurements over the entire available input frequency band. The flatness constant is calculated by the calibration value entered for the calibration command and by automatic measurement during calibration.

Each range and frequency should be calibrated in the order shown.

Flatness Calibration Considerations

Before starting gain calibration, the ADC and zeroing calibration adjustment procedures must have been recently performed. Flatness calibration can be performed using either the front or rear input terminals. Make sure the Front/Rear switch matches the terminal being used.

Note: Do not turn off the instrument during gain or flatness calibration. This may cause the current function of the calibration memory to be lost.

Gain calibration

The instrument does gain calibration for calculation and memory of each input value. The gain constant is calculated from the calibration value entered for the calibration command and by automatic measurement during calibration.

Most measurement functions and ranges have gain calibration procedures, and calibration should be performed for each function in the order shown.

Gain calibration effective range

function	range	Valid calibration of input values
DCV	100 mV ~ 100 V	0.9 ~ 1.1× full scale
	1000V	900 V to 1050 V
DCI, ACI	100 μ A ~ 1 A	0.9 ~ 1.1× full scale
	3A	2.7 A ~ 3.03 A
	10A	9 A ~ 11 A
ACV	100 mV ~ 100 V	0.9 ~ 1.1× full scale
	1000V	195 V ~ 770 V
Ω 2 w, Ω 4 w	100 Ω ~ 10 M Ω	0.9 ~ 1.1× full scale
	100 M Ω	Open circuit
CAP	1 nF - 100 μ F	0.9 ~ 1.1× full scale
FREQ	10V	2Vrms ~ 11Vrms/9.5kHz ~ 25kHz

The calibration procedure

The following calibration procedure applies to **HDM3000 DMM**. Perform the calibration procedure in the order listed in this document.

1. SelfTest and reset-to-zero calibration
2. DC voltage gain calibration
3. DC current gain calibration
4. Ohmic gain calibration
5. AC voltage gain and flatness calibration
6. AC current gain and flatness calibration
7. Frequency accuracy calibration
8. Capacitance offset calibration (optional)
9. Complete calibration

SelfTest and reset-to-zero calibration

Each time you perform a reset-to-zero calibration, the instrument stores a new set of offset correction constants for each measurement function and range. The instrument automatically sorts all required functions and ranges and stores the new reset-to-zero offset calibration constants. Automatically determine all offset corrections.

Note: Do not turn off the instrument during the reset-to-zero calibration. This may cause all calibration memories to be lost.

SelfTest and Zero Calibration Process

Be sure to allow instrument to be preheated and stabilize for 90 minutes before performing calibration. The reset-to-zero calibration includes DCV, DCI, RES, FRES, ACV, ACI, CAP.

CAP needs to be open circuit for zero calibration.

1. Follow the steps listed below.
2. Select **SelfTest ([Utility] > Test/Admin > SelfTest)**.

Note: Before going through this step, ensure that all input terminals are in the no-load state.

3. The display displays a message indicating that the SelfTest calibration is in progress. The results of the SelfTest calibration are then displayed.

A **Succeeded** message indicates that the calibration succeeds. If the display displays **Failed**, check the input value, range, function, and the entered calibration value, and repeat the calibration steps.

4. This process uses a low-heat short circuit block mounted on the input connector. For HDM3000, two short circuit blocks are recommended. One is on the front panel and one is on the back panel. Short-circuit is suitable for DCV, DCI, RES, FRES, ACV, ACI zero calibration.



5. Select the front panel input terminal. Install the short circuit block on the front panel input terminal.
6. Select the DCV measurement function. Range=100mV, Sign=Pos, Value= 0.
7. Press **Start**.
8. The reset-to-zero calibration lasts for approximately two minutes. The message **Calibration Step Succeeded** indicates success.

If the display shows **Calibration Step Failed**, check the input value, range, function, and the input calibration value and repeat the Calibration Steps.

9. Choose the rear input terminal. Install the short circuit block on the rear panel input terminal.
10. Repeat steps 4 to 9 for the rear input terminal.
11. Switch **DCI, RES and FRES** to complete DC zero calibration.

Note: Zero calibration for all ranges under the same function is completed in one time, so there is no need for repeated calibration.

DC voltage gain calibration

Configuration: DC voltage

1. Configure each function and range in the order shown in the table below.
2. Apply the input signal shown in the Input column.
3. Input the input voltage range of the actual application. The message **Calibration Step Succeeded** indicates success. If the display shows **Calibration Step Failed**, check the input value, range, function, and the input Calibration value and repeat the Calibration Step.
4. Repeat steps 1 through 3 for each gain calibration point shown in the table.

The calibration points of **HDM3000** are as follows:

gear	Calibration point 1	Calibration point 2
100mV	-100mV	100mV
1V	-1V	1V
10V	-10V	10V
100V	-100V	100V
1000V	-1000V	1000V

DC current gain calibration

Configuration: DC current

1. Configure each function and range in the order shown in the table below.
2. Apply the input signal shown in the Input column.
3. Input the actual input current as the calibration value. The message **Calibration Step Succeeded** indicates success. If the display shows **Calibration Step Failed**, check the input value, range, function, and the input calibration value and repeat the calibration step.
4. Repeat steps 1 to 3 for each gain calibration point shown in the table.

The calibration points of **HDM3000** are as follows:

gear	Calibration	Calibration
------	-------------	-------------

	point 1	point 2
100uA	-100uA	100uA
1mA	-1mA	1mA
10mA	-10mA	10mA
100mA	-100mA	100mA
1A	-1A	1A
3A	-3A	3A
10A	-10A	10A

Ohms Gain Calibration

Configuration This procedure adjusts the gain of the 2-wire and 4-wire resistor functions as well as the offset compensation resistor functions.

1. Configure each function and range in the order shown in the table below.
2. Apply the input signal shown in the Input column.
3. Enter the input resistance for the actual application (see Input calibration values). The message **Calibration Step Succeeded** indicates success. If the display shows **Calibration Step Failed**, check the input value, range, function, and the input calibration value and repeat the calibration steps.
4. Repeat steps 1 to 3 for each gain calibration point shown in the table.

The calibration points of **HDM3000 FRES** are as follows:

gear	Calibration point 1
100 Ω	100 Ω
1 K Ω	1 K Ω
10 K Ω	10 K Ω
100 K Ω	100 K Ω
1 M Ω	1 M Ω
10 M Ω	10 M Ω
100 M Ω	Input HI short circuits Sense HI. Input LO short circuits Sense LO.

AC voltage gain and flatness calibration

Configuration: AC voltage

1. Configure the ranges shown in the following table.
2. Apply the input signal shown in the Input column.
3. Input the input voltage range for the actual application. The message **Calibration Step Succeeded** indicates success. If the display shows **Calibration Step Failed**, check the input value, range, function, and the input calibration value and repeat the

calibration steps.

- Repeat steps 1 to 3 for each flatness calibration point shown in the table.

6_{1/2} DMM calibration points are as follows:

	Range linearity calibration	Low frequency flatness calibration	High frequency flatness calibration				
gear	Calibration point 1	Calibration point 2	Calibration point 3	Calibration point 4	Calibration point 5	Calibration point 6	Calibration point 7
100mV	100mV@1KHz		100mV@20KHz	100mV@50KHz	100mV@100KHz	100mV@150KHz	100mV@300KHz
1V	1V@1KHz		1V@20KHz	1V@50KHz	1V@100KHz	1V@150KHz	1V@300KHz
10V	10V@1KHz	10V@10Hz	10V@20KHz	10V@50KHz	10V@100KHz	10V@150KHz	10V@300KHz
100V	50V@1KHz		50V@20KHz	50V@50KHz	50V@100KHz	50V@150KHz	50V@300KHz
750V	750V@1KHz		750V@20KHz	750V@50KHz	750V@100KHz	140V@150KHz	70V@300KHz

5_{1/2} DMM calibration points are as follows:

	Range linearity calibration		High frequency flatness calibration		
gear	Calibration point 1	Calibration point 2	Calibration point 3	Calibration point 4	Calibration point 5
100mV	20mV@1KHz	100mV@1KHz	100mV@20KHz	100mV@50KHz	100mV@100KHz
1V	0.2 V @ 1 KHz	1V@1KHz	1V@20KHz	1V@50KHz	1V@100KHz
10V	2V@1KHz	10V@1KHz	10V@20KHz	10V@50KHz	10V@100KHz
100V	20V@1KHz	100V@1KHz	100V@20KHz	100V@50KHz	100V@100KHz
750V	200V@1KHz	750V@1KHz	300V@20KHz	300V@50KHz	300V@100KHz

Note: Gain and flatness calibration can be done with front and rear terminals. Make sure the Front/Rear switch matches the terminal being used.

AC Current Gain and Flatness Calibration

Configuration: AC current

- Configure the ranges shown in the following table.
- Apply the input signal shown in the Input column.
- Input the input current range for the actual application. The message **Calibration**

Step Succeeded indicates success. If the display shows **Calibration Step Failed**, check the input value, range, function, and the input calibration value and repeat the calibration steps.

4. Repeat steps 1 to 3 for each frequency shown in the table.
5. Repeat steps 1 to 4 for each current range shown in the table.

6^{1/2} DMM calibration points are as follows:

gear	Range linearity calibration		
	Calibration point 1	Calibration point 2	Calibration point 3
100uA	100uA@1KHz	100uA@10KHz	
1mA	1mA@1KHz	1mA@10KHz	
10mA	10mA@1KHz	10mA@10KHz	
100mA	100mA@10Hz	100mA@1KHz	100mA@10KHz
1A	1A@1KHz	1A@10KHz	
3A	3A@1KHz	3A@10KHz	
10A	10A@1KHz	10A@10KHz	

5^{1/2} DMM calibration points are as follows:

gear	Range linearity calibration	
	Calibration point 1	Calibration point 2
100uA	30uA@1KHz	100uA@1KHz
1mA	0.2 mA @ 1 KHZ	1mA@1KHz
10mA	2mA@1KHz	10mA@1KHz
100mA	20mA@1KHz	100mA@1KHz
1A	0.2 A @ 1 KHZ	1A@1KHz
3A	0.6 A @ 1 KHZ	3A@1KHz
10A	2A@1KHz	10A@1KHz

Frequency Accuracy Calibration

Configuration: Frequency, 10 V range

1. Configure the measuring frequency under 10 V and 10 kHz, 1 s gated time conditions.
2. A 10 kHz sine wave should be applied between 9 and 11 Vrms.
3. Input the input frequency for the actual application. The message **Calibration Step Succeeded** indicates success. If the display shows **Calibration Step Failed**, check the input value, range, function, and the input calibration value and repeat the calibration steps.

Capacitance offset calibration (optional)

In general, this calibration is not required. This procedure usually compensates for residual capacitance offsets that are less than a few pF. In normal use, any residual offset is overwritten by the null function (the null function also corrects the cable capacitance), and it is also required to use the null function to implement the capacitance specification of the multimeter.

Configuration: capacitance

1. Remove all connections from the front terminal of the instrument.
2. Select the front terminal.
3. Enter the calibration value +0. The message **Calibration Step Succeeded** indicates success; If the display shows **Calibration Step Failed**, check the input value, range, function, and the input Calibration value and repeat the Calibration Step.
4. Repeat steps 1 through 3 for the rear terminal of the instrument.
5. Select each range in the order shown in the table below.
6. Apply each input current shown in the Input column.
7. Input the actual input capacitance as the calibration value. The message **Calibration Step Succeeded** indicates success. If the display shows **Calibration Step Failed**, check the input value, range, function, and the input calibration value and repeat the calibration steps.
8. Repeat steps 5 through 7 for each frequency shown in the table.

The HDM3000 CAP calibration points are as follows:

gear	Calibration point 1
1nF	1nF
10nF	10nF
100nF	100nF
1uF	1uF
10uF	10uF
100uF	100uF

Chapter 5 Remote Control

USB Communication

Connect the Type-A end of the USB cable to the computer, and connect the Type-B end to the USB port on the back of the DMM. A new device will be displayed in the computer device manager.

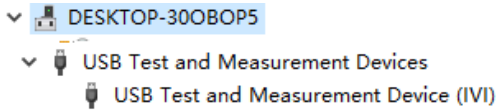

Install the IO driver:

Click the following URL to download the latest IO software:

<https://www.keysight.com/main/software.aspx?ckey=2175637&lc=chi&cc=CN&nid=-11143.0.00&id=2175637>

Double-click the application to start the installation. According to the installation prompts, install step by step, the installation process may take several minutes.

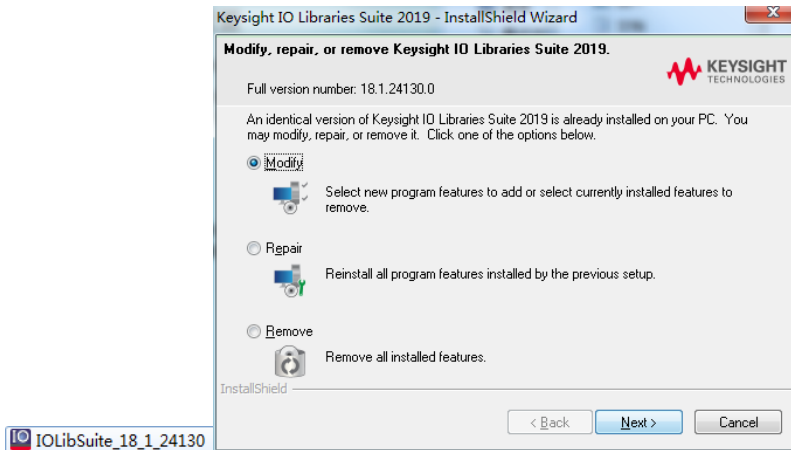

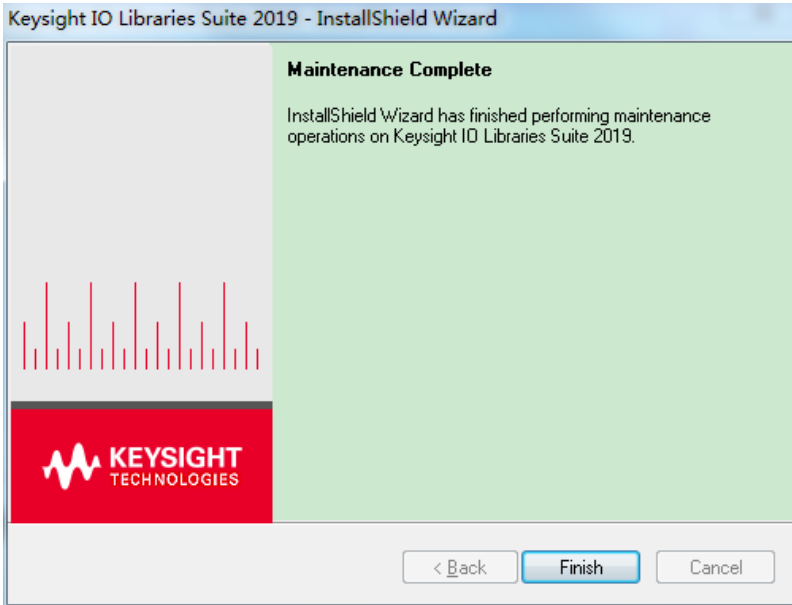

After installation, you can see the running IO software in the lower right corner of the screen.

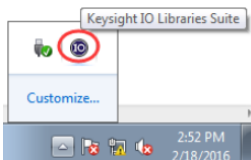

Double-click to open the IO software, you can see the connected device information displayed under My Instrument-USB.

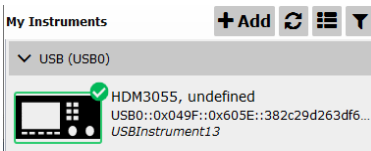

Click "Interactive IO", send an instruction arbitrarily, and the computer and the oscilloscope will communicate.

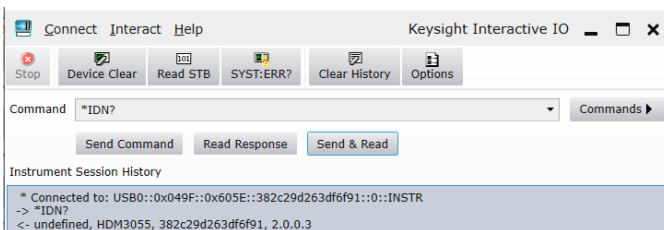

Double-click "HDM3000.EXE" to install the software.



Click “Next” to finish the software install.

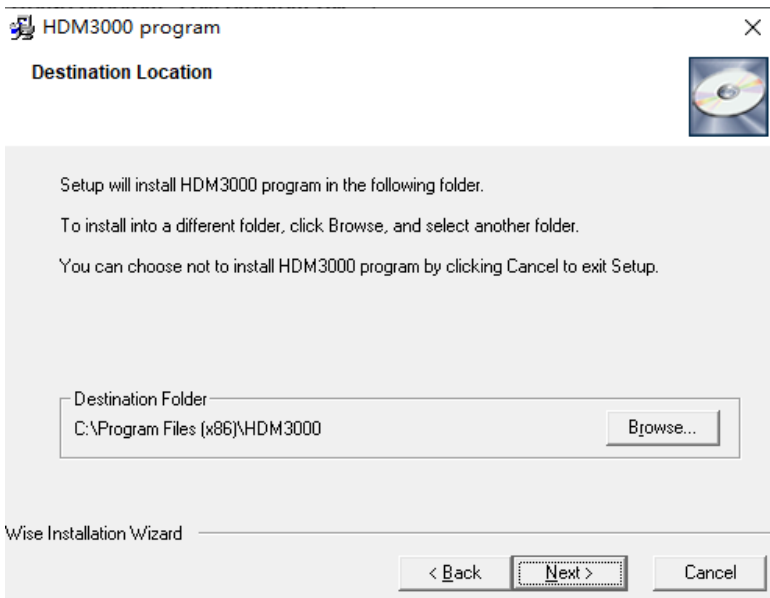
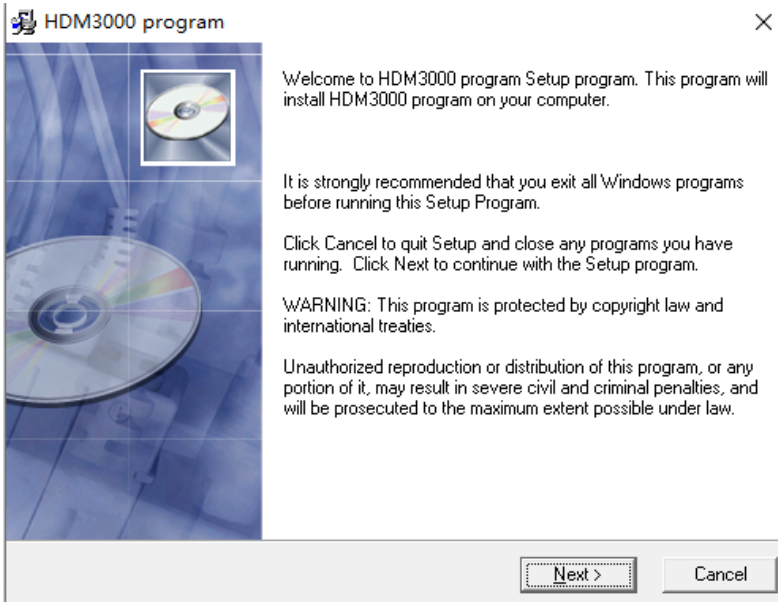

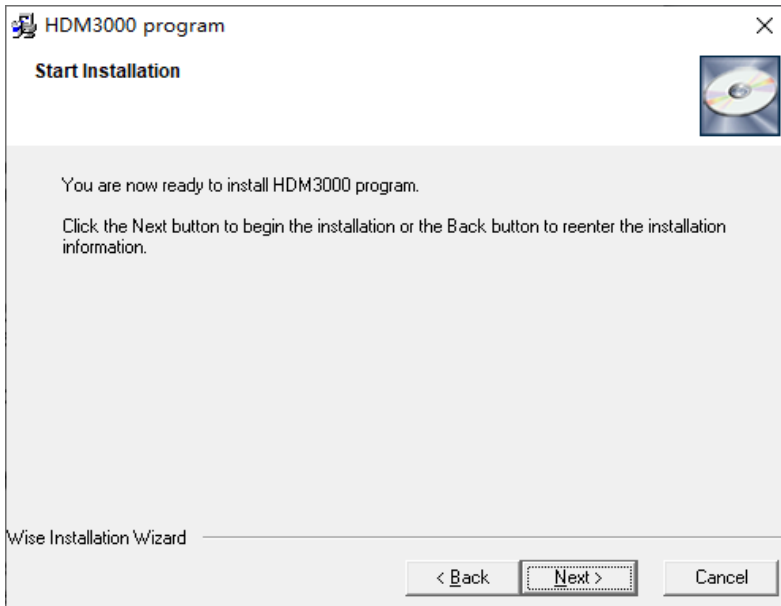

Double-click the software shortcut to open the host computer software, At this point, the host computer has been connected.





LAN Communication

The procedure for LAN communication is as follows:

Connect one end of the network cable to the computer and the other end to the back-end LAN port of the multimeter. To set the HDM3000, click Shift+Display to access the I/O Config page in the Utility.

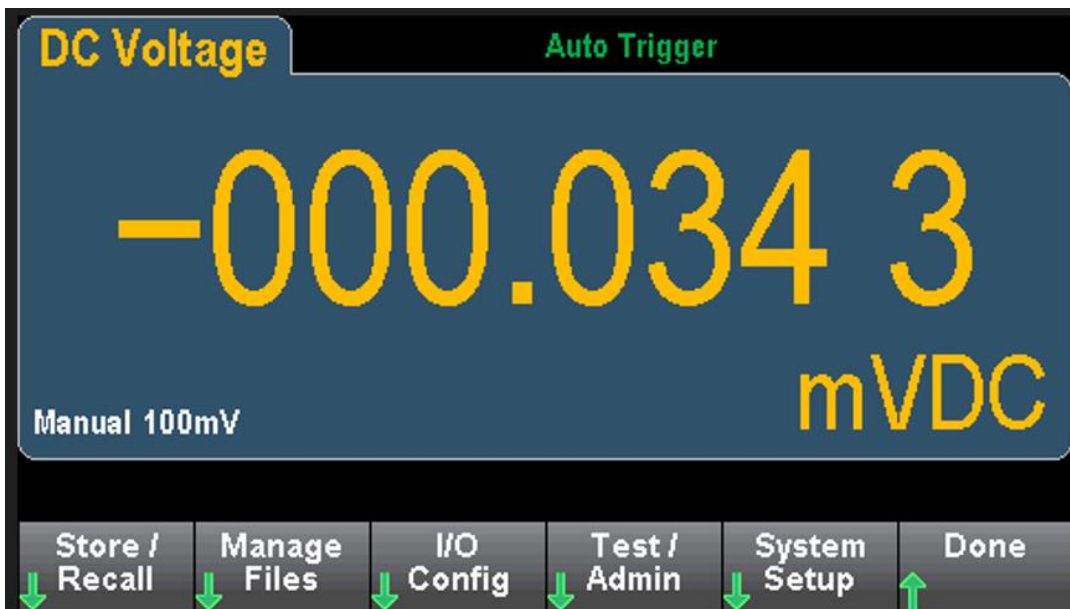

Set LAN Settings. Set IP Mode to Static, set IP Addr and Gateway manually, and click Apply. "Set IP address successfully" is displayed, indicating that the IP address is

successfully set.



Manually change the IP address of the computer to the same network segment as the DMM.

Open IO, select “LAN instrument” in “Manual Configuration”, and enter the IP Addr of HDM3000 in “Hostname or IP Address” of “Set LAN Address”.

“Set Protocol” select Socket: Port Number: 5025

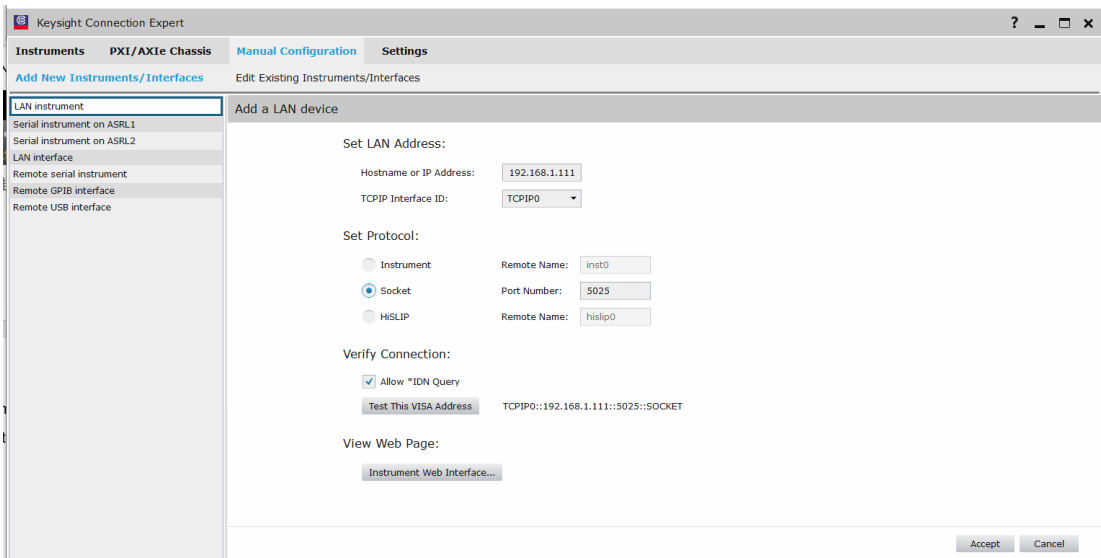

Click Verify connection: “Test This VISA Address”, verify that the connection is successful.

Set LAN Address:

Hostname or IP Address:

TCPIP Interface ID:

Set Protocol:

Instrument Remote Name:

Socket Port Number:

HiSLIP Remote Name:

Verify Connection:

Allow *IDN Query

TCPIP0::192.168.1.153::5025::SOCKET

Verified

hantek,hdm3065b,cn2243013000775

Click Accept, and the new device is automatically generated in the Instruments column.

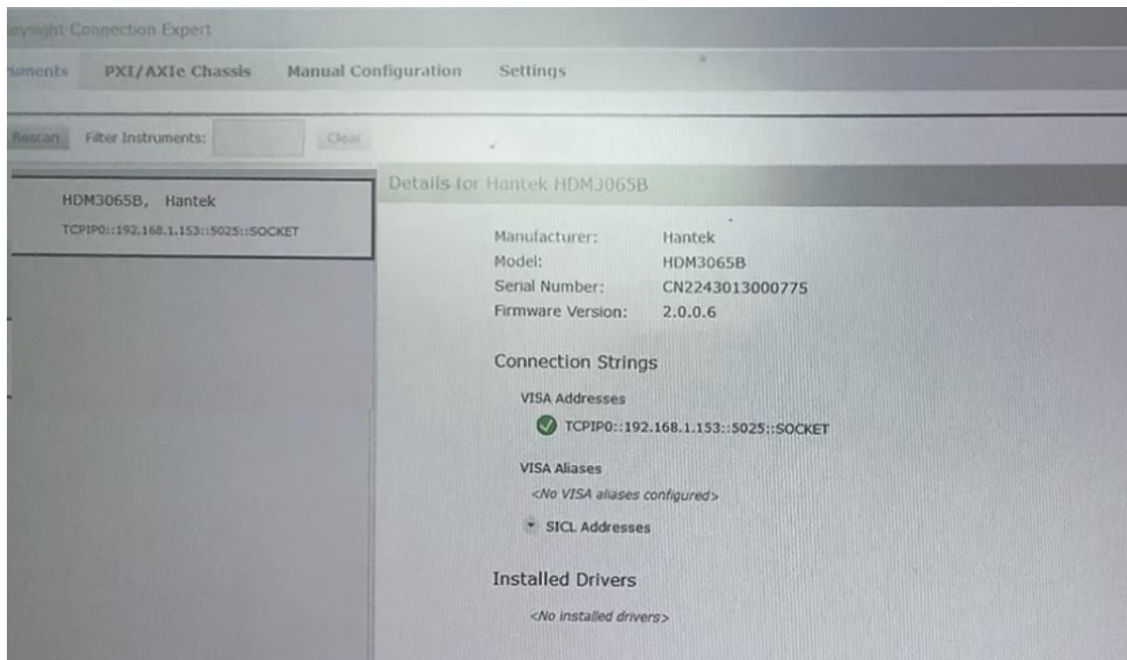

If IP Mode is set to DHCP in LAN Settings in Step 2, You do not need to manually Set IP Addr and Gateway. Click Apply. The router connected to the DMM automatically assigns IP addresses to the DMM. After the assignment is successful, the message "Set IP

address successfully" is displayed, if failed, the display is "Map IP address failed!". If the DHCP assignment failed, the original IP address of the DMM is not changed.

After the DHCP IP address is successfully assigned, the communication between DMM and PC is as the IP Mode Static.

Chapter 6 Appendix

Appendix A: HDM3000 Digital Multimeter Annex

	Description
model	HDM3000 (6 ½ (5 ½) bit, dual display)
The standard accessories	The power cord
	2 watch pens (black and red)
	2 alligator clips (black and red)
	USB cable
	Resource CD-ROM (with user manual and application software)

Note: For all standard accessories and optional accessories, please order from local agent or distributor of Qingdao Hantek Electronic Co., Ltd.

Appendix B: Warranty Summary

Qingdao Hantek Electronic Co., LTD. commits that its instrument host is without any material and process defects in the product warranty period. During the warranty period, if the product is proved to be defective, Qingdao Hantek Electronic Co., Ltd. will repair or replace the product free of charge. For full repair service or warranty instructions, please contact Qingdao Hantek Electronic Co., Ltd.

Other than the warranties provided by this summary or any other applicable warranty card, Qingdao Hantek Electronic Co., Ltd. does not provide any other warranties, express or implied, including, but not limited to, any implied warranties of merchantability and fitness for special purposes of the products. In no event shall Qingdao Hantek Electronic Co., LTD be liable for indirect, special or consequential damages.

