



User Manual

# **Programmable DC Power Supply**

**HDP43XX/44XX Series**

**V 1.1**

## Copyright Statement

### Copyright

Qingdao Hantek Electronic Co., Ltd.

### Statement

Qingdao Hantek Electronic Co., Ltd. reserves the right to amend this document without prior notice. Qingdao Hantek Electronic Co., Ltd. promises that the information provided is correct and reliable, but does not guarantee that this document is infallible. Please make sure that the specifications of relevant technical documents used are the latest and valid version yourself before using this product. If you require the cooperation of products, patents or works of a third party when your company using the documents or products of Qingdao Hantek Electronic Co., Ltd., your company shall be responsible for obtaining the consent and authorization of the third party. The aforesaid consent and authorization are not the responsibility of our company to guarantee.

## Technical Support

If you have any question or ambiguity in the process of using products of Qingdao Hantek Electronic Co., Ltd., you can get the service and support through the following ways:

A: Please contact the local dealer of Qingdao Hantek Electronic Co., Ltd.;

B: Please contact the local office directly under Qingdao Hantek Electronic Co., Ltd.;

C: Please contact the headquarters of Qingdao Hantek Electronic Co., Ltd.

Contact Method of our company:

Qingdao Hantek Electronic Co., Ltd.

<http://www.hantek.com/en/index.html>

Address: 35# Building No.780 Baoyuan Road, High-tech District, Qingdao China

Zip Code: 266114

Telephone: 0532-55678770

Fax: 0532-88705691

Email: [service@Hantek.com](mailto:service@Hantek.com)

Technical Support:

Telephone: 0532-55678772

Email: [support@Hantek.com](mailto:support@Hantek.com)

## Summary of general safety matters

### General Safety Summary

Read the following safety precautions carefully to avoid injury and prevent damage to this product or any product connected to this product. To avoid possible danger, be sure to use this product as specified.

#### Avoid fire and personal injury.

Only professionally authorized personnel should perform repairs.

#### Use the correct power cord.

Use only the power cord specified for this product in your country.

#### Connect and disconnect properly.

Select the correct AC power input gear and input the AC voltage within its allowable range. Please turn off the power before connecting to the output terminal. Before powering off the instrument, disconnect the load it carries and then power off.

#### Ground the product.

To avoid electric shock, the product is grounded through the grounding conductor of the power cord. The grounding conductor must be connected to ground. Before connecting the input or output of the product, be sure to ground the product properly.

#### View all terminal ratings.

To avoid fire or the impact of excessive current, check all ratings and markings on the product. Please consult the product manual for details on ratings before connecting the product.

#### Use proper overvoltage protection.

Make sure that no over voltages (such as those caused by lightning) reach the product. Otherwise, the operator may be exposed to electric shock.

#### Do not open the cover.

Do not operate the product with the cover or panel open.

#### Maintain proper ventilation.

Poor ventilation will increase the temperature of the instrument and cause damage to the instrument. Good ventilation should be maintained during use, and the vents and fans should be checked regularly.

#### Use a suitable fuse.

Only use fuses specified for this product.

**Avoid exposed circuits.**

Do not touch exposed connectors and components after power is turned on.

**Do not operate the product if you suspect it is malfunctioning.**

If the user suspects that this product has been damaged, have it inspected by qualified service personnel.

**Do not operate in a humid environment.**

To avoid the danger of short circuit or electric shock inside the instrument, do not operate the instrument in a humid environment.

**Do not operate in a flammable or explosive environment.**

To avoid damage to the instrument or personal injury, do not operate the instrument in a flammable or explosive environment.

**Keep the surface of the product clean and dry.**

To prevent dust or moisture in the air from affecting the performance of the instrument, keep the product surface clean and dry.

**Anti-static protection.**

Static electricity can cause damage to the instrument. Test in an anti-static area whenever possible. Before connecting the cable to the instrument, ground its inner and outer conductors briefly to discharge static electricity.

**Pay attention to handling safety.**

In order to avoid the instrument falling down during transportation, which may cause damage to the buttons, knobs, or interfaces on the instrument panel, please pay attention to transportation safety.

## **Safety terms and symbols**

Product terminology. The following terms may appear on the product:

---

**DANGER**

It indicates that if you do this, you may cause immediate damage to the user.

**WARNING**

It indicates that the user may not immediately harm the user if they do this.

**CAUTION**

It indicates that the user may cause damage to this product or other property if this operation is performed.

---

Product symbol: The following symbols may appear on the product:



Safety Warning



Protective Test



Ground Shell



Earth Terminal

---

## Ventilation requirements

Make sure that the exhaust area is not blocked and has free flowing air. To ensure adequate ventilation, when using the power supply in a workbench or rack, make sure that there should be a gap of at least 10 cm on both sides, above, and behind it.

**WARNING**

Poor ventilation will increase the temperature of the instrument and cause damage to the instrument. Good ventilation should be maintained during use. Regularly check the vents and fans.

---

## Working environment

### Temperature

During operation: 0°C to 50°C

Non-operating: -40°C to 70°C

### Humidity

0°C to 30°C: 95% relative humidity.

30°C to 40°C: 75% relative humidity.

40°C to 50°C: 45% relative humidity.

**WARNING**

To avoid the danger of short circuit or electric shock inside the instrument, do not operate the instrument in a humid environment.

---

### Altitude

When operating: below 3000 meters.

Non-operating: below 15000 meters.

## Daily maintenance and cleaning

### Daily maintenance

When storing or placing the oscilloscope, do not expose the LCD monitor to direct sunlight for a long time.

**CAUTION**

To avoid damaging the oscilloscope or probe, do not place it in mist, liquid or solvent.

---

**Clean**

According to the requirements of operating conditions, check the oscilloscope and probe frequently. Please clean the outer surface of the instrument according to the following steps:

Use a lint-free cloth to remove dust from the outside of the oscilloscope and probe. Be careful not to scratch the smooth display filter.

Clean the oscilloscope with a soft cloth dampened with water. For more thorough cleaning, use 75% isopropyl alcohol in water.

---

**CAUTION**

To avoid damaging the surface of the oscilloscope or probe, do not use any corrosive or chemical cleaning agents.

---

**Equipment recycling**

Production of this equipment requires the extraction and use of natural resources. If this product is not disposed of properly, some of the substances contained in the device may be harmful to the environment or human health. To avoid release of harmful substances into the environment and reduce the use of natural resources, it is recommended that this product be recycled by appropriate methods to ensure that most materials can be reused correctly.

## Contents

<b>COPYRIGHT STATEMENT.....</b>	<b>2</b>
<b>TECHNICAL SUPPORT.....</b>	<b>3</b>
<b>SUMMARY OF GENERAL SAFETY MATTERS.....</b>	<b>4</b>
General Safety Summary.....	4
Safety terms and symbols.....	5
Ventilation requirements.....	6
Working environment.....	6
Daily maintenance and cleaning.....	6
Equipment recycling.....	7
<b>CONTENTS.....</b>	<b>8</b>
<b>INTRODUCTION.....</b>	<b>10</b>
<b>CHAPTER 1 QUICK START.....</b>	<b>11</b>
<b>1. Check before use.....</b>	<b>11</b>
1.1 Check the shipping package.....	11
1.2 Check the whole machine.....	11
1.3 Check the accessories.....	11
<b>2. Front Panel Introduction.....</b>	<b>11</b>
<b>3. Rear Panel Introduction.....</b>	<b>13</b>
<b>4. User Interface.....</b>	<b>14</b>
4.1 Main interface.....	14
4.2 Meter View.....	15
4.3 Data logger view.....	16
4.4 Help system.....	17
<b>CHAPTER 2 GETTING STARTED.....</b>	<b>18</b>
<b>1. Check the AC voltage range.....</b>	<b>18</b>
<b>2. Check the fuse.....</b>	<b>18</b>
<b>CHAPTER 3 FUNCTION INTRODUCTION.....</b>	<b>19</b>



---

<b>1. Output voltage and current.....</b>	<b>19</b>
<b>2. Over protection.....</b>	<b>20</b>
<b>3. Channel delay.....</b>	<b>20</b>
<b>4. Output coupling.....</b>	<b>21</b>
<b>5. Output inhibit.....</b>	<b>21</b>
<b>6. Operation Mode.....</b>	<b>22</b>
6.1 Independ.....	22
6.2 Series.....	22
6.3 Parallel.....	22
6.4 Tracking.....	23
<b>7. Output list.....</b>	<b>23</b>
<b>8. Data logger.....</b>	<b>26</b>
<b>9. Remote control.....</b>	<b>28</b>
9.1 USB remote control.....	28
9.2 LAN remote control.....	29
9.3 RS232/485 remote control.....	32
9.4 GPIB remote control.....	33
<b>10. Utilities.....</b>	<b>34</b>
10.1 Store/recall.....	34
10.2 I/O setting.....	35
10.3 Setup.....	37
10.4 Error message.....	37
10.5 Capture.....	37
<b>11. Lock/Unlock.....</b>	<b>38</b>
<b>CHAPTER 4 TROUBLESHOOTING.....</b>	<b>38</b>
<b>CHAPTER 5 PERFORMANCE INDEX.....</b>	<b>39</b>

## Introduction

HDP43XX/44XX is a programmable DC power supply. It has a user-friendly interface design, excellent performance indicators, a variety of communication interfaces to meet the different needs of users, and a variety of analysis functions to meet the diverse needs of users.

### Main Feature:

- 4.3-inch TFT display
- Series and parallel output
- High performance: accuracy, transient response and linear adjustment rate
- Built-in Chinese and English help system
- Digital IO interface, support trigger input/output function
- Support SCPI programmable command control
- Waveform display function, real-time dynamic display of output voltage/current waveform, with the digital display of voltage, current and power values, so that users can see the output status and trend of the instrument at a glance
- OV/OC/OT protection function
- Keyboard lock function to prevent misoperation
- Voltage tracking function
- Delay switch function
- One-key restore preset state function
- Support store and recall
- A variety of interface configurations to meet the needs of users
- Support U disk storage

# Chapter 1 Quick Start

Taking the three-channel power supply as an example, this chapter will briefly describe and introduce the front panel, rear panel, user interface, help system, and precautions when using the instrument for the first time. In this way, users can become familiar with this series of power supplies in the shortest possible time.

## 1. Check before use

### 1.1 Check the shipping package

If you find that the packaging carton or foam protection pad is severely damaged, please keep it until the whole machine and accessories pass the electrical and mechanical tests.

### 1.2 Check the whole machine

If you find that the appearance of the instrument is damaged, the instrument is not working properly, or the performance test fails, please contact the dealer responsible for this business.

### 1.3 Check the accessories

Please check the accessories according to the product packing list. If you find the accessories are missing or damaged, please contact the dealer responsible for this business.

## 2. Front Panel Introduction



1. LCD Display screen

2. Restore default settings

3. Help

Used to quickly get relevant help on the use of the instrument.

4. USB Host

Used for firmware upgrade or external file saving.

5. Auxiliary function soft keys

Operate according to the screen display.

6. Channel Button

Press to select the current channel. Then you can directly set the voltage and current of the current channel.

7. Power button

8. Common ground terminal

9. Output terminal

10. Output control keys

Turn the output on or off.

11. ALL ON/OFF key

Turn on all or turn off all output channels.

12. Voltage/current adjustment knob

Finely adjust the voltage/current, and the adjustment accuracy is 1mV/1mA.

13. Arrow keys

Use the arrow keys to move the cursor position up, down, left, and right.

14. Numeric keypad

Enter the value directly, press the "Enter" key to confirm, and press the "x" key to delete.

15. Function keys

Meter View: Display the Meter View of the selected channel.

Tracking: Turn on or off the tracking mode of channel 1 and channel 2.

Store/Recall: Open the store/recall menu.

### 3. Rear Panel Introduction

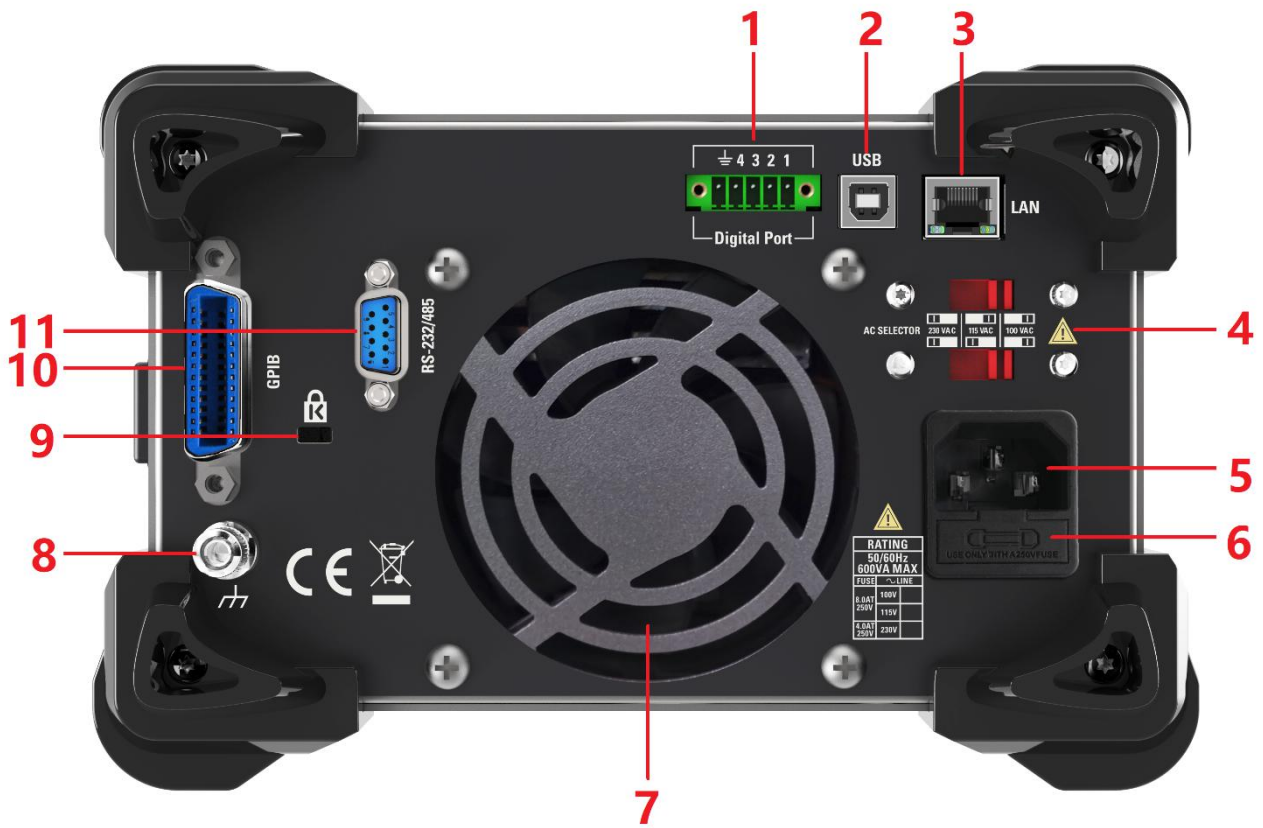

1. Digital IO interface
2. USB interface
3. LAN interface
4. AC selector
5. Power jack
6. Fuse holder
7. Exhaust fan
8. Ground reference point
9. Safety lock
10. GPIB interface
11. RS-232/485 interface

## 4. User Interface

### 4.1 Main interface

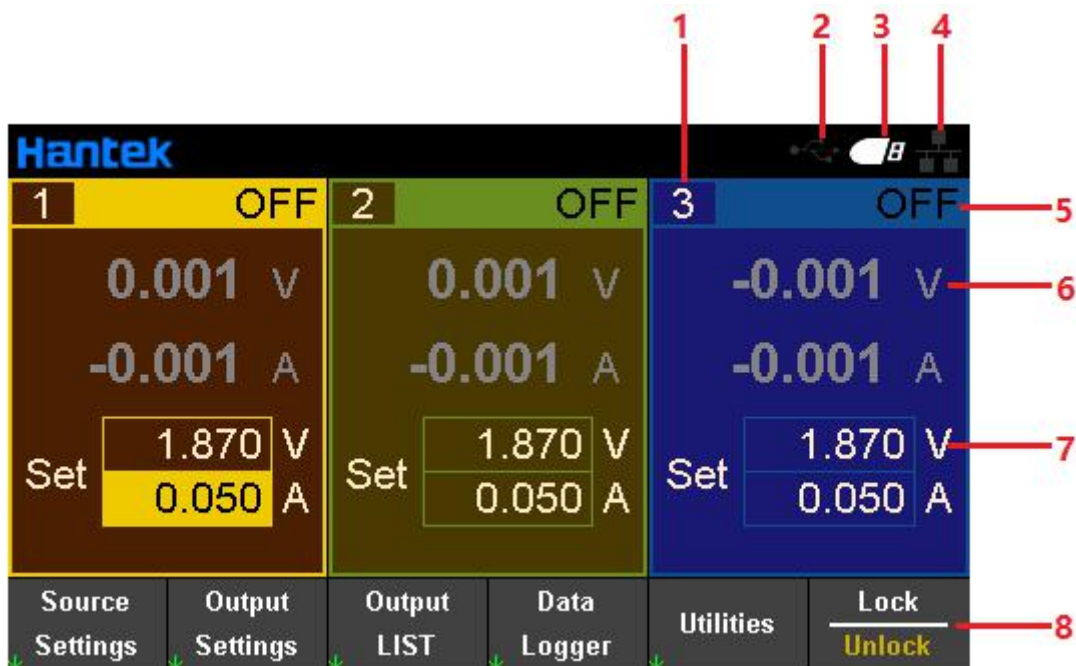

#### 1. Output channel indication

When an output channel is selected, the background of the corresponding channel is highlighted.

#### 2. USB device icon display

#### 3. U disk icon display

#### 4. Network icon display

#### 5. Output status/ mode

OFF: output is off;

CV: Constant voltage mode: The output voltage is equal to the set voltage value. The output current value is equal to the voltage setting value divided by the load resistance value. If the load current exceeds the set current value, it will change to constant current mode.

CC: Constant current mode: the output current is equal to the set current value. The output voltage value is equal to the current setting value multiplied by the load resistance value. If the load voltage exceeds the set voltage value, it will become a constant voltage mode.

OV: Overvoltage protection;

OC: Overcurrent protection;

OT: Over temperature protection;

LT: Low temperature protection. The sensor is lower than  $-10^{\circ}\text{C}$ , which may be due to environmental problems too low, or the sensor is damaged. So channels are forbidden to output. When the hardware restored to normal, this phenomenon is eliminated.

MV: If voltage out of control, it may be the adjustment tube is damaged. So channels are forbidden to output. After reset and restart, this phenomenon is eliminated.

LE: May be that the 220V supply voltage inputs to the device of the 110V input configuration, in which case the channels is forbidden to output. When the hardware restored to normal, this phenomenon is eliminated.

6. The actual output voltage and current value of the channel

7. User-set voltage and current values

8. Auxiliary Menu Bar

## 4.2 Meter View

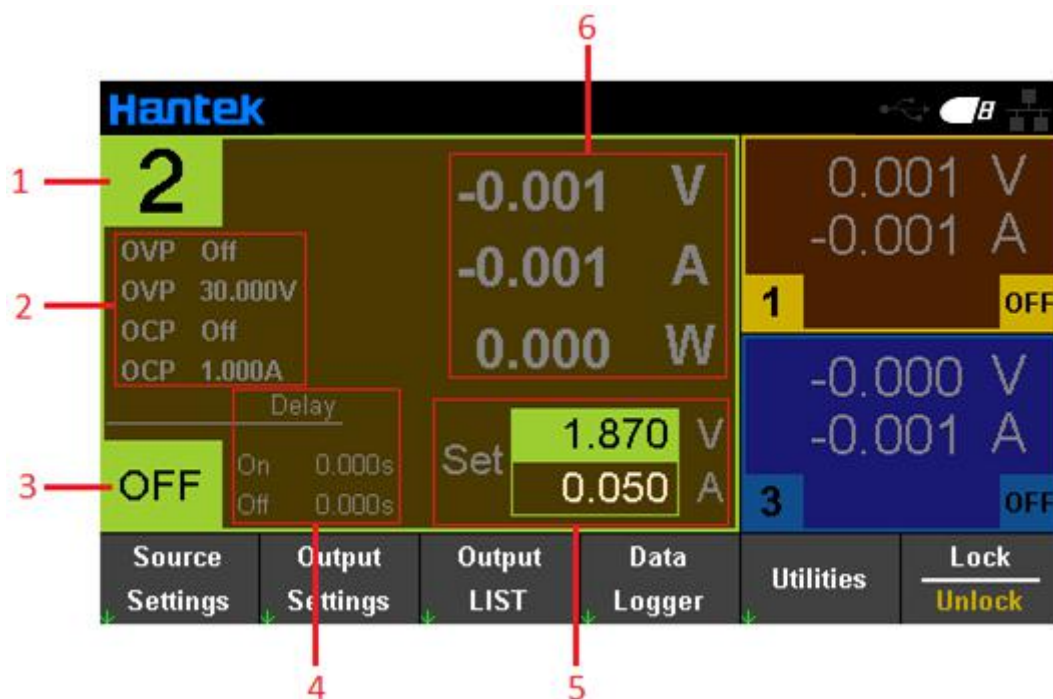

1. The serial number of the currently selected channel
2. Over-protection status and set value
3. The output status/mode of the currently selected channel
4. Set time for channel delay to open or close
5. User-set voltage and current values
6. The actual output voltage and current value of the channel

### 4.3 Data logger view



#### 1. Tracking parameters

All parameters of all channels can be tracked and displayed. Press the "Enter" key to turn on or off the tracking display of a single parameter. The display "----" after the parameter indicates that the tracking of the parameter has been turned off.

#### 2. Tracking parameter identification

The corresponding tracking parameters are displayed on the tracking curve. Voltage, current, and power are expressed as V, I, and P respectively.

#### 3. Recording time

Display the current data recording duration.

#### 4. Track and record progress

The length of the data visible on the display screen.

#### 5. Horizontal time base

Display the time represented by each grid in the horizontal direction.

#### 6. Horizontal offset time

Display the offset time in the horizontal direction.

#### 7. Grid time

Display the time of the current specified point on the corresponding grid.



## 4.4 Help system

The help list can help users quickly understand the instrument. Press "About" to view product information, including product model, serial number, etc.

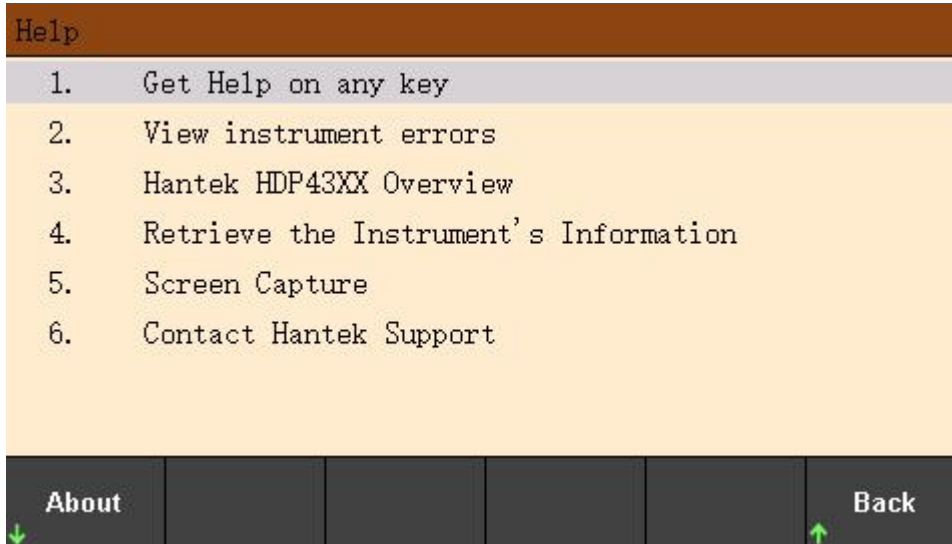

This series of programmable DC power supplies provide help information for any key on the front panel and any menu key. You can long press any key to get help information, use the up and down arrows to turn pages, and press the "Back" button to exit the help system. The user can view the operation tips of each function at any time during the use process.

## Chapter 2 Getting Started

This chapter introduces the items that users need to pay attention to when starting to use this series of programmable DC power supplies in order to carry out subsequent operations smoothly.

### 1. Check the AC voltage range

This series of programmable DC power supplies support various specifications of AC power input, and users can choose the appropriate input gear according to actual needs. The user must check the gear position of the AC voltage selector on the rear panel of the power supply before using it, and the input voltage must be within the allowable range ( $\pm 10\%$ ) of the gear position. The corresponding relationship between the voltage selector on the rear panel of the power supply and the allowable input voltage is as follows:

RATING				
50/60Hz				
600VA MAX				
FUSE	LINE			
8.0AT 250V	100V	230 VAC	115 VAC	100 VAC
	115V			
4.0AT 250V	230V			

### 2. Check the fuse

The instrument has been installed with the specified fuse at the factory. Before use, please check whether the fuse type matches the AC voltage range. If it does not match or the fuse is blown, replace the fuse according to the specifications.

#### **Steps to replace the fuse:**

1. Turn off the power and unplug the power cord;
2. Lift out the fuse holder;



3. Remove the broken fuse and install a new one;
4. Put the fuse holder back into the slot.

## Chapter 3 Function Introduction

This chapter will introduce in detail the following functions of this series of programmable DC power supplies:

- [Output voltage and current](#)
- [Over protection](#)
- [Channel delay](#)
- [Output coupling](#)
- [Output inhibit](#)
- [Operation mode](#)
- [Output list](#)
- [Data logger](#)
- [Remote control](#)
- [Utility function](#)
- [Lock/unlock](#)

### 1. Output voltage and current

The output voltage and current can be directly input in the main interface, or set in "Source Settings" and "Meter View".



**Setting steps:**

1. Select the output channel

Press the digital channel button on the front panel, or continuously press the left "<" and right ">" arrows to select the output channel to be set.

2. Set voltage/current:

Press the arrow keys to select voltage or current, use the numeric keyboard or knob to set the value, press "x" to delete, and press "Enter" to confirm and exit editing.

3. Turn on the output

Press the "On/Off" key to turn on the output.

**2. Over protection**

Set the overvoltage and overcurrent protection in Source Settings.

OV Protection: If the output voltage reaches the voltage protection value, the output status of the channel becomes OV, and the output is disabled;

OC Protection: If the output current reaches the current protection value, the output status of the channel becomes OC, and the output is disabled.

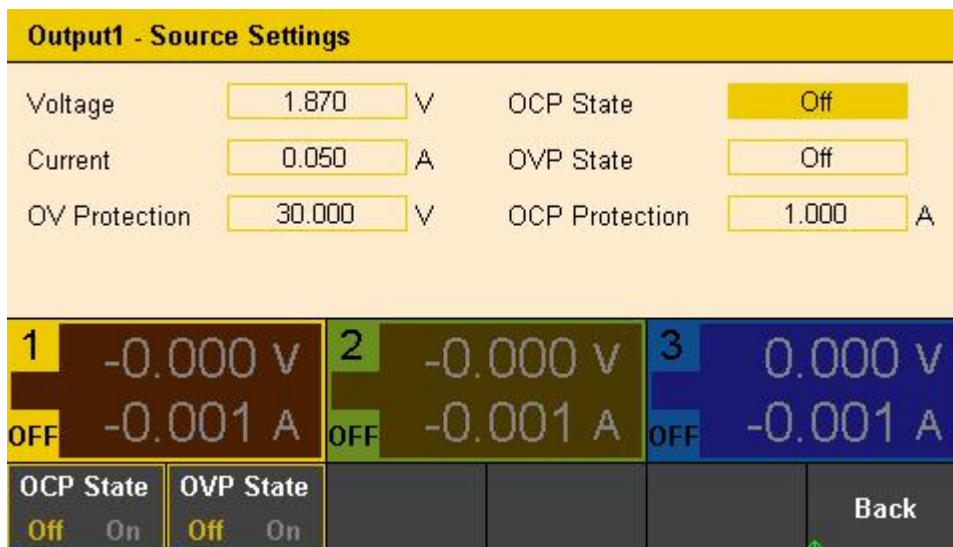

**3. Channel delay**

Set the channel delay in Source Settings, the range of delay that can be set is 0~3600s. After setting the delay, press [All On/Off] on the front panel, and each channel will output and close in the order of delay.

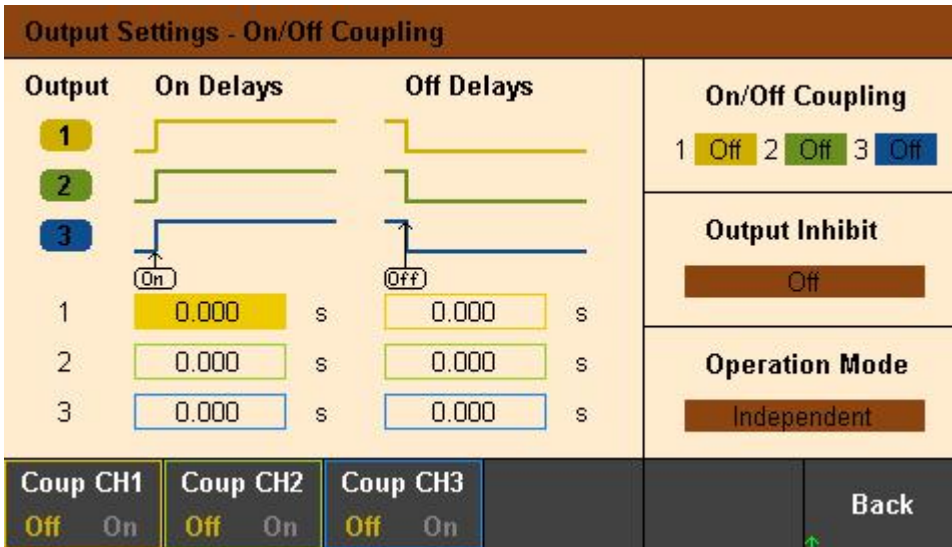

#### 4. Output coupling

Press Source Settings->On/Off Coupling to set the output coupling. After setting the coupling, turn on the output of any one of the channels, and the other coupling channels will be turned on at the same time. If only part of the channel output coupling is set, open the front panel [All On/Off], regardless of whether the channel is set to output coupling, all channels will be turned on.

Note: Single channel output, no need to set output coupling.

#### 5. Output inhibit

Press Output Settings->Output Inhibit to set the inhibition mode (off, latched or live) and DIO Pin3 function.



- ◆ Inhibit Off: Inhibit input is ignored.
  - ◆ Inhibit Latched: Inhibit the transition from True to False in the input state of the external logic signal, and always inhibit the output.
  - ◆ Inhibit Live: Allow the transition of the external logic signal input state from True to False. The output state is determined by the external input signal. When the external input signal is True, the output is disabled; when the external input signal is False, the output is enabled.
  - ◆ DIO Pin3: Can be set to remote inhibit input or digital input.
- INH: Remote inhibit input, the output status of all channels of the power supply can be controlled through external signals.
- DINP: Digital input, you can trigger the input by setting the level of Pin3.

Note: When the output inhibition mode is selected as "Latched", to turn off the output inhibition, you must first switch the "Output Inhibit" to "Live"

## 6. Operation Mode

Press Output Settings->Operation Mode to set the operation mode. For Channel 1 and Channel 2, the operation mode can be set to Independent, Series, Parallel and Tracking. Note: When in series or parallel mode, the output coupling is invalid.

### 6.1 Independ

In the independent mode, the channels are output independently and do not affect each other. The output voltage or current is the set voltage and set current of each channel. The default output of the power supply is independent mode.

### 6.2 Series

In series mode, the channels are internally connected in series to form a single output. The channel 2 window of the main interface displays "SERIES with CH1". Channel 1 is the master and channel 2 is the slave. The "+" terminal of channel 1 and the "-" terminal of channel 2 are the two output terminals of the series circuit. The output voltage is twice the set voltage of channel 1, and the output current is the set current of channel 1. The external wiring method of series mode is as follows:



### 6.3 Parallel

In parallel mode, the channels are internally connected in parallel to form a single output. The channel 2 window of the main interface displays "PARALLEL with CH1". Channel 1 is the master and channel 2 is the slave. The "+" and "-" binding posts of channel 1 are the two output terminals of the parallel circuit. The output current is twice the set current of

channel 1, and the output voltage is the set voltage of channel 1. The external wiring method of parallel mode is as follows:



## 6.4 Tracking

In tracking mode, channel 1 and channel 2 are associated with each other, and the voltages track each other. Changing the set voltage of either channel will change the set voltage of the other channel accordingly; the current of the two channels will not be affected.

Note: When using the tracking function, make sure that the OCP setting of each channel does not affect the normal output of the voltage.

Tracking mode can also be set by long pressing "Tracking" on the front panel, and short pressing "Tracking" to exit. After setting, the "Tracking" logo will be displayed between channel 1 and channel 2 on the main interface.

## 7. Output list

The output list can be output according to the conditions set by the list. Output conditions include trigger point, output duration, output cycle times, etc.







Output 1 - Output LIST Properties					
Voltage/Current After List	Return to DC Value				
Pace	Trigger				
Trigger Source	List Run/Stop Key				
Trigger Delay	0.000				
Repeat Count	1				
	<input type="checkbox"/> Continuous				
<b>V/I List</b>	<b>Pace</b>	<b>Trig Src</b>	<b>Save</b>		<b>Back</b>
DC List	Dwl Trg	Key IO Rmt	Param		↑

◆ Voltage/Current After List: Set the output value after the list output is completed.

Last list value: After the list output is completed, the last list value is output.

Return to DC Value: After the list output is completed, the DC value before the list becomes effective is output.

◆ Pace: Set the output step.

Dwell: Take the dwell time as the pace, the dwell time ends, and enter the next step;

Trigger: After the output is triggered, the dwell time ends, and enter the next step at the external trigger pace.

◆ Trigger Source: Set the trigger source.

List Run/Stop Key: Set the Run/Stop key as the trigger source.

Set the DIO trigger input as the trigger source. After pressing Run/Stop to run the list, the output is triggered by external signal changes. (Note that you need to set the Pin function to Trigger In: Utility->I/O Config->Digital IO).

Remote Command: Set the remote command as the trigger source. After pressing Run/Stop to run the list, send an SCPI command to trigger the output. (For remote interface settings, please refer to [9. Remote Control](#))

For example:

List:trig (@1)      Trigger the list output of channel 1.

◆ Trigger Delay: Set the trigger delay time, the range is 0-3600s.

◆ Repeat Count: Set the repeated output times of the list, the range is 1-255.

◆ Continuous: Press "Enter" key to select whether to output continuously.

#### 4. Run/Stop

Set the output list to run or stop. During operation, the output value is displayed in the corresponding channel of the main interface.

Note: The property cannot be set when the list is "Run". The Run/Stop trigger output is valid only when the trigger source is set to Key. When using the list output, you should turn on the channel output first, and then press "Run/Stop", otherwise the complete list cannot be output.

### 8. Data logger

The data recording function is used to view and record the output voltage, current, and power waveforms and data. This function must be used with the external USB storage device on the front panel, the waveform is displayed on the screen, and the data is directly recorded to the external storage device.

**Data record setting steps:**

Press the "Data Logger" button in the menu bar to enter the data logger setting interface.



1. Select the data output channel and set the output parameters.
2. Set the waveform parameters

All recordable waveform parameters are displayed on the left side of the screen. Press the arrow keys to select the parameter to be recorded, and press Enter to confirm. Press Waveform Settings to set the waveform vertical parameters and horizontal parameters respectively.



Vertical: Set the voltage/current/power value represented by the unit grid in the vertical direction of the displayed waveform, the setting range is 10uV~50V/10uA~50A/10uW~50W, press "Volts/Div +", "Volts/Div -" or "Amps/Div +", "Amps/Div -" or "Watts/Div +", "Watts/Div -" keys to adjust the size, the step is 1-2-5.

Press "Offset +", "Offset -" to set the vertical offset of the displayed waveform.



Horizontal: Set the horizontal offset of the displayed waveform. Press "Offset +", "Offset -" to set the offset. The default horizontal time base is 5s/div.

### 3.Properties property settings

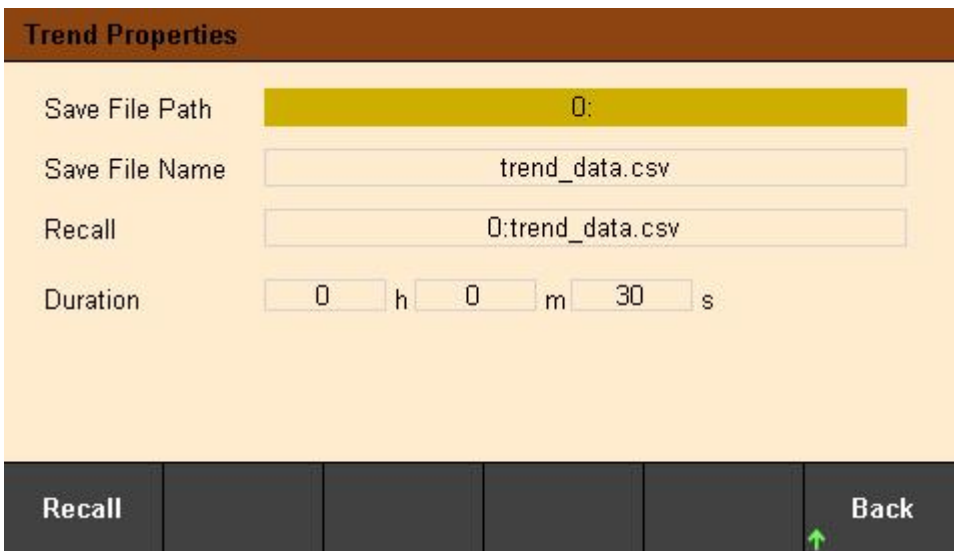

◆ Save File Path: Set the file save path. Press the Enter key to enter the file system list, press the up and down arrow keys to browse the files, and press the Select key to select the file path.

◆ Save File Name: Set the save file name. Press Enter to recall the soft keyboard, press the up, down, left, and right arrow keys to select characters to edit the file name, and press Done to confirm and exit. Press Cancel to exit editing directly.



Clear All: Clear all characters.

Delete Char: Delete the previous character.

Previous Char: Move the cursor forward one character.

Next Char: Move the cursor one character back.

◆ Recall: Recall the wave file. An external storage device must be connected to use this function. Press Enter to view the file system list, use the up and down arrow keys to select the file to be recalled. The file type that can be recalled is a .csv file, and press Enter again to confirm. Press the Recall key to execute the recall, and the waveform is immediately displayed in the record table.

◆ Duration: Set the data recording time.

4.Auto Scale: Auto configuration.

The system automatically adjusts the waveform display trajectory.

5.Run/Stop: Run or stop waveform recording.

## 9. Remote control

### 9.1 USB remote control

Use the USB cable to connect the USB port on the back of the computer to the USB port on the rear panel of the power supply. At this time, the USB connected logo is displayed on the upper right corner of the main interface of the power supply.



Download and install the IO software from the following address:

<https://www.keysight.com/main/software.aspx?ckey=2175637&lc=chi&cc=CN&nid=-11143.0.00&id=2175637>

Open the IO software, find the device, and send an instruction to see if the communication is normal. After normal communication is obtained, SCPI commands can be used to control the power output.

E.g:

OUTP On, (@1)	Set the channel 1 output on.
Volt 5, (@1)	Set the voltage of channel 1 to 5V.
Meas:volt? (@1)	View the output voltage value of channel 1.

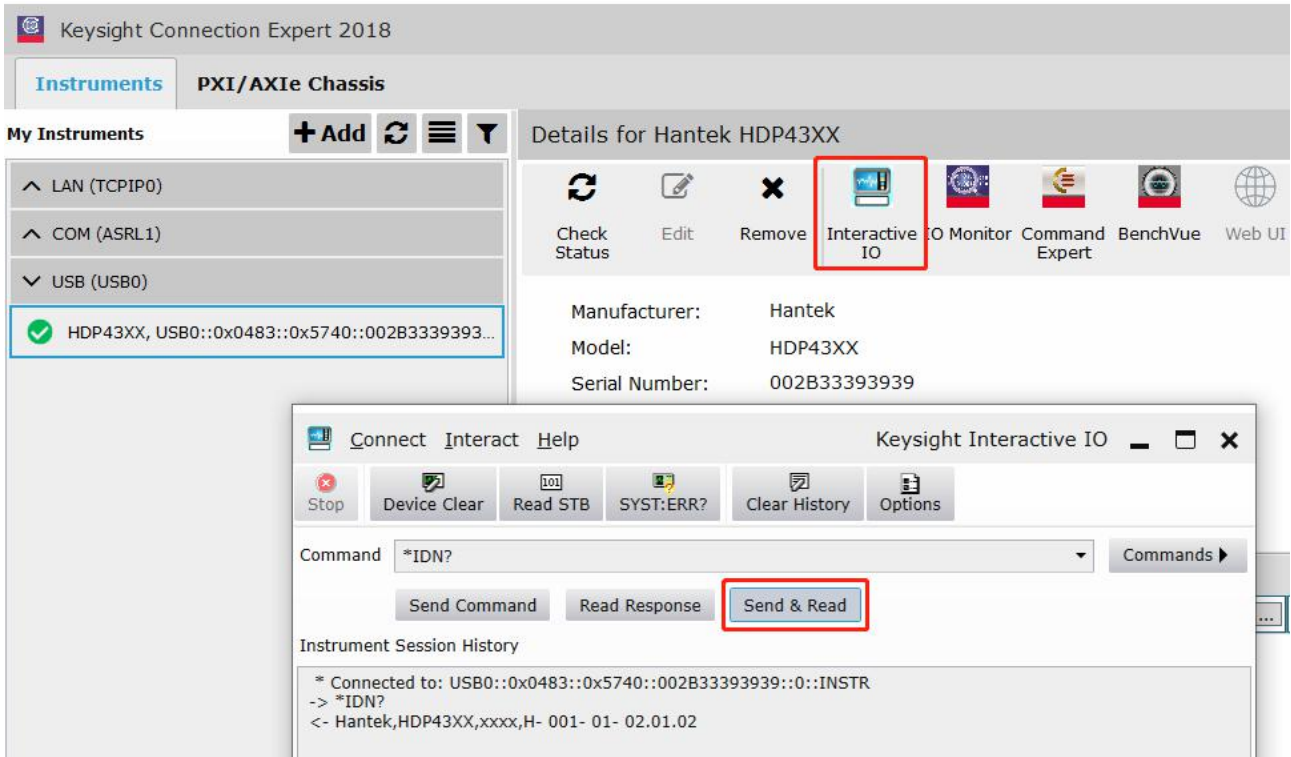

## 9.2 LAN remote control

Connect the back-end network port of the computer to the network port on the rear panel of the power supply with a LAN network cable.

Utility→I/O Config→LAN Settings to set the power supply LAN parameters.

Press Load menu to load settings, as shown in the figure below:

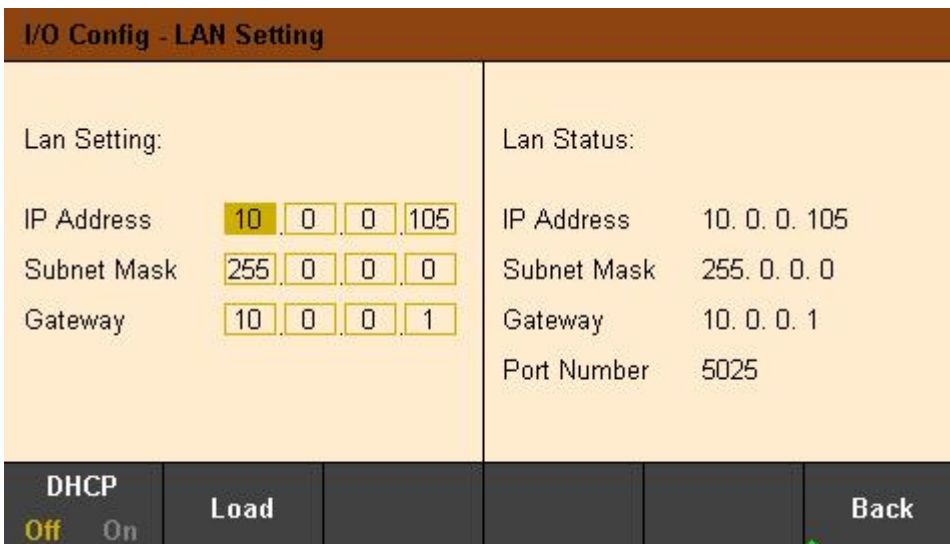

Please configuration of computer IP and other information manually. Set computer Ethernet properties:

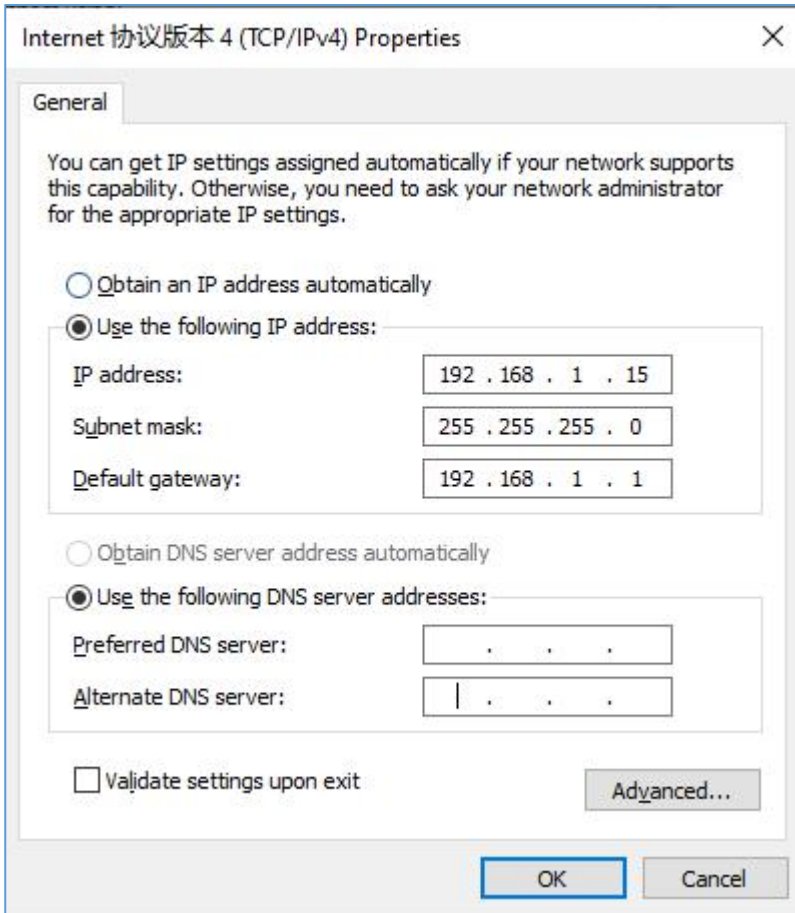

After the connection is successful, open the IO software and the device will appear in the LAN list. If the device does not appear, you can manually add the device, enter the device's IP address and protocol, test the VISA address, and click OK to add a new device.

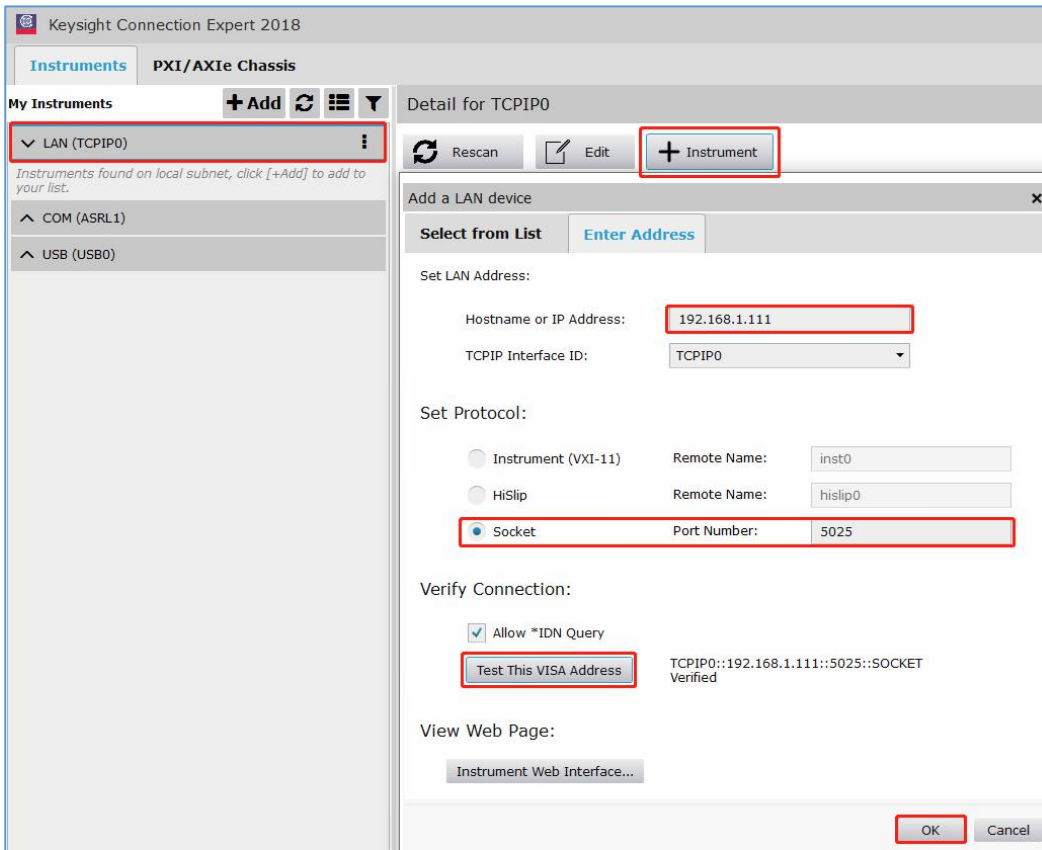

After a successful connection, the network port icon in the upper right corner of the main interface is displayed as follows:



As with USB remote control, after obtaining normal communication, you can use SCPI commands to control the power output.

If there is a DHCP server in the LAN, you can open the DHCP function, and the instrument will automatically obtain IP and other information from the DHCP server without manual setup.



I/O Config - LAN Setting			
<b>Lan Setting:</b>	<b>Lan Status:</b>		
IP Address	10 0 0 105	IP Address	10. 0. 0. 105
Subnet Mask	255 0 0 0	Subnet Mask	255. 0. 0. 0
Gateway	10 0 0 1	Gateway	10. 0. 0. 1
		Port Number	5025
<b>DHCP</b>		<b>Back</b>	
Off <b>On</b>		↑	

Note: If there is no DHCP server on the LAN, you must configure IP and other information manually.

### 9.3 RS232/485 remote control

RS232/485 Set	
Baud Rate	2400
Data Bits	8
Parity	NONE
Stop Bits	1
<b>Back</b>	
↑	

Each parameter is unchanged by default.

Pay attention to the wiring:

Pin2 is RS232\_TX, Pin3 is RS232\_RX, Pin4 is RS485\_A, Pin9 is RS485\_B.



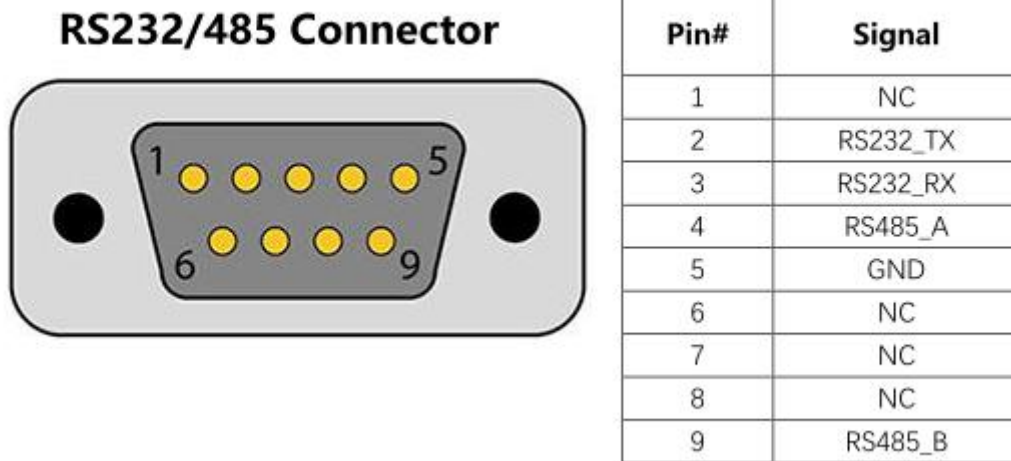

Open the IO software, select to add a device, set the corresponding baud rate, test the VISA address, and click OK to add a new device.

As with USB remote control, after obtaining normal communication, you can use SCPI commands to control the power output.

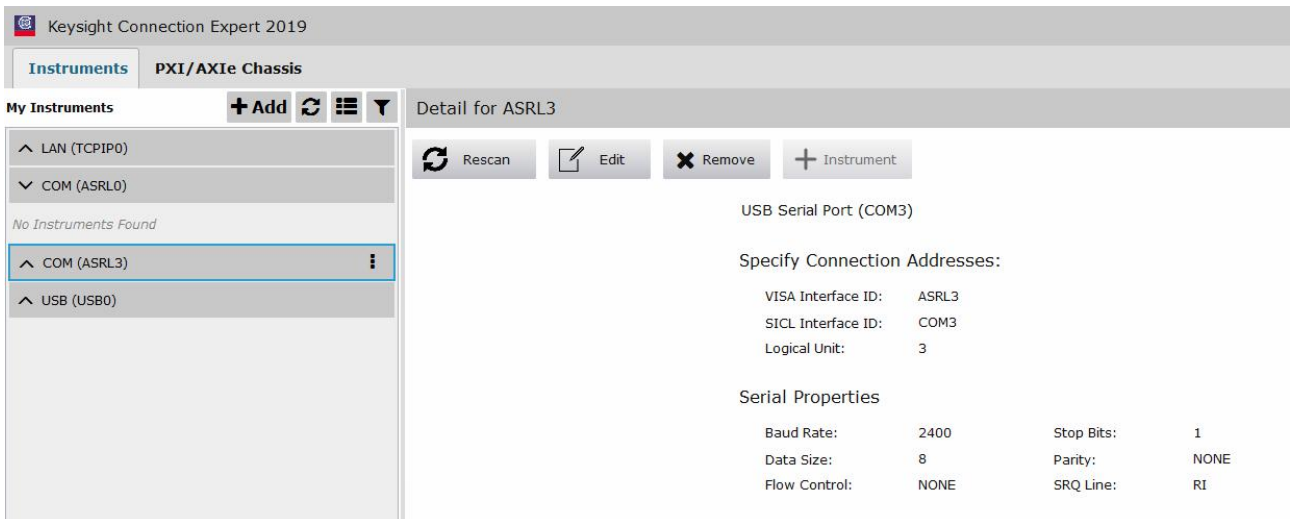

## 9.4 GPIB remote control

Utility->I/O Config->GPIB to open GPIB window. Use the numeric keypad to set the address of GPIB and press ENTER to confirm.



## 10. Utilities



### 10.1 Store/recall



Store/Recall can store and recall settings as volatile settings, such as: voltage and current values, OVP, OCP, output coupling, output status, operation mode, list output, trigger settings, data recording, key tone, Help language etc.

#### 10.1.1 Store setting

Store Settings: Used to select internal storage or external storage.

Select **Internal**, the settings will be saved in the power memory. Up to 10 states can be stored as State 0-State 9. You can choose whether to set it to "Power-on State". Press "Store" to save this setting.

Select **External**, the settings will be saved to the external storage device. First insert the USB storage device into the USB port on the front panel, press "Enter" under "File" to edit the file name, press "Done" to save and exit, and press "Store" to execute the save. The file will be saved in the .csv format to the root directory of the external storage device.

#### 10.1.2 Recall setting

Used to select to recall from internal or from external. Same as store settings: select the location, state name or external .csv setting file of the file to be recalled, press "Enter" to confirm, and press "Recall" to execute recall.

**10.1.3 Power-on setting**

Press "Power On Setting" to select a state to be automatically recalled after power-on. You can choose the default settings or user-specified settings. Press "SetPwrOn" to save the settings. Users can also check " Set this as power-on state." in "Store Settings" to set.

**10.1.4 Restore default settings**

Press "Set to Defaults" to restore the default settings.

**10.2 I/O setting**



IO setting is used to configure port parameters for remote control.

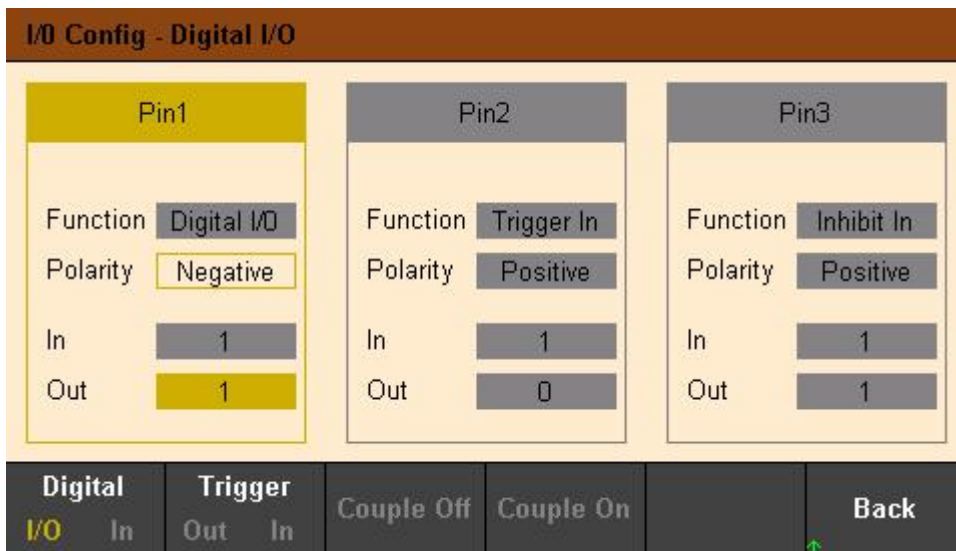

**10.2.1 Digital I/O**

Digital I/O is used to set the Pin1-Pin3 functions on the rear panel, and the other Pin is the common ground terminal. Select Digital I/O, Pin 1-Pin3 can be set as general bidirectional digital input and output. The data bits are allocated as follows:

Pins	3	2	1
Bit Weight	2 (msb)	1	0 (lsb)

Polarity: Set the Pin polarity to positive or negative.

In input: display the state applied to Pin (binary bit 0 or 1).

Out output: binary bit 0 or 1 can be set.

**10.2.2 Digital input**

Select Digital In, Pin 1-Pin3 can be set as digital input.

Polarity: Set the Pin polarity to positive or negative.

In: display the state applied to Pin (binary bit 0 or 1).

### 10.2.3 Trigger output

Select Trigger Out, Pin1-Pin3 can be set as trigger output. This function is used in conjunction with the list output (BOST/EOST).

The Pin assigned this function will output a pulse signal of about 5ms.

Polarity: Set the Pin polarity to positive or negative, that is, the trigger output pulse is positive or negative.

#### **Trigger output operation example:**

1. Connect Pin1 to the display device

Pin1 is connected to the input terminal of the oscilloscope as the trigger output terminal, and the common ground terminal is connected to the ground of the display device.

2. IO function settings

Pin1 function select "Trigger out", Pin1 polarity is set to positive. Refer to the "[Output List](#)" chapter to set the output list, and check "BOST" or "EOST".

3. Trigger output

Turn on the channel output and execute the list output "Run/Stop". After the trigger occurs, the oscilloscope displays a positive pulse at each trigger response point set.

### 10.2.4 Trigger input

Select Trigger In, Pin 1-Pin3 can be set as trigger input. This function is used in conjunction with the list output (trigger source is set to DIO Trigger In under the property menu). When an external digital signal is input from the specified Pin, a trigger occurs and the output is set according to the list.

Polarity: Set the Pin polarity to positive or negative.

In input: display the relative status of the input level.

#### **Trigger input operation example:**

1. Connect Pin1 to a digital signal generator

Pin1 is used as the trigger input interface, and the common ground is connected to the ground of the digital signal generator.

2. IO function settings

Pin1 function select "Trigger in", Pin1 polarity is set to positive. Refer to the "[Output List](#)" chapter to set the output list, and select "DIO Trigger In" as the trigger source in the "Properties".

3. Trigger input

Turn on the channel output, execute the list output "Run/Stop", set the Pin1 external input signal 0 or 1 to change, and the list output will be triggered at this time.

### 10.2.5 Coupling off/on

Select Couple Off/Couple On, Pin1-Pin3 can be set as coupling off/on. Only one Pin can be set as coupling off or coupling on, and the polarity of Pin is fixed to negative. Changing the input signal corresponding to Pin can control the coupling output of the specified channel.

Note: First, set at least two channel couplings to be turned on in the output settings, refer to the [output coupling](#) chapter.

### 10.2.6 Inhibit input

Select Inhibit In, Pin3 can be set to inhibit input. Refer to the description of DIO Pin3 function in "[Output Inhibition](#)".

Polarity: Set the Pin polarity to positive or negative.

In input: display the relative status of the input level.

## 10.3 Setup

### 10.3.1 Help language

The default is English, press Enter to switch to Chinese.

### 10.3.2 Sound switch

Press "Enter" to switch the key tone on or off.

### 10.3.3 Firmware upgrade

Select the channel to be upgraded and press "Start" to start the upgrade.

### 10.3.4 Calibration

The instrument has been calibrated before leaving the factory, and the user does not need to calibrate again. If you really need to calibrate, you can use SCPI commands to recall the calibration program.

## 10.4 Error message

Error displays the error information of the instrument. The error information list is arranged in the order in which it was generated, that is, the most recent error is displayed at the top. Press "Next" to view the next page.

## 10.5 Capture

Capture can set the properties of the screenshot file, including the save path and file name. The default picture format is .bmp.

Long press the "Meter View" button for 3 seconds to perform the screenshot operation, and the screenshot file is automatically saved to the external storage device.

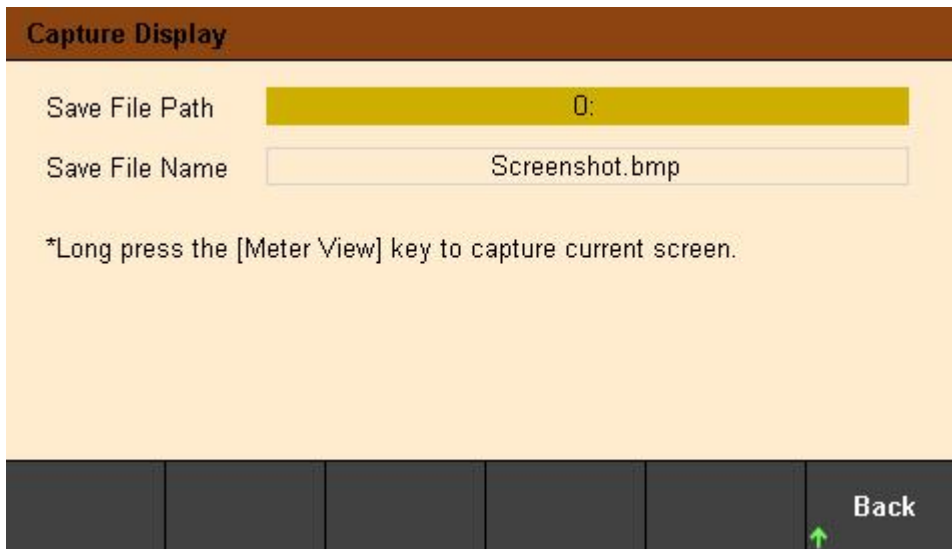

## 11. Lock/Unlock

Long press the "Lock/Unlock" key to lock the front panel, short press this key to cancel the lock.

When the front panel is locked, the lock icon will be displayed on the top of the main screen, and the icon will disappear after unlocking.

## Chapter 4 Troubleshooting

The following faults may occur during the use of this series of programmable DC power supplies. Users can refer to the following methods to deal with. If the fault still exists, please contact Hantek and provide the equipment information of the instrument (How to obtain:  ->About).

### 1. The instrument cannot be turned on.

- (1) Check whether the power cord is properly connected.
- (2) Check whether the power switch on the front panel is turned on.
- (3) Unplug the power cord, check whether the AC selector is in the correct position, whether the specifications of the fuse are correct and whether it is intact. If you need to replace the fuse, please refer to the "[Steps to replace the fuse](#)".
- (4) If the problem persists, please contact Hantek.

### 2. The constant voltage output is abnormal.

- (1) Check whether the maximum output power of the selected gear meets the load requirements.
- (2) Whether the cables connecting the load and the power supply are short-circuited, and whether they are in good contact.
- (3) Check whether there is a problem with the load.
- (4) Check whether the current setting value of this gear is appropriate. If it is too low, you can increase the current setting value appropriately.

(5) If the problem still cannot be solved, please contact Hantek.

### 3. The constant current output is abnormal.

(1) Check whether the maximum output power of the selected gear meets the load requirements.

(2) Whether the cables connecting the load and the power supply are disconnected and whether they are in good contact.

(3) Check whether there is a problem with the load.

(4) Check whether the voltage setting value of this gear is appropriate. If it is too low, you can increase the voltage setting value appropriately.

(5) If the problem still cannot be solved, please contact Hantek.

### 4. The U disk cannot be recognized correctly.

(1) Check whether the U disk can work normally.

(2) Make sure that the USB flash drive is used. This instrument does not support hard drive USB flash drives.

(3) After restarting the instrument, insert the U disk to check.

(4) If the USB flash drive still cannot be used normally, please contact Hantek.

## Chapter 5 Performance Index

DC output (0°C~40°C)			
Channel		Voltage	Current
HDP43XX	CH1	32V	3.2A
	CH2	32V	3.2A
	CH3	8V	5A
HDP44XX	CH1	32V	3.2A
	CH2	32V	3.2A
	CH3	8V	2A
	CH4	16V	1.5A

Series and parallel output			
Channel		Series	Parallel
HDP43XX	CH1	64V,3.2A	32V,6.4A
	CH2		
	CH3	—	—
HDP44XX	CH1	64V,3.2A	32V,6.4A
	CH2		
	CH3	—	—
	CH4	—	—

Load Regulation  $\pm$ (% of output + offset)

Voltage	<0.01%+2mV
Current	<0.01%+250μA

Line Regulation ±(% of output + offset)	
Voltage	<0.01%+2mV
Current	<0.01%+250μA

Ripple and noise (20Hz to 20MHz)	
Normal mode voltage	<350μVrms /2mVpp

Accuracy(25°C±5°C) ±(% of output + offset)					
Channel		Programming		Readback	
		Voltage	Current	Voltage	Current
HDP43XX	CH1	0.05%+10mV	0.2%+5mA	0.05%+10mV	0.2%+5mA
	CH2				
	CH3	0.1%+5mV	0.1%+10mA	0.1%+5mV	0.1%+10mA
HDP44XX	CH1	0.05%+10mV	0.2%+5mA	0.05%+10mV	0.2%+5mA
	CH2				
	CH3	0.1%+5mV	0.1%+10mA	0.1%+5mV	0.1%+10mA
	CH4				

Transient response time	
The output current from full load to half load, or from half load to full load, the time for the output voltage to recover to within 15mV is less than 50μs.	

Mechanical		
Size	232*153*392mm	
Weight	HDP43XX	9.15Kg
	HDP44XX	9.45Kg

Power supply	
AC input (50Hz~60Hz)	100Vac±10%, 115Vac±10%, 230Vac±10%(Maximum 250Vac)
Maximum input power	600VA

Interface	
USB Device	1 piece
USB Host	1 piece
LAN	1 piece
Digital IO	1 piece
RS-232/485	1 piece (Option)



GPIB	1 piece (Option)
------	------------------

Surroundings	
Cooling method	Air-cooled
Operating temperature	0°C ~ 50°C
Storage temperature	-40°C ~ 70°C
Humidity	0°C ~ 30°C: ≤95% relative humidity 30°C ~ 40°C: ≤75% relative humidity 40°C ~ 50°C: ≤45% relative humidity
Altitude	Below 3000 meters