

MDP-M01

User Manul Of Display Control Module

Before using this product, please read this manual
(This user's manual written based on firmware version V1.20)



table of Contents

Key description	2
Waveform diagram interface WARE	4
Lamp status	4
DETAIL detailed list of information	4
SET interface	5
Upgrade	9
Appendix 1 Description	9

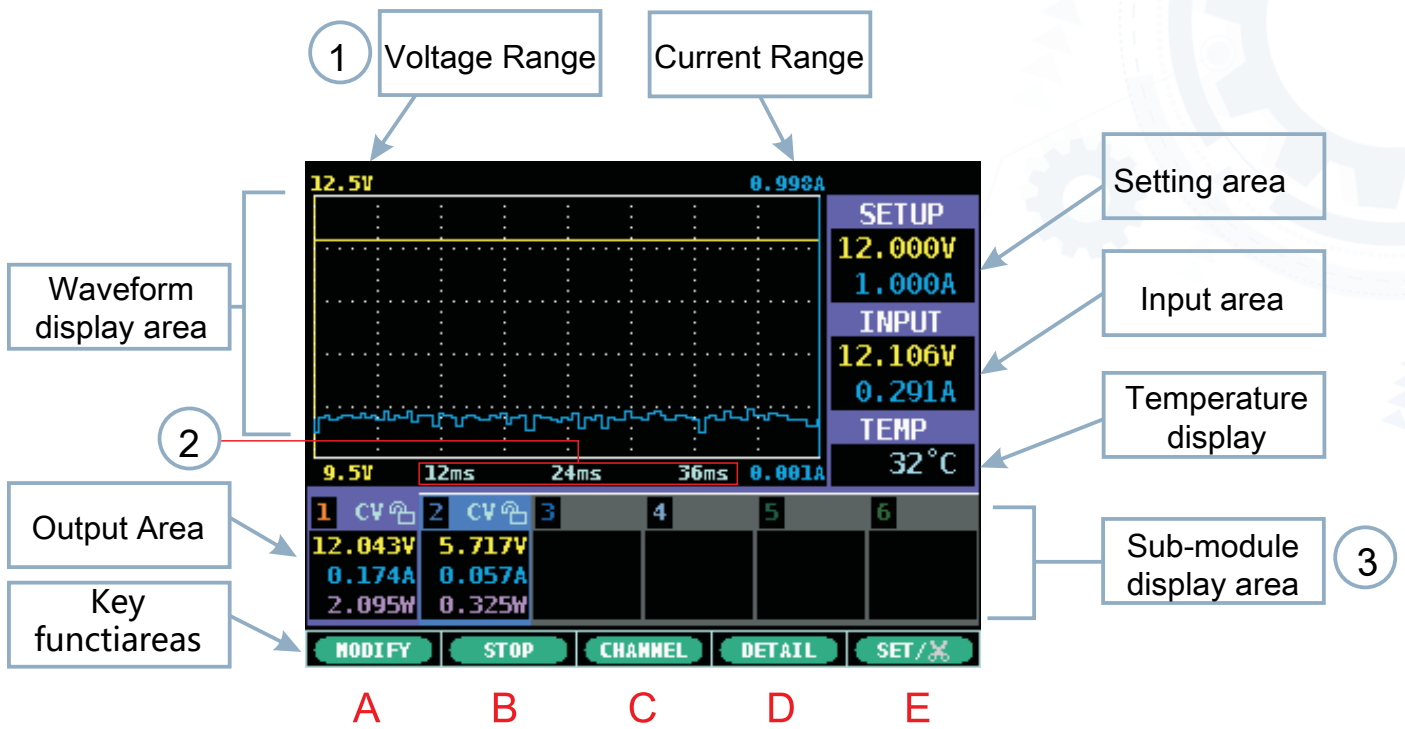

figure 1

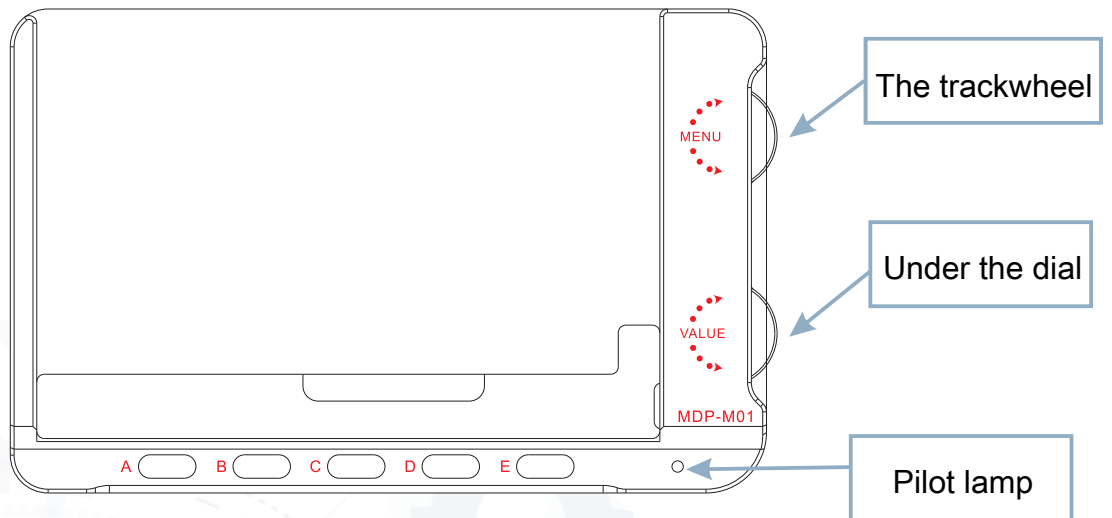

FIG 1 interface buttons corresponding to the bottom of its key function, when the key gray background when the key is not representative of the current.

- A** (MODIFY) Edit mode: If you want to change certain values must click the button to enter the next level editing mode;
- B** (PLAY / STOP) Playback Stop: stop or playback waveform;
- C** (The CHANNEL) Channel: Wireless channel switching (i.e. a table for selected power supply);
- D** (DETAIL)details interface;
- E** (the SET)setting interface;
- ☒ Screenshot (long press): in order to be saved screenshot U disk;

on the dial: Similar cursor jumps, i.e. choose a place to be edited;

under the dial: change value;

- (the NEXT) Next a: a turn to the numerical modification mode;
- (the BACK) Returns: Returns to the previous editing mode;
- (the CONFIRM) acknowledgment;
- (the WAVE) waveform interface;
- (the HELP) help.

Edit mode:

▲ Note: when adjusting the settings set current or voltage, which can not exceed the total power is 90W.

Step one: Click the MODIFY button, the following figure:

The screenshot shows the device's control interface. The top section displays a waveform with a yellow trace and a blue trace. The 'SETUP' menu on the right shows '12.000V' selected in orange, with '3.000A' below it. The 'INPUT' section shows '11.861V' and '0.382A'. The 'TEMP' section shows '31 °C'. Below the waveform, there are buttons for 'NEXT' and 'BACK'. A callout box points to the '12.000V' value, stating: 'Select the current or voltage (Orange color selected module)'. Another callout box points to the 'NEXT' button, stating: 'Turn to a lower value Modify Mode'. A third callout box points to the 'BACK' button, stating: 'Go back to the previous Edit mode'.

Step Two: Click the NEXT button, the following figure:

The screenshot shows the device's control interface after clicking the 'NEXT' button. The '12.000V' value in the 'SETUP' menu is now highlighted with a blue box. The 'INPUT' section shows '11.862V' and '0.380A'. The 'TEMP' section shows '31 °C'. Below the waveform, there are buttons for 'NEXT' and 'BACK'. A callout box points to the '12.000V' value, stating: 'In the selected voltage, the rotation of the pulley to move the selected specified values, the rotation of the lower pulley to change the numerical size'. Another callout box points to the 'BACK' button, stating: 'Go back to the previous Edit mode'.

WARE interface reference waveform diagram shown in FIG 1:

- 1 Range Adaptive. The voltage at the current time into 0ms removed from the queue, the queue to find the maximum value with the minimum and maximum voltage change range is plus 500mV, the minimum value Save 2500 mV, and the current range is the maximum current is applied according to 800mA, Save minimum 300mA.
- 2 Axis can be adjusted on the dial.
- 3
 1. break extension, which corresponds to the numerical values of the background turns red channel, reconnection can restore its original color.
 2. When no power source is connected, the key under the ribbon jump prompts to Auto Match interface (FIG. 1.1) matching wireless connection.

Lamp status

Blue indicator lights: Always running lights.

Red light: the extension case warning lights.

DETAIL detailed list of information

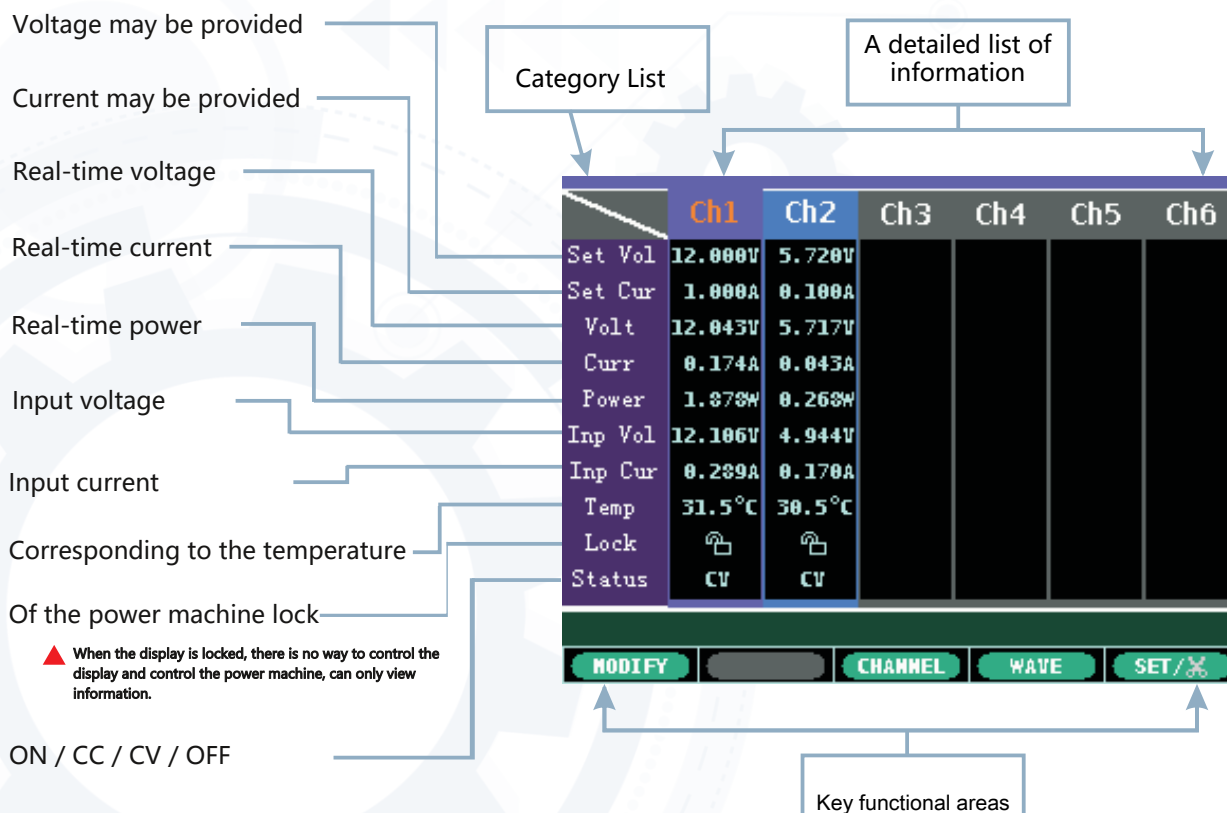

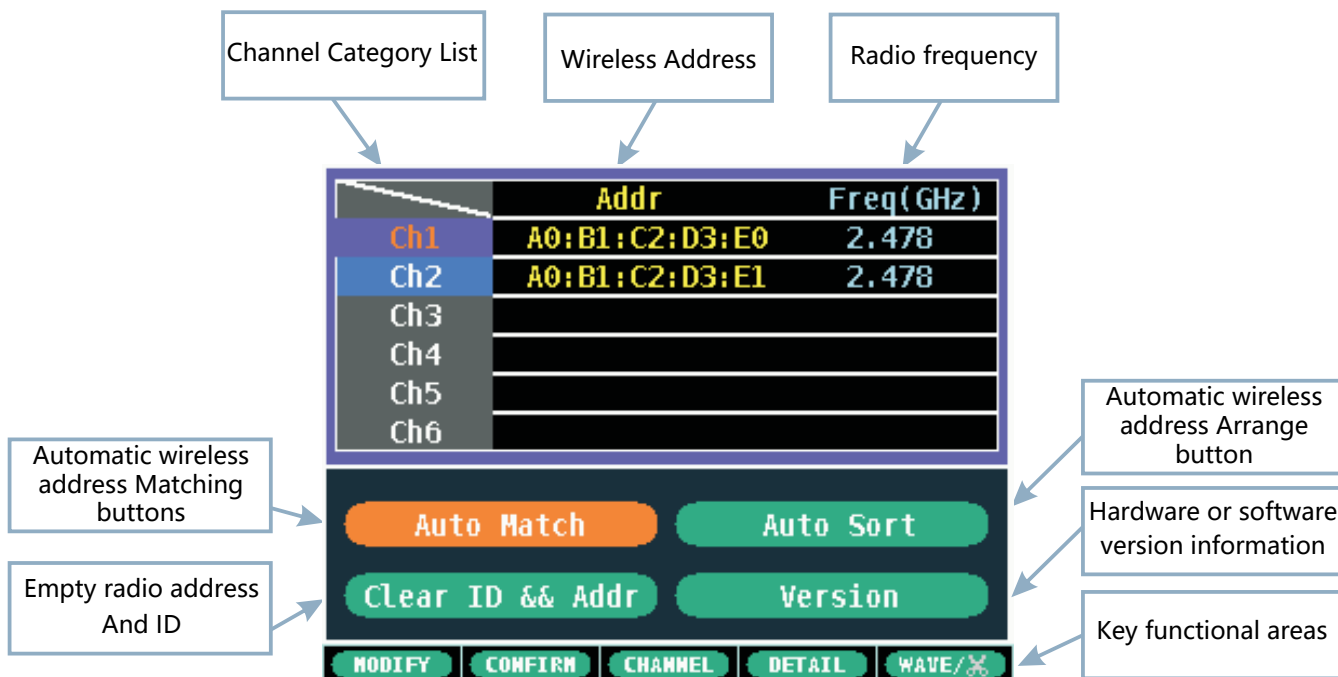

a) Addr: wireless address is connected.

b) Freq (GHz): is a radio frequency connection.

▲ May be individually modified with radio frequency wireless address Addr or Freq (GHz) list.

Step one: Click the MODIFY button, the following figure:

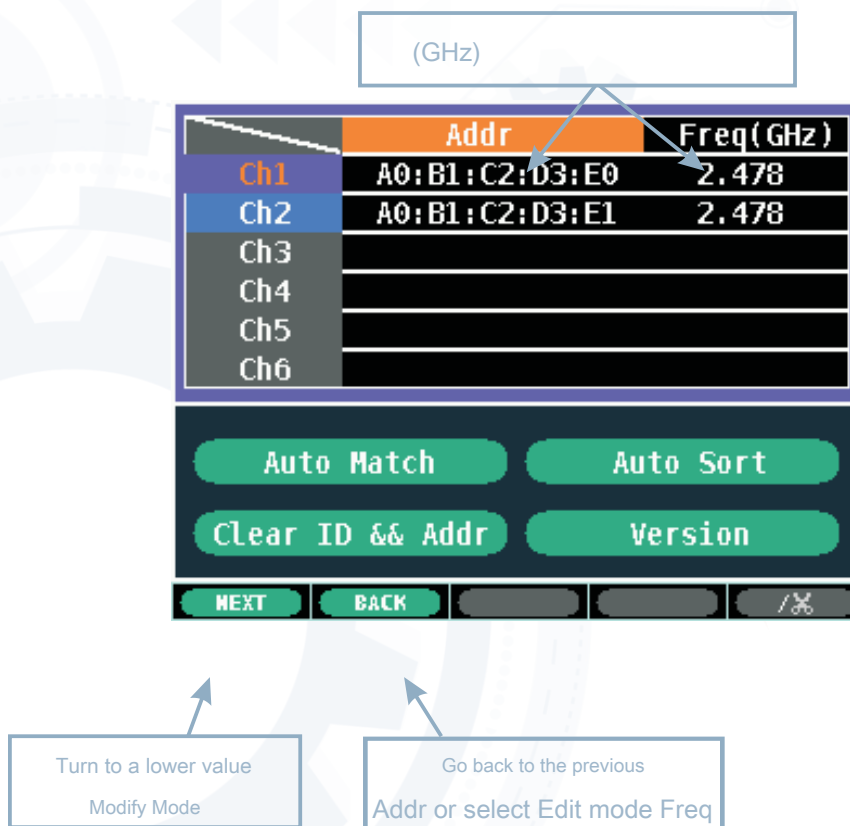

Step Two: Click the NEXT button, the following figure:

In Addr selected, the rotation of the pulley to move the selected specified value, the rotation of the pulley to change the size of the value

	Addr	Freq(GHz)
Ch1	A0:B1:C2:D3:E0	2.478
Ch2	A0:B1:C2:D3:E1	2.478
Ch3		
Ch4		
Ch5		
Ch6		

Auto Match Auto Sort

Clear ID && Addr Version

BACK

Go back to the previous Edit mode

c) Clear ID && Addr: Remove all power and the corresponding wireless addresses match the ID number, and can not automatically deleted Line address file.



OK button

Cancel button

d) Version: includes hardware and software version information.

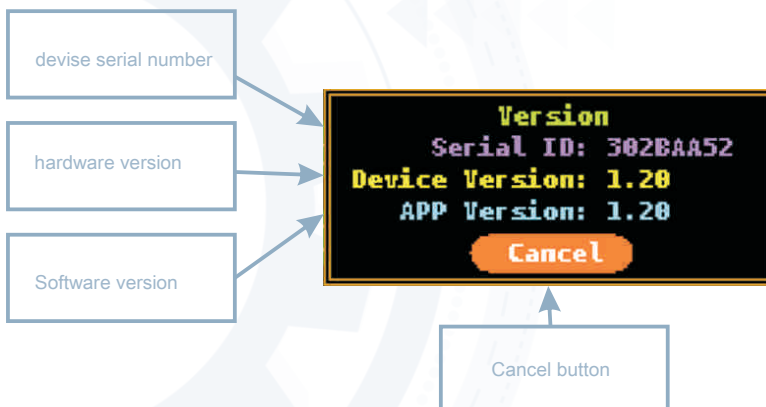

There are three display control method may be paired with the wireless power sub-modules, are as follows e, f, g:

e) Auto Match:Automatically match with the address with a wireless radio frequency power.

Auto Match sub-interface:

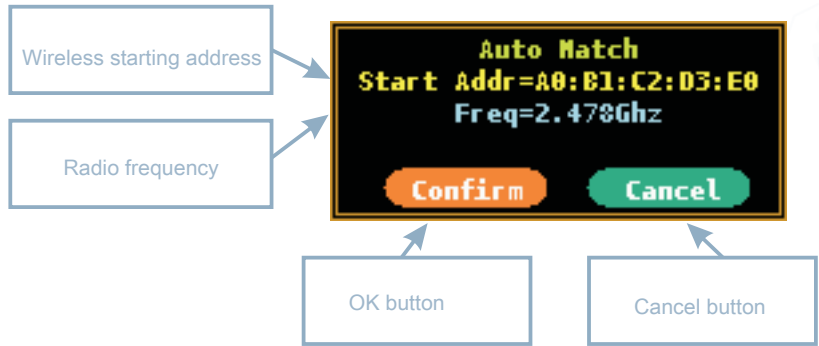

Figure 1.1

Start Addr: automatic matching requires the starting address of the wireless slave device, each additional slave units in the wireless address Finally, the cumulative value of 1;

Freq: automatic matching of the radio frequency required slave.

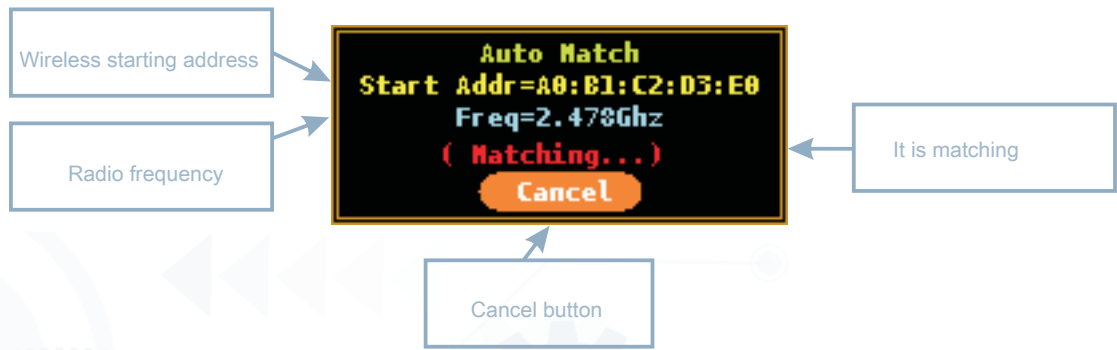

Figure 1.2

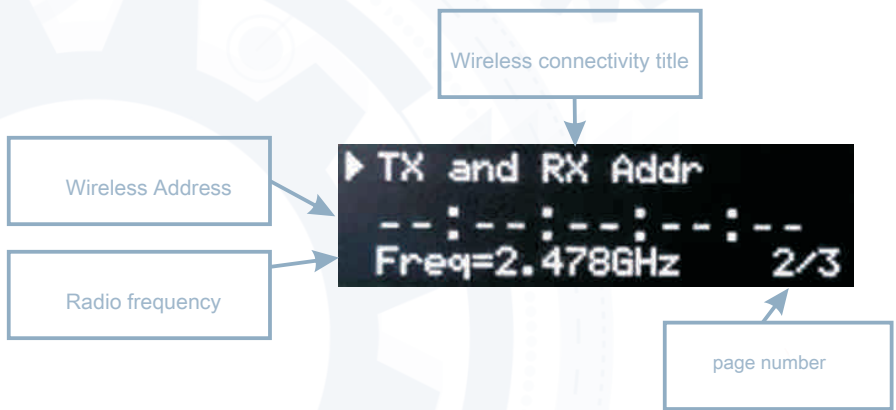

Figure 1.3

Display and Control: select "Auto Match" button, to enter the above interface sub Auto Match (FIG. 1.1), then Confirm Click the OK button to enter Figure 1.2, matching the wireless connection, and then waits for a reply pairing wireless power supply.

Power: Press the power button MENU intermediate, then move the pulley to a menu page provided Tx and Rx Addr(Figure 1.3), and then click the left button SET. As can be matched successfully, the wireless list box on the SET display and control interface, a power menu page provided Tx and Rx Addr (Figure 1.3) is displayed above the address of wireless radio frequency with the matching succeeds.

- f) Auto Sort: Sort automatically with radio frequency wireless address. (This pairing for power wirelessly Has good access in sequence, the power supply has been completed or modifications as are suited to the address with a wireless radio frequency through the U disk).

Auto Sort sub-interface:

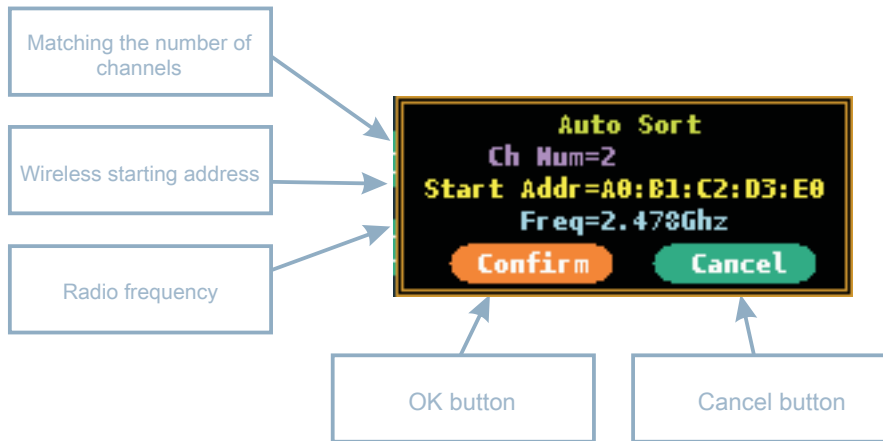

Ch Num: the number of the slave to be sorted;

Start Addr: need to sort the originating wireless address of the slave, each additional slave units, most radio addresses After the values incremented by 1;

Freq: a radio frequency to be sorted slave.

- g) Into the U can display and control panel to change the radio address to match with the radio frequency power supply, its file name is RX_ADDR.TXT, the contents of the file as shown below, changes will take effect after reboot.

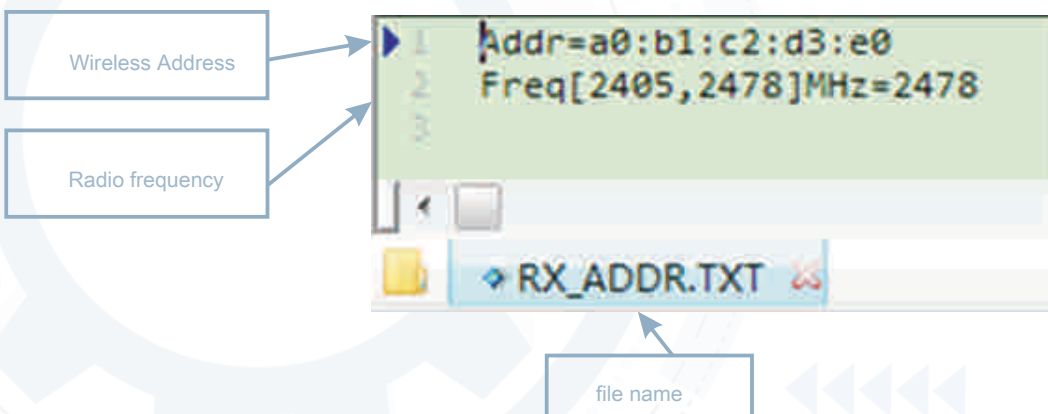

Note:

- 1) To add a new sub-module , Click "Clear ID && Addr" function to delete the old ID to save the information,Again the match in order to connect to the host.
- 2) Radio frequency 2405MHz-2478MHz.
- 3) If the currently selected sub-equipment dropped,it will automatically jump to the other sub-selected on the device is online.
- 4) When radio address matching, if the power output to open their own,based on security issues, will be forced to shut down Power Output.

Upgrade

A press of the display and control keys, and also with a USB cable usb computer, the computer will appear named: DFU Vx_xx_x removable hard disk, the prepared .hex firmware copied to the root directory of the mobile hard disk, when the extension by the firmware .hex become .rdy, restart the display and control, to complete the firmware upgrade.

Appendix 1 Description

Note that (abnormalities alarm description):

- 1) Because the U disk inside the factory does not need to put files in there, so do not read a file Check;
- 2) Interface displays "Flash Error", Explanation Abnormal flash chip;
- 3) Interface display "Wireless Error",Description wireless chip anomalies.