

## USR-TCP232-S2 User Manual

File version:V1.0.1



USR-TCP232-S2 User Manual.....	1
1. Quick Start.....	4
1.1. Hardware Testing Environment.....	4
1.2. Connection.....	4
1.3. Default Parameter.....	6
1.4. Data Transmission Testing.....	6
2. Overview.....	7
2.1. Brief Introduction.....	7
2.2. Features.....	7
2.3. Parameters.....	8
2.4. Hardware Information.....	8
2.5. Pin Dimension.....	10
3. Module Function.....	11
3.1. Work mode.....	11
3.1.1. TCP Client mode.....	11
3.1.2. TCP Server mode.....	12
3.1.3. UDP Client mode.....	14
3.1.4. UDP Server mode.....	14
3.1.5. HTTPD Client.....	15
3.1.6. TCP and UDP mechanism.....	15
3.2. DHCP and DNS Function.....	15
3.3. VCOM.....	17
3.3.1. Module Works as Client.....	17
3.3.2. Module Works as Server.....	18
3.3.3. Create VCOM.....	19
3.4. Special Function.....	21
3.4.1. RS485 Function.....	21
3.4.2. Transparent transmission cloud.....	21
3.4.3. Link Function.....	21
3.4.4. Factory Reset.....	21
3.4.5. Reset Function.....	22
3.4.6. ID Function.....	22
3.4.7. Index Function.....	22
3.4.8. Similar RFC2217 Function.....	22
3.5. New Function.....	22
3.5.1. AT Command.....	22
3.5.2. Display IP and Data.....	22
3.5.3. Set Client Number in TCP Server Mode.....	23
3.5.4. Defined MAC Address.....	23
3.5.5. Defined DNS Server IP.....	23
3.5.6. Defined Registration Package.....	23
3.5.7. Defined Heartbeat Package.....	23
3.5.8. HTTPD Client.....	23

---

3.6. Firmware Upgrade.....	23
4. Parameter Setting.....	24
4.1. Webpage Setting.....	25
4.2. Log in.....	25
4.3. State Configuration.....	26
4.4. Local IP.....	26
4.5. Serial Port Parameter.....	27
4.6. Expand Function.....	28
4.7. Misc Configuration.....	28
4.8. Reboot.....	29
4.9. Software Setting.....	29
5. Contact information.....	33
6. Disclaimer.....	33
7. Undated History.....	34

## 1. Quick Start

USR-TCP232-S2 is used for data bidirectional transparent transmission between TTL and Ethernet. S2 module itself complete protocol conversion, parameter can be set by built-in webpage or software. Once set permanent preservation.

This chapter is quick start for using USR-TCP232-S2 module, we advice users to read it carefully and operate personally, it can help you know about module generally.

Here is application case for inference:

<http://www.usriot.com/support/application-case/usr-tcp232-series-application-case/>

You can also email it to Customer Support Center:

<http://h.usriot.com/>

### 1.1. Hardware Testing Environment

To test S2 conversion function, user should connect S2 UART to computer by USB to TTL serial line, then connect S2 LAN port to computer LAN port by internet cable. If you want to use S2 evaluation board, use USB to RS232 serial line instead of USB to TTL serial line.

Here is schematic diagram for hardware link .



Diagram 1 Hardware Link

### 1.2. Connection

Computer should be set as follows:

- 1) Shut down firewall and anti-virus software .

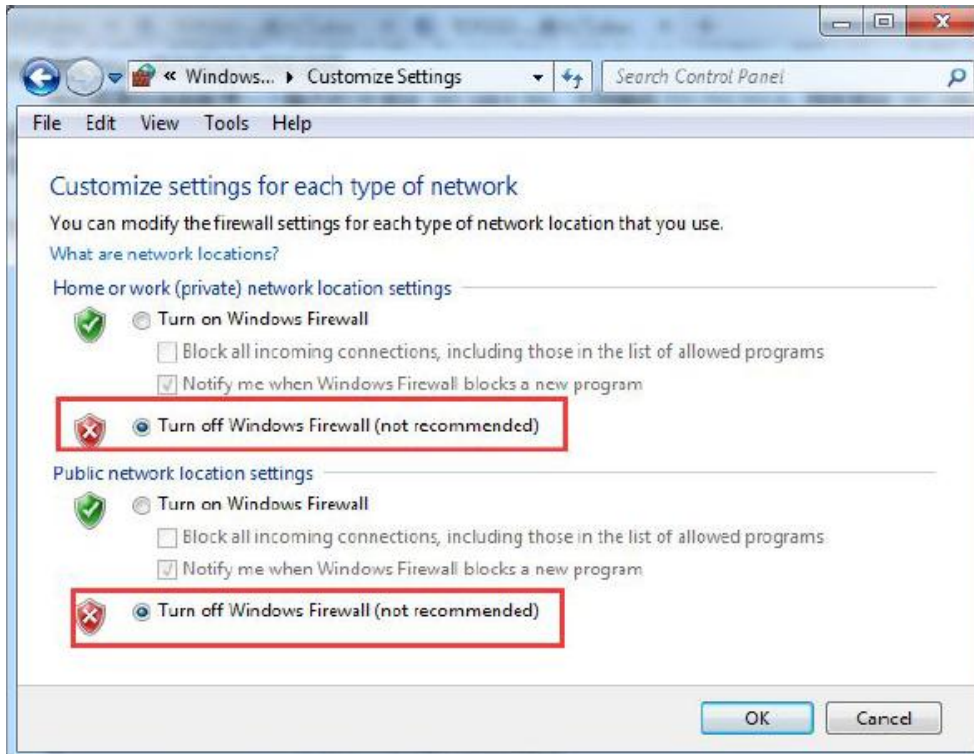

Diagram 2-1

2) Shut down unrelated network card, just use one local connection.

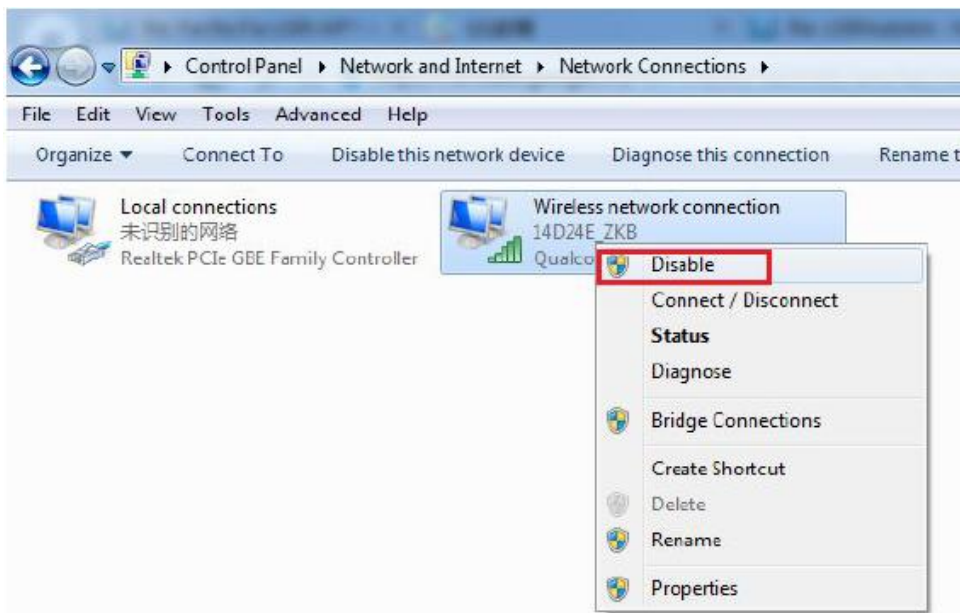
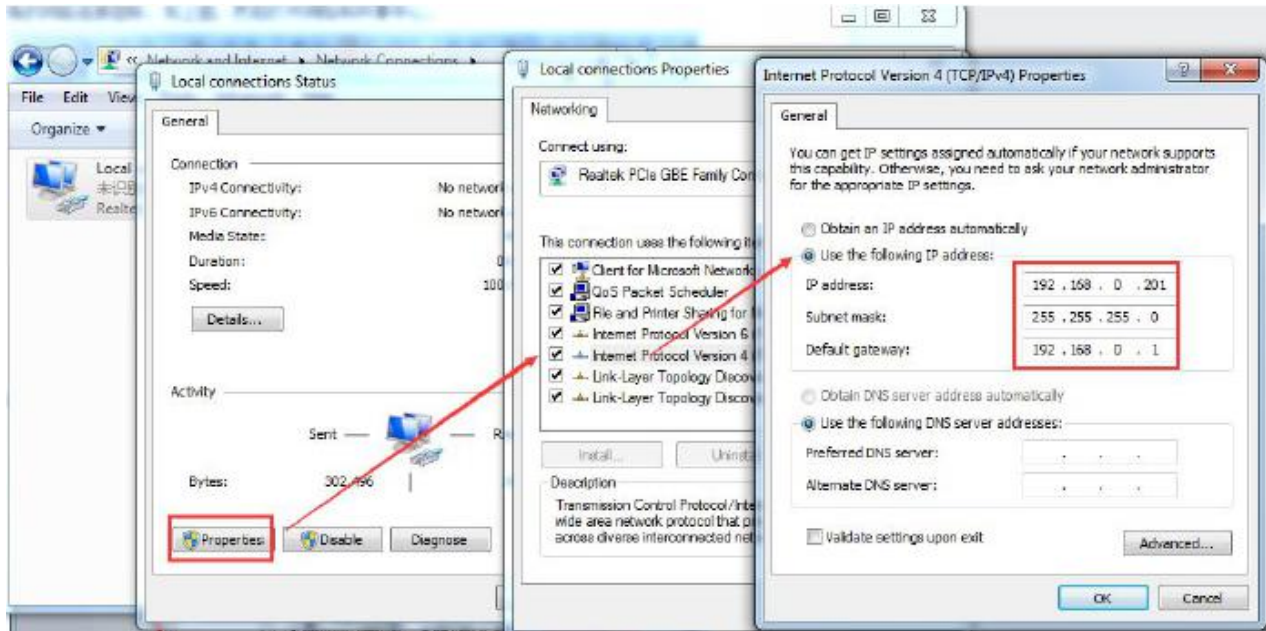

Diagram 2-2

3) If you want connect module to PC directly, user should set static IP for computer which is in the same network segment with module.

**Diagram 2-3**

### 1.3. Default Parameter

Item	Content
User name	admin
Password	admin
IP address	192.168.0.7
Subnet mask	255.255.255.0
Default gateway	192.168.0.1
Serial baud rate	115200
Serial parameter	None, 8 ,1
Local port	20108
Target IP	192.168.0.201
Target port	8234

**Table 1 S2 Module Default Parameter**

### 1.4. Data Transmission Testing

Steps for network communication parameters:

- 1) Install USR-TCP232-Test.exe .
- 2) Connect UART to PC, LAN to PC.
- 3) Protocol: TCP Server  
 Server IP: 192.168.201 ( PC Static IP )  
 Server Port No: 8234

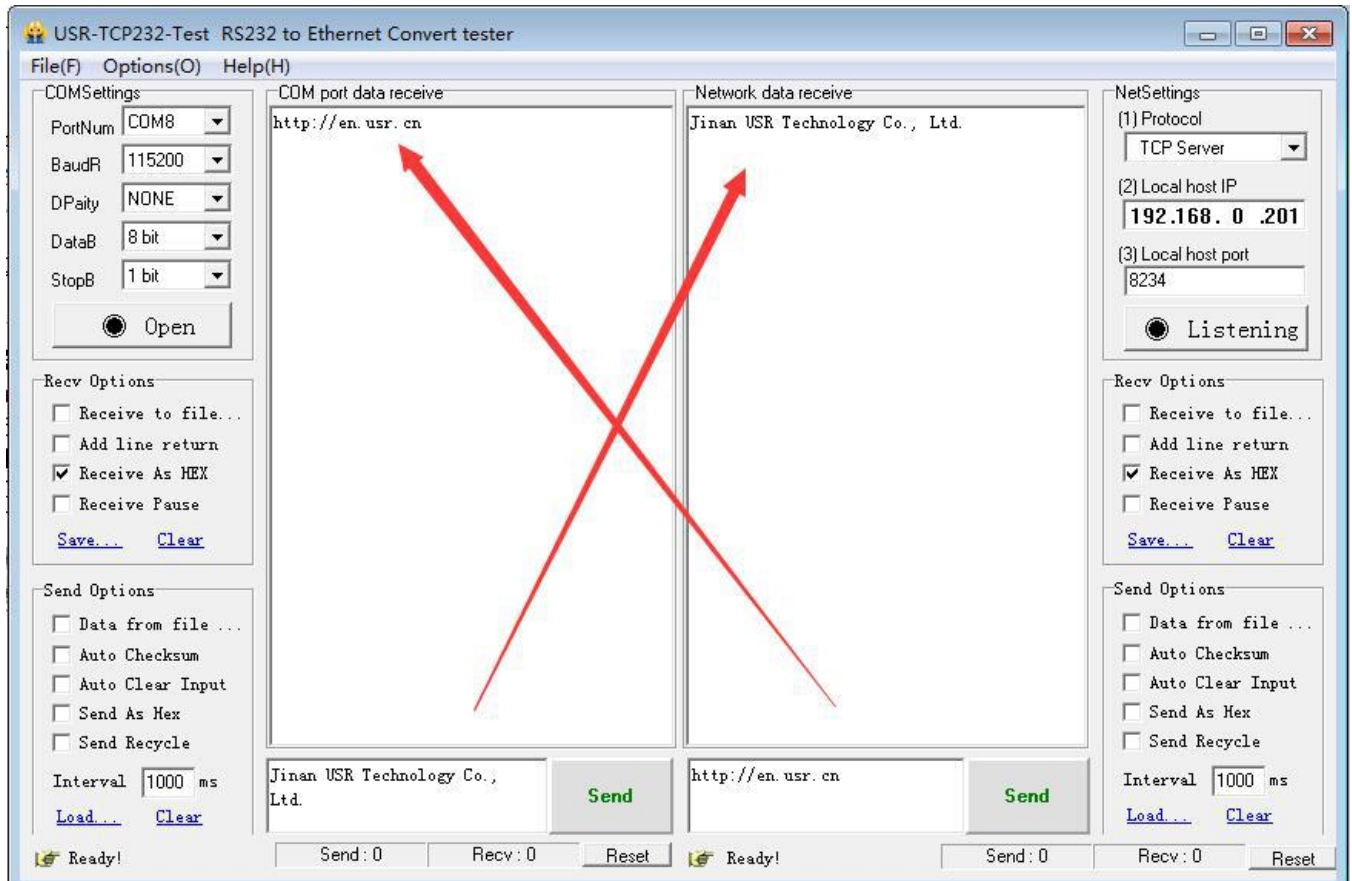

Diagram 3 Port to LAN Test

## 2. Overview

### 2.1. Brief Introduction

TCP232-S2 is a new and tiny size serial to Ethernet module which realizes data bidirectional transparent transmission between TTL Port and RJ45 Port, it can also be used in RS232/RS485 by level shift circuit.

S2 is equipped with Cortex-M0 core. It has characteristics of low power, fast speed, high efficiency, strong compatibility, and is easy to use.

### 2.2. Features

- Support DHCP (Dynamic Host Configuration Protocol);
- Support DNS (Domain Name System);
- Web-set: Setting parameters through web;
- Upgrade firmware via network;
- Support AUTO MDI/MDIX, can use a crossover cable or parallel cable connection;
- Serial port baud rate 600 bps ~460.8Kbps, and None, Odd, Even, Mark, Space, five check bits;
- Work mode: TCP Server, TCP Client, UDP Client, UDP Server, HTTPD Client;
- Working mode related parameters can be set via a serial port or network;

- Support virtual serial port, self-developed USR-VCOM software;
- Heartbeat package mechanism to ensure connection is reliable, put an end to connect feign death;
- User-defined registration package mechanism, check the status of connection;
- Under TCP Server mode, Client number rangefrom1 to 16, default value is 4;
- Support User-defined MAC address;
- Restore factory default;
- Across the gateway, switches, routers;
- Across the gateway, across switches, routers;
- Provide(socket), VB, C++, Delphi, Android, IOS;
- Download application cases;
- Support customization;

## 2.3. Parameters

**Table 2 USR-TCP232-S2 Parameter**

Parameter	Parameter Value
Voltage	VCC: DC typical value 3.3V, 3.0V~3.6 V
Current	150mA (aver) /200mA (max)
Serial Level	TTL(3.3V)
Network interface	PHY signal
Packing	SMD package
Size	PCB: 33.0*20.3 mm (L*W)
Temperature	Working temp: -25 ~ 75 °C Storage temp: -40 ~ 105 °C Storage humidity: 5% ~ 95% RH

## 2.4. Hardware Information

**Table 3 USR-TCP232-S2 Pin**

Number	Pin	Function	Instruction
1	GND	Ground signal	Connect to ground
2	RST	Reset	Pin receive current below 200ms ,it can reset module. If unneeded, don't connect the pin . (Power on , reset means restart the module. Advice connect I/O of MCU, MCU can control the module .)
3	ISP	NC	Don't connect the pin
4	RXD	Receive data	TTL connect to 3.3v MUC (For 5V, refer to Diagram 4)



5	TXD	Send data	TTL connect to 3.3v MCU (For 5V, refer to <b>Diagram 4</b> )
6	CFG(Reload)	For module configuration and restore factory default	When normal working , don't connect the pin or connect to high level. Under low level, the pin is used for module Configuration. When configuration, pull down Reload pin, enter into port Configuration. If choose "Reload" in webpage or setting software, it is used to restore factory default
7	LD2	Network data indication	Network data indication light, connect VCC by LED, don't need to connect current-limiting resistance.
8	LD1	Network connection indication	Network connection indication light, connect VCC by LED, don't need to connect current-limiting resistance.
9	AVDD	PHY output voltage	PHY control voltage output, connect network transformer center tap.
10	RX+	Receive signal +	Receive Data+ ,shorten the line if connect
11	RX-	Receive signal -	Receive Data- ,shorten the line if connect
12	TX+	Send signal+	Transceiver Data+ ,shorten the line if connect
13	TX-	Send signal-	Transceiver Data- ,shorten the line if connect
14	RS_485	Reserved	RS485 reserved pin
15	Link	Reserved	Used as indication pin for TCP connection status.
16	VCC	Power supply	Typical value 3.3V @ 200mA

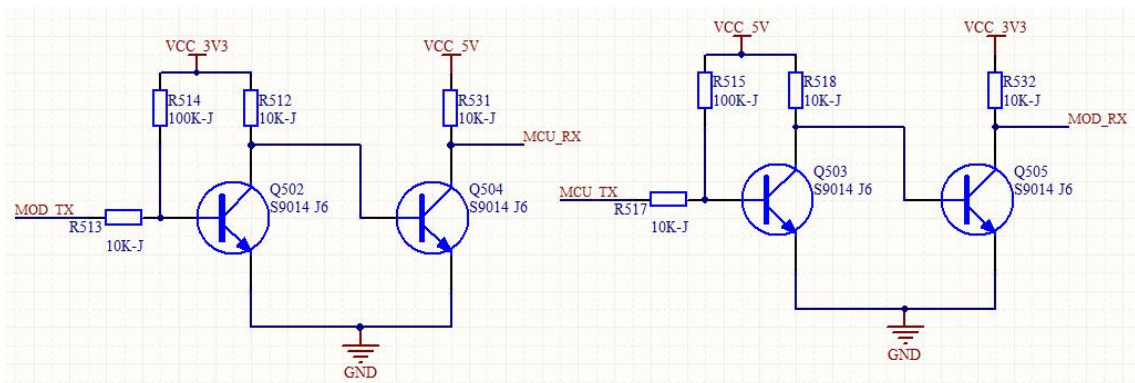

**Diagram 4 3.3V to 5V voltage conversion circuit**

## 2.5. Pin Dimension

单位: mm

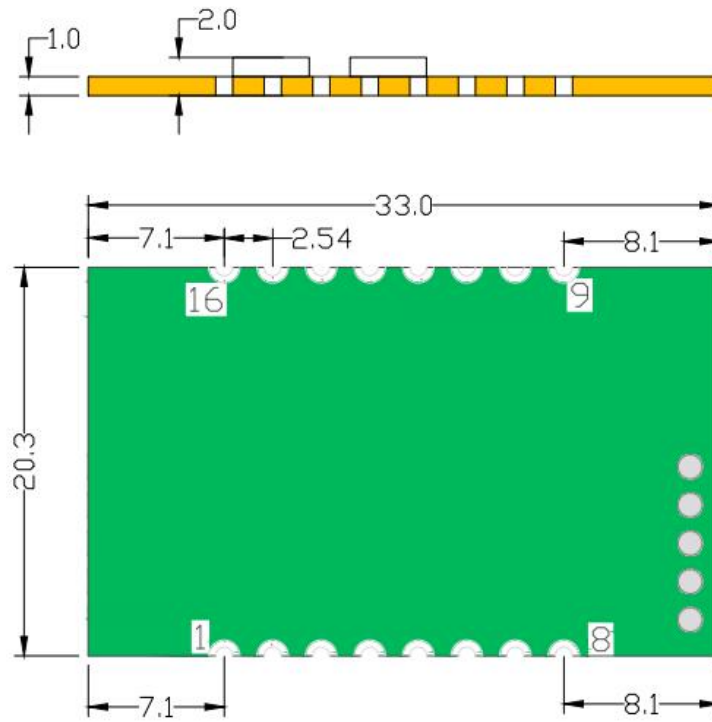

Diagram 5 S2 Dimension

### 3. Module Function

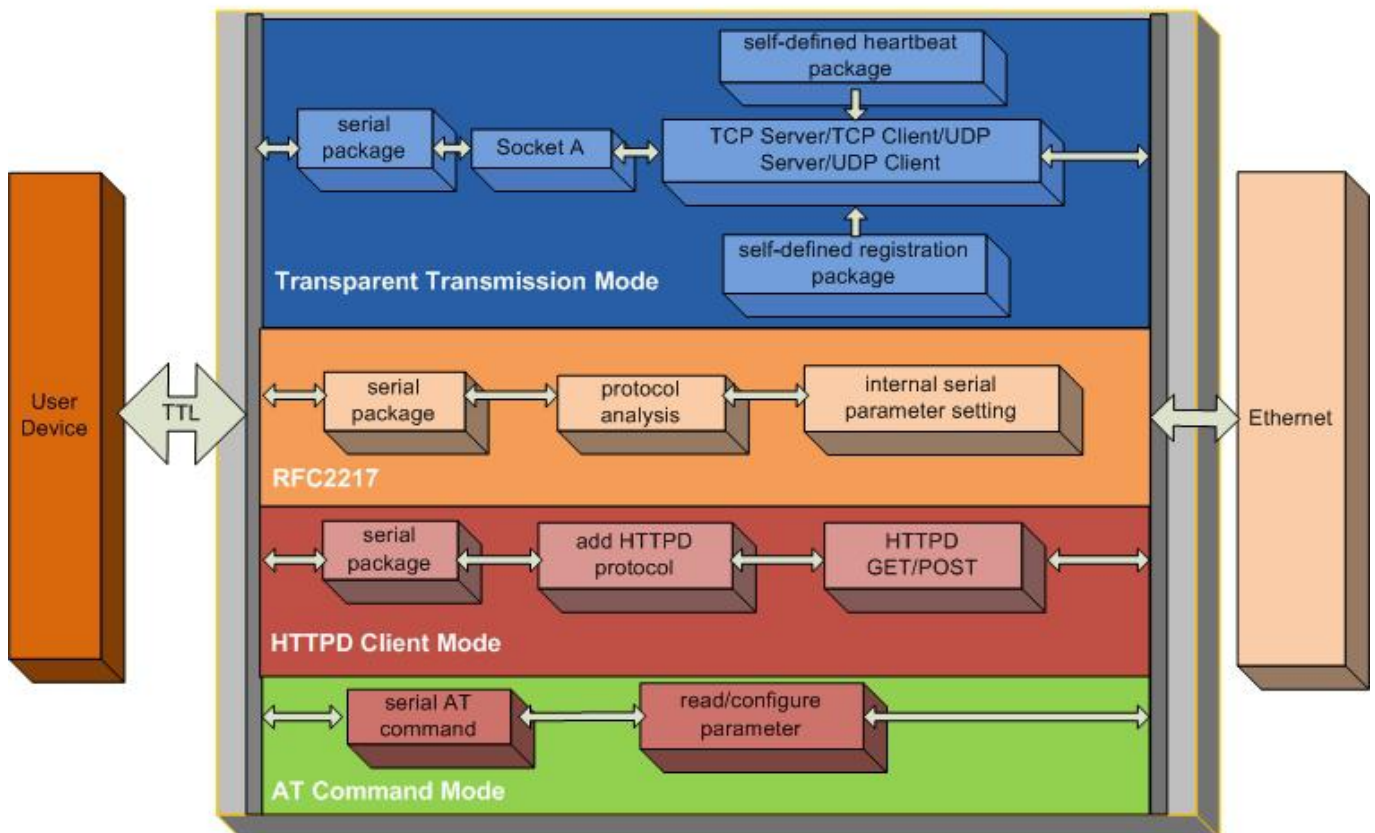

Diagram 6 USR-TCP232-S2 function flow

#### 3.1. Work mode

TCP Client, TCP Server, UDP Client, UDP Server, HTTPD Client

##### 3.1.1. TCP Client mode

It has to be connected before transferring data.

- 1) In TCP Client Mode, TCP232-S2 connects TCP Server actively, establish a connection to transmit data
- 2) In TCP Client Mode, It has function of identifying disconnected link. When connected, it will send keepalive package every 15s. If unconnected, it can be detected timely and enforce TCP232-S2 to disconnect the former link to establish a new one.
- 3) When TCP232-S2 try to connect remote server, if the local port number is not "0", it will establish a connection with the same source port every time.
- 4) It has synchronizing function of baud rate, user should install USR VCOM Software.
- 5) When local port number is "0", it means local port is random.

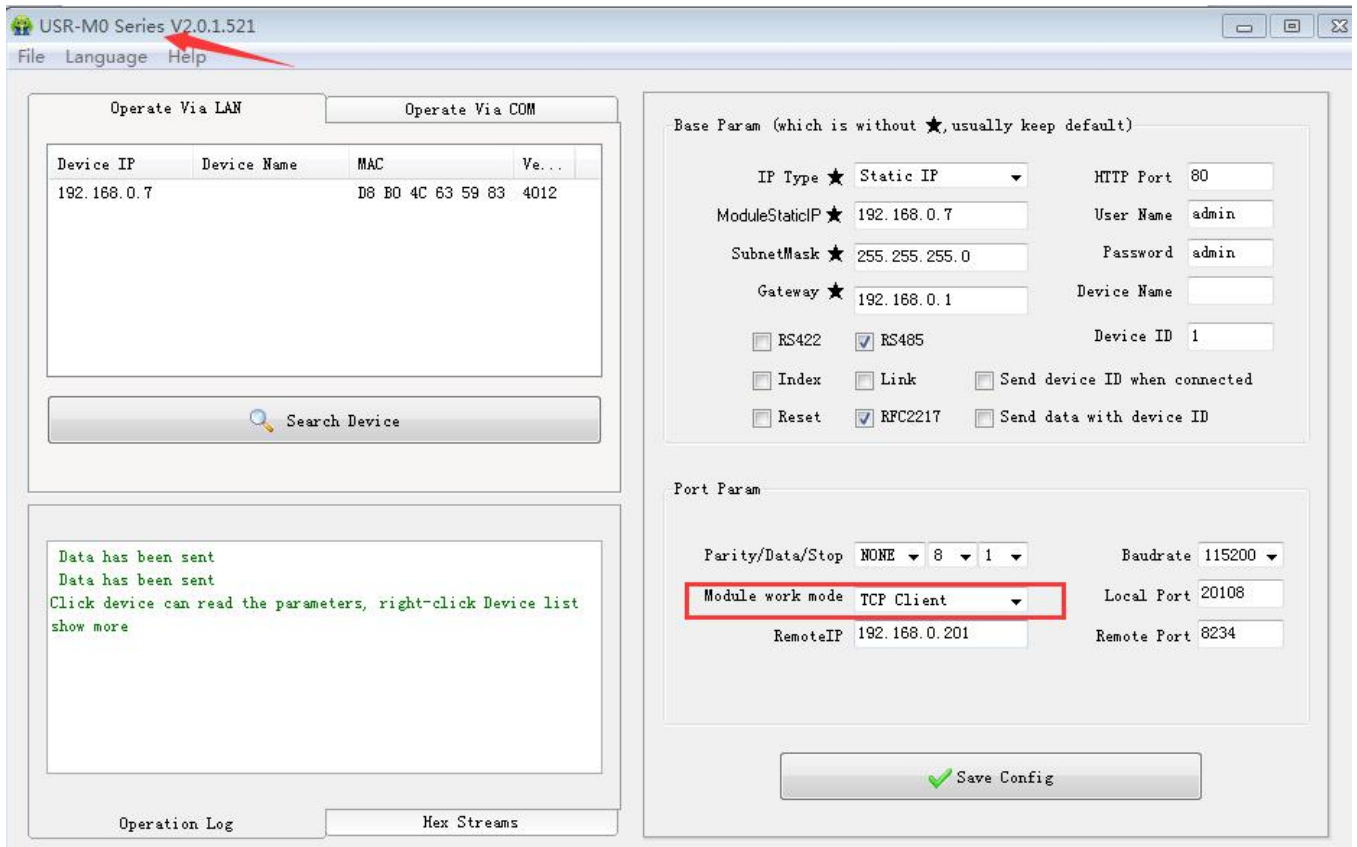

### TCP Client Setting

- TCP Client Mode

Module starts connection to all set TCP Server; if connection fails, module will try to reconnect till success  
If connection succeeds, Server will transmit data with serial device

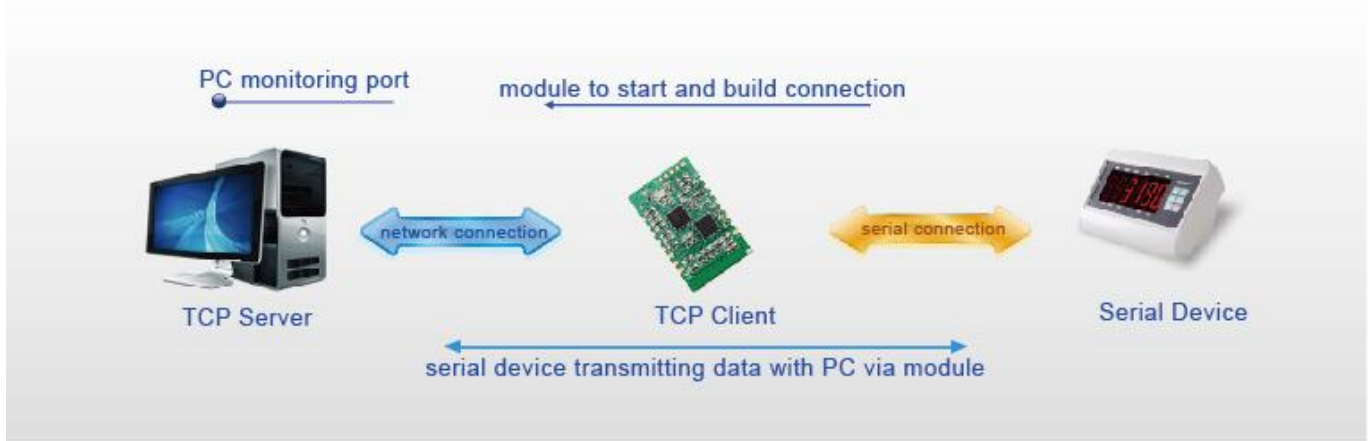

### TCP Client mode

#### 3.1.2. TCP Server mode

- 1) It has to be connected before transferring data.
- 2) In TCP Server Mode, S2 monitors local port, it will response and establish a connection when there is a request. Up to 4 links at the same time. Once received data, S2 serial port will send data to all the devices

which connect to TCP232-S2.

3 ) It has synchronizing function of baud rate, user should install USR VCOM Software.

4) In TCP Server Mode, The maximum number can be configured by user. TCP Client number is from 1 to 16, default value 4. When the Client link is more than 16, the new link will replace the former link from Link 1. If the Client link is more than 4, send and receive data at same time, the data flow should be within 2.5 KB/s

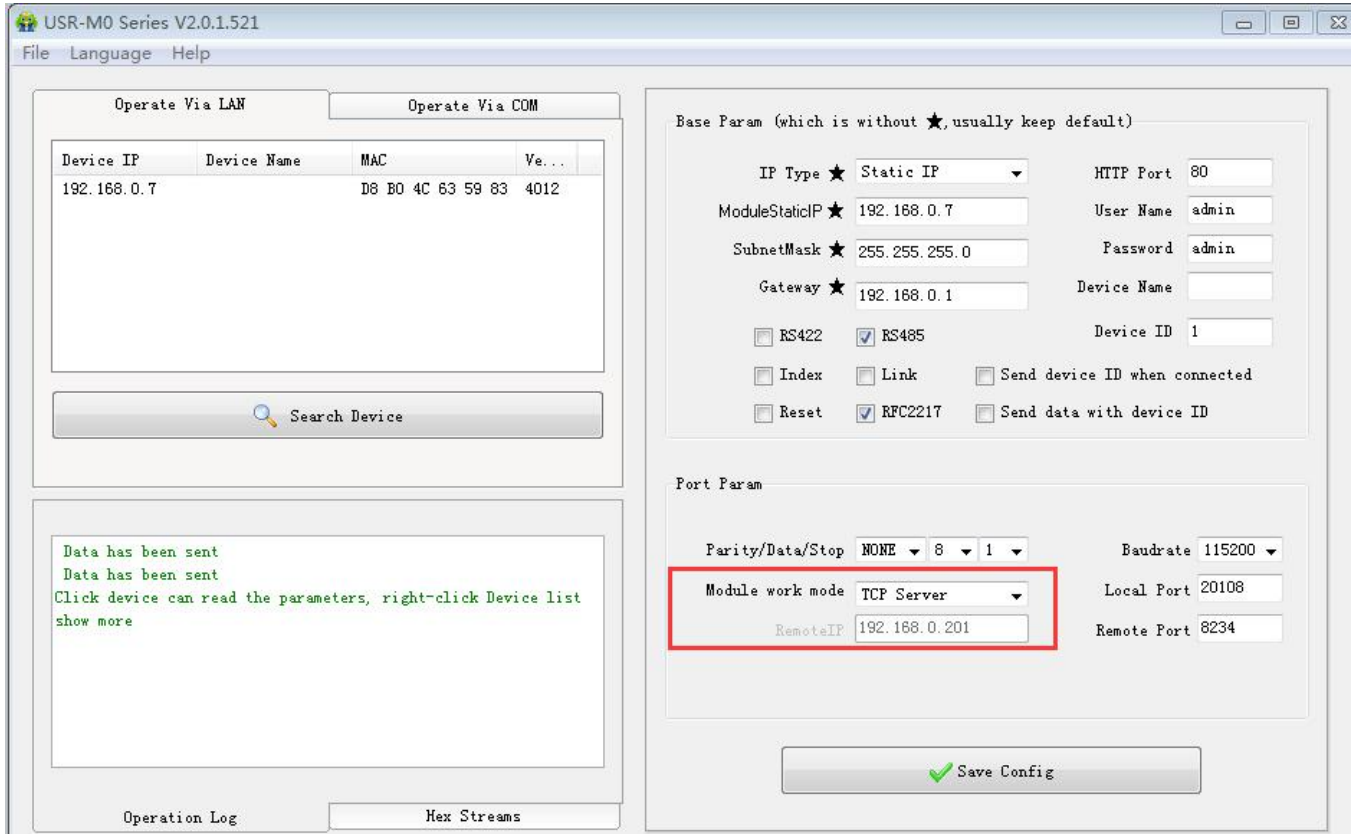

### TCP Server Setting

- TCP Server Mode

Module monitors the set port and waits for TCP Client to connect

Data sent by serial device will transmit to all successfully-linked Clients via module

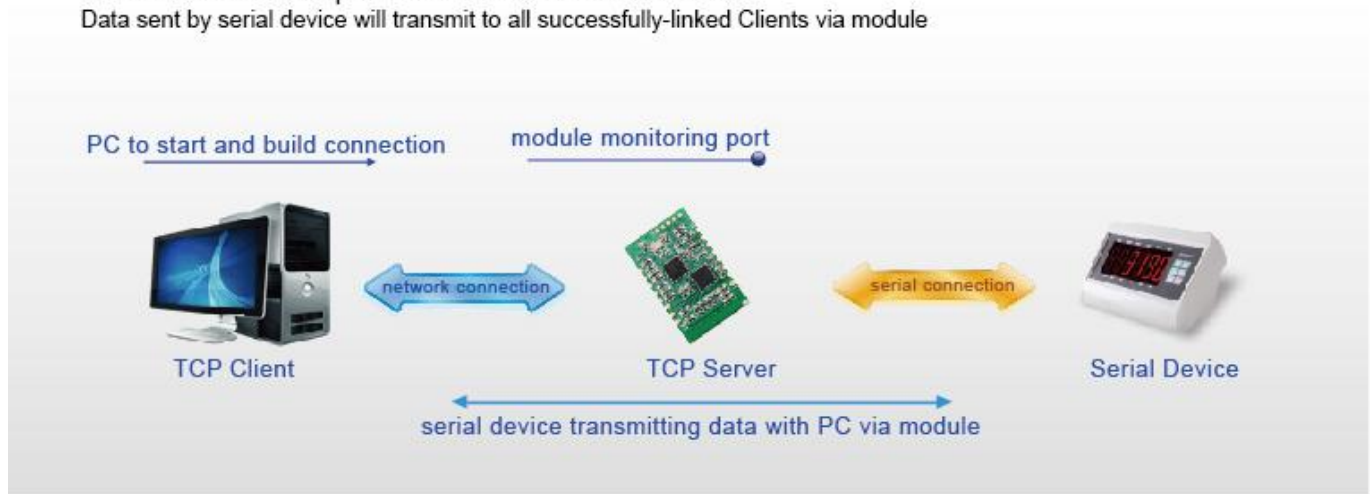

### TCP Server mode

### 3.1.3. UDP Client mode

- 1) The mode belongs to UDP Protocol.
- 2) In UDP Client Mode, TCP232-S2 won't establish the connection actively. It can only communicate with the target port whose IP has been set. When serial port receive data, it send data to target IP and port. If data doesn't come from this channel, it will not be accepted by TCP232-S2.
- 3) In UDP Client Mode, if target IP is set as 255.255.255.255, it can realize function of entire network broadcast, also can receive broadcast data. If broadcast in network segment ,eg.192.168.0.255, it can only send data ,can't receive data.
- 4) Under UDP Client, maximum data length sent from MCU to TCP232-S2 is 1460.

- UDP Mode

Module sends data of serial device to the set network device  
Module monitors port and sends the received data to serial device

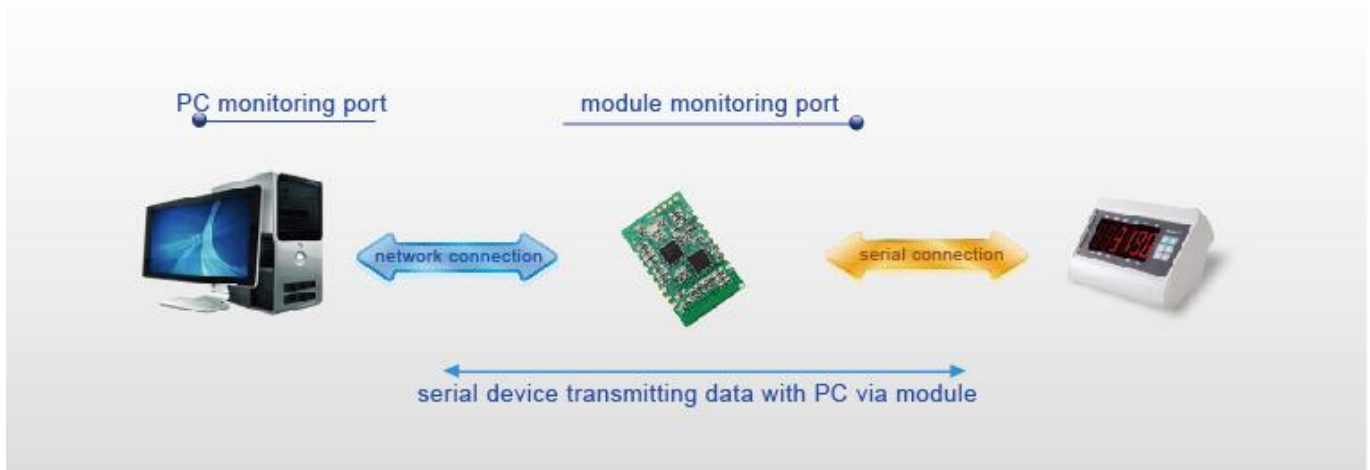

### UDP Client mode

### 3.1.4. UDP Server mode

- 1) UDP Server is based on normal UDP, it doesn't validate the source of IP address. Once received UDP data, it convert target IP to data source IP, similar to TCP Server.
- 2) In UDP Server Mode, TCP232-S2 records an IP, Once it receives data, it will send data to record IP. TCP232-S2 also works as a server, can receive data from Ethernet and convert target IP to data source IP.

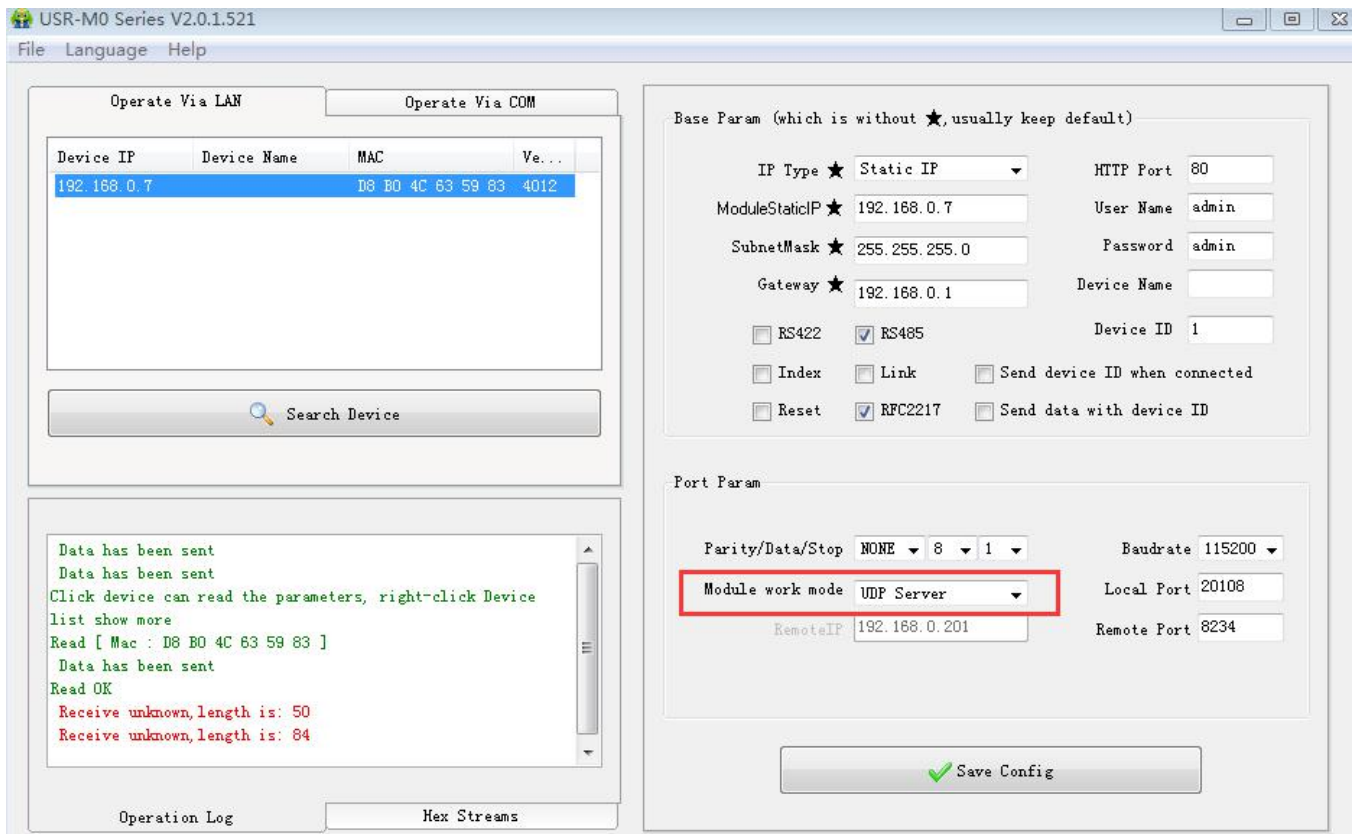

**UDP Server Setting**

### 3.1.5. HTTPD Client

This function is used for developer.

- 1) Module S2 send data to HTTP Server or receive from HTTP Server, complex HTTP protocol will be done by S2, it is convenient for user to programming.
- 2) S2 received data from HTTP Server will send to serial port without process.
- 3) According to demand, user can define HTTP content.

### 3.1.6. TCP and UDP mechanism

**Table 4 TCP and UDP mechanism**

	TCP	UDP
Advantages	Stable; Not easy to lose data package; Reliable connection mechanism;	Transmission interval is accurate; No connection mechanism; Easy and flexible;
Disadvantage	Easy to block up Information; Because of check and resend mechanism, interval isn't accurate	Under bad network condition, it is high risky to losing data package

## 3.2. DHCP and DNS Function

DHCP: Dynamic Host Configuration Protocol

When S2 connects to remote server, it can obtain an IP address automatically which router or gateway distributed. If you don't know how to set IP address or it can't connect because of the set IP is not in the same segment, the function is helpful for you.

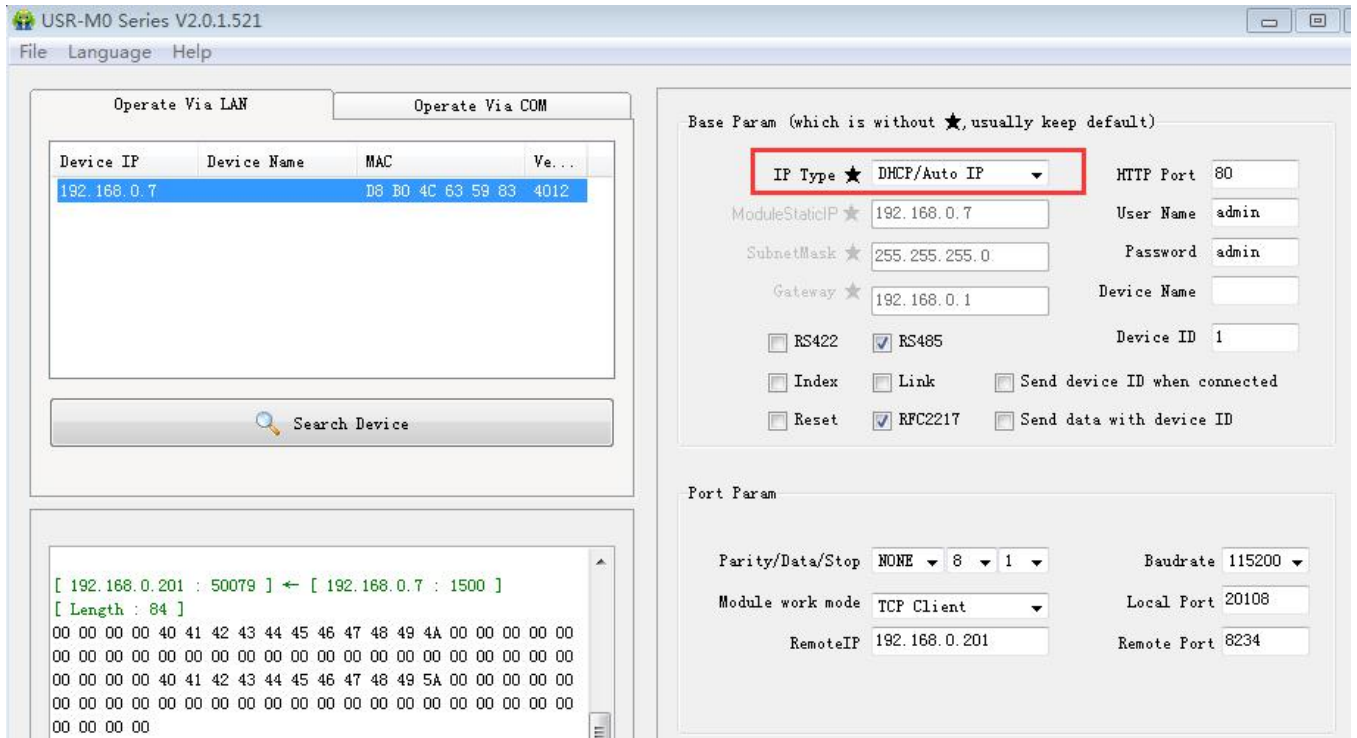

Diagram 7 DHCP

DNS: Domain Name System

e.g. domain name sever is cloud usr.cn, when we don't know Server IP or Server IP changed, this function plays an important role.

Note: when use NDS function, S2 gateway must be same as router IP or choose DHCP function.



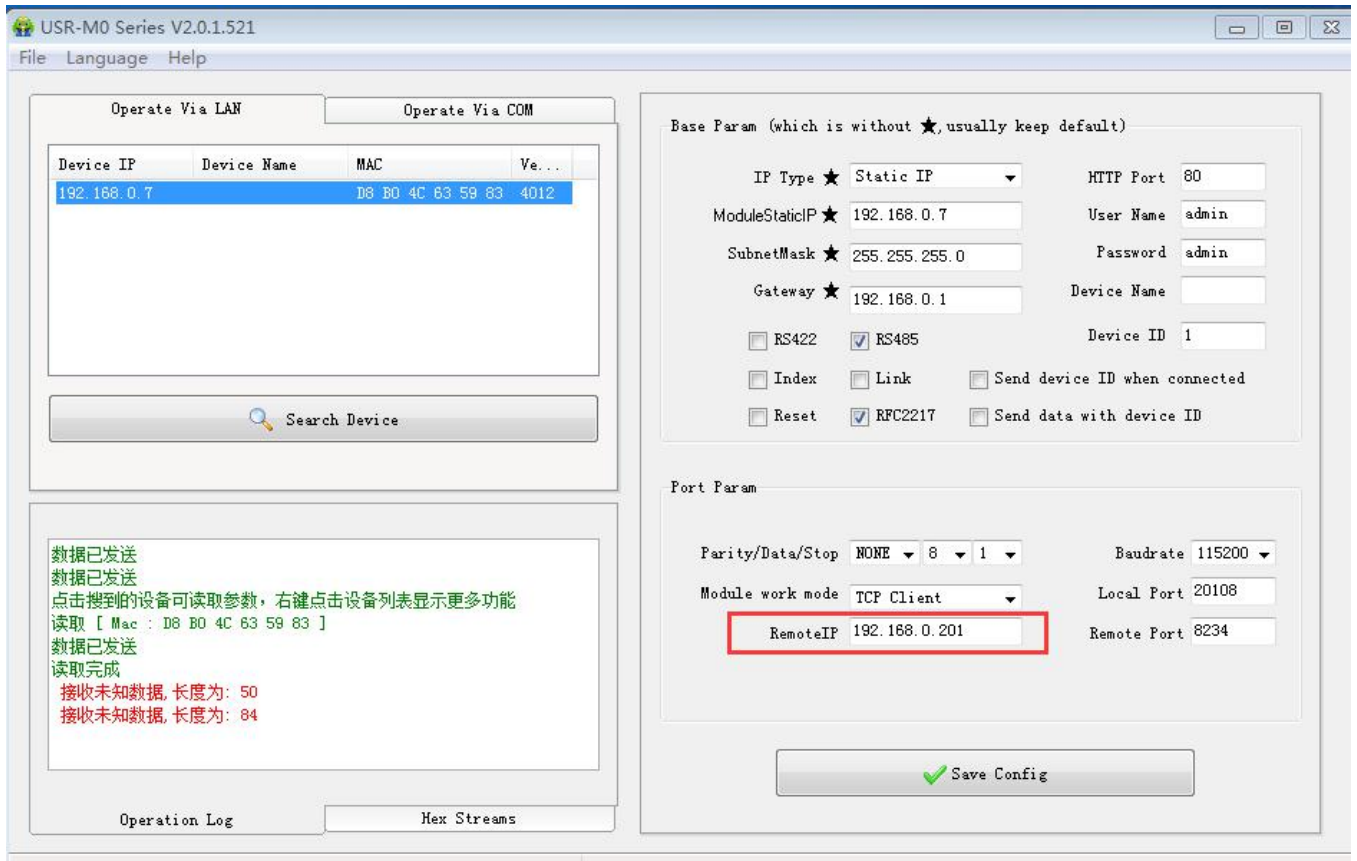

Diagram 8 DNS

### 3.3. VCOM

USR-VCOM Download: <http://www.usriot.com/usr-vcom-setup-software-v3-7-1-520/>

USR-VCOM Manual: <http://www.usriot.com/usr-vcom-setup-software-user-manual-v3-5-2/>

If user's upper computer and device are all connect by serial port, user can create a COM which has TCP/IP to realize remote control by USR-VCOM software.

- 1) Turn off firewall and anti-virus software.
- 2) Install USR-VCOM.

I advise user to choose "Search" or "Smart vcom" to create virtual port. **Please refer to 4.3.3**

#### 3.3.1. Module Works as Client

- 1) Set module parameters. S2 work mode: TCP Client.
- 2) Open USR-VCOM, set virtual port as follows :

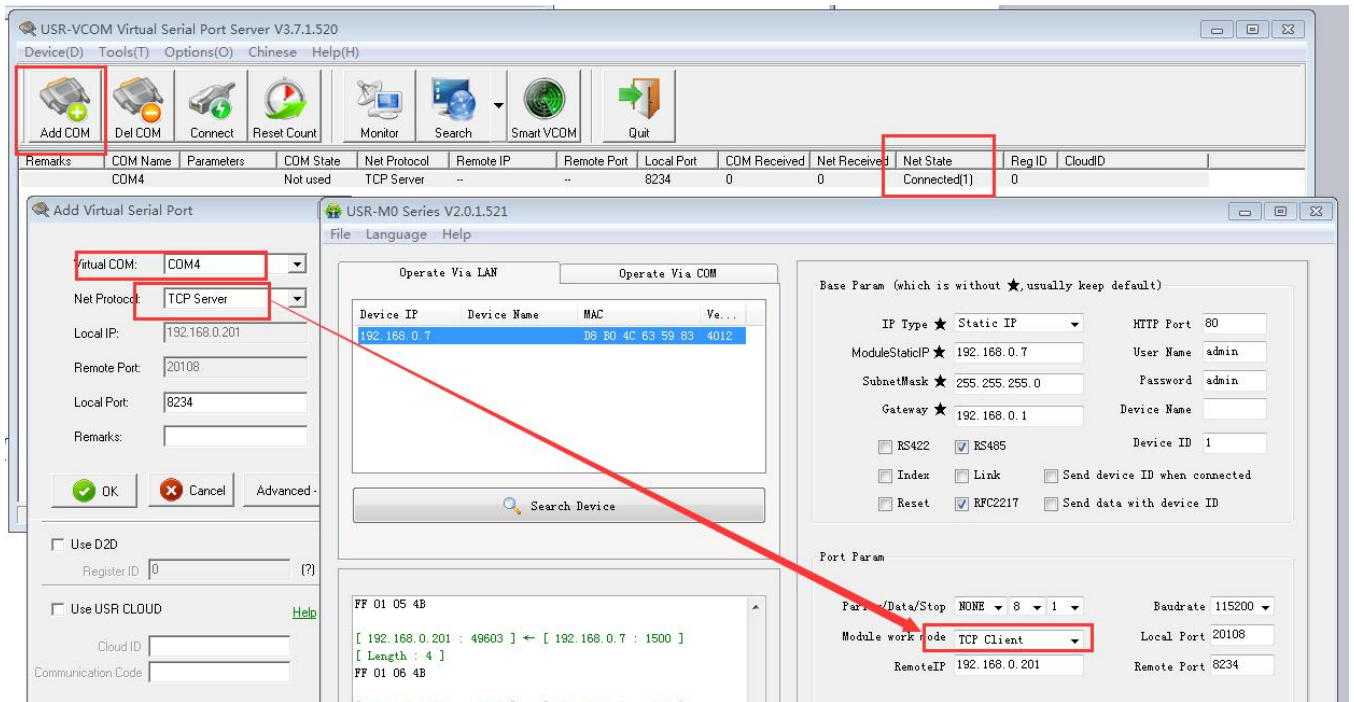

**Diagram 10 Create Server Virtual Port**

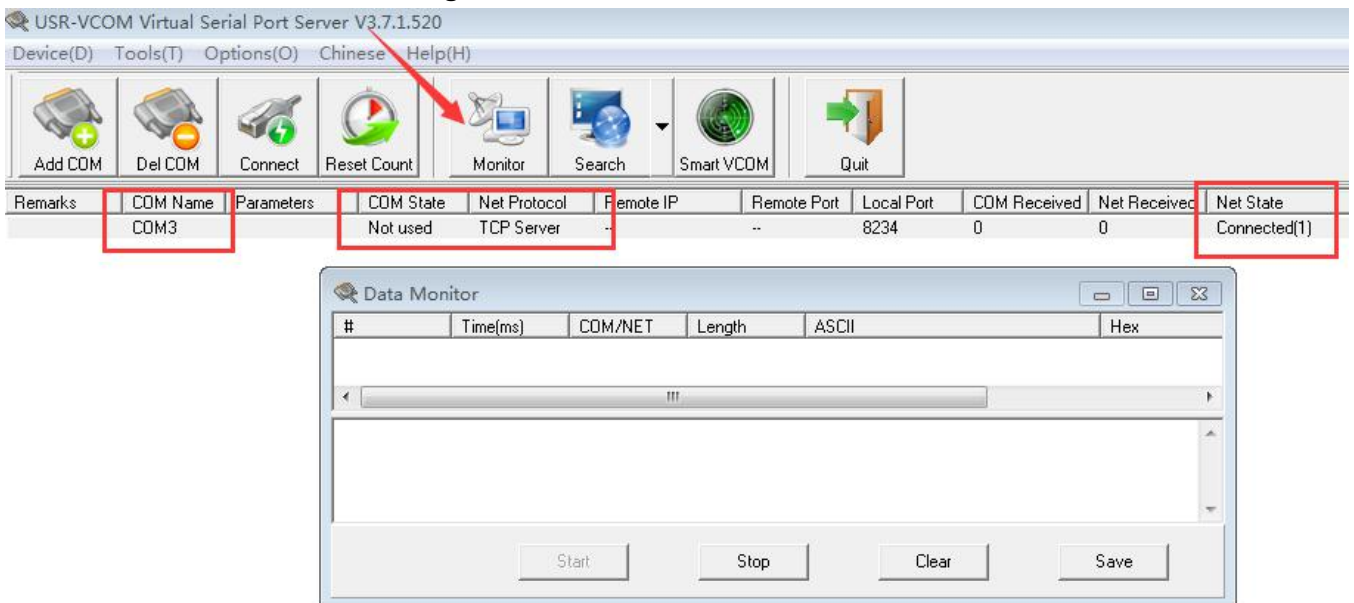

**Diagram 11 VCOM software monitor function**

### 3.3.2. Module Works as Server

- 1) Set S2 work mode: TCP Server.
- 2) Set virtual port as follows:

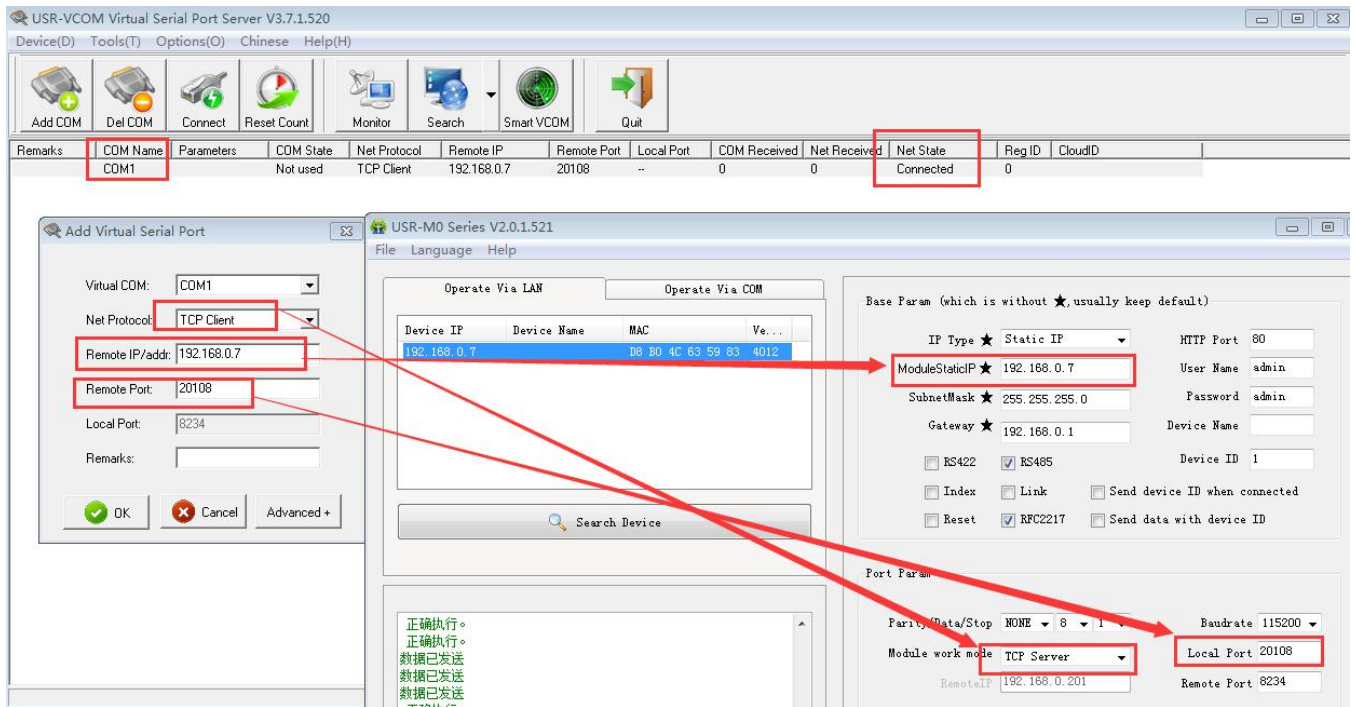
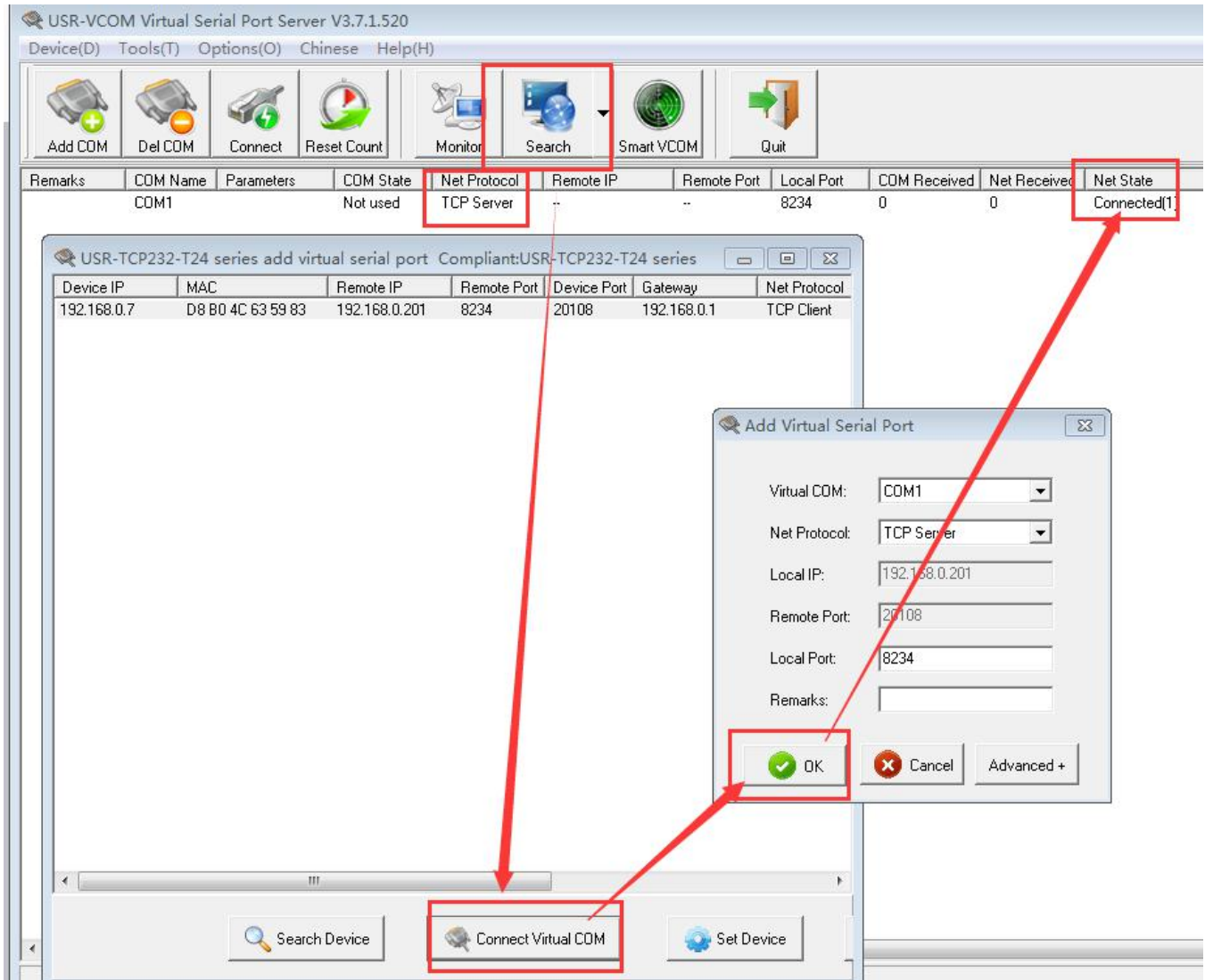

Diagram 12 Create Client Virtual Port

### 3.3.3. Create VCOM

1) Create VCOM by "search" button.





**Diagram 13 Search Function**

2) Automatically Create

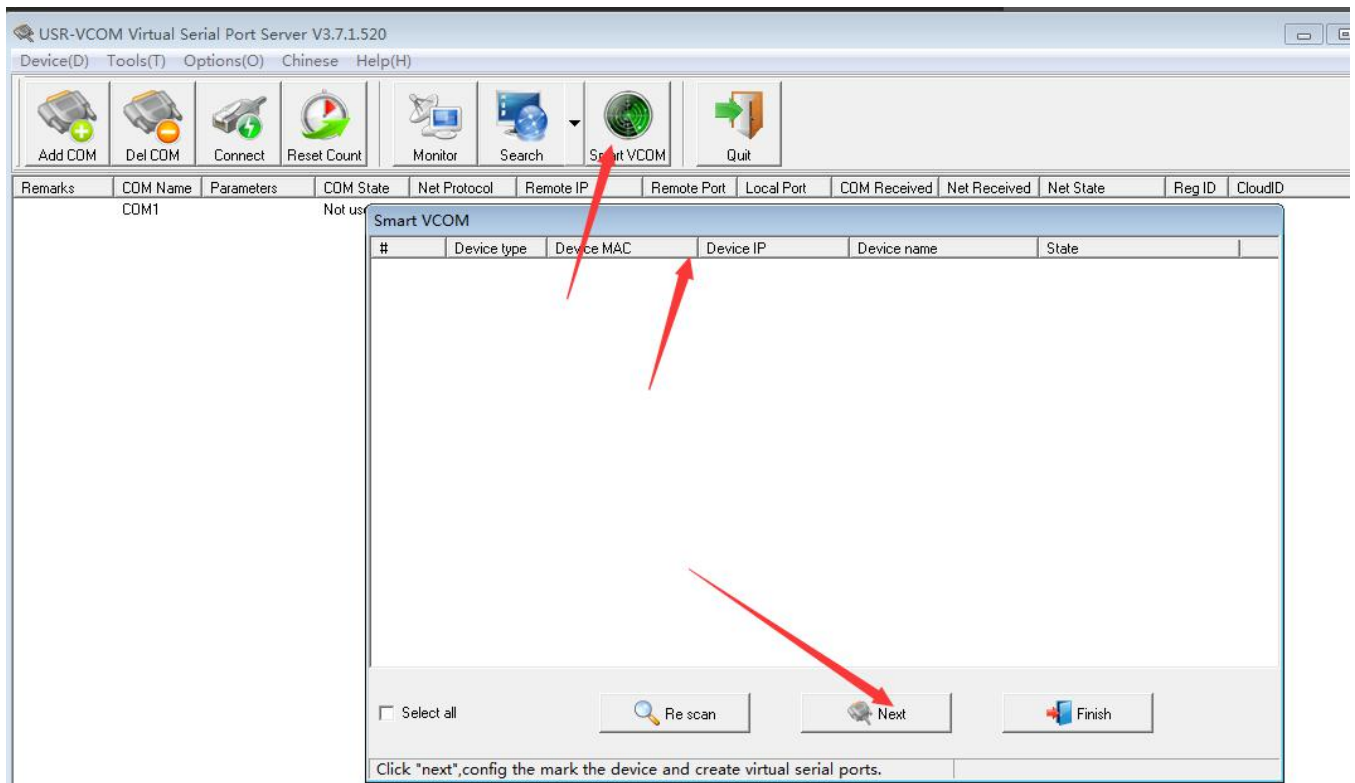

**Diagram 14 Smart VCOM**

## 3.4. Special Function

### 3.4.1. RS485 Function

S2 reserved 485 pin, this function can be set by software, won't effect RS232 communication.

### 3.4.2. Transparent transmission cloud

This function is used to get communication between module and MCU, transmit remote data transparently . <http://cloud.usr.cn/en>

Cloud user name and password can be set through software.

### 3.4.3. Link Function

Link pin can be used as indication pin for TCP connection status.

When connected, it output low level; When unconnected, high level.

When S2 is under TCP mode, Link pin will pull down, otherwise, it stays in high level.

When S2 is under DUP mode, Link pin will always pull down. By default ,it is not checked .

### 3.4.4. Factory Reset

1) Hardware: At first, check "Reload" in webpage or software, then Reload can only used to restore factory settings. After setting then module will reset, pull " Reload " down to 0 V level for 5 seconds then pull CFG( Reload) up to 3.3 V or don't connect it, factory reset is finished.

- 2) Software: finish it by set-up software.
- 3) AT Command: After entering into AT Command, then send AT+ clear.

### 3.4.5. Reset Function

When S2 works as TCP Client, S2 connects to TCP Server actively. When start Reset function, S2 try to connect to TCP Server for 30 times. If failed, S2 will restart automatically. By default, it won't be chose.

### 3.4.6. ID Function

When S2 works as TCP Client, it send module ID when establishing connection or carry ID when in communication, S2 ID is decimal .1-65535 ( ID function and transparent transmission can't work at same time )

### 3.4.7. Index Function

When S2 works as TCP Server, it can establish 16 links simultaneously at most. The max number can be set from 1 to 16. Default is 4. Take 16 link as example, Server send data to 16 Client simultaneously or Server can't distinguish the data source, Index can realize the choice of data source of sending or receiving.

Index function can be set by software or web-page.

### 3.4.8. Similar RFC2217 Function

This function is used to change USR-TCP232-S2 serial port parameter through network.

E.g: change baud rate from 115200bps to 9600bps. It can be set by software or webpage. By default , it is in open state.

When using VCOM software, this function also works, the baud rate of software in PC will match Autonomic with the baud rate of USR-TCP232-S2, don't need to focus on serial port baud rate .After restart, it is default parameter .

## 3.5. New Function

### 3.5.1. AT Command

According to AT Command protocol , TCP232-S2 enter into AT Command mode and set parameter More details ,please refer to 《USR-TCP232-S2 software manual》

When pull low CFG(Reload)Pin firstly, S2 will set parameter by port , AT Command is invalid.

When enter into AT Command Mode, then pull down CFG(Reload), S2 will set parameter by port firstly, AT Command is invalid. User pull up or don't connect CFG(Reload), it enter into AT Command Mode again.

### 3.5.2. Display IP and Data

On the web page of TCP232-S2, it can display the IP of device and sent/received data byte, and the total data byte of TCP232-S2.

In TCP Mode, it can display the TOP 5 device IP and sent/received data byte. In UDP Mode, it only display sent/received data byte,don't display connection IP.

### 3.5.3. Set Client Number in TCP Server Mode

In TCP Server Mode, The maximum number can be configured by user. TCP Client number is from 1 to 16, default value 4. When the Client link is more than 16, the new link will replace the former link from Link 1

When the Client link is more than 4, send and receive data at same time , the data flow should be within 2.5 KB/s.

### 3.5.4. Defined MAC Address

Mac address can be modified. Factory Mac address is exclusive.

### 3.5.5. Defined DNS Server IP

To resolve server domain name, user should send data by gateway or router, then gateway or router Distributes IP address, it can show IP in the webpage. User can set specific domain name resolution IP, to specific gateway or router to resolve domain name.

### 3.5.6. Defined Registration Package

The content of registration package can be defined, 40 bytes at most.

It includes sending registration package when connecting and carrying registration package when sending data. It can be used singly or together.

It is set by webpage, support decimal input and hexadecimal input. By default ,this function isn't open..

### 3.5.7. Defined Heartbeat Package

The content of heartbeat package can be defined, 40 bytes at most. Time set from 1s to 255s

It can ensure connection is reliable, put an end to connect feign death; It can send to LAN Port or Serial Port singly or at same time.

### 3.5.8. HTTPD Client

TCP232-S2 has HTTPD Client , it support GET and POST. In HTTPD Client, package head and end can be modified . In GET Mode, package head data is replaced by "\$". In POST Mode, put port data in the end, "\$" means data length in package head, TCP232-S2 will assign a value, user don't need to modify. The Parameter can be set in webpage.

## 3.6. Firmware Upgrade

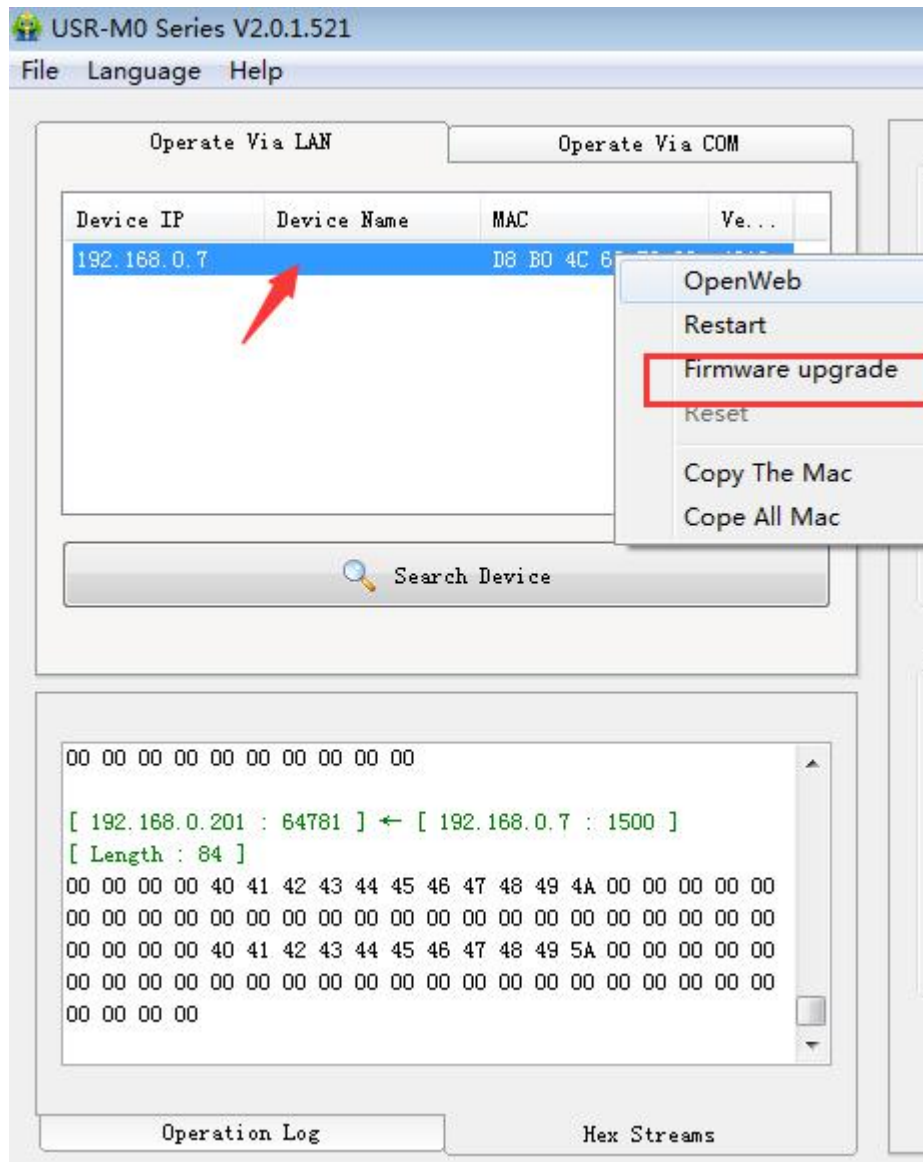

**Diagram 17** Firmware upgrade

## 4. Parameter Setting

At first, user should connect PC to TCP232-S2 Lan port ,then set parameter by webpage or software. TCP232-S2 connects Auto-MDI/MDIX RJ45 port with 10/100Mbps. It support Router connection and direct connection.

- 1)TCP232-S2 connect PC by Lan cable, user should set parameter for PC. When TCP232-S2 connects to power supply and PC, module will connect PC directly. (Module IP and PC IP should in the same Network segment )
- 2)TCP232-S2 connects PC by router, one PC can connect several modules or one module connects Several PC (When modules works as TCP Server , at most it can connect 16 clients )



## 4.1. Webpage Setting

User should set parameter as follows:

- ❖ Work mode:
  - ◆ TCP Client、TCP Server、UDP Client、UDP Server、HTTPD Client
- ❖ Default TCP/UDP connection parameter
  - ◆ Connection type (Server, Client, HTTPD Client)
  - ◆ Target Port
  - ◆ Target IP address
  - ◆ Local Port
- ❖ Serial Port parameter
  - ◆ Baud rate
  - ◆ Data bit
  - ◆ Check bit
  - ◆ Stop bit
  - ◆ RS485 function
- ❖ IP address and module password
  - ◆ The way of getting IP address.
  - ◆ Module name and password

After setting parameter then reset the module .

## 4.2. Log in

Open a browser, type 192.168.0.7 , Name and password: admin

User can also log in by software.

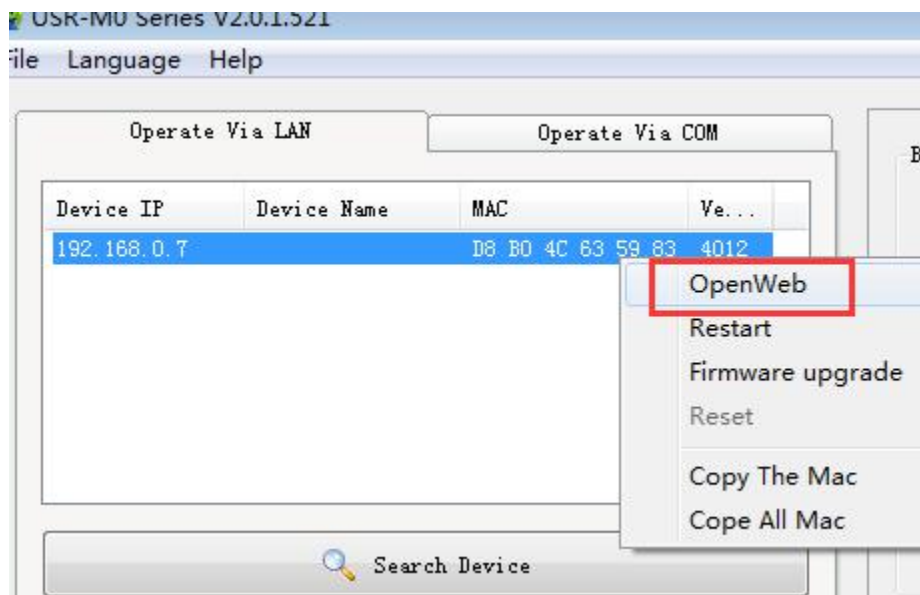
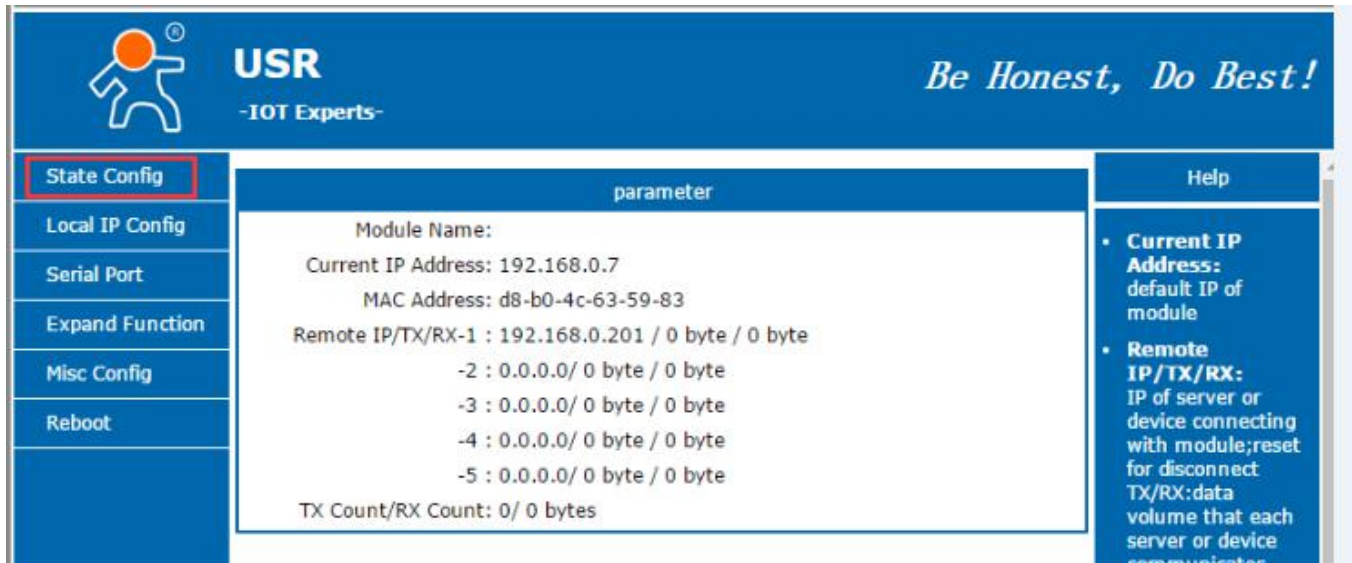

Diagram 18 Open Web

### 4.3. State Configuration

Module name , Current IP address , Mac address, Remote IP/TX/RX , TX Count/ RX Count.



parameter	Help
Module Name:	
Current IP Address: 192.168.0.7	• <b>Current IP Address:</b> default IP of module
MAC Address: d8-b0-4c-63-59-83	
Remote IP/TX/RX-1 : 192.168.0.201 / 0 byte / 0 byte	• <b>Remote IP/TX/RX:</b> IP of server or device connecting with module;reset for disconnect TX/RX:data volume that each server or device communicates
-2 : 0.0.0.0/ 0 byte / 0 byte	
-3 : 0.0.0.0/ 0 byte / 0 byte	
-4 : 0.0.0.0/ 0 byte / 0 byte	
-5 : 0.0.0.0/ 0 byte / 0 byte	
TX Count/RX Count: 0/ 0 bytes	

Diagram 19 State Configuration

### 4.4. Local IP

- 1)IP type : Static IP means fixed IP, DHCP means acquire IP automatically.
- 2)Static IP : when user choose Static IP, don't conflict IP address in the LAN.
- 3)Subnet mask: used to distinguish network segment, default value is 255.255.255.0
- 4)Gateway: Router IP address, it should be set correctly when used for domain name resolution.
- 5)DNS Gateway : Server IP of domain name resolution , by default it is module gateway.

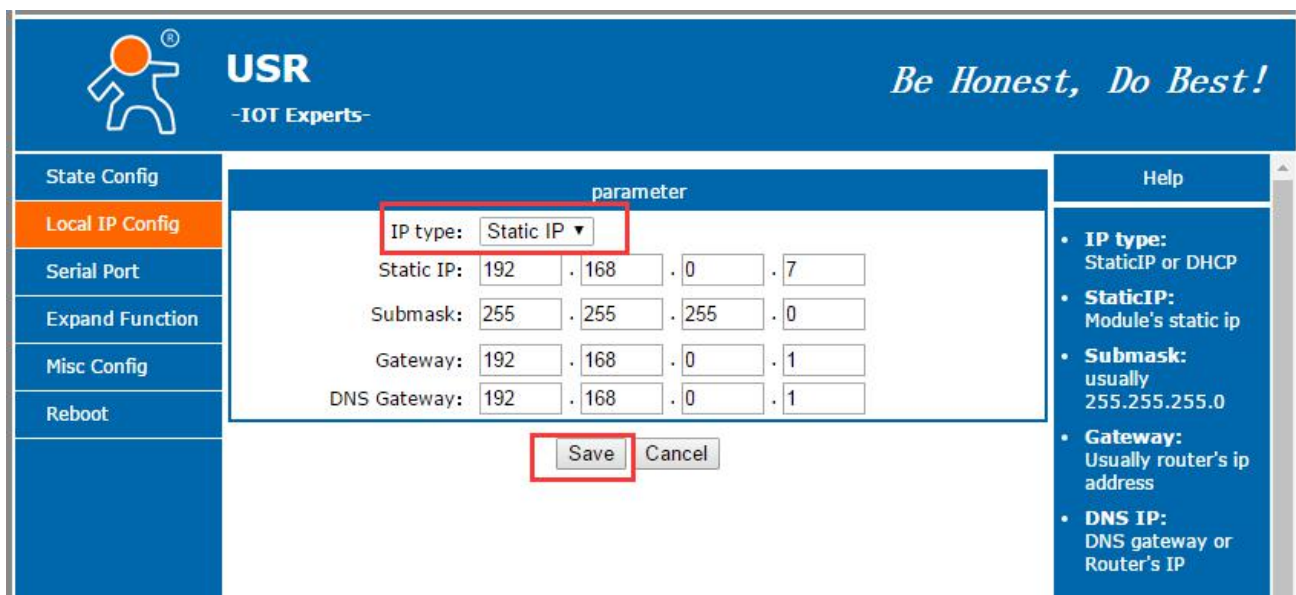

parameter	Help
IP type: Static IP	• <b>IP type:</b> StaticIP or DHCP
Static IP: 192 . 168 . 0 . 7	• <b>StaticIP:</b> Module's static ip
Submask: 255 . 255 . 255 . 0	• <b>Submask:</b> usually 255.255.255.0
Gateway: 192 . 168 . 0 . 1	• <b>Gateway:</b> Usually router's ip address
DNS Gateway: 192 . 168 . 0 . 1	• <b>DNS IP:</b> DNS gateway or Router's IP

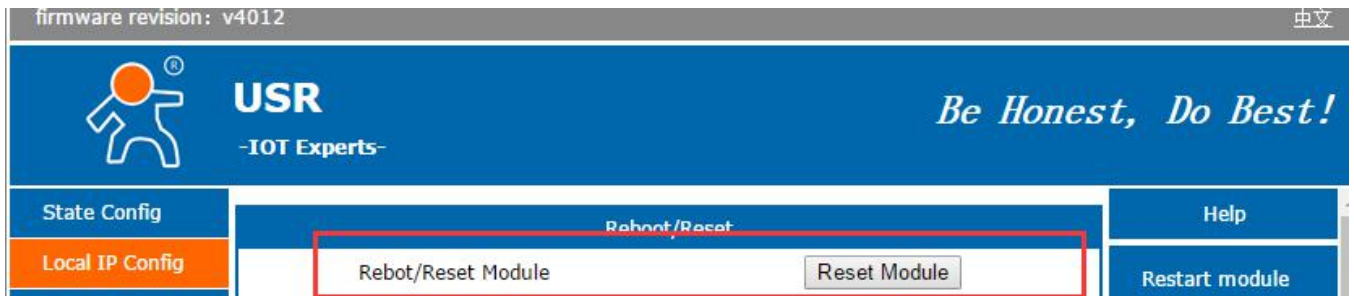

Diagram 20 Local IP

## 4.5. Serial Port Parameter

- 1) Baud rate: 600bps~460.8Kbps
- 2) Stop bit: 1,2.
- 3) Data bit : 5,6,7,8.
- 4) Check bit: NONE,ODD,EVEN,MARK,SPACE.
- 5) Local Port :By default ,it is local port number, it can set 0 if connect outer net.
- 6) Remote: Remote server port
- 7) Work mode :TCP Server, TCP Client,UDP Client,UDP Server,HTTPD Client.
- 8) Remote Server address: it can be IP address or server domain name.
- 9) HTTPD:HTTPD GET or HTTPD POST.

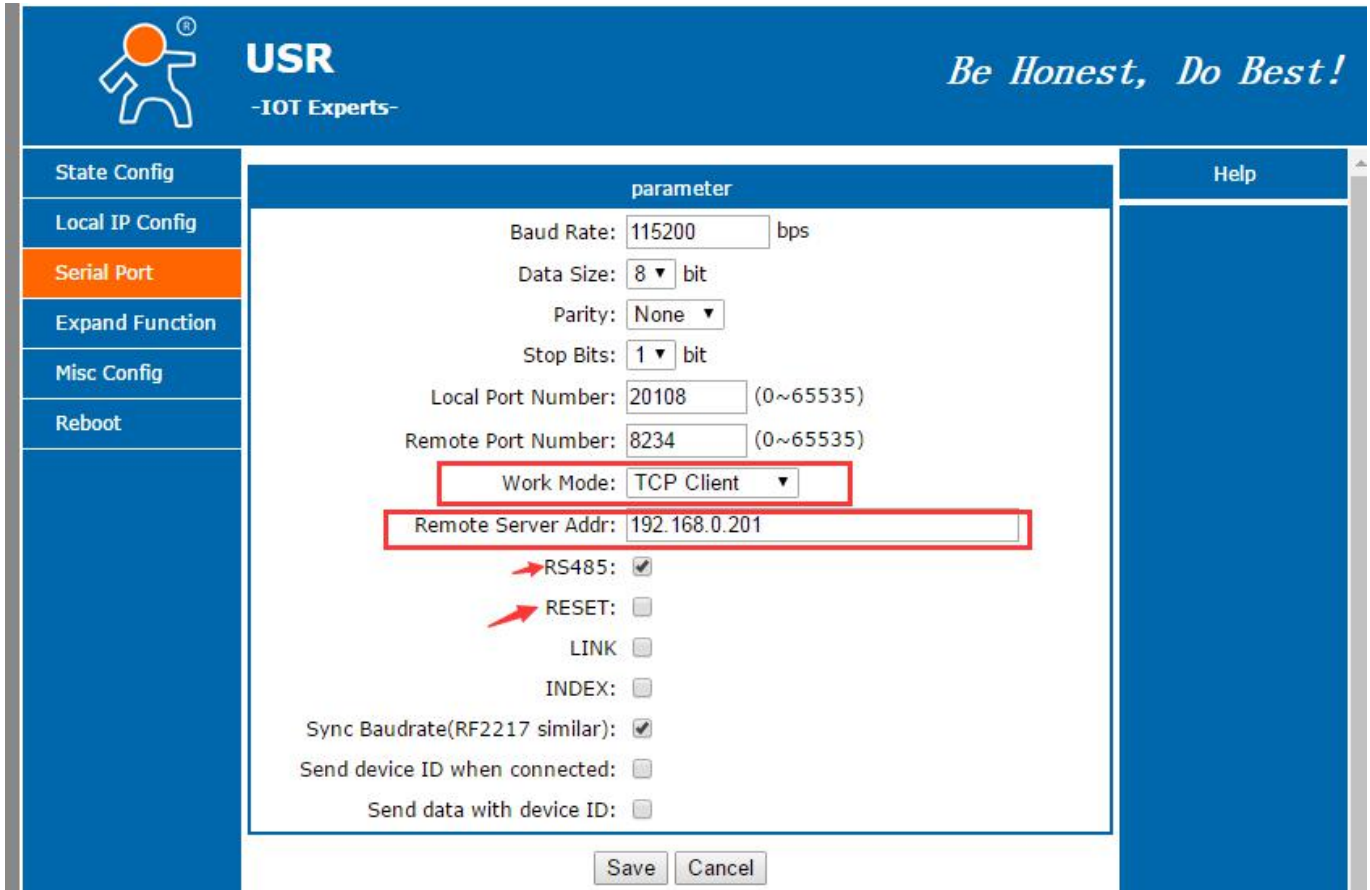
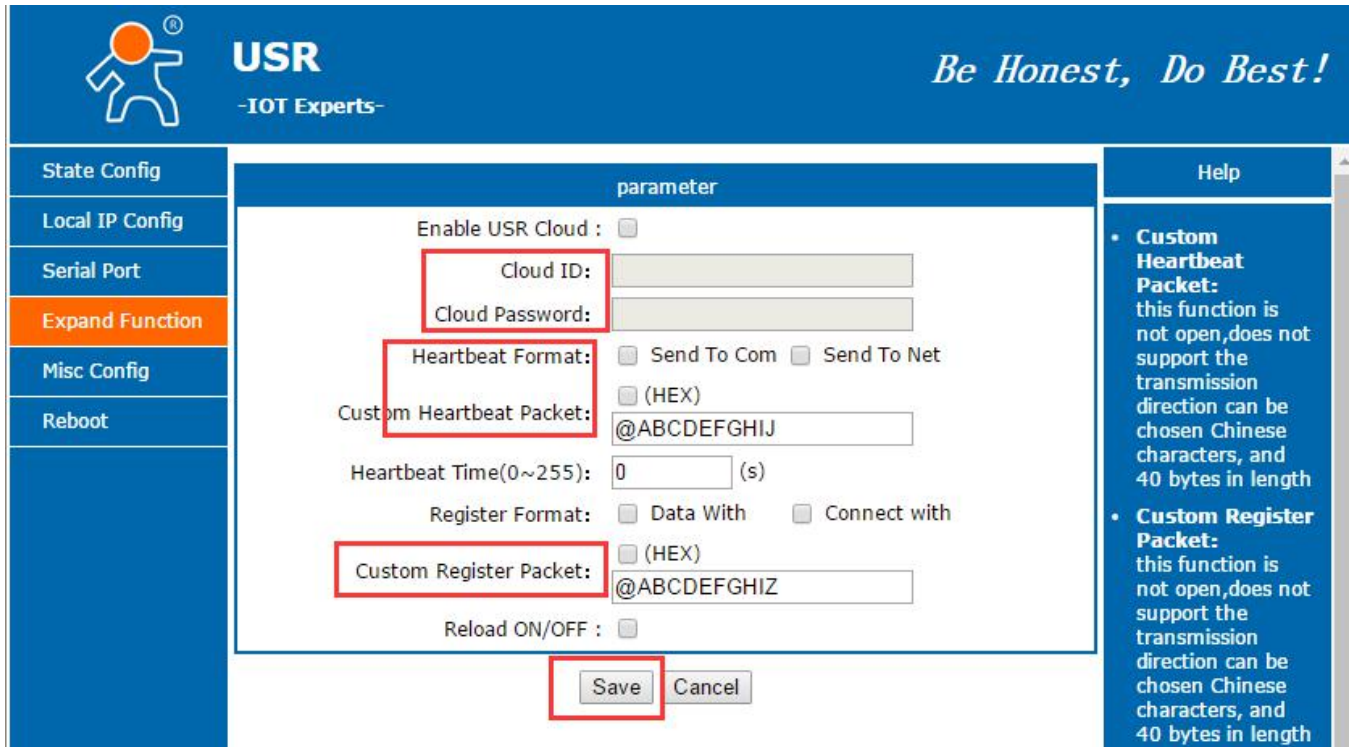

Diagram 21 Serial Port parameter

## 4.6. Expand Function



**parameter**

Enable USR Cloud :

Cloud ID:

Cloud Password:

Heartbeat Format:  Send To Com  Send To Net

(HEX)

Custom Heartbeat Packet:

Heartbeat Time(0~255):  (s)

Register Format:  Data With  Connect with

(HEX)

Custom Register Packet:

Reload ON/OFF :

**Help**

- **Custom Heartbeat Packet:** this function is not open, does not support the transmission direction can be chosen Chinese characters, and 40 bytes in length
- **Custom Register Packet:** this function is not open, does not support the transmission direction can be chosen Chinese characters, and 40 bytes in length

Diagram 22 Expand Function

## 4.7. Misc Configuration

After setting , click "save" ,then restart the module .

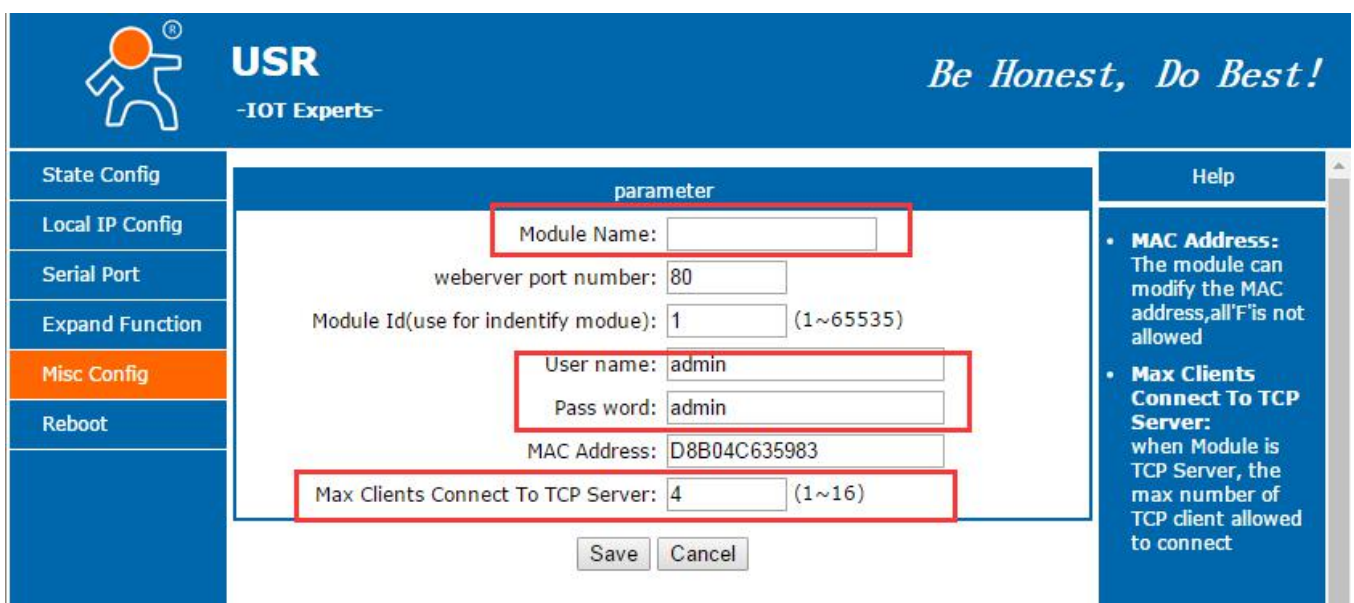

**parameter**

Module Name:

weberver port number:

Module Id(use for indentify modue):  (1~65535)

User name:

Pass word:

MAC Address:

Max Clients Connect To TCP Server:  (1~16)

**Help**

- **MAC Address:** The module can modify the MAC address, all 'F' is not allowed
- **Max Clients Connect To TCP Server:** when Module is TCP Server, the max number of TCP client allowed to connect

Diagram 23 Misc Setting

## 4.8. Reboot

Only have reset function.

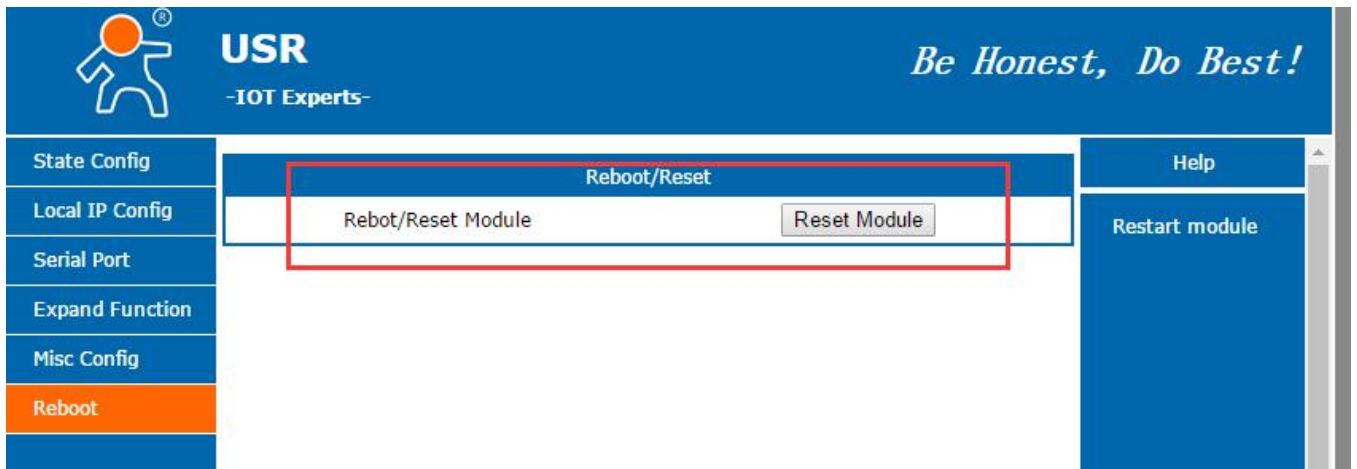
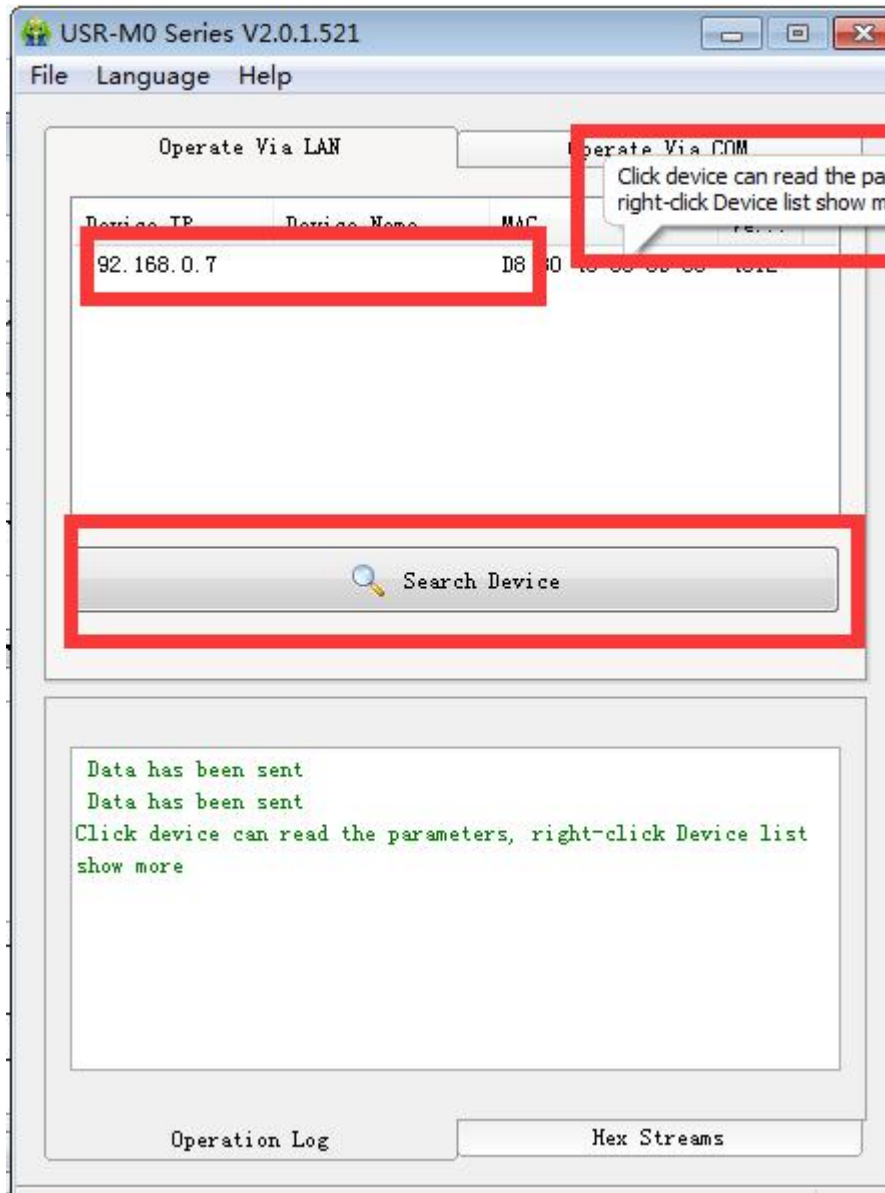

Diagram 24 Reboot Setting

## 4.9. Software Setting

1) Search device



**Diagram 25 Search**

2) Set parameters

After setting parameters, click "save".

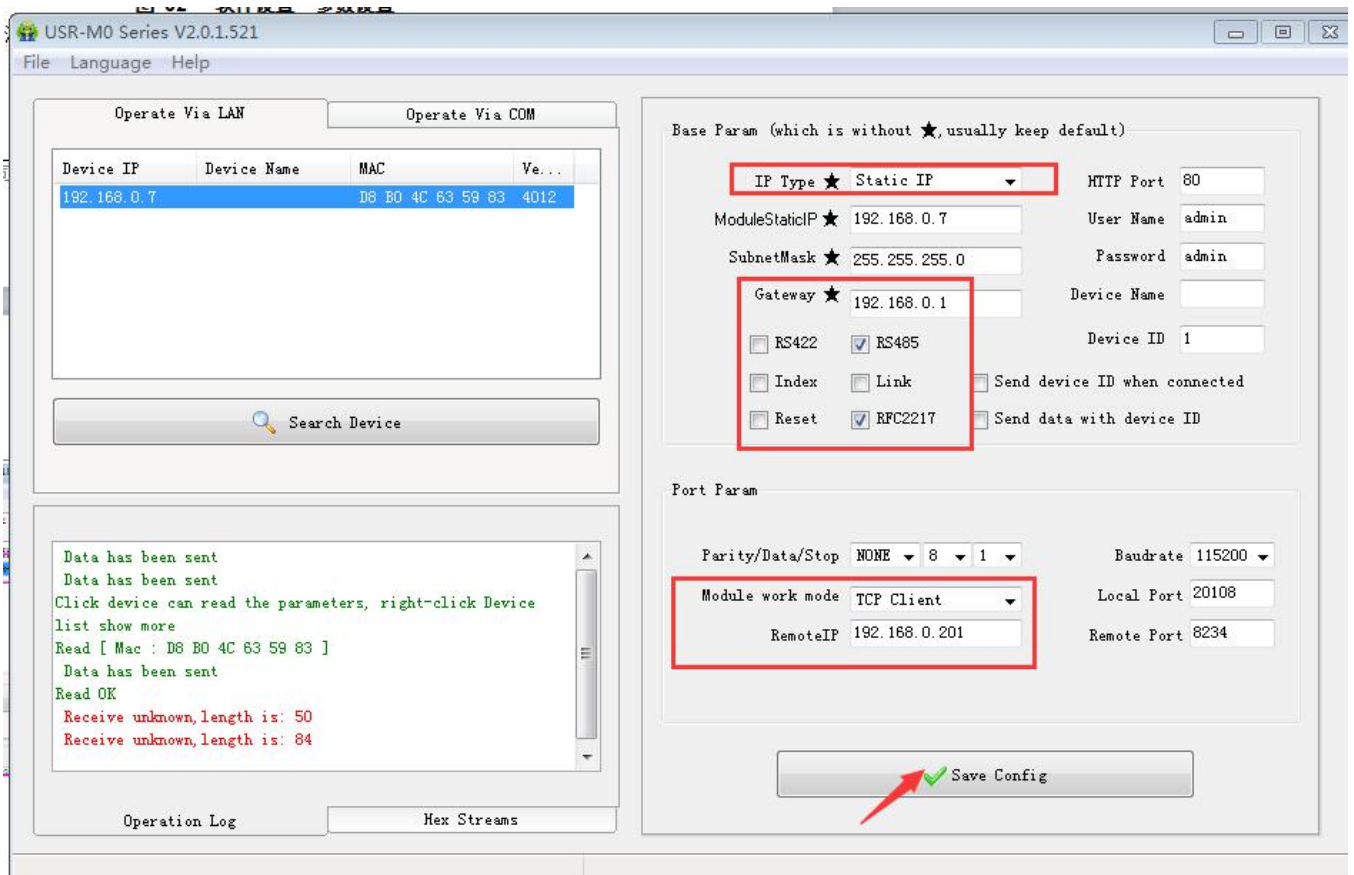

**Diagram 26 Parameter setting**

3) Check data

Click "Hex streams", check whether the data sends correctly.

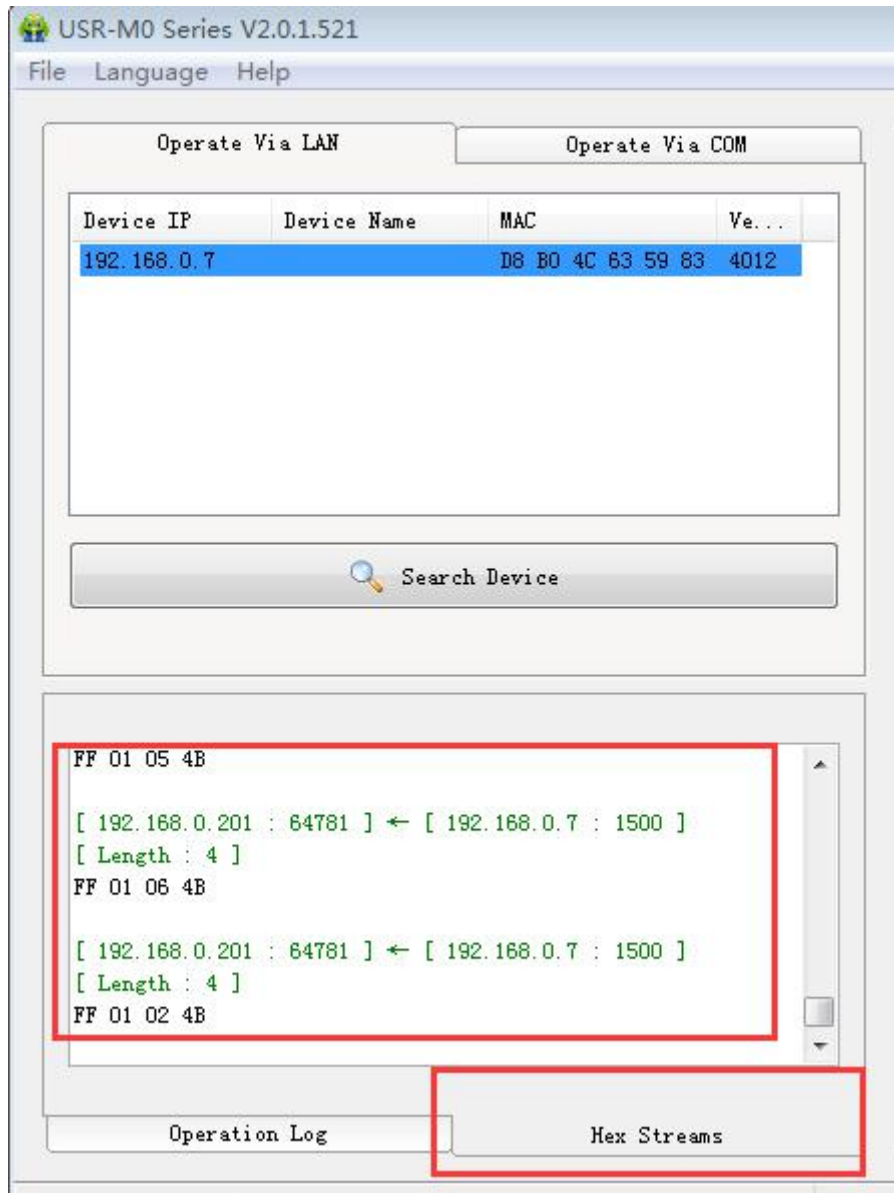

**Diagram 27 Check Streams**

4) Pull CFG(Reload) down and keep this state. Choose right COM, click"operate via COM", then Set parameter in the right page.

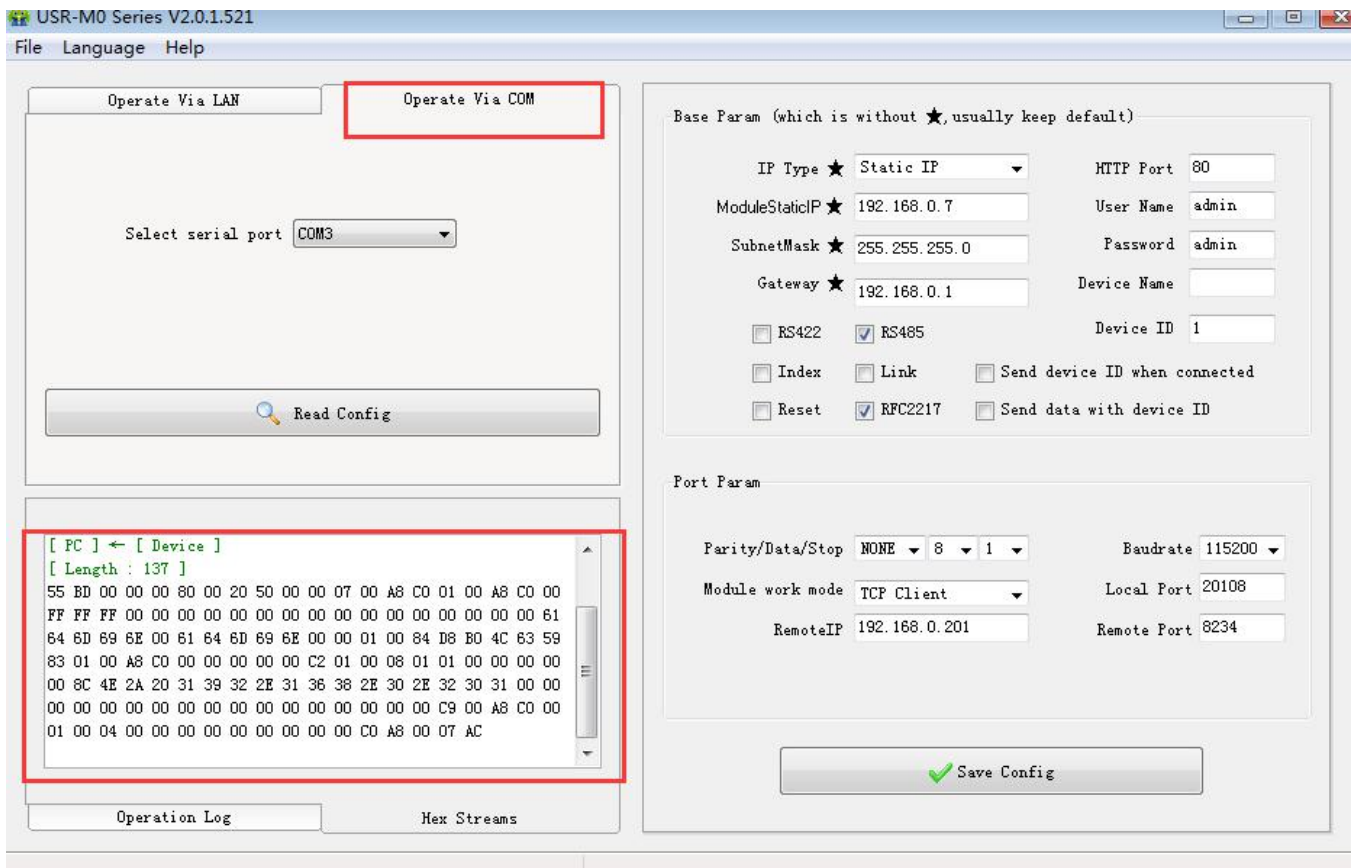

**Diagram 28 Port Setting**

## 5. Contact information

Company: Jinan USR IOT Technology Limited.

Address: Floor 11, Building 1, No. 1166 Xinluo Street, Gaoxin Distric, Jinan, Shandong, 250101 China.

Tel: 86-531-55507297 86-531-88826739-803

Web: <http://www.usriot.com/>

Support: <http://h.usriot.com/>

Email: [sales@usr.cn](mailto:sales@usr.cn)

## 6. Disclaimer

The document provides information about USR-TCP232-S2 module, it doesn't grant any license to the intellectual property rights. Except the responsibility declared in the product sale clause, USR does not assure any other responsibilities. In addition, USR does not make any warranties for the sale and use of this product, including the suitability of products for a particular purpose, merchant ability or fitness for any patent, copyright or other intellectual property infringement. USR may make changes to specifications and products description without notice.

## 7. Undated History

V 1.0 2016-4-29 First Version