

Preface

Thanks very much for purchasing the SK series touch-screen products of Shenzhen Samkoon Automation Technology Co., Ltd..

Shenzhen Samkoon Automation Technology Co., Ltd. is a national hi-tech enterprise involved in research and development of industrial visual touch control products – core technology of human machine interface, as well as development, manufacture and selling of advanced industrial control products. With over 6 years of development, it has accumulated great strengths and become leading in the related national and even global industry by virtue of its strong R&D and innovation capability, core technologies that are not based on any system and for which the Company has 100% independent intellectual property right and high cost effectiveness of the products.

Samkoon's SK series human machine interface (HMI) products are mainly used in industrial control to realize visual touch control. With excellent performance, they are increasingly widely used in various industries, such as textile machines, dyeing machines, plastic and rubbery machines, plastic injection molding machines, packaging machines, ultrasonic wave equipment, electronic welding machines, printing machines, food making machines, medical machines, woodworking machines, lifting equipment, intelligent buildings, water treatment equipments, power system, rail transport, coal system, petrochemical system, air-conditioning industry, processing machines, tire industry, monitoring and control equipments, teaching instruments, advanced manufacturing system and equipments, and general equipment control industries. The Company has become leading in the domestic market, and won wide favorable comments of users by virtue of excellent product quality, stable software operation and powerful product functions.

In view of the various design and construction requirements of industrial control projects, technicians of Shenzhen Samkoon Automation Technology Co., Ltd. devoted themselves to development and application of generic configuration screen editing software. To meet the needs of the wide industrial control circle in the whole world for configuration screen editing software, Shenzhen Samkoon launched this SK Workshop4.0.0 generic industrial automation configuration screen editing software for the users in the whole country and even the whole world.

SKWorkshop generic industrial automation configuration editing software is a kind of configuration software used to quickly construct and generate embedded computer monitoring and control system. Based on the Company's rich experience in configuration software development and application over the years, this software uses currently advanced computer software technology, uses window as the unit, constructs graphical interfaces for user operation system, and provides users with engineering solutions through field data collection and processing and by means of animated drawings, alarm processing, flow control, report output, and so on. It is widely used in automation field.

To help users use SKWorkshop generic industrial automation configuration editing software, we wrote this manual to introduce in detail the system structure, functions and other aspects of SKWorkshop 4.0.0 Users can construct their own configurations by a few simple operations, and get rid of fussy programming. With this software more users can use human machine interface products masterly.

This User Manual introduces how to operate the SK series SKWorkshop configuration software. Please read it carefully to ensure proper use of the software.

Due to the limited ability of the author, it is inevitable that there are some mistakes in this Manual, and readers are sincerely invited to find out and correct them. If you need further information on this software or more technical supports, please contact us and we shall provide sincere service for you. Our contact information is as follows:

Shenzhen Samkoon Automation Technology Co., Ltd

Address: Building C6 Hengfeng Industrial

Baoan District, Shenzhen, China.

Tel: 0755-29419068

Fax: 0755-29455559

E-Mail: szsamkoon@163.com

Web: [Http://www.samkoon.com.cn](http://www.samkoon.com.cn)

Caution

- (1) Without prior consent, anyone should not reprint or duplicate all or any part of this Manual.
- (2) The contents of this Manual, including specs, are subject to change without prior notification.
- (3) The author of this Manual tried the best to make it precise. If you find any ambiguity or mistake in this Manual, please contact us using the contact information provided at the end of this Manual, and notify us the serial number indicated on the cover of the Manual.

On the trade mark and other matters

- Windows® is a registered trade mark of Microsoft Corporation in USA.
- Programmable Logic Controllers (PLC) refer to products of all manufacturers.

Safety issues

In this Manual safety considerations are divided into [Danger] and [Caution].

Danger: Mis-operation may lead to accidents and cause death or serious injury.

Caution: Mis-operation may lead to accidents and cause middle or minor injury.

However, issues marked as [Caution] may also cause serious accidents in some cases.

So, please abide by these instructions carefully.

Warning

- Before installation, dismantling, wiring, maintenance or testing, please switch off the power to prevent electric shock, mis-operation or failure.
- Please set external emergency stop loop and interlock device for the touch screen. Otherwise, failure of the touch screen may cause mechanical damage or accidents.
- When the power is on, do not touch live parts such as the terminals, or electric shock may be caused.

Caution

- Do not use items that have been damaged or deformed at the time of unpacking, or failure or mis-operation may be caused.
- Prevent the machine from impact such as falling or rolling, or product damage and failure may be caused.
- Please store and use the machine under the environment specified in the operation instructions and user manual. Storage or use under such adverse environment as high temperature, high humidity, frost, dust, corrosive gas, oil stain, organic solvent, lubricant, great vibration, and shock, or it may cause electric shock, fire, malfunction, and the like.
- Please transfer on-screen data during operation only when the safety is ensured. Otherwise mechanical damage or failure may be caused by mis-operation.
- Do not turn off the power while the software is working (communicating with the equipment connected), or it may cause data loss, machine damage or failure.
- Please use and operate under the software action environment specified in this Manual, or it may cause failure or mis-action.
- Please confirm reliable and firm connection with communication cable, or it may cause failure or mis-action.

Contents

1.	Hardware manual.....	8
1.1	General.....	8
1.2	Model and description.....	8
1.3	Installing dimension of SKWorkshop.....	9
1.4	Structure of the touch screen.....	17
1.4.1	Power supply.....	17
1.4.2	Front panel.....	17
1.4.3	Communication interfaces.....	17
1.4.4	Operation indicator light.....	18
1.5.	Technical parameters.....	18
1.6	Principle of the touch screen.....	32
1.6.1	CPU module.....	33
1.6.2	Touch screen display module.....	33
1.6.3	Communication module.....	33
1.6.4	Memory module.....	33
1.6.5	Power supply module.....	33
1.7	Industrial environment.....	33
1.8	Wiring.....	33
2.	Quick start of SKWorkshop.....	34
2.1	What is SKWorkshop?.....	34
2.2	Requirements of SKWorkshop for computer.....	35
2.2.1	Software requirements of SKWorkshop for computer.....	35
2.2.2	Hardware requirements of SKWorkshopfor computer.....	35
2.3	Installation of SKWorkshop configuration software.....	36
2.4	Uninstall of SKWorkshop configuration software.....	42
2.5	Operation of SKWorkshop.....	44
2.6	Installation of USB driver of SKWorkshop.....	45
2.7	Editing page and system composition of SKWorkshop.....	49
2.7.1	Editing page of SKWorkshop.....	49
2.7.2	System composition of SKWorkshop.....	67
2.8	Basic operations of SKWorkshop.....	68
2.8.1	Use of mouse and shortcut key of SKWorkshop.....	68
2.8.2	Mouse shape.....	69
2.8.3	Shortcut keys.....	69
2.8.4	Common terms of SKWorkshop.....	69
3.	Basic steps of creating a project with SKWorkshop.....	70
3.1	Creating a new project with SKWorkshop.....	70
3.1.1	New project dialog with SKWorkshop.....	70
3.1.2	Communication port setting dialog.....	72
3.1.3	Communication interface setting dialog.....	73
3.2	Setting parameters and adding graph objects with SKWorkshop.....	74
3.2.1	Setting parameters.....	75
3.2.2	User password setting dialog.....	76

3.2.3	Connection with printer.....	77
3.2.4	Saving position and system alarming setting.....	79
3.3	Downloading configuration project of SKWorkshop.....	80
3.4	Upload configuration program.....	82
3.5	SKWorkshop converter.....	83
3.5.1	Choose “Convert SamDraw3.3 to SKWorkshop”.....	84
3.5.2	Choose “Upload historical data”.....	84
4.	Guide on configuration with SKWorkshop.....	85
4.1	Screen operation with SKWorkshop.....	85
4.1.1	New screen with SKWorkshop.....	85
4.1.2	Modify screen properties with SKWorkshop.....	86
4.1.3	Delete screen with SKWorkshop.....	87
4.1.4	Copy screen with SKWorkshop.....	87
4.2	Graph editing commands of SKWorkshop.....	88
4.2.1	Assemble and disassemble of SKWorkshop.....	88
4.2.2	Layer of SKWorkshop.....	89
4.2.3	Rotary of SKWorkshop.....	91
4.2.4	Align of SKWorkshop.....	92
4.3	Drawing basic graphs with SKWorkshop.....	96
4.3.1	Line of SKWorkshop.....	96
4.3.2	Polygonal line of SKWorkshop.....	97
4.3.3	Curve/Arc of SKWorkshop.....	97
4.3.4	Free line of SKWorkshop.....	98
4.3.5	Rectangle of SKWorkshop.....	99
4.3.6	Rounded rectangle of SKWorkshop.....	100
4.3.7	Ellipse/Circle of SKWorkshop.....	101
4.3.8	Polygon of SKWorkshop.....	102
4.3.9	Fan chart of SKWorkshop.....	103
4.3.10	Text graphs of SKWorkshop.....	103
4.3.11	Table graph of SKWorkshop.....	105
4.3.12	Scale graph of SKWorkshop.....	107
4.3.13	Open library of SKWorkshop.....	108
4.3.14	Build library of SKWorkshop.....	110
4.4	Advanced controls of SKWorkshop.....	112
4.4.1	GIF display of SKWorkshop.....	112
4.4.2	Trend chart of SKWorkshop.....	114
4.4.3	XY Trend chart of SKWorkshop.....	119
4.4.4	Historical trend chart of SKWorkshop.....	120
4.4.5	Dynamic circle of SKWorkshop.....	125
4.4.6	Dynamic rectangle of SKWorkshop.....	126
4.4.7	Alarm control of SKWorkshop.....	128
4.4.8	Dynamic alarm bar of SKWorkshop.....	130
4.4.9	Historic alarm display of SKWorkshop.....	131
4.4.10	Graphics move of SKWorkshop.....	133

4.4.11	Meter of SKWorkshop.....	135
4.4.12	Historical data display of SKWorkshop.....	137
4.4.13	Message display of SKWorkshop.....	138
4.4.14	Flow block of SKWorkshop.....	140
4.4.15	Timer of SKWorkshop.....	142
4.4.16	Data transfer of SKWorkshop.....	144
4.4.17	Multifunction button of SKWorkshop.....	145
4.5	Basic controls of SKWorkshop.....	148
4.5.1	Bit button of SKWorkshop.....	148
4.5.2	Word button of SKWorkshop.....	156
4.5.3	Bit lamp of SKWorkshop.....	158
4.5.4	Screen button of SKWorkshop.....	160
4.5.5	Function button of SKWorkshop.....	162
4.5.6	Multi-state lamp of SKWorkshop.....	165
4.5.7	Multi-state switch of SKWorkshop.....	169
4.5.8	Numeric display of SKWorkshop.....	173
4.5.9	Numeric entry of SKWorkshop.....	176
4.5.10	ASC character display of SKWorkshop.....	181
4.5.11	ASCII character entry of SKWorkshop.....	182
4.5.12	Bar graph of SKWorkshop.....	183
4.5.13	Time display of SKWorkshop.....	187
4.5.14	Date display of SKWorkshop.....	188
4.4.15	Day-of-week display of SKWorkshop.....	190
4.5.16	Static picture of SKWorkshop.....	192
4.5.17	Picture display of SKWorkshop.....	193
4.6	New functions of SKWorkshop.....	194
4.6.1	Fan chart of SKWorkshop.....	194
4.6.2	Step button of SKWorkshop.....	195
4.6.3	Radio button of SKWorkshop.....	197
4.6.4	Dropdown box of SKWorkshop.....	198
4.6.5	Slider analog switch of SKWorkshop.....	200
4.6.6	Animation of SKWorkshop.....	201
4.6.7	Message board of SKWorkshop.....	204
4.6.8	Data group display of SKWorkshop.....	205
4.6.9	User-defined keyboard of SKWorkshop.....	207
4.6.10	Recipe selector of SKWorkshop.....	210
4.6.11	Recipe data display of SKWorkshop.....	211
4.6.12	Operation record display of SKWorkshop.....	213
4.7	Control operation introduction of SKWorkshop.....	215
5.	Macro.....	217
5.1.	Introduction to C language.....	217
5.1.1	Data type of C language.....	217
5.1.2.	Initial value of variable and type conversion.....	222
5.1.3.	Basic operator and expression.....	223

5.1.4.	One-dimensional array.....	224
5.1.5	Section summary.....	227
5.2.	C Language programming preliminary.....	228
5.2.1.	Statement of C program.....	228
5.2.2.	Branch structure program.....	230
5.2.3.	switch statement.....	233
5.2.4.	Loop structure program.....	234
5.2.5.	for statement.....	235
5.2.6.	break statement.....	236
5.2.7.	continue statement.....	236
5.2.8	Section summary.....	237
5.3.	Macro function introduction.....	238
5.3.1.	How to use macro function for programming.....	238
5.3.2.	Function button introduction in macro editor.....	239
5.3.3.	How to new create macro.....	240
5.3.4.	How to insert library function in the program.....	242
5.3.5	How to use internal storage area in macro.....	243
5.4.	QuickStart: A simple macroblock.....	244
5.5.	Appendix 1.....	253
6.	Off-line simulation of SKWorkshop.....	261
6.1	Offline simulation of SKWorkshop.....	261
6.2.	On-line simulation of SKWorkshop.....	268
7.	System setting of SKWorkshop.....	268
7.1.	Setting of communication screen of SKWorkshop.....	268
7.2.	Setting of SKWorkshop.....	270
7.2.1	Language of SKWorkshop.....	270
7.2.2	Parameter setting of touch screen of SKWorkshop.....	276
7.2.3	HMI status of SKWorkshop.....	281
7.2.4	PLC control of SKWorkshop.....	282
7.2.5	Clock of SKWorkshop.....	284
7.2.6	File protect of SKWorkshop.....	286
7.2.7	HMI protect of SKWorkshop.....	286
7.2.8	Variable table control of SKWorkshop.....	288
7.3.	Screen of SKWorkshop.....	289
7.4.	Window of SKWorkshop.....	290
7.5.	Historical data collector of SKWorkshop.....	290
7.6.	Alarm setting of SKWorkshop.....	294
7.6.1	Digital alarm log of SKWorkshop.....	294
7.6.2	Analog alarm log of SKWorkshop.....	300
7.7.	Alarm display controls of SKWorkshop.....	302
7.8.	Recipe configuration of SKWorkshop.....	304
7.9.	Setting of global macro of SKWorkshop.....	308
7.10.	Setting of initial macro of SKWorkshop.....	309
8.	System reserved register of SKWorkshop.....	310

8.1.	LB.....	310
8.2.	LW.....	312
8.3.	RWI.....	318
9.	Connection method of SKWorkshop multi-screen multi-unit.....	319
9.1	One-unit multi-screen connection method of SKWorkshop.....	319
9.2	One-screen multi-unit connection method of SKWorkshop.....	323
9.3	Penetration connection method of SKWorkshop.....	325
10.	Device driver of SKWorkshop.....	329
10.1.	AIBUS device driver.....	332
10.2.	Allen-Bradley device driver.....	334
10.3.	Delta device driver.....	335
10.4.	Emerson device driver.....	337
10.5.	Fatek device driver.....	338
10.6.	Fuji device driver.....	340
10.7.	GE device driver.....	341
10.8.	HaiWell device driver.....	343
10.9.	Hitachi device driver.....	344
10.10.	HollySys device driver.....	345
10.11.	IDEC device driver.....	347
10.12.	Inovance device driver.....	349
10.13.	Keyence device driver.....	350
10.14.	Koyo device driver.....	352
10.15.	LG device driver.....	353
10.16.	Matsushita device driver.....	355
10.17.	Mitsubishi device driver.....	357
10.18.	Modbus device driver.....	360
10.19.	Modicon device driver.....	362
10.20.	Nanda device driver.....	364
10.21.	Omron device driver.....	366
10.22.	Siemens device driver.....	368
10.23.	TaiAn device driver.....	370
10.24.	TaiLing device driver.....	372
10.25.	Techwayson device driver.....	373
10.26.	Vigor device driver.....	374
10.27.	Xinje device driver.....	376
10.28.	Yokogawa device driver.....	377
10.29.	ZhengHang device driver.....	379
11.	Appendix.....	380
11.1.	How to export data with U-disk or SD card.....	380
11.2.	How to update a project with U disk or SD card.....	380
11.3.	Image formats supported by SK series touch screen.....	381
11.4.	Dial switch.....	381
12.	Contact.....	382

1. Hardware manual

1.1 General

Samkoon SK series touch screens are high quality human machine interface products, integrating CPU module, output module, display screen, memory and some other modules. It can be widely used in various control systems of different industries. Optimized design of hardware and software is adopted so that the touch precision and screen color of the product meet the requirements for machine control.

Samkoon SK series touch screens have the following models: SK-3.5A, SK-4.0A, SK-4.3A, SK-5.0A, SK-5.7A, SK-5.7C, SK-5.7D, SK-5.7F, SK-7.0A, SK-7.2A, SK-8.0A, SK-10.2A, SK-10.4A, SK-12.1A.

Samkoon SK series touch screens are open human machine interface products, providing standard serial interfaces for connection with other equipment. It mainly supports serial communication, including communication with currently popular PLCs, such as Mitsubishi's PLC products, Siemens' PLC products, Omron's PLC products, and Modicon's PLC products. Meanwhile, communication drive can be developed upon request of users.

The configuration software of Samkoon SK series touch screen is SKWorkshop, which provides users with screen configuration, drive setting, control and some other functions. The up-to-date version of this software is V4.4.0

1.2 Model and description

At present Samkoon SK series touch screens have the following models:

SK-3.5A	(320×240	3.5')
SK-4.0A	(320×240	4.3')
SK-4.3A	(480×272	4.3')
SK -5.0A	(480×272	5.0')
SK -5.7A	(640×480	5.7')
SK -5.7C	(320×234	5.7')
SK -5.7D	(640×480	5.7')
SK -5.7F	(320×234	5.7')
SK -7.0A	(800×480	7.0')
SK -7.2A	(800×600	7.2')
SK -8.0A	(800×600	8.0')
SK -10.2A	(800×480	10.2')
SK-10.4A	(800×600	10.4')
SK 12.1A	(800×600	12.1')

The length/width ratio of SK-3.5A and SK-4.0A is 4:3, and the resolution reaches 320x240; The length/width ratio of SK-4.3A and SK-5.0A is 16:9, and the resolution reaches 480x272; The length/width ratio of SK-5.7A is 4:3, and the resolution reaches 640x480; The length/width ratio of SK-5.7C and SK-5.7F is 4:3, and the resolution reaches 320x240; The

length/width ratio of SK-5.7D is 4:3, and the resolution reaches 640x480; The length/width ratio of SK-7.0A is 16:9, and the resolution reaches 800x480; The length/width ratio of SK-7.2A is 4:3, and the resolution reaches 800x600; The length/width ratio of SK-8.0A is 4:3, and the resolution reaches 800x600; The length/width ratio of SK-10.2A is 16:9, and the resolution reaches 800x480; The length/width ratio of SK-10.4A is 4:3, and the resolution reaches 800x600; The length/width ratio of SK-12.1A is 4:3, and the resolution reaches 800x600. Refer to technical parameter list for detailed parameters.

1.3 Installing dimension of SKWorkshop

✚ Installing dimension of SK-035A

Figure 1-1 shows the product dimensions (mm) of SK-3.5A
 The outline dimension is 136×89×39,
 and the installing opening dimension is 124×81.

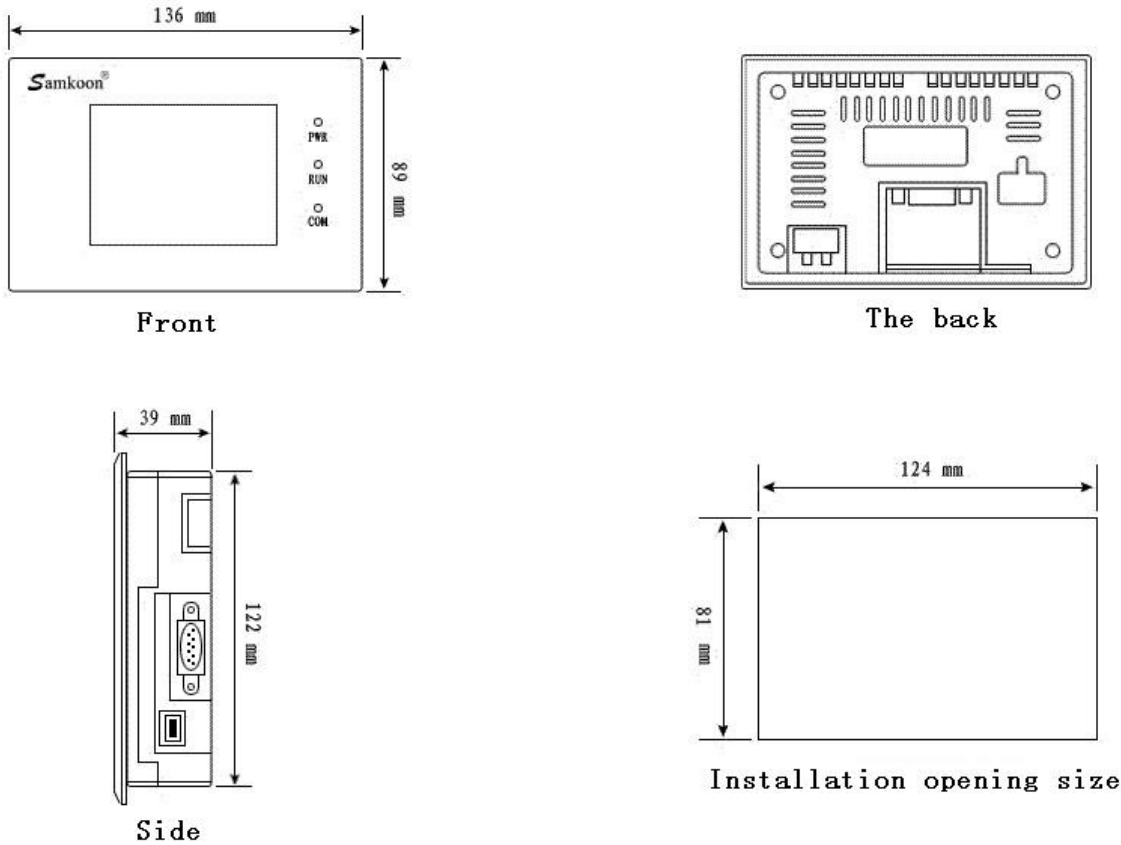

Figure 1-1: Installing dimensions of SK-3.5

✚ Installing dimension of SK-4.0A

Figure 1-2 shows the product dimensions (mm) of SK-040A.

The outline dimension is 123×99×39
and the installing opening dimension is 114×90

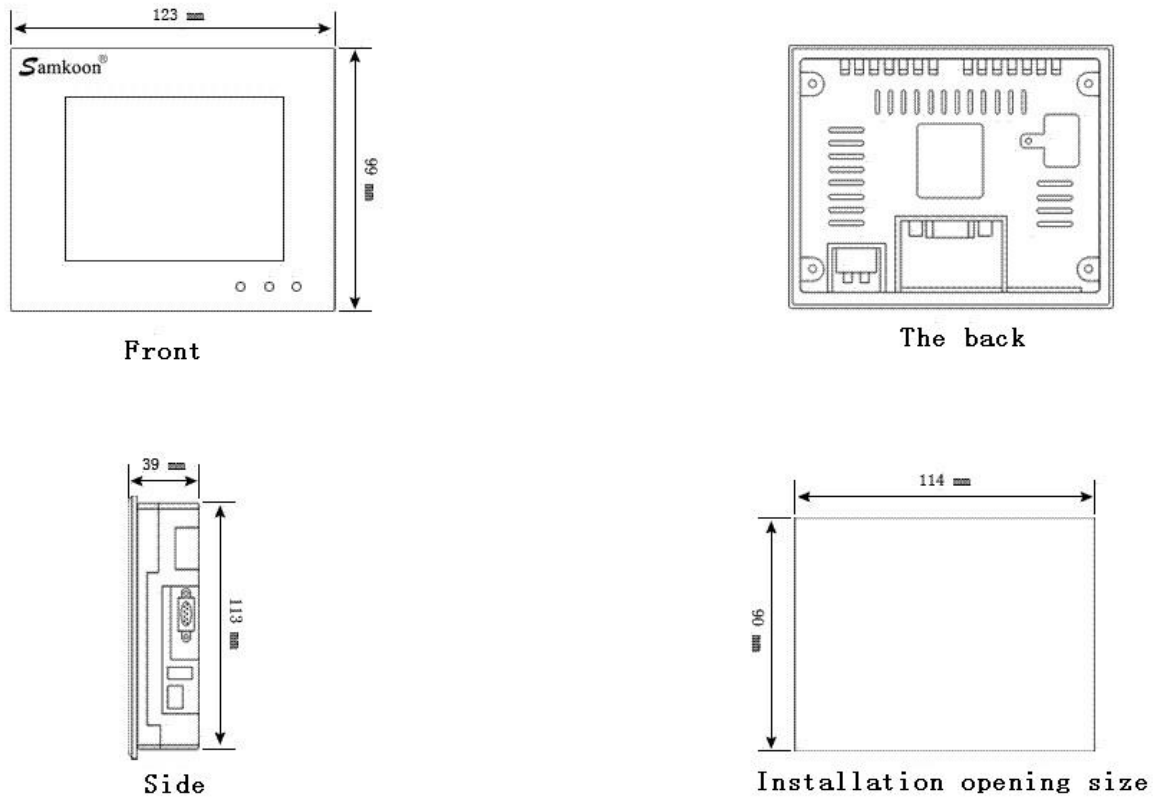

Figure 1-2: Installing dimensions of SK-4.0A

✚ Installing dimension of SK-4.3A

Figure 1-3 shows the product dimensions (mm) of SK-043A.

The outline dimension is 151×93×39,

and the installing opening dimension is 142×85.

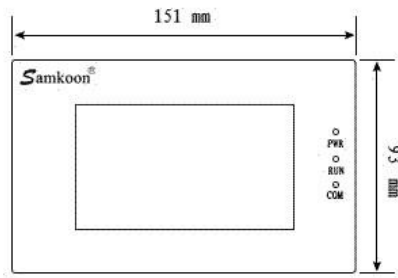

Front

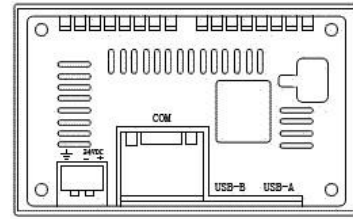

The back

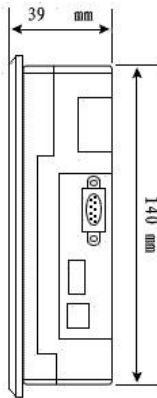

Side

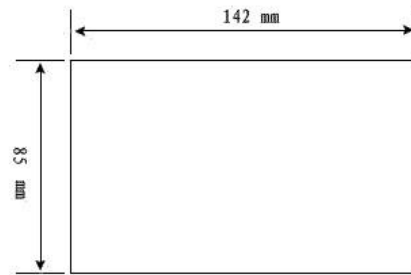

Installation opening size

Figure 1-3: Installing dimensions of SK-4.3

✚ Installing dimension of SK-5.0A

Figure 1-4 shows the product dimensions (mm) of SK-050A.

The outline dimension is 165×103×39,

and the installing opening dimension is 157×95.

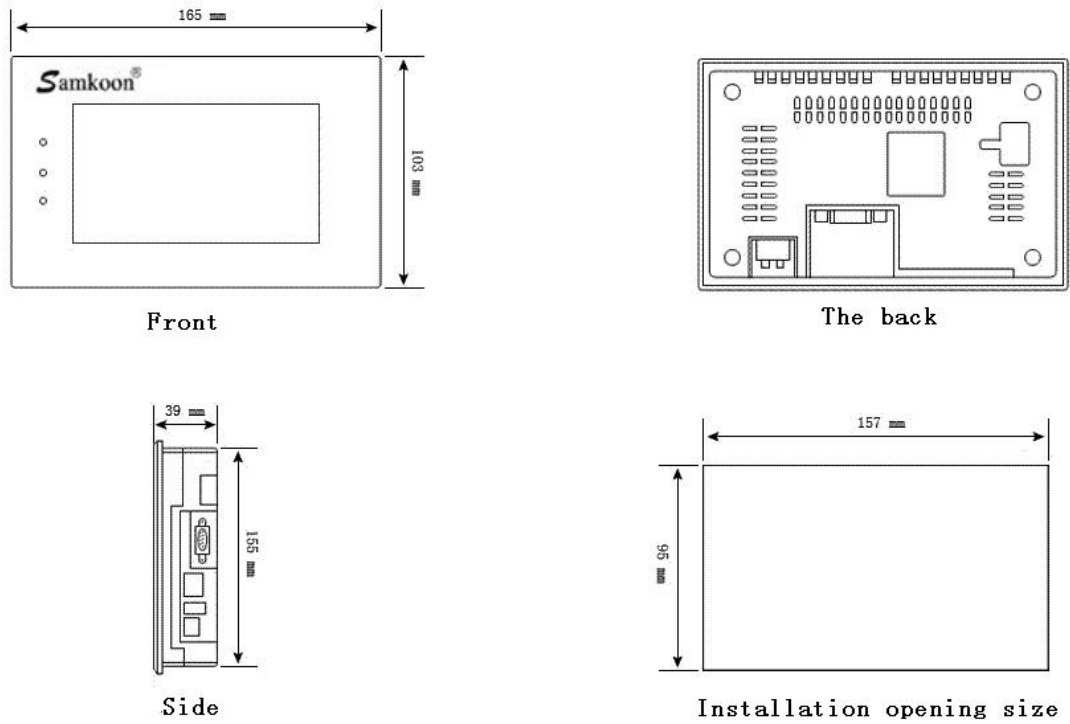

Figure 1-4: Installing dimensions of SK-5.0A

✚ Installing dimension of SK-5.7

Figure 1-5 shows the product dimensions (mm) of SK-057AS/SK-057AE, SK-057CS/SK-057CE.

The outline dimension is 176x140x40,

and the installing opening dimension is 164x134.

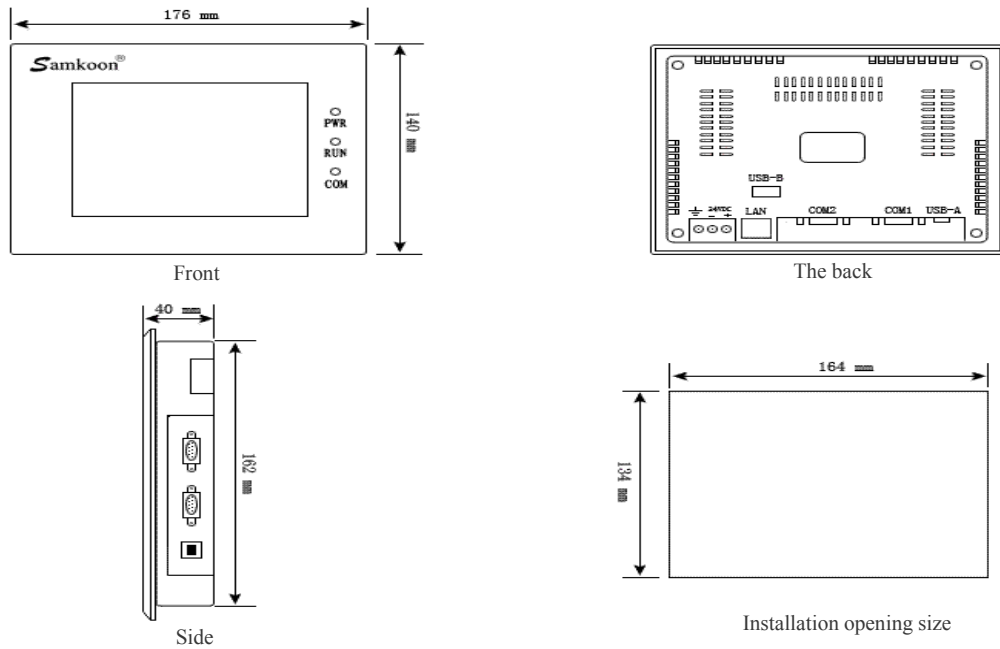

Figure 1-5: Installing dimensions of SK-057AS/SK-057AE, SK-057CS/SK-057CE

Figure 1-6 shows the product dimensions (mm) of SK-5.7D/SK-5.7E/SK-5.7F.

The outline dimension is 202x144x40,

and the installing opening dimension is 192x138.

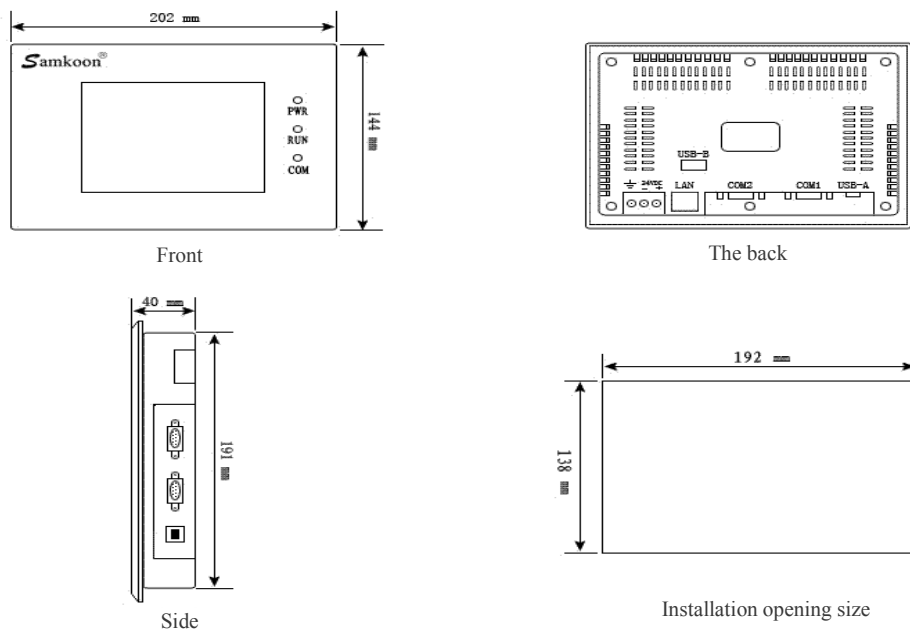

Figure 1-6: Installing dimensions of SK-057DS/SK-057DE, SK-057FS/SK-057FE

✚ Installing dimension of SK-7.0A

Figure 1-7 shows the product dimensions (mm) of SK-070AS, SK-070AE.

The outline dimension is 228×154×41,

and the installing opening dimension is 211×145.

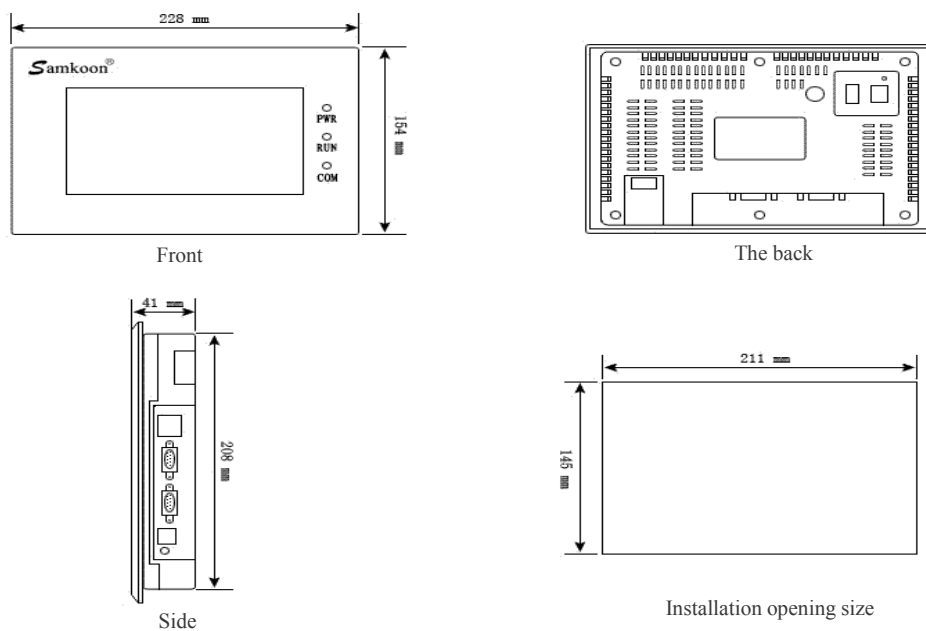

Figure 1-7: Installing dimensions of SK-070AS, SK-070AE

✚ Installing dimension of SK-7.2A

Figure 1-8 shows the product dimensions (mm) of SK-072AS/SK-072AE.

The outline dimension is 203×165×40,

and the installing opening dimension is 186×156.

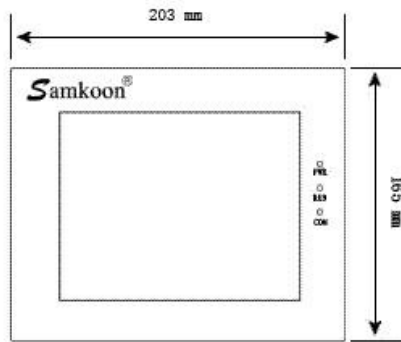

Front

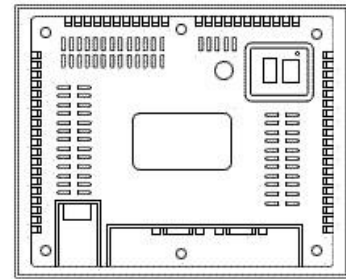

The back

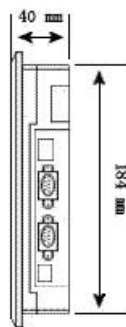

Side

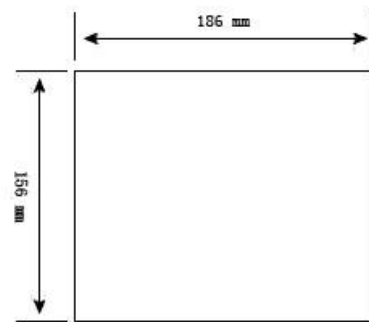

Installation opening size

Figure 1-8: Installing dimensions of SK-072AS/SK-072AE

✚ Installing dimension of SK-8.0A

Figure 1-9 shows the product dimensions (mm) of SK-080AS/SK-080AE.

The outline dimension is 239×192×49,

and the installing opening dimension is 235×188

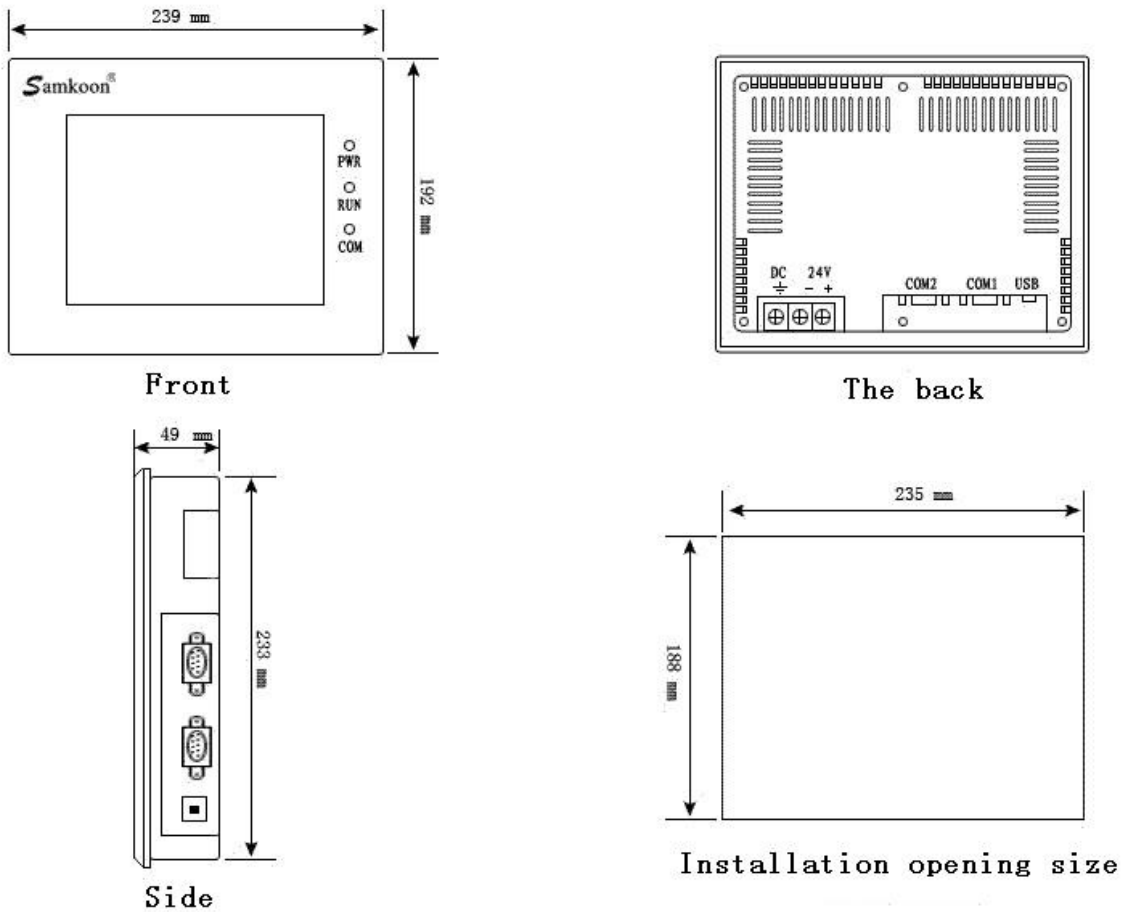

Figure 1-9: Installing dimensions of SK-080AS/SK-080AE

Installing dimension of SK-10.2A

Figure 1-10 shows the product dimensions (mm) of SK-102AS/SK-102AE.

The outline dimension is 266×208×40,

and the installing opening dimension is 261×203

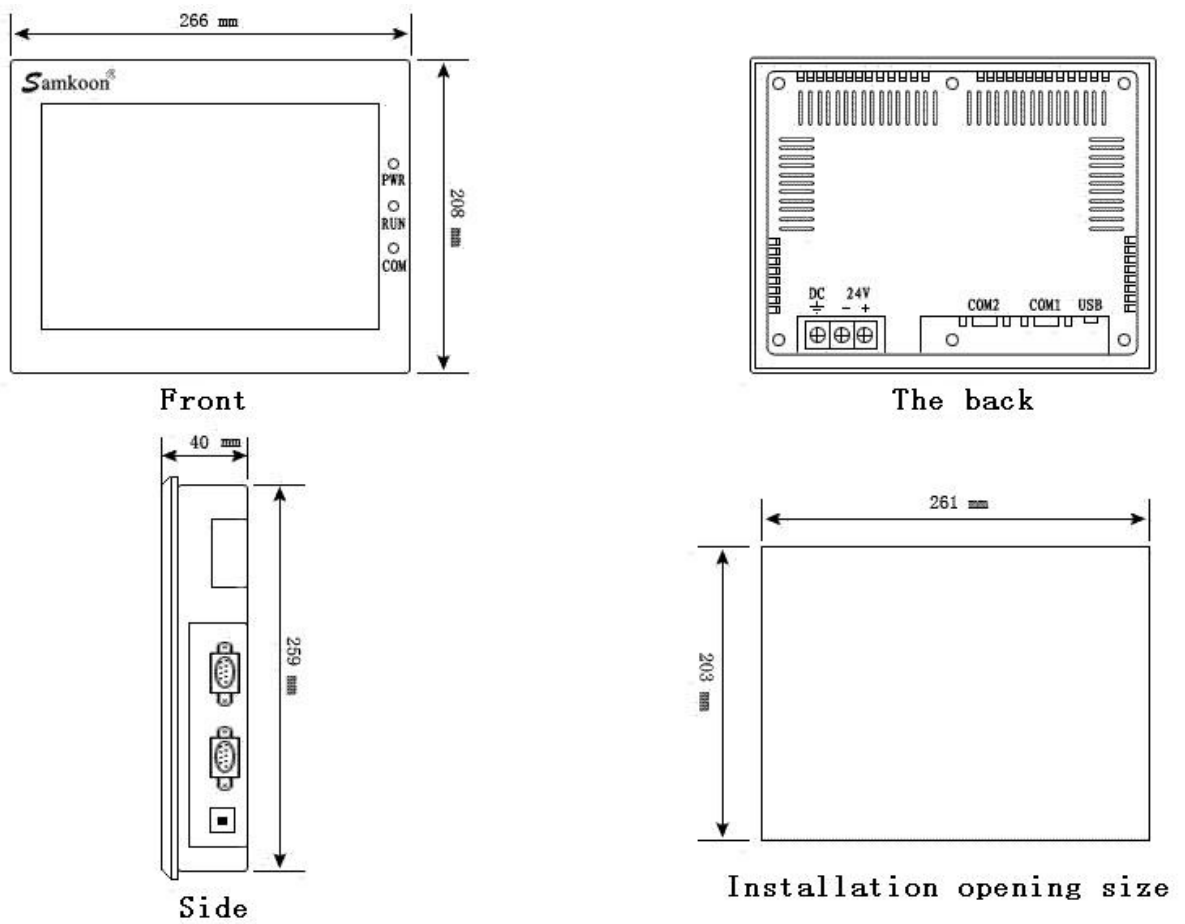

Figure 1-10: Installing dimensions of SK-102AS/SK-102AE

✚ Installing dimension of SK-10.4A

Figure 1-11 shows the product dimensions (mm) of SK-104AS/SK-104AE.

The outline dimension is 312×225×54,

and the installing opening dimension is 386×214

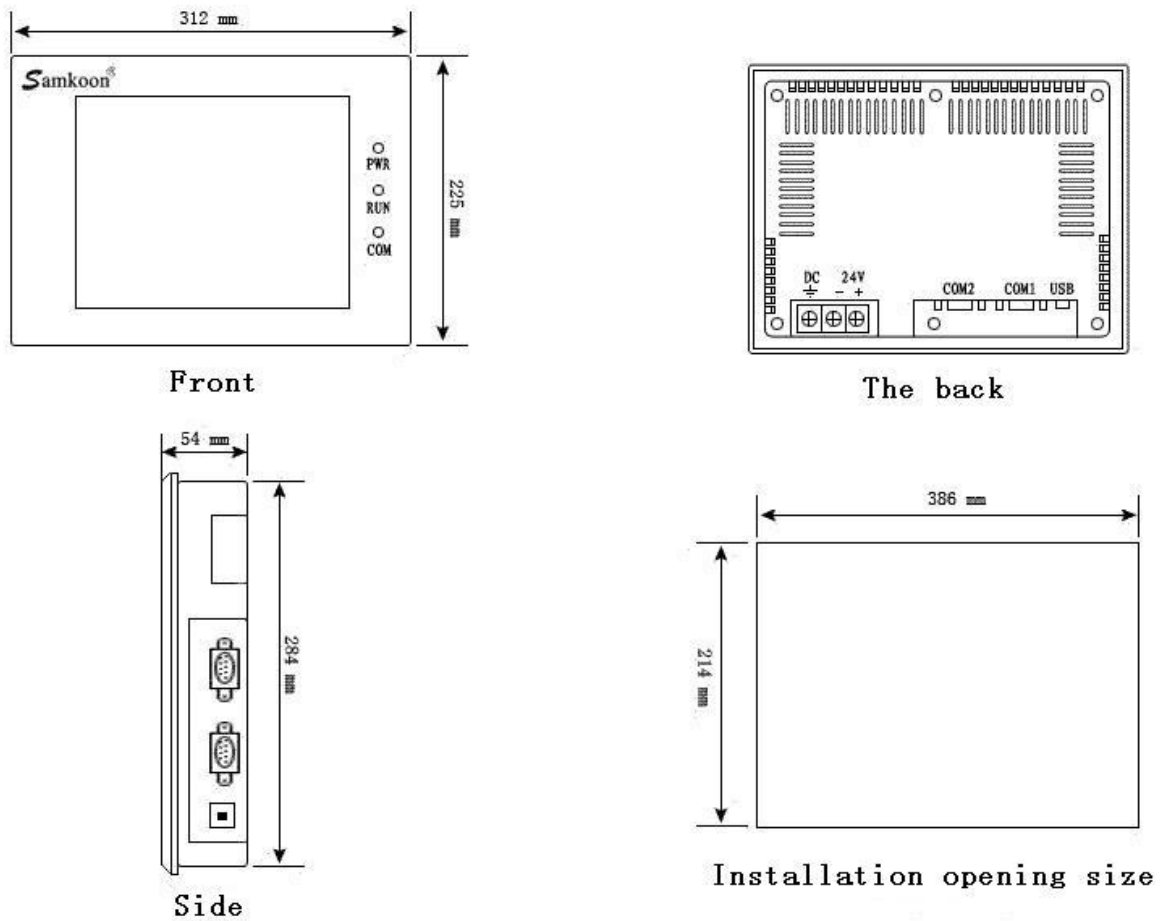

Figure 1-11: Installing dimensions of SK-104AS/SK-104AE

Installing dimension of SK-12.1A

Figure 1-12 shows the product dimensions (mm) of SK-121AS/SK-121AE.

The outline dimension is 338×253×65,

and the installing opening dimension is 330×246

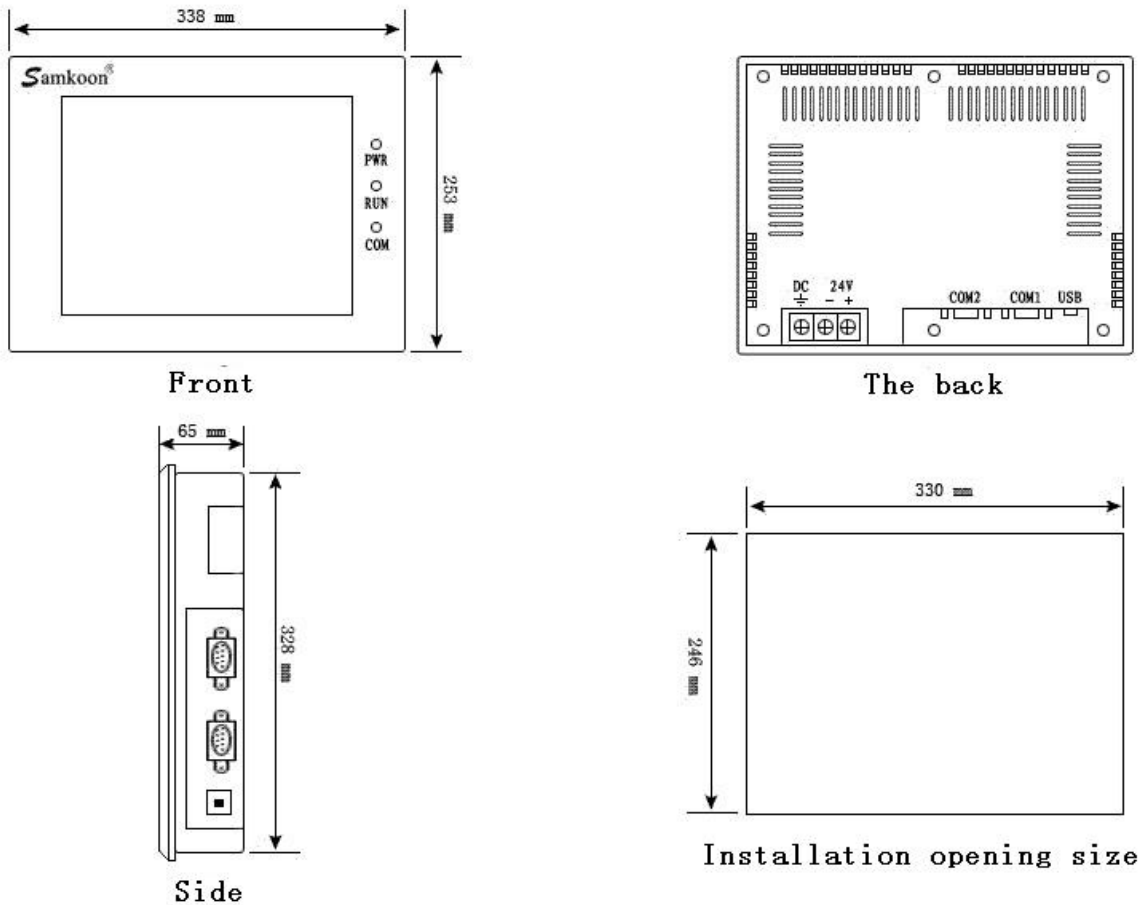

Figure 1-12: Installing dimensions of SK-121AS/SK-121AE

1.4 Structure of the touch screen

The overall structure of Samkoon touch screen consists of display area, indicator light, power supply and communication interfaces. The colors of all models of touch screens are designed according to relevant industrial standards, with high dirtying resistance and being suitable for use under bad conditions of plants. Indicator lights are equipped on the front panel to indicate equipment failure. The power supply module and the communications interfaces are all located at the bottom of the touch screen, meeting design standards.

1.4.1 Power supply

The power supply interface of Samkoon SK series touch screen is located in the back panel. It uses DC24V power supply ($\pm 15\%$) and isolated power input, effectively shielding from interference and enhancing the anti-interference capability of the whole system. Figure 1-13 is a view of the power supply module.

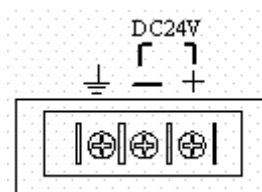

Figure 1-13 Power supply module

1.4.2 Front panel

Figure 1-14 is a view of the front panel of Samkoon SK series touch screen. The front panel consists of the display screen and the operation indicator lights:

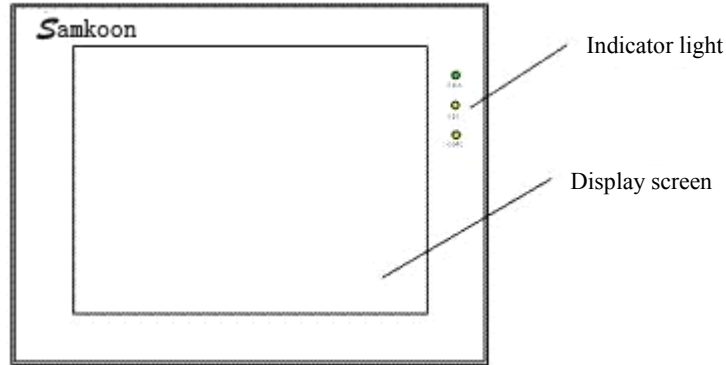

Figure 1-14: Front panel of SK series

1.4.3 Communication interfaces

The communication interfaces of the touch screen are located in the bottom panel of the machine. 2 standard serial communication interfaces are provided in SK-12.1A, SK-10.4A, SK-10.4B, SK-8.0A, SK-7.0A, SK-7.2A SK-5.7A, SK-5.7B, SK-5.7C, and 1 standard serial communication interface is provided in SK-3.5A, SK-4.0A, SK-4.3A, SK-5.0A. 9-pin D-type interfaces are used for connection and communication with PLC or other controller.

When shielded cables are used, the communication distance of RS232 should be no more than 15m. A USB communication interface is provided for connection with PC for configuration downloading, with a communication rate up to 10Mbps (2 USB interfaces are provided in SK-5.7A, SK-5.7C, SK-5.7D and SK-5.7F). These USB interfaces use B-type female interfaces (1 B-type female interface and 1 A-type female interface are provided in SK-5.7A, SK-5.7C, SK-5.7D and SK-5.7F). For connection of different PLCs, the definitions of the communication interfaces are also different (Users need to specify the types of the PLCs to be connected at the time of ordering so that appropriate communication cables can be provided). Figure 1-15 shows a panel equipped with two serial interfaces and a B-type female USB interface:

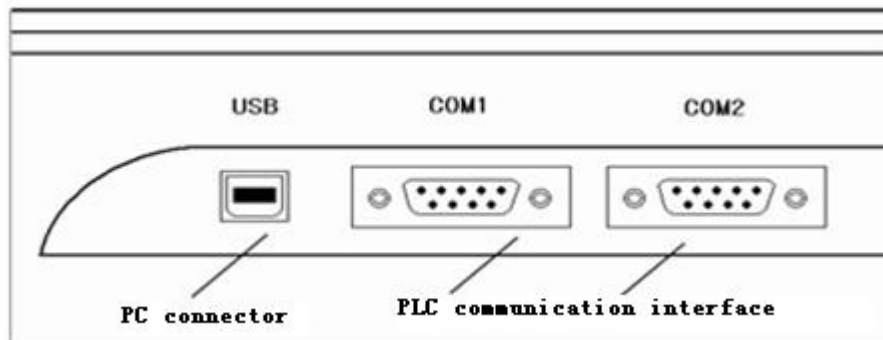

Figure 1-15 Side panel of SK series

1.4.4 Operation indicator light

Operation state indicator lights on the touch screen include power indicator light (PWR), operation indicator light (RUN) and communication indicator light (COM). See Figure 1-16. When the touch screen is powered on, the PWR light is on (green); when the touch screen CPU is running normally, RUN light is on (yellow) and when CPU fails RUN light is off; When a PLC is connected, the COM light is flashing (yellow). Table 1-1 shows the display statuses of the three LED indicator lights on different working state.

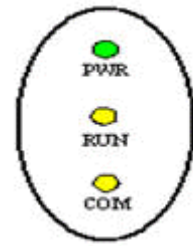

Figure 1-16: Operation indicator lights of SK series

Equipment state	Green LED (PWR)	Yellow LED (RUN)	Yellow LED (COM)
No power supply	○	○	○
Power on	●		
CPU running	●	●	
Communication with connected equipment	●	●	※

○: LED is off; ●: LED is on; ※: LED is flashing

Table 1-1

1.5. Technical parameters

✚Detailed parameters of SK-3.5

This model of machine only has economic type but no standard type.

	Main technical parameters
Model	SK-035AE
Display size	3.5"(length : width = 4:3)
Resolution	320×240
Brightness	350cd/m ²
Color	262,144 pigments
Contrast	400 : 1
Number of COM interfaces	1
Network interfaces	None

USB device interfaces	1
USB main interfaces	None
SD cards	None
Service life of back light	60,000 hours
Touch screen plate	4-wire high precision touch plate
Communication interface	USB,RS232,RS422, RS485
User memory	12M
Power supply	DC24V (±15%)
Power consumption	3W
CE certification	Meeting EN50022 and EN50024
FCC compatibility	Meeting FCC, Class A
Dielectric strength test	1,000V AC, 1 minute
Protection grade	IP 65 (front panel)
Ambient temperature for running	-10~65°C
Ambient humidity for running	10~90%RH
Shell plastic	Engineering plastic ABS + PC
Outline dimension	136×89×39(mm)
Opening dimension	124×81(mm)
Weight	About 0.2kg
Configuration software	SKWorkshop 4.0.0

Detailed parameters of SK-4.0A

This model of machine only has economic type but no standard type.

	Main technical parameters
--	---------------------------

Model	SK-040AE
Display size	4.0" (length : width = 4:3)
Resolution	320×240
Brightness	350cd/m ²
Color	262,144 pigments
Contrast	400:1
Number of COM interfaces	1
Network interfaces	None
USB device interfaces	1
USB main interfaces	None
SD cards	None
Service life of back light	60,000 hours
Touch screen plate	4-wire high precision touch plate
Communication interface	USB,RS232,RS422, RS485
User memory	12M
Power supply	DC24V (±15%)
Power consumption	3W
CE certification	Meeting EN50022 and EN50024
FCC compatibility	Meeting FCC, Class A
Dielectric strength test	1,000V AC, 1 minute
Protection grade	IP 65 (front panel)
Ambient temperature for running	-10 to 65 °C
Ambient humidity for running	10 to 90% RH

Shell plastic	Engineering plastic ABS + PC
Outline dimension	123×99×39(mm)
Opening dimension	114×90(mm)
Weight	About 0.2kg
Configuration software	SKWorkshop 4.0.0

✚Detailed parameters of SK-4.3A

This model of machine only has economic type but no standard type.

	Main technical parameters
Model	SK-043AE
Display size	4.3'' (length : width =16:9)
Resolution	480×272
Brightness	400cd/m ²
Color	262,144pigments
Contrast	400:1
Number of COM interfaces	1
Network interfaces	None
USB device interfaces	1
USB main interfaces	None
SD cards	None
Service life of back light	60,000 hours
Touch screen plate	4-wire high precision touch plate
Communication interface	USB, RS232, RS422, RS485
User memory	12M
Power supply	DC24V (±15%)

Power consumption	3W
CE certification	Meeting EN50022 and EN50024
FCC compatibility	Meeting FCC, Class A
Dielectric strength test	1,000V AC, 1 minute
Protection grade	IP 65 (front panel)
Ambient temperature for running	-10 to 65°C
Ambient humidity for running	10 to 90% RH
Shell plastic	Engineering plastic ABS + PC
Outline dimension	151×93×39 (mm)
Opening dimension	142×85 (mm)
Weight	About 0.2kg
Configuration software	SKWorkshop 4.0.0

✚Detailed parameters of SK-5.0A

SK-5.0A has two types, respectively SK-050AE and SK-050AS.

SK-050AE is an economic type and SK-050AS is a standard type.

	Main technical parameters	
Model	SK-050AE	SK-050AS
Display size	5.0'' (length : width =16:9)	
Resolution	480×272	
Brightness	350cd/m ²	
Color	262,144pigments	
Contrast	400:1	
Number of COM interfaces	1	
Network interfaces	None	1
USB device interfaces	1	

USB main interfaces	None	1
SD cards	None	
Service life of back light	60,000 hours	
Touch screen plate	4-wire high precision touch plate	
Communication interface	USB, RS232, RS422, RS485	
User memory	12M	
Power supply	DC24V (±15%)	
Power consumption	3W	
CE certification	Meeting EN50022 and EN50024	
FCC compatibility	Meeting FCC, Class A	
Dielectric strength test	1,000V AC, 1 minute	
Protection grade	IP 65 (front panel)	
Ambient temperature for running	-10 to 65°C	
Ambient humidity for running	10 to 90% RH	
Shell plastic	Engineering plastic ABS + PC	
Outline dimension	165×130×39 (mm)	
Opening dimension	157×95 (mm)	
Weight	About 0.2kg	
Configuration software	SKWorkshop 4.0.0	

✚Detailed parameters of SK-5.7

Model	Main technical parameters							
	SK-057AS	SK-057AE	SK-057CS	SK-057CE	SK-057DS	SK-057DE	SK-057FS	SK-057FE
Resolution	640×480	640×480	320×240	320×240	640×480	640×480	320×240	320×240
Number of network interfaces	1	0	1	0	1	0	1	0
Number of USB main interfaces	1	0	1	0	1	0	1	0
Number of SD cards	1	0	1	0	1	0	1	0

Outline dimension	176x130x39	176x130x39	202x144x40	202x144x40
Opening dimension	164x134	164x134	193x139	193x139
USB device interfaces	1			
Number of COM interfaces	2			
Display size	5.7'' (length : width = 4:3)			
Brightness	400cd/m ²			
Color	262,144 pigments			
Contrast	400:1			
Service life of back light	60,000 hours			
Touch screen plate	5-wire high precision touch plate			
Communication interface	USB,RS232,RS422, RS485			
User memory	12M			
Power supply	DC24V (±15%)			
Power consumption	4W			
CE certification	Meeting EN50022 and EN50024			
FCC compatibility	Meeting FCC, Class A			
Dielectric strength test	1,000V AC, 1 minute			
Protection grade	IP 65 (front panel)			
Ambient temperature for running	-10 to 65°C			
Ambient humidity for running	10 to 90% RH			
Shell plastic	Engineering plastic ABS + PC			
Weight	About 0.8kg			
Configuration software	SKWorkshop 4.0.0			

✚Detailed parameters of SK-7.0A

	Main technical parameters	
Model	SK-070AS	SK-070AE
Number of network interfaces	1	0

Number of USB main interfaces	1	0
Number of SD cards	1	0
Outline dimension	228×154×41 mm	
Opening dimension	211×145 mm	
USB device interfaces	1	
Number of COM interfaces	2	
Display size	7'' (length : width = 16:9)	
Resolution	800x480	
Brightness	450cd/m ²	
Color	262,144 pigments	
Contrast	450:1	
Service life of back light	60,000 hours	
Touch screen plate	5-wire high precision touch plate	
Communication interface	USB, RS232, RS422, RS485	
User memory	12M	
Power supply	DC24V (±15%)	
Power consumption	6W	
CE certification	Meeting EN50022 and EN50024	
FCC compatibility	Meeting FCC, Class A	
Dielectric strength test	1,000V AC, 1 minute	
Protection grade	IP 65 (front panel)	
Ambient temperature for running	-10 to 65°C	
Ambient humidity for running	10 to 90% RH (non condensable)	
Shell plastic	Engineering plastic ABS + PC	
Weight	About 1.5kg	
Configuration software	SKWorkshop 4.0.0	

✚Detailed parameters of SK-7.2A

	Main technical parameters	
Model	SK-072AS	SK-072AE
Number of network interfaces	1	0
Number of USB main interfaces	1	0
Number of SD cards	1	0
Outline dimension	230x165x40 mm	
Opening dimension	186x156 mm	
USB device interfaces	1	
Number of COM interfaces	2	
Display size	7'' (length : width = 16:9)	
Resolution	800×600	
Brightness	450cd/m ²	
Color	262,144 pigments	
Contrast	450:1	
Service life of back light	60,000 hours	
Touch screen plate	5-wire high precision touch plate	
Communication interface	USB, RS232, RS422, RS485	
User memory	12M	
Power supply	DC24V (±15%)	
Power consumption	6W	
CE certification	Meeting EN50022 and EN50024	
FCC compatibility	Meeting FCC, Class A	
Dielectric strength test	1,000V AC, 1 minute	
Protection grade	IP 65 (front panel)	

Ambient temperature for running	-10 to 65°C
Ambient humidity for running	10 to 90% RH (non condensable)
Shell plastic	Engineering plastic ABS + PC
Weight	About 1.5kg
Configuration software	SKWorkshop 4.0.0

 Detailed parameters of SK-8.0A

	Main technical parameters	
Model	SK-080AS	SK-080AE
Number of network interfaces	1	0
Number of USB main interfaces	1	0
Number of SD cards	1	0
USB device interfaces	1	
Number of COM interfaces	2	
Display size	8'' (length : width = 4:3)	
Resolution	800×600	
Brightness	450cd/m ²	
Color	262,144 pigments	
Contrast	450:1	
Service life of back light	60,000 hours	
Touch screen plate	5-wire high precision touch plate	
Communication interface	USB, RS232, RS422, RS485	
User memory	12M	
Power supply	DC24V (±15%)	
Power consumption	7W	

CE certification	Meeting EN50022 and EN50024
FCC compatibility	Meeting FCC, Class A
Dielectric strength test	1,000V AC, 1 minute
Protection grade	IP 65 (front panel)
Ambient temperature for running	-10 to 65°C
Ambient humidity for running	10 to 90% RH (non condensable)
Shell plastic	Engineering plastic ABS + PC
Outline dimension	239×192×49 (mm)
Opening dimension	235×188(mm)
Weight	About 1.8kg
Configuration software	SKWorkshop 4.0.0

✚ Detailed parameters of SK-10.2A

	Main technical parameters	
Model	SK-102AS	SK-102AE
Number of network interfaces	1	0
Number of USB main interfaces	1	0
Number of SD cards	1	0
USB device interfaces	1	
Number of COM interfaces	2	
Display size	10.2" (length : width = 16:9)	
Resolution	800×480	
Brightness	500cd/m ²	
Color	262,144 pigments	
Contrast	450:1	

Service life of back light	60,000 hours
Touch screen plate	5-wire high precision touch plate
Communication interface	USB, RS232, RS422, RS485
User memory	12M
Power supply	DC24V (±15%)
Power consumption	7W
CE certification	Meeting EN50022 and EN50024
FCC compatibility	Meeting FCC, Class A
Dielectric strength test	1,000V AC, 1 minute
Protection grade	IP 65 (front panel)
Ambient temperature for running	-10 to 65°C
Ambient humidity for running	10 to 90% RH (non condensable)
Shell plastic	Engineering plastic ABS + PC
Outline dimension	266×208×40 (mm)
Opening dimension	261×203(mm)
Weight	About 2.2 kg
Configuration software	SKWorkshop 4.0.0

 Detailed parameters of SK-10.4A

	Main technical parameters	
Model	SK-104AS	SK-104AE
Number of network interfaces	1	0
Number of USB main interfaces	1	0
Number of SD cards	1	0
USB device interfaces	1	

Number of COM interfaces	2
Display size	10.4" (length : width = 4:3)
Resolution	800×600
Brightness	450cd/m ²
Color	262,144 pigments
Contrast	450:1
Service life of back light	60,000 hours
Touch screen plate	5-wire high precision touch plate
Communication interface	USB, RS232, RS422, RS485
User memory	12M
Power supply	DC24V (±15%)
Power consumption	8W
CE certification	Meeting EN50022 and EN50024
FCC compatibility	Meeting FCC, Class A
Dielectric strength test	1,000V AC, 1 minute
Protection grade	IP 65 (front panel)
Ambient temperature for running	-10 to 65°C
Ambient humidity for running	10 to 90% RH (non condensable)
Shell plastic	Engineering plastic ABS + PC
Outline dimension	312×225×54 mm
Opening dimension	386×214 mm
Weight	About 2.2 kg
Configuration software	SKWorkshop 4.0.0

✚Detailed parameters of SK-12.1A

	Main technical parameters	
Model	SK-121AS	SK-121AE
Number of network interfaces	1	0
Number of USB main interfaces	1	0
Number of SD cards	1	0
USB device interfaces	1	
Number of COM interfaces	2	
Display size	12.1" (length : width = 4:3)	
Resolution	800×600	
Brightness	450cd/m ²	
Color	262,144 pigments	
Contrast	450:1	
Service life of back light	60,000 hours	
Touch screen plate	5-wire high precision touch plate	
Communication interface	USB, RS232, RS422, RS485	
User memory	12M	
Power supply	DC24V (±15%)	
Power consumption	8W	
CE certification	Meeting EN50022 and EN50024	
FCC compatibility	Meeting FCC, Class A	
Dielectric strength test	1,000V AC, 1 minute	
Protection grade	IP 65 (front panel)	
Ambient temperature for running	-10 to 65℃	
Ambient humidity for running	10 to 90% RH (non condensable)	
Shell plastic	Engineering plastic ABS + PC	

Outline dimension	338×253×65(mm)
Opening dimension	330×246(mm)
Weight	About 1.8 kg
Configuration software	SKWorkshop 4.0.0

1.6 Principle of the touch screen

Samkoon SK series touch screen uses powerful 32-digit RISC microprocessor, with low power consumption, low temperature rise, low failure rate and aging of the machine, and high reliability of the system. It also includes internal memory, external system program memory, power circuit module, communication module, display and touch module, and so on. Figure 1-17 is a schematic diagram for the structure of the touch screen:

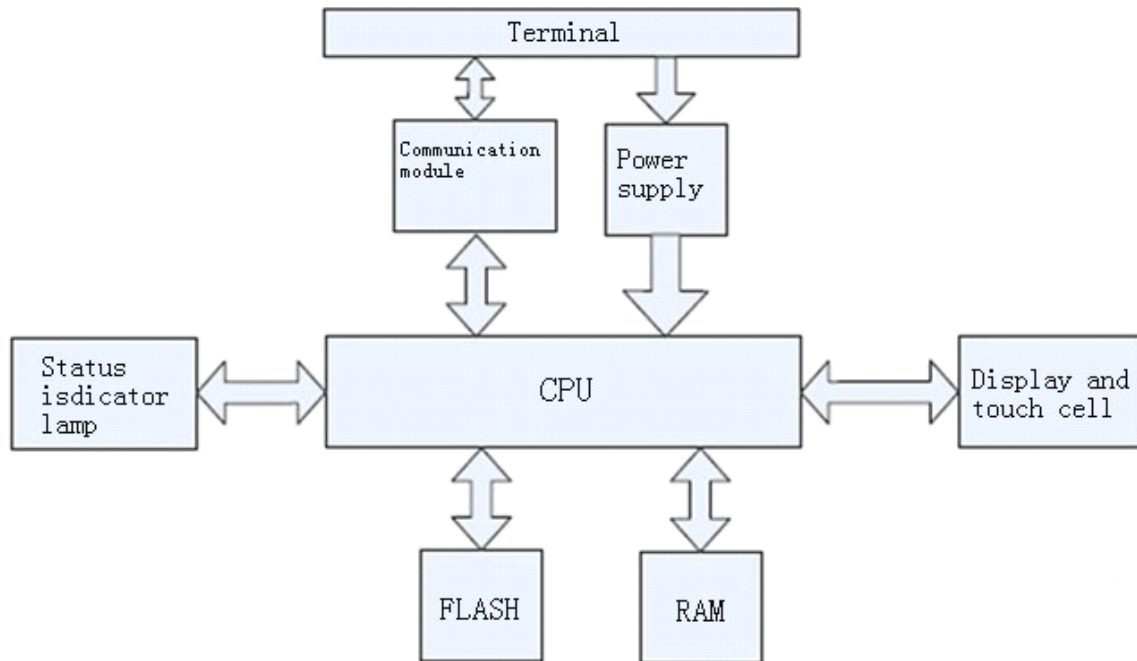

Figure 1-17: Schematic diagram for the structure of SK series touch screen

1.6.1 CPU module

32-digit RISC microprocessor is used, with higher computation rate, lower power consumption and stable operation.

1.6.2 Touch screen display module

SK-4.3A, SK-4.0A and SK-3.5A use 4-wire electric resistance type touch screen plate, and SK-12.1A, SK-10.4A, SK-10.2SK, SK-8.0A, SK-7.2A, SK-7.0A, SK-5.7A, SK-5.7C, SK-5.7D, SK-5.7F and SK-5.0A use 5-wire electric

resistance type touch screen plate, with high touch precision, high durability, and long service life. The display screen brings TFT LCD 260,000-pigment true color display.

1.6.3 Communication module

This module is designed with high resistance against interference, high voltage and lightning. It has enhanced communication accuracy and reliability and supports RS232, 485 and 422 communications.

1.6.4 Memory module

FLASH with power failure retention is used as ROM, providing rapid access and a high capacity for all models up to 128M;

1.6.5 Power supply module

High-precision switch voltage-stabilizing power supply is used, with lower power consumption.

1.7 Industrial environment

Samkoon series touch screens meet the standards of EN50022 and EN50024, and the requirements of FCC, Class A. They have strong resistance against interference, and meet the requirements of industrial application environment for electromagnetic compatibility.

1.8 Wiring

Samkoon SK series touch screen requires DC 24V power supply. Figure 1-18 shows the connection of the touch screen with PLC and PC:

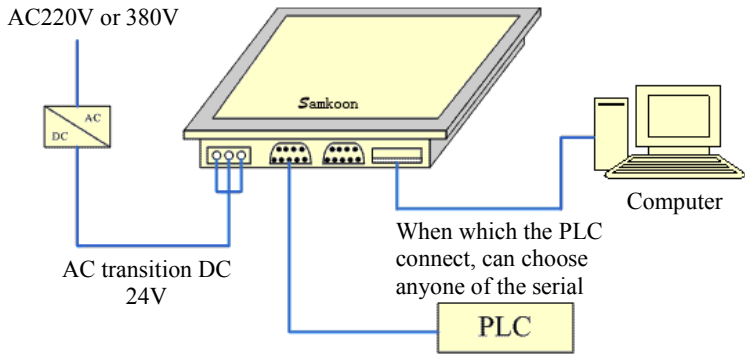

Figure 1-18: Connection diagram of SK series touch screen

USB cables for connection with PC are supplied along with the machine.

2. Quick start of SKWorkshop

This chapter introduces installation of SKWorkshop configuration software, including installation of configuration program and equipment drive, as well as basic functions and main characteristics of the software. It also introduces in detail the composition of the software system and the functions of each component, helping users to understand the overall structure framework of SKWorkshop configuration software. In addition, it introduces the hardware and software requirements of SKWorkshop, and the installation process and working environment of SKWorkshop, helping users to learn use of this software and create application projects.

2.1 What is SKWorkshop?

SKWorkshop configuration software is the configuration visual development system of Samkoon SK series touch screens produced by Shenzhen Samkoon Automation Technology Co., Ltd.. As integrated development environment software it has abundant and powerful development functions. SKWorkshop adopts the advantages of Windows system, with high user interface consistency and simple interfaces. The layout of the menus is close to those of Windows system, making it easy to learn, so that project designers can easily develop suitable configurations for their projects using SKWorkshop. Its function and structure features can help users to shorten the process of developing automation projects and the process of system upgrading and maintenance. It provides seamless integration with third party applications, effectively enhancing the productivity.

Functions and features of SKWorkshop are as follows:

1. Screen display. The color of Samkoon touch screens reaches 260,000-pigment, and compared with the products of other manufacturers the color is more vivid. Besides, SKWorkshop provides a larger picture library, helping designers to design their configurations more conveniently and quickly. After configuration is downloaded to the touch screen, it has the same appearance as on PC screen, without distortion of color and font. Meanwhile, SKWorkshop has very simple operation interface, and the menu layout is similar to that of Windows. It absorbs and integrates the advantages of many major visual configuration software and touch screen configuration software, helping users to configure high performance and high quality project documents.
2. Complete functions. SKWorkshop has complete functions, including basic shape drawing, coloring, text preparation, system picture library, animated display, bitmap status change, trend picture display, alarm control, and the like. In updating of SKWorkshop4.0.0, powerful functions such as dynamic circle, dynamic rectangle, meter, historical data collection, address searching, off-line simulation, data transfer, macro, and multi-function button are added. Designers can easily design schemes and configuration basing on their own requirements and characteristics of projects, and can achieve satisfactory effects.
3. Communication. SKWorkshop provides drives for communication with PLCs projects of all major manufacturers in the world, such as Siemens, Mitsubishi, Omron, Fuji, Panasonic, Schneider and Emerson. Meanwhile, the Company can also develop individualized PLC communication drive upon request of users. Two communication drives can be loaded at the same time in SK-12.1A, SK-10.4A, SK-10.2A, SK-8.0A, SK-7.2A, SK-7.0A, SK-5.7A, SK-5.7C, SK-5.7D and SK-5.7F.
4. Resources. SKWorkshop provides abundant resources. The picture library of SKWorkshop includes 3D indicator light, 3D button, television, 3D tank, 3D pipe, electron, bars, and the like. In addition, many pictures are provided with animation properties and can be used to design vivid animation. It also allows for user-defined picture library and inserting pictures from Windows. SKWorkshop also provides controls that have abundant functions, such as trend diagram and alarming controls and the like, meeting the requirements of various configurations.

2.2 Requirements of SKWorkshop for computer

2.2.1 Software requirements of SKWorkshop for computer

SKWorkshop configuration software can be run in the following operating systems:

- Microsoft Windows NT Server 4.0 or later release;
- Microsoft Windows NT Workstation 4.0 or later release;
- Microsoft Windows 98, Me, 2000, XP or later release.



SKWorkshop will refuse to be installed if the operating system does not meet the above requirements.

Recommended system:

It is recommended to use Windows XP SP3 as the operating system.

2.2.2 Hardware requirements of SKWorkshop for computer

The minimum hardware requirements of SKWorkshop are:

- CPU: Pentium 3-800MHz as a minimum;
- Memory: When Windows 9X operating system is used, the memory should be 128MB or above;
When Windows NT operating system is used, the memory should be 256MB or above;
When Windows 2000 or XP operating system is used, the memory should be 256MB or above;
- Graphics card: Compatibility with Windows system, graphics memory of 1MB or above, allowing for running at 1024*768, 256 colors.
- Hard disk: The minimum hard disk occupation of SKWorkshop configuration software is 200MB.
- USB interface is required.
- Two-key mouse and keyboard.



If the computer configuration is lower than the above requirements, SKWorkshop is likely unable to be installed and operated.

Recommended configuration:

- CPU: Intel Pentium 800 or above, or equivalents;
- Memory: When Windows 9X operating system is used, the memory should be 256MB or above;
When Windows NT operating system is used, the memory should be 512MB or above;
When Windows 2000 or XP operating system is used, the memory should be 512MB or above;
- Graphics card: Compatibility with Windows system, graphics memory of 1MB or above, allowing for running at 1024*768, 65535 colors.
- Hard disk: Over 200MB.

2.3 Installation of SKWorkshop configuration software

SKWorkshop is a 32-digit application specially designed for standard Microsoft Windows systems. Before installation of this software, please confirm that the software and hardware of the computer meets the above-mentioned minimum requirements.

Install SKWorkshop4.0.0 using the installation CD provided along with the product. The detailed installation steps are as follows:

- Start up Windows;
- Place the CD into the CD drive.
- The contents of the CD are shown in Figure 2-1. Please check the contents of the CD.



Figure 2-1: Contents of the installation CD

If any part of the contents is missing, please contact the Company, and we will provide sincere service to you.

- After inserting the CD, a window of SKWorkshop installation program will pop up. Open the CD directly, and execute Setup_V4.0.0.exe. Then an installation window as shown in Figure 2-2 will appear.

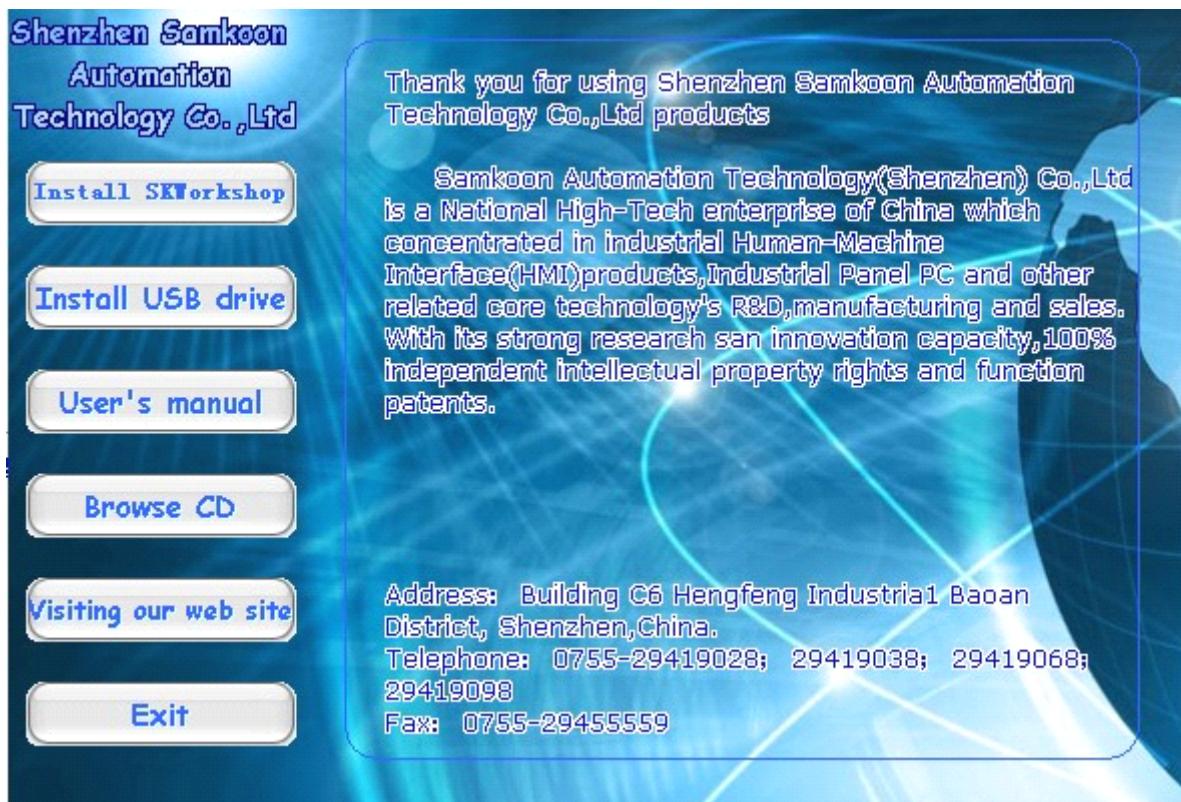
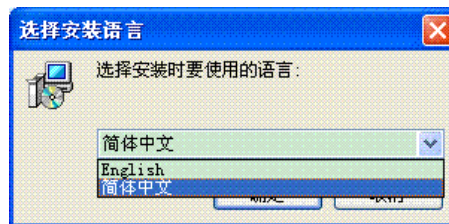

Figure 2-2: Automatic running page

- In the installation window, select “Install SKWorkshop4.0.0”, that is left click the red circle in Figure 2-2 to start installation.
- In the welcome window, you can also install USB drive program, view the CD, read user manual, access the website of the Company via the hyperlink, and view contact information of the Company. You can quit installation by clicking the “Exit” button on the right bottom corner.
- After starting up the installation program, the following language selection box will pop up, allowing user to select English or Simplified Chinese installation. Here we take Simplified Chinese as an example. Choose “Simplified Chinese”, and click “OK”, then the startup dialog will pop up in several seconds.



- In the startup dialog, click Next to continue installation, or click Cancel to quit installation, as shown in Figure 2-3. Before installation, please confirm that SKWorkshop3.3 or earlier releases have been uninstalled, or normal use of SKWorkshop4.0.0 may be impacted.

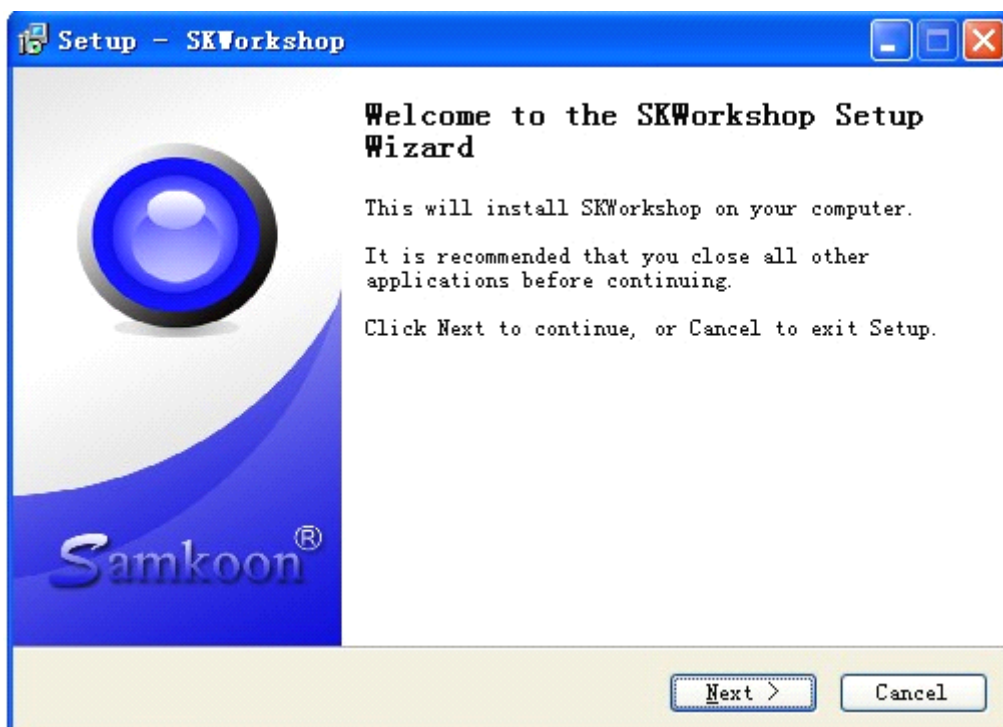

Figure 2-3: Installation window

- In the license agreement dialog, please select whether to accept the software clauses, and click “next”. See Figure 2-4:

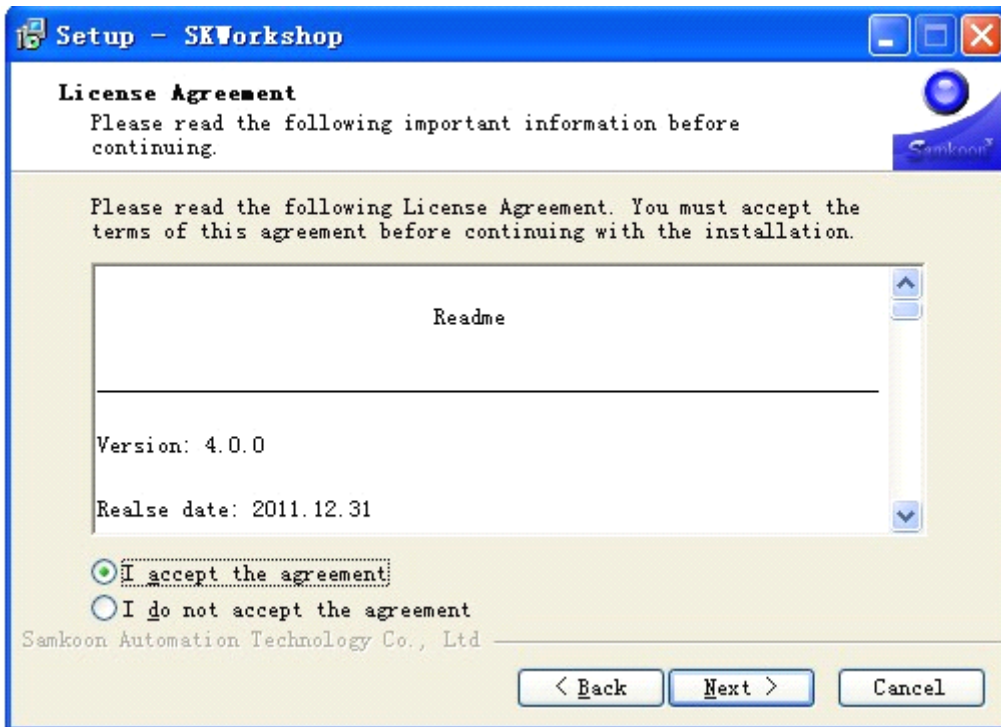

Figure 2-4: Agreement accepting page

- Users can fill in their own personal or company information, or choose the default setting “C:\Program File\SKWorkshop”, and then click “next”. See Figure 2-5.

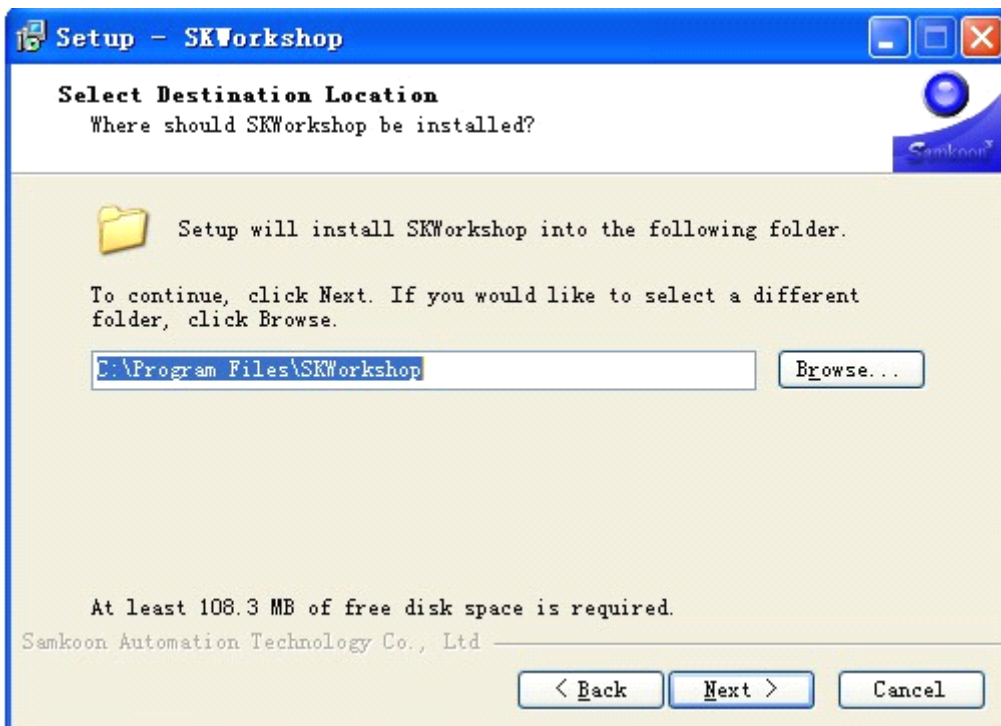

Figure 2-5: Installation directory selection page

If you have installed SKWorkshop4.0.0 before, a dialog as shown in Figure 2-6 will pop up:

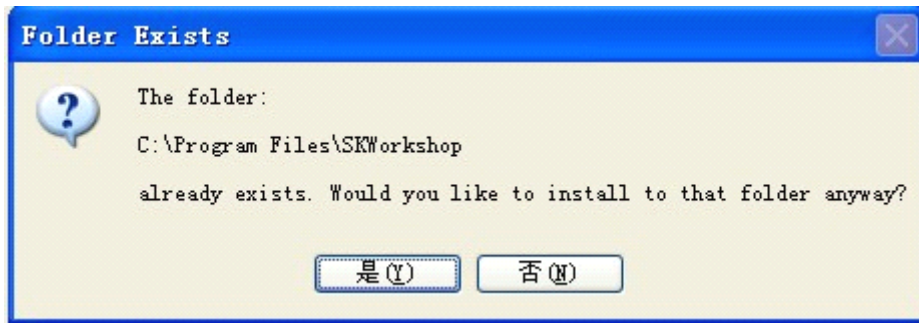

Figure 2-6: A prompt dialog

If you want to cover the previous installation, click Yes; Otherwise, click No to go back to the dialog as shown in Figure 2-5 and reselect an installation directory.

- After clicking Yes in the dialog as shown in Figure 2-6, a dialog will appear to allow you to choose the installation folder. You may choose the default folder or other folders. Then, click Next, as shown in Figure 2-7.

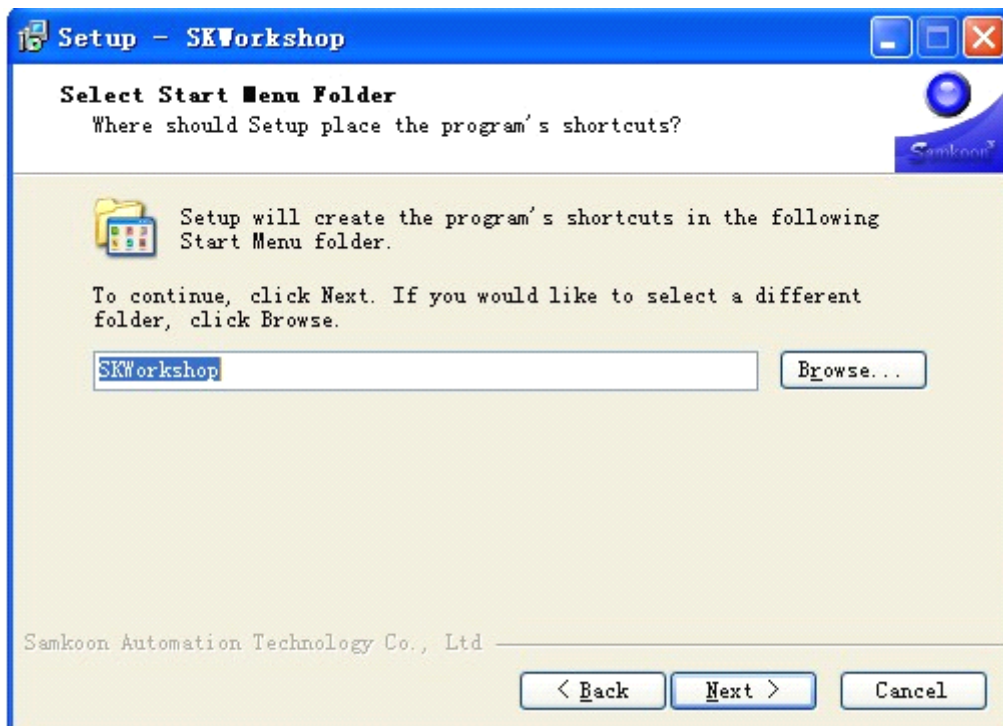

Figure 2-7: Installation folder selection dialog

- Choose whether to create a desktop shortcut, and then click Next, as shown in Figure 2-8.

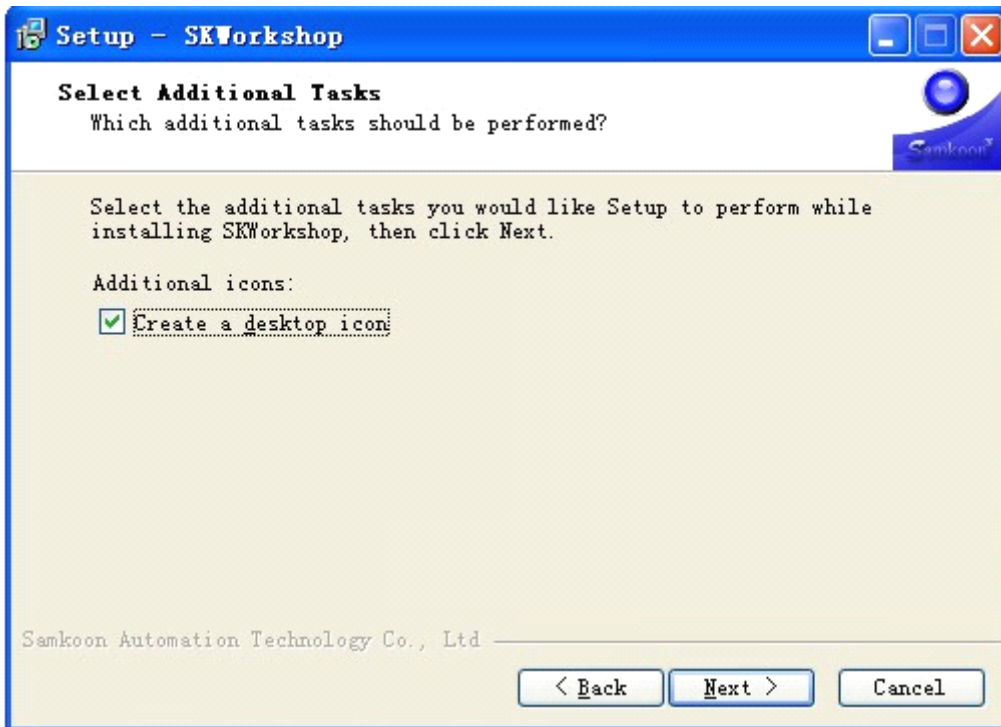

Figure 2-8: Choose whether to create a desktop shortcut

- Then a confirmation dialog will appear, showing the installation directory, installation folder and whether to create a desktop shortcut chosen by the user. Click Next, as shown in Figure 2-9.

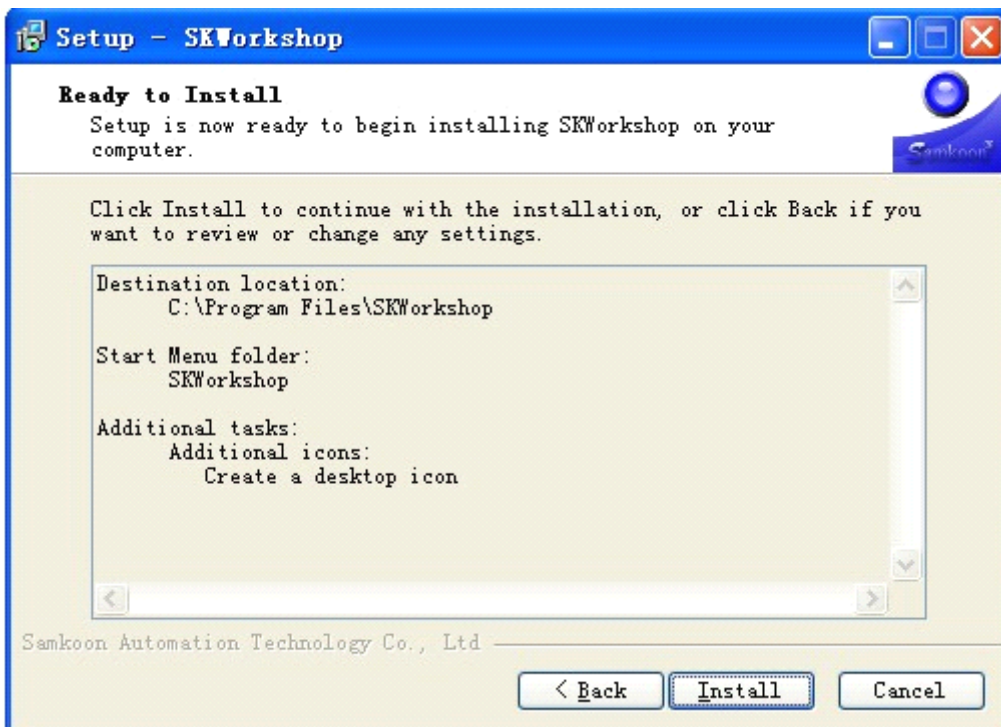

Figure 2-9: Installation confirmation dialog

- Then an installation dialog will appear where you can click Cancel to cancel the installation, as shown in Figure 2-10.

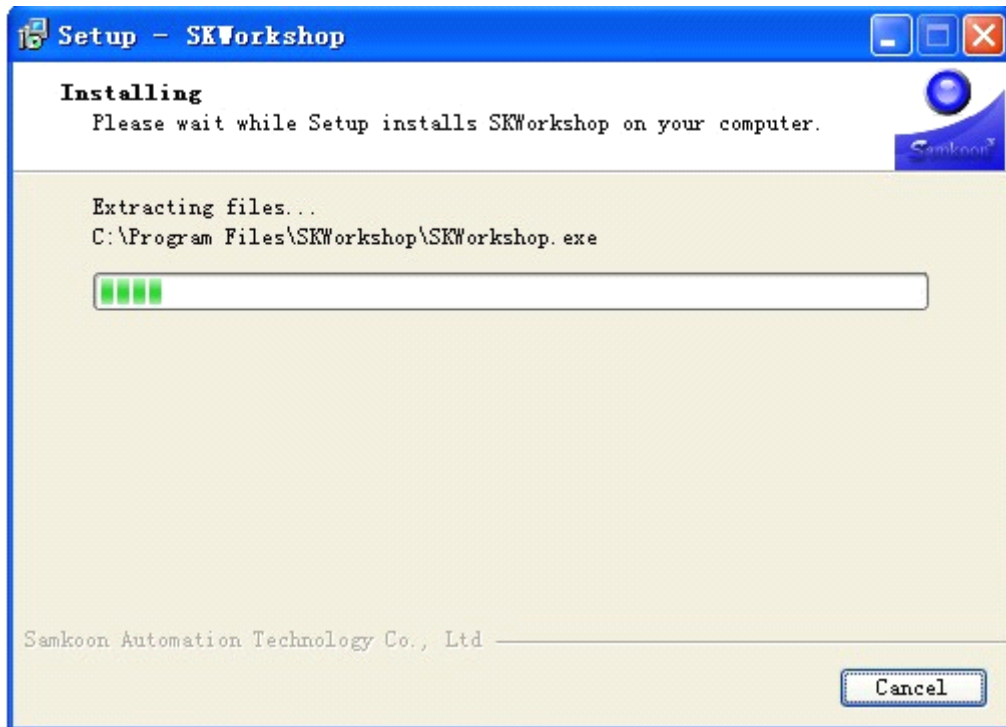

Figure 2-10: Installation dialog

- After completion of installation, click OK to complete the installation process, as shown in Figure 2-11.

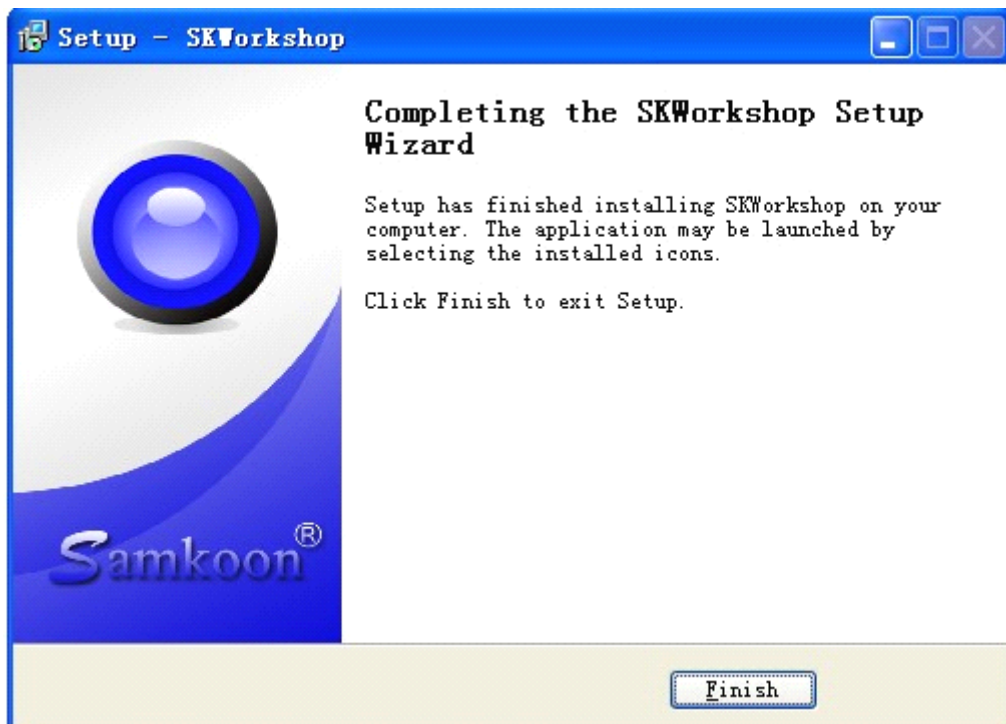

Figure 2-11: Installation completion dialog

- After that, an icon of SKWorkshopV4.0.0 will appear on the desktop, as shown in Figure 2-12.



Figure 2-12: Shortcut icon

- You can also click “SKWorkshop” in “Start”---“All programs”--- “SKWorkshop4.0.0” to run SKWorkshop configuration software.



2.4 Uninstall of SKWorkshop configuration software

There are two uninstalling methods, as introduced below:

The first method:

First, select “Start” – “Program” – “SKWorkshop” in Windows, and then select “Uninstall” option. See Figure 2-13.



Figure 2-13: Select “Uninstall”

Second, click “Yes” in the pop-up dialog, and wait for automatic deletion of the software by Windows system. After completion of the deletion process, click “OK” button to end the uninstalling. See Figure 2-14 and 2-15:

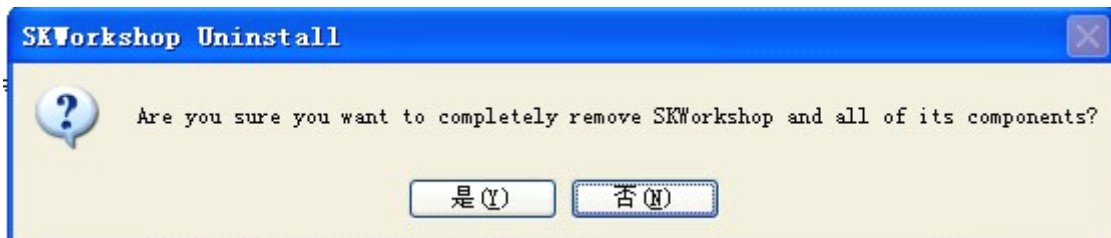

Figure 2-14: Confirm the uninstalling

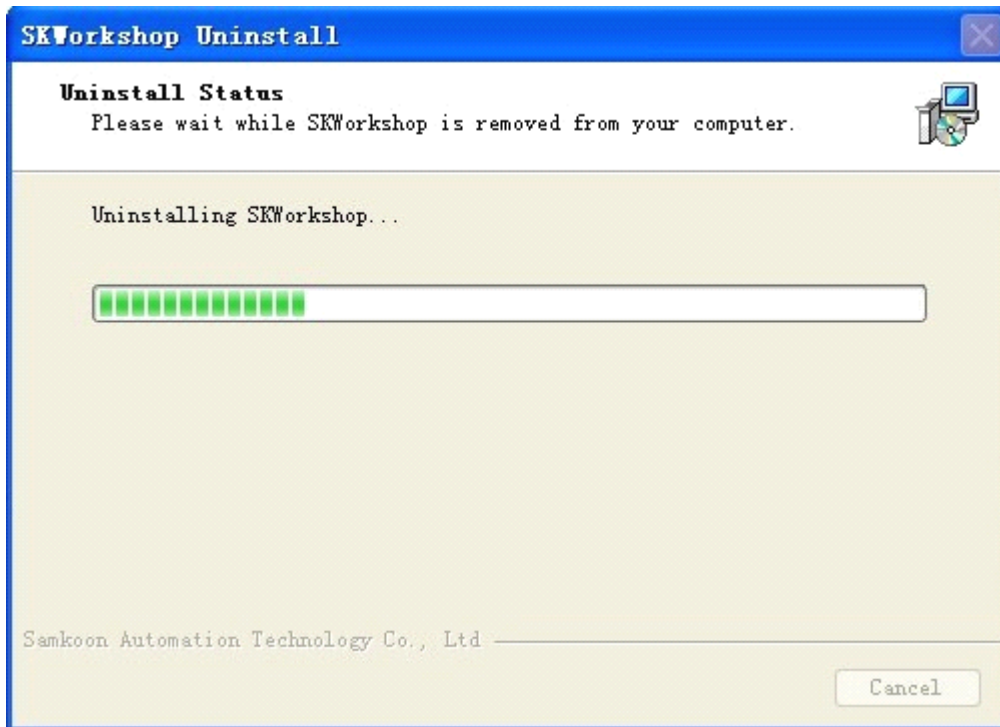

Figure 2-15: Uninstalling completed

The second method:

First, click "Start" – "Setting" – "Control Panel" of Windows to open the control panel, and click "add/delete programs". Then a pop-up dialog will appear. See Figure 2-16:

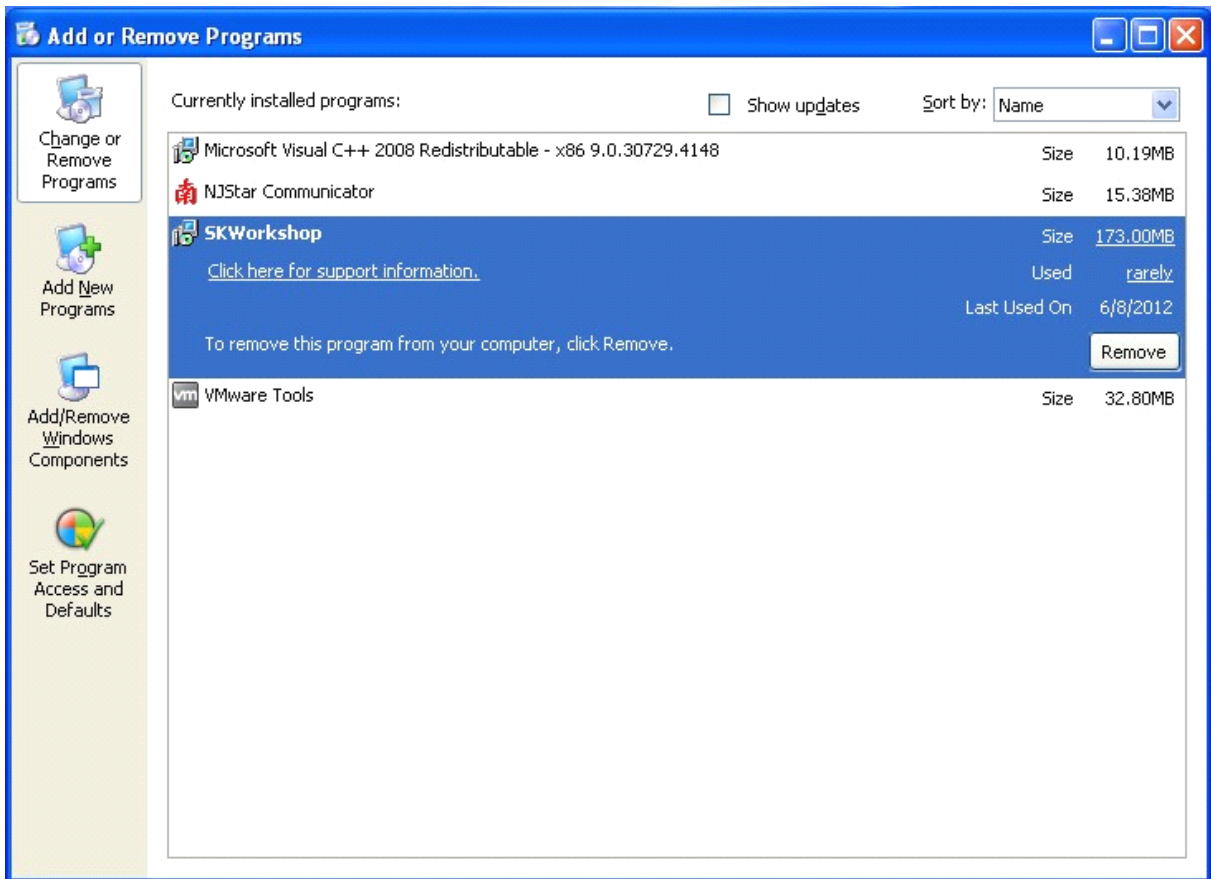

Figure 2-16: Add/delete program page

Second, select “SKWorkshopV4.0.0” in the page shown in Figure 2-16, and click “Change/Delete” button. Then, the system will automatically delete SKWorkshopV4.0.0 and related components as introduced in Step 2 and Step 3 of the first method.

2.5 Operation of SKWorkshop

After installation of SKWorkshop, a shortcut will appear on the desktop, as shown in Figure 2-17:



Figure 2-17: Shortcut on the desktop

Meanwhile, SKWorkshop program group is added in Start menu of Windows, as shown in Figure 2-18:



Figure 2-18: Program icon in Start menu

Double click the shortcut on the desktop, or click SKWorkshop.exe in the SKWorkshop program group in the Start menu to run the software. See Figure 2-19 for the software running page:

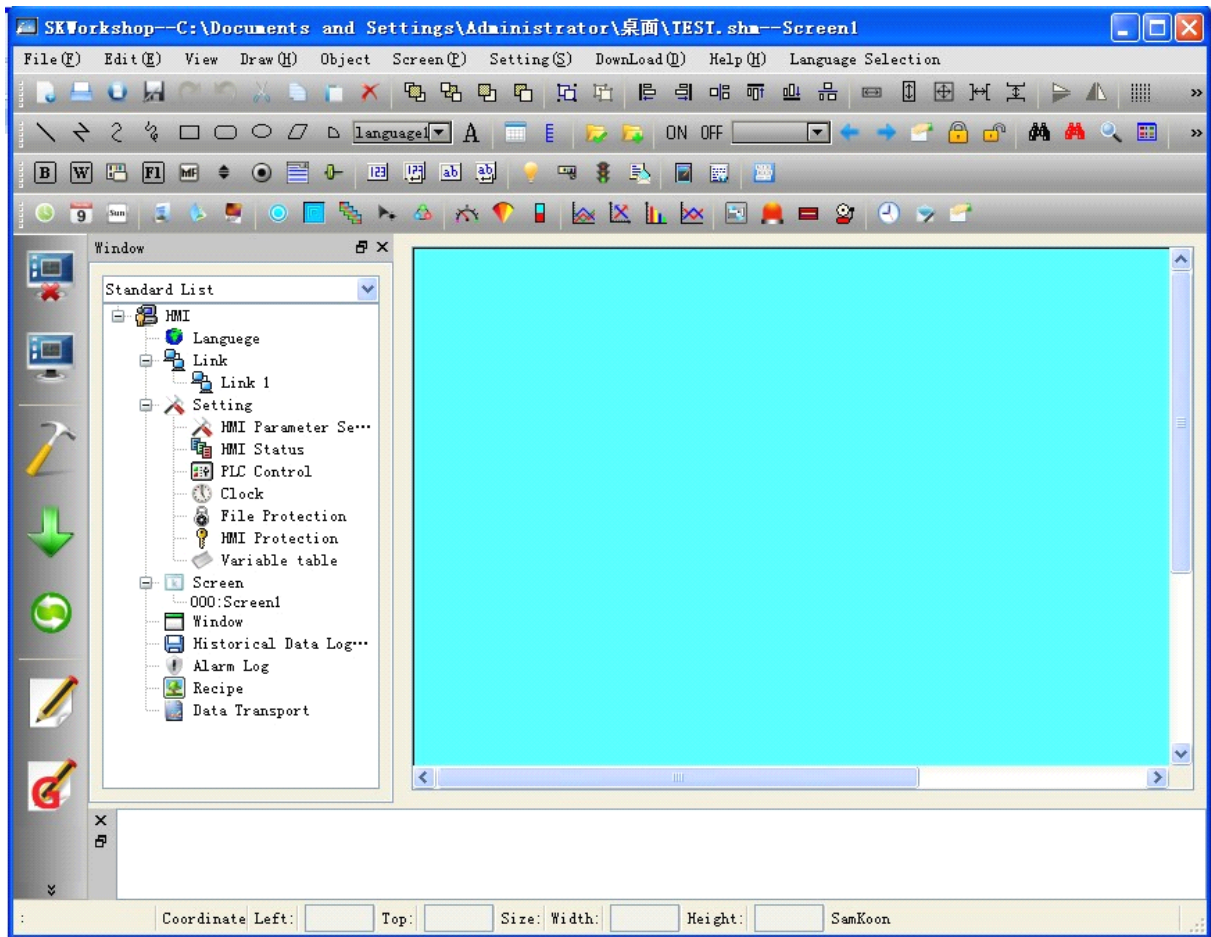

Figure 2-19: Software running page

2.6 Installation of USB driver of SKWorkshop

Before downloading configuration files to the touch screen, you must install USB driver of the touch screen, or the PC will not identify the touch screen after connection and thus configuration projects cannot be downloaded.

Appropriate installation method should be chosen according to the version of Windows.

1. The steps of installation under Windows XP, 2000 and 98 are as follows:

- Start up Windows;
- Place the installation CD into the CD drive.
- Double click USBDriver file to start installation. See Figure 2-20.

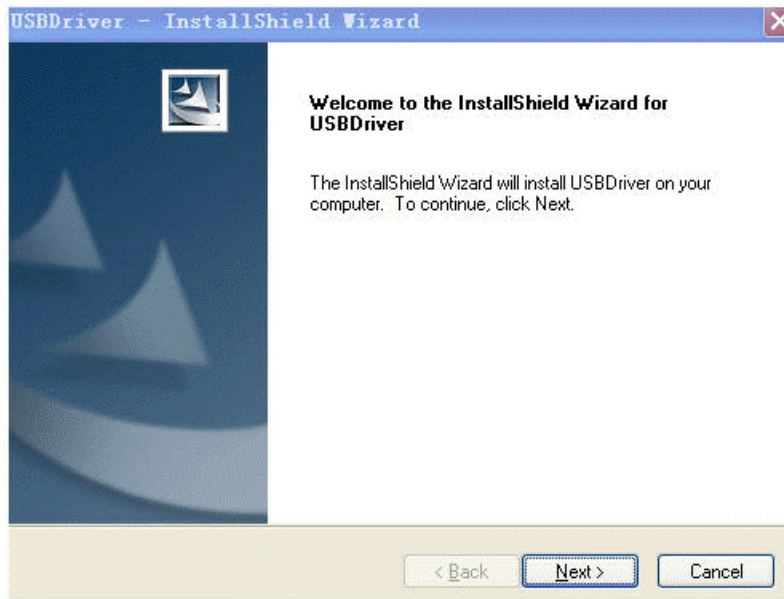

Figure 2-20: Install the USB driver

- After the installation has completed, you can connect the touch screen with the PC via USB.
2. Installation under Windows VISTA:
- Manual installation is required under Windows VISTA.
 - Start up Windows.
 - Connect the USB cable of the touch screen to the PC, and then a page as shown in Figure 2-21 will appear:

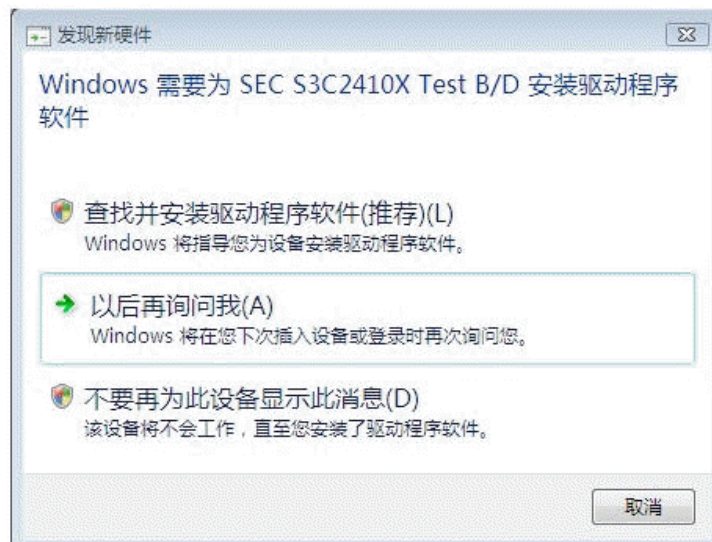

Figure 2-21: VISTA identifies the driver

- Select “Ask me later”, and then open the device manager to find the touch screen equipment. Right click on the equipment, and choose to update the driver. See Figure 2-22.

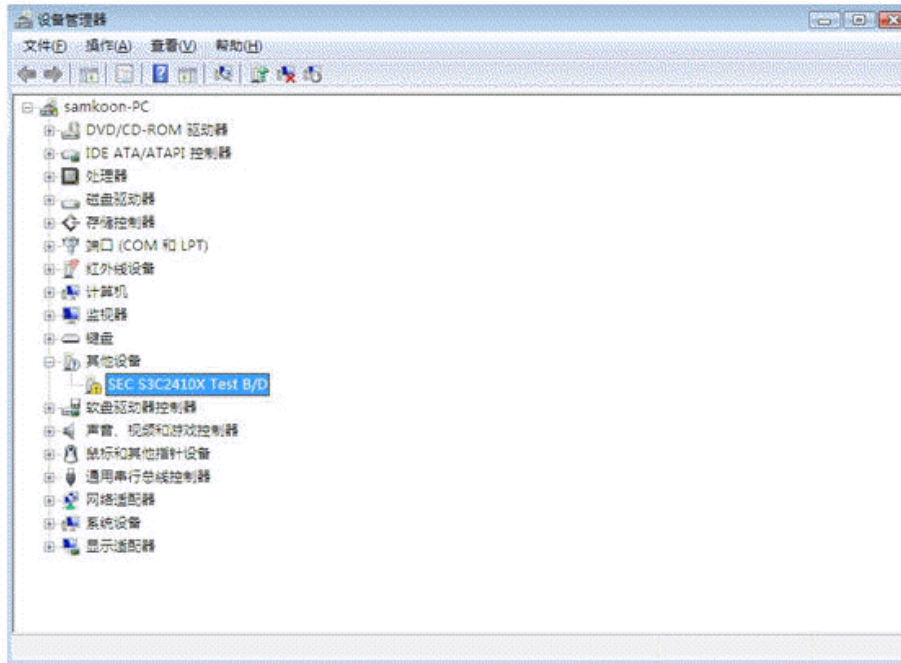

Figure 2-22: Device manager page of VISTA

- Choose “View the computer to find the driver software” on the installation page. See Figure 2-23.

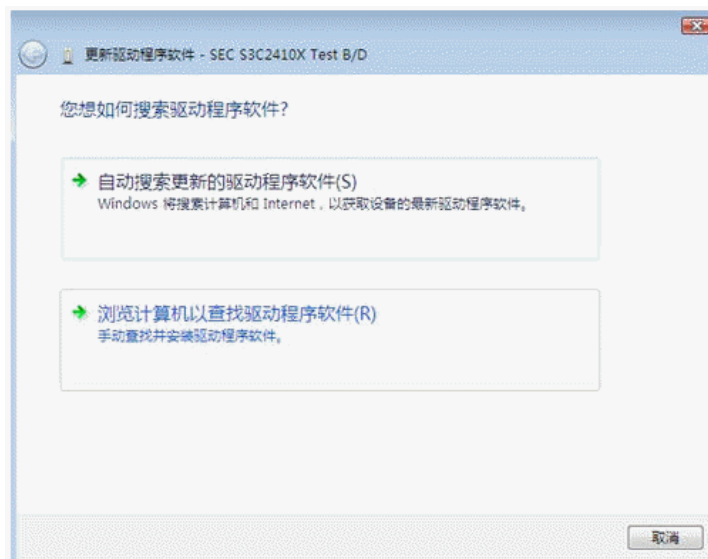

Figure 2-23: Driver updating page of VISTA

- Then, view “Manual installation” directory, and click “next”. See Figure 2-24.

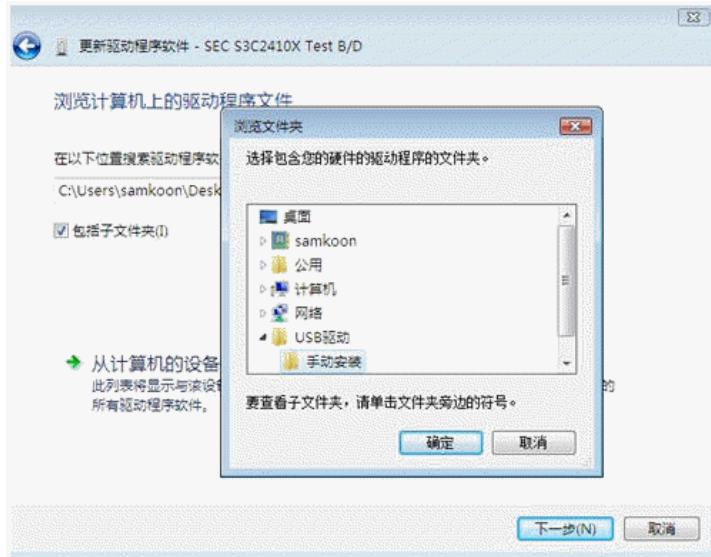

Figure 2-24: Manual installation selecting page of VISTA

- Choose “Always install this driver software”. See Figure 2-25.



Figure 2-25: Driver installation

- After installation, connect the touch screen with PC using USB cable. We can find a serial driver named Samkoon HMI Tech Corp under “General serial bus controller” of the device manager. See Figure 2-26.



Figure 2-26: Driver name

- So far, the touch screen has been connected properly with the computer.



After connection of Samkoon SK series touch screen with a computer, do install USB driver strictly following the above steps, or you may fail in downloading the project configuration.

2.7 Editing page and system composition of SKWorkshop

2.7.1 Editing page of SKWorkshop

SKWorkshop configuration software is the configuration visual development system of Samkoon SK series touch screens produced by Shenzhen Samkoon Automation Technology Co., Ltd... As an integrated development environment software it has abundant and powerful development functions. SKWorkshop adopts the advantages of Windows system, with high user interface consistency and simple interfaces. The layout of the menus is close to those of Windows system, making it easy to learn, so that project designers can easily develop suitable configurations for their projects using SKWorkshop. The development interface and the functional areas are shown in Figure 2-27.

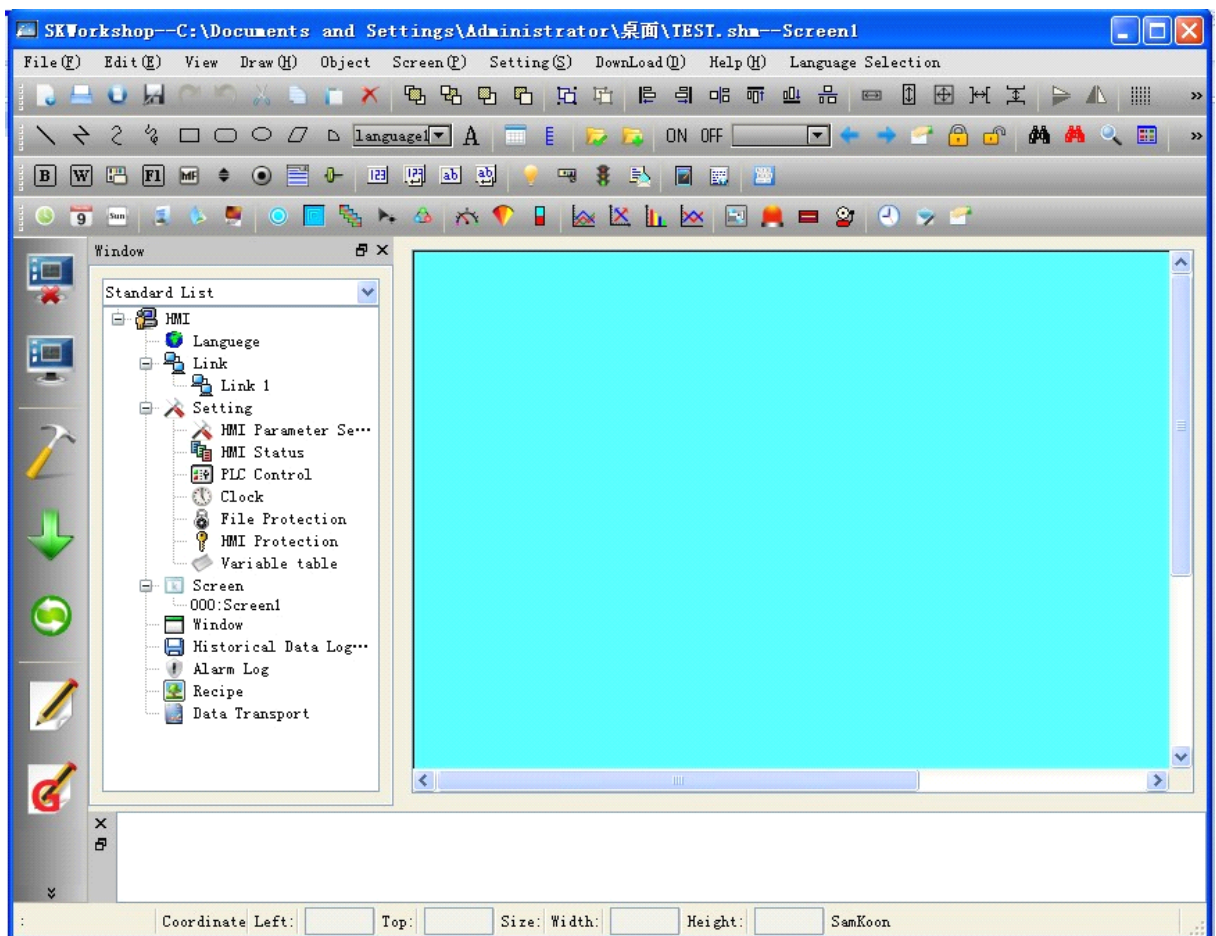

Figure 2-27: Interface and areas of the software

- Title bar: Displaying version number of SKWorkshop.

- Menu bar: Displaying command menus of SKWorkshop. All these menus are drop-down menu.
- Tool buttons: Shortcut buttons of some commands. Displaying corresponding buttons of file, edit, drawing, and some other functions.
- Picture area window: A window for designers to configure and edit graphs.
- Project manager: Tree menu for communication connection, parameter setting, screen management, alarming setting, recipe setting, and historical data collection.
- Information output window: Displaying prompt messages such as input/output information and error prompt when the designer are editing and compiling configuration.
- Status bar: Displaying current configuration status, including coordinate of mouse, control type, coordinate of control, size of control, and the like.

Menu bar of SKWorkshop

Menu bar of SKWorkshop configuration editing software provides users with abundant menu options, and here you can find almost all tool commands and editing commands required during configuration. The menu bar consists of File menu, Edit menu, Draw menu, Object menu, Screen menu, Setting menu, Download menu and Help menu, and also includes right click menus. See Figure 2-28.

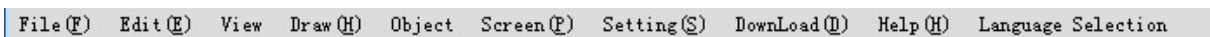

Figure 2-28: Menu bar

- File menu

File menu includes such options as New Project (N), Open Project (O), Close(C), Save(S), Save As and Quit (Q). Grey options indicate the corresponding operation is invalid under current environment. To open File menu, click the “File (F)” button on the left top corner of the screen, and then a drop-down bar will appear. See Figure 2-29.

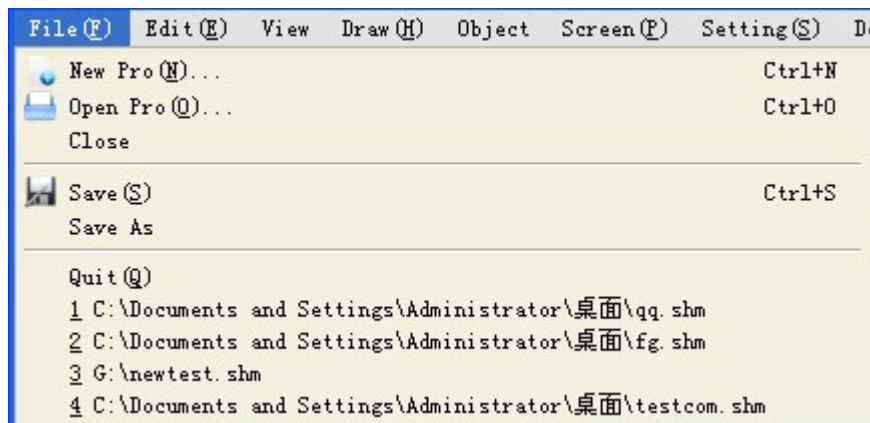

Figure 2-29: “File” menu

New Project: Used to create a new blank project. The shortcut key is Ctrl + N.

Open Project: Used to open an existing project file saved in Windows. Project configuration files with an extension name of “.drw” can be opened. The shortcut key is Ctrl + O.

Close: Used to close the current project screen configuration without quitting SKWorkshop configuration software.

Save: Used to save the current screen configuration that has been changed, with the file name and directory being the same as the original. The shortcut key is Ctrl + S.

Save As: Used to save the current screen configuration, with the file name and directory being changeable.

Quit: Used to quit SKWorkshop configuration software.

- **Edit menu**

“Edit” menu consists of commands used to edit screen, text and drawing as well as some auxiliary commands, including Undo (U), Redo (R), Cut (T), Copy (C), Duplicate (D), Paste (V), Delete (D), Select All (A), Align, Layer, Rotary, Assemble, Mirror, Zoom, Pan View, Grid, Grid Width, Border Scale, The Forward Screen, The Backward Screen, Open Screen Property, Information Output Window, Project Manager, Find Address, and Address Table. Grey commands are invalid under the current environment, and can be used only when the object to be edited is chosen. Some commands in Edit menu are group commands, which are marked with a small triangle on the right side of the line. In addition, each command has a shortcut key. This menu is a drop-down menu, as shown in Figure 2-30.

Undo: Used to cancel the last operation. The shortcut key is Ctrl + Z.

Redo: Used to recover the last operation. The shortcut key is Ctrl + Shift + Z.

Cut: used to delete the object chosen and copy it to the paste buffer area. The shortcut key is Ctrl + X.

Copy: Used to copy the object chosen to the paste buffer area. The shortcut key is Ctrl + C.

Duplicate: Used to copy several graphs chosen in horizontal and vertical directions, increasing the address by 0-255 units. The shortcut key is Ctrl + D.

Paste: Used to copy the object in the paste buffer area to the current screen. The shortcut key is Ctrl + V.

Delete: Used to delete a chosen object. The shortcut key is Ctrl + Del.

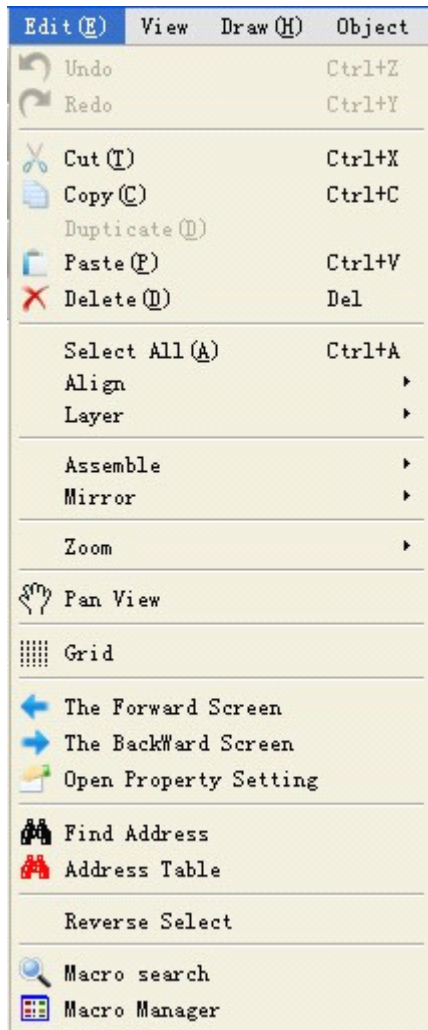

Figure 2-30: “Edit” menu

Select All: Used to select all the objects in the current screen of the current project. The shortcut key is Ctrl + A.

Align: Used to align two or more objects chosen. The align manners include top alignment, bottom alignment, vertical centering, left alignment, right alignment, and horizontal centering.

Layer: Used to place the object chosen to different screen layer. The selectable layers include top layer, one upper layer, bottom layer, and one lower layer.

Rotary: Used to rotate the chosen object. The rotary manners include free rotation, horizontal rotation and vertical rotation.

Assemble: Used to assemble two or more objects chosen to a control, or to disassemble an assembled object to the original objects.



When using Assemble key, do not assemble objects to be touched, or it cannot be touched after downloading to the touch screen. Users may use Layer command to superpose touch objects.

Mirror: Used to overturn a chosen object. The allowable overturning manners include horizontal overturning and vertical overturning.

Zoom: Used to zoom in or out the current screen in order to conduct finer control operation. The available zoom options include 1x zoom in, recover and 1x zoom out.

Pan view: Used to move the current screen up and down or horizontally at will.

Grid: Used to set and cancel in the current screen grids whose widths have been selected.

Grid width: Used to change the grid width of the current screen. The range of such change is 4-16.

Border scale: Used to add or cancel scale lines on the left top corner of the picture window.

The forward screen: Used to open the screen numbered before the current screen.

The backward screen: Used to open the screen numbered after the current screen.

Open screen property: Used to open property window of object (if an object is chosen) or screen (if no object is chosen).

Information output window: Used to open and close information output window.

Project manager: Used to open and close the project manager.

Find address: Used to find an address being used.

Address table: Used to open and close an address table being used. Address table is a list of addresses of objects for the purpose of convenient searching and replacing.

- **Draw menu**

This menu is mainly used to draw pictures. SKWorkshop provides Line (L), Polyline (B), Curve/Arc (A), Free line, Straight Connection Line, Curve Connection Line, Rectangle (R), Ellipse (E), Polygon (Y), Text (T), Open Library (O), Build Library (C), Set ON Status, Set OFF Status, Table and Scale. This menu can be also used to open and close tool box. A “√” on the left of the command indicates the tool box has been displayed in the screen. Using picture elements built with the Tool menu, designers can conveniently change the color, text, size and position of these elements. See Figure 2-31.

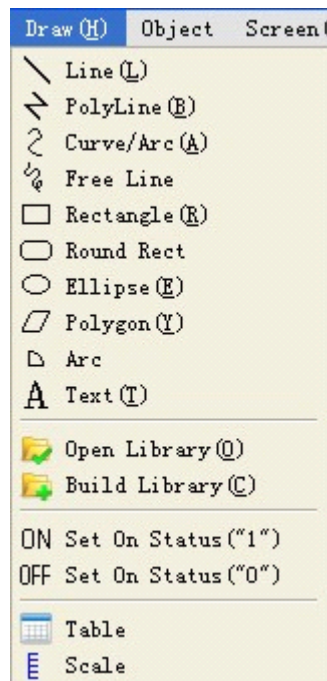

Figure 2-31: Draw menu

Line: Used to draw a straight line of any direction in the current screen.

Polyline: Used to draw a polygonal line of any direction in the current screen.

Curve/Arc: Used to draw a line in the current screen first, and then adjust the radian after canceling drawing by right click.

Free line: Used to draw a line of any direction in the current screen along the movement of the mouse.

Straight connection line: Used to draw a 90° polygonal line between two points in the current screen.

Curve connection line: Used to draw a curve with changing radian between two points in the current screen.

Rectangular: Used to draw a rectangular of any size in the current screen.

Ellipse: Used to draw an ellipse of any size in the current screen.

Polygon: Used to draw a polygon of any shape in the current screen.

Text: Used to create a transparent rectangular box in the current screen, in where any words can be typed.

Open library: Used to open the picture library of the system.

Build library: Used to generate a picture library file basing on the pictures drawn by the user, for the purpose of future use.

Set OFF status: Used to set all digit operation objects in the current screen to OFF status.

Set ON status: Used to set all digit operation objects in the current screen to ON status.

Table: Used to create a table of specified number of rows and columns in the current screen.

Scale: Used to draw required scale.

- **Object menu**

“Object” menu consists of a group of touch keys and functional keys, including Bit Button, Word Button, Screen Button, Function Button, Bit Lamp, Multi-state Lamp, Numeric Display, Numeric Entry, ASCII Character Display, ASCII Character Entry, Bar Graph, Time Display, Date Display, Day-of-Week Display, Static Picture, Picture Display, GIF Display, Trend Chart, XY Trend Chart, Dynamic Circle, Dynamic Rectangle, Alarm Control, Dynamic Alarm Bar, Historic Alarm Dialog, Graphics Move, Meter, Multi-state Switch, Historic Record Display, Message Display, Multi-function Button and Flow Block. “Object” menu corresponds the third row of the tool bar. See Figure 2-32.

Bit button: Used to set in the current screen a touch key for bit operation of the connected device, including bit setting, resetting, inching and alternation.

Word button: Used to set in the current screen a touch key for word operation of the connected device, including constant setting, value inputting, password inputting, adding and subtracting.

Screen button: Used to set screen switch in the current screen, including opening a screen, opening the previous screen, closing and opening a screen, and closing a screen.

Function button: Used to set in the current screen a touch key that realizes certain function of the operating system, including closing back light, confirming alarm, restarting, entering touch screen setting mode, writing a recipe to PLC, reading a recipe from PLC, setting date and time, clearing alarm, the previous recipe, the next recipe, saving the current recipe, moving alarm upward, moving alarm downward, paging down alarm, paging up alarm, adjusting coordinates, system parameters, changing user level, logging off user level, touch sound ON/OFF, alarm sound ON/OFF, clearing all historical data, clearing historical alarm, and HMI protection unlocking.

Bit lamp: used to set in the current screen a graph to monitor bit state of single connected device.

Multi-state lamp: Used to set in the current screen a graph to monitor word state of several connected devices with continuous addresses.



Figure 2-32 “Object” menu

Numeric display: Used to draw in the current screen a numeric display box showing the value of the monitored address.

Numeric entry: Used to draw in the current screen a numeric display box for data entry and showing the value of the monitored address.

ASCII character display: Used to draw in the current screen a numeric display box showing ASCII character words.

ASCII character entry: Used to draw in the current screen an ASCII character display and entry box for inputting ASCII character words.

Bar graph: Used to insert in the current screen bar graph controls. You can use up-and-down or left-right movement of bars to observe the change in the value of the monitored address.

Time display: Used to insert in the current screen a time control to display time.

Date display: Used to insert in the current screen a date control to display date.

Day-of-week display: Used to insert in the current screen a day-of-week control to display day of week.

Static picture: Used to insert in the current screen a static picture from local disk.

Picture display: Used to draw in the current screen a picture display box displaying several pictures.

GIF display: Used to draw in the current screen a picture display box displaying static or animated pictures with an extension name of .GIF.

Trend chart: Used to create in the current screen a trend chart control to monitor change trend of the values of continuous addresses of the connected device.

XY trend chart: Used to create in the current screen an XY trend chart control to monitor the ratio between the values of two continuous addresses of the connected device.

Dynamic circle: Used to create in the current screen a dynamic circle whose size and position can change along with the change in the values of several continuous addresses of the connected device.

Dynamic rectangle: Used to create in the current screen a dynamic rectangle whose size and position can change along with the change in the values of several continuous addresses of the connected device.

Alarm control: Used to create in the current screen an alarm box control to display the date, time and message of each alarm.

Dynamic alarm bar: Used to create in the current screen an alarm bar that can display alarm message and move left or right.

Historic alarm dialog: Used to create in the current screen a historical alarm box control to display the date, time and message of each alarm.

Graphics move: Used to create in the current screen a graph display box whose picture state and position can change along with the change in the values of several continuous addresses of the connected device.

Meter: Used to create in the current screen a meter to monitor the change in the value of single address of the connected device.

Multi-state switch: Used to create in the current screen a multi-state button to monitor change in the value of single address of the connected device by means of state change.

Historic record display: Used to create in the current screen a display control to display the message saved by the historical record collector.

Message display: Used to create in the current screen a display control to display preset messages.

- **Screen menu**

“Screen” menu consists of commands used for screen operation, including New Screen (N), Screen Properties (P) and Delete Screen (D). See Figure 2-33.

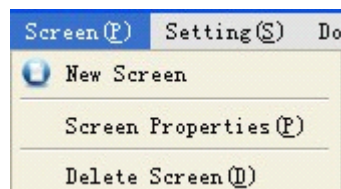

Figure 2-33: Screen menu

New screen: Used to create in the current project a new screen.

Screen properties: Used to open the property dialog of the current screen, where name and background of the screen can be set.

Delete screen: Used to delete the current screen.



: Before deleting a screen please ensure that the screen to be deleted is the current screen, and whether there are useful controls in the screen. Deleted screens cannot be recovered by means of “Undo”.

- **Setting menu**

“Setting” menu consists of the following commands: Preference Setting (P), Alarm Setting (A), Recipe Setting (R), File Protection (M), Macro Editor, Converter, Global Macro and Initial Macro. See Figure 2-34.



Figure 2-34: “Setting” menu

Parameter settings: By clicking this menu item, you can open the parameter settings window where you can set and modify a range of parameters including the touch screen model, mode, startup screen, screen saver time, flash frequency, alarm sound, touch sound, and initial grade and its password etc.

Alarm settings: By clicking this menu item, you can open the digital alarm window and analog alarm window where you can set parameters such as the volume of alarm sound, time for scanning alarm and address for reading alarm etc.

Formula settings: By clicking this menu item, you can open the formula settings window where you can set the parameters of the formula needed by yourself.

File protection: Used to open file protection password setting window, where password can be set for the purpose of protection.

Macro editor: Used to open the macro editor to add, modify, compile or delete a macro.

Global macro: Used to open global macro setting interface to set or modify global macro.

Initial macro: Used to open initial macro interface to set or modify initial macro.



: Please keep firmly in mind the password after setting. Project configuration files with password can be opened only after correct password is entered. The password is case sensitive.

- **Download menu**

“Download” menu is used to compile and download configuration project, consisting of four commands, that is Compile (C), Off-line Simulation (M), USB Download (D) and Compile + Download (A). After the touch screen is connected to PC via USB cable, you can download the configuration project to the touch screen after compiling the configuration project. See Figure 2-35:



Figure 2-35: Download menu

Compile: Used to check the configuration project created by the user, and prepare for downloading.

Off-line simulation: Used to call other applications of SKWorkshop, open simulation panel, and to simulate the current project configuration on PC to check the effect or modify the screen. Please save the project before off-line simulation.

USB download: Used to download the compiled project configuration to the touch screen via the USB cable supplied along with the product. Before downloading, please compile and save the project configuration.

Converter: Use this command to the configuration procedures by the SamDraw3.3into the SKWorkshop V4.0.0version.

- **Help menu**

“Help” menu is used to call the help file of SKWorkshop and the version number and copyright statement of the software. See Figure 2-36.

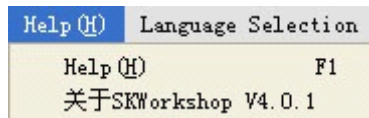

Figure 2-36: Help menu

The help file is shown in Figure 2-37:

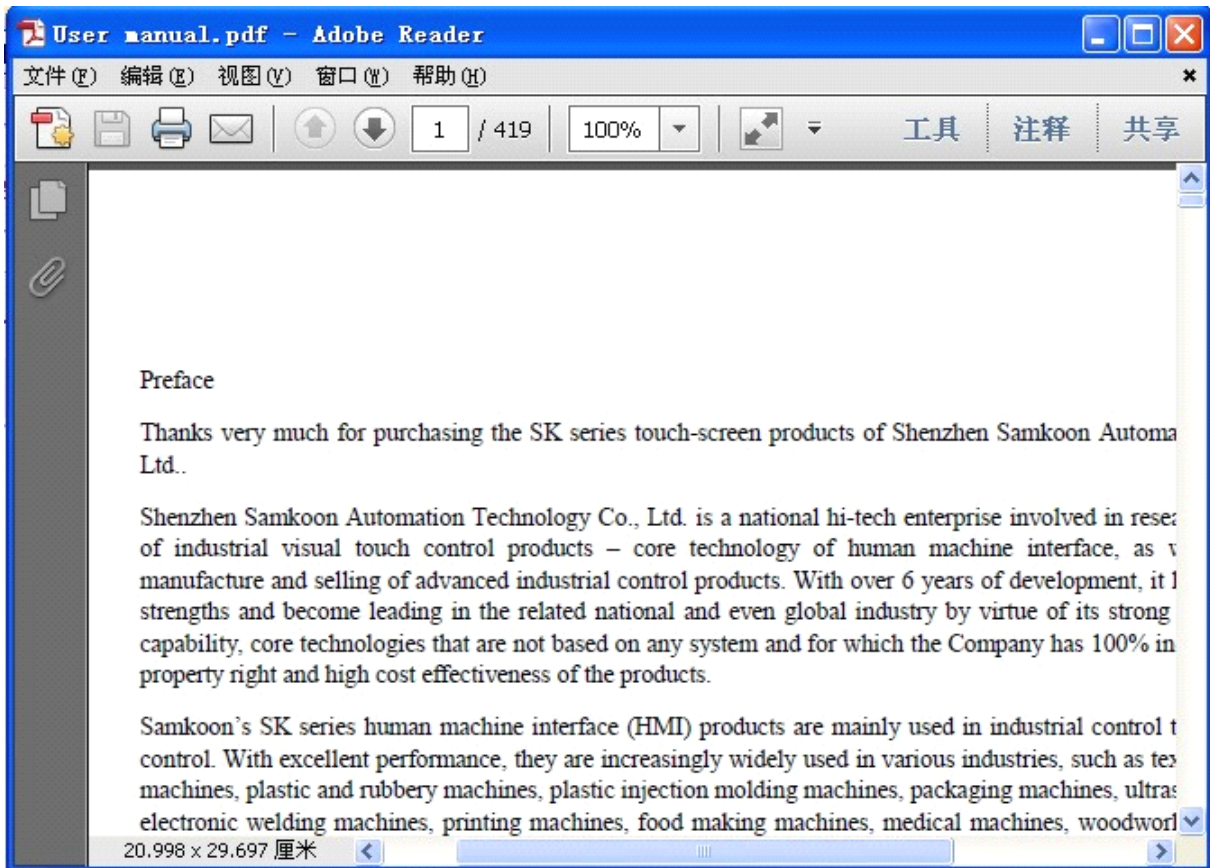

Figure 2-37: Help file

Version number and copyright statement of SKWorkshop are shown in Figure 2-38.

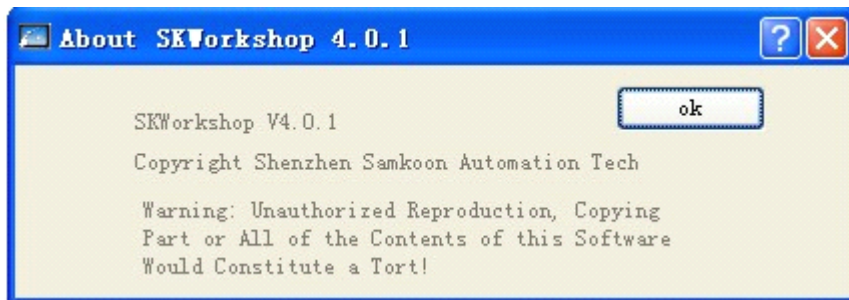
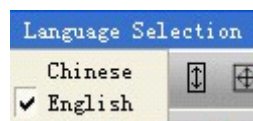

Figure 2-38: Version number statement

- **Translation menu**

This menu is used to switch between Chinese and English version, as shown in the following figure:



Click “Chinese”, the language of the software will be simplified Chinese; Click English, the language will be English.

- Right click menu

To provide convenience for users, a right click menu is set in the software, meeting the operation habit of Chinese and the style of Windows. Many functions used in configuration can be found here. Commands in right click menu include Properties, Insert, Library, Cut, Copy, Duplicate, Paste, Delete, Select All, Align, Layer, Rotary, Assemble, Image Ratio, Grid, Grid Width, Simulation Status and Screen. See Figure 2-39.





Attribute	
Insert	▶
Library	▶
 Cut (T)	Ctrl+X
 Copy (C)	Ctrl+C
Duplicate (D)	
 Paste (P)	Ctrl+V
 Delete (D)	Del
Select All (A)	Ctrl+A
Align	▶
Layer	▶
Assemble	▶
Zoom	▶
 Grid	
Emulation Mode	▶
Screen (E)	▶

Figure 2-39: Right click menu

Properties: Used to open property window of object (if an object is chosen) or screen (if no object is chosen).

Insert: Used to open all object windows in the Object menu.

Library: Used to open and generate picture library.

Cut: Used to delete the object chosen and copy it to the paste buffer area. The shortcut key is Ctrl + X.

Copy: Used to copy the object chosen to the paste buffer area. The shortcut key is Ctrl + C.

Duplicate: Used to copy several graphs chosen in horizontal and vertical directions, increasing the address by 0-255 units. The shortcut key is Ctrl + D.

Paste: Used to copy the object in the paste buffer area to the current screen. The shortcut key is Ctrl + V.

Delete: Used to delete a chosen object. The shortcut key is Ctrl + Del.

Select All: Used to select all the objects in the current screen of the current project. The shortcut key is Ctrl + A.

Align: Used to align two or more objects chosen. The align manners include top alignment, bottom alignment, vertical centering, left alignment, right alignment, horizontal centering, the same height, the same width, and the same height and width.

Layer: Used to place the object chosen to different screen layer. The selectable layers include top layer, one upper layer, bottom layer, and one lower layer.

Rotary: Used to rotate the chosen object. The rotary manners include free rotation, horizontal rotation and vertical rotation.

Assemble: Used to assemble two or more objects chosen to a control, or to disassemble an assembled object to the original objects.



When using Assemble key, do not assemble objects to be touched, or it cannot be touched after downloading to the touch screen. Users may use Layer command to superpose touch objects.

Zoom: Used to zoom in or out the current screen in order to conduct finer control operation. The available zoom options include 1x zoom in, recover and 1x zoom out.

Grid: Used to arrange the current screen and cancel grids whose widths have been selected.

Grid width: Used to change the grid width of the current screen. The range of such change is 4-16.

Simulation status: Used to change the ON/OFF status of all bit operation objects in the current screen.

Screen: Used to create a new screen, open screen property window and delete a screen.



Before deleting a screen please ensure that the screen to be deleted is the current screen, and whether there are useful controls in the screen. Deleted screens cannot be recovered by means of “Undo”.

SKWorkshop Tool bar

SKWorkshop totally provides three lines of shortcut tool buttons, including tool commands and editing commands. After getting familiar with these buttons, designers can find the desired commands quickly without searching in the menu bar. Each button has a floating prompt, which appears when you move the mouse to the button. SKWorkshop totally provides 87 tool buttons. When these buttons are grey, they are invalid under current operation status. See Figure 2-40.

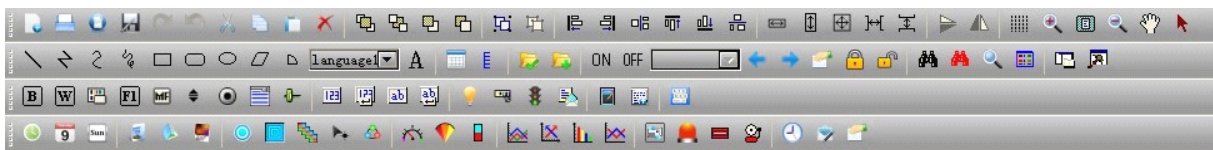

Figure 2-40: Tool bar

As shown in the figure above, the commands in the tool bar are corresponding to the commands in the menus. The functions of the buttons are as follows:

Standard toolbar:



Corresponding to “New” command, with the shortcut key of Ctrl + N, used to create a new blank project.





Corresponding to “Open” command, with the shortcut key of Ctrl + O, used to open an existing project file saved in Windows with an extension name of “.drw”.





Corresponding to “New Screen” command, used to create a new screen in the current project.

: Corresponding to “Save” command, with the shortcut key of Ctrl + S, used to save the current screen configuration that has been changed, with the file name and directory being the same as the original.

: Corresponding to “Undo” command, with the shortcut key of Ctrl + Z, used to cancel the last operation.

: Corresponding to “Redo” command, with the shortcut key of Ctrl + Z, used to recover the last operation.

: Corresponding to “Cut” command, with the shortcut key of Ctrl + X, used to delete the object chosen and copy it to the paste buffer area.

: Corresponding to “Copy” command, with the shortcut key of Ctrl + C, used to copy the object chosen to the paste buffer area.

: Corresponding to “Paste” command, with the shortcut key of Ctrl + V, used to copy the object in the paste buffer area to the current screen.

: Corresponding to “Delete” command, with the shortcut key of Ctrl + Del, used to delete a chosen object from the screen.

: Corresponding to “Move object forward” command, used to move the chosen object to the top layer of the screen.

: Corresponding to “Move object backward” command, used to move the chosen object to the bottom layer of the screen.

: Corresponding to “Move object one layer forward” command, used to move the chosen object one layer forward.

: Corresponding to “Move object one layer backward” command, used to move the chosen object one layer backward.

: Corresponding to “Assemble” command, used to assemble several graph objects chosen to one combined object.

: Corresponding to “Disassemble” command, used to disassemble an assembled graph object to the original objects. It is a reverse operation of “Assemble”.

: Corresponding to “Left align” command, used to align the left boundaries of the chosen objects on the left.

: Corresponding to “Right align” command, used to align the right boundaries of the chosen objects on the right.

: Corresponding to “Top align” command, used to align the top boundaries of the chosen objects at the top.

: Corresponding to “Bottom align” command, used to align the bottom boundaries of the chosen objects at the bottom.

: Corresponding to “Horizontal centering” command, used to horizontally center the graph objects chosen.

: Corresponding to “Vertical centering” command, used to vertically center the graph objects chosen.

: Corresponding to “The same width” command, used to set the same width for the graphs chosen. The minimum left coordinate is taken as the baseline.

: Corresponding to “The same height” command, used to set the same height for the graphs chosen.

: Corresponding to “The same height and width” command, used to set the same height and width for the graphs chosen. The minimum left coordinate is taken as the baseline.

: Corresponding to “Equal horizontal space” command, used to arrange two or more controls at equal horizontal space.

: Corresponding to “Equal vertical space” command, used to arrange two or more controls at equal vertical space.

: Corresponding to “Horizontal overturning” command, used to overturn the chosen graph(s) with the axis of the vertical center line.

: Corresponding to “Vertical overturning” command, used to overturn the chosen graph(s) with the axis of the horizontal center line.

: Corresponding to “Grid” command, used to set and cancel in the current screen grids whose widths have been selected.

: Corresponding to “Zoom in” command, used to zoom in the current screen by 1x. For further zoom in, click this button again.

: Corresponding to “Recover” command, used to recover the current screen to the original standard size.

: Corresponding to “Zoom out” command, used to zoom out the current screen by 1x. For further zoom out, click this button again.

: Corresponding to “Translate” command, used to move the screen in the allowable range of the configuration window. Choose this command first, move the mouse to the picture area, press down the left key of the mouse and keep such state, then move the mouse to desired position and loosen the key.

: Scroll arrow, used to change the palm shape under Translate command back to ordinary mouse shape.

Draw toolbar:

: Corresponding to “Line” command, used to draw a straight line of any direction in the current screen.

: Corresponding to “Polyline” command, used to draw a polygonal line of any direction in the current screen.

: Corresponding to “Curve/Arc” command, used to draw a curve or arc in the current screen.

: Corresponding to “Free line” command, used to draw a line of any direction in the current screen along the movement of the mouse.

: Corresponding to “Rectangle” command, used to draw a rectangle of any size in the current screen.

: Corresponding to “Rounded rectangle” command, used to draw a rounded rectangle in the current screen.

: Corresponding to “Polygon” command, used to draw a polygon in the current screen.

: Sector command, used to draw a sector in the screen.

: Language box, used to choose desired language.

: Corresponding to “Text” command, used to draw a text box in the current screen for word inputting.

: Corresponding to “Table” command, used to create a table of specified number of rows and columns in the current screen.

: Corresponding to “Scale” command, used to draw required scales.

: Corresponding to “Open library” command, used to open the picture library of the SKWorkshop for use by the designers.

: Figure saving command, used to save the current figure or user-selected control or user-imported picture as a control or a figure.

ON: Corresponding to “ON” (“1”) command, used to set to ON status the graph objects in the current screen for which ON/OFF status can be set.

OFF: Corresponding to “OFF” (“0”) command, used to set to OFF status the graph objects in the current screen for which ON/OFF status can be set.

: State drop-down box. When there is a control with state in the current screen, this box will display the state value of the control, and when the value of this box is changed, the chosen control will be changed to the same state corresponding to the value.

: Corresponding to “The forward screen” command, used to switch to the screen before the current screen.

: Corresponding to “The backward screen” command, used to switch to the screen after the current screen.

: Corresponding to “Properties” command, used to open property page of the chosen key.

: Corresponding to “Lock” command, used to lock the chosen key in the screen so that it can be no longer moved.

: Corresponding to “Unlock” command, used to unlock the chosen key.

: Address search button, used to search whether an address has been used, with the searching results shown in the information output window.

: Address browsing button, used to browse all the addresses used by all the controls in all or specified screens.

: Corresponding to “Search macro” command, used to check whether a macro has been used, with the result displayed in the “information output window”.

: Corresponding to “Macro manager” command, used to view the macro use by all controls in the specified screen or all screens.

: Corresponding to “Project manager” command, used to open and close the project manager window.

: Corresponding to “Information output window” command, used to open and close the information output window.

Object toolbar:

Controls in the Object toolbar in the first row:

: Corresponding to “Bit button” command, used to set in the current screen a touch key for bit operation of the connected device, including bit setting, resetting, inching and alternation.

: Corresponding to “Word button” command, used to set in the current screen a touch key for word operation of the connected device, including constant setting, value inputting, password inputting, adding and subtracting.

 : Screen button command, used to set screen switch in the current screen, including opening a screen, opening the previous screen, closing and opening a screen, and closing a screen.

 : Corresponding to “Function” command, used to set in the current screen a control that realizes certain function of the operating system, including closing back light, confirming alarm, restarting, entering touch screen setting mode, writing a recipe to PLC, reading a recipe from PLC, setting date and time, clearing alarm, the previous recipe, the next recipe, saving the current recipe, moving alarm upward, moving alarm downward, paging down alarm, paging up alarm, adjusting coordinates, system parameters, changing user level, logging off user level, touch sound ON/OFF, alarm sound ON/OFF, clearing all historical data, clearing historical alarm, and HMI protection unlocking.

 : Multi-function button, used to create a multi-function button in the current screen to perform several functions by one click.

 : Step button, used to create a step button control in the current screen to perform cyclic switchover of states.

 : Radio button, used to create a radio button control in the current screen so that you can click a specified state area to realize specified state.

 : Drop-down box button, used to create a drop-down box button control in the current screen for view and selection. Once you have chosen an item, the corresponding value will be written into the control address of the character register.

 : Slider analog switch, used to create a slider analog switch control in the current screen. You can drag the slider to change the value of the corresponding character register address.

 : Corresponding to “Numeric display” command, used to draw in the current screen a numeric display box showing the value of the monitored address.

 : Corresponding to “Numeric entry” command, used to draw in the current screen a numeric display box for data entry and showing the value of the monitored address.

 : Corresponding to “ASCII character display” command, used to draw in the current screen a numeric display box showing ASCII character words.

 : Corresponding to “ASCII character entry” command, used to draw in the current screen an ASCII character display and entry box for inputting ASCII character words.

 : Corresponding to “Bit lamp” command, used to set in the current screen a graph to monitor bit state of single connected device.

 : Corresponding to “Multi-state lamp” command, used to set in the current screen a graph to monitor word state of several connected devices with continuous addresses.

 : Corresponding to “Multi-state switch” command, used to create in the current screen a multi-state button to monitor change in the value of single address of the connected device by means of state change.

 : Corresponding to “Message display” command, used to create in the current screen a display control to display preset messages.

: Recipe selector, used to create a recipe selector button in the current screen, which can be used to list all recipes and write and monitor contents of recipe number register (RW10).

: Recipe data display, used to create a recipe data display control in the current screen, which can be used to display the data of user specified recipe.

: Keyboard component, used to create a keyboard component in the current screen for use of user-defined keyboard.

Controls in the Object toolbar in the second row:

: Corresponding to “Time display” command, used to insert in the current screen a time control to display time.

: Corresponding to “Date display” command, used to insert in the current screen a date control to display date.

: Corresponding to “Day-of-week display” command, used to insert in the current screen a day-of-week control to display day of week.

: Corresponding to “Static picture” command, used to insert in the current screen a static picture from local disk.

: Corresponding to “Picture display” command, used to draw in the current screen a picture display box displaying several pictures.

: Corresponding to “GIF display” command, used to draw in the current screen a picture display box displaying static or animated (32 frames) pictures with an extension name of GIF.

: Corresponding to “Dynamic circle” command, used to create in the current screen a dynamic circle whose size and position can change along with the change in the values of several continuous addresses of the connected device.

: Corresponding to “Dynamic rectangle” command, used to create in the current screen a dynamic rectangle whose size and position can change along with the change in the values of several continuous addresses of the connected device.

: Corresponding to “Flow block” command, used to create a flow simulation control in the current screen.

: Corresponding to “Graphics move” command, used to create in the current screen a graph display box whose picture state and position can change along with the change in the values of several continuous addresses of the connected device.

: Animation, used to create an animation control in the current screen to move the controls.

: Corresponding to “Meter” command, used to create in the current screen a meter to monitor the change in the value of single address of the connected device.

: Fan chart, used to create a fan chart (pie chart) control in the current screen to read the value of the monitored address and present it to the control.

: Bar graph, used to insert a bar control in the current screen to show the change in the values of the monitored address with height change or left-right movement of bars.

: Trend chart, used to create a trend chart control in the current screen to monitor the value change trend of continuous addresses of the connected equipment.

: XY trend chart, used to create a XY trend chart control in the current screen to monitor the proportion between the values of two continuous addresses of the connected equipment.

: Data group display, used to create a data group display control in the current screen to display several groups of data in the trend chart.

: Historical trend chart, used to create a historical trend chart control in the current screen to display historical data in the trend chart.

: Historical record display, used to create a historical record display control in the current screen to display historical data collected.

: Alarming control, used to create an alarming box control in the current screen to display the date, time and messages of each alarm.

: Dynamic alarming bar, used to create a dynamic alarming bar in the current screen that can display alarming message in the form of left or right rolling.

: Historical alarming dialog, used to create a historical alarming dialog in the current screen to display the date, time and messages of historical alarms.

: Timer, used to create a macro timer in the current screen to control execution of macros.

: Message board, used to create a message board control in the current screen so that you can write on the control.

Test toolbar:



: Offline simulation, used to directly execute offline simulation command.



: Online simulation, used to directly execute online simulation command.



: Compile, used to check the screen configuration project created by the user and get prepared for downloading.



: Download, used to call the download dialog. You can download the configuration project into the screen if SK series HMI is connected.



: Converter, used to call a dialog with four functions: first, converting a SamDraw3.3 project to a SKWorkshop V4.0 project; second, uploading historical data; third, uploading recipes; fourth, uploading configuration project.



: Macro, used to programme for the configuration screen with C language.



: Global macro, used to set a global macro.



: Initial macro, used to set an initial macro.

SK Workshop project manager

The Project Manager window of SKWorkshop is located below the tool bar on the left of the interface of the configuration software. It can be used to set parameters for the touch screen, including Link, Setting, Screen, Window, Historical Data Logger, Alarm Log, and Recipe. In detail, Link includes Link 1 and Link 2; Setting includes HMI parameter setting, HMI status, PLC Control, Clock, File Protection and HMI Protection. See Figure 2-41.

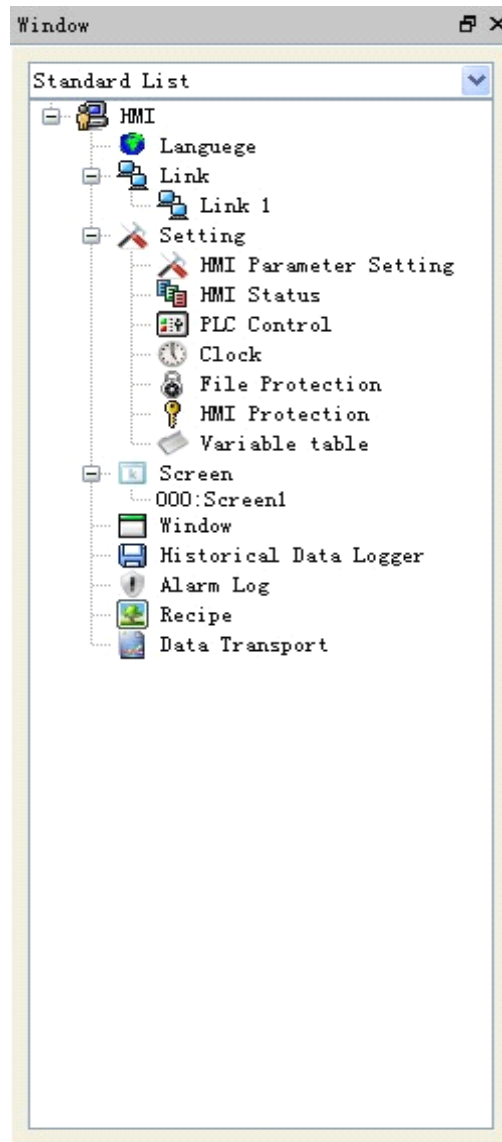

Figure 2-41: Project manager window

2.7.2 System composition of SKWorkshop

SKWorkshop is the configuration editing software of Samkoon touch screen. SKWorkshop allows designers to edit project configuration on PC and then download the final configuration screen and required communication drivers to the storing mechanism of the touch screen via USB. Then, communication with PLC or other connected devices can be constructed through the executive body of the touch screen and serial communication. Figure 2-42 shows the system composition of SKWorkshop:

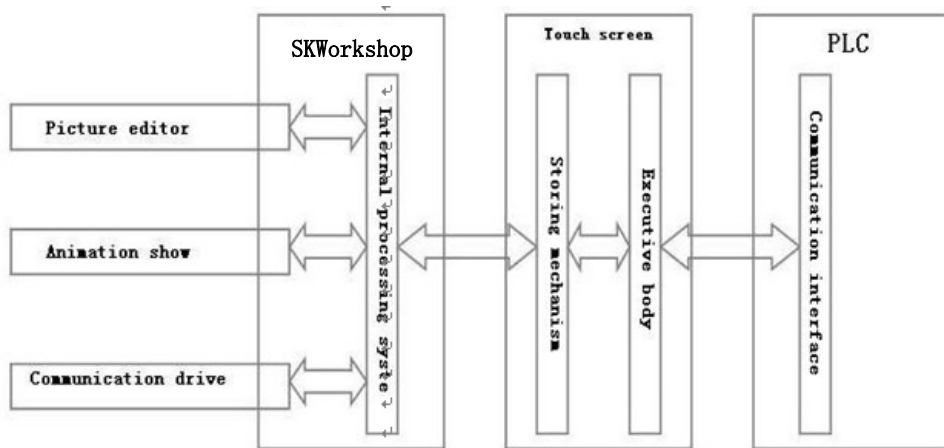

Figure 2-42: System composition of SKWorkshop

2.8 Basic operations of SKWorkshop

This chapter introduces operation of SKWorkshop configuration software, including use of mouse, shortcut keys and some terms.

2.8.1 Use of mouse and shortcut key of SKWorkshop

When preparing configuration screens using mouse, the mouse is as shown in Figure 2-43.

Now we introduce common mouse operations and the functions of such operations in the software:

☉ Left click

The process of pressing down the left key and then releasing is called “Left click” in this Manual. It can be used to select menu items, select object, select tool button, edit configuration and confirm setting.

☉ Double click

The process of quickly and continuously clicking the left key twice is called “Double click” in this Manual. It can be used to set properties for placed objects, set properties of screen and window, set properties of touch screen connection, change settings of the touch screen, create historical data collection, create recipe, and create alarm control. After such clicking a dialog will appear for operation.

☉ Right click

The process of pressing down the right key of mouse and then releasing is called “Right click” in this Manual. You can open a right click drop-down menu by right clicking an object, or open a right click menu by right clicking a blank space. In addition, you can also cancel screen editing status and recover the mouse shape.

☉ Drag

The process of moving the mouse while pressing the left key is called “Drag” in this Manual. It can be used to select several objects, move objects, or move pop-up editing windows.

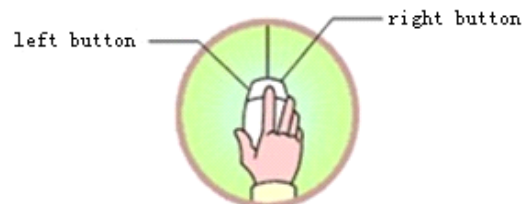

Figure 2-43: Sketch of mouse

2.8.2 Mouse shape

When using SKWorkshop software, the shape of the mouse may change with the operation to distinguish different operation types and provide convenience for users. Table 2-1 below shows the allowable operations of different mouse shapes.









	Choosing object, and left clicking tool button.
+	Pasting.
	Drawing a graph.
I	Inputting text.
	Enlarging object vertically.
	Enlarging object horizontally.
	Enlarging object both vertically and horizontally.
	Readjusting.
	Enlarging object both vertically and horizontally.
	Rotating object.

Table 2-1: Different mouse shapes and corresponding meanings

2.8.3 Shortcut keys

Table 2-2 below lists common shortcut keys. Designers can use these keys to quicken the configuration.

Ctrl + C	Copy
Ctrl + V	Paste
Ctrl + X	Cut
Ctrl + drag	Copy the chosen object and move it.
Shift + left click	Select several objects at the same time.
	Move the object chosen left, right, up and down.
Esc	Cancel the command.
Del	Delete

Table 2-2: Shortcut keys

2.8.4 Common terms of SKWorkshop

Table 2-3 below lists some frequently used terms in this Manual.

Project	Shortened name of user application system. Introduction of this concept is to make the complex computer technologies closer to common engineering users. Files generated by SKWorkshop are called project files, with an extension name of “*.shm”, and can be saved to a directory specified by the user.
Object	General designation of operation object and operation environment. For example, window, part, data, graph, and the like can be all referred to as object.
Choose an object	Choosing an object refers to the process of clicking a window or object to make it operable. The chosen object (including window) is also called current object.
Configuration	Configuration refers to the process of defining, preparing and editing objects in window environment and setting their status features (properties).
Properties	General designation of name, type, status, performance and use of objects.
Menu	Aggregate of commands for certain functions. For example, “File” menu consists of commands used to process project files. All menus of SKWorkshop are drop-down menus, and a drop-down menu can be divided into several levels, each level called a sub-menu.
Command button	A button corresponding to a command. Some command buttons are in tool bar and some are in menus.
Set ON	Switch the bit status of an object with bit status display to “ON” status.
Set OFF	Switch the bit status of an object with bit status display to “OFF” status.
Pattern	A kind of transition effect of object from foreground color to background color.
Address	A memory variable linked with the current object.
Connected device	A device communicating with the current project.
Control	Aggregate with certain special functions.

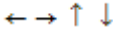
Table 2-3: Common terms

3. Basic steps of creating a project with SKWorkshop

3.1 Creating a new project with SKWorkshop

To create a new project, click the “New Project” command in File menu or the “ New Project” button in the tool bar, and then a pop-up dialog for new project creation will appear. Select a directory for project saving, and choose a name for the project. Choose the model of the touch screen corresponding to the project, click OK to complete the creation and enter the communication port setting dialog. Click “Cancel” to quit the dialog.

3.1.1 New project dialog with SKWorkshop

- Project name: The name of the project to be created.
- Path: Directory to save the new project file, C:\ in default.
- Model: Model of the touch screen used by the project. Available models include:

SK-035AE(320*240)
SK-040AE(320*240)
SK-043AE(480*272)
SK-050AS(480*272)
SK-050AE(480*272)
SK-057AS(640*480)
SK-057AE(640*480)
SK-057CS(320*240)
SK-057CE(320*240)
SK-057DS(640*480)
SK-057DE(640*480)
SK-057FS(320*240)
SK-057FE(320*240)
SK-070AS(800*480)
SK-070AE(800*480)
SK-072AS(800*600)
SK-072AE(800*600)
SK-080AS(800*600)
SK-080AE(800*600)
SK-102AS(800*480)
SK-102AE(800*480)
SK-104AS(800*600)
SK-104AE(800*600)
SK-121AS(800*600)
SK-121AE(800*600)

The default model is SK-070AS(800*480). Here the screen resolution (800*480) in the brackets is not displayed in the dialog.

- Show model: Display direction of the touch screen used by the project. Available models include:

Horizontal: Configuration with the touch screen being horizontal.

Vertical: Configuration with the touch screen being vertical.

The default model is horizontal.

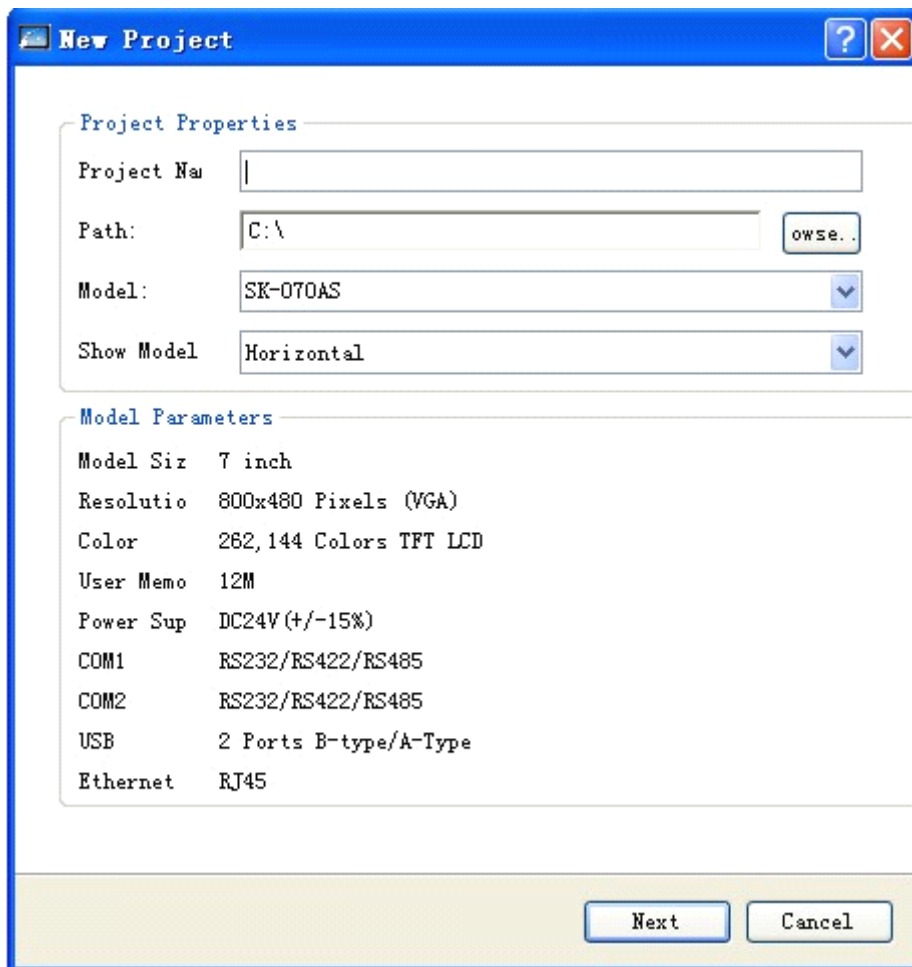

Figure 3-1: New project dialog

Figure 3-1 shows a New Project dialog. Please choose a project name, the path for project file saving, the model, and the show model, and then you can click Next to set the communication port.

The concrete model selection depends on the model of the touch screen actually used by the user.



A project name cannot include the following characters: \ / : * ? " < > |.

3.1.2 Communication port setting dialog

This dialog is used to set communication parameters of the communication port of the touch screen. Correct setting of communication parameters is vital for successful communication between the touch screen and PLC. The particular parameters depend on the model of the PLC to be connected.

Link name: Name of the communication port.

Link type: Communication manner.

Device/server: Model and brand of PLC, model of CPU.

Link port: Selecting a proper COM port.

PLC continuous address interval: Setting interval of PLC addresses. The default value is recommended.

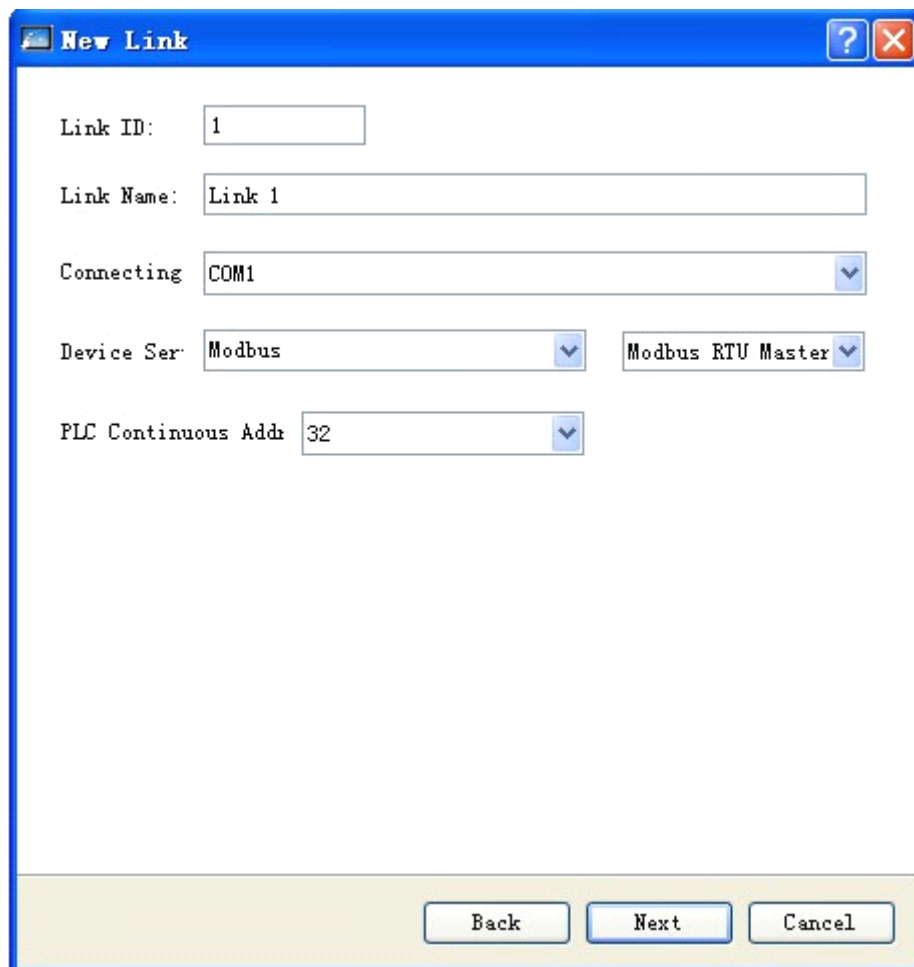

Figure 3-2: Communication setting dialog

Figure 3-2 shows a communication port setting dialog. Designers can choose appropriate options in this dialog basing on the actual conditions. To use Ethernet connection, choose “Direct Connection (Ethernet)” option in the “Connection Type”.



There are two COM ports in SK-5.7A, SK-5.7C, SK-5.7D, SK-5.7F, SK-7A, SK-7.2A, SK-8A, SK-10.2A, SK-10.4A, SK-12.1A. If only one PLC is connected, the parameter of COM port depends on the COM port actually used. SK-3.5A, SK-4A, SK-4.3A and SK-5A have only one COM port, so you can simply choose COM1.



The serial number of connection is an internal parameter that cannot be changed.



During configuration, you may also set communication properties in the project manager, and set other parameters in the communication properties.

3.1.3 Communication interface setting dialog

Click “Next” in Figure 3-2, and a New Screen dialog will pop up. In this dialog you can set name and background color. The default name of a new screen is the serial number of the screen, and the default background color is blue. When we create a

new screen for the first time, SKWorkshop software will allocate a serial number for the screen, indicating the ordinal number of the screen and starting from 1. For example, the serial number of the fifth screen is 5. Such serial number cannot be modified. To change the background color of the new screen, click the small black triangle on the right bottom corner, and then a color selection dialog will pop up. SKWorkshop provides abundant color options. Over 200 colors are provided in the color selection box for quick selection by the user. If you are not satisfied with any color in this box, you can define a color by yourself by clicking  on the right bottom. For the purpose of such definition, first choose a base color in the dialog, and then drag the mouse in the square color area in the middle. Then, you may also drag the mouse in the rectangular box on the right to finalize the color. At last, click “Add to self-defined colors” on the right bottom and then click “OK” to complete color definition. Alternatively, you may also enter the composition values of the three primary colors in the boxes above the “Add to self-defined colors” button to get a self-defined color. See Figure 3-3 and 3-4.

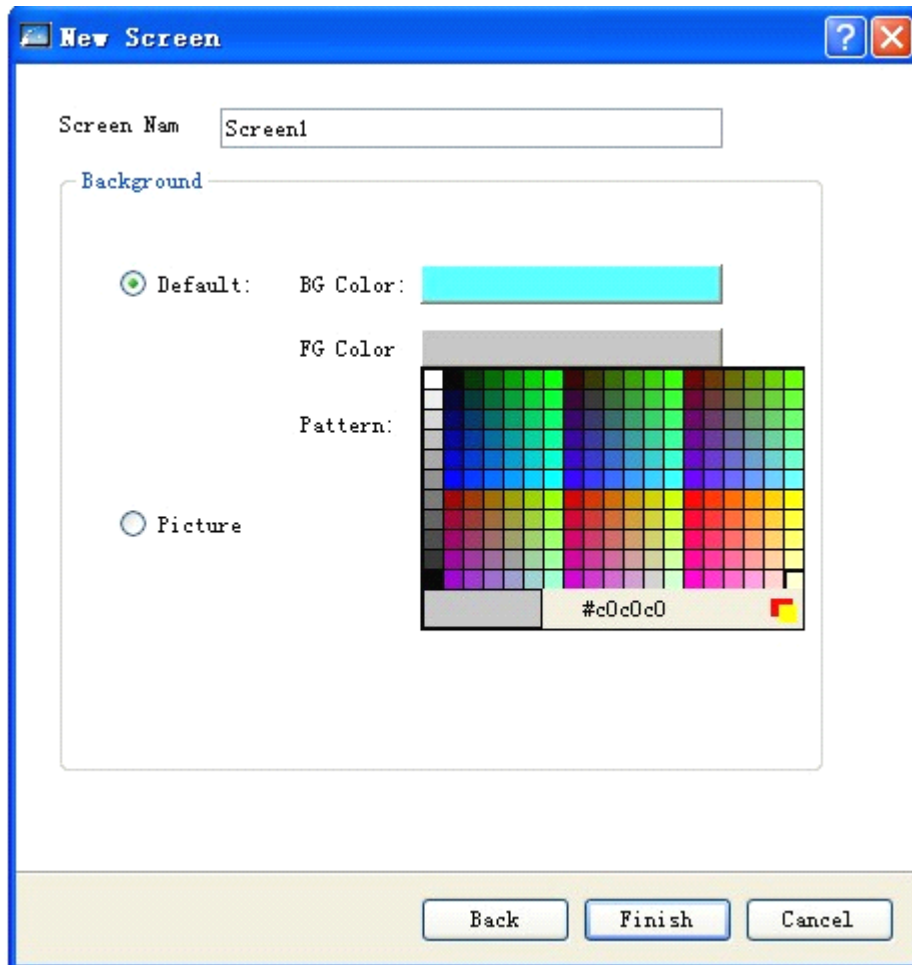

Figure 3-3: New screen dialog

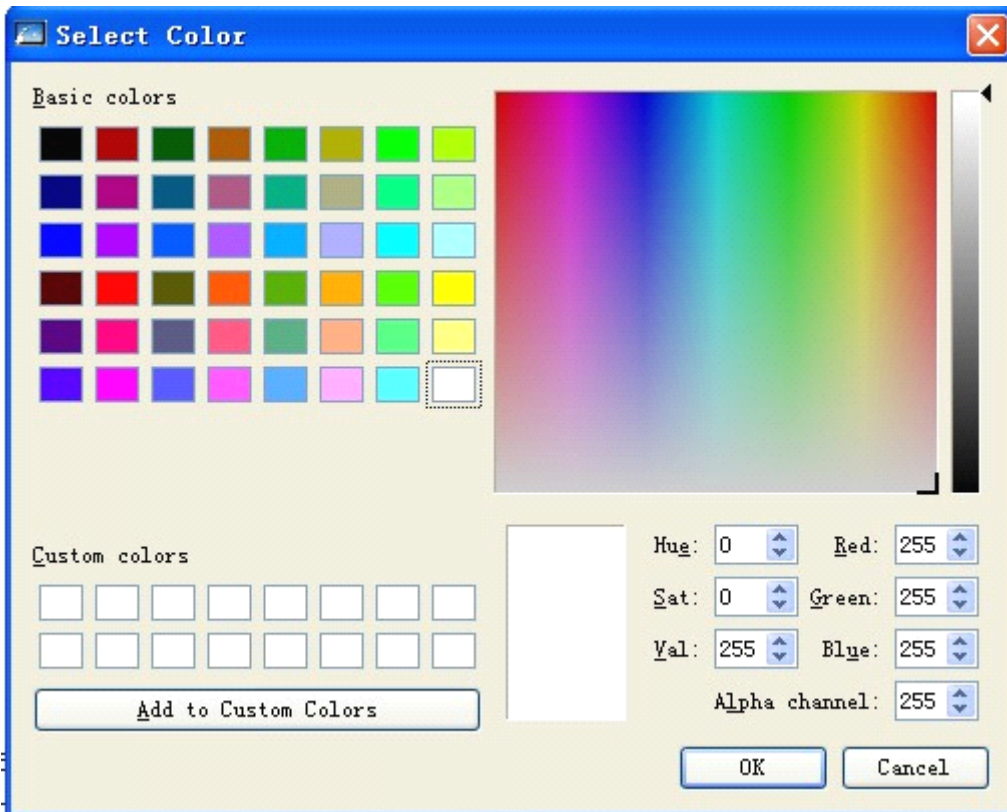

Figure 3-4: Color selection dialog

Then, click “OK”, and then the system will immediately open the screen you created just now. After that, the new screen creation is completed, and you can use SKWorkshop to configure your project screens.



Screen name cannot be led by space and numbers, and cannot contain other special symbols.

3.2 Setting parameters and adding graph objects with SKWorkshop

3.2.1 Setting parameters

In the Setting menu, you can choose to modify the settings, and you can also modify parameters by double clicking touch screen parameter setting in the Project Manager. The dialog as shown in Figure 3-5 will pop up:

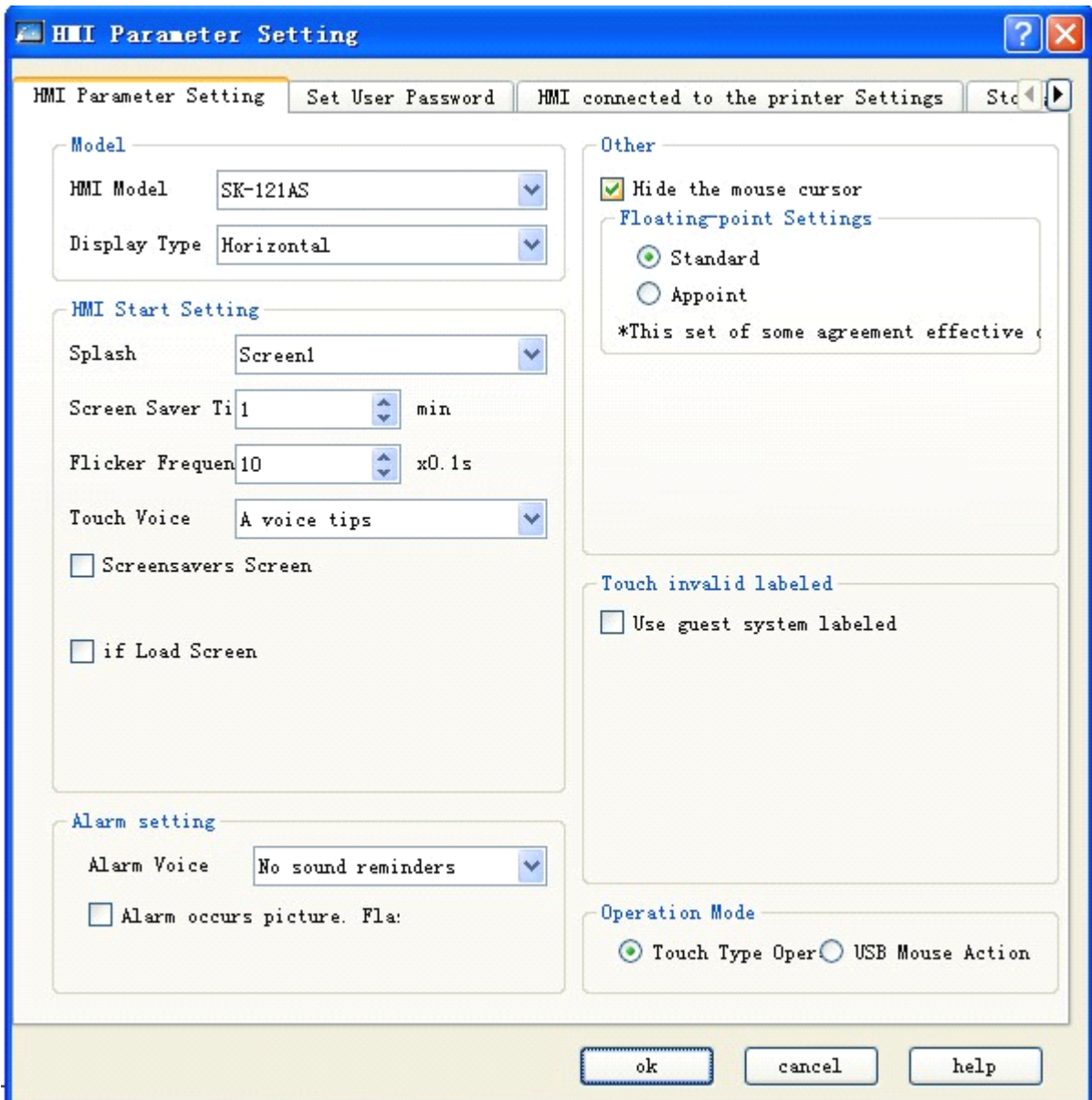

Figure 3-5: General parameter setting dialog

- Touch screen model: To change the model of the touch screen by changing this option.
- Display mode: To switch between horizontal or vertical display of the screen.
- Touch screen startup setting
 - ◆ Startup screen: The screen displayed when the touch screen is powered on.
 - ◆ Screen saver time: The time before starting up screen saver.
 - ◆ Flicker frequency: This parameter defines the frequency of the flicker of objects or controls with flicker option. You can set this parameter by directly inputting a value or by clicking the tuning button.
 - ◆ Alarm voice: With this parameter you can set alarm sound for the system. The options include “No voice prompt” and “Voice prompt”.

- ◆ Touch voice: You can set whether to have sound when the touch screen is touched.
 - ◆ Screen saver screen: If this box is checked, you can select a picture and set it to be the screen saver picture. After the screen saver picture appears, you can simply touch the screen to go back the original screen.
 - ◆ Load screen: If this box is checked, the selected loading picture will be displayed after power-up of the touch screen, and remain for set duration before the appearing of the start-up picture. This is to give some prompts or instructions to users.
- Other settings
- ◆ Hide mouse cursor: Whether to display the mouse or not.
 - ◆ Floating point number setting: [Standard]: higher bytes of the floating point number in front of the lower bytes; [Specified]: positions of higher and lower bytes to be set by user.
 - ◆ No data sign

Numerical value object: All controls with numerical value (such as numerical value display and numerical value input controls) under communication failure. [As it is]: Keep the displayed text contents as it is; [Clear]: Clear the text contents displayed in the control; [#] Present the displayed contents of this control with #; [?]:Present the displayed contents of this control with [?].

Character object: All controls with character (such as ASCII display and ASCII input controls) under communication failure. [As it is]: Keep the displayed text contents as it is; [Clear]: Clear the text contents displayed in the control; [?]:Present the displayed contents of this control with [?].
- Invalid touch sign: When “Use Sign” is chosen, that is a touchable control cannot be touched, a user-selected picture will be used to indicate that this control cannot be touched.

3.2.2 User password setting dialog

See Figure 3-6:

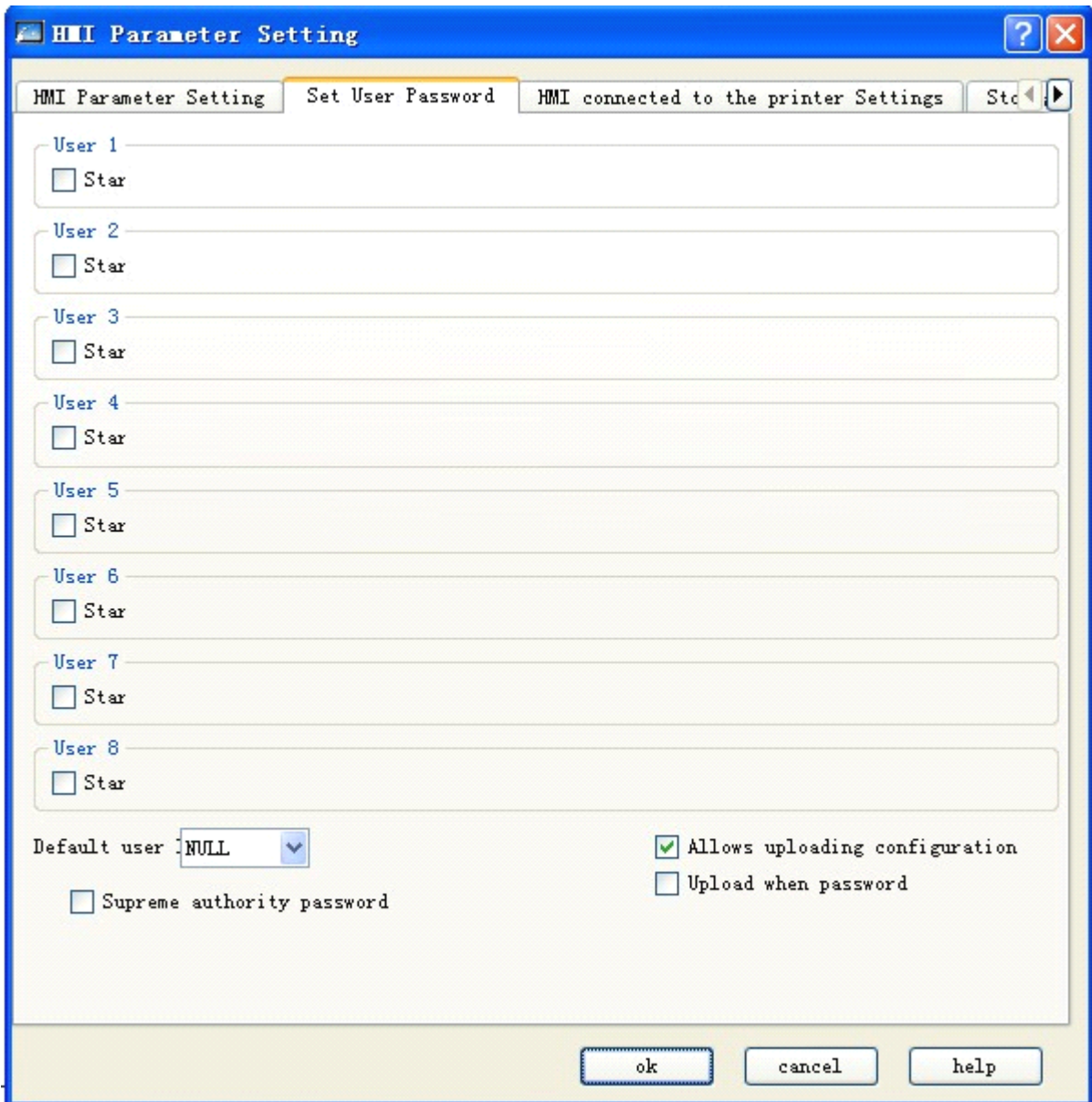

Figure 3-6: User password setting dialog

- In this dialog there are 8 user passwords, and for each user password there are 8 levels available for selection.
- Default user level: The current user level by default is NULL.
- Allow configuration uploading: If this option is chosen, you can upload the project from the HMI to the PC, otherwise such uploading is not allowed.
- Input password when uploading: Whether to enter password for uploading of the project.
- Highest privilege password: This password can be used to open all controls subject to level controlling.
- Enable uploading: You can use this password to upload the HMI configuration project to PC.
- Privilege operation: You can use this password to carry out all privilege based operations.

3.2.3 Connection with printer

Click “Connection with Printer” dialog, as shown in Figure 3-7.

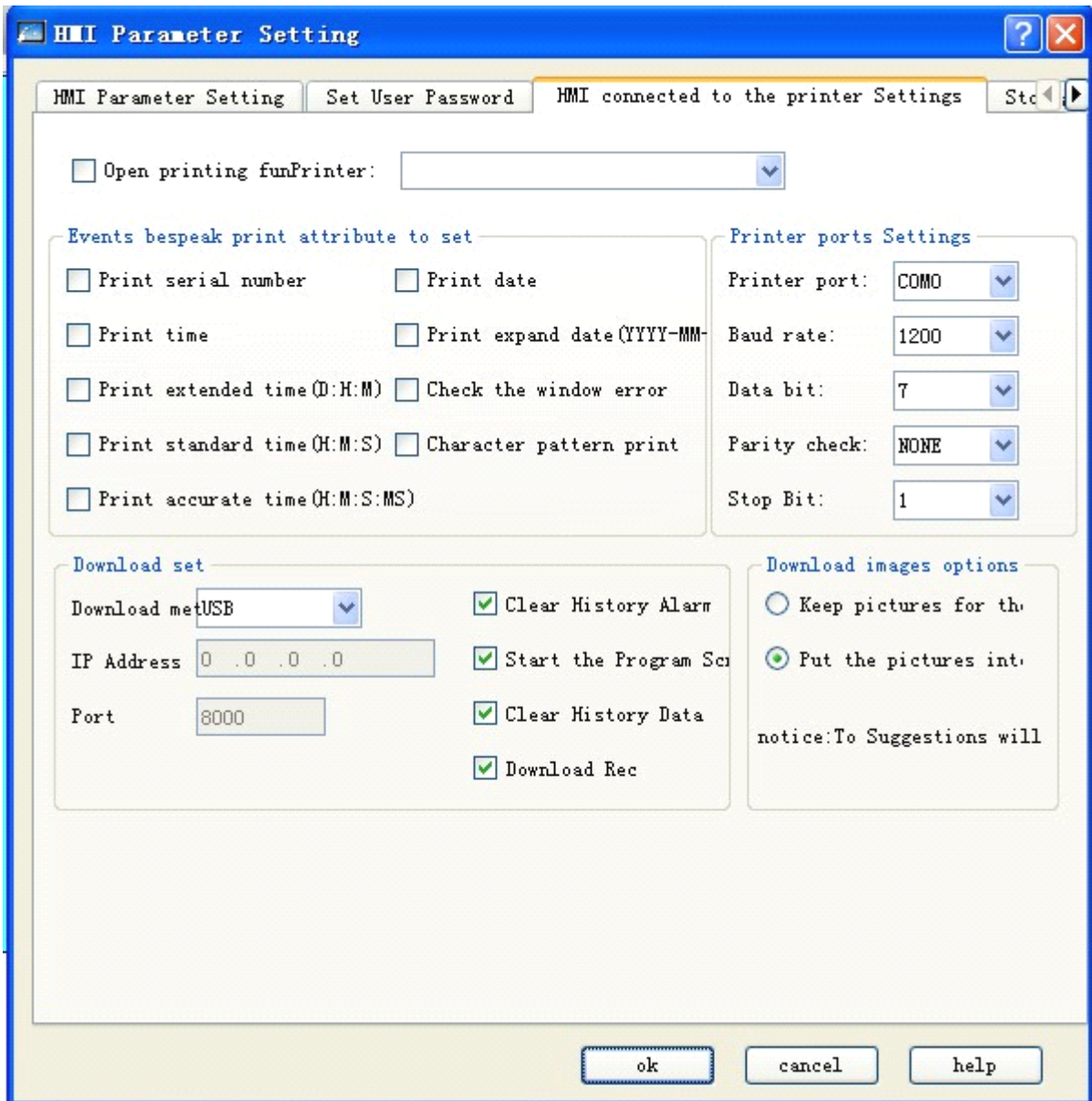

Figure 3-7: Connection with printer dialog

- This dialog contains some parameters for HMI connection with printer, and you can set these parameters basing on the printer type.
- Downloading setting

Downloading mode: You can choose to download through USB connection or Ethernet. If Ethernet is chosen, you need to set IP address and port number (IP address and port number of HMI).

Clear historical alarming record: Whether to clear the historical alarming information saved by HMI when downloading.

Start up program screen after downloading: Whether to enter the restart screen after completion of downloading.

Clear historical record: Whether to clear the historical data saved by the HMI when downloading.

Recipe downloading: Whether to download the recipe of the current project into the HMI.

➤ Picture downloading options:

Save picture to original format: If this option is chosen, the picture format chosen by the user when be kept at the time of downloading.

Convert to JPG: If this option is chosen, all pictures chosen by the user will be converted to JPG format before downloading to HMI.

(Note: As BMP pictures occupy more space, it is recommended to choose “Convert to JPG” option.)

3.2.4 Saving position and system alarming setting

Click “Saving position and system alarming” dialog, as shown in Figure 3-8

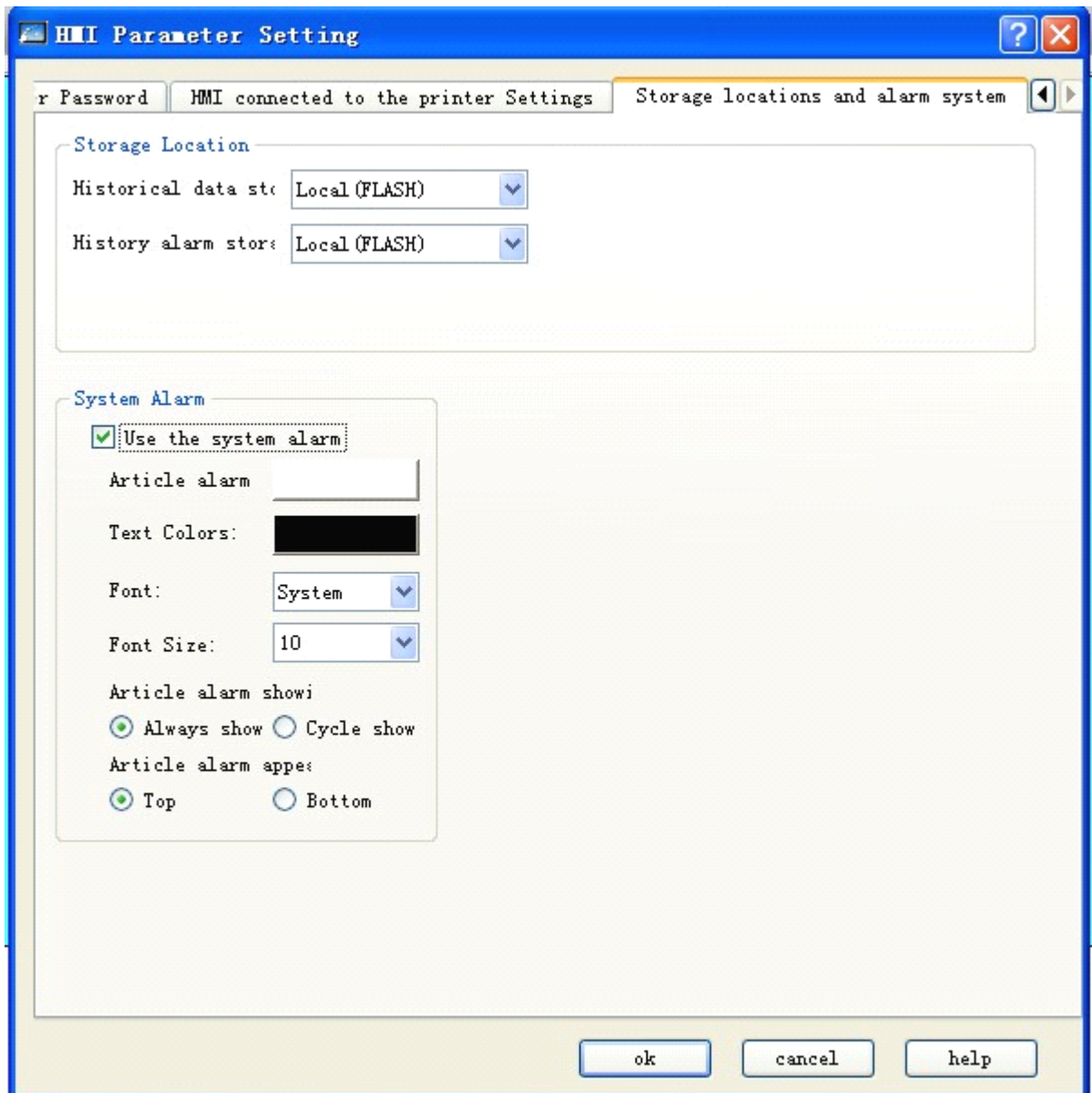

Figure 3-8: Saving position and system alarming setting dialog

- Saving position: The target directory where the historical data, historical alarms and screen shot pictures will be saved. Totally three options are provided, that is “Local (FLASH)”, “U-disk” and “SD card”, and you can choose a suitable option basing on actual needs. The default setting is “Local (FLASH)”.

- System alarming

Enable system alarming: Whether to use the system alarming function. If this option is chosen, whenever a system alarm appears an alarming message will be displayed on the top or bottom of each screen basing on user setting.

Alarming bar background color, text color, font and font size: These are used to define the display of the alarm. You can choose these options basing on actual needs.

Alarm bar display mode: “Always” means always display of the alarm; “Periodic” means periodic display and disappearing producing an effect of flashing.

Alarm bar position: The position where the alarm bar will appear.



The screen saver time is effective only if screen saver is enabled. After the screen saver picture appears, you can simply touch the screen to go back the original screen.

3.3 Downloading configuration project of SKWorkshop



After completion of compiling screen configuration, you need to click “ Save” button on the tool bar or use shortcut key Ctrl +S. Then, you can compile the configuration screen by clicking “ Compile” tool or “Compile” command in Download menu. During the compiling by the system, the compiling information will be displayed real time in the information output window. If there is an error in the screen configuration, the compiling cannot be completed. See Figure 3-9.



Figure 3-9: Prompt of compiling error

You can modify the configuration screen basing on the error prompt in the information output window, or double click the error to allow the software to find the error automatically. Then, you can double click the wrong object to view its property setting, find the source of the error and make corresponding modification. After modification, click Save button and execute Compile command again. If there is no error in the configuration, after executing the Compile command a dialog will appear to show successful compiling. Click OK to complete the compiling process. See Figure 3-10 and 3-11.

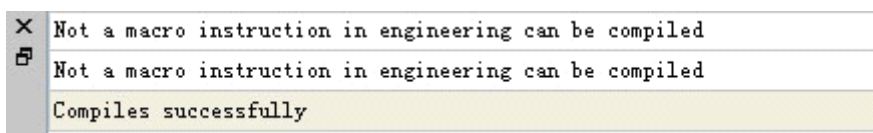

Figure 3-10: Information output window



Compiling is a necessary process before downloading. Do save the configuration before compiling, or the compiling process cannot be started. See Figure 3-11. If you change the screen configuration after compiling, you need to compile it again.

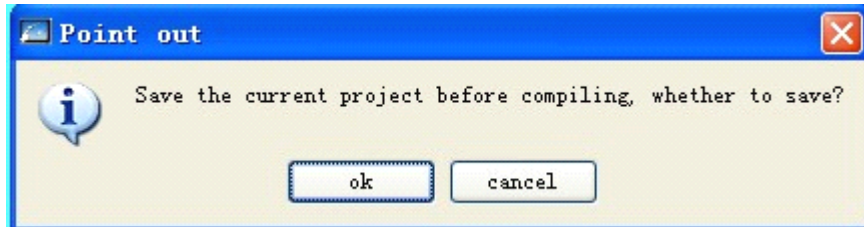

Figure 3-11: Compiling reminder

Finally, choose USB download command in the Download menu. Alternatively, you can also directly choose Compile + Download command in the Download menu to complete both compiling and downloading. After that, a dialog as shown in Figure 3-12 will pop up.

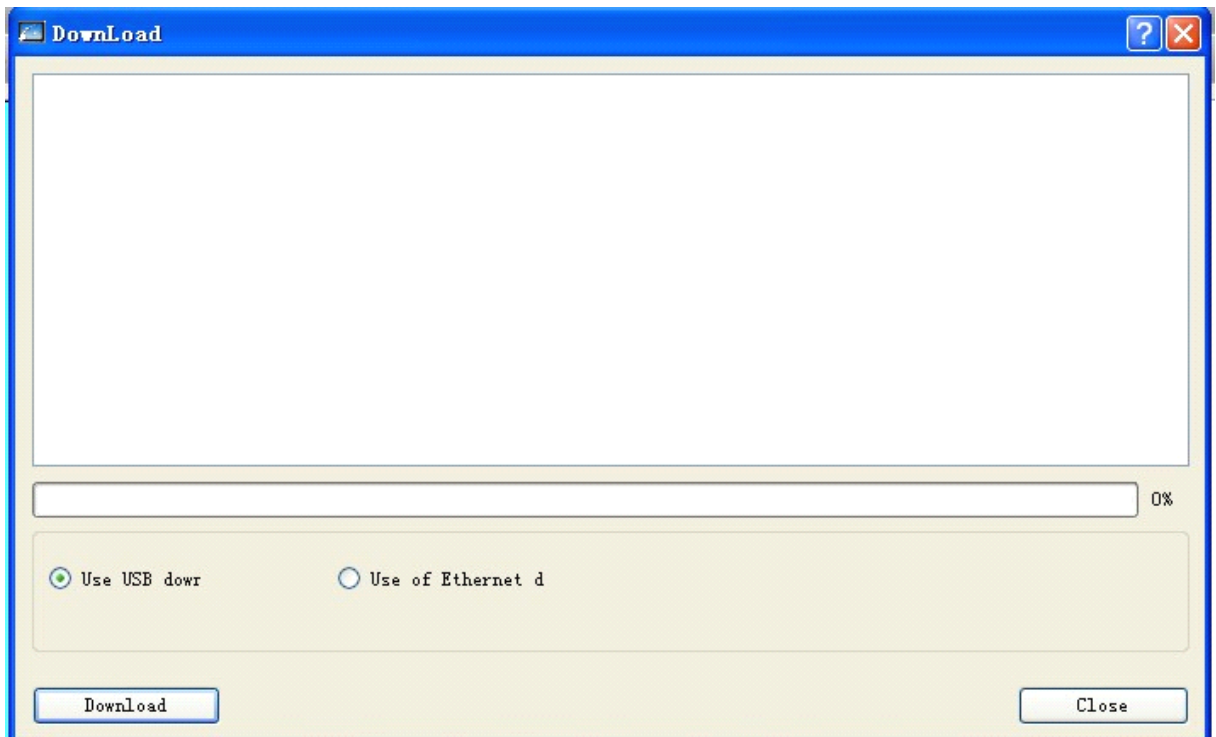

Figure 3-12: Download dialog

Click Download, then the progress bar in the middle will show the downloading progress. After completion of downloading, a window will pop up to prompt that the USB downloading has been completed. Click OK to complete the process. See Figure 3-13:

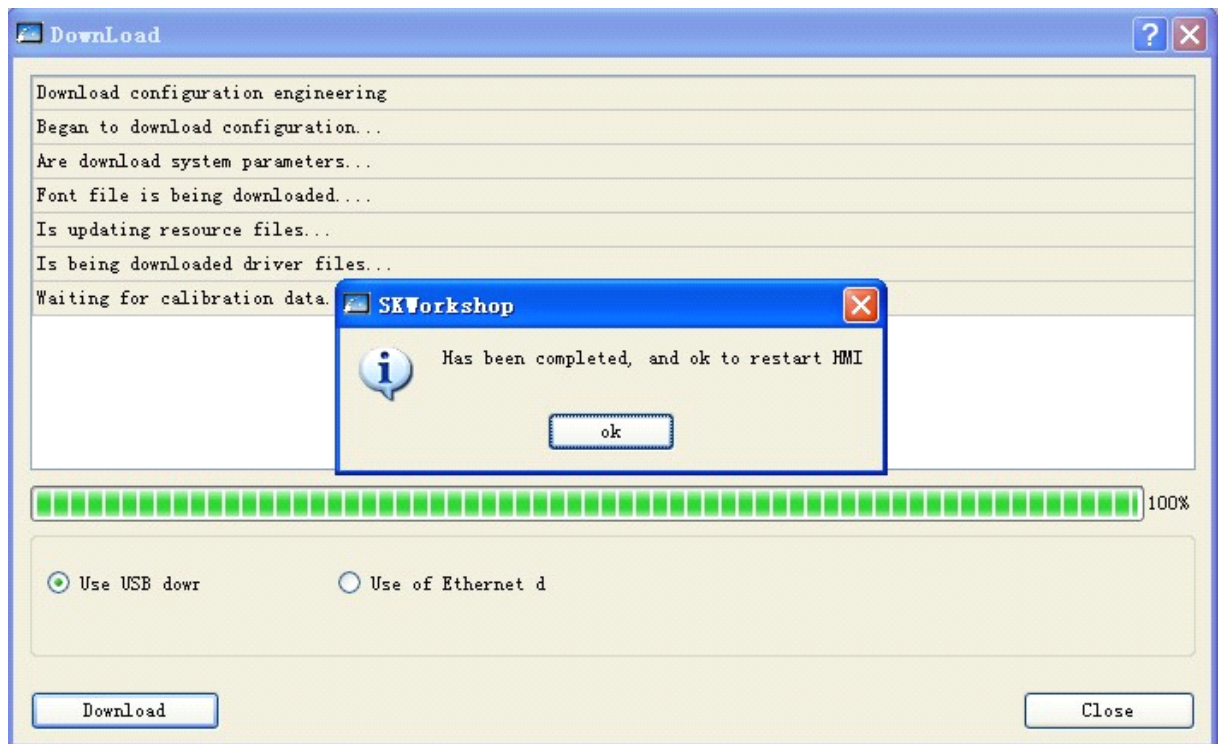

Figure 3-13: Downloading completed

Then, connect the touch screen with PLC, and observe in the touch screen whether the configuration results are correct. Refer to Wiring part for connection between PC/PLC and HMI.



Do not disconnect the power supply of the touch screen or PC or the data cable during data transfer, and do not carry out other operations, otherwise the data transfer may be adversely impacted.



Please install USB driver well before downloading, otherwise HMI cannot be connected with PC and thus the downloading cannot be completed.



Figure 3-14: USB driver prompt



If a dialog as shown in Figure 3-14 appears, it indicates that the PC cannot identify the touch screen. In this case, you can check whether the USB driver has been installed. Connect the PC with the touch screen, power on the touch screen, and search for a USB driver named Samkoon HMI Tech Corp in “My Computer” – “Properties” – “Hardware” – “Device Manager” – “General Serial Bus Controller” of Windows. See Figure 3-15. You may also try removing and plugging USB cable repeatedly to check whether the PC can identify the HMI.

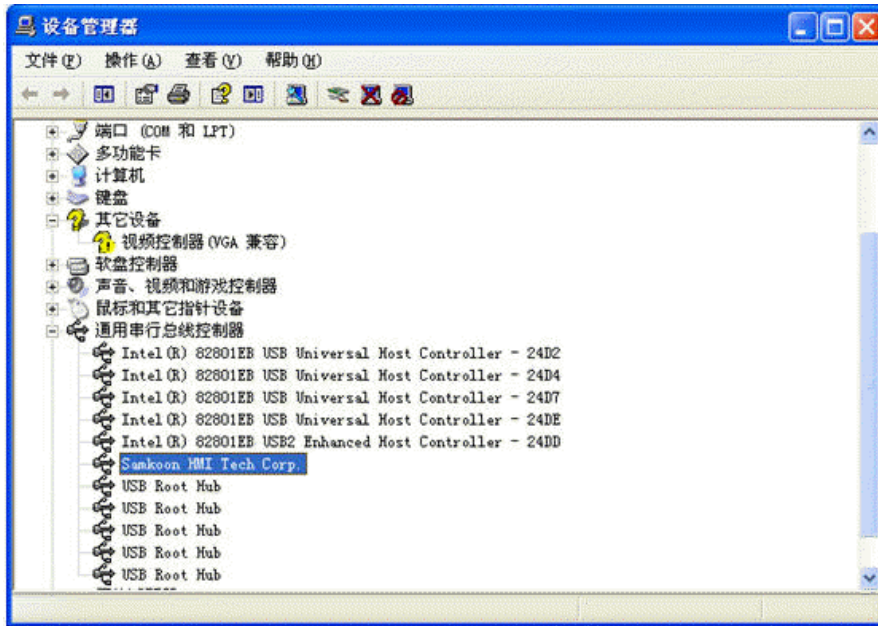
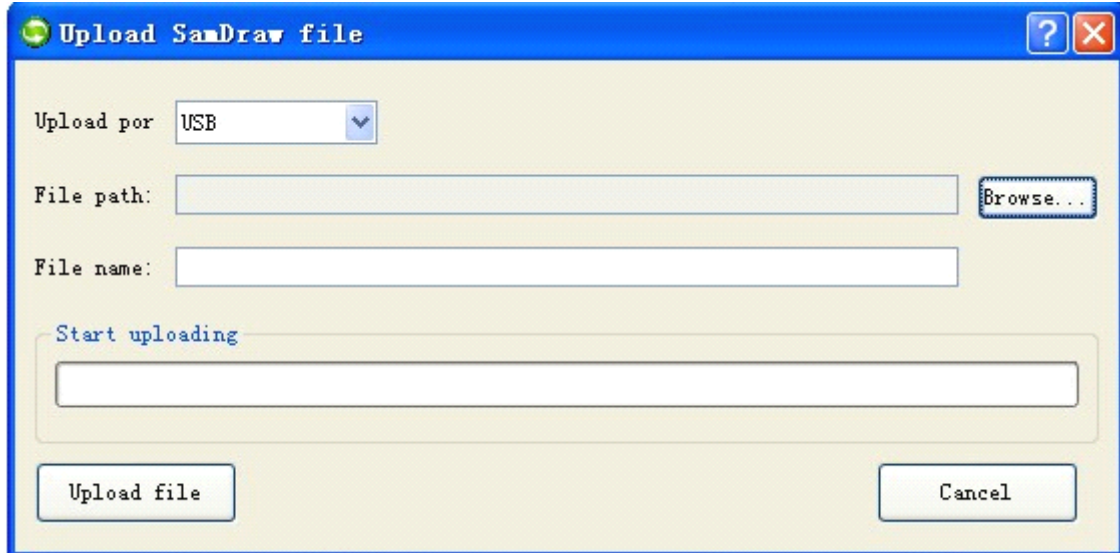

Figure 3-15: Searching for USB driver of the touch screen

3.4 Upload configuration program

SKWorkshop4.0 allows uploading of configuration from HMI to hard disk. To do this, connect HMI with PC, choose Upload option in Download menu, and then an uploading dialog will appear.



File path: Click Browse to choose the directory for file saving.

Project name: Enter the name of the project to be uploaded.

Upload: Click this button to start uploading.

After successful uploading, you may choose whether to open the project uploaded.

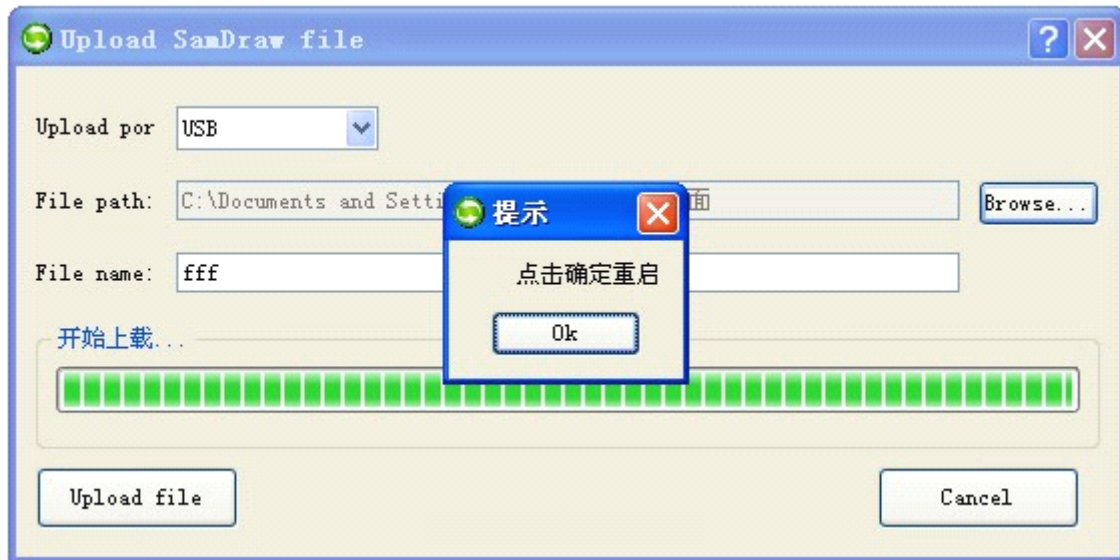

3.5 SKWorkshop converter



If any pictures, shapes or library graph is contained in the original V3.3 configuration project, after conversion these will be invalid in the new V4.0.0 configuration.

SKWorkshop4.0.0 has a remarkable functional improvement compared with SamDraw3.3, and project files generated by SamDraw3.3 cannot be directly opened using SKWorkshop. Thus conversion is required. SKWorkshop provides a tool to convert V3.3 project files to V4.0.0 ones that is the Converter.

Start up SKWorkshop, click  to start up the Converter or start up it from “Start” – “Programs” – “SKWorkshop” – “Convert 3.3 projects”.

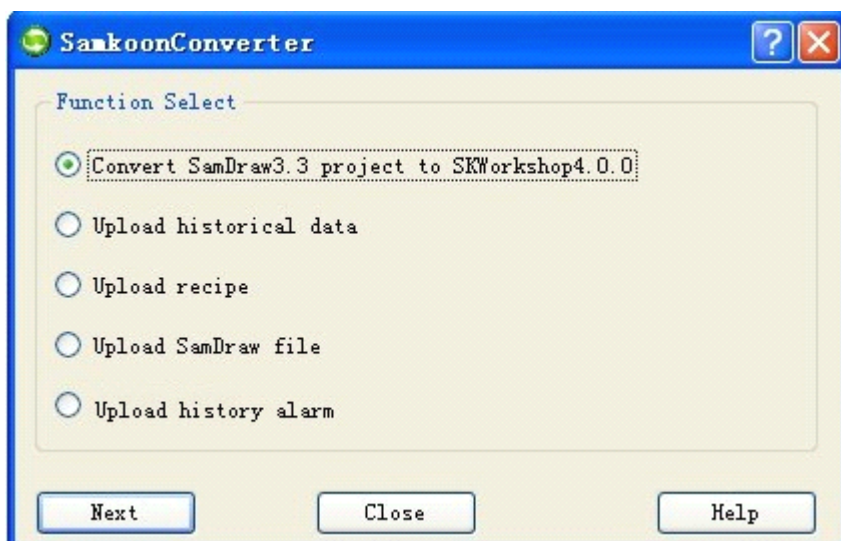

3.5.1 Choose “Convert SamDraw3.3 to SKWorkshop”

To convert V3.3 configuration files to V4.0.0 ones.

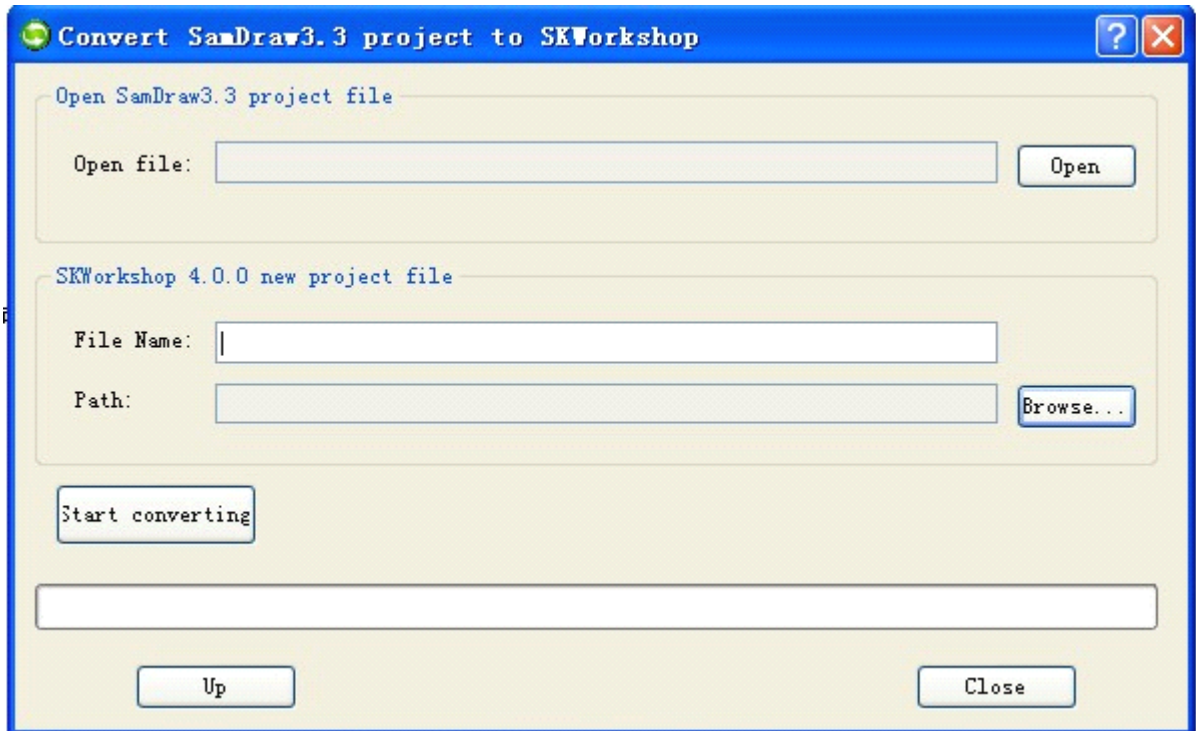

Choose “Convert SamDraw3.3 to SKWorkshop” to enter the conversion page. Click Open to choose a V3.3 project file to be converted, and type in the name of the target V4.0.0 project file. Then, click Browse to set the path for saving of the V4.0.0 project file. Then, click “Begin to convert”, and after conversion completion click “Close”. Then you can find the converted file from the stored path.



If a V3.3 configuration project is directly opened using SKWorkshop, the system will prompt whether to convert it to V4.0.0, and if you choose yes, the project will be converted to V4.0.0 and then opened.

3.5.2 Choose “Upload historical data”

To upload the historical data from HMI to hard disk.

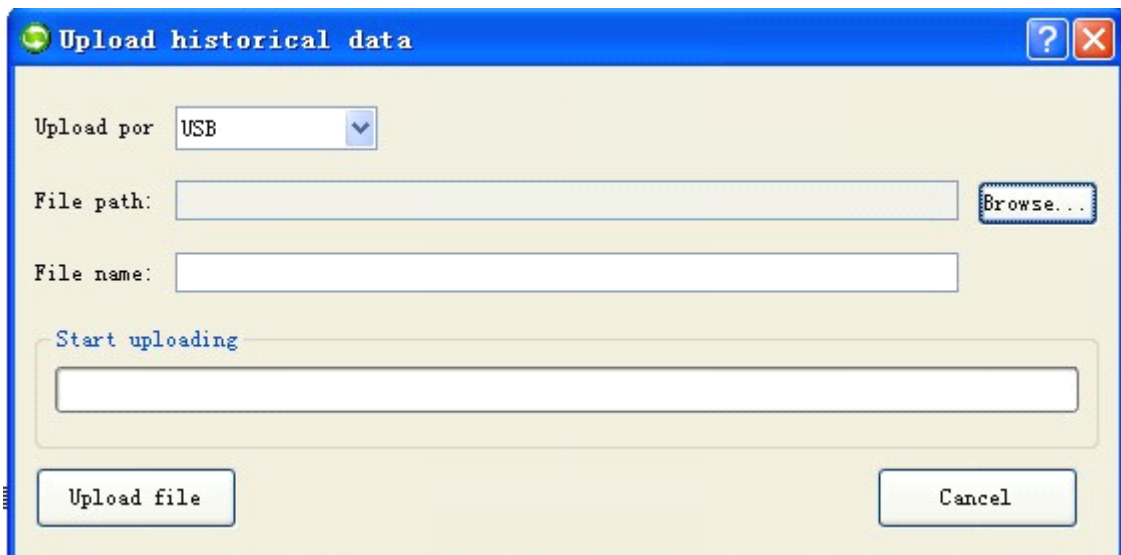

Stored path: Click Browse to choose the path where the uploaded file will be saved.

File name: Set a name for the uploaded file. The uploaded file is in the format of CSV that is comma separator file, which can be opened and edited with Excel.

Click OK to start uploading. The file will be saved to the set path.



The operations of choosing uploading recipe and uploading configuration are the same as that of uploading historical data.

4. Guide on configuration with SKWorkshop

This chapter introduces in detail the configuration methods using SKWorkshop software.

4.1 Screen operation with SKWorkshop

4.1.1 New screen with SKWorkshop

“New Screen” command is used to create a new screen in the current project. The steps to create a new screen are so simple that even beginners can complete easily. These steps are as follows:

1. Choose “New Screen” command in the Screen menu, or click  in the tool bar, or right click the Screen in the Project Manager and then click “Add Screen” in the right click menu. See Figure 4-1.

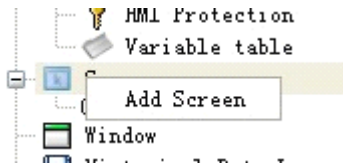

Figure 4-1: Screen option

2. In the “New Screen” pop-up dialog, set the name and background color of the screen to be created, and then click OK. The default name of a new screen is the serial number of the screen, and the default background color is blue. See Figure 4-2.

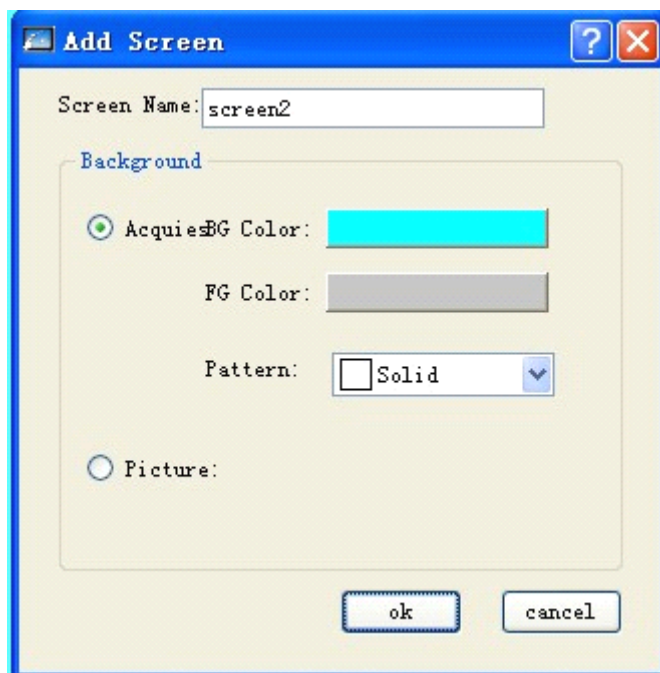

Figure 4-2 New screen dialog

- Background color, foreground color and pattern can be set for the new screen.
- Picture: Picture can be used as the background of the new screen.



Screen name cannot be led by space and numbers, and cannot contain other special symbols.

4.1.2 Modify screen properties with SKWorkshop

To modify properties of a screen, follow the steps below to have a “Screen Properties” dialog pop up. In this dialog screen name and background color can be modified. The steps are as follows:

If no object or control is chosen (click a blank area in the current screen), click  command in the tool bar, or click the screen to be modified in the Screen option in the Project Manager and right click it to call the right click menu and then click Properties option. Besides, you can also move the mouse to a blank space in the screen and right click the mouse to call the right click menu, and choose Properties option in the menu. After that, a dialog as shown in Figure 4-3 will appear.

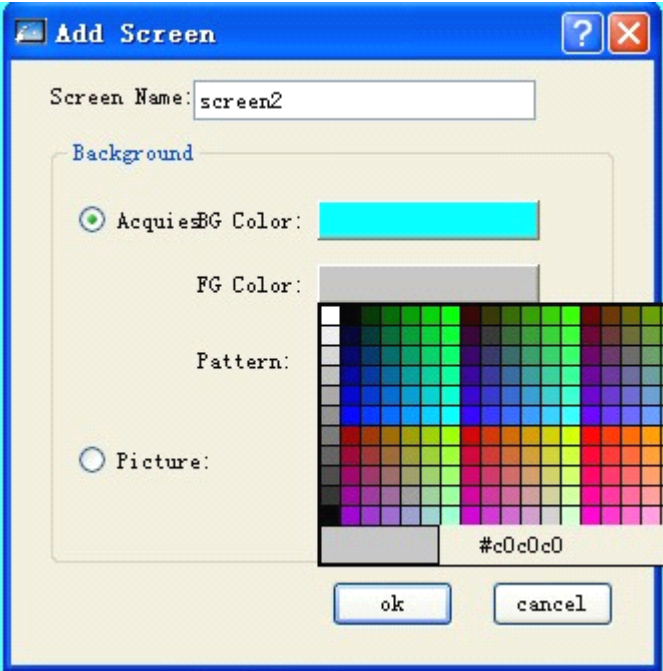

Figure 4-3: Screen properties dialog

4.1.3 Delete screen with SKWorkshop

“Delete Screen” command is used to delete a screen in the current project. The steps are as follows:

Choose “Delete Screen” in Screen menu, or click the screen to be deleted in the Screen option in the Project Manager and right click it to call the right click menu and then click Delete option. Besides, you can also move the mouse to a blank space in the screen and right click the mouse to call the right click menu, and choose Delete option in the menu. After that, a dialog as shown in Figure 4-4 will appear.



Figure 4-4: Screen deletion confirmation

Click OK to complete the deletion operation.



: Deleted screen can never be recovered! Thus, be careful to execute this command.

4.1.4 Copy screen with SKWorkshop

“Copy Screen” command is used to copy the screen in the current project. The steps are as follows:

Click the screen to be copied in Screen options in the Project Manager, right click it to call the right click menu, and then choose Copy option in the menu. Then, a dialog as shown in Figure 4-5 will appear. Input the name in this dialog and click OK to complete copying. You can click Cancel to cancel the copy operation.

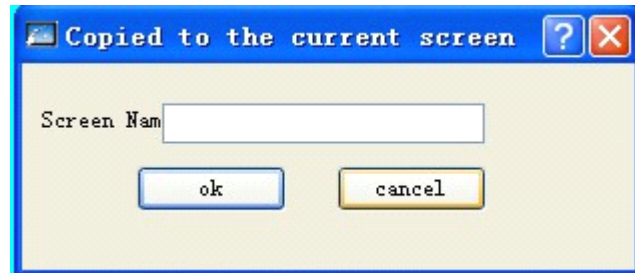



Figure 4-5: Copy screen

4.2 Graph editing commands of SKWorkshop

4.2.1 Assemble and disassemble of SKWorkshop

“Assemble” command is a group command, used to assemble two or more graph objects in the current screen to a whole graph object. The objects to be assembled may be graphs drawn by designers or users, or graphs from picture library of the system, or other controls such as alarm control and trend chart. After assembling the original properties of the graph elements will not be kept. An assembled object, graph or control is a whole image and can be saved as library control for future use, helping to save much time of the users. “Disassemble” command is used to disassemble a graph assembled using “Assemble” command to the original elements. After disassembling the original properties of the elements can be recovered. “Disassemble” command is a reverse command of “Assemble” command.

The assembling steps are as follows:

- First, choose the graph objects to be assembled, then press “Assemble” command in the Edit menu, or  button in the tool bar, or call the right click menu and choose Assemble command in the Assemble option. Figure 4-6 shows the contrast before and after assembling.

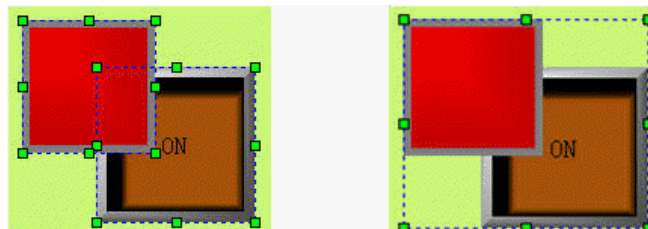



Figure 4-6: Contrast before and after assembling

The disassembling steps are as follows:

- Choose a graph object assembled using Assemble command, and then choose Disassemble command in the Edit menu or

Disassemble command  in the tool button, or call the right click menu and choose Disassemble command in the Assemble option. Figure 4-7 shows the contrast before and after disassembling.

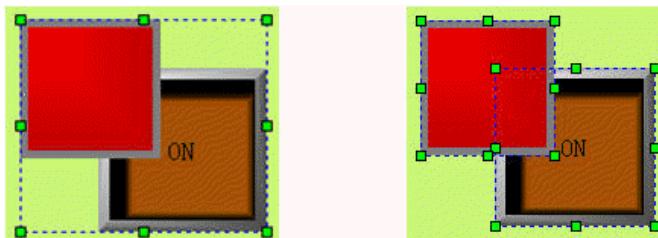

Figure 4-7: Contrast before and after disassembling



Several objects can be selected using Shift key.



Before assembling, please consider whether the elements to be assembled still need touch or monitoring after assembling, as the assembled object is a whole object and the elements can be no longer touched or monitored.

4.2.2 Layer of SKWorkshop

“Layer” command is a group command, used to adjust the display sequence of intersected graph objects in the screen. Each graph in SKWorkshop has a layer, and graph objects on upper layer are always displayed on top of the objects on lower layer. Thus, we can use this command to adjust layer level of graph objects. By default, objects created later are on upper layer than those created earlier. There are four Layer commands that are “Move object forward”, “Move object backward”, “Move object one layer forward”, and “Move object one layer backward”. To execute these commands, first choose one or more graph objects in the current screen, and then choose corresponding Layer commands in Edit menu or the tool button.

Move object forward

This command is used to move the chosen object to the top layer of all the graph objects in the current screen. Thus, the parts of other graphs intersected with this graph will be covered by this graph. Figure 4-7 shows a contrast before and after such moving.

First choose an object in several graphs, and then choose Move to Top command in Edit menu, or command button  in the toolbar buttons, or call the right click menu and choose Move to Top command in the Layer option. See Figure 4-8 for a comparison before and after combination.

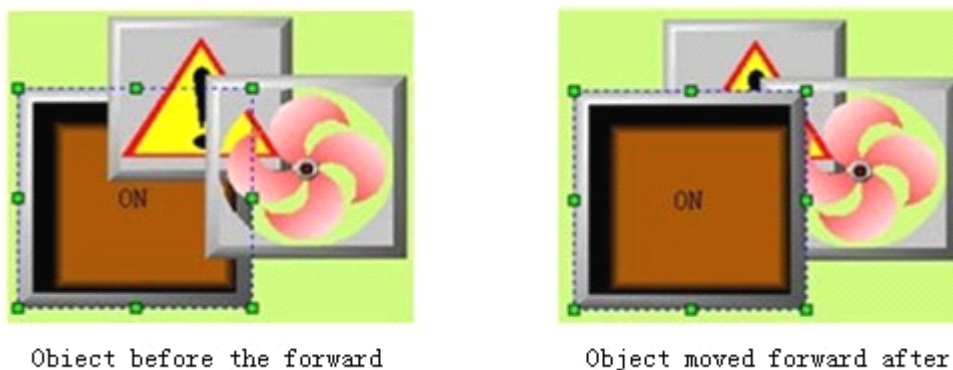



Figure 4-8: Contrast before and after moving object forward

Move object backward

This command is used to move the chosen object to the bottom layer of all the graph objects in the current screen. Thus, the part of this graph intersected with other graphs will be covered by other graphs. Figure 4-8 shows a contrast before and after such moving:

First choose an object in several graphs, and then choose Move to Bottom command in Edit menu, or command button  in the toolbar buttons, or call the right click menu and choose Move to Bottom command in the Layer option. See Figure 4-9 for a comparison before and after combination.

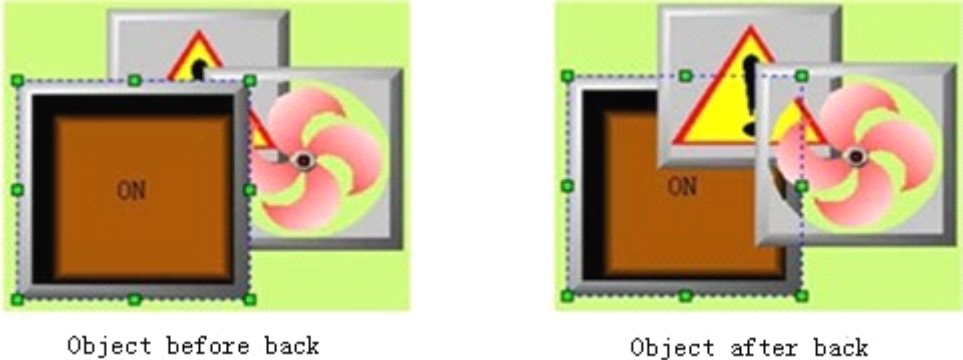



Figure 4-9: Contrast before and after moving object backward

Move object one layer forward

This command is used to move the chosen object to an upper layer over the graph object intersected with it. Thus, the parts of other graphs intersected with this graph will be covered by this graph. Figure 4-9 shows a contrast before and after such moving.

First choose an object in several graphs, and then choose Move to Upper Layer command in Edit menu, or command button  in the toolbar buttons, or call the right click menu and choose Move to Upper Layer command in the Layer option. See Figure 4-10 for a comparison before and after combination.

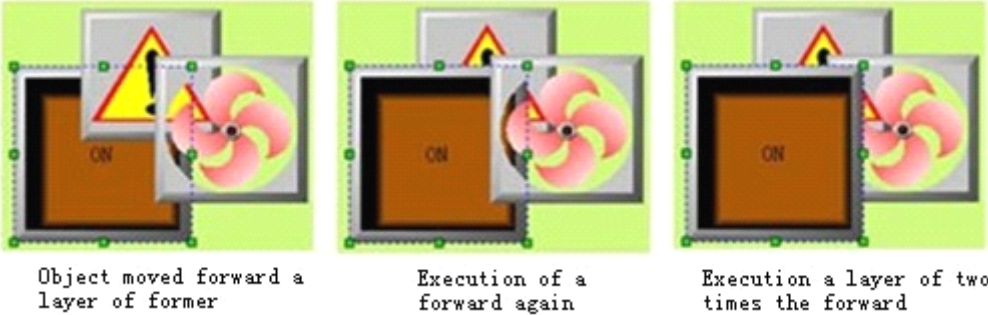



Figure 4-10: Contrast before and after moving object one layer forward

Move object one layer backward

This command is used to move the chosen object to a lower layer than the graph object intersected with it. Thus, the part of this graph intersected with other graphs will be covered by other graphs. Figure 4-10 shows a contrast before and after such moving.

First choose an object in several graphs, and then choose Move to Lower Layer command in Edit menu, or command button  in the toolbar buttons, or call the right click menu and choose Move to Lower Layer command in the Layer option. See Figure 4-11 for a comparison before and after combination.

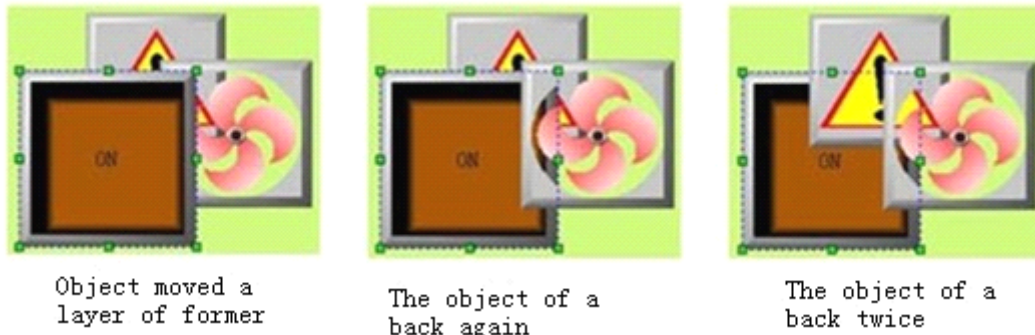



Figure 4-11: Contrast before and after moving object one layer backward

4.2.3 Rotary of SKWorkshop

“Rotary” command is a group command, allowing designer to rotate one or more graph objects by any angle. There are many rotatable graph objects, such as line, circle, rectangle, and graphs in the picture library of the system, controls, assembled graphs, and polygons.

➤ Horizontal overturning

Horizontal rotation allows designers to overturn a chosen graph object (or several graph objects) by 180° around a vertical center line. Use of the horizontal overturning command is simple. First, choose one or more graph objects, then click Horizontal Overturn command in Rotary option in Edit menu, or click horizontal overturn button  in the tool buttons, or call the right click menu and click Horizontal Overturn command in Rotary option in the right click menu.

See Figure 4-12 for horizontal overturning of single graph object.

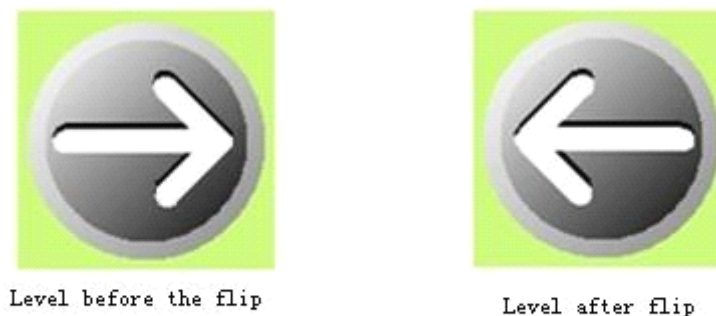

Figure 4-12: Contrast before and after horizontal overturning of single graph object

See Figure 4-13 for horizontal overturning of multiple graph objects:

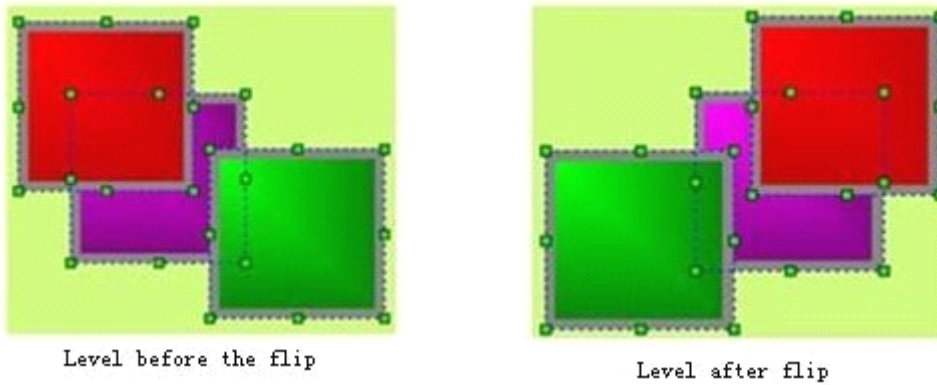



Figure 4-13: Contrast before and after horizontal overturning of several graph objects

➤ Vertical overturning

Vertical rotation allows designers to overturn a chosen graph object (or several graph objects) by 180° around a horizontal center line. Use of the vertical overturning command is simple. First, choose one or more graph objects, then click Vertical Overturn command in Rotary option in Edit menu, or click vertical overturn button  in the tool buttons, or call the right click menu and click Vertical Overturn command in Rotary option in the right click menu.

See Figure 4-14 for vertical overturning of single graph object:

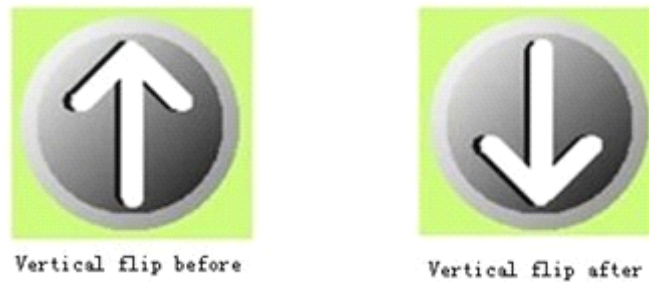

Figure 4-14: Contrast before and after vertical overturning of single graph object

See Figure 4-15 for vertical overturning of multiple graph objects.

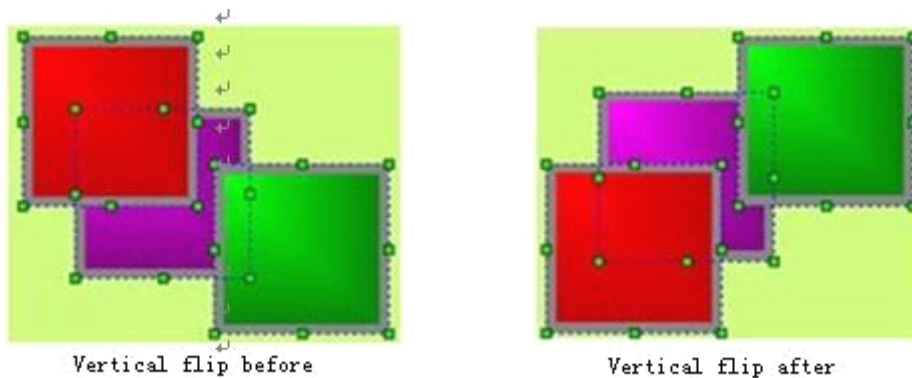



Figure 4-15: Contrast before and after vertical overturning of several graph objects

4.2.4 Align of SKWorkshop

“Align” is also a group commands, allowing designers to align several graph objects. This command can be used only when several graph objects are chosen. To select several graph objects, you may click the objects while press Shift key, or press the left key of the mouse and drag the mouse. This command can make the configuration screen more beautiful. This group command includes several commands that are Top Align, Bottom Align, Vertical Centering, Left Align, Right Align, Horizontal Centering, The Same Width, The Same Height, and The Same Height and Width.

➤ Top Align

“Top Align” command allows designers to align several graph objects chosen basing on the top boundaries of the graphs. To do this, first select several graph objects (2 or more), and then click Top Align command in Align option in Edit menu, or click Top Align button  in the tool buttons, or call the right click menu and click Top Align command in the Align option in the right click menu. Then the graphs will move upward to align basing on the top boundaries. See Figure 4-16 for a contrast before and after top align.

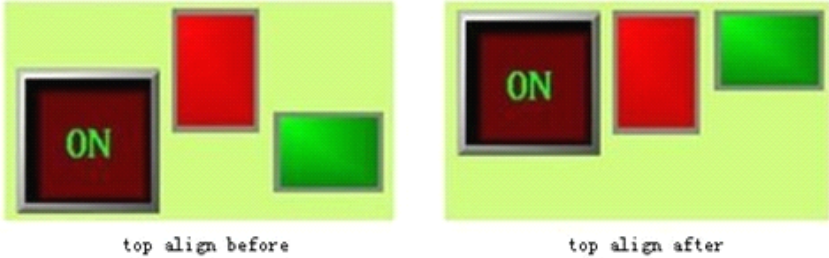



Figure 4-16: Contrast before and after top align

➤ Bottom Align

“Bottom Align” command allows designers to align several graph objects chosen basing on the bottom boundaries of the graphs. To do this, first select several graph objects (2 or more), and then click Bottom Align command in Align option in Edit menu, or click Bottom Align button  in the tool buttons, or call the right click menu and click Bottom Align command in the Align option in the right click menu. Then the graphs will move downward to align basing on the bottom boundaries. See Figure 4-17 for a contrast before and after bottom align.

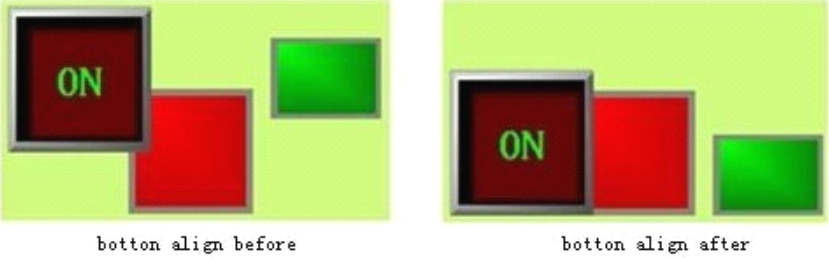



Figure 4-17: Contrast before and after bottom align

➤ Vertical Centering

“Vertical Centering” command allows designers to center several graph objects chosen basing on the same vertical line that is the vertical center line of the range from the left boundary to the right boundary of the graph objects. To do this, first select several graph objects (2 or more), and then click Vertical Centering command in Align option in Edit menu, or click Vertical Centering button  in the tool buttons, or call the right click menu and click Vertical Centering command in the Align option in the right click menu. See Figure 4-18 for a contrast before and after vertical centering.

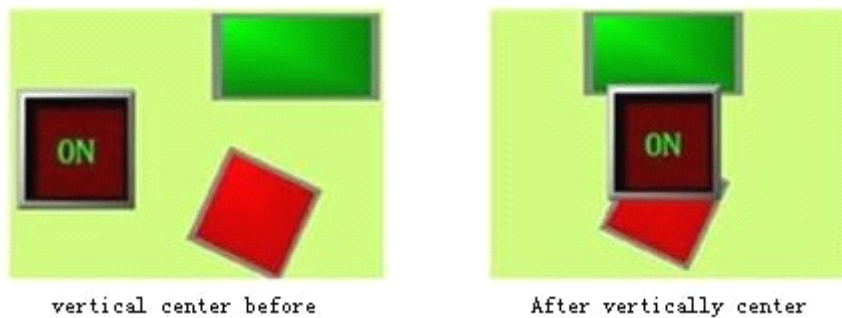



Figure 4-18: Contrast before and after vertical centering

➤ Left Align

“Left Align” command allows designers to align several graph objects chosen basing on the left boundaries of the graphs. To do this, first select several graph objects (2 or more), and then click Left Align command in Align option in Edit menu, or click Left Align button  in the tool buttons, or call the right click menu and click Left Align command in the Align option in the right click menu. Then the graphs will move left to align basing on the left boundaries. See Figure 4-19 for a contrast before and after left align.

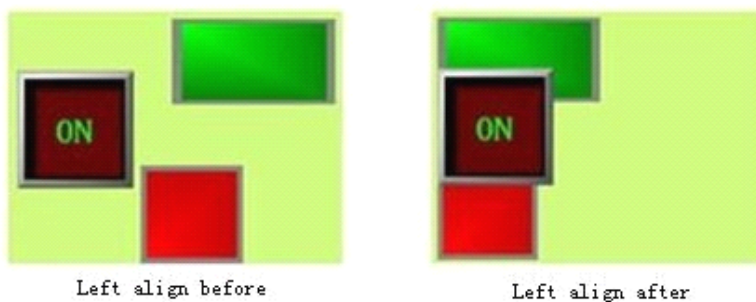



Figure 4-19: Contrast before and after left align

➤ Right Align

“Right Align” command allows designers to align several graph objects chosen basing on the right boundaries of the graphs. To do this, first select several graph objects (2 or more), and then click Right Align command in Align option in Edit menu, or click Right Align button  in the tool buttons, or call the right click menu and click Right Align command in the Align option in the right click menu. Then the graphs will move right to align basing on the right boundaries. See Figure 4-20 for a contrast before and after right align.

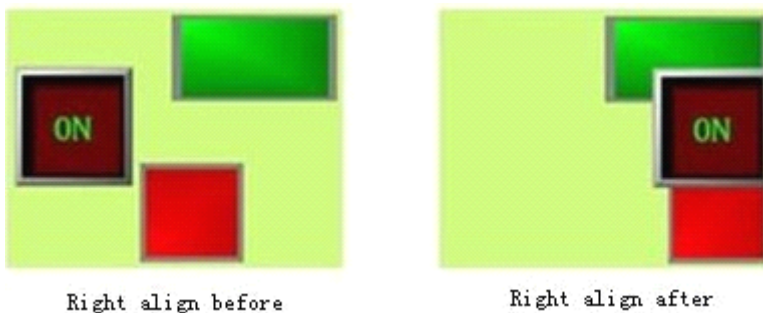



Figure 4-20: Contrast before and after right align

➤ The Same Width

“The Same Width” command allows designers to set the same width for several graph objects chosen basing on the width of the highest graph object (considering the top boundaries), without changing the heights of the graph objects and with the top left coordinates of the graph objects being fixed. To do this, first select several graph objects (2 or more), and then click The Same Width command in Align option in Edit menu, or click The Same Width button  in the tool buttons, or call the right click menu and click The Same Width command in the Align option in the right click menu. See Figure 4-21 for a contrast before and after such processing.

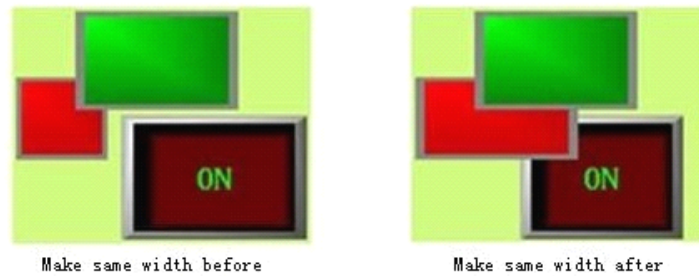



Figure 4-21: Contrast before and after “The Same Width”

➤ The Same Height

“The Same Height” command allows designers to set the same height for several graph objects chosen basing on the height of the highest graph object (considering the top boundaries), without changing the widths of the graph objects and with the top left coordinates of the graph objects being fixed. To do this, first select several graph objects (2 or more), and then click The Same Height command in Align option in Edit menu, or click The Same Height button  in the tool buttons, or call the right click menu and click The Same Height command in the Align option in the right click menu. See Figure 4-22 for a contrast before and after such processing.

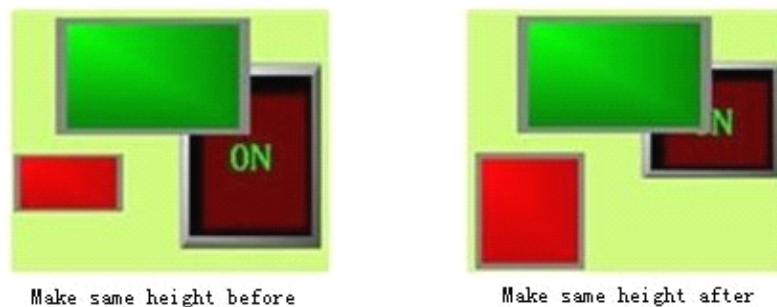



Figure 4-22: Contrast before and after “The Same Height”

➤ The Same Height and Width

“The Same Height and Width” command allows designers to set the same height and width for several graph objects chosen basing on the height and width of the highest graph object (considering the top boundaries), with the top left coordinates of the graph objects being fixed. To do this, first select several graph objects (2 or more), and then click The Same Height and Width command in Align option in Edit menu, or click The Same Height and Width button  in the tool buttons, or call the right click menu and click The Same Height and Width command in the Align option in the right click menu. See Figure 4-23 for a contrast before and after such processing.

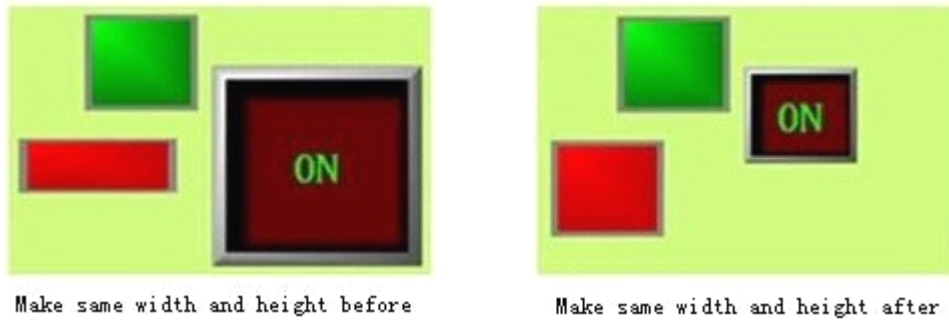



Figure 4-23: Contrast before and after “The Same Height and Width”

➤ Equal horizontal space

First choose several (two or more) graph objects, and then click the Equal Horizontal Space command in Align option in Edit menu, or command button  in the toolbar buttons, or call the right click menu and choose the Equal Horizontal Space command in Align option.

➤ Equal vertical space

First choose several (two or more) graph objects, and then click the Equal Vertical Space command in Align option in Edit menu, or command button  in the toolbar buttons, or call the right click menu and choose the Equal Vertical Space command in Align option.





Before apply “The Same Width”, “The Same Height” and “The Same Height and Width” commands, you need to first make sure whether the objects to be processed have been rotated. Rotated objects are subjected to change between width and height. Application of these commands after rotation has the same effect as rotation after application of these commands.

4.3 Drawing basic graphs with SKWorkshop

This chapter introduces in detail the operations of drawing basic graphs with SKWorkshop.

4.3.1 Line of SKWorkshop

Choose Line command in Draw menu or click Line command button  in the tool buttons, and then move the mouse to the picture editing window. At this moment the mouse shape will become a cross, and now you can draw lines in the screen by clicking the mouse.

- After completing the above steps, the line has default settings in transparency, line type, line width, line color, end arrow, and end shape. You can modify these settings basing on actual needs. To do this, move the mouse onto the line and double click, or click Properties button  in the tool bar after choosing the line. At this moment, a property dialog as shown in Figure 4-24 will appear.

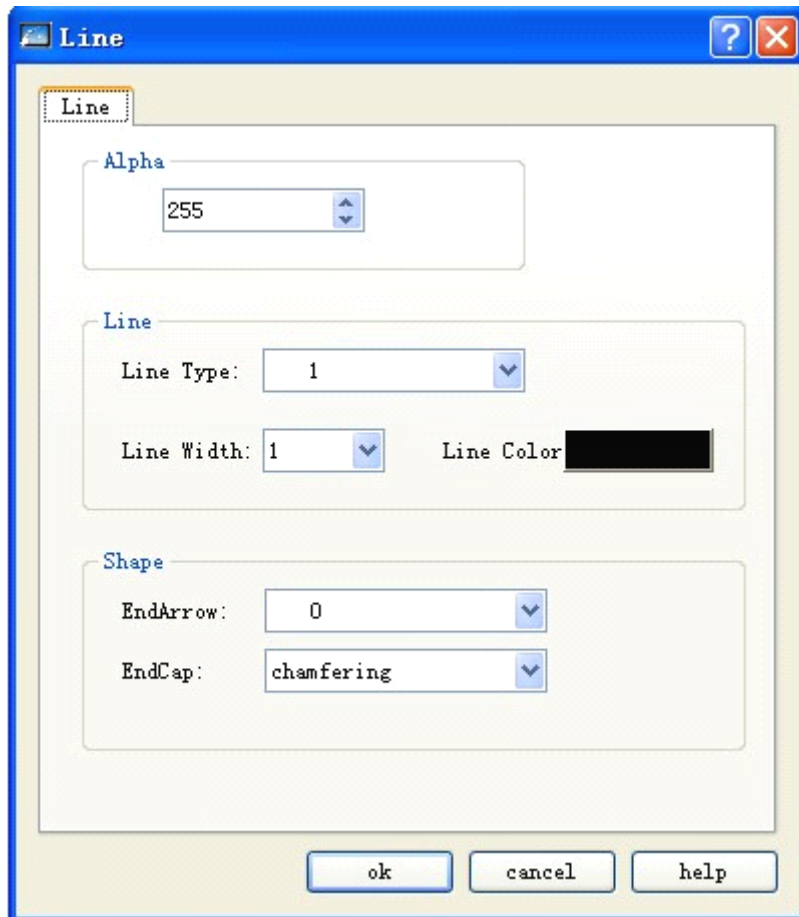



Figure 4-24: Line property dialog

- You may adjust the properties of the line using the pull-down and fine tuning button. SKWorkshop provides 6 line types, 30 line widths, and 6 line end arrows for straight line. To change the length, direction and position of the line, you may first choose the line, move the mouse to an end of the line, press down left key of the mouse after the mouse shape becomes , drag the mouse to appropriate position and finally release the left key.

4.3.2 Polygonal line of SKWorkshop

Choose Polyline command in Draw menu or click Polyline command button  in the tool buttons, and then move the mouse to the picture editing window. At this moment the mouse shape will become a cross, and now you can draw polygonal lines in the window.

- Move the mouse to a position where a line will be drawn, left click the mouse once, and then a small green dot will appear in the picture editing window. This dot will be an end of the polygonal line to be drawn.
- Move the mouse to another position in the screen, and at this moment the system will draw a line automatically. Move the mouse to a position where you want to change the direction of the line, left click the mouse once, and then a small green rectangle will appear. At this moment, the line from the first end to this green rectangle will not move along with the mouse. Then, move the mouse to another position where you want to change the direction of the line, and left click again. When a desired polygonal line has been drawn, right click the mouse to complete. See Figure 4-25.

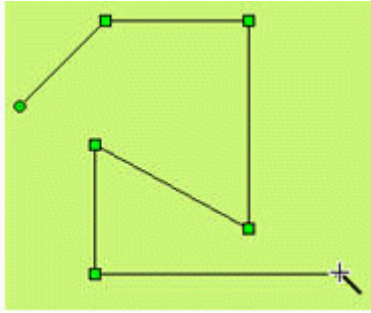





Figure 4-28: Drawing a polygonal line

- After completing the above steps, the polygonal line has default settings in transparency, line type, line width, line color, end arrow, and end shape. You can modify these settings basing on actual needs. To do this, move the mouse onto the polygonal line and double click, or click Properties button  in the tool bar after choosing the polygonal line. At this moment, a property dialog similar to that in line drawing will appear.

You may adjust the properties of the polygonal line using the pull-down and fine tuning button. SKWorkshop provides 6 line types, 30 line widths, and 6 line end arrows for polygonal line. To change the length, direction and position of the polygonal line, you may first choose the polygonal line, move the mouse to the polygonal line, press down left key of the mouse after the mouse shape becomes , drag the mouse to appropriate position and finally release the left key.

4.3.3 Curve/Arc of SKWorkshop

Choose Curve/Arc command in Draw menu or click Curve/Arc command button  in the tool buttons, and then move the mouse to the picture editing window. At this moment the mouse shape will become a cross, and now you can draw curve/arc in the window.

- Move the mouse to a position where a curve/arc will be drawn, left click the mouse, and then a small green dot will appear in the picture editing window. This dot will be the starting point of the polygonal line to be drawn.
- Move the mouse to another position in the screen, and at this moment the system will draw a line automatically. Then, left click the mouse and release.
- At this moment, the mouse shape is still a cross. Move the mouse to another position where you want to set the end of the curve/arc, press down the left key of the mouse and drag the mouse to move in the screen. Then, release the mouse and right click it to complete the drawing process. See Figure 4-26.

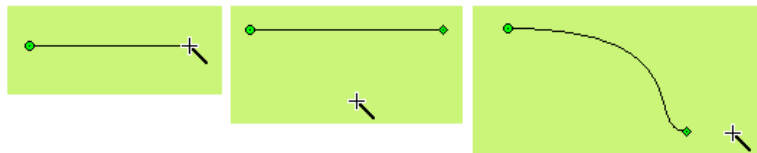



Figure 4-26: Drawing a curve/arc

- As shown in Figure 4-26, in the curve drawn the starting point is a green dot and the ending point is a diamond dot. This indicates that a curve/arc has been preliminarily drawn. Move the mouse to the starting point or the ending point, a dotted line will appear. The ending point of the dotted line is a square dot. Move the mouse to this dot, and then the mouse will become , press down the left key of the mouse, move it to an appropriate position, and release it to get desired radian. In addition, you can also move the starting point or the ending point to an appropriate position. See Figure 4-27.

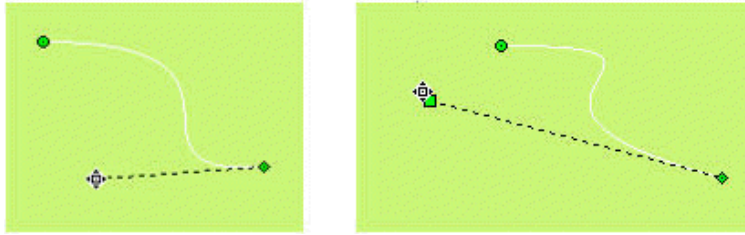



Figure 4-27: Drawing a curve/arc

- After completing the above steps, the curve/arc has default settings in transparency, line type, line width, line color, end arrow, and end shape. You can modify these settings basing on actual needs. To do this, move the mouse onto the curve/arc and double click, or click Properties button  in the tool bar after choosing the curve/arc. At this moment, a property dialog similar to that in line drawing will appear.

You may adjust the properties of the curve/arc using the pull-down and fine tuning button. SKWorkshop provides 15 line types, 10 line widths, and 6 line end arrows for curve/arc.

4.3.4 Free line of SKWorkshop

Choose Free Line command in Draw menu or click Free Line command button  in the tool buttons, and then move the mouse to the picture editing window. At this moment the mouse shape will become a cross, and now you can draw free line in the window.

- Move the mouse to a position where a free line will be drawn, left click the mouse once, and then a small green dot will appear in the picture editing window. This dot will be an end of the free line to be drawn.
- Move the mouse to another position in the screen, and at this moment the system will draw a curve automatically along the movement track of the mouse. Then, left click or right click the mouse to complete free line drawing. See Figure 4-28.
-

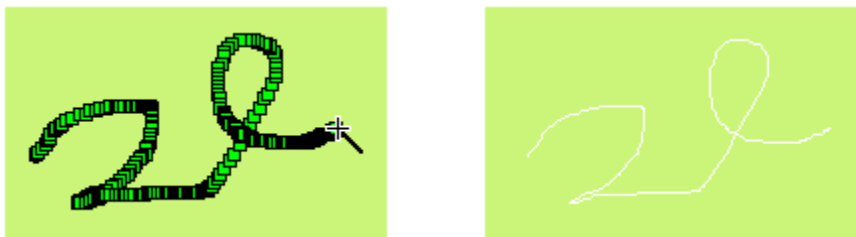







Figure 4-28: Drawing a free line

- After completing the above steps, the free line has default settings in transparency, line type, line width, line color, end arrow, and end shape. You can modify these settings basing on actual needs. To do this, move the mouse onto the free line and double click, or click Properties button  in the tool bar after choosing the free line. At this moment, a property dialog similar to that in line drawing will appear.

You may adjust the properties of the free line using the pull-down and fine tuning button. SKWorkshop provides 6 line types, 30 line widths, and 6 line end arrows for free line.

4.3.5 Rectangle of SKWorkshop

Choose Rectangle command in Draw menu or click Rectangle command button  in the tool buttons, and then move the mouse to the picture editing window. At this moment the mouse shape will become a cross, and now you can draw rectangle in the window.

- To change the size of the rectangle, first choose it and move the mouse to any of the 8 green square dots on the frame of the rectangle. When the mouse becomes  or  or , press down the left key of the mouse and drag the mouse to an appropriate position. Then release the left key of the mouse. So far the size of the rectangle has been adjusted.

 : Changing width of rectangle.

 : Changing height of rectangle.

 : Changing both width and height of rectangle.

- After completing the above steps, the rectangle has default settings in transparency, line type, line width, line color, and filling pattern. You can modify these settings basing on actual needs. To do this, move the mouse onto the rectangle and double click, or click Properties button  in the tool bar after choosing the rectangle. At this moment, a property dialog as shown in Figure 4-29 will appear.

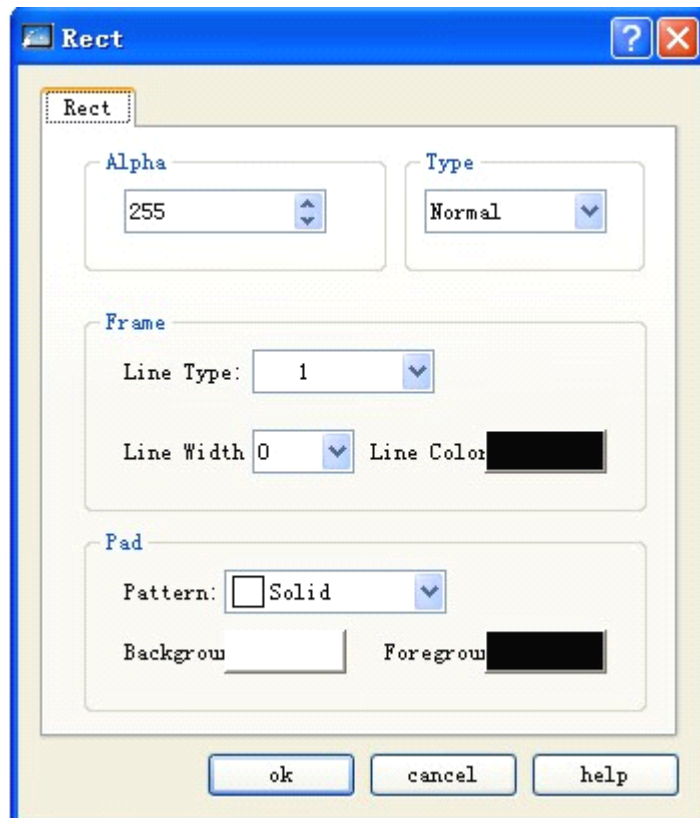

Figure 4-29: Rectangle properties dialog

- You may adjust the properties of the rectangle using the pull-down and fine tuning button. SKWorkshop provides 15 frame line types, 10 frame line widths, and 21 filling patterns for rectangle to make the graph more beautiful and vivid. See Figure 4-30.

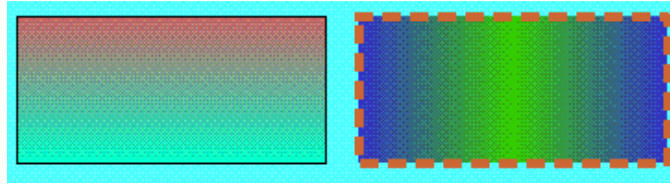







Figure 4-30: An example of a rectangle drawn

4.3.6 Rounded rectangle of SKWorkshop

Choose Rounded Rectangle command in Draw menu or click Rounded Rectangle command button  in the tool buttons, and then move the mouse to the picture editing window. At this moment the mouse shape will become a cross, and now you can draw a rounded rectangle in the screen by clicking the mouse.

- To change the size of the rectangle, first choose it and move the mouse to any of the 8 green square dots on the frame of the rectangle. When the mouse becomes  or  or , press down the left key of the mouse and drag the mouse to an appropriate position. Then release the left key of the mouse. So far the size of the rectangle has been adjusted.

 : Changing width of rectangle.

 : Changing height of rectangle.

 : Changing both width and height of rectangle.

- After completing the above steps, the rectangle has default settings in transparency, line type, line width, line color, and filling pattern. You can modify these settings basing on actual needs. To do this, move the mouse onto the rectangle and double click, or click Properties button  in the tool bar after choosing the rectangle. At this moment, a property dialog similar to that in rectangle drawing will appear. See Figure 4-31:

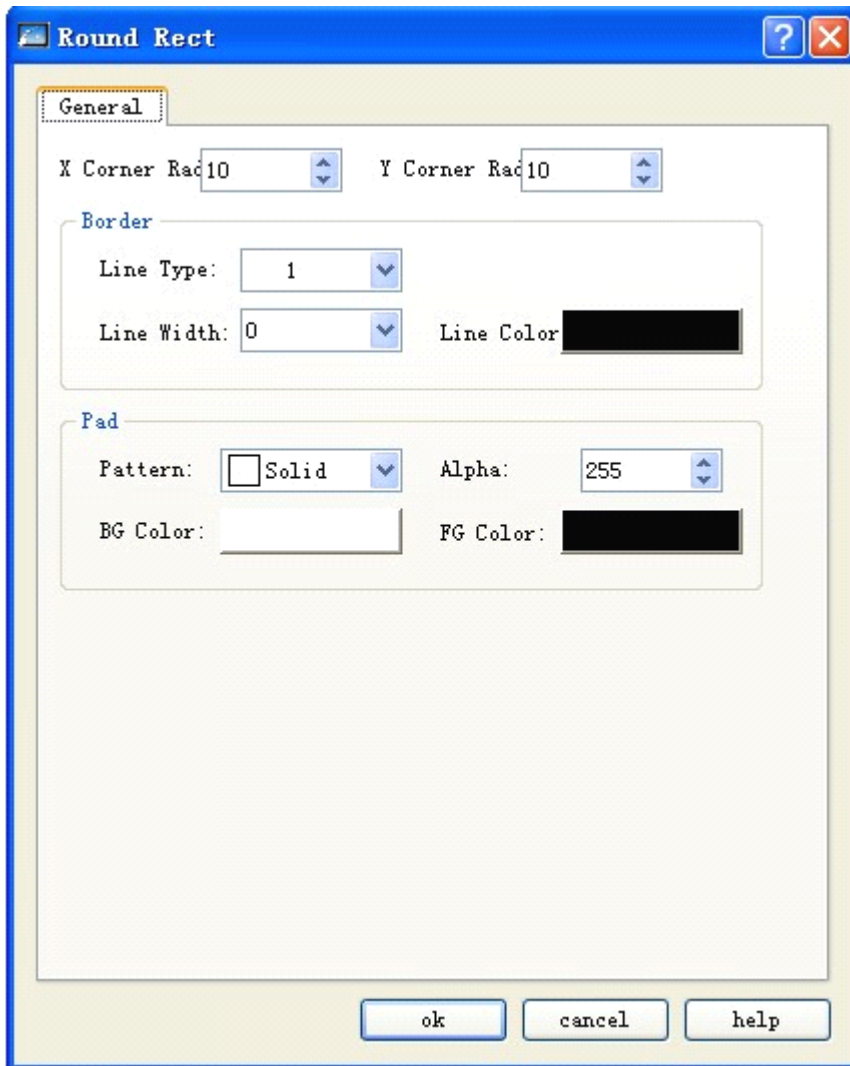







Figure 4-31: Rounded rectangle property dialog

- X bend radius: Radian of the four bends in X direction.
- Y bend radius: Radian of the four bends in Y direction.

4.3.7 Ellipse/Circle of SKWorkshop

Choose Ellipse/Circle command in Draw menu or click Ellipse/Circle command button  in the tool buttons, and then move the mouse to the picture editing window. At this moment the mouse shape will become a cross, and now you can draw ellipse/circle in the window.

- To change the size of the ellipse/circle, first choose it and move the mouse to any of the 8 green square dots on the frame of the ellipse/circle. When the mouse becomes  or  or , press down the left key of the mouse and drag the mouse to an appropriate position. Then release the left key of the mouse. So far the size of the ellipse/circle has been adjusted.

 : Changing width of ellipse/circle.

 : Changing height of ellipse/circle.

 : Changing both width and height of ellipse/circle.

- After completing the above steps, the ellipse/circle has default settings in transparency, line type, line width, line color, and filling pattern. You can modify these settings basing on actual needs. To do this, move the mouse onto the ellipse/circle and double click, or click Properties button  in the tool bar after choosing the ellipse/circle. At this moment, a property dialog similar to that in rectangle drawing will appear.
- You may adjust the properties of the ellipse/circle using the pull-down and fine tuning button. SKWorkshop provides 15 frame line types, 10 frame line widths, and 21 filling patterns for ellipse/circle to make the graph more beautiful and vivid. See Figure 4-32.

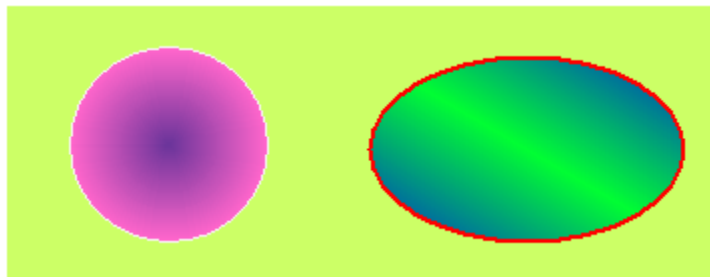



Figure 4-32: An example of an ellipse/circle drawn

4.3.8 Polygon of SKWorkshop

Choose Polygon command in Draw menu or click Polygon command button  in the tool buttons, and then move the mouse to the picture editing window. At this moment the mouse shape will become a cross, and now you can draw polygon in the window.

- Move the mouse to a position where a polygon will be drawn, left click the mouse (or press down and hold), and then a small green dot will appear in the picture editing window. This dot will be the starting position of the polygon to be drawn.
- Move the mouse to another position in the screen, and at this moment the system will draw a line automatically. Move the mouse to other appropriate positions, and each time the left key is clicked a side of the polygon will be drawn. Right click the mouse to complete polygon drawing. See Figure 4-33.

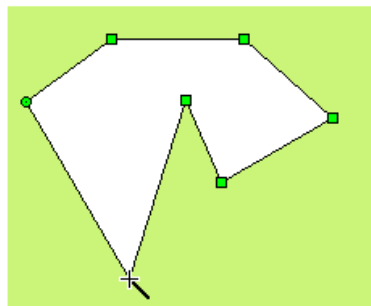



Figure 4-33: Drawing a polygon

- To change the shape of the polygon, first click the polygon and then several green dots will appear on the polygon frame (depending on number of sides of the polygon), indicating that the polygon has been chosen. Then, move the mouse to any of these dots, and the mouse will change to . Press down the left key of the mouse, and drag the mouse to a desired

target position of this point of the polygon to change the lengths and positions of the two lines connecting these two points. Finally, release the left key to complete drawing.

- After completing the above steps, the polygon has default settings in transparency, line type, line width, line color, and filling pattern. You can modify these settings basing on actual needs. To do this, move the mouse onto the polygon and double click, or click Properties button  in the tool bar after choosing the polygon. At this moment, a property dialog similar to that in rectangle drawing will appear.
- You may adjust the properties of the polygon using the pull-down and fine tuning button. SKWorkshop provides 15 frame line types, 10 frame line widths, and 21 filling patterns for polygon to make the graph more beautiful and vivid. See Figure 4-34.

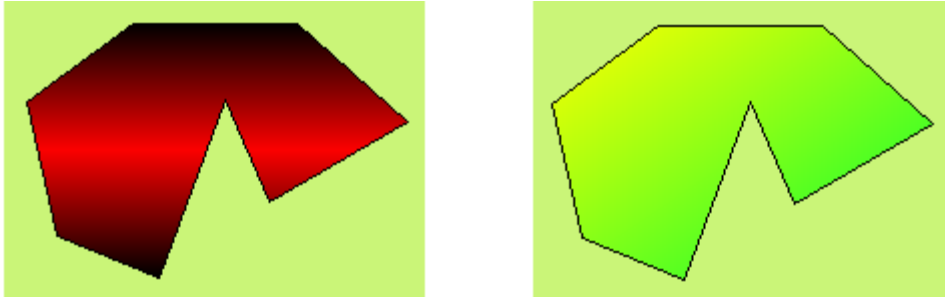



Figure 4-34: An example of a polygon drawn

4.3.9 Fan chart of SKWorkshop

Choose Fan Chart command in Draw menu or click Fan Chart command button  in the tool buttons, and then move the mouse to the picture editing window. At this moment the mouse shape will become a cross, and now you can draw a fan chart in the screen by clicking the mouse.

See Figure 4-35:

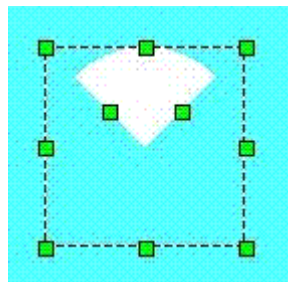



Figure 4-35: Draw a polygon

- Move the mouse to any of the green dots in the rectangle, and at this moment the mouse shape will become . Then, you can change the span of the sector by moving the mouse along an arc course.

4.3.10 Text graphs of SKWorkshop

Choose Text command in Draw menu, or click Text command button  in the tool buttons, and then a Static Text dialog will pop up. See Figure 4-36.

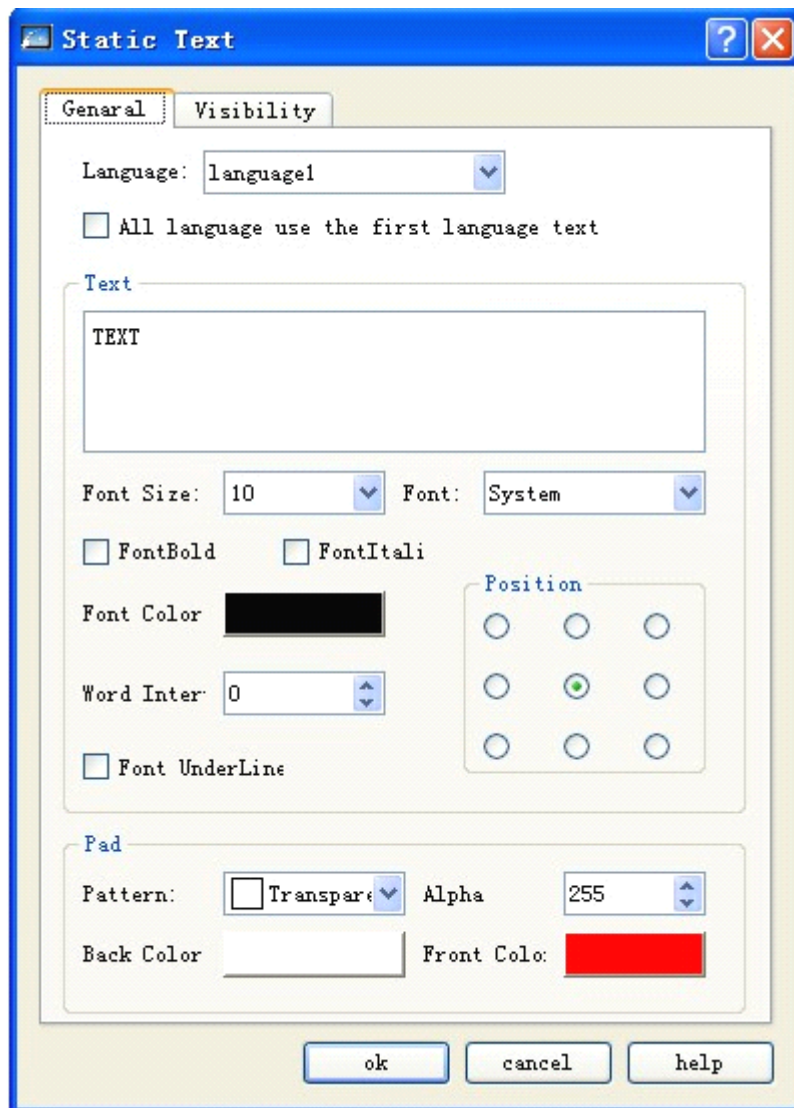

Figure 4-36: Static text dialog

- Input the words to be displayed in the “text” area in the above dialog.
- You can change the font size of the text to be displayed in the drop-down menu of “Font size”. The font sizes provided by SKWorkshop are 7-56 points.
- You can change the font in the drop-down menu of “Font”. SKWorkshop provides almost all fonts. See Figure 4-37.
- Language: it can input different texts and set different fonts and font size for different languages.







Figure 4-37: An example of a text graph

- Left click the small square in front of “FontBold”/ “FontItalic” in the dialog, a green tickle will appear, indicating the words will be displayed in bold/Italic.
- You can change the word interval and line interval by means of the corresponding fine tuning button. The range of such intervals is 0-15.
- SKWorkshop provides up to 16 underline forms, and you can change the display position of the words in the text box and the filling pattern and transparency. See Figure 4-38.



Figure 4-38 An example of a text graph

- After the font properties are modified, click OK button to close the dialog. Then, in the picture editing window the mouse will become . Move the mouse to a position where text will be displayed, left click the mouse and drag it to another appropriate position before left clicking again. The system will automatically draw a rectangular cell that is a text box.
- To modify or re-input the words of the text, double click the words and type in new words with keyboard. Enter key can be used to change a line during such inputting.
- To change the size of the background box of the text cell, first choose the text cell, move the mouse to the edge of the text box, press down the left key and drag the mouse when it becomes  or  or , and finally release the key at appropriate position.

: Changing width of text cell.

: Changing height of text cell.

: Changing both width and height of text cell.

- The Visibility tab has the same functions as the Visibility tab of other buttons.

4.3.11 Table graph of SKWorkshop

Choose Table command in Draw menu, or click Table command button  in the tool buttons, and then a Table dialog will pop up. See Figure 4-39.

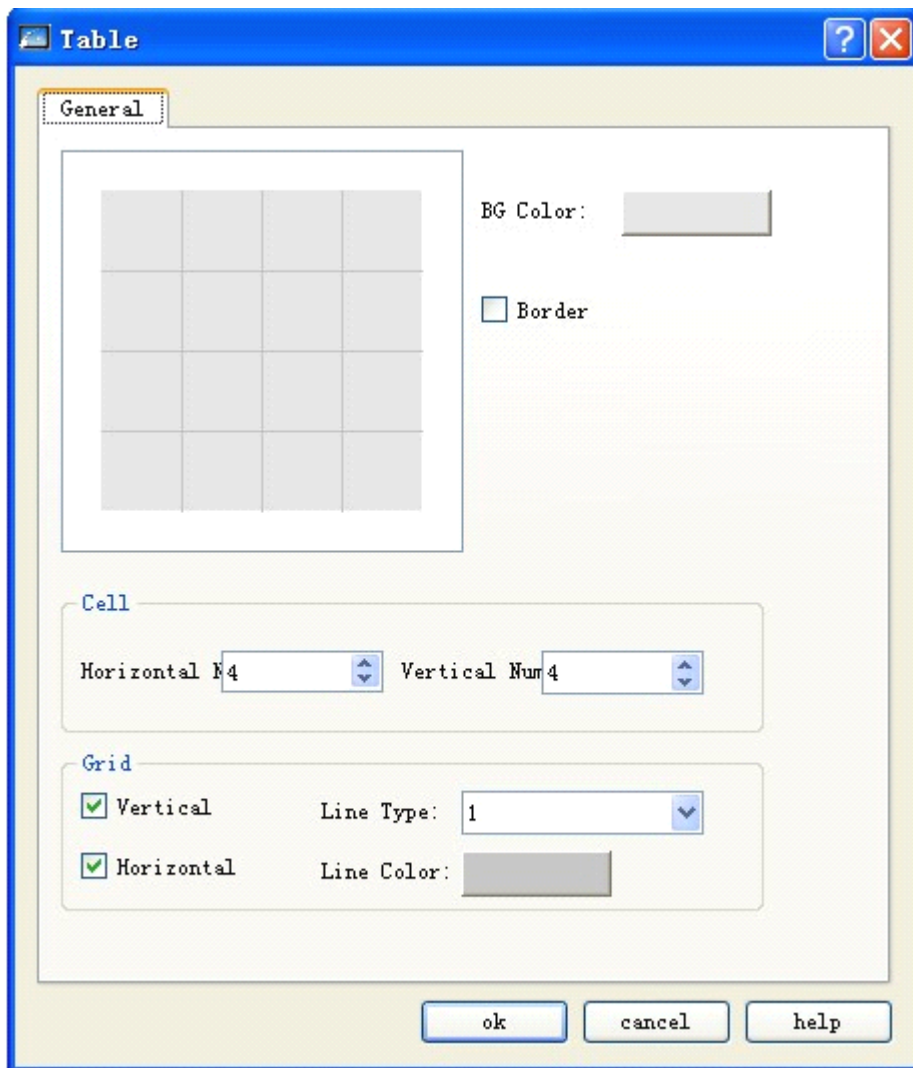

Figure 4-39: Table dialog

- In the Table dialog as shown in the figure above, SKWorkshop provides options such as background color, display of border, cell options and grid options. In Cell options, number of cells and be adjusted either by clicking the fine tuning button or directly typing in a number. In Grid options, you can choose whether to display the vertical/horizontal lines and change the grid pattern and color.
- After modifying the table properties, click OK button to close the dialog. Then, in the picture editing window the mouse will become . Move the mouse to a position where the table will be displayed, left click the mouse and drag it to another appropriate position before left clicking again. The system will automatically draw a table. See Figure 4-40.



Figure 4-40: An example of a table drawn



Such table is a pure graph object, and cannot be filled with words, data or other embedded objects. It can be only used as bottom graph. To display words, data or other objects over the table, you can add text graph and numeric display objects over the table, and set top layer for these objects.

4.3.12 Scale graph of SKWorkshop

Choose Scale command in Draw menu, or click Scale command button  in the tool buttons, and then a Scale dialog will pop up. See Figure 4-41.

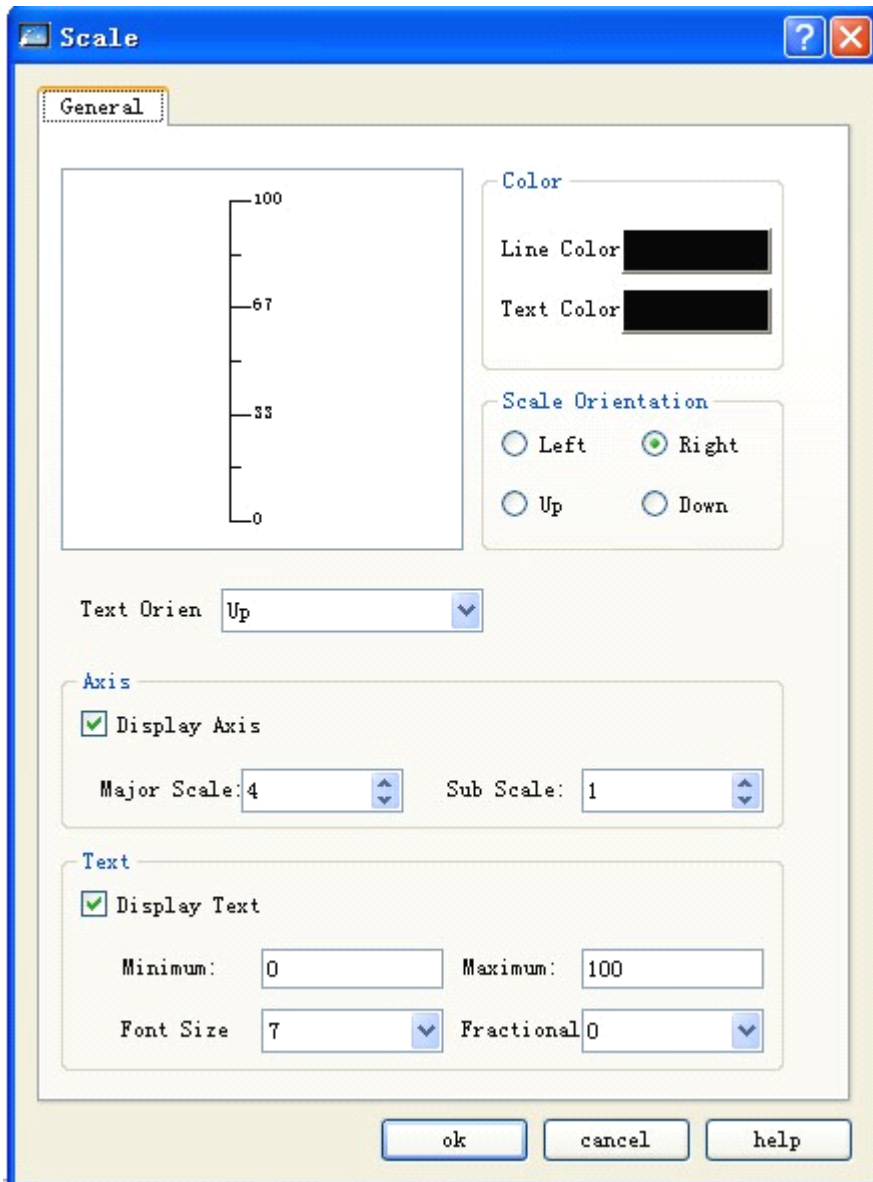



Figure 4-41: Scale dialog

- In the Scale dialog as shown in the figure above, SKWorkshop provides options such as color, coordinate axis, and text options. In Color options, you can choose line color and text color. In Axis options you can choose whether to display the axis and define the precision of the main scale and sub-scale either by means of the fine tuning button or direct typing in. In Text options, you can choose whether to display text and can change the maximum and minimum value of the scale, the Font Size and the Fractional Digits of the scale.
- After modifying the scale properties, click OK button to close the dialog. Then, in the picture editing window the mouse will become . Move the mouse to a position where the scale will be displayed, left click the mouse and drag it to another appropriate position before left clicking again. The system will automatically draw a scale. See Figure 4-42.

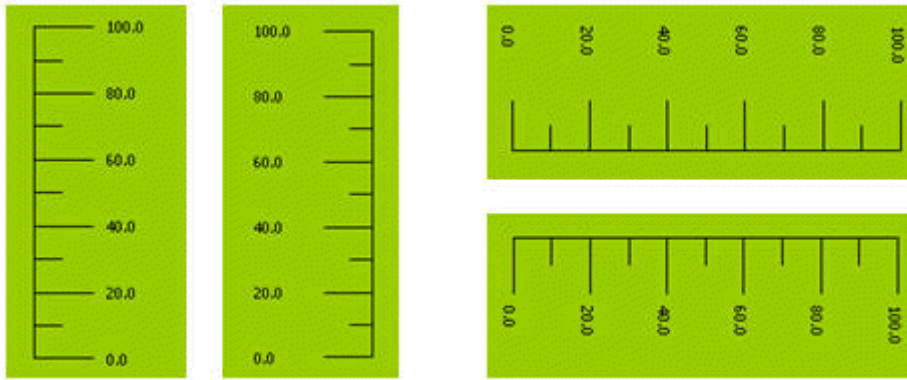



Figure 4-42: An example of a scale drawn

- A scale drawn following the above steps is as shown in the first left scale in the figure above. If you want to change it to the form of the second left scale in the figure above, first choose the scale, move the mouse to one of the height sides, press down the left key and drag the mouse when the mouse becomes , and have the mouse pass through the other height side. To change the scale to the right forms in the figure above, perform Free Rotation for it.

4.3.13 Open library of SKWorkshop

Choose Open Library command in Draw menu, or click Open Library command button  in the tool buttons, and then a Library List dialog will pop up. See Figure 4-43.

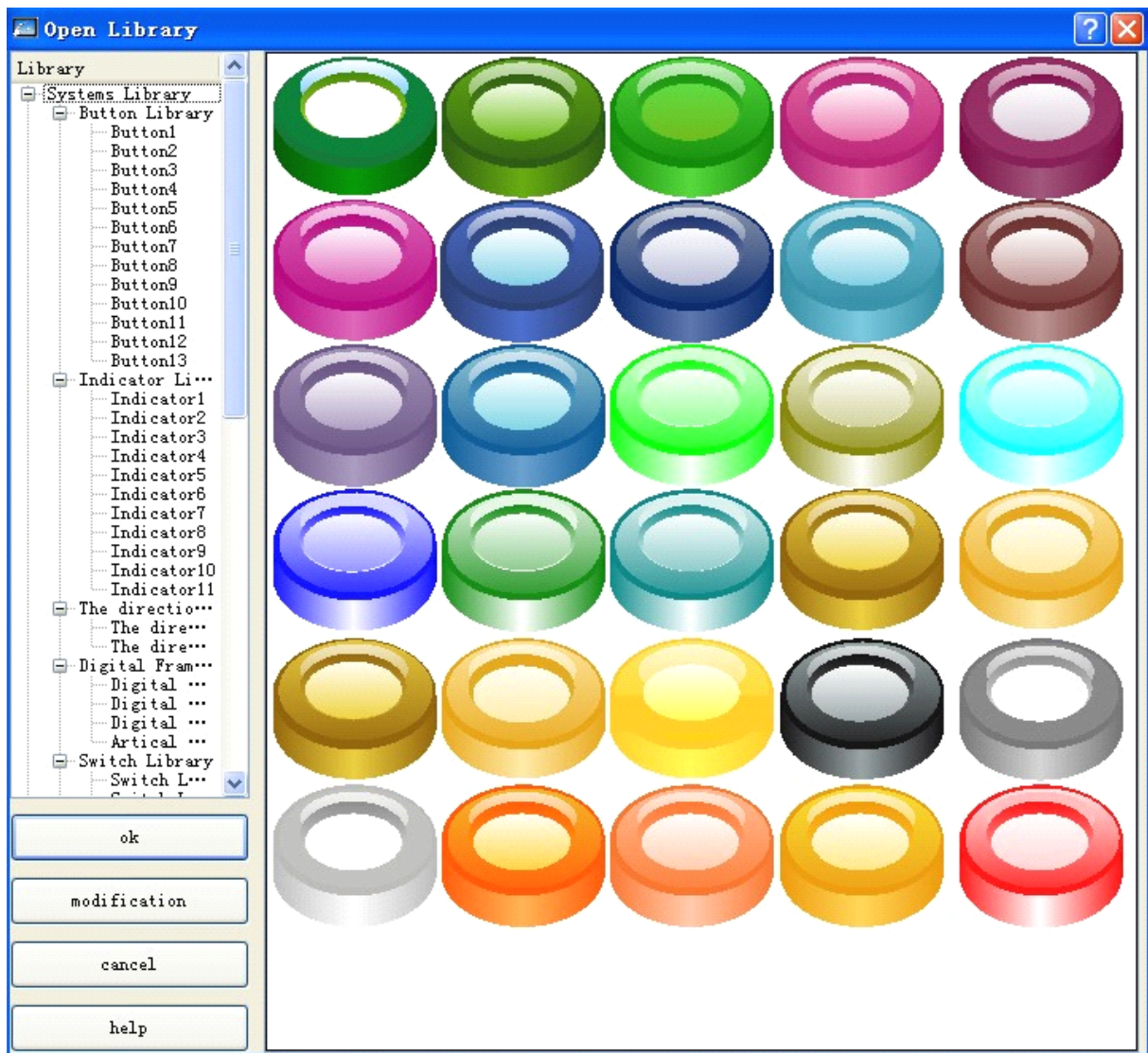

Figure 4-43: Library list

- The picture library of SKWorkshop provides users with abundant graph objects, and in SKWorkshop V4.0.0 many additional buttons, indicator lights and other graph objects are added. Designers can easily find desired graph objects in the library, saving much time in configuration.
- To choose a graph object, you can first click the brief major categories on the left side of the library, click “+” to unfold the detailed classes under the major categories, and then choose a desired graph object in the right area. Click or double click a graph, and click OK button on the lower left, and then the mouse shape will become a cross. Now you can add the library graph into the screen by clicking the mouse.
- Modify: Choose the graph to be modified, click the Modify button on the lower left, and then a dialog as shown in Figure 4-44 will pop up:

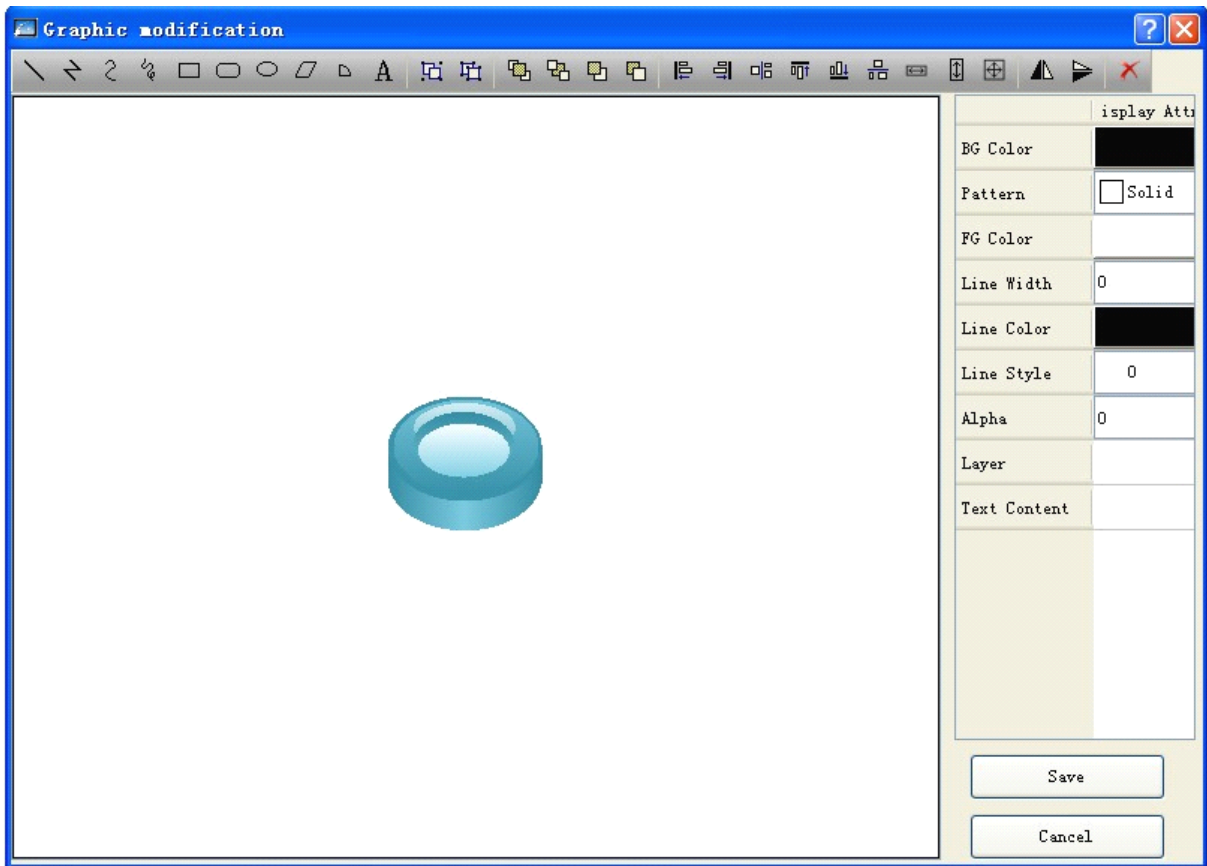

Figure 4-44: Modify a library graph

In the dialog as shown in Figure 4-44, choose the graph, and choose the Disassemble function button on the toolbar to disassemble the control from the library. Then, you can choose and modify a graph disassembled from the original combination. Choose the graph to be modified, and then you can set its foreground color, background color and pattern in the right list. After modification, choose all the graphs disassembled from the original combination, click the Assemble function button on the toolbar, and click Save button on the lower right. Then a dialog as shown in Figure 4-50 will pop up:

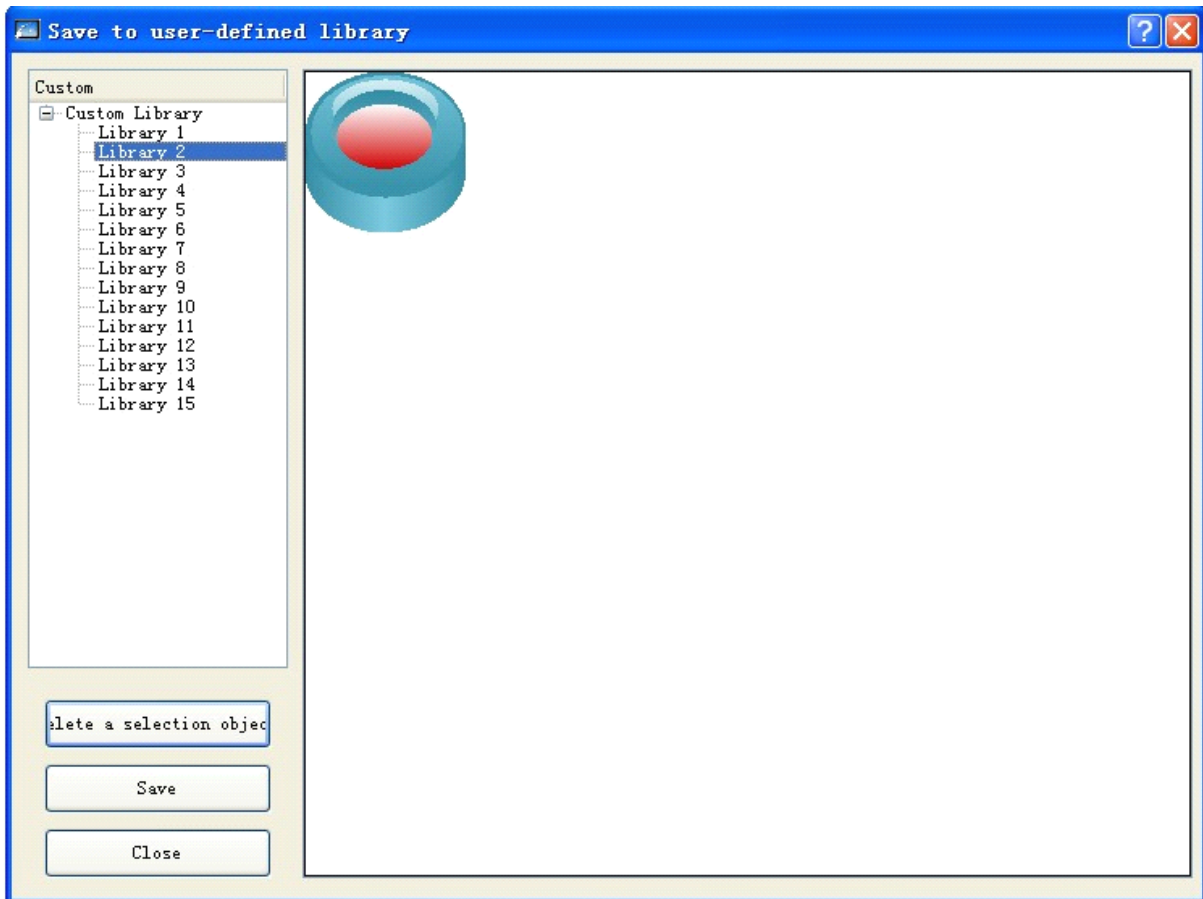



Figure 4-50: Save the modified graph to user-defined library

Choose the position where the modified graph will be saved (such as Library 2) in the User-defined list on the left, and click Save button below the list to save the modified graph. To view the graph saved just now, you can click the open library command button , scroll down the scroll bar to the bottom, and choose Library 2 in the User-defined Libraries.

4.3.14 Build library of SKWorkshop

Choose Build Library command in Draw menu, or click Build Library command button  in the tool buttons, and then a Library List dialog will pop up. See Figure 4-51.

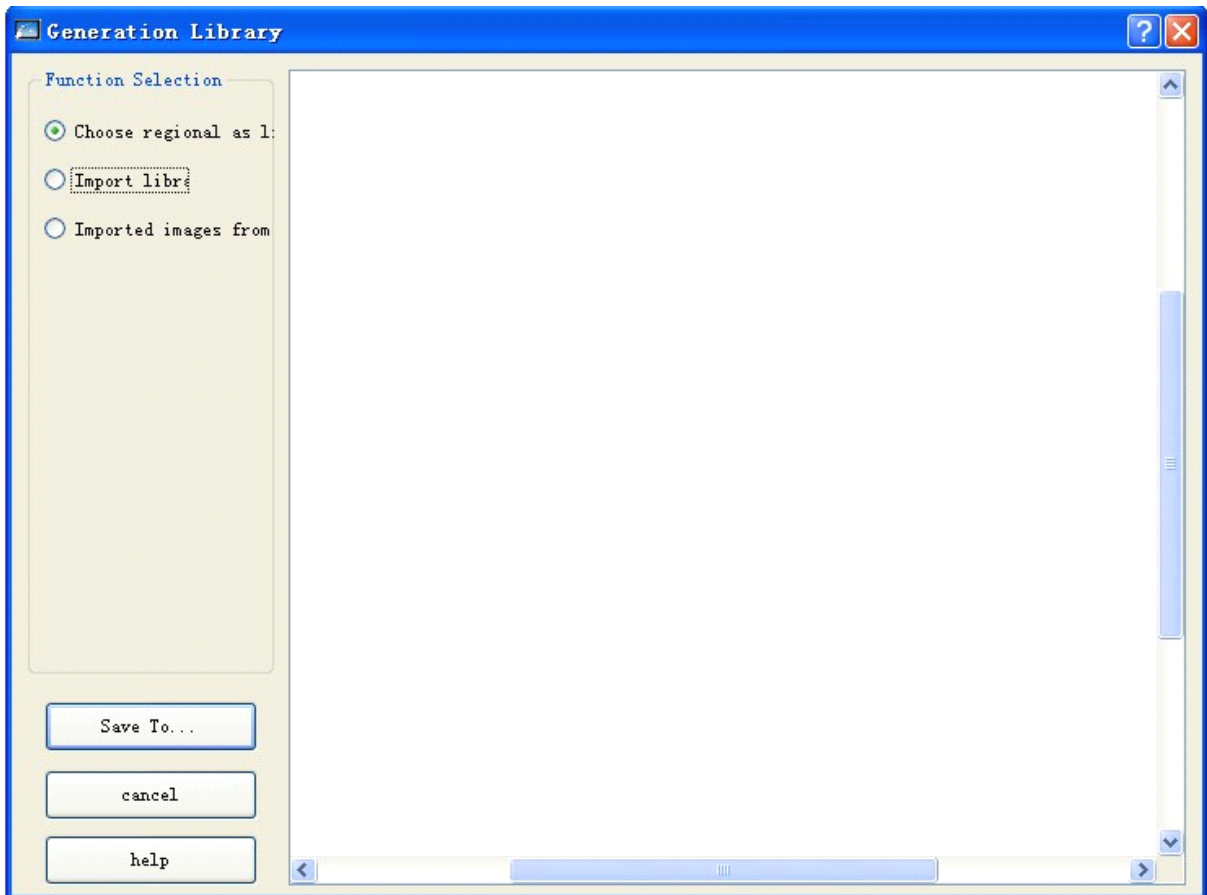

Figure 4-51: Build library dialog

- SKWorkshop can save configuration pictures completed by the designers so that they can use them conveniently next time. After clicking Build Library, as shown in the figure above, the graph object in the current screen will be displayed in the white area in the middle of the dialog.
- There are three options in the function area:
 - Choose area as library: Take the chosen object in the screen as the library object.
 - Import library: Import from external source well arranged library files with an extension of sk (such files are generally provided by the Company)
 - Import picture from files: Take a picture imported from external files as the library object.
- Click “Save to” button, select “library 2” .See Figure 4-52

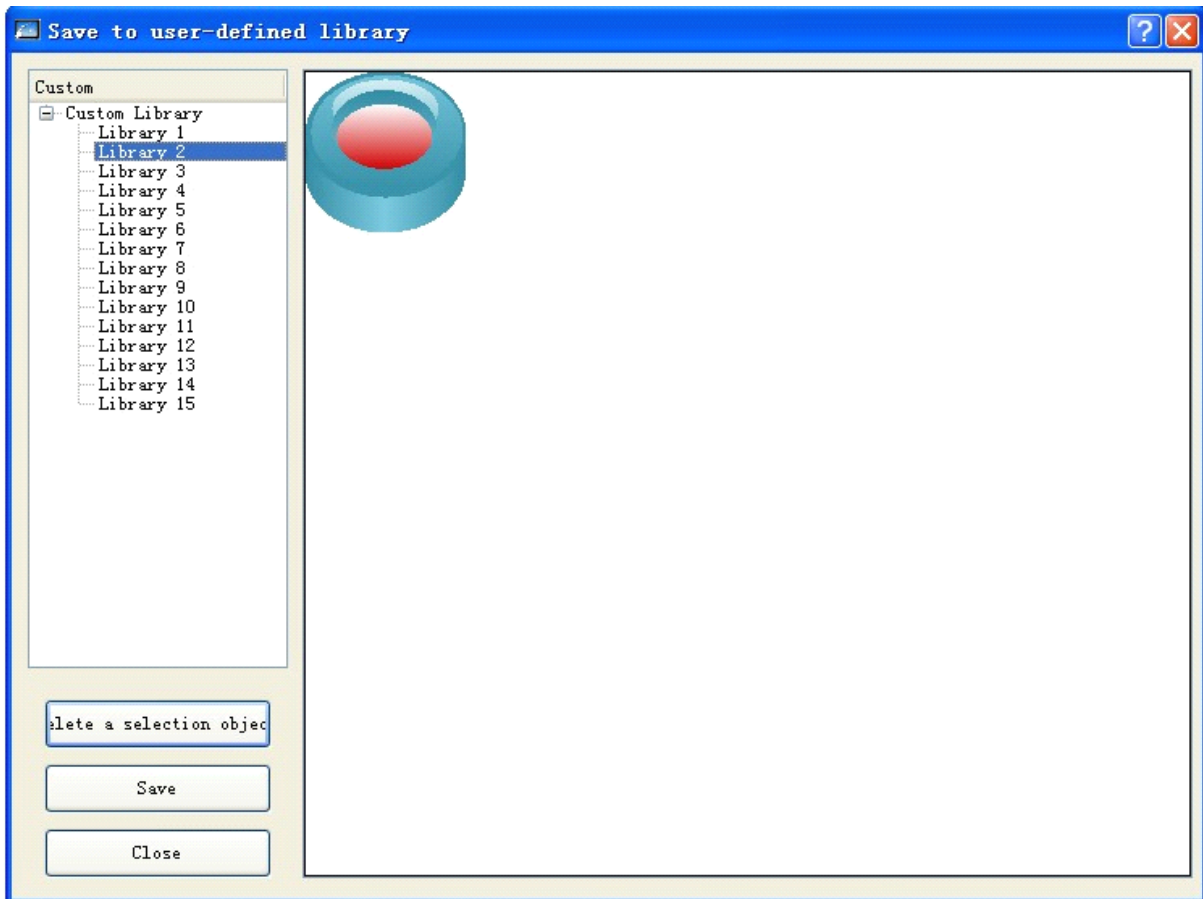



Figure 4-52: Save path selection dialog

Choose a save path in the selection box on the left. SKWorkshop totally provides 8 self-defined control libraries and graph libraries. After a save path is selected, click “Save to ...” button below to save the graph object. At this moment, the saved graph object will be displayed in the white area on the left. Click OK again to complete this operation. To view the graph saved just now, you can click the open library command button , scroll down the scroll bar to the bottom, and choose Library 2 in the User-defined Libraries.

4.4 Advanced controls of SKWorkshop

4.4.1 GIF display of SKWorkshop

GIF Display can be used to display animated pictures in GIF format, up to 32 frames. The operation steps are as follows:

Click GIF Display icon  in the tool bar, and then a dialog as shown in 4-53 will appear.



Figure 4-53: GIF Display dialog

After setting of the properties, click OK button, and then the mouse shape will become a cross. Now you can draw a rectangle in the screen by clicking the mouse and thus add this control into the screen.

- Click Advanced tab to enter Advanced properties setting page. See Figure 4-54.

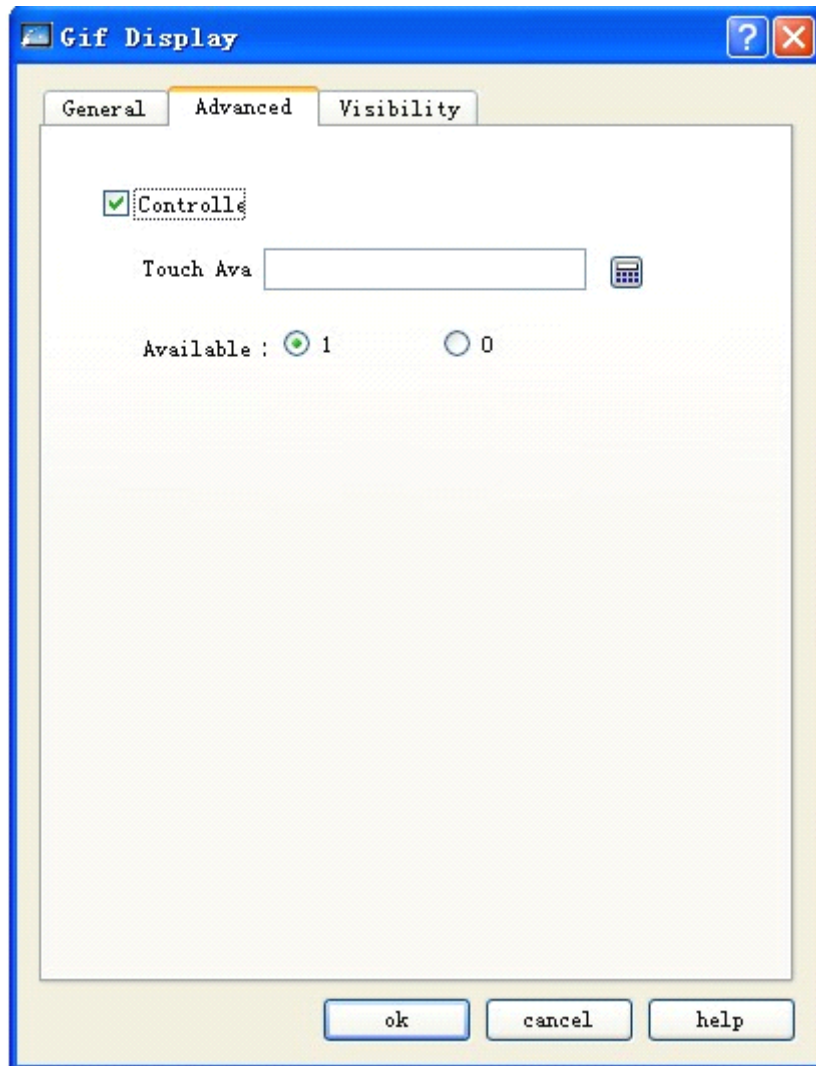

Figure 4-54: Advanced tab of GIF display

- ◆ **Controlled by bit:** When this option is checked, if the Effective State is 1, then the GIF picture will have animation effect when and only when the value of the Control Bit is 1; if the Effective State is 0, then the GIF picture will have animation effect when and only when the value of the Control Bit is 0.



Refer to Bit Button control for the use of Visibility tab.

4.4.2 Trend chart of SKWorkshop

- Overview of trend chart:

Displaying continuous values of variables on a dynamic and continuous basis.

Reference curves for multiple data can be drawn. Time will be used as the horizontal axis and value will be used as the vertical axis to visualize the change trend of the value in a period.

8 polygonal lines can be displayed at most (line chart).

- Steps to insert a Trend Chart and modify its properties are as follows:

1. Click Trend Chart icon  in the tool bar, and then a Trend Chart property dialog as shown in Figure 4-55 will appear.

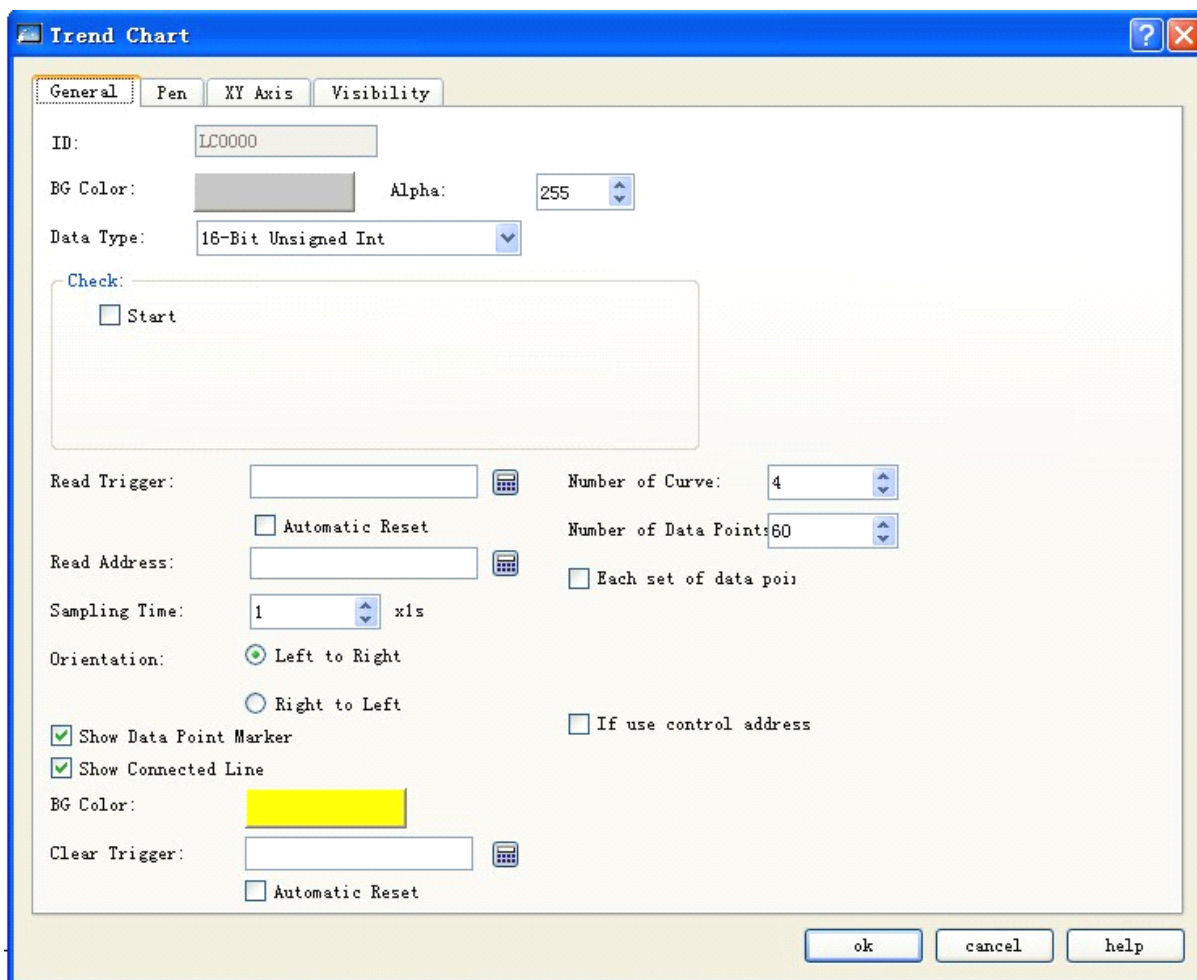

Figure 4-55: General tab of trend chart

BG Color: Used to set background color for the trend chart. The change in the color can be seen only after clicking OK button.

Data Type: Totally 7 data types are provided.

Read Trigger: The curves will move only when this option is set to 1.

Number of Data: Number of pens that is number of lines. 8 pens at most.

Auto resetting of read trigger bit: If the system detects that the value of the read trigger bit is 1, it will immediately reset this value to 0.

Number of Data Points per Data: The number of values that can be displayed by X axis.

Sampling Time: Sampling frequency.

Read Address: Value of read address presents the value of each pen in Y axis. Basing on different data groups and data type read address may be subject to continuous reading (16-digit data) or separated reading (32-digit data).

Variable data points of each data group: Set “Data Points of Each Data Group” on a dynamic basis basing on the value of the address. If this option is chosen, the default value of the address is the original value of “Data Points of Each Data Group”.

➤ Detection

Enable: Whether to enable the detection line (reference line).

Color: Color of the detection line (reference line).

Detection address: Write the value corresponding to the current position of the detection line (reference line) into the detection address register.

➤ Use Control Address: Set the minimum and maximum value of Y axis on a dynamic basis basing on the value of the control address. This address occupies 5 consecutive address offsets, and is used to change the maximum/minimum value of each pen and to determine whether to recover the original state.

Address offset	Controlled object of the control register address
0	Minimum value the lower 16 bits
1	Minimum value the higher 16 bits
2	Maximum value the lower 16 bits
3	Maximum value the higher 16 bits
4	Whether to recover the original state of the minimum value and the maximum value. If the value of the address is 1, there will be dynamic change, otherwise the original value will be recovered.

Note: Only internal address can be used for this control address, and the minimum value and maximum value respectively occupies two consecutive word addresses.

➤ For example:

If the data type is 16-digit data, the number of data is 8, and the read address set by the user is LW3, then the values of 8 addresses will be read continuously, that is:

LW3: Value of pen 1

LW4: Value of pen 2

LW5: Value of pen 3

LW6: Value of pen 4

LW7: Value of pen 5

LW8: Value of pen 6

LW9: Value of pen 7

LW10: Value of pen 8

Thus, if 16-digit data is chosen and the number of data is set to N, then the values of N addresses can be read continuously according to different address rules of the PLC.

If the data type is 32-digit data, the number of data is 5, and the read address set by the user is LW3, then the values of 5 addresses will be read continuously, that is:

LW3: Value of pen 1

LW5: Value of pen 2

LW7: Value of pen 3

LW9: Value of pen 4

LW11: Value of pen 5

Thus, if 32-digit data is chosen and the number of data is set to N, then the values of N addresses (adding 2 to the address each time) can be read according to different address rules of the PLC.

Direction:

From left to right: The pens (lines) move from left to right.

From right to left: The pens (lines) move from right to left.

BG Color: Background color of the area where the pens (lines) are moving.

Clear Trigger: When the value of the Clear Trigger address changes from 0 to 1, all current pens (lines) will be cleared. When the value of the Clear Trigger address changes from 1 to 0 or has no change, no change will be made to the pens.

2. Pen tab of Trend Chart. See Figure 4-56.

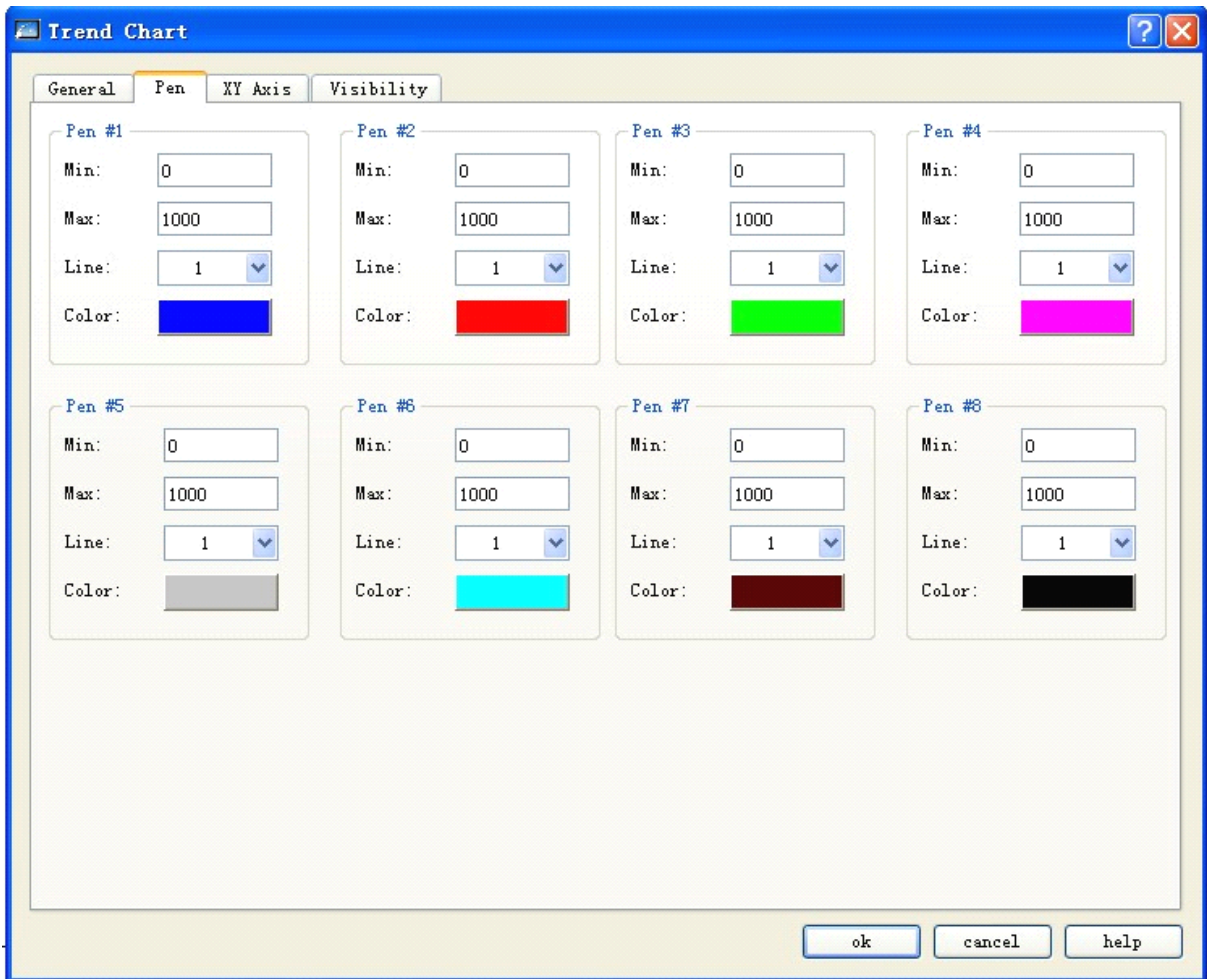

Figure 4-56: Pen tab of Trend Chart

In this tab you can set the maximum value, minimum value, line pattern and line color of each pen.

The data type of Max and Min is determined by the Data Type defined in General tab.

For example, if you want to enter floating point numbers to Max and Min, you must choose “32-digit floating point number” in Data Type option in General tab. Otherwise, an error will be reported when you click OK button.

3. XY Axis tab. See Figure 4-57.

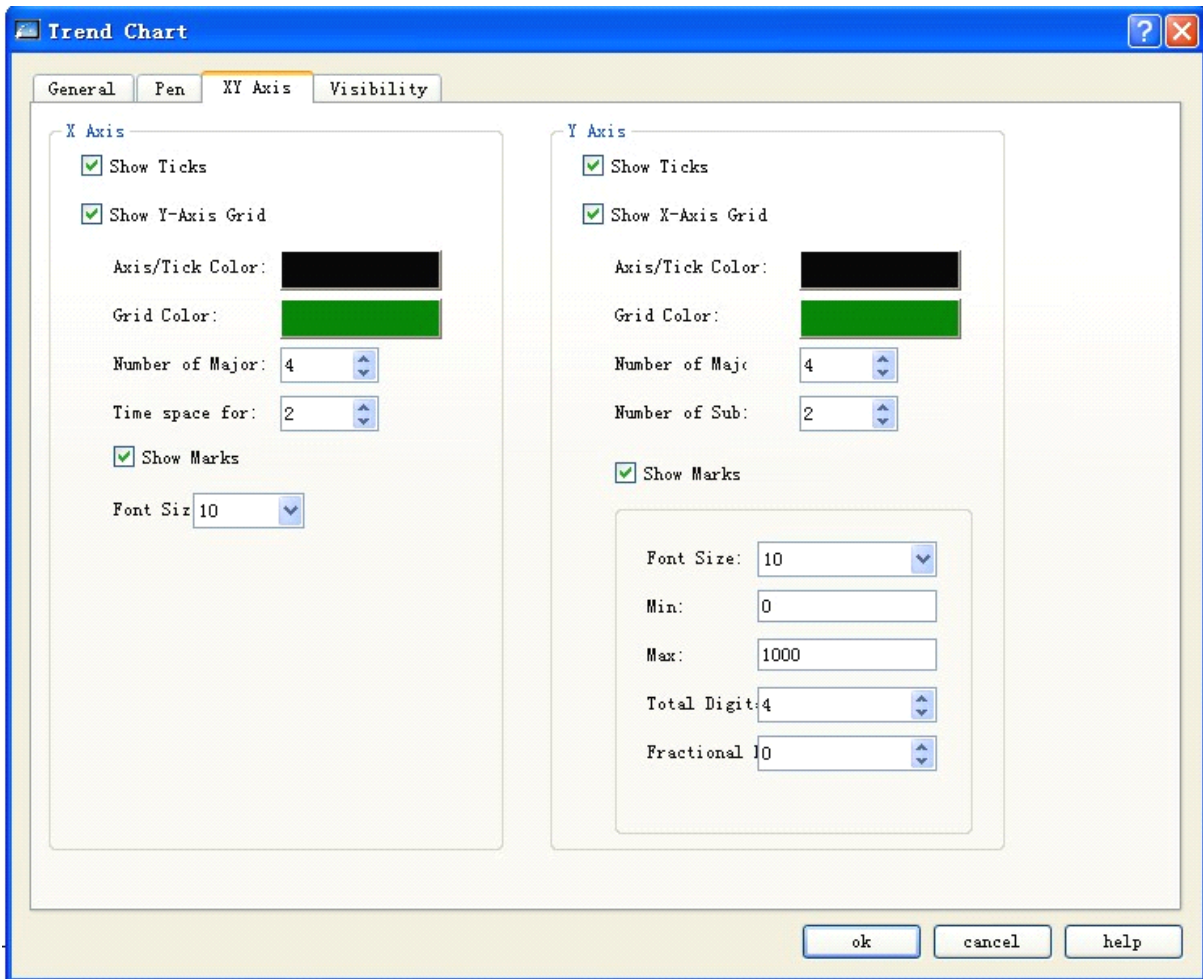

Figure 4-57: XY Axis tab of Trend Chart

- X Axis
 - Show Ticks: Defining whether to show scales of X axis.
 - Show Y-Axis Grid: Defining whether to show grids of Y axis.
 - Axis/Tick Color: Changing the color of X axis/tick.
 - Grid Color: Changing the color of X axis grids.
 - Number of Major: Number of major ticks of X axis.
 - Number of Sub: Number of sub ticks of X axis.
 - Show Marks: Defining whether to show marks of X axis.
- Y Axis
 - Show Ticks: Defining whether to show scales of Y axis.
 - Show X-Axis Grid: Defining whether to show grids of X axis.
 - Axis/Tick Color: Changing the color of Y axis/tick.
 - Grid Color: Changing the color of Y axis grids.
 - Number of Major: Number of major ticks of Y axis.

Number of Sub: Number of sub ticks of Y axis.

Show Marks: Defining whether to show marks of Y axis.

Font Size: Changing font size of marks on Y axis.

Min: Minimum value of ticks of Y axis.

Max: Maximum value of ticks of Y axis.

Total Digits: Maximum digits of the data displayed.

Fractional Digits: Maximum fractional digits of the data displayed.



Refer to Bit Button control for the use of Visibility tab.

4.4.3 XY Trend chart of SKWorkshop

➤ Overview of XY Trend chart:

Displaying continuous values of variables on a dynamic and continuous basis.

Reference curves for multiple data can be drawn. Values of two continuous register addresses will be respectively used as the horizontal and vertical axis to visualize the change trend of the two values.

8 polygonal lines can be displayed at most.

Steps to insert a XY Trend Chart are similar to that for Trend Chart, so you can refer to the introduction above for reference. The icon of XY Trend Chart in the tool bar is .

Open the Properties dialog of XY Trend Chart, and set parameters with reference to the parameter setting for Trend Chart. It should be noted that in Trend Chart each pen presents the values of continuous addresses starting from write address, and in XY Trend Chart each pen presents the values of two continuous addresses starting from write address.

➤ Detection module

Enable: Whether to enable the detection line (reference line).

Color: Color of the detection line (reference line).

Detection address: Write the value corresponding to the current position of the detection line (reference line) into the detection address register.

For example:

If the data type is 16-digit data, the number of data is 4, and the read address set by the user is LW3, then the values of 8 addresses will be read continuously, that is:

LW3: X-axis value of pen 1

LW4: Y-axis value of pen 1

LW5: X-axis value of pen 2

LW6: Y-axis value of pen 2

LW7: X-axis value of pen 3

LW8: Y-axis value of pen 3

LW9: X-axis value of pen 4

LW10: Y-axis value of pen 4

The read addresses are LW3 to LW10, totally 8 addresses. Thus, if 16-digit data is chosen and the number of data is set to N, then the values of $2*N$ addresses can be read continuously according to different address rules of the PLC.

If the data type is 32-digit data, the number of data is 3, and the read address set by the user is LW3, then the values of 12 addresses will be read continuously, that is:

LW3: X-axis value of pen 1

LW5: Y-axis value of pen 1

LW7: X-axis value of pen 2

LW9: Y-axis value of pen 2

LW11: X-axis value of pen 3

LW13: Y-axis value of pen 3

The read addresses are LW3 to LW14, totally 12 addresses. Thus, if 32-digit data is chosen and the number of data is set to N, then the values of $2*N$ addresses (adding 2 to the address each time) can be read according to different address rules of the PLC.

4.4.4 Historical trend chart of SKWorkshop

➤ Overview of trend chart: This chart should be used together with the Historical Data Collector in the Project Manager of the system. It displays the data value read from the Historical Data Collector.

➤ Overview of XY Trend chart:

Displaying continuous values of variables on a dynamic and continuous basis.

Reference curves for multiple data can be drawn. Values of two continuous register addresses will be respectively used as the horizontal and vertical axis to visualize the change trend of the two values.

8 polygonal lines can be displayed at most (line charts).

➤ The steps to insert Trend chart and modify its properties are as follows:

1. Click Trend chart icon  in the tool bar, and then a dialog as shown in Figure 4-58 will appear:

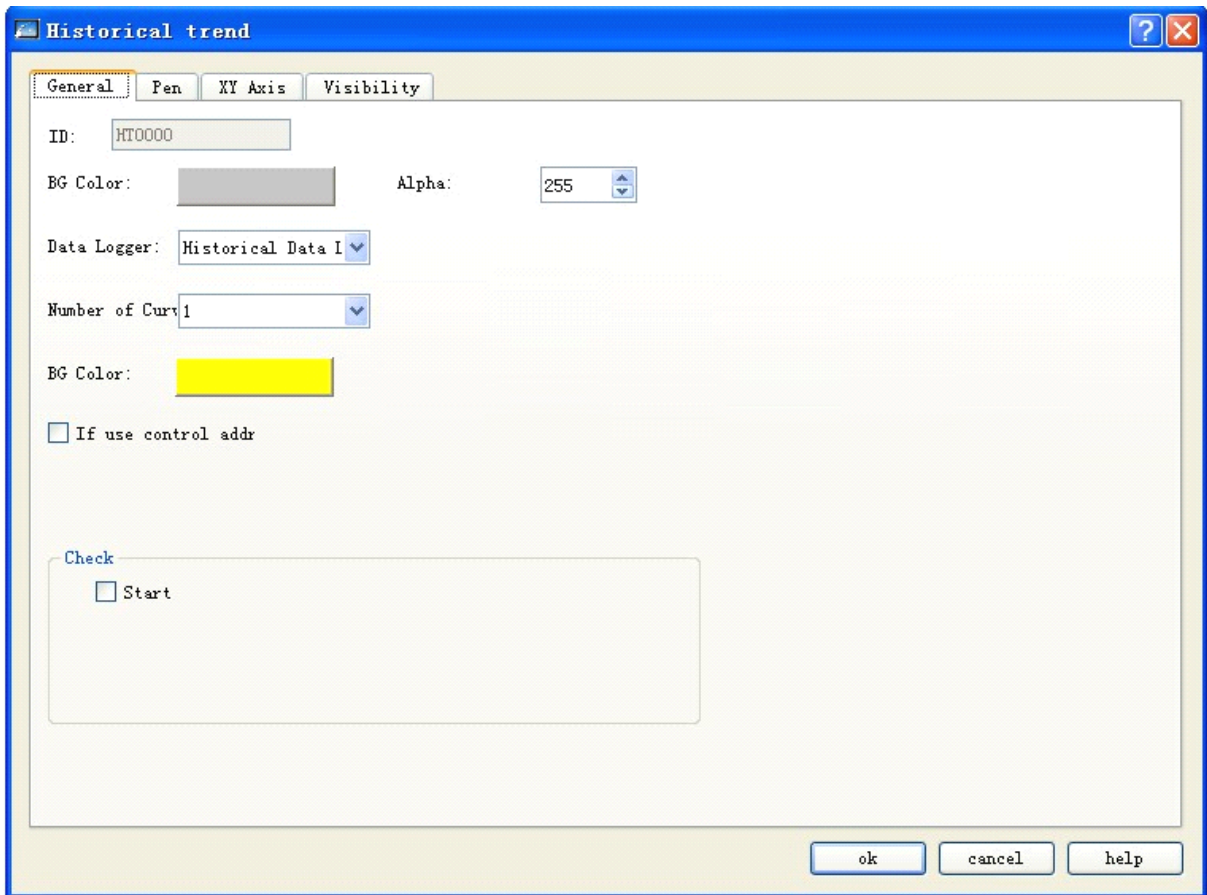

Figure 4-58: General tab of historical trend chart

BG Color: Used to set background color for the trend chart. The change in the color can be seen only after clicking OK button.

Transparency: Change transparency of the background color.

Data collection: The default setting of this option is Historical Data Collector in the Project Manager.

Total number of curves: Number of pens, which is number of register values, up to 8.

Background color: Color of the area where the pen (i.e. the line) will be moved.

Use control address: This address occupies 50 consecutive address offsets, used to change options of each pen such as whether to display pen, maximum value of pen, minimum value of pen, ending time of control (minute), range of control time (minute), maximum Y axis display at the time of single axis control, minimum Y axis display at the time of single axis control, whether use multiple Y axes and recover to original state.

Address offset	Controlled object of the control register address
0	Total number of pens
1	Whether to display pen 1
2	MAX
3	
4	MIN

5	
6	Whether to display pen 2
7	MAX
8	
9	MIN
10	
11	Whether to display pen 3
12	MAX
13	
14	MIN
15	
16	Whether to display pen 4
17	MAX
18	
19	MIN
20	
21	Whether to display pen 5
22	MAX
23	
24	MIN
25	
26	Whether to display pen 6
27	MAX
28	
29	MIN
30	
31	Whether to display pen 7
32	MAX
33	
34	MIN
35	
36	Whether to display pen 8
37	MAX
38	
39	MIN
40	
41	Ending time (minute), used to define the ending time basing on the current time.
42	
43	Time range (minute)
44	
45	MAX MAX at the time of single Y axis display
46	
47	MIN MIN at the time of single Y axis display
48	
49	Whether to use multiple Y axis
50	Recover original state. Recover when the value is 1, and automatically reset after recovering.

➤ Detection

Enable: enable the detection line (reference line) or not.

Color: the color of detection line (reference line).

Detection address: writing the corresponding value of current detection line (reference line) into the detection address register.

2. Page of “Pen” in historical tendency chart as shown in Figure 4-59:

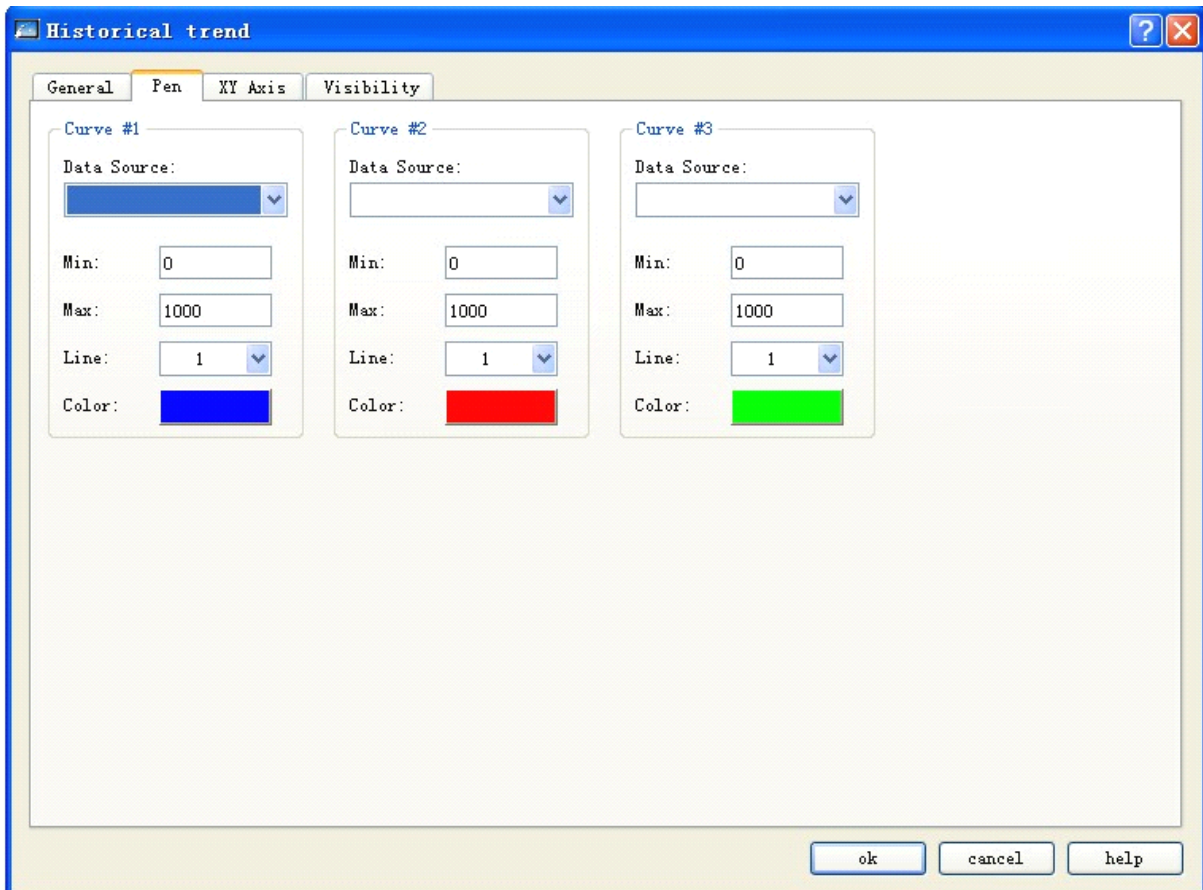

Figure 4-59: Pen tab of historical trend chart

In this tab user can set the maximum/minimum value of each pen, line pattern and line color. The data source is the data in the Data tab of Historical Data Collection in the Project Manager. Different data sources can be chosen for the pens.

3. XY Axis tab of Historical trend chart, as shown in Figure 4-60:

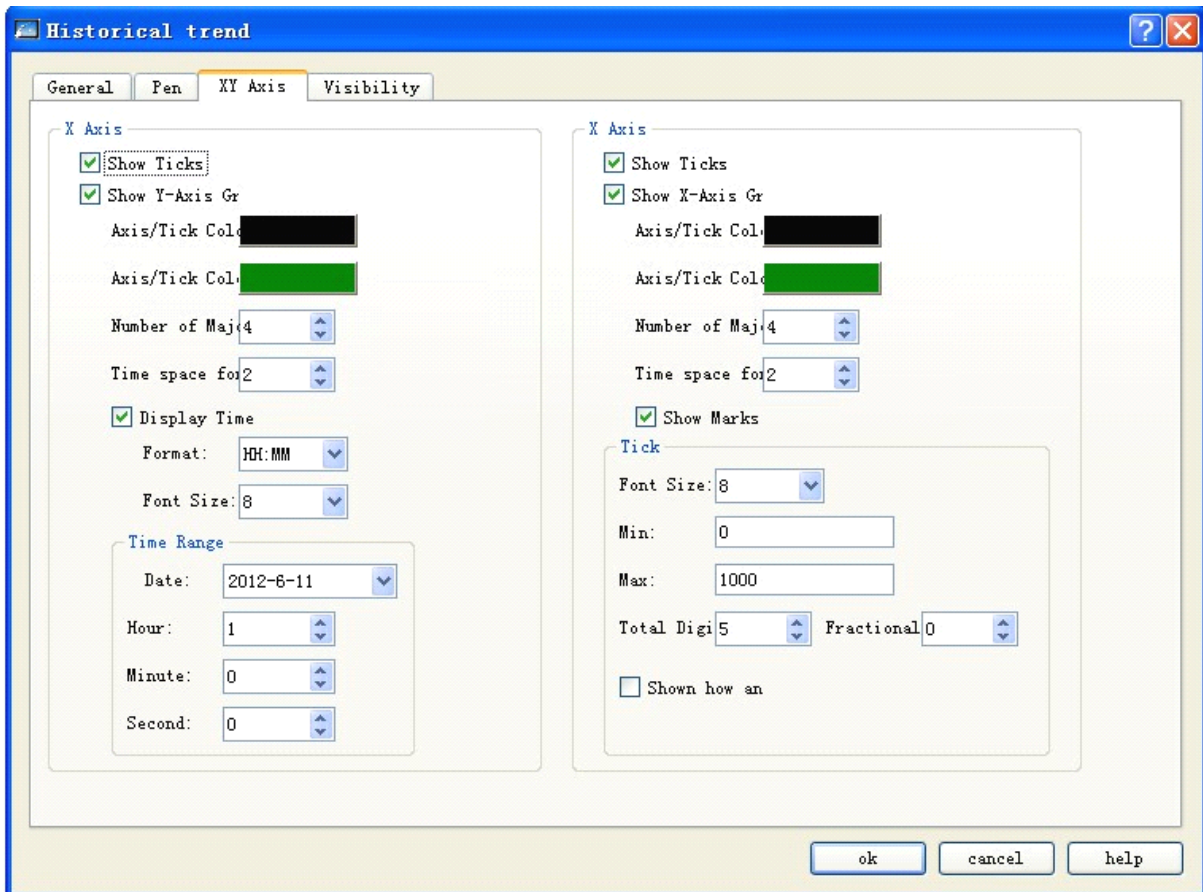

Figure 4-60: XY Axis tab of Trend Chart

- X Axis
 - Show Ticks: Defining whether to show scales of X axis.
 - Show Y-Axis Grid: Defining whether to show grids of Y axis.
 - Axis/Tick Color: Changing the color of X axis/tick.
 - Grid Color: Changing the color of X axis grids.
 - Number of Major: Number of major ticks of X axis.
 - Number of Sub: Number of sub ticks of X axis.
 - Display time: Set the format of time display and the font size of the time displaying text.
 - Time range module: Set the time range displayed in the trend chart.
- Y Axis
 - Show Ticks: Defining whether to show scales of Y axis.
 - Show X-Axis Grid: Defining whether to show grids of X axis.
 - Axis/Tick Color: Changing the color of Y axis/tick.
 - Grid Color: Changing the color of Y axis grids.
 - Number of Major: Number of major ticks of Y axis.
 - Number of Sub: Number of sub ticks of Y axis.

Show Marks: Defining whether to show marks of Y axis.

Font Size: Changing font size of marks on Y axis.

Min: Minimum value of ticks of Y axis.

Max: Maximum value of ticks of Y axis.

Total Digits: Maximum digits of the data displayed.

Fractional Digits: Maximum fractional digits of the data displayed.

Display multiple axes: Whether to display several coordinate axes.



Refer to Bit Button control for the use of Visibility tab.

4.4.5 Dynamic circle of SKWorkshop

Dynamic Circle is used to place a graph onto the screen and have the graph move along a specified course and change in size. Such movement and size change is determined by the value of the monitored address. The steps to insert Dynamic Circle control and modify its properties are as follows:

Click Dynamic Circle icon  in the tool bar, and then a dialog as shown in Figure 4-61 will appear:

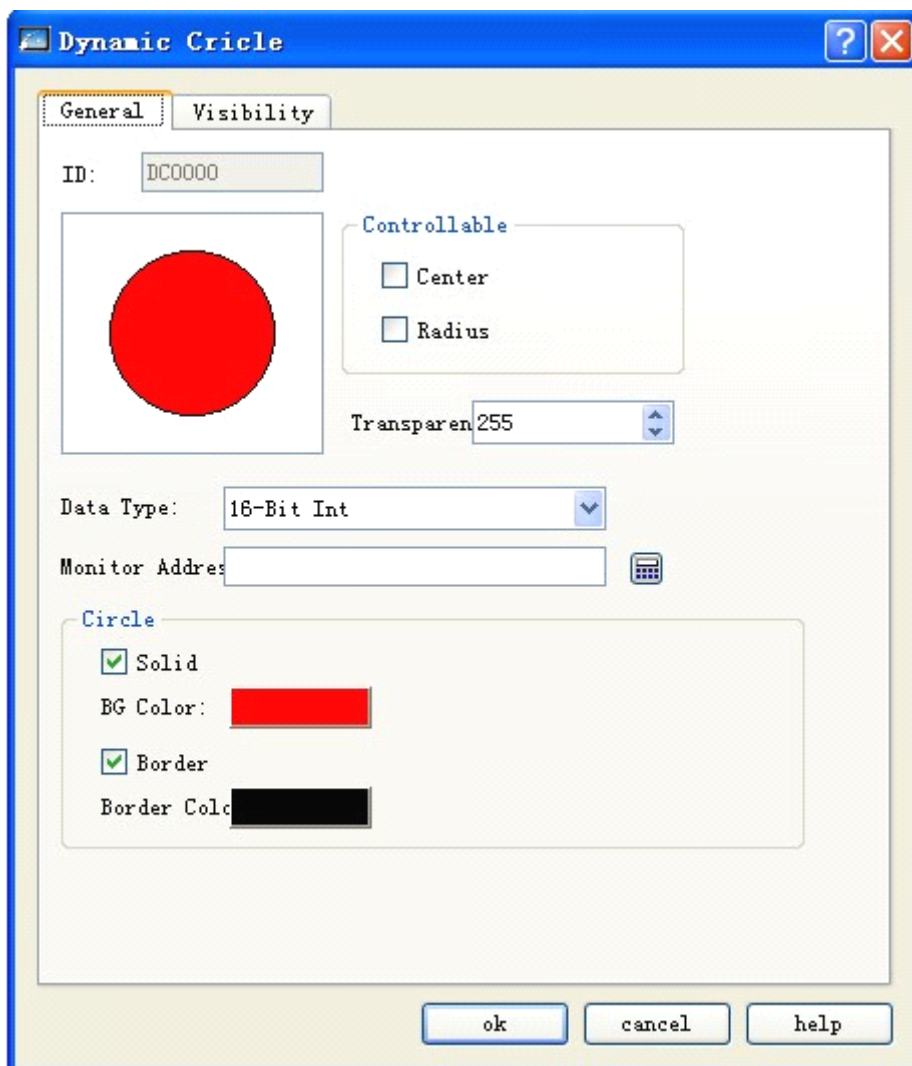

Figure 4-61: Dynamic circle dialog

This control reads values of three addresses to define X-coordinate, Y-coordinate and radius of the circle. Reading of these values should be based on the data type set by the user.

- Controllable:

Only Center is chosen: The circle moves along with the change of the position of the center, with the radius being unchanged.

Only Radius is chosen: The circle changes along with the change of the radius, with the center being unchanged.

Both Center and Radius is chosen: Not only the radius of the circle changes along with the value of the monitored address, the X-coordinate and Y-coordinate of the center changes along with the values of the monitored addresses.

- Transparency: Change the transparency of the background color of the dynamic circle control.

- Solid:

If this option is not checked, the circle will be a hollow circle without background color; if this option is checked, the circle will be filled with the background color defined in BG Color option.

- Border:

If this option is not checked, the circle will have no border line and thus the border line color cannot be changed; If this option is checked, the circle will have border line and the border color can be changed through the Border Color option below.

For example:

If the Data Type chosen by the user is “16-digit positive integer”, then the control can read continuously three data from the monitored address according to the address rule of the PLC, which respectively indicates X-coordinate of circle center, Y-coordinate of circle center and radius of the circle. If the monitored address is LW1, then the values of LW1, LW2 and LW3 will be read, respectively with the following meanings:

The value of LW1 is the X-coordinate of the circle center;

The value of LW2 is the Y-coordinate of the circle center;

The value of LW3 is the radius of the circle.



The touch screen will read from three addresses no matter whether Center and/or Radius option is checked, and the meanings of these addresses remain the same. For example, if only Radius is chosen, and the monitored address is LW1, then the value of LW3 controls the radius of the circle.

If the Data Type chosen by the user is “32-digit positive integer”, and the monitored address is LW1, then the values of LW1, LW3 and LW5 will be read, respectively with the following meanings:

The value of LW1 is the X-coordinate of the circle center;

The value of LW3 is the Y-coordinate of the circle center;

The value of LW5 is the radius of the circle.

Thus, if the chosen Data Type is “32-digit positive integer”, the control can read three data from the monitored address (adding 2 to the address each time) according to the address rule of the PLC, which respectively indicates X-coordinate of circle center, Y-coordinate of circle center and radius of the circle.



Refer to Bit Button control for the use of Visibility tab.

4.4.6 Dynamic rectangle of SKWorkshop

With similar functions to Dynamic Circle, Dynamic Rectangle is also used to change the position and size of the graph basing on the change in the value of the monitored address, and thus to show real-time change of the monitored address on a dynamic basis.

Click Dynamic Rectangle icon  in the tool bar, and then a dialog as shown in Figure 4-62 will appear.

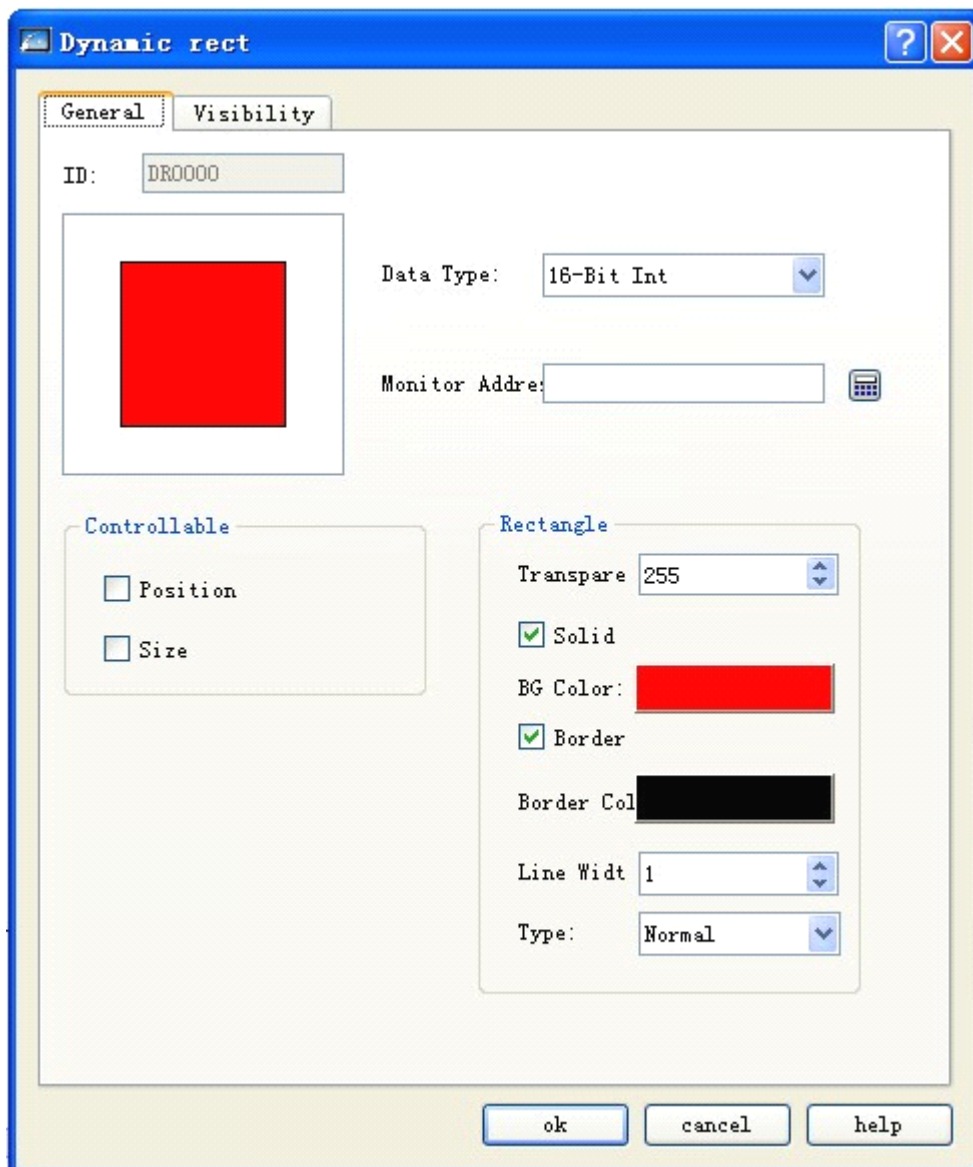

Figure 4-62: Dynamic rectangle dialog

This control reads values of four addresses to respectively define X-coordinate, Y-coordinate, width and height of the rectangle. Reading of these values should be based on the data type set by the user.

Line width: Change the width of the line.

Category: Three categories are available, i.e. right angle, cut-off angle and round angle.

Remark: Take effect only when the line width is higher than 1.

- For example:

If the Data Type chosen by the user is “16-digit positive integer”, and the monitored address is LW1, then the values of LW1, LW2, LW3 and LW4 will be read, respectively with the following meanings:

The value of LW1 is the X-coordinate of the rectangle;

The value of LW2 is the Y-coordinate of the rectangle;

The value of LW3 is the width of the rectangle.

The value of LW4 is the height of the rectangle.

Thus, if the chosen Data Type is “16-digit positive integer”, the control can read four data continuously from the monitored address according to the address rule of the PLC, which respectively indicates X-coordinate of the rectangle, Y-coordinate of the rectangle, width of the rectangle and height of the rectangle.

If the Data Type chosen by the user is “32-digit positive integer”, and the monitored address is LW1, then the values of LW1, LW3, LW5 and LW7 will be read, respectively with the following meanings:

The value of LW1 is the X-coordinate of the rectangle;

The value of LW3 is the Y-coordinate of the rectangle;

The value of LW5 is the width of the rectangle.

The value of LW7 is the height of the rectangle.

Thus, if the chosen Data Type is “32-digit positive integer”, the control can read four data from the monitored address (adding 2 to the address each time) according to the address rule of the PLC, which respectively indicates X-coordinate of the rectangle, Y-coordinate of the rectangle, width of the rectangle and height of the rectangle.

- Controllable:

Only Position is chosen: The width and height of the rectangle does not change with the corresponding values of the monitored address; the position of the rectangle changes with the corresponding values of the monitored address.

Only Size is chosen: The width and height of the rectangle changes based on the anchor point defined, with the position remaining unchanged. The meaning of the four anchor points is as follows:

Upper left: The upper left corner of the rectangle is fixed, and the size of the rectangle changes towards the lower right corner.

Upper right: The upper right corner of the rectangle is fixed, and the size of the rectangle changes towards the lower left corner.

Lower left: The lower left corner of the rectangle is fixed, and the size of the rectangle changes towards the upper right corner.

Lower right: The lower right corner of the rectangle is fixed, and the size of the rectangle changes towards the upper left corner.

- Solid:

If this option is not checked, the rectangle will be a hollow rectangle without background color; if this option is checked, the rectangle will be filled with the background color defined in BG Color option.

- 1 Border:

If this option is not checked, the rectangle will have no border line and thus the border line color cannot be changed; if this option is checked, the rectangle will have border line and the border color can be changed through the Border Color option below.

- Transparency: Change the transparency of the background color of the dynamic circle control.



Refer to Bit Button control for the use of Visibility tab.

4.4.7 Alarm control of SKWorkshop

Alarm Control can display current alarm information of the equipment (digital alarm and analog alarm). Before using this control, you must configure alarm settings. Refer to Alarm Setting for configuration of “alarm settings”.

Alarm Control can store real-time alarm information and the number of alarms to be displayed is defined during configuration. SKWorkshop supports digital alarm information.

The steps to insert Alarm Control are as follows:

- Click Alarm Control command in Tool menu or click Alarm Control button  in the tool bar, and then a dialog as shown in Figure 4-63 will appear.
-

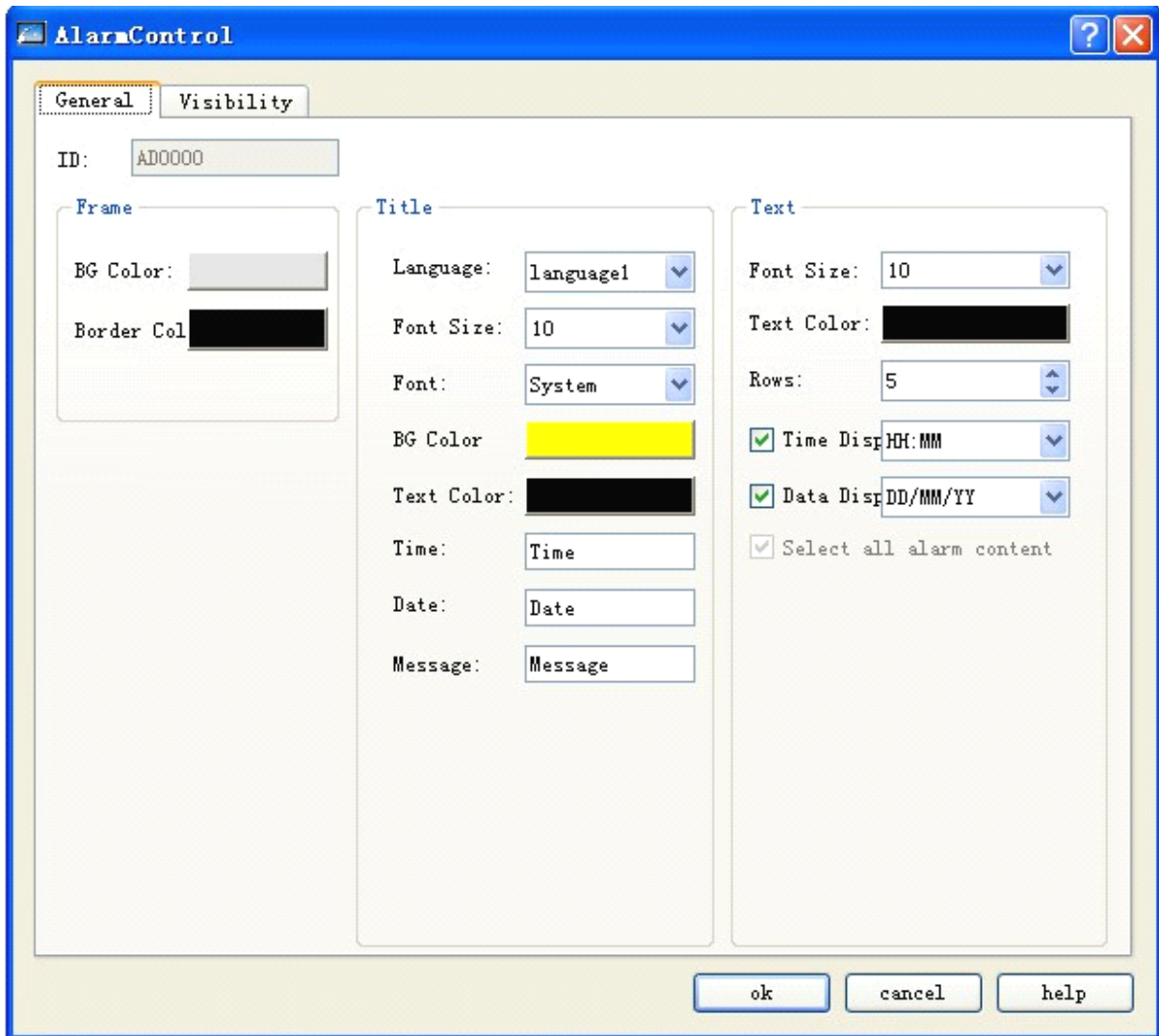

Figure 4-63: Alarm display dialog

- In this dialog you can set color and size of the display box, pattern and color of grid, and time, font and color of title. You can also set alarm text size, color and row number in alarm list box. If the Rows are set to 5, the control can display 5 rows of alarm information at the same time. When there is a new alarm, the previous alarm will be replaced.
- Language: For different languages, the font size, font, time, date and message contents may be different, while the background color and text color are the same as the first language.
- Choose all alarming information: If this option is chosen, this alarm display control will display all conforming alarming information in Digital Alarm and Analog Alarm in the Project Manager; otherwise only the specified alarming information chosen by the user will be displayed.
- After setting these parameters, press down the left key of the mouse and drag the mouse to draw an Alarm Control on the screen. See Figure 4-64.

Time	Date	Message

Figure 4-64



: Size of Alarm Control is determined by the number of Rows and the maximum character length of the alarm information. The size and position of Alarm Control can be adjusted using the mouse.



: When the number of alarming messages is more than the line number set, this alarming control will add one line automatically and display the alarming information in the form of rolling texts.



: Refer to Bit Button control for the use of Visibility tab.

4.4.8 Dynamic alarm bar of SKWorkshop

Dynamic Alarm Bar is used to display the current alarm. The difference between Dynamic Alarm Bar and Alarm Control is that the former displays the current alarm information in the form of rolling texts (digital alarm and analog alarm).

If there are 3 alarm at present, Dynamic Alarm Bar will display the first, the second and the third alarm in turn and repeatedly in rolling form, either from left to right or from right to left. The movement speed, movement interval and alarm voice are determined by the related parameters. Refer to “Alarm Bar Setting”. Before using a dynamic alarm bar, you must configure the alarm settings first. Refer to “Alarm Setting”.

➤ The steps to insert a dynamic alarm bar are as follows:

Click Dynamic Alarm Bar command in Tool menu or click button  in the tool bar, and then a dialog as shown in Figure 4-65 will appear.

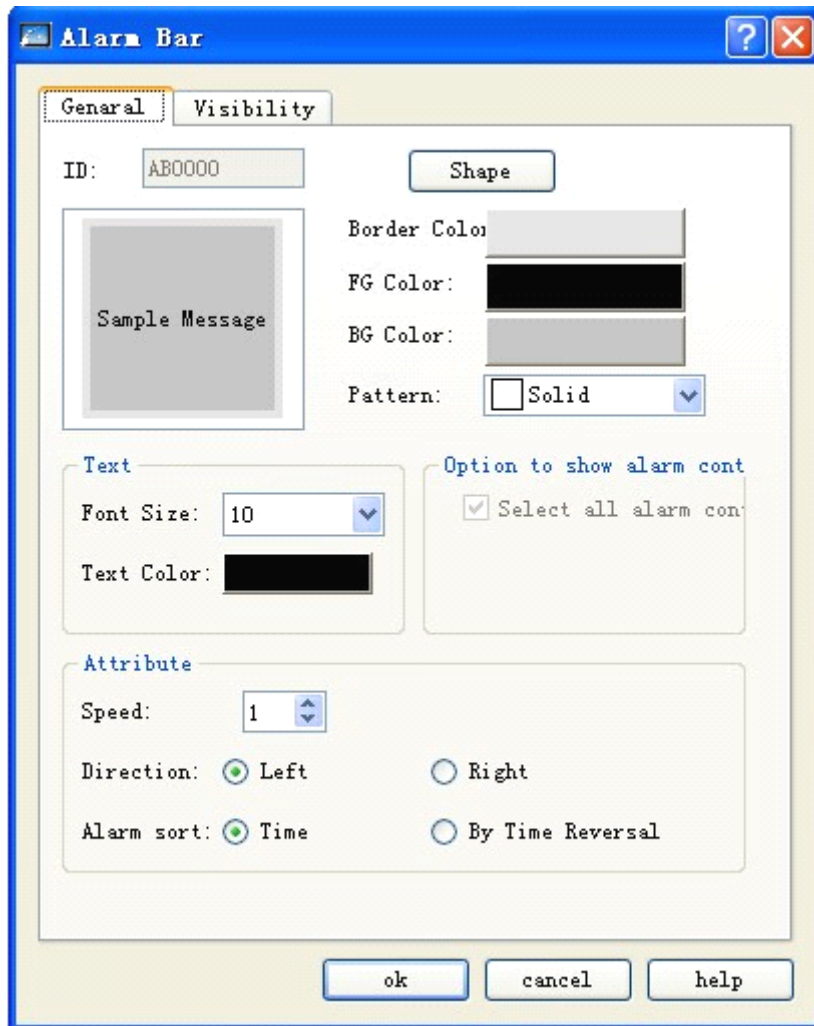

Figure 4-65: Dynamic alarm bar dialog

- Choose all alarming information: If this option is chosen, this alarm display control will display all conforming alarming information in Digital Alarm and Analog Alarm in the Project Manager; otherwise only the specified alarming information chosen by the user will be displayed.
- Font size: Here you can change the word size of the alarm text.
- Text color: Here you can change the word color of the alarm text.
- Speed: Movement speed of the alarm information.
- Direction: Movement direction of the alarm information, either from left to right or from right to left.
- Alarm sort: Display sequence of the alarm information.



Refer to Bit Button control for setting of Shape, Border Color, FG Color, BG Color and Pattern.



If Off-line Simulation is to be called, the Font Size must be "16x16"; if not, other font sizes can be used.



Refer to Bit Button control for the use of Visibility tab.

4.4.9 Historic alarm display of SKWorkshop

The main function of Historic Alarm Display is to display previous alarm information. This control has the same operation steps as Alarm Display, so you can refer to the introduction of Alarm Display for reference. The icon of Historic Alarm Display in the tool bar is . The following dialog will pop up after clicking this button:

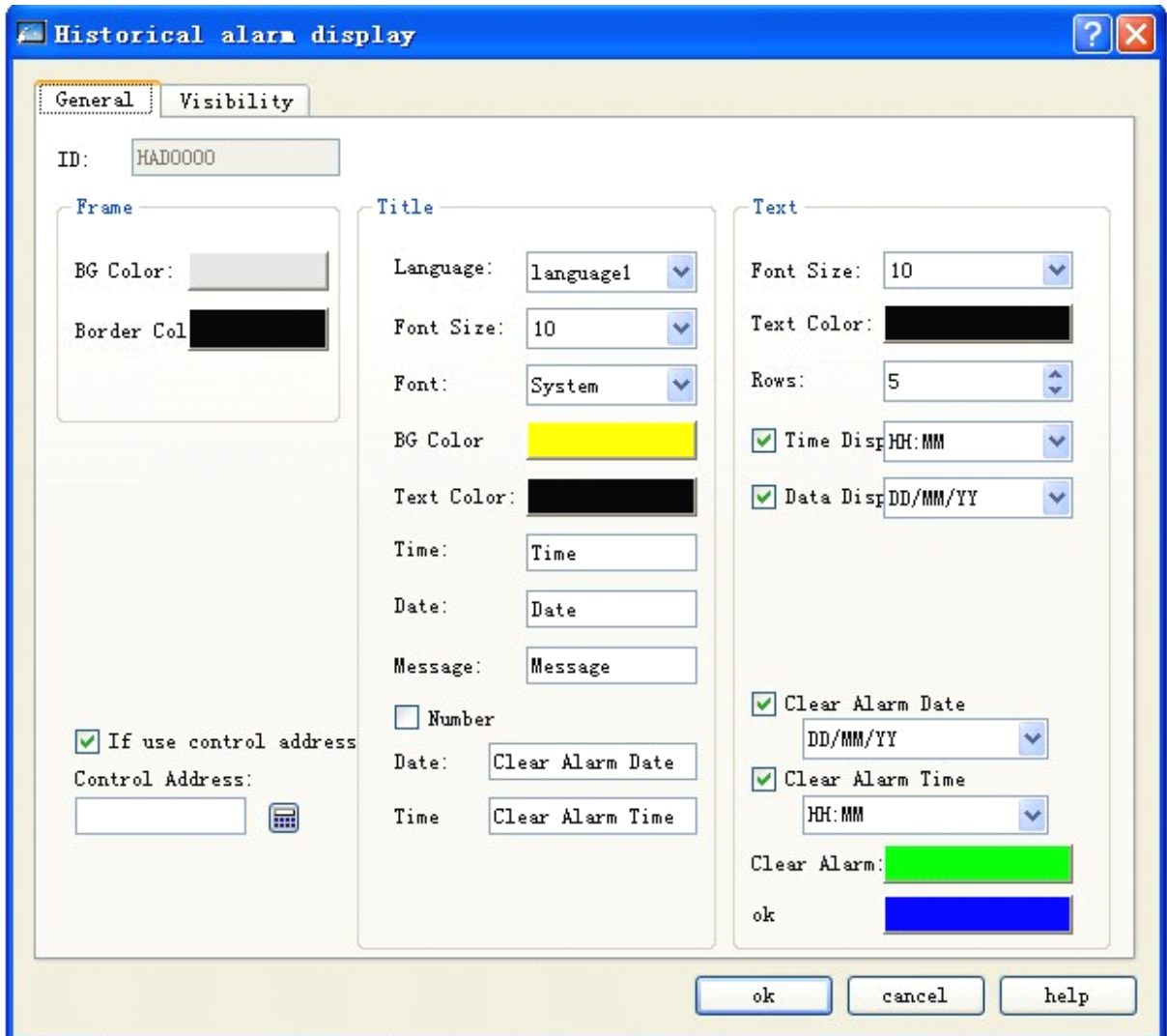

- Use control address:

This address occupies 12 consecutive address offsets. The meaning of each address is as follows:

Address offset	Controlled object of the control register address
0	0 indicates displaying all data, 1 indicates displaying some of the data (time range)

1	Starting time (year)
2	Starting time (month)
3	Starting time (day)
4	Starting time (hour)
5	Starting time (minute)
6	Starting time (second)
7	Ending time (year)
8	Ending time (month)
9	Ending time (day)
10	Ending time (hour)
11	Ending time (minute)
12	Ending time (second)

- Refer to Alarm Display for basic operations.
- Clear Alarming Date: Clear the date of the alarm.
- Clear Alarming Time: Clear the time of the alarm.
- Clear Alarm: Clear the line of the alarm message, and use this color to indicate alarm.
- Confirm: Use this color to indicate alarm.



Refer to Alarm Display control for the basic operations.



Refer to Bit Button control for the use of Visibility tab.

4.4.10 Graphics move of SKWorkshop

Graphics move control is used to make a picture from the library or graph files move in specified direction basing on linked variables or trigger variables. With this control you can realize animation effect on the screen.

The steps to insert Graphics Move control and modify its properties are as follows: Click Graphics Move button  in the tool bar, set parameters in the pop-up dialog and then click OK. See Figure 4-66.

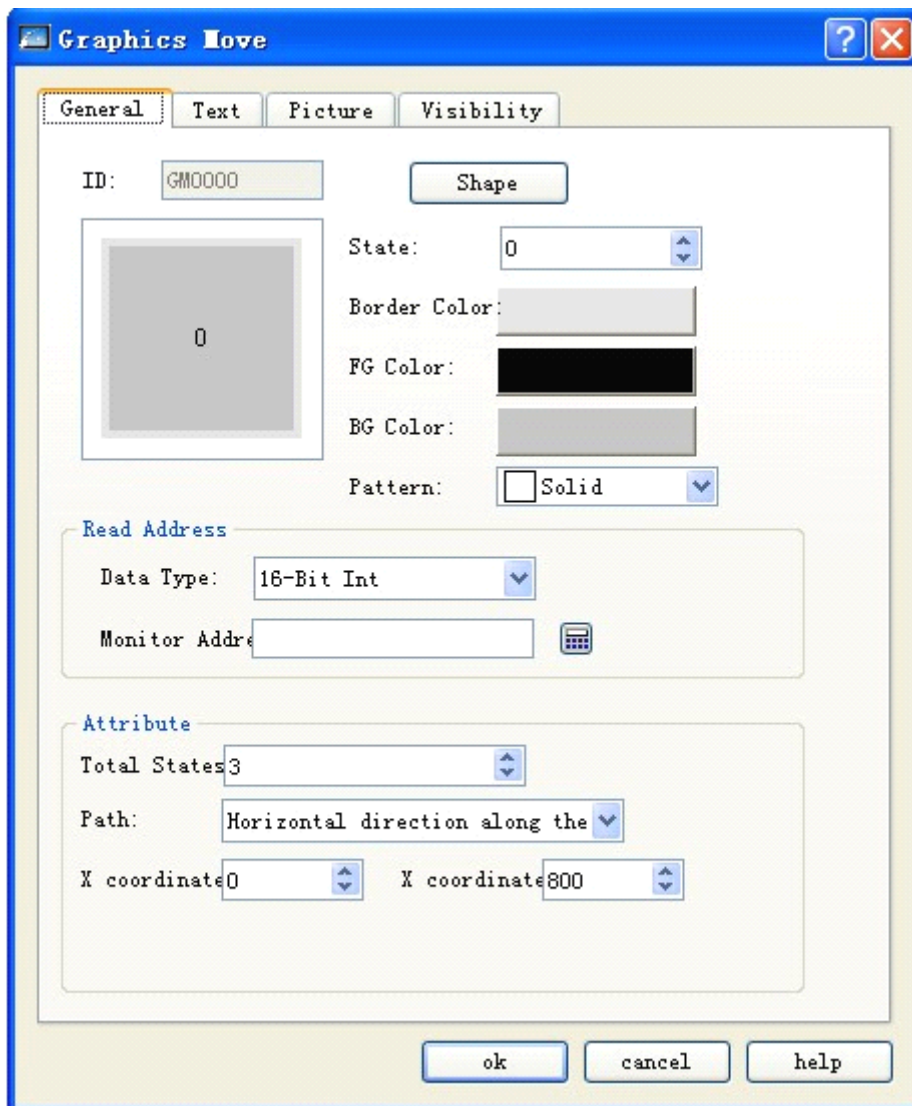

Figure 4-66: Graphics move dialog

- Picture selection:

Choose in Picture tab a picture from the library or a user-defined picture.

- Monitor address:

Monitored address linked with Graphics Move. Three addresses are occupied, respectively corresponding to change of total states, X-axis value and Y-axis value. For example, if the monitor address set is LW1 and the data type is 16-digit number, then the monitor address for total states is LW1, that for X-axis is LW2 and that for Y-axis is LW3 (that is change in the value of LW1, LW2 and LW3 can respectively control the total states, movement along X-axis and movement along Y-axis). If the data type is 32-digit, then the monitor addresses for total states, X-axis and Y-axis are respectively LW1, LW3 and LW5.

- Path: If the monitor address is internal storage address LW1 and the data type is 16-digit, then:

- ◆ Horizontal moving along the X-axis: The graph moves in horizontal direction only, and the movement range should be between the X Coordinate Floor and the X Coordinate Ceiling. The total states are the value of LW1, and the X coordinate is the value of LW2.

- ◆ Vertical moving along the Y-axis: The graph moves in vertical direction only, and the movement range should be between the Y Coordinate Floor and the Y Coordinate Ceiling. The total states are the value of LW1, and the Y coordinate is the value of LW2.
- ◆ Moving along both X and Y axis: The graph moves in both horizontal and vertical direction, the movement range along X axis should be between the X Coordinate Floor and the X Coordinate Ceiling, and the movement range along Y axis should be between the Y Coordinate Floor and the Y Coordinate Ceiling. The total states are the value of LW1, the X coordinate is the value of LW2, and the Y coordinate is the value of LW3.
- ◆ Proportional horizontal moving along the X axis: The graph moves in horizontal direction only, and the movement range should be between the X Coordinate Floor and the X Coordinate Ceiling. The total states are the value of LW1, and the X coordinate is the value of LW2.
- ◆ Proportional vertical moving along the Y-axis: The graph moves in vertical direction only, and the movement range should be between the Y Coordinate Floor and the Y Coordinate Ceiling. The total states are the value of LW1, and the X coordinate is the value of LW2.
- ◆ Proportional reverse horizontal moving along the X axis: The graph moves in horizontal direction only, and the movement range should be between the X Coordinate Floor and the X Coordinate Ceiling. The total states are the value of LW1, and the X coordinate is the value of LW2.
- ◆ Proportional reverse vertical moving along the Y-axis: The graph moves in vertical direction only, and the movement range should be between the Y Coordinate Floor and the Y Coordinate Ceiling. The total states are the value of LW1, and the X coordinate is the value of LW2.



Refer to the introduction of Multi-state Lamp control for setting of Text and Picture tabs.



Refer to Bit Button control for the use of Visibility tab.



The position of graphics move can be controlled through the value of the last two digits of the monitor address.



Maximum X/Y coordinate is the maximum size of the screen.

4.4.11 Meter of SKWorkshop

Meter control can display the value of the current linked variable using a pointer (needle). Generally, a meter is a semicircle or circle. Use of meter helps to show variables visually.

The steps to insert Meter control and modify its properties are as follows:

1. Click Meter control icon  in the tool bar, and then a dialog as shown in Figure 4-67 will appear.

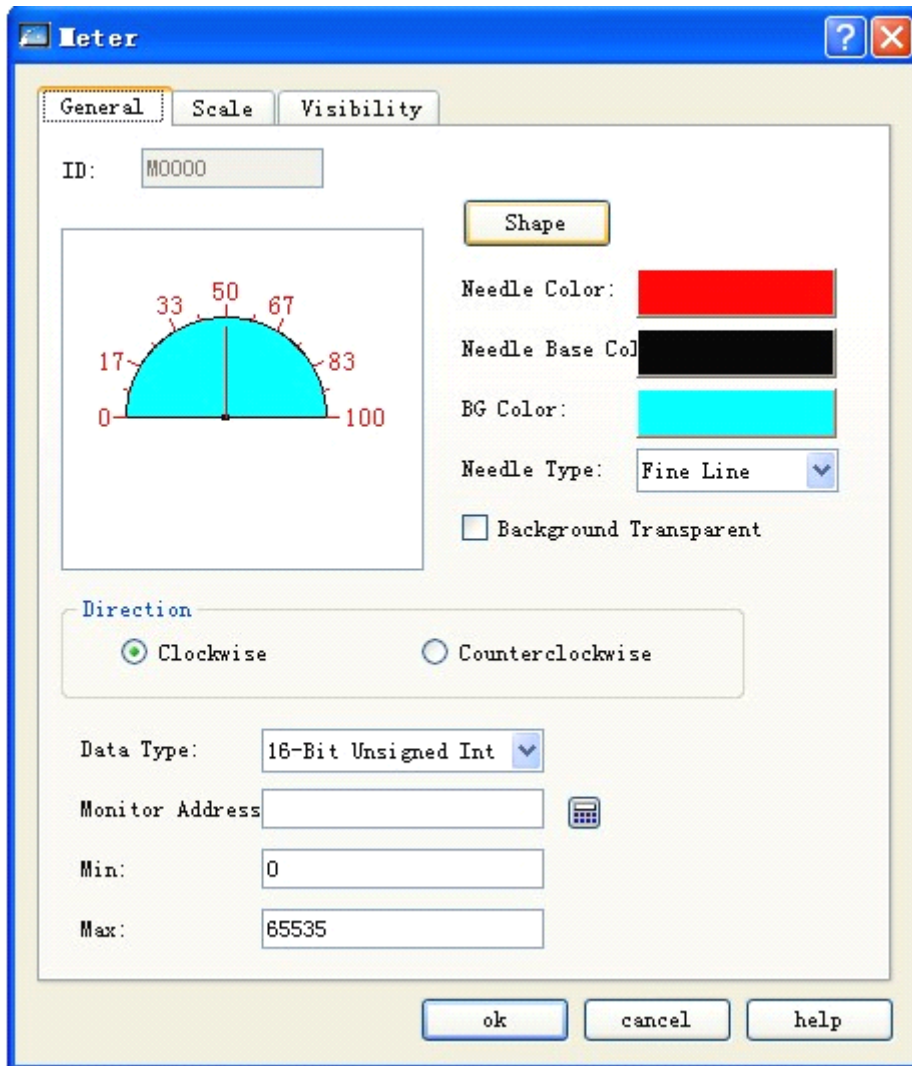

Figure 4-67: Meter dialog

- Needle Color: Here you can change the color of the pointer.
- Needle Base Color: Here you can change the color of the pointer base.
- BG Color: Here you can change the background color.
- Transparent background: Set transparent background for the control.
- Pointer type: There are four options, those are thin straight line, thick straight line, diamond and triangle.
- Direction: Here you can choose clockwise or counterclockwise movement of the pointer.
- Data Type: Here you can choose different data types according to actual needs.
- Monitor Address: An address, the value of which will be displayed in the meter and pointed by needle.
- Max: Maximum value of the monitor address allowed.
- Min: Minimum value of the monitor address allowed.

2. Click the Scale tab to set scale properties. See Figure 4-68.

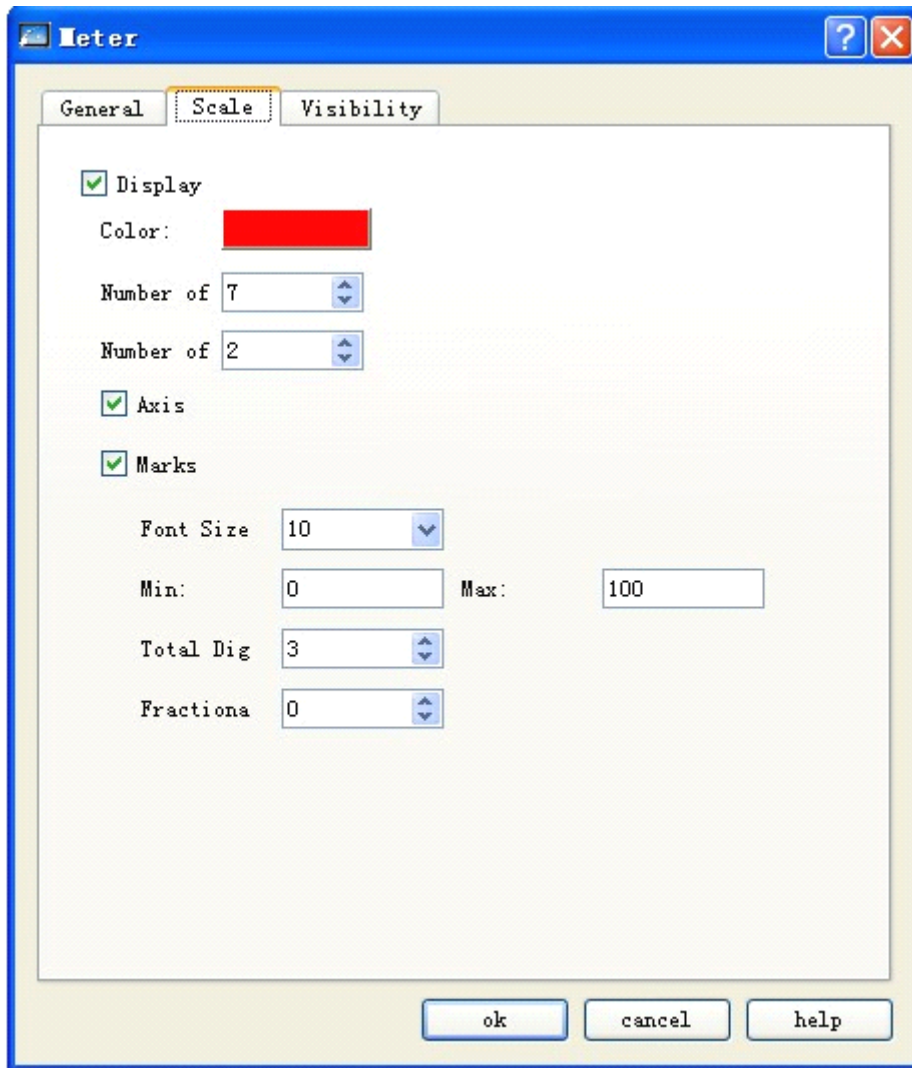

Figure 4-68: Scale tab of meter

In this tab, you can set scale color, number of main scales, number of sub-scales, whether to display axis, whether to display marks, and the like.

3. In screed edit area, press down left key of the mouse and drag the mouse to draw a Meter control. See Figure 4-69 for an example of Meter.

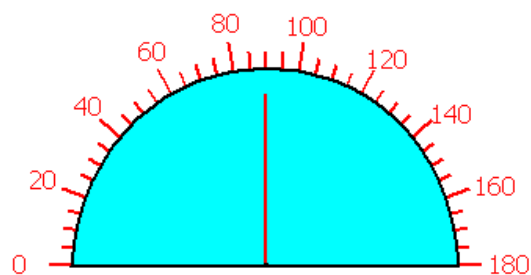

Figure 4-69

4. Choose the Meter graph, and then you can move the mouse to any of the 8 small green dots on the graph to change the size of the control, or double click the control to modify the properties of the Meter.



Meter control has fixed width/height ratio, so when you adjust the size of the control the width and the height change simultaneously.



Refer to Bit Button control for the use of Visibility tab.

4.4.12 Historical data display of SKWorkshop

In actual use, some data generated by PLC or other connected devices may change all the time, such as alarm information. Sometimes we need to view some historical data, and in **SKWorkshop** we can do this using the Historic Data Collector.

SKWorkshop provides a collector of historical data, and you can enter Historic Data Collector dialog in the Project Manager. If the project is a new project, you need to right click the “Historic Data Collector” and choose “Add a Historic Data Collector” option. After that, double click it to enter Historic Data Collector dialog. Refer to Chapter VI for detailed introduction of the Historic Data Collector.

Click Historic Record Display button  in the tool bar, and then a dialog as shown in Figure 4-70 will appear.

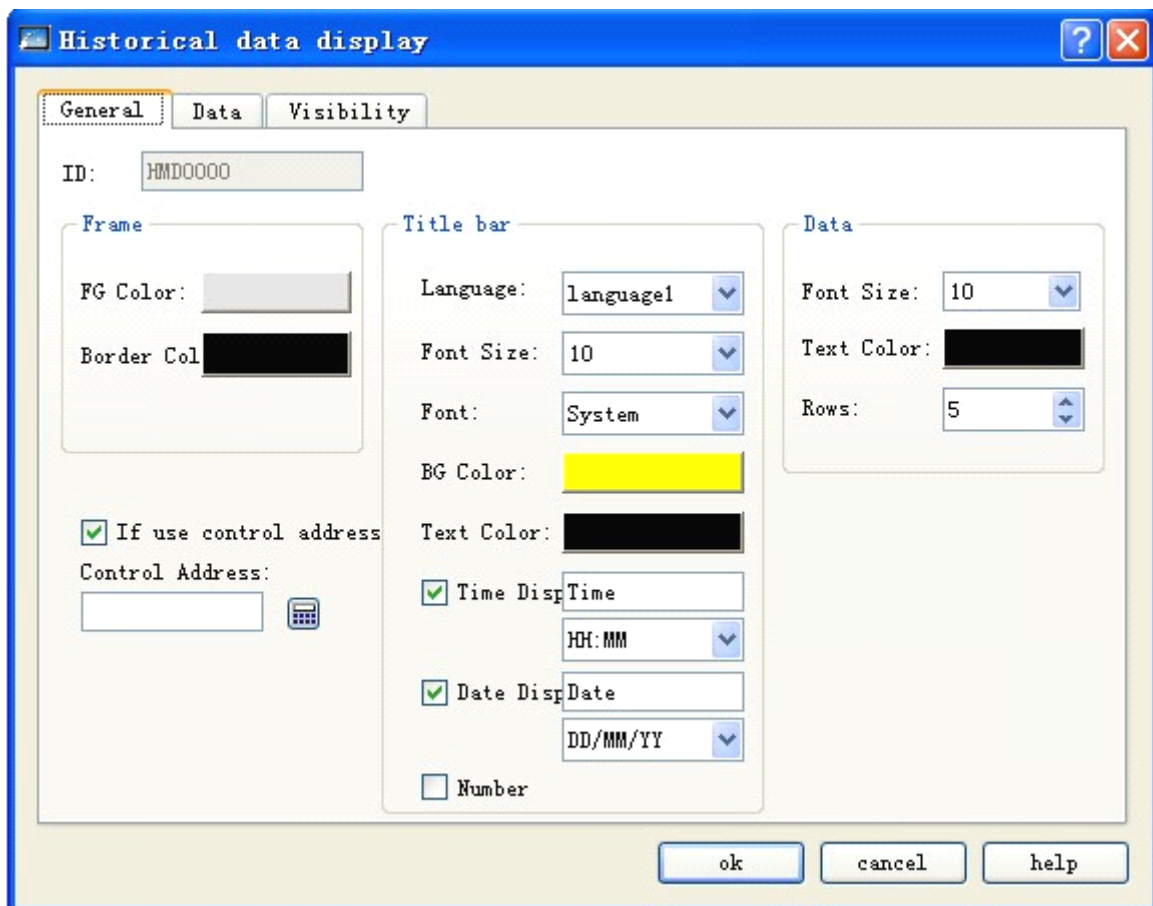

Figure 4-70: Historic record display dialog

- General tab

- FG Color: Click the color in the box to change the foreground color of the Display.
- Border Color: Click the color in the box to change the border color of the Display.
- Grid: Define whether to display grids, and the color of grids.

Vertical: If this option is checked, vertical grids will be displayed (indicated by a green tick in front, if no indicated no display).

Horizontal: If this option is checked, horizontal grids will be displayed (indicated by a green tick in front, if no indicated no display).

- Title Bar: Here you can set Font Size, Font, BG Color, Text Color and whether to display time and date. Refer to the language functions of Alarm Display for the language related options.
- Data: Here you can set Font Size, Text Color and maximum Rows.
- Use control address:

This address occupies 12 consecutive address offsets. The meaning of each address is as follows:

Address offset	Controlled object of the control register address
0	0 indicates displaying all data, 1 indicates displaying some of the data (means that the starting/ending time restriction will take effect)
1	Starting time (year)
2	Starting time (month)
3	Starting time (day)
4	Starting time (hour)
5	Starting time (minute)
6	Starting time (second)
7	Ending time (year)
8	Ending time (month)
9	Ending time (day)
10	Ending time (hour)
11	Ending time (minute)
12	Ending time (second)

- Data tab

Checked columns will be displayed (indicated by a green tick in the box if no indicated no display).



Refer to Bit Button control for the use of Visibility tab.

4.4.13 Message display of SKWorkshop

Functions of Message Display are similar to the functions of Multi-state Lamp, except that Message Display control has more total states, up to 128 states. The icon of this control in the tool bar is . Click this button, and then a dialog as shown in Figure 4-71 will appear.

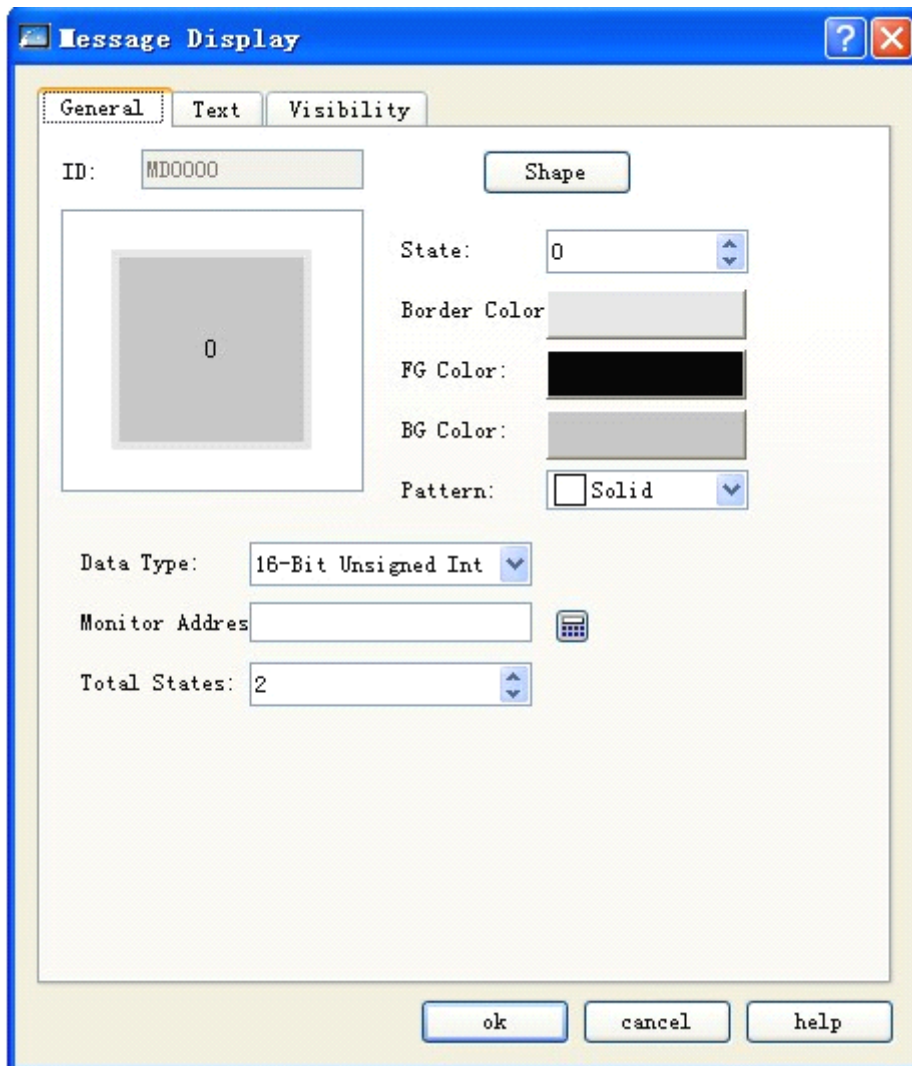

Figure 4-71: General tab of message display

The text tab of Message Display is shown in Figure 4-72.

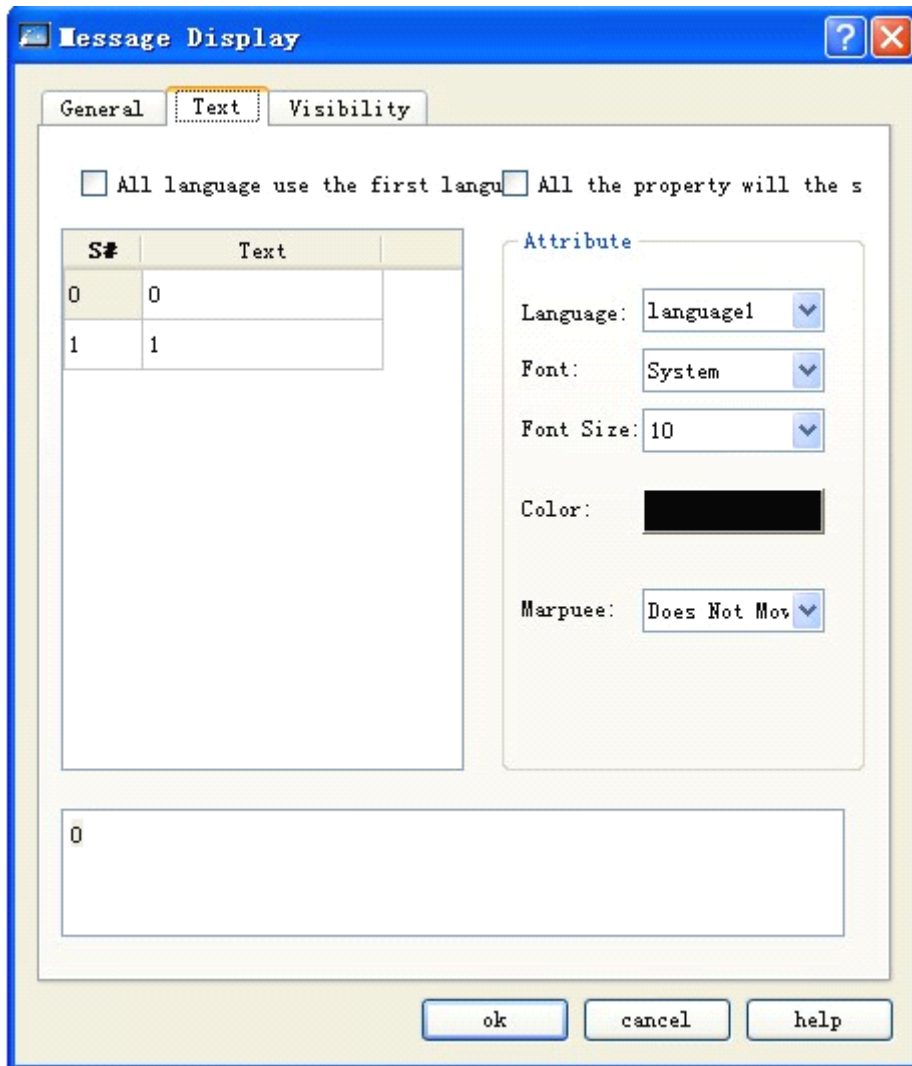



Figure 4-72: Text tab of message display

- Refer to the Multi-state Lamp for setting of language, font, font size and color.
- Movement: There are three choices in this option, those are no movement, left movement and right movement.
 - No movement: The text will be displayed still in the center of the screen.
 - Left movement: The text will be moved left by n pixels at the Speed value (for example n) set by the user.
 - Right movement: The text will be moved right by n pixels at the Speed value (for example n) set by the user.



Refer to Multi-state Lamp control for parameter setting of Message Display.

4.4.14 Flow block of SKWorkshop

Flow Block is used to simulate in animated pictures the fluid flow status in pipeline. Whether a flow block is flowing is determined by the state of the trigger bit: when the trigger bit is 1, the flow block is flowing; when the trigger bit is 0, the flow block is static. The flowing speed is specified by user. Click button  in the toolbar, and then the General tab of flowing block will pop up, as shown in the figure below:

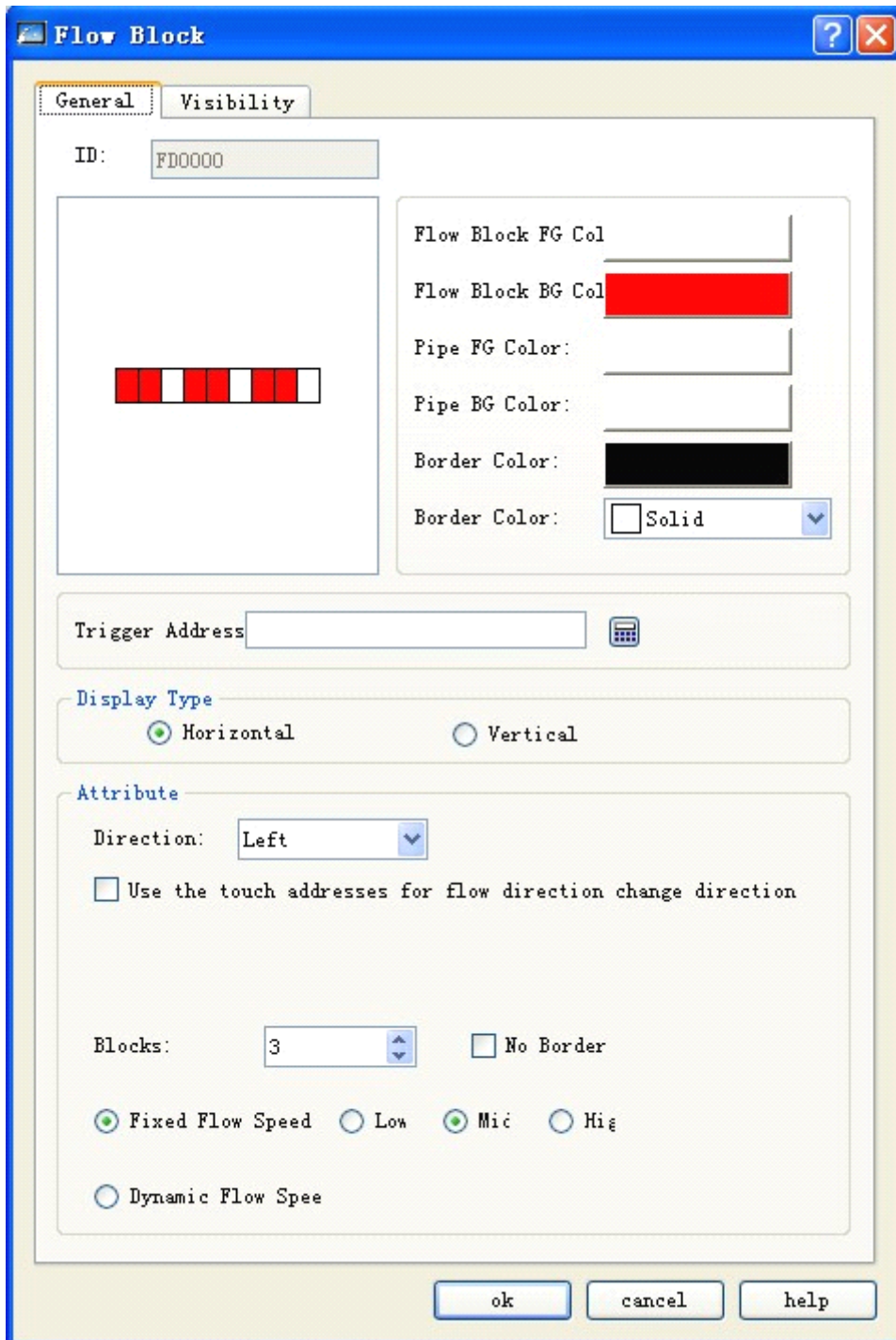

Color: Here you can set the color of the flow block.

- Flow Block FG Color: Click here to set the foreground color of the flow block.
- Flow Block BFG Color: Click here to set the background color of the flow block.
- Pipe FG Color: Click here to set the foreground color of the pipe.
- Pipe BG Color: Click here to set the background color of the pipe.

- Border Color: Click here to set the color of the border of the Flow Block control.
- Pattern: Click here to choose a pattern for the Flow Block. Pure color by default.
- Trigger address: The address that triggers flowing of the Flow Block. When the value of this address is 1, the Flow Block is flowing.

Attribute: Here you can set attributes of the Flow Block, such as direction and flow speed.

- Display type: If Horizontal option is checked, the flow block flows horizontally; if Vertical option is checked, the flow block flows vertically.
- Direction: When the Display Type is Horizontal, you can choose Left or Right for this option; When the Display Type is Vertical, you can choose Up or Down for this option.
- Use touch address to change the flow direction to reverse; if the value of the Touch Address is the same as the value of the Valid State set by the user, the flowing direction of the flowing block will be changed to the opposite direction to the Flowing Direction.

For example, if the Flowing Direction set by the user is Left, this option is chosen, the Touch Address is LB2, and the Valid State is 1, then: when the value of LB2 is 1, the flowing direction of the flowing block is changed to “right” and when the value of LB2 is 0 the flowing direction is changed back to “left”.

- Blocks: “Blocks” refer to the quantity of the flow units, from 1 to 30.
- No border: When this option is checked, the border of the Flow Block will be hidden.
- Flowing speed: The choices include fixed flowing speed and dynamic flowing speed.

Fixed flowing speed: Three flowing speeds are available, that is Fast, Normal and Slow. This speed is set by the manufacturer as a default.

Dynamic flowing speed: This speed is depending on a word address, and the value of the address is only valid between 1 and 10. When the value of the address is 0, the flowing block will not move; when the value is 1, the flowing block flows at the maximum speed; when the value is 10, the block flows at the minimum speed.

- Refer to Bit Button control for the use of Visibility tab.

4.4.15 Timer of SKWorkshop

Timer is a control that triggers specified function basing on time conditions. In SKWorkshop V4.0, timer is used as a control for trigger of macros. Create a new Timer or double click an existing Timer  to enter the property dialog.

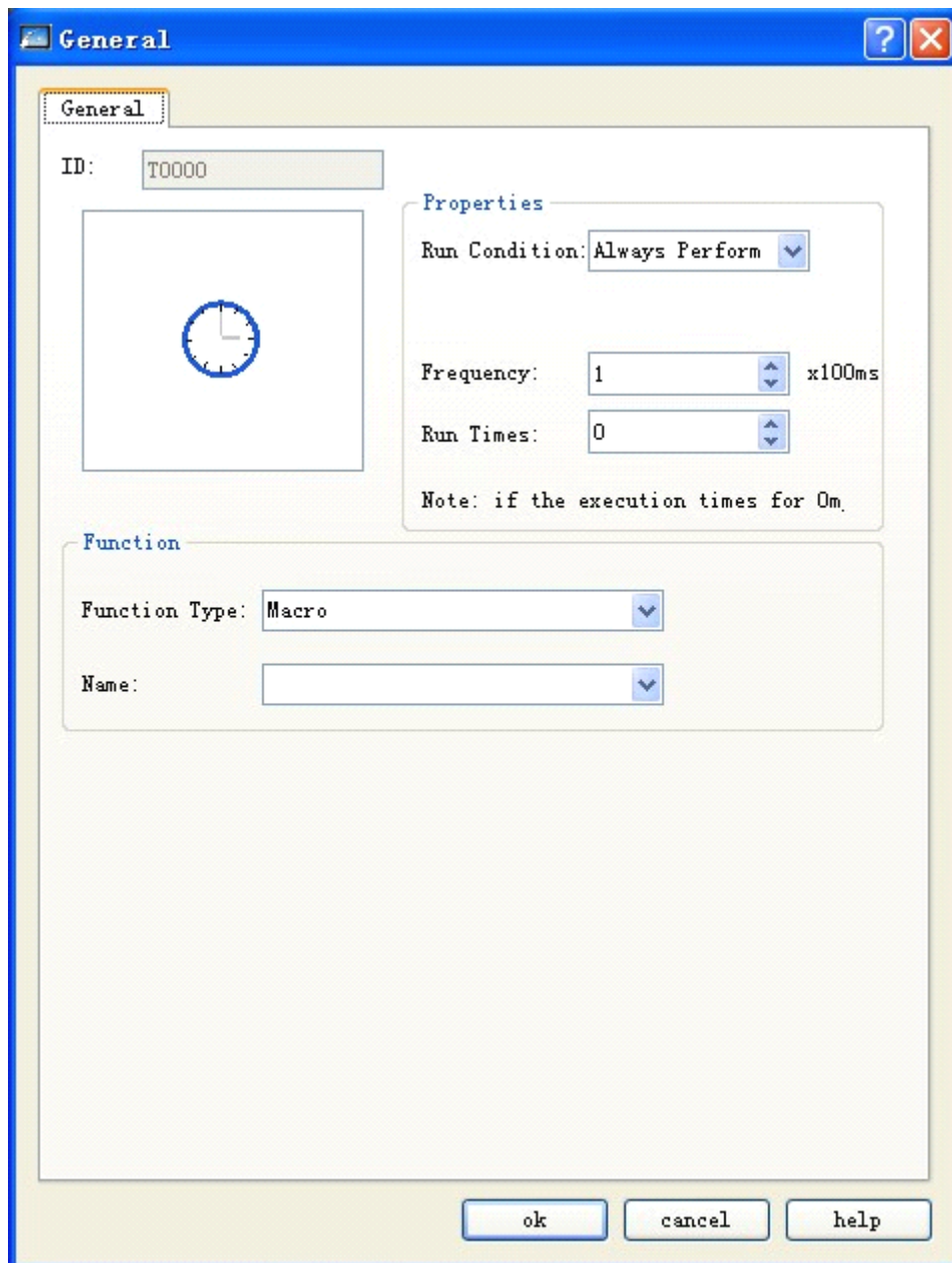

Control

Run Conditions: Here you can set run conditions for macros, either Always Perform or Address Triggered.

1. “Always Perform”: If this option is chosen, the macros will be always executed in specified frequency.
2. “Address Triggered”: If this option is chosen, then the macros will be executed when the value of the specified bit is 1, and will not be executed when the value is 0.

Address: When “Address Triggered” option is chosen, there will be a box for address entering. Enter here the bit that controls the macro, so that when the value of this bit is 1, the macro will be executed.

Frequency: Execution frequency of the chosen macro, from 0.1 to 60s.

Run times: This option defines how many times the macro will be run. If 0 is set here, the macro will be always executed.

Function

Function Type: Here you can choose the type of the function to be executed. In SKWorkshop V4.0 the function controlled by Timer is macro.

Name: Name of the macro to be executed. No Timer can be set if there is no macro at present.



The size of Timer cannot be changed, but its position can be set. Timer control will not be displayed on HMI during project execution.

4.4.16 Data transfer of SKWorkshop

Data Transfer is used for transfer of data between PLC and HMI or between PLC and PLC. Click Data Transfer in Project Manager, and the current data transfer list will appear.

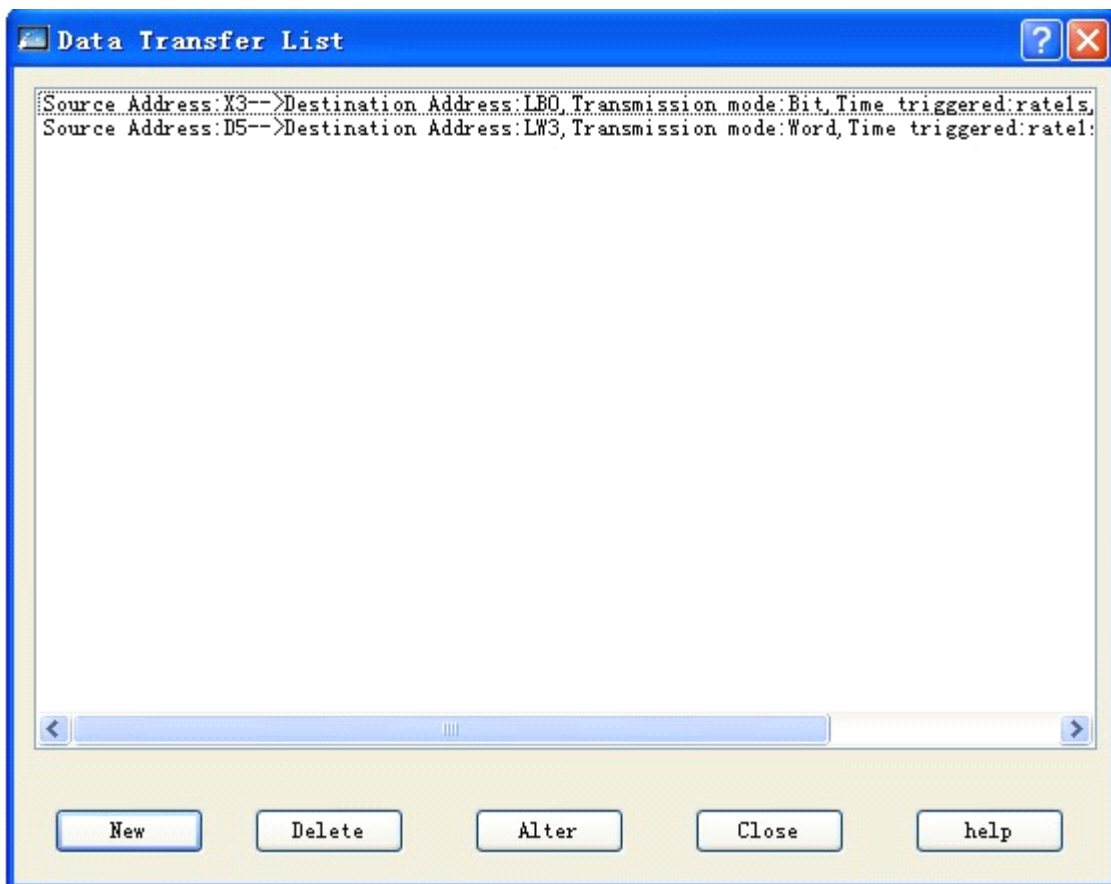

This list shows the details of all current data transfers, and you can carry out New, Delete and Alter operations. **SKWorkshop V4.0** supports up to 64 data transfers at the same time.

Create a new Data Transfer or double click an existing Data Transfer to enter the property dialog:

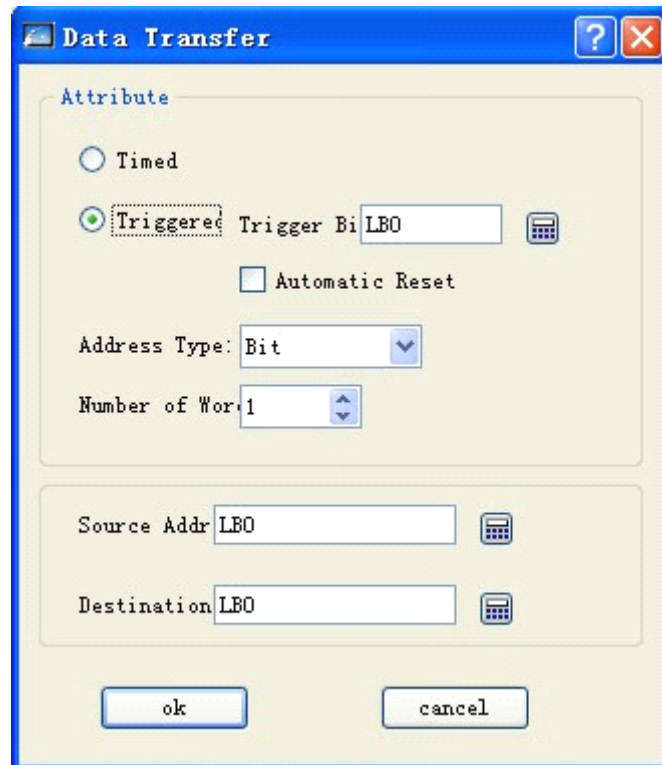

1. Attribute:

Timed/Triggered: Here you choose the trigger manner of data transfer.

Timed: The data will be transferred basing on specified time interval.

Triggered: Data transfer will be triggered by specified address, i.e. triggered when the value of trigger bit is 1.

Automatic resetting: When the address value of the trigger bit is 1, this value will be automatically changed to 0.

Address Type: Here you choose the address type for data transfer, including bit/word/double word.

Number of Word/Bit: Here you enter the length of the data to be transferred, from 1 to 32.

2. Address:

Source Address: Source address of the data transfer. The type of this address must be the same as the address set in Address Type option in Attribute above.

Destination Address: Destination address of the data transfer. The type of this address must be the same as the address set in Address Type option in Attribute above.



The source address and the destination address should not be the same PLC.

4.4.17 Multifunction button of SKWorkshop

Multifunction Button can be used to complete multiple steps of user-defined operations by single control. It helps to simplify user operations and make operation more convenient. Create a new Multifunction Button  or double click an existing Multifunction Button to enter the property dialog.

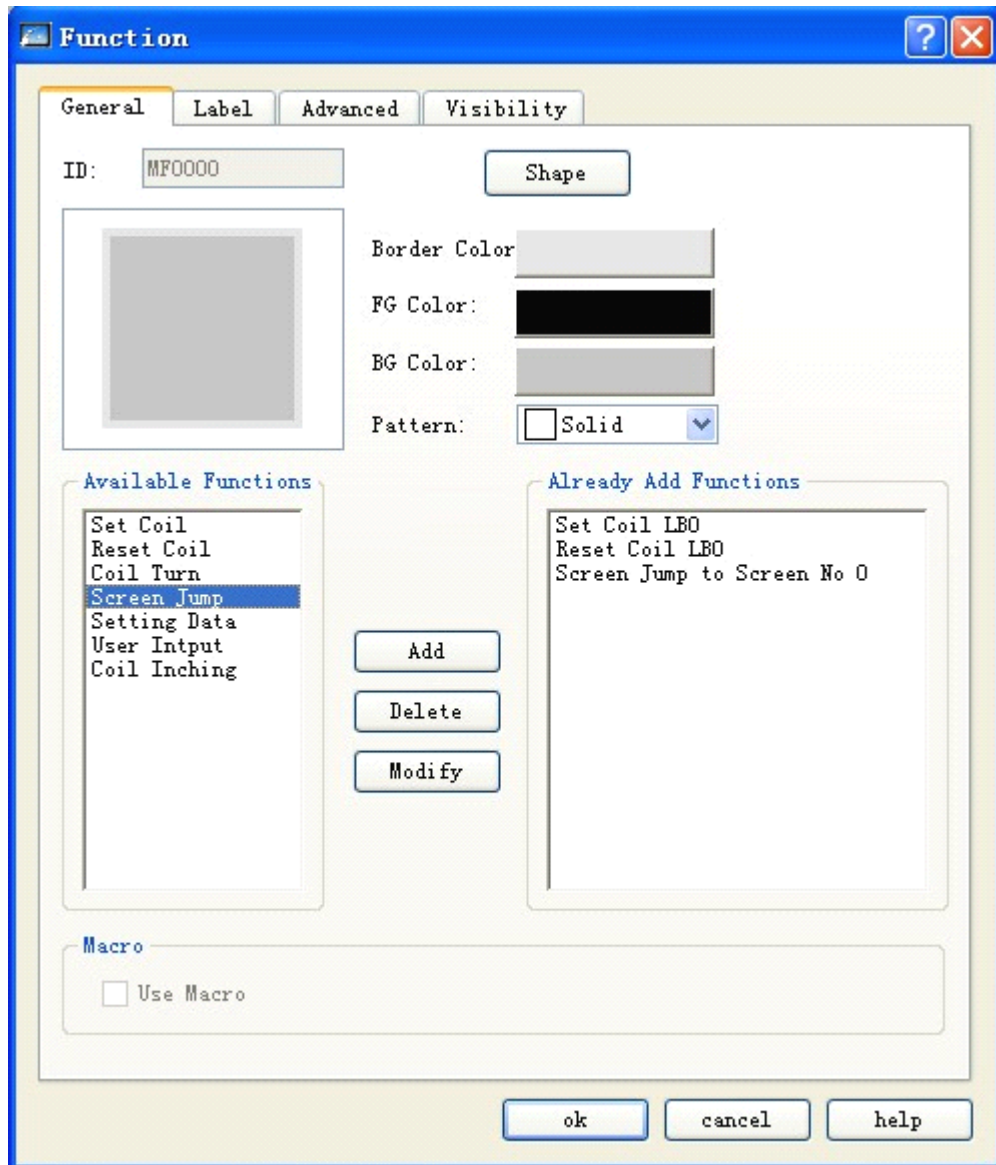

- Function tab

1. Button appearance: Here you can set shape, color and pattern of the button.
2. Available functions: Multiple functions are listed for users to choose, and the chosen function will be executed when the button is pressed.

Set Coil: Set ON the address entered.

Reset Coil: Set OFF the address entered.

Coil Turn: Change the address entered to opposite: If the bit is 0, change it to 1; if it is 1, change it to 0.

Coil inching: Set ON the input address when this is touched, and set OFF when released.

Screen Jump: Jump to the chosen screen. You can choose the target screen by changing this option.

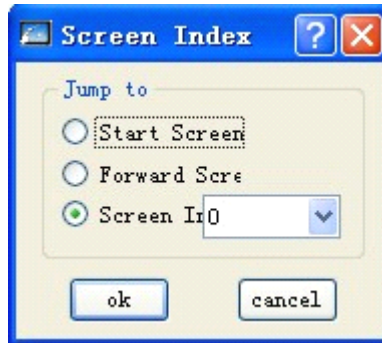

Setting Data: Write the set data to the set address. You can choose Data Type, Write Address and Set Data to be written.

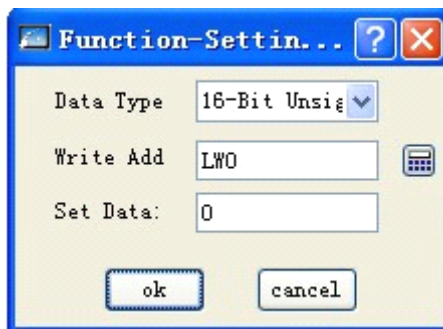

User Input: Input a value and write it to the set address. You can choose Data Type and Write Address. When this function is executed, a data entering dialog will appear, you can enter data of chosen type in the dialog, and then the data will be written to the set address.

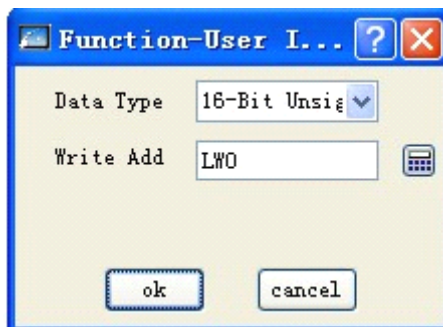

Choose a function, and click Add to add it to the list of chosen functions.

When both User Input and Coil Inching are chosen, only User Input is effective and Coil Inching will not be executed.

3. Functions added

When you choose a function, it is displayed in the Functions Added area. Double click it or click Modify to set or modify it, and click Delete to delete it.

During operation of the configuration, all these function chosen will be executed when the Multifunction Button is pressed.

4. Macro

When Use Macro is chosen, there will be a list of available macros. Choose a macro, and then it will be also executed when the Multifunction Button is pressed.

- Label, Advanced and Visibility tabs
- Refer to Bit Button for introduction of Label, Advanced and Visibility tabs.

4.5 Basic controls of SKWorkshop

This chapter mainly introduces the use of basic controls of SKWorkshop.

4.5.1 Bit button of SKWorkshop

Bit button is used to operation and display the ON/OFF state (or 1/0 state) of the bit address of the device connected to the touch screen. Bit button is a fundamental and the most frequently used control. The steps to set a bit button are as follows:

1. Click Bit Button icon  in the tool bar, and then a dialog will pop up for setting of bit button properties. See Figure 4-73.

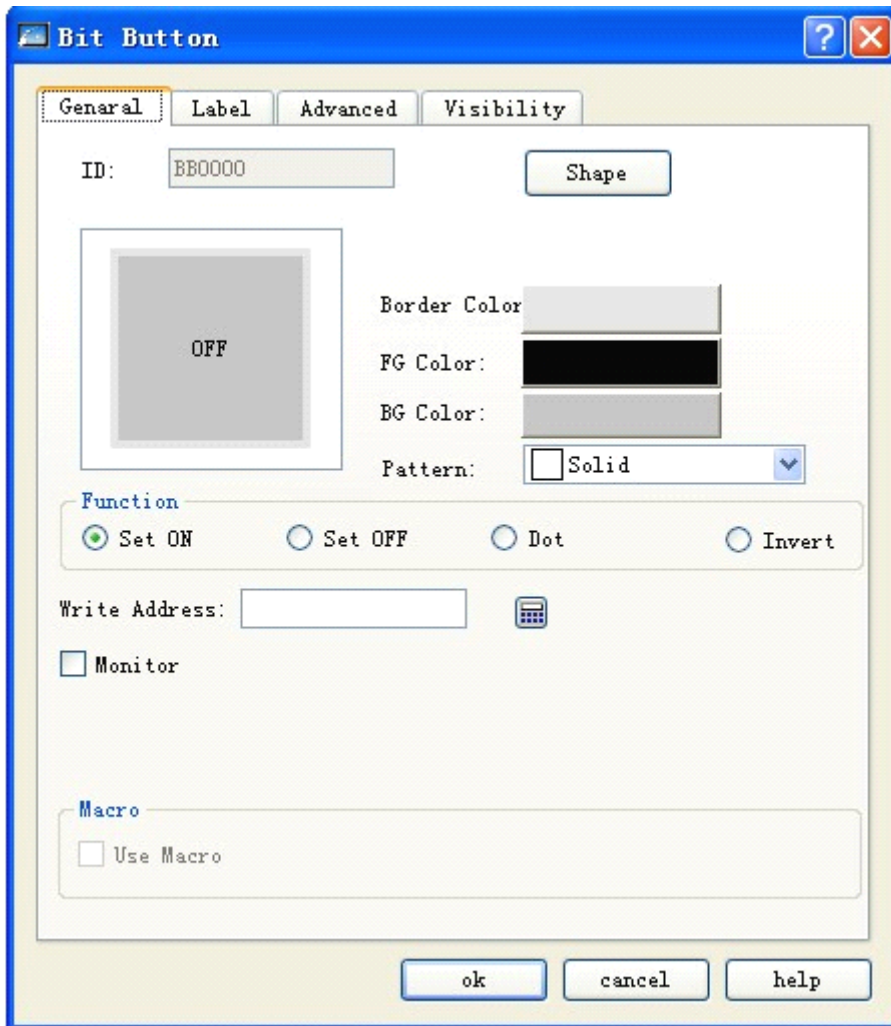

Figure 4-73: Bit button dialog

2. This dialog has four property tabs that are General, Label, Advanced and Visibility. Click the tab to enter the corresponding property setting page and then to set the properties.

➤ General

- ◆ Shape: Click Shape button Shape, and then a Shape dialog will pop up, in this dialog, you can choose desired shape simply by clicking the shape. See Figure 4-74.

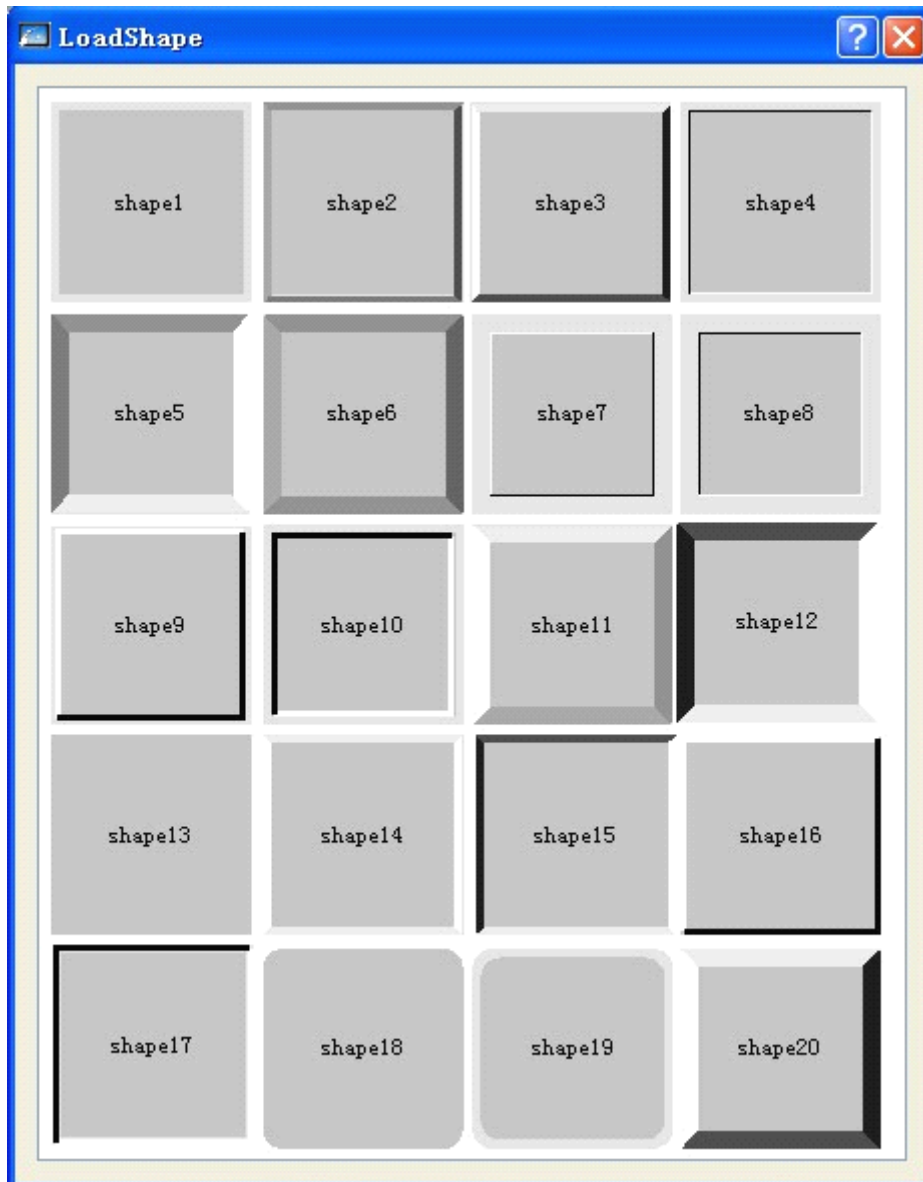

Figure 4-74: Shape pop-up dialog

- ◆ **Border Color:** If you have chosen a shape with border, you can click this button and then choose a desired color in the drop-down color selection system.
- ◆ **FG Color:** If you want to change the foreground color, you can click this button and then choose a desired color in the drop-down color selection system (foreground color is effective only when transition pattern is chosen). Then, there will be a contrast transition between the foreground color and the background color to make the control more beautiful.
- ◆ **BG Color:** If you want to change the background color, you can click this button and then choose a desired color in the drop-down color selection system.
- ◆ **Pattern:** Click this drop-down box, and then you can select any of the 21 patterns to beautify the control. See Figure 4-75 for an example:

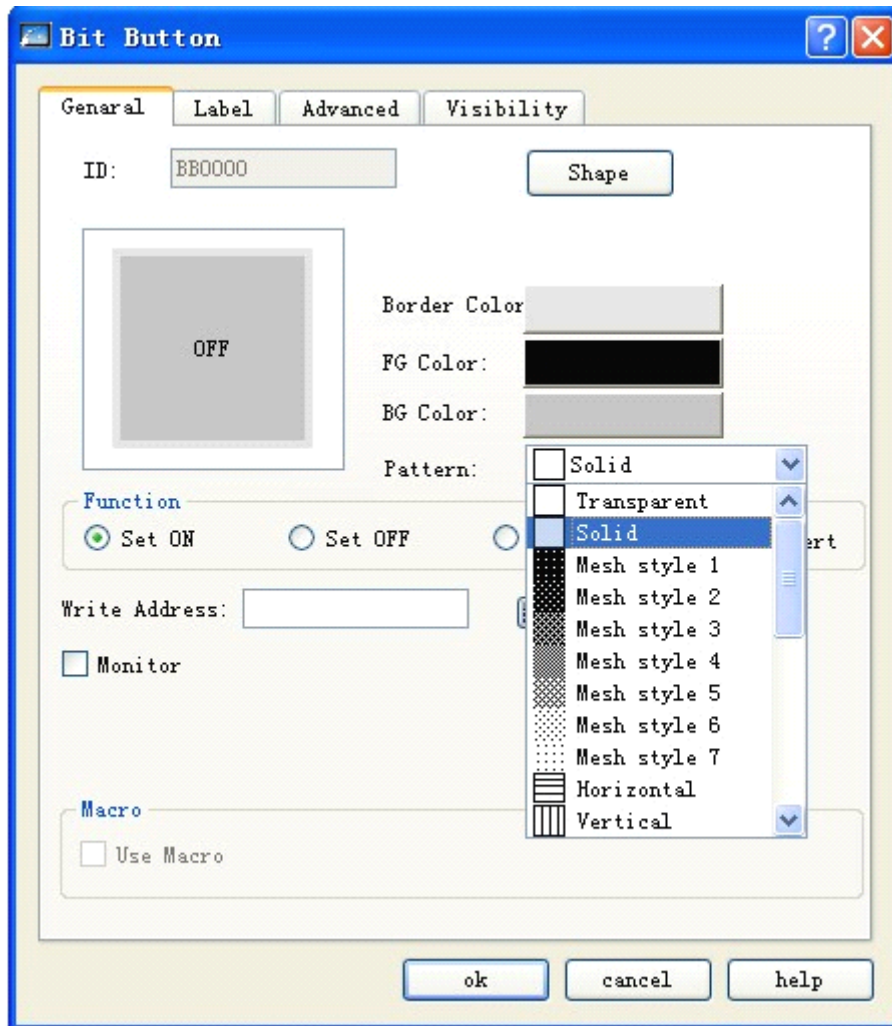



Figure 4-75: Change shape and pattern value

- ◆ **Set ON:** If this option is checked, after downloading to HMI you can set the value of the write address to 1 by clicking this bit button that is setting the write address of the connected device to ON state and displaying 1/ON state.
- ◆ **Set OFF:** If this option is checked, after downloading to HMI you can set the value of the write address to 0 by clicking this bit button that is setting the write address of the connected device to OFF state and displaying 0/OFF state.
- ◆ **Inching:** This option includes two choices, those are “Press down as 1” and “Press down as 0”. If “Press down as 1” is chosen, after downloading to HMI, when the bit button is touched, you can set the value of the write address of the connected equipment to 1/ON by pressing down the button while set to 0/OFF by releasing the button; If “Press down as 0” is chosen, when the bit button is touched, you can set the value of the write address of the connected equipment to 0/OFF by pressing down the button while set to 1/ON by releasing the button.
- ◆ **Momentary:** If this option is checked, after downloading to HMI you can set the value of the write address of the connected device to 1/ON by pressing down the button (and then 1/ON state is displayed), and set the value to 0/OFF by releasing the touch button (and then 0/OFF state is displayed).
- ◆ **Write address:** You can either enter an address by clicking the address input button , or directly type in an address. The address name is not case sensitive. SKWorkshop will give corresponding bit address symbols

basing on the connected device. For example, for FX-2N series of Mitsubishi PLCs, X represents the address of input coil, Y represents the address of the output coil, M represents the address of the intermediate relay, C represents the address of the counter (on/off state display), T represents the address of the timer (on/off state display), D represents the address of the data register, C* represents the address of the counter (count value), and T* represents the address of the timer (count value). For S7-200 series of Siemens PLCs, I represents the address of the input point, Q represents the address of the output point, M represent the address of the intermediate relay, and V represents the address of the data register. See Figure 4-76.

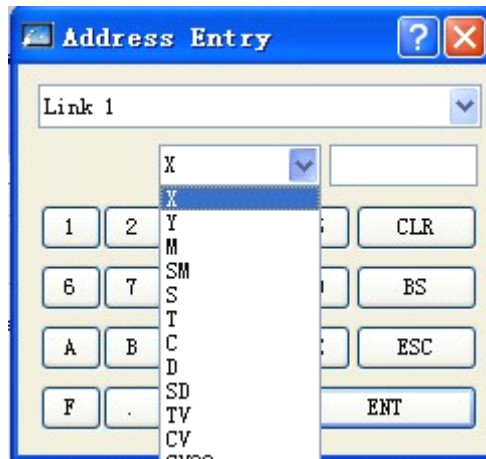

Figure 4-76

Thus, you can write the current state of the bit button into the address basing on the corresponding address symbols of the PLCs or other connected device used. In other words, when the Bit Button is at 0/OFF state, the value of the write or displayed address is 0/OFF; when the control is at 1/ON state, the value of the write or displayed address is 1/ON.

- ◆ Monitor: If this option is checked, a Monitor Address will appear, indicating this Bit Button can be used to monitor the state change of the value of Monitor Address. When the value of the monitored address is 1/ON, the bit button presents 1/ON state; when the value of the monitored address is 0/OFF, the bit button presents 0/OFF state. When Monitor is chosen, the monitored address can be different from the write address. For example, when Set ON function is chosen for this bit button, the write address can be set to 1/ON by touching the button. However, if the current state of the monitored address is 0/OFF, then this bit button presents 0/OFF state. Generally we choose the option of “The Same Monitor Address and Write Address”, so that the state value written by you can be directly presented or displayed.
- ◆ Macro: If “Use Macro” option is checked, a list of macros will be displayed, and you can choose a macro so that this macro will be executed when the bit button is pressed. Only successfully compiled macros are displayed in the drop-down list.



When Monitor option is not checked, the ON/OFF state of the bit button will not change even if it is touched.

➤ Label

When Label tab is clicked, the “Off Text” page will be displayed by default. See Figure 4-77.

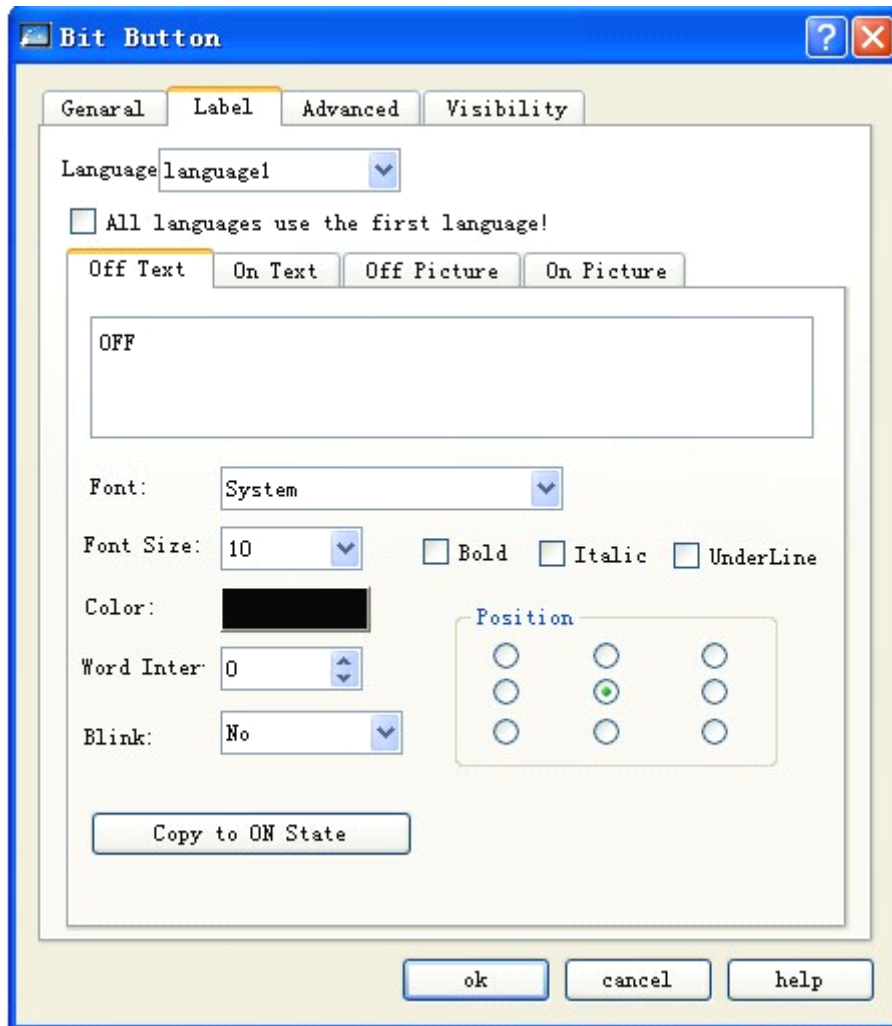

Figure 4-77: Label tab of bit button

This tab consists of four pages that are “Off Text”, “On Text”, “Off Picture” and “On Picture”.

- ◆ Off Text and On Text: Used to change the text at Off state or On state, font pattern, font size, edge distance, font color, position and some other properties. SKWorkshop also provides more convenient copy function, so that you can directly copy well set properties to the current Off Text or On Text.
- ◆ Text of the first language used for all languages: This option is used for multiple languages cases that are when the total numbers of languages is more than 1 in the Language option of the Project Manager. If this option is chosen, the language of the control will not be changed along with the language switch.
- ◆ Language: This option is used for multiple languages cases. You can choose different languages and enter different texts under different states, getting prepared for multiple language controls. Thus, when Switch Language option is chosen in the function buttons, and a target language is chosen, all the text controls in the screen will use specified language after clicking this function button. For different languages, text contents, font and font size may be different, but color, word space and position are the same.
- ◆ Font: Font of the text contents entered. You may choose different fonts for different states or languages.
- ◆ Font size: Font size of the text contents entered. You may choose different font sizes for different states or languages.

- ◆ Color, word space and position: Used to set the text color, word space and alignment mode under the current state. When the total numbers of languages is more than 1 in the Language option of the Project Manager, and the language other than language 1 is chosen, these three function options will be invalid, and the same text color, word space and position as that in language 1 will be applied.

- ◆ Off Picture and On Picture: Here you can add pictures of different formats to different state according to the Picture Source. When you have chosen the desired picture, it will be automatically added to General tab. When you choose the option of “Fit to Object”, the picture will be of the same size as the control set in the General tab

- ◆ Fit object size: If this option is chosen, the size of the graph is the same as the control in the General tab, and the Edge Distance and Position options will be invalid and hidden.

- ◆ When importing a picture from external files, there will be a Transparent option, which is used to change a specified color to transparency.



When flicker is chosen, the flickering screen will be the screen at ON/OFF state, and the default frequency is 1s. To change this frequency, double click Touch Screen Parameter Setting option in the Project Manager, find Flickering Frequency option in the pop-up dialog, and then change the frequency to the desired value.

- Advanced page will be displayed after you click this tab. See Figure 4-78.

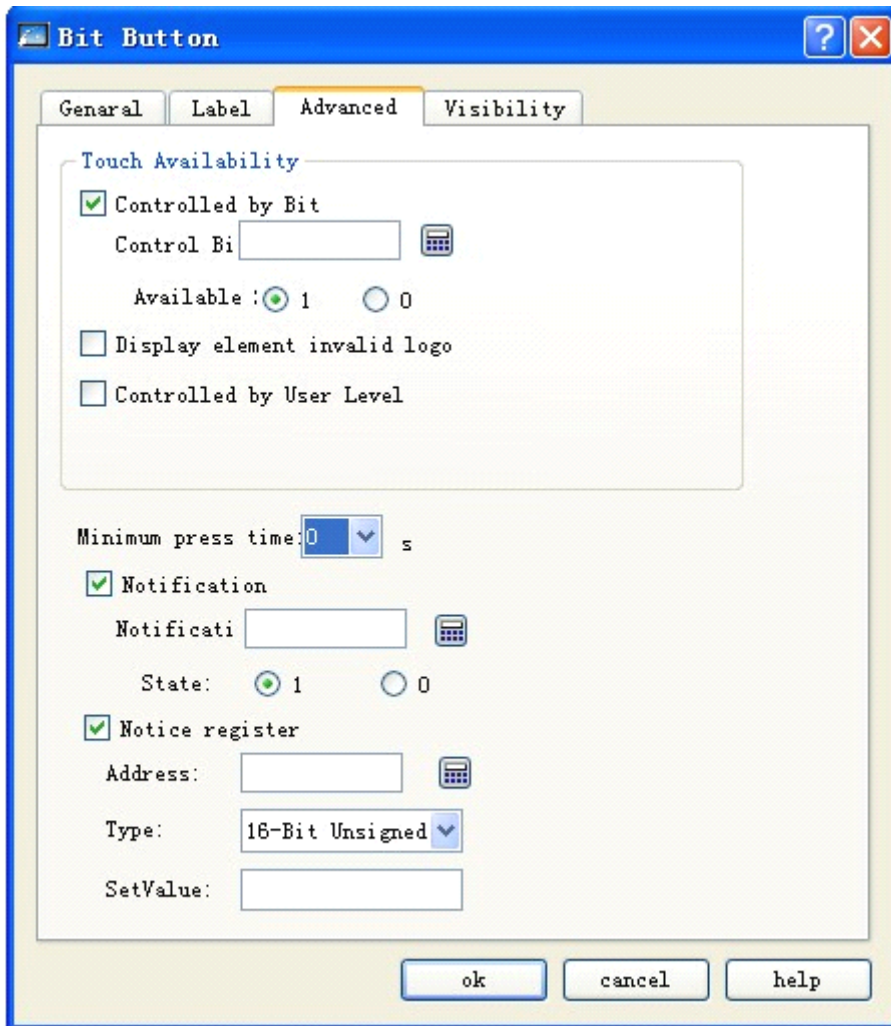

Figure 4-78: Advanced tab of bit button

- ◆ **Controlled by bit:** When this option is checked, if the Effective State is 1, then the Bit Button can be effectively touched when and only when the value of the Control Bit is 1; if the Effective State is 0, then the Bit Button can be effectively touched when and only when the value of the Control Bit is 0.
- ◆ **Controlled by User Level:** You can choose several options basing on the actual needs. After setting, the touch level of this control will be compared with the Default User Level in the User Password Setting in the Touch Screen Parameter Setting to determine whether the control is touchable.

For example, if option 2 and 3 are chosen in the Effective Level Controlled in the Advanced Tab of the control, and the User Password Setting in the Touch Screen Parameter Setting is as shown in Figure 4-79:

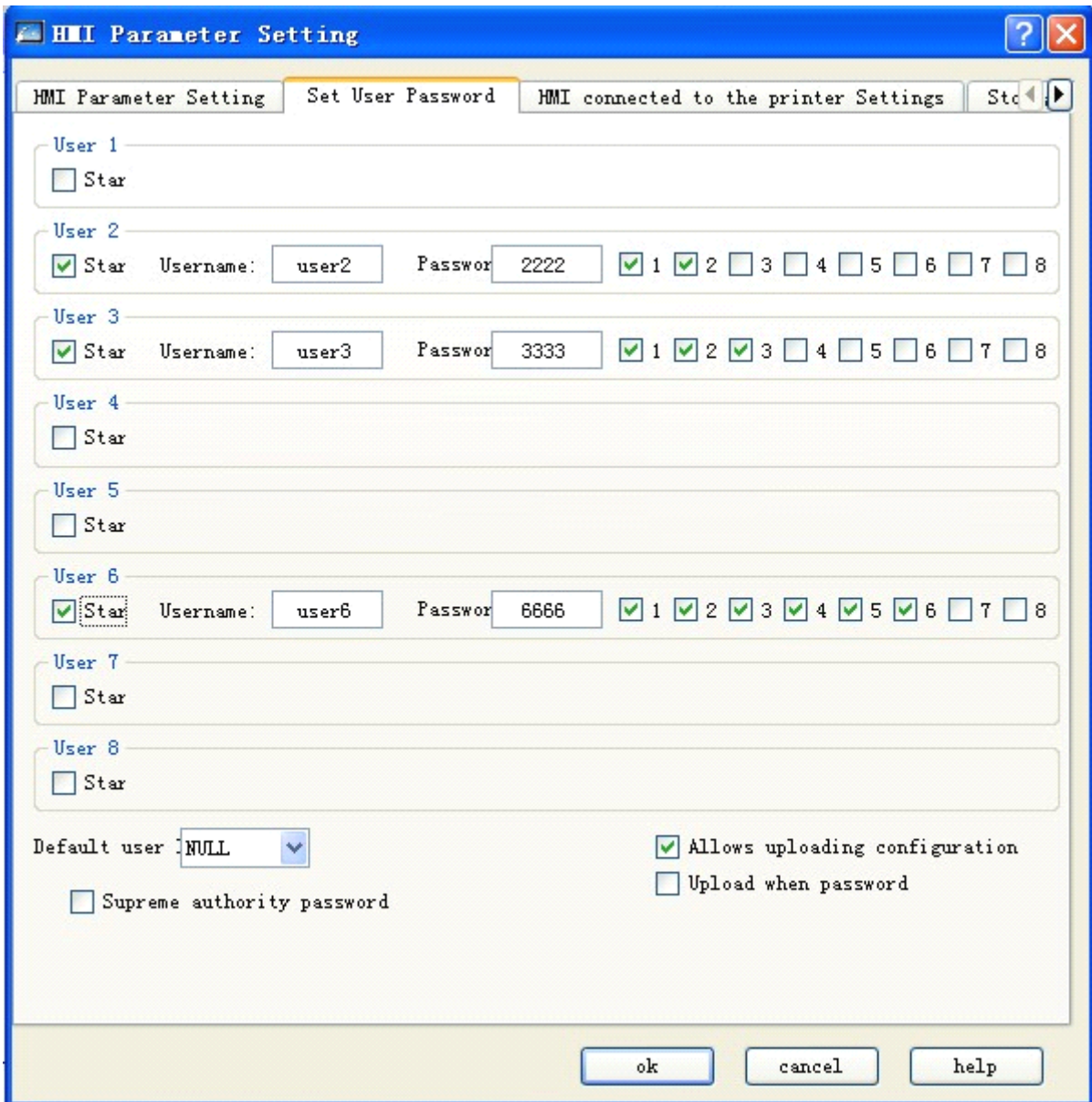

Figure 4-79: User password setting in the touch screen parameter setting

Then: if Default User Level is NULL, this control is not touchable, and in this case you can use Change User Level in Function buttons to change the default level. For example, if the password entered by the user is 6666, corresponding to User Level 6, but the user chooses only option 1, not matching option 2 or 3, so the system will prompt that the password is incorrect; When the password entered by the user is 2222 or 3333, as both users have option 2, matching option 2 or 3, the password is valid and this control will be changed to a touchable control. If the Default User Level is user 2 to 3, then both user levels have option 2 to match the touching conditions, and then this control is touchable in simulation or initialized screen; If the Default User Level is user 3, then this user level does not have an option to match the touching conditions, and then this control is not touchable in simulation or initialized screen.

- ◆ Minimum press-down time: Indicates how long (in second) should the control be pressed down to take effect in simulation or screen.

- ◆ Notification: When the control is touchable, if you click this control and enter a value in the pop-up keyboard, the system will write a user-specified state value (1 or 0) to the Notification Bit address set by the user.
- ◆ Notification register: When the control is touchable, if you click this control and enter a value in the pop-up keyboard, the system will write a user-specified state value (Set Value entered by the user) to the Notification Register Address set by the user.



The default user level is 1 that is the minimum level. Designers can change the user level in the “Change User Level” option in the function buttons after entering correct password.



Effective touch means that there are actual actions after the control is touched, for example successful setting, resetting, inching and alteration. Notification will be given only upon effective touch. Taking numeric entry for example, when you touch numeric entry button, a keyboard will pop up. At this moment, although the numeric entry button has action against the touch, no write operation will be carried out to the write address, so there will be no notification. If the keyboard is quitted by pressing ESC, no notification will be generated either. Only when you type in a number between the maximum value and the minimum value via the keyboard, and then press ENTER key, there will be notification and such touch will be an effective touch.

- Visibility page will be displayed after you click Visibility tab. This page is mainly used to set whether to display or hide the control. See Figure 4-80

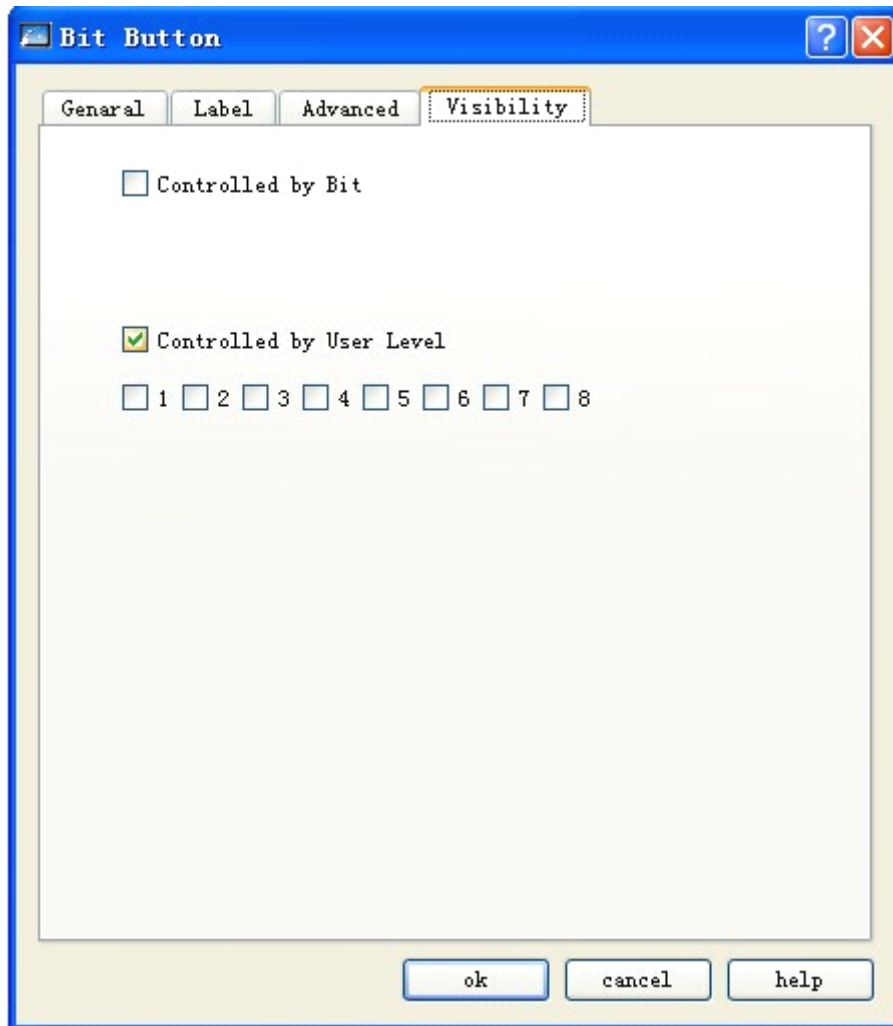

Figure 4-80: Visibility tab of bit button

- ◆ **Controlled by bit:** When this option is checked, if the Effective State is 1, then the Bit Button can be displayed on the touch screen when and only when the value of the Control Bit is 1; if the Effective State is 0, then the Bit Button can be displayed on the touch screen when and only when the value of the Control Bit is 0.
- ◆ **Controlled by User Level:** When User Level Controlled is chosen, the conditions will be the same as those in the User Level Controlled option in Advanced tab, and only when such conditions are met the Bit Button can be displayed on the touch screen.



If neither of these two options is checked, the control will be always displayed on the touch screen.

- After setting of the properties, click OK button, and then the mouse shape will become a cross. Now you can draw a rectangle in the screen by clicking the mouse and thus add this control into the screen.

4.5.2 Word button of SKWorkshop

Word Button can be used to enter fixed value, numeric value and password into the data register and execute adding/subtracting operations for the values in the register. The steps to set a Word Button are as follows:

- Choose Word Button icon **W** in the tool bar, and then a dialog as shown in Figure 4-81 will pop up.

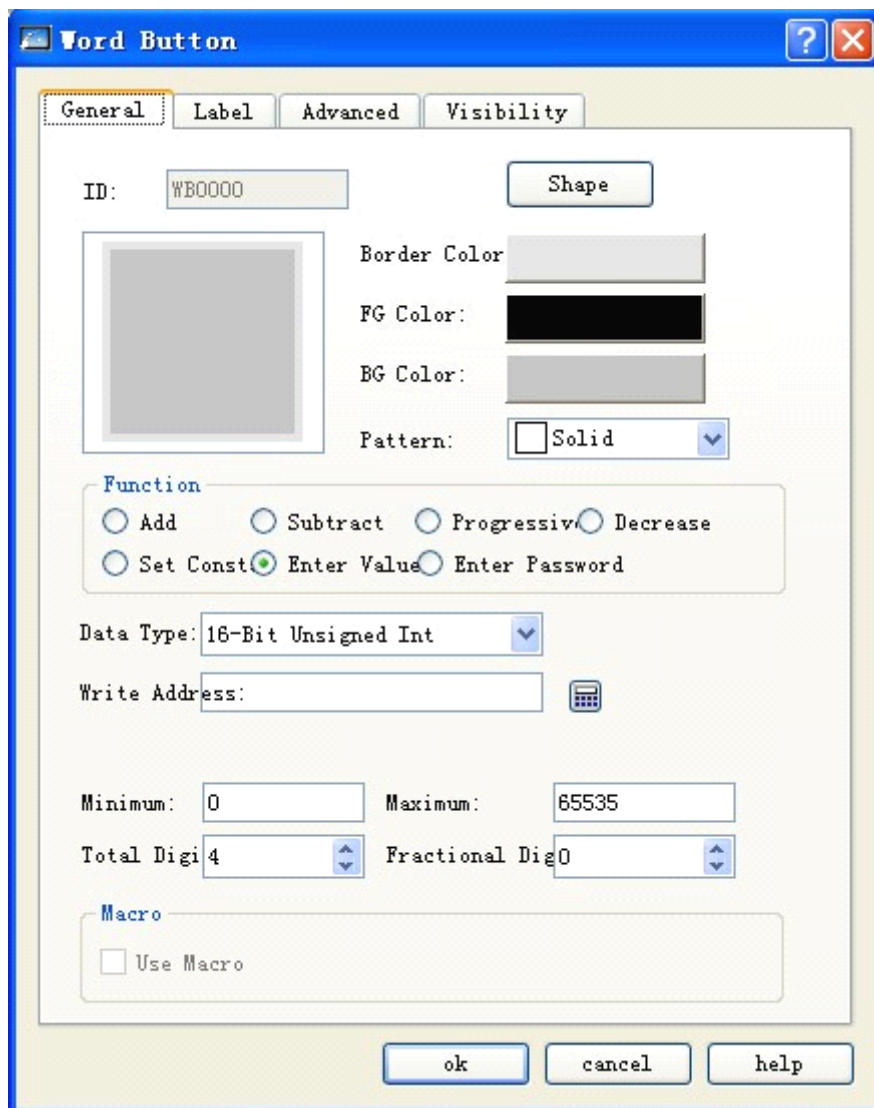

Figure 4-81: Word Button dialog



Refer to Bit Button control for setting of Shape, Border Color, FG Color, BG Color and Pattern.

- Function module:

- ◆ Set Constant: Different types of data can be chosen. SKWorkshop provides several data types, including 16/32-digit positive integer, 16/32-digit integer, 16/32-digit BCD positive integer, and 32-digit floating point number. This option is to write the constant set by you to the write address. For example, if the write address is LW1, and the constant is 10, then each time the button is touched the value of LW1 will be set to constant 10 regardless of its original value.
- ◆ Enter value: Different data types can be chosen. This option is to write a value that is the numeric value set by you, to the write address. This value must be between the maximum value and minimum value. Then, when you touch the Word Button, a keyboard will pop up on the touch screen, and you can enter desired value. See Figure 4-82.

Min: 0		Max: 7			
1	2	3	4	5	Del
6	7	8	9	0	Esc
00	.	+/-	Clr	Enter	

Figure 4-82

- ◆ Increase: When the Delay Parameter is 0, this function is the same as Add function. If the Delay Parameter is not 0, after clicking this control the value of the write address will continuously add a constant after elapse of the time set in the Delay Parameter and write the value into the write register.
 - ◆ Decrease: When the Delay Parameter is 0, this function is the same as Subtract function. If the Delay Parameter is not 0, after clicking this control the value of the write address will continuously subtract a constant after elapse of the time set in the Delay Parameter and write the value into the write register.
 - ◆ Enter password: The same function as Enter Numerical Value, except that this function module does not have the option of decimal digits
 - ◆ Add: After you set the data type, the write address, the constant and the maximum value, the value of the register corresponding to the write address will be added by the constant set each time the Word Button is touched. However, the value of the write address cannot exceed the maximum value set by you. For example, if the write address is LW1, the constant is 5, and the maximum value is 65535, then each time this control is executed, the value of LW1 will be added by 5, but will be no higher than 65535. After setting of the properties, click OK button, and then the mouse shape will become a cross. Now you can draw a rectangle in the screen by clicking the mouse and thus add this control into the screen.
 - ◆ Subtract: After you set the data type, the write address, the constant and the maximum value, the value of the register corresponding to the write address will be deducted by the constant set each time the Word Button is touched. However, the value of the write address cannot be less than the minimum value set by you. For example, if the write address is LW1, the constant is 5, and the maximum value is 0, then each time this control is executed, the value of LW1 will be deducted by 5, but will be no lower than 0.
- Total digits: Total number of digits including the decimal.
 - Fractional digits: When the data type is not “32-digit floating point number”, and the fractional digits are set to n, then the maximum value entered should be reduced by 10^n . For example, if the data type chosen is “32-digit positive integer” and the number of fractional digits is 3, then you can only enter a value between 0 and 99999.999.
 - Enter Password: This option has the same functions as Enter Value option, except that there is no option of “Fractional digits”.



The Label tab of Word Button is the same as the Label tab of Bit Button, except that in the former there is not ON Text and ON Picture, as Word Button has only one state. Thus, you can refer to the introduction of Bit Button control for some settings of Word Button.



: When 32-digit data type is chosen for Word Button, the save address occupies two characters. For example, when writing data to data register of Siemens PLCs, and the write address is V10, the occupied addresses of the data register are V10 and V11. If you try using other controls to monitor the value of V11, there may be errors. Thus, pay attention to 32-digit data type to avoid mis-operation over data and address.



: The Advanced and Visibility tabs of Word Button are exactly the same as the Advanced and Visibility tabs of Bit Button. Thus, you can refer to the introduction of Bit Button control for some settings of Word Button.

- After setting of the properties, click OK button, and then the mouse shape will become a cross. Now you can draw a rectangle in the screen by clicking the mouse and thus add this control into the screen.

4.5.3 Bit lamp of SKWorkshop

Bit Lamp can be used to monitor the ON/OFF state of the bit contact of the connected device, and to display the corresponding state on the screen. See Figure 4-83.





图 4-83 Figure 4-83

Steps to set a Bit Lamp are as follows:

1. Choose the Bit Lamp button icon  in the tool bar, and then a dialog as shown in Figure 4-84 will appear.

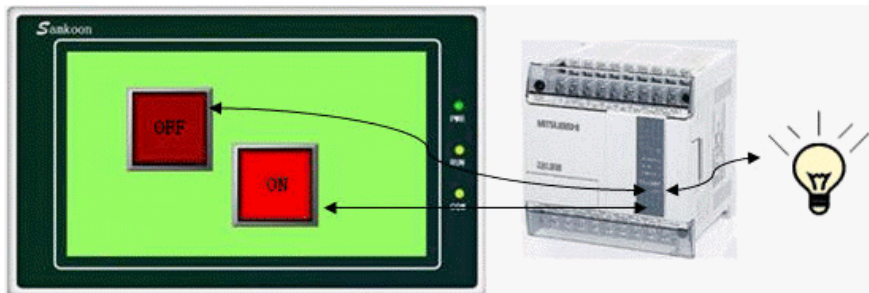
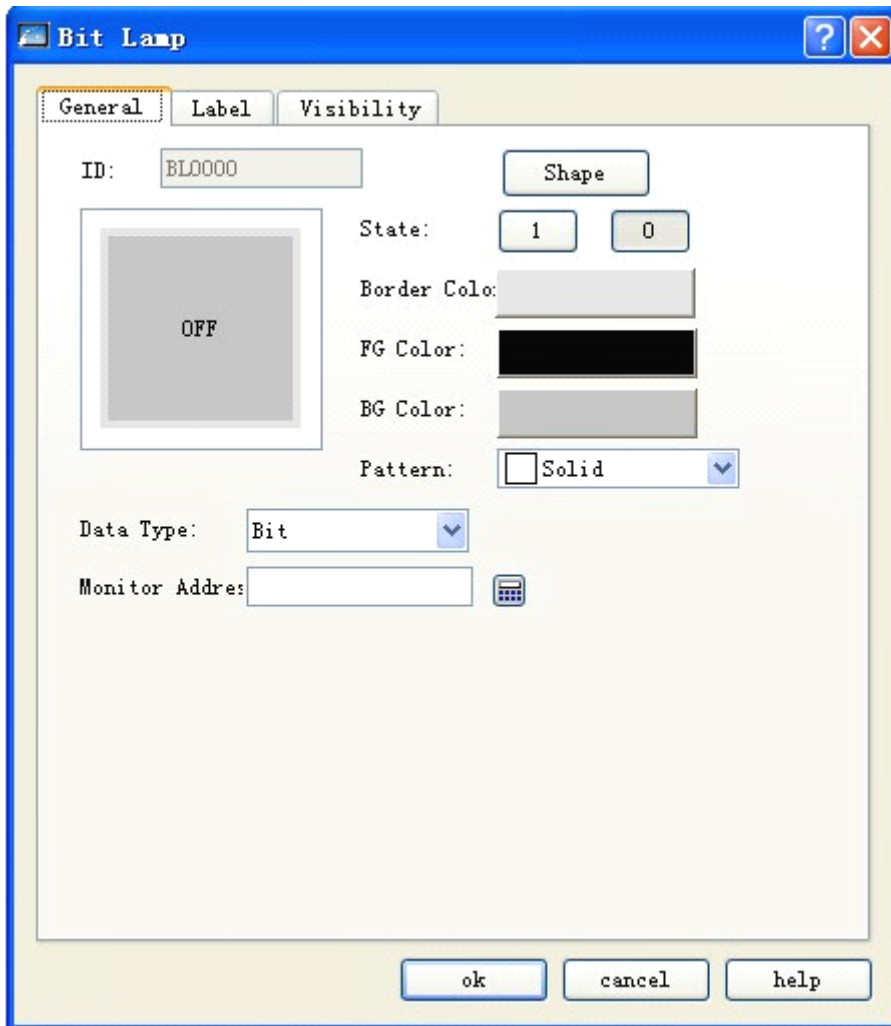

Figure 4-84: Bit Lamp dialog

- Data type: This drop-down box has three options that are bit, word bit and double word bit. If Bit is chosen, the monitored (read) address will be a bit address; If Word Bit is chosen, the monitored (read) address will be a word address; If Double Word Bit is chosen, the monitored (read) address will be a double word address.
- Bit Number: If the data type chosen by the user is Word Bit or Double Word Bit, the displayed ON/OFF state of the monitored (read) address will be determined by the value of the Bit Number; The bit number of Word Bit is 0-15 and the bit number of Double Word Bit is 0-31.

For example: If Word Bit is chosen, the monitored address is LW1 and the value of LW1 is 23, as the decimal number 23 corresponds binary number 10111, so if the bit number chosen is 3, the system will check the value of the number 3 (counting from right to left from 0) bit, and display such value as the state (if this value is 0, state 0 will be displayed; if this value is 1, state 1 will be displayed). In this example, the value is 0, so the bit lamp will display state 0.



Refer to Bit Button control for setting of Shape, Border Color, FG Color, BG Color and Pattern.

2. In the General page of the Bit Lamp, choose an address to be monitored by the lamp, and set such parameters as the display texts and picture and flicker in Label page.



The Label tab of Bit Lamp is exactly the same as the Label tab of Bit Button. Thus, you can refer to the introduction of Bit Button control for some settings of Bit Lamp.

3. If “Word Bit” or “Double Word Bit” is chosen as Date Type, there will be a bit number selection dialog.



The Visibility tab of Bit Lamp is exactly the same as the Visibility tab of Bit Button. Thus, you can refer to the introduction of Bit Button control for some settings of Bit Lamp.

After setting of the properties, click OK button, and then the mouse shape will become a cross. Now you can draw a rectangle in the screen by clicking the mouse and thus add this control into the screen.

4.5.4 Screen button of SKWorkshop

Screen Button is mainly used to switch screens, change user level and pop-up window, and the like. You can make the screen/window switch to a set screen/window by touching a set screen button, and during the switching process you can also choose whether to change user level.

➤ Click Screen Button icon  in the tool bar, and then a dialog as shown in Figure 4-85 will pop up.

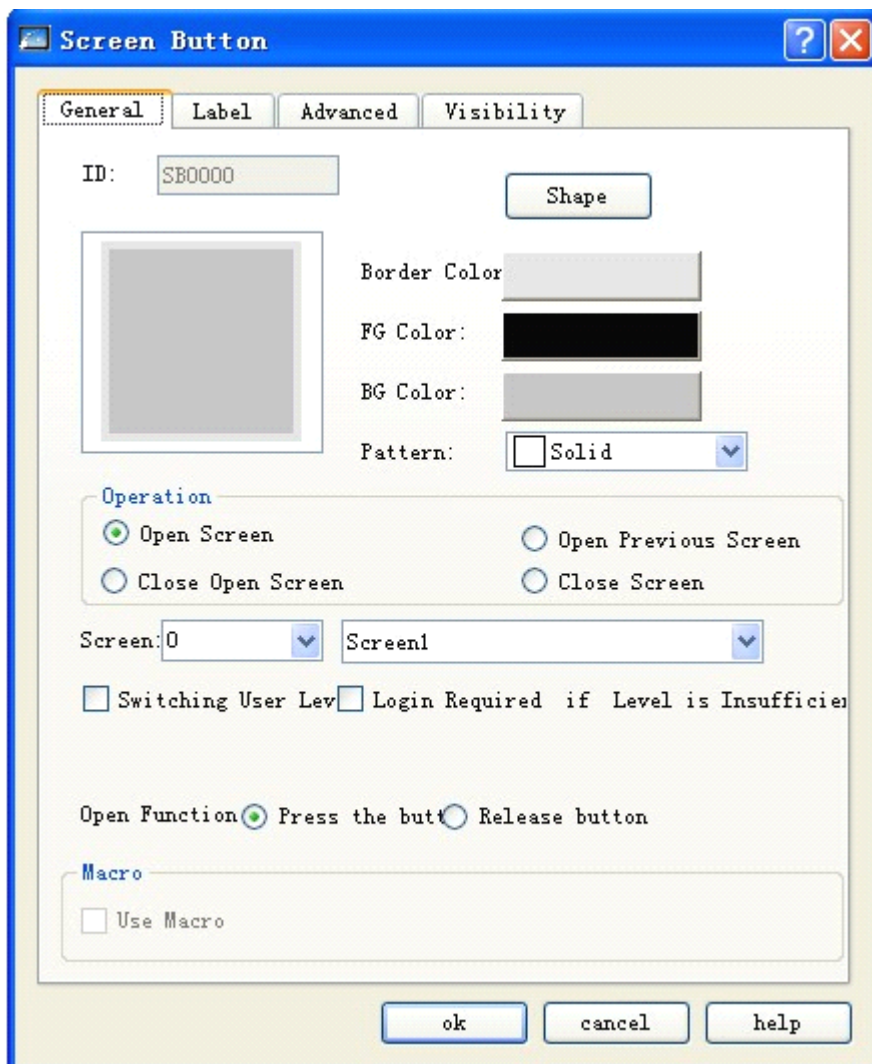

Figure 4-85: Screen button dialog



Refer to the introduction of Bit Button for Shape, Border Color, FG Color, BG Color and Pattern.

- **Function module:**
 - Open Screen: Here you can choose a screen to be opened in Screen option, so that the screen will be opened after you click the screen button in the touch screen. This function can be used in screen or window.
 - Open Previous Screen: When this option is checked, the screen will jump to the previous screen after you click this button. This function can be only used in screen pages.
 - Close and Open Screen: This function can be only used in window page. It is used to close the current window and open another window or screen.
 - Close Screen: This function can be only used in window page. It is used to close the current window page.
- **Change user level:**
 - ◆ User level log off: Recover the current user level to the default user level.
 - ◆ Specify user level: Change the current user level to a specified level.
- **Open function:**
 - ◆ When Pressing Down: Screen switch-over will be performed when you press down the mouse.
 - ◆ When Releasing: Screen switch-over will be performed when you release the mouse.
- **Require logon at insufficient user level**

If you chose User Level Controlled option in the Advance tab of Screen dialog, and have changed the Valid Lowest Level, then the controls in the screen will be touchable only when the current user level is equal to or higher than the Valid Lowest Level set by you. Otherwise, a password dialog will pop up when you touch a control in the screen, as shown in Figure 4-86:

Min. 0		Max. 7			
1	2	3	4	5	Del
6	7	8	9	0	Esc
00	.	+/-	Clr	Enter	

Figure 4-86: Password input dialog

The screen can be opened only when the level of the password entered is higher than that set by you, and after the screen is opened the current user level is the level entered just now.

- **Use Macro:** If “Use Macro” option is checked, a list of macros will be displayed, and you can choose a macro so that this macro will be executed when the screen button is pressed. Only successfully compiled macros are displayed in the drop-down list.



The Label tab of Screen Button is the same as the Label tab of Bit Button, except that in the former there is not ON Text and ON Picture, as Screen Button has only one state. Thus, you can refer to the introduction of Bit Button control for some settings of Screen Button.



The Advanced and Visibility tabs of Screen Button are exactly the same as the Advanced and Visibility tabs of Bit Button. Thus, you can refer to the introduction of Bit Button control for some settings of Screen Button.

- After setting of the properties, click OK button, and then the mouse shape will become a cross. Now you can draw a rectangle in the screen by clicking the mouse and thus add this control into the screen.

4.5.5 Function button of SKWorkshop

Function Button is an important control in the whole touch screen. Using this button you can conveniently realize various functions. Click **F1**, and then a Function Button property dialog as shown in Figure 4-87 will appear.

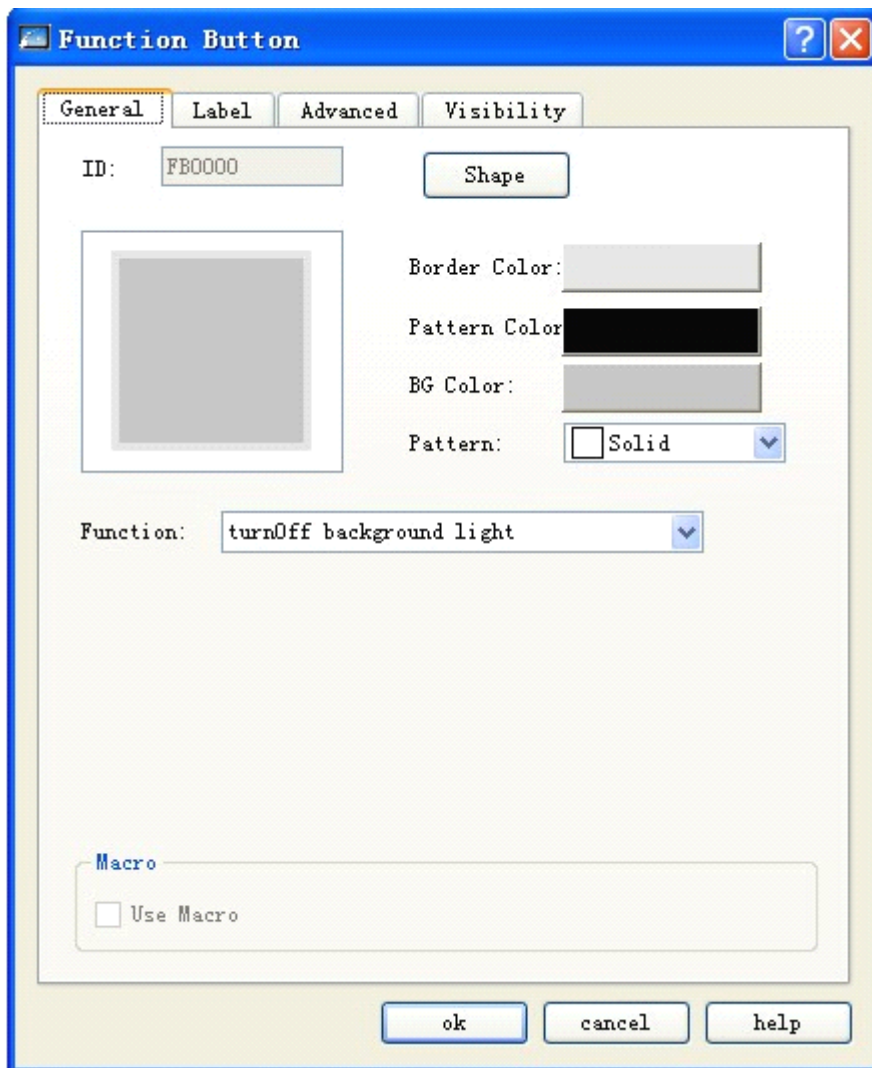

Figure 4-87: Function button dialog



Refer to Bit Button control for setting of Shape, Border Color, FG Color, BG Color and Pattern.

1. Turn off background light

Used to set the function of the Function Button to “turn off alarm light”. Then, you can turn off the background light of the touch screen by touching this button, but the touch screen remains working normally. To turn on the background light, you only need to touch any position on the touch screen.

2. Confirm alarm

Used to set the function of the Function Button to “confirm alarm”. Then, you can confirm chosen alarm contents by touching this button on the touch screen.

3. Restart

Used to set the function of the Function Button to “restart”. Then, you can restart the touch screen by touching this button on the touch screen.

4. Set screen saver time

Set the time before starting up screen saver.

5. Write recipe to PLC

Used to set the function of the Function Button to “write recipe to PLC”. Then, you can write the recipe parameters saved in the current screen to corresponding continuous data register addresses (which are write addresses set by designers during recipe setting) of PLC or other connected devices by touching this button on the touch screen.

6. Read recipe from PLC

Used to set the function of the Function Button to “read recipe from PLC”. Then, you can read the recipe parameters saved in corresponding continuous data register addresses (which are write addresses set by designers during recipe setting) of PLC or other connected devices to the touch screen by touching this button on the touch screen.

7. Set time and date

Used to set the function of the Function Button to “set time and date”. Then, you can set internal time and time of the touch screen by touching this button on the touch screen.

8. Clear alarm

Used to set the function of the Function Button to “clear alarm”. Then, you can clear chosen and confirmed historical alarm information by touching this button on the touch screen.

9. Previous recipe

Used to set the function of the Function Button to “previous recipe”. Then, you can open the previous recipe of the current recipe by touching this button on the touch screen. If the current recipe is the first recipe or there is only 1 recipe, the recipe parameters will not be changed by touching.

10. Next recipe

Used to set the function of the Function Button to “next recipe”. Then, you can open the next recipe of the current recipe by touching this button on the touch screen. If the current recipe is the last recipe or there is only 1 recipe, the recipe parameters will not be changed by touching.

11. Save current recipe

Used to set the function of the Function Button to “save current recipe”. Then, you can save the recipe parameters from corresponding continuous data register addresses (which are write addresses set by designers during recipe setting) of PLC or other connected devices to the current recipe by touching this button on the touch screen.

12. Screen shot

This function button is used to shoot the current screen and save it as a picture to specified position.

13. System parameters

Used to set the function of the Function Button to “system parameters”. Then, you can open the system parameter page by touching this button on the touch screen. In this page some information on the touch screen is displayed and can be modified by touching, such as system time, screen saver time, background light contrast, and the like.

14. Change user level

Used to set the function of the Function Button to “change user level”. Then, you can change the privilege of the current user by touching this button on the touch screen. If Privilege Login option is chosen, then a keyboard will appear on the screen when you touch the Function Button. Then, after you enter the system password set in Environment Parameter option, you can get the privilege corresponding to this user level and thus enter a screen with a level equal to or higher than this level.

15. Cancel user level

Used to set the function of the Function Button to “cancel user level”. Then, you can cancel the privilege of the current user by touching this button on the touch screen so that the user level will become the minimum level that is level 1.

16. Alarm voice (On/Off)

Used to set the function of the Function Button to “alarm voice (On/Off)”. Then, where there is an alarm in the touch screen, the alarm will be audible. Function button can be used to enable or disable this function. Add a Function Button on the screen, and set it to “alarm voice (On/Off)”. Then, if alarm voice is enabled in the current system, it will be disabled by pressing this button; if it is disabled in the current system, it will be enabled by pressing this button.

17. Touch voice (On/Off)

Used to set the function of the Function Button to “touch voice (On/Off)”, that is to enable or disable touch voice. Then, if the screen makes a sound along with touching, after pressing this button it will no longer make a sound; and vice versa.

User Macro: If this option is chosen, a list of macros will be displayed, and you can choose a macro so that this macro will be executed when the bit button is pressed. Only successfully compiled macros are displayed in the drop-down list.

18. Clear all historical data

Used to clear all historical data saved in the touch screen.

19. Clear historical alarm

Used to clear all historical alarm information saved in the touch screen.

20. HMI protection unlocking

Used to unlock HMI protection by entering password.

21. Recipe reading & saving

Used to read and save a recipe.

22. Stand-by function

Used as stand-by function. No action will be executed after pressing this button.

23. Reload recipe

23. Change language

Change the text of all controls of the project to specified language.



: After the system jumps to the system screen, the system will close the current project. When the system quits the system screen, it will restart the project and enter the startup page set in the project.



: The Label tab of Function Button is the same as the Label tab of Bit Button, except that in the former there is not ON Text and ON Picture, as Function Button has only one state. Thus, you can refer to the introduction of Bit Button control for some settings of Function Button.



: The Advanced and Visibility tabs of Function Button are exactly the same as the Advanced and Visibility tabs of Bit Button. Thus, you can refer to the introduction of Bit Button control for some settings of Function Button.

After setting of the properties, click OK button, and then the mouse shape will become a cross. Now you can draw a rectangle in the screen by clicking the mouse and thus add this control into the screen.

4.5.6 Multi-state lamp of SKWorkshop

Multi-state Lamp is mainly used to display different states according to the value of the monitored address, up to 32 states.

Click the multi-state Lamp button icon  in the tool bar, and then a dialog as shown in Figure 4-88 will appear.

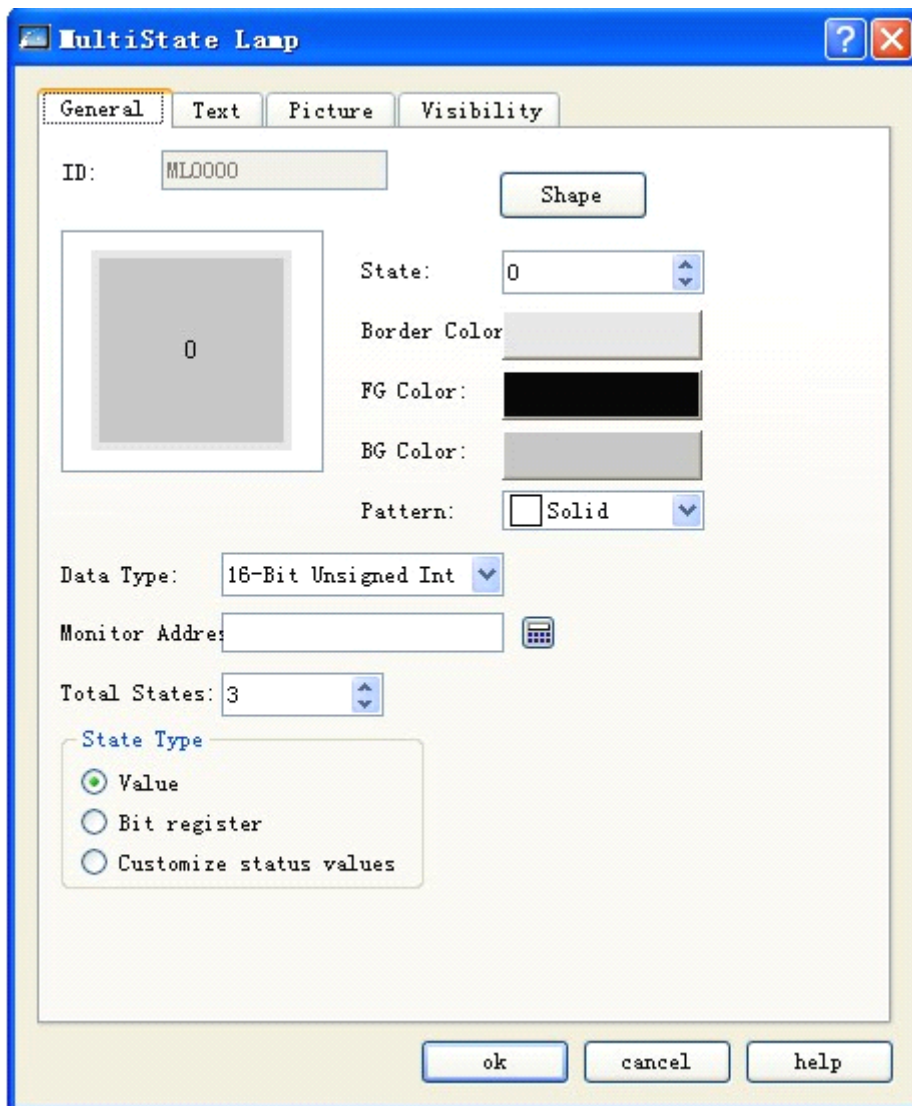

Figure 4-8: Multi-state lamp dialog

1. General

- State: You can change this state value, and modify the border color, pattern color, background color and pattern of the control under different states.
- State type: (it is assumed that the number entered by the user is n)
 - ◆ Numerical value: The written value is a numerical value from 0 to the total number of states less 1.
 - ◆ Register bit: The written value is the No. n power of 2. For example:

We assume the monitored (read) address is LW3, and the total number of states is 8. After setting and clicking OK, click on the screen to add the control into the screen, add an value entering control in the screen, set both the write address and monitored address to LW3, and then save the project.

Click the number entering control in simulation or screen, and enter a desired state value in the pop-up keyboard. We assume the value entered is 2, then the value of the monitored (read) address is 1, and the control will display the texts under state 1 (that is the text contents under State 1 in the Text tab of this control). Similarly, if the entered value for LW3 is 8, the control will display the text under state 3. If the entered value for LW3 is 3, the multi-state lamp will not switch to any state.

- ◆ User-defined state value: When this option is chosen, there will be a Define State Value button after the User-defined State Value. Click this button, and then a dialog as shown in 4-89 will pop up:

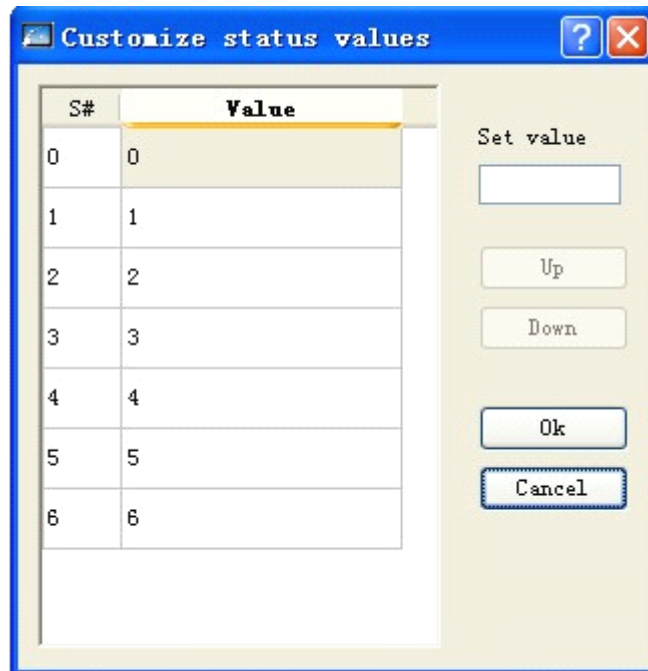

Figure 4-89: User-defined state value dialog

In this dialog, column S# is the current state column, which means that when you chose a line, the value corresponding to S# in the line indicates the current state value. Double click the Value column of a line, and then you can enter the value to be written under the current state.

For example, we assume the monitored (read) address is LW3, and the total number of states is 8. After setting and clicking OK, click on the screen to add the control into the screen, add an value entering control in the screen, set both the write address and monitored address to LW3, and then save the project.

Click the number entering control in simulation or screen, and enter a desired state value in the pop-up keyboard. We assume the value entered is 22, then the value of the monitored (read) address is 1, and the control will display the texts under state 1 (that is the text contents under State 1 in the Text tab of this control). Similarly, if the entered value for LW3 is 33, the control will display the text under state 3. If the entered value for LW3 is 2, the multi-state lamp will not switch to any state.

- Date type: Data type of the write address and monitored (read) address.
- Monitored address: The same to read address. The value of this address is the read state value, and the user-chosen state will be shown in the control.
- Total states: Here you can set the total number of states basing on particular needs, up to 32 states that is state 0-31.

For example, when 16-digit positive integer is chosen and the total states are 32, if the value in the monitored address is 0, then the Multi-state lamp displays the texts and picture of state 0; if the value in the monitored address is 5, then the Multi-state lamp displays the texts and picture of state 5. If the value in monitored address is 60, then the Multi-state lamp displays the texts and picture of state 31, as the total number of states is 32 at most.



Refer to Bit Button control for setting of Shape, Border Color, FG Color, BG Color and Pattern.



When 32-digit data type is chosen for multi-state Lamp, the save address occupies two characters. For example, when writing data to data register of Siemens PLCs, and the write address is V10, the occupied addresses of the data register are V10 and V11. If you try using other controls to monitor the value of V11, there may be errors. Thus, pay attention to 32-digit data type to avoid mis-operation over data and address.



The data type should be the same as the type of the data to be indicated.

2. Text

Click Text tab in the Multi-state lamp property dialog, and then a property setting dialog as shown in Figure 4-90 will appear:

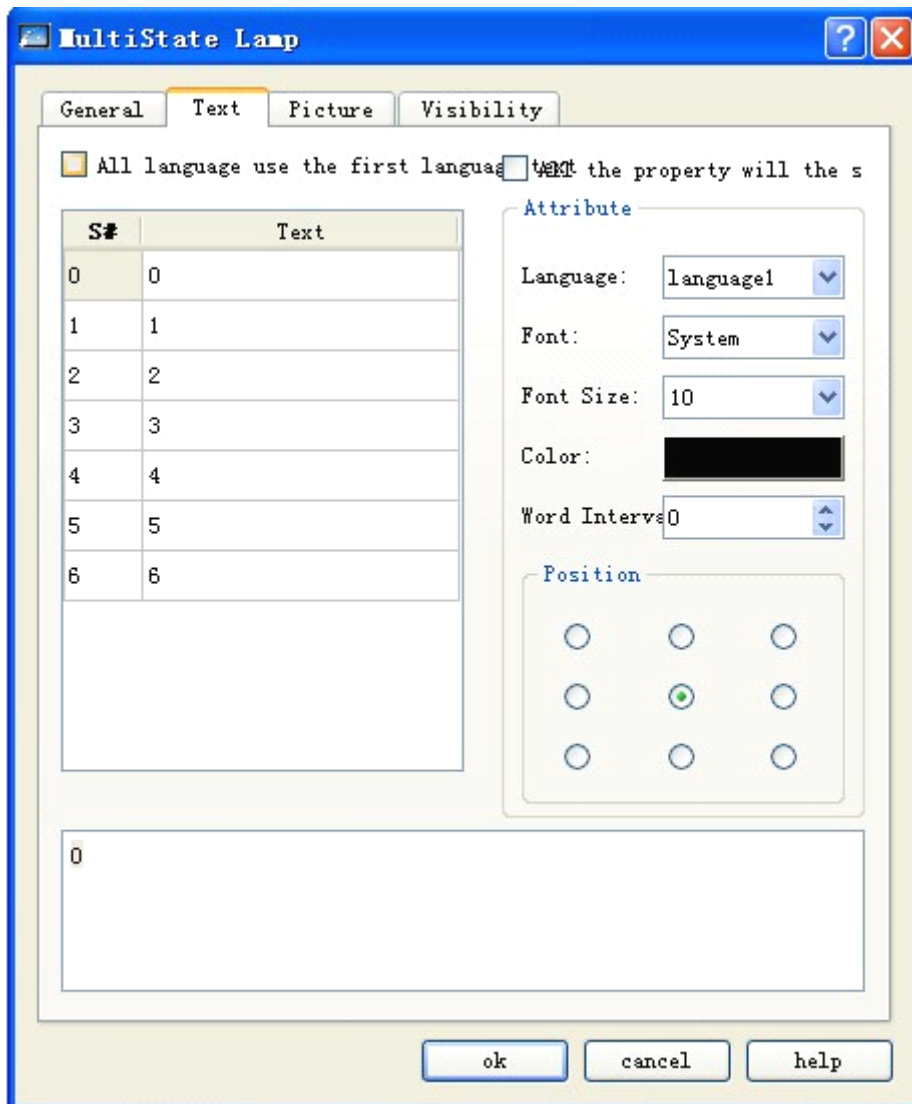

Figure 4-90: Text tab of multi-state lamp

- Text of the first language used for all languages: This option is used for multiple languages cases that are when the total numbers of languages is more than 1 in the Language option of the Project Manager. If this option is chosen, the language of the control will not be changed along with the language switch.
- Language: This option is used for multiple languages cases. You can choose different languages and enter different texts under different states, getting prepared for multiple language controls. Thus, when Switch Language option is chosen in the function buttons, and a target language is chosen, all the text controls in the screen will use specified language after clicking this function button. For different languages, text contents, font and font size may be different, but color, word space and position are the same.
- Font: Font of the text contents entered. You may choose different fonts for different states or languages.
- Font size: Font size of the text contents entered. You may choose different font sizes for different states or languages.
- Color, word space and position: Used to set the text color, word space and alignment mode under the current state. When the total numbers of languages is more than 1 in the Language option of the Project Manager, and the language other than language 1 is chosen, these three function options will be invalid, and the same text color, word space and position as that in language 1 will be applied.

3. Picture

Click Picture tab in the Multi-state lamp property dialog, and then a property setting dialog as shown in Figure 4-91 will appear.

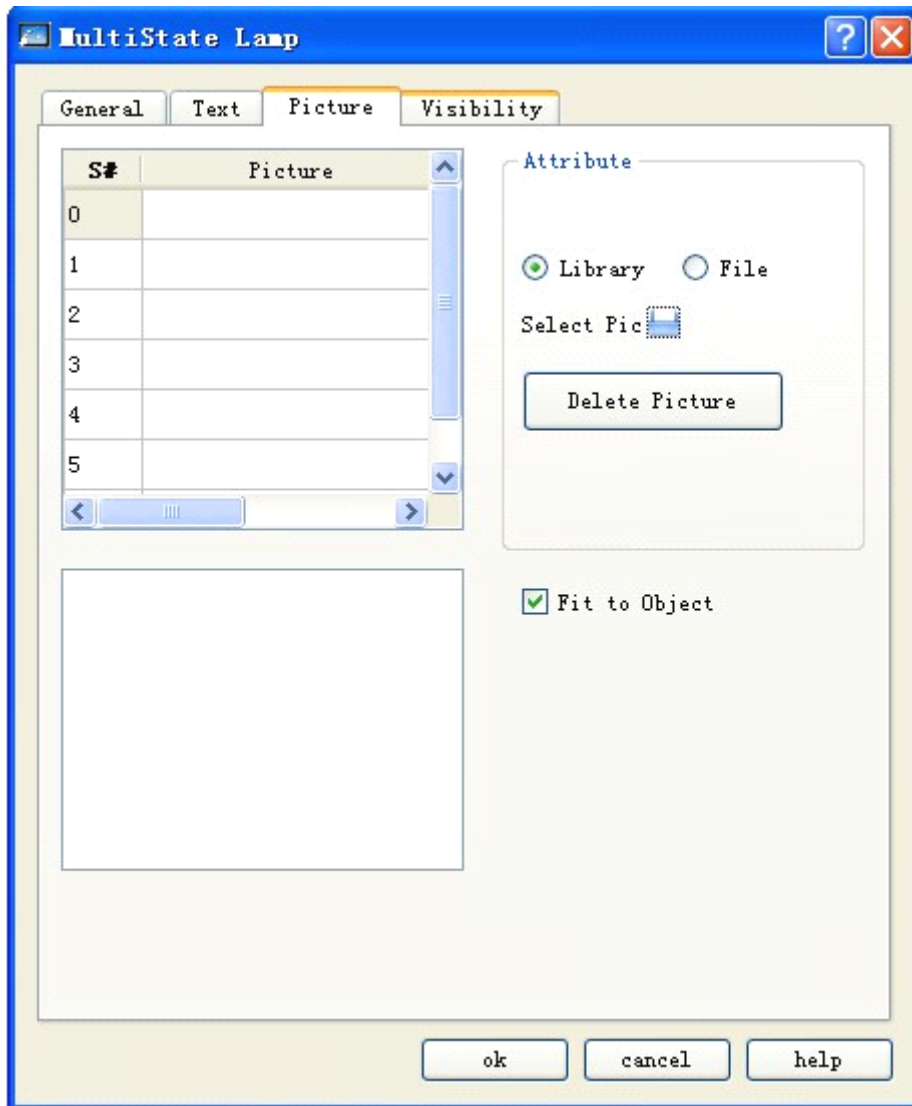



Figure 4-91: Picture tab of multi-state lamp

This tab is mainly used to load pictures for different states. By default the picture for each state is void, and you can change the picture to be displayed according to actual needs.

The steps are as follows: Choose the state to be modified in the list, choose whether the required picture is from system library or saved in Windows, click button , and add a picture from the system library or a directory of Windows. Then, you can see pictures corresponding to different states when you click the states in the list. In addition, you can also choose “Fit to Object” option. If this option is not checked, you can change the border interval and position of the picture in the control to beautify the control.

- Fit object size: If this option is chosen, the size of the graph is the same as the control in the General tab, and the Edge Distance and Position options will be invalid and hidden.
- When importing a picture from external files, there will be a Transparent option, which is used to change a specified color to transparency.



Refer to the introduction of Bit Button for Visibility tab.

After setting of the properties, click OK button, and then the mouse shape will become a cross. Now you can draw a rectangle in the screen by clicking the mouse and thus add this control into the screen.

4.5.7 Multi-state switch of SKWorkshop

Multi-state Switch has functions basically the same as the functions of Multi-state Lamp, except that in Multi-state Switch data can be entered in addition to the display function. The operations are as follows:

Click the Multi-state Switch icon  in the tool bar, and then a dialog as shown in Figure 4-92 will appear.

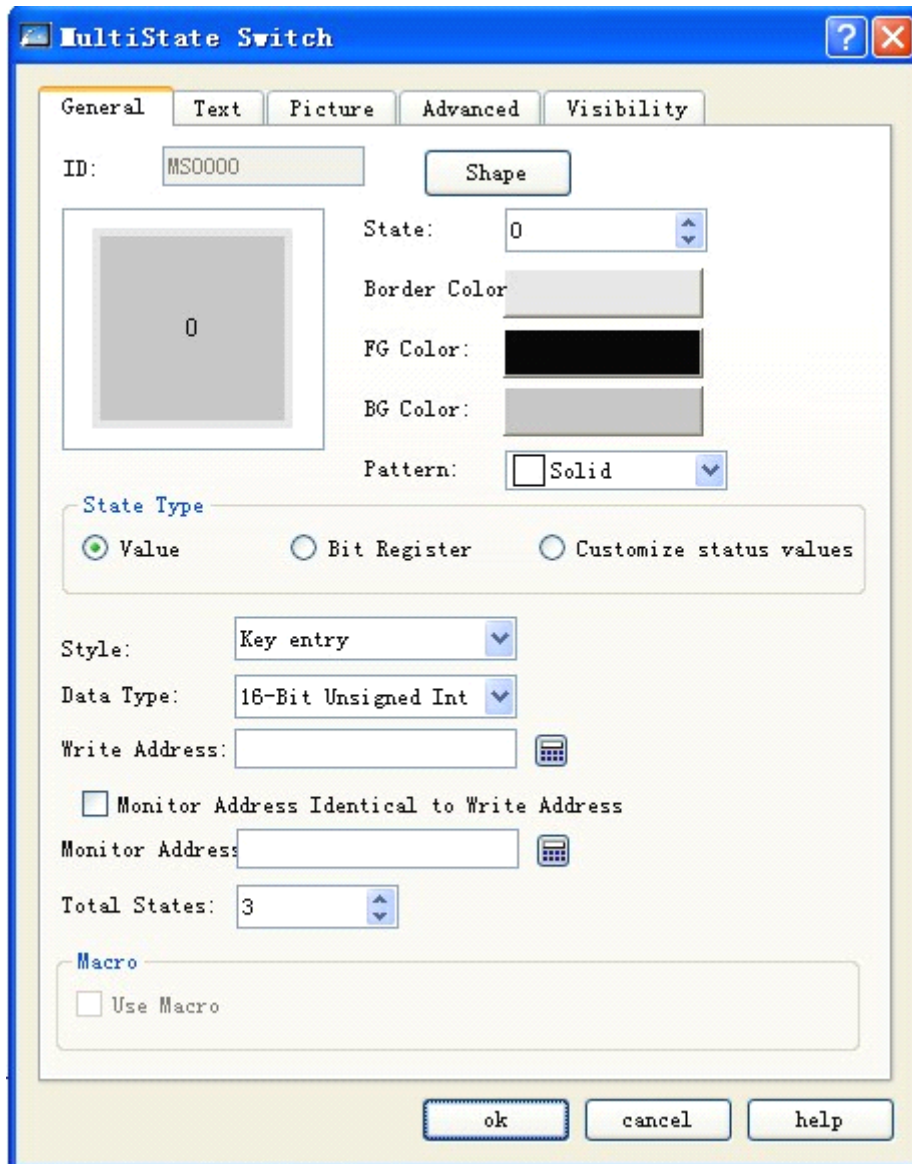

Figure 4-92: Multi-state switch dialog

- State: You can change this state value, and modify the border color, pattern color, background color and pattern of the control under different states.
- State type: (it is assumed that the number entered by the user is n)
 - ◆ Numerical value: The written value is a numerical value from 0 to the total number of states less 1.

- ◆ Register bit: The written value is the No. n power of 2. For example:

We assume State Type of this control is Numerical Value, Keyboard Input is chosen for Manner option, the write address is LW3, the option The Same Write Address and Monitor Address is chosen, and the total number of states is 8. After setting and clicking OK, click on the screen to add the control into the screen, add an value entering control in the screen, set both the write address and monitored address to LW3, and then save the project.

Click the number entering control in simulation or screen, and enter a desired state value in the pop-up keyboard. We assume the value entered is 3, then the value written to the register is the third power of 2, the value of the monitored (read) address is 3, and the control will display the texts under state 3 (that is the text contents under State 3 in the Text tab of this control). On the contrary, if the entered value for LW3 is 8, the control will display the text under state 3.

- ◆ User-defined state value: When this option is chosen, there will be a Define State Value button after the Total State Number, as shown in 4-93:

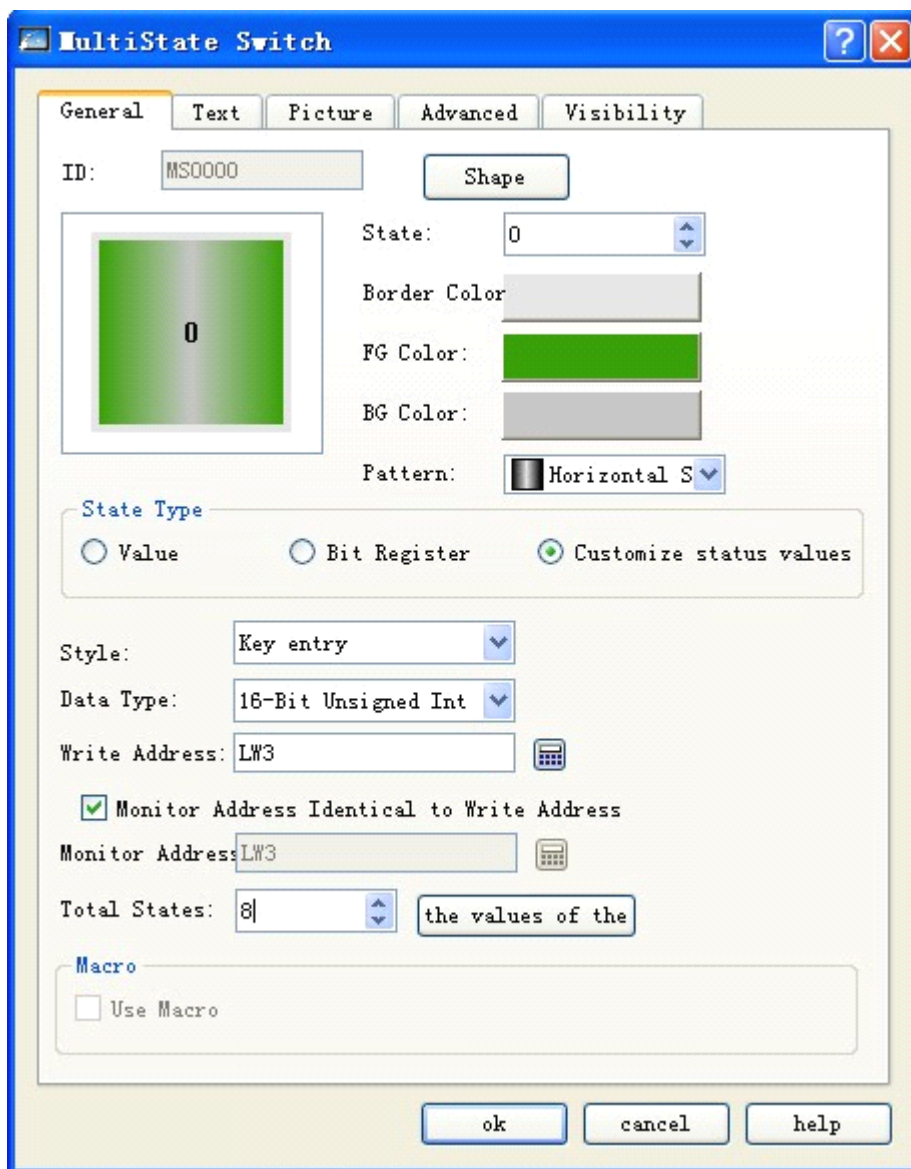

Figure 4-93: User-defined state value chosen for multi-state button

Click the Define State Value button, and then a dialog as shown in 4-94 will pop up:

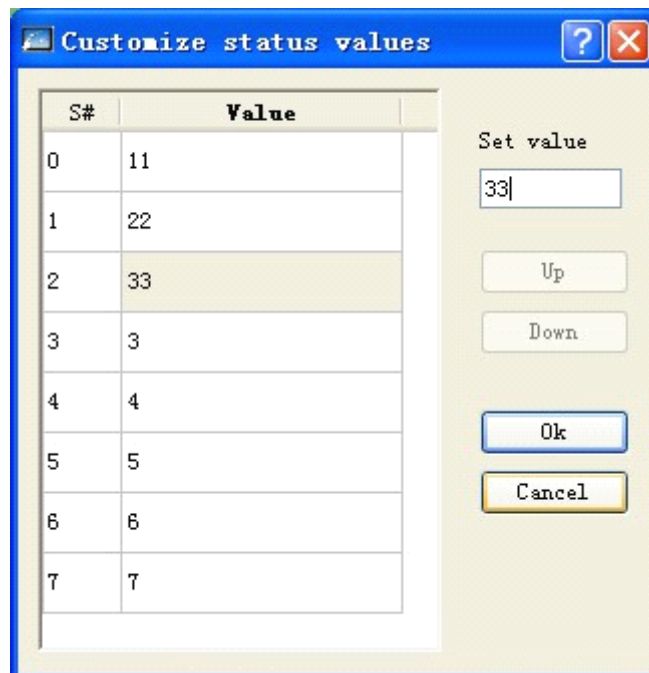

Figure 4-94: User-defined state value dialog

In this dialog, column S# is the current state column, which means that when you chose a line, the value corresponding to S# in the line indicates the current state value. Double click the Value column of a line, and then you can enter the value to be written under the current state.

For example, we assume State Type of this control is User-defined State Value, Keyboard Input is chosen for Manner option, the write address is LW3, the option The Same Write Address and Monitor Address is chosen, and the total number of states is 8. Click Define State Value button, and then complete setting in the pop-up dialog as shown in Figure 4-71. After setting and clicking OK, click on the screen to add the control into the screen, add an value entering control in the screen, set both the write address and monitored address to LW3, and then save the project. Click the number entering control in simulation or screen, and enter a desired state value in the pop-up keyboard. We assume the value entered is 1, then the value written to the register is 22, the value of the monitored (read) address is 1, and the control will display the texts under state 1 (that is the text contents under State 3 in the Text tab of this control). On the contrary, if the entered value for LW3 is 33, the control will display the text under state 2.

- Manner: There are four options that are Keyboard Input, Output Constant, Increase and Decrease.
 - ◆ Keyboard input: This can be chosen for all of the three options in State Type. If this option is chosen, when you click the control in the simulation or screen, a pop-up keyboard will appear so that you can enter a value, as shown in Figure 4-95:

Min: 0		Max: 7			
1	2	3	4	5	Del
6	7	8	9	0	Esc
00	.	+/-	Clr	Enter	

Figure 4-95: Keyboard

- ◆ Output constant: This option can be chosen only when the Numerical Value option in the three options of State Type is chosen. If this option is chosen, a Constant option will appear after the dropdown box of Manner. When you click the control in the simulation or screen, the value written will be this constant set here.
- ◆ Increase: This option can be chosen only when the Numerical Value option in the three options of State Type is chosen. If this option is chosen, when you click the control, the state number will increase by 1 each time you click until the state number is equal to the total state number.
- ◆ Decrease: This option can be chosen only when the Numerical Value option in the three options of State Type is chosen. If this option is chosen, when you click the control, the state number will decrease by 1 each time you click until the state number is equal to the total state number.
- Data type: Data type of the write address and monitored (read) address.
- Monitored address: The same to read address. The value of this address is the read state value, and the user-chosen state will be shown in the control.
- Total state number: The maximum number of the states that can be set.
- User Macro: If this option is chosen, when you click the control in online simulation or screen the chosen macro will be executed.



Refer to the introduction of Bit Button control for setting of Shape, Border Color, FG Color, BG Color and Pattern.



Refer to the introduction of Multi-state Lamp control for setting of Text and Picture tabs.



Refer to the introduction of Bit Button control for setting of Advanced and Visibility tabs.

After setting of these parameters, click OK, and then the mouse will become . Draw a rectangle in the picture area by left clicking the mouse, and then the control will be displayed.

4.5.8 Numeric display of SKWorkshop

Numeric Display control is a common control used to display the data saved in the data register of PLC or other connected devices, such as speed, current, pressure, and the like.

Click Numeric Display icon  in the tool bar, and then a dialog as shown in Figure 4-96 will appear.

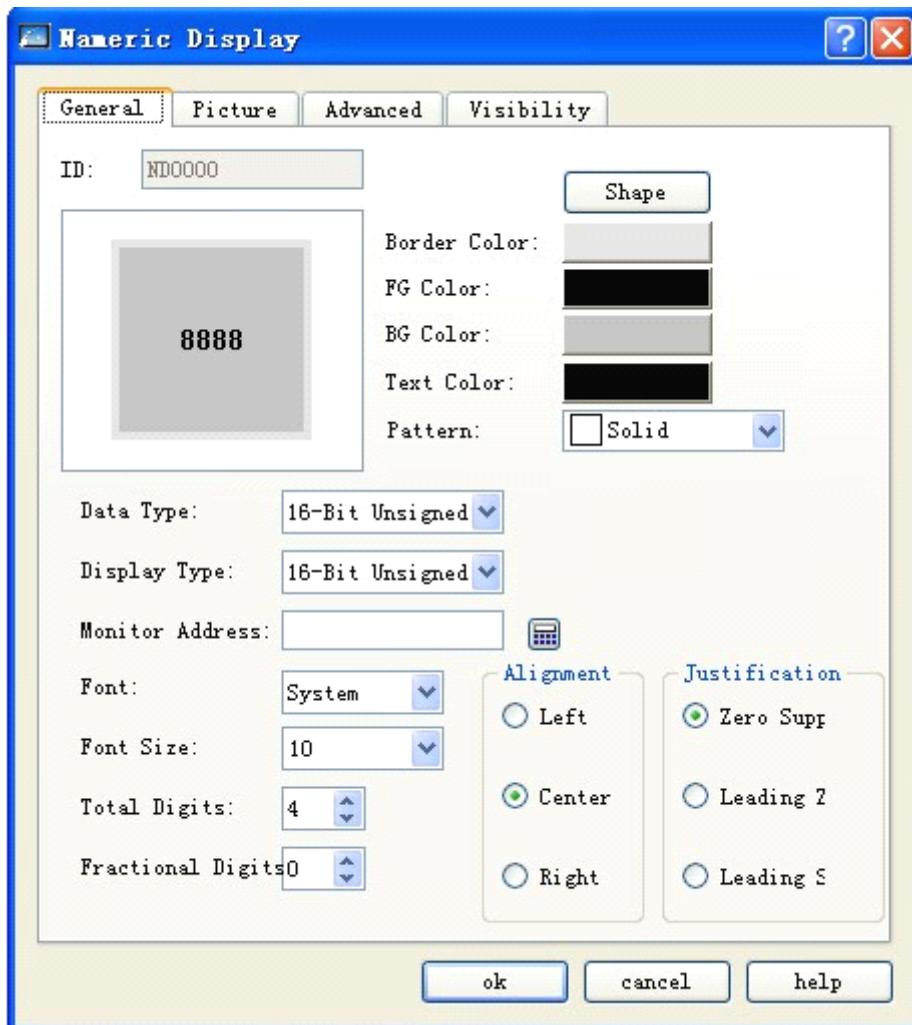

Figure 4-96: Numeric display dialog

In this dialog you can set the data register address of the PLC or other connected device where the data to be displayed are saved, total display digits of the data, fractional digits of the data, font size, font color, alignment and value adjustment.

Data type: Here you can choose different data types according to the data in the register address to be monitored.

Display type: Here you can choose different display types according to actual needs.

Monitor address: This control is used to display data, and the Monitor Address is the data register address of the PLC or other connected device to be displayed.

Fractional digits: The number of fractional digits of the data to be displayed.

Font: Here you can choose common font or digital font.

Font size: Here you can change the font size according to actual needs.

Alignment: Center alignment by default.

Left: Align the data to be displayed on the left side of the display box.

Center: Align the data to be displayed in the middle of the display box.

Right: Align the data to be displayed on the right side of the display box.

Justification: Zero Suppres by default.

Zero Suppres: Zeros in front of the effective digits will not be displayed. For example, if the number of the monitored address is a 16-digit positive integer and its value is 00123, then the number displayed in the display box will be “123”.

Leading zero: Zeros in front of the effective digits will be displayed. For example, if the number of the monitored address is a 16-digit positive integer and its value is 00123, then the number displayed in the display box will be “00123”.

Leading space: Zeros in front of the effective digits will not be displayed but be replaced by space. For example, if the number of the monitored address is a 16-digit positive integer and its value is 00123, then the number displayed in the display box will be “123”.

Text color: Font color of the data to be displayed.



: Refer to the introduction of Bit Button control for setting of Shape, Border Color, FG Color, BG Color and Pattern.



: To reset the contents and properties of Numeric Display, you can double click the Numeric Display dialog. When this control is executed in HMI, a keyboard will pop up on the screen for users to enter the data.



: Fractional digits: Setting of this parameter will impact the data display effect. If the data type chosen is 16/32-digit positive integer or 16/32-digit integer, the number displayed will be the return number subject to decimal point left movement by the number of digits as set in this parameter. For example, if the return number is 212 and the number of fractional digits set here is 2, then 2.12 will be displayed. If the data type chosen is 32-digit floating point number, then the decimal point will not be moved but only the set fractional digits will be displayed. For example, if the return number is 2.123 and the number of fractional digits set here is 2, then 2.12 will be displayed.



: Total digits: The sum of the number of integer digits and fractional digits. If the integer length of the number to be displayed is longer than the set value, the integer length displayed will be the integer length of the actual number. For example, if the return number is 2123, the data length is 2 and the number fractional digits are 1, then 212.3 will be displayed.

Advanced tab of Numeric Display has powerful functions, including Scaling and Range Display. See Figure 4-97.

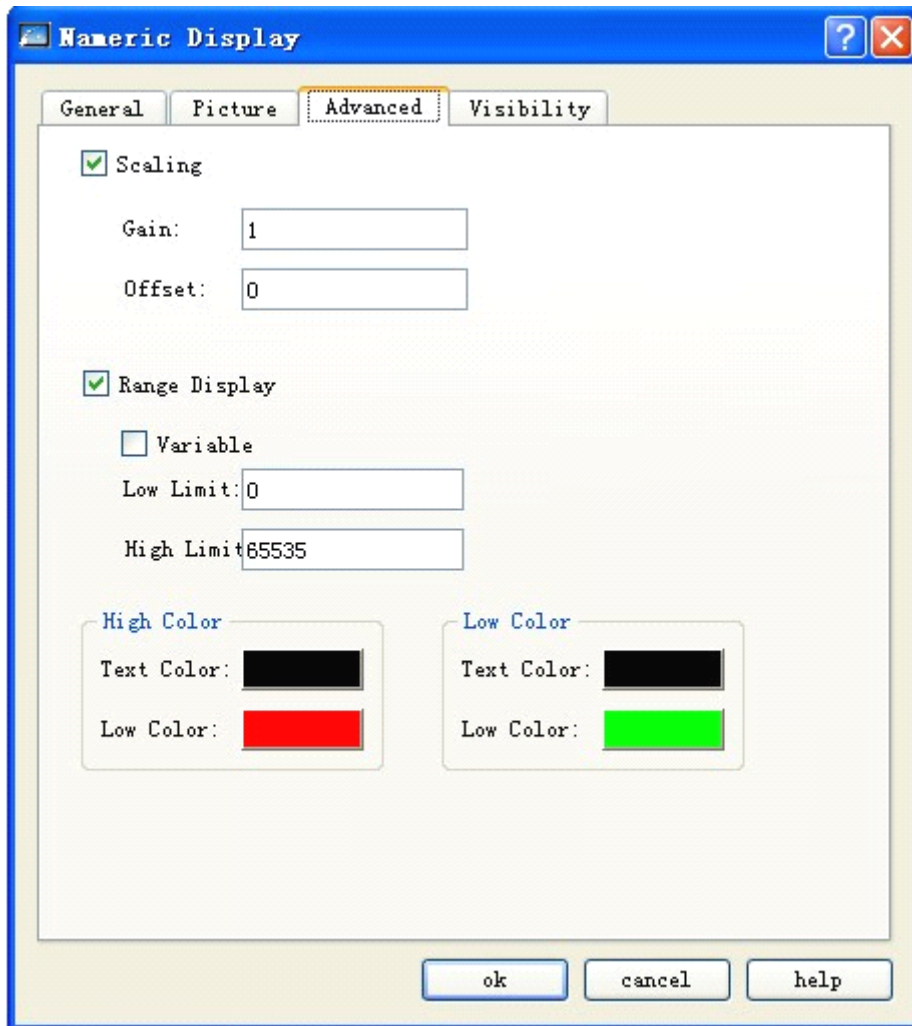

Figure 4-97: Advanced tab of numeric display

- Scaling: When this option is checked, the data displayed will be: Value of monitored address x Gain + Offset
- Range display:
- Range display: If this option is chosen, you can set the lower limit, higher limit, lower level color and higher level color, and then value of the monitored (read) address will be reflected with different colors in the set range.
- Variable range: The values of Lower Limit and Higher Limit are changing, depending on the address entered by the user.
- Lower limit: When the value of the monitored (read) address is lower than this limit, the pattern color and background color of the control will be the pattern color and background color set in the Lower Level Color.
- Higher limit: When the value of the monitored (read) address is higher than this limit, the pattern color and background color of the control will be the pattern color and background color set in the higher Level Color.

For example, if the BG color and text color in General tab are defined with Range Display checked, as shown in Figure 4-98.

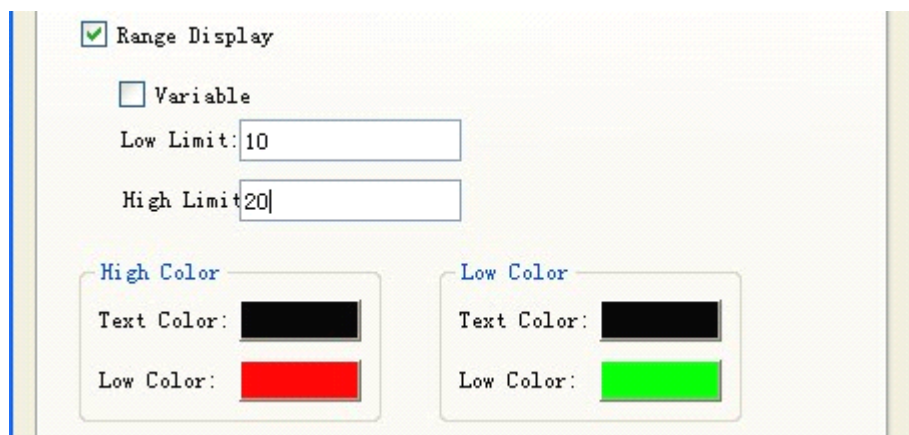
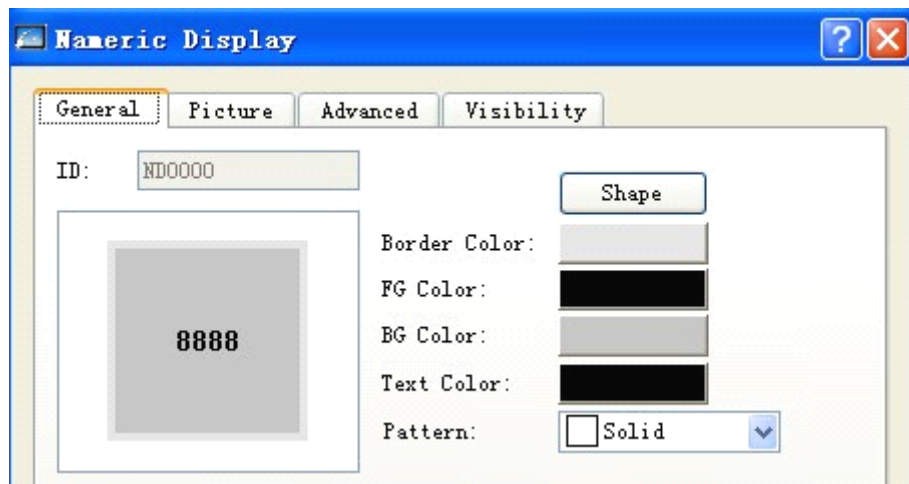

Figure 4-98: Range display checked

The text and background color of the Numeric Display will change with the change of the value of the monitored address, as shown in Figure 4-99.



Figure 4-99: An example of numeric display



Refer to Bit Button control for setting of Visibility tab.



When 32-digit data type is chosen for Numeric Display, the save address occupies two characters. For example, when writing data to data register of Siemens PLCs, and the write address is V10, the occupied addresses of the data register are V10 and V11. If you try using other controls to monitor the value of V11, there may be errors. Thus, pay attention to 32-digit data type to avoid mis-operation over data and address.

After setting of the properties, click OK button, and then the mouse shape will become a cross. Now you can draw a rectangle in the screen by clicking the mouse and thus add this control into the screen.

4.5.9 Numeric entry of SKWorkshop

Numeric Entry control is the most frequently used control, as data (analog quantity) need to be operated in almost all process controls. With Numeric Entry you can enter and display the data saved in the data register of PLC or other connected devices, such as speed, current, pressure and the like.

Numeric Entry has functions basically the same as Numeric Display, except that with Numeric Entry you can enter data to the data register of PLC or other connected devices in addition to data display. The steps to create a Numeric Entry touch button are as follows:

Click Numeric Entry icon  in the tool bar, and then a dialog as shown in Figure 4-100 will appear.

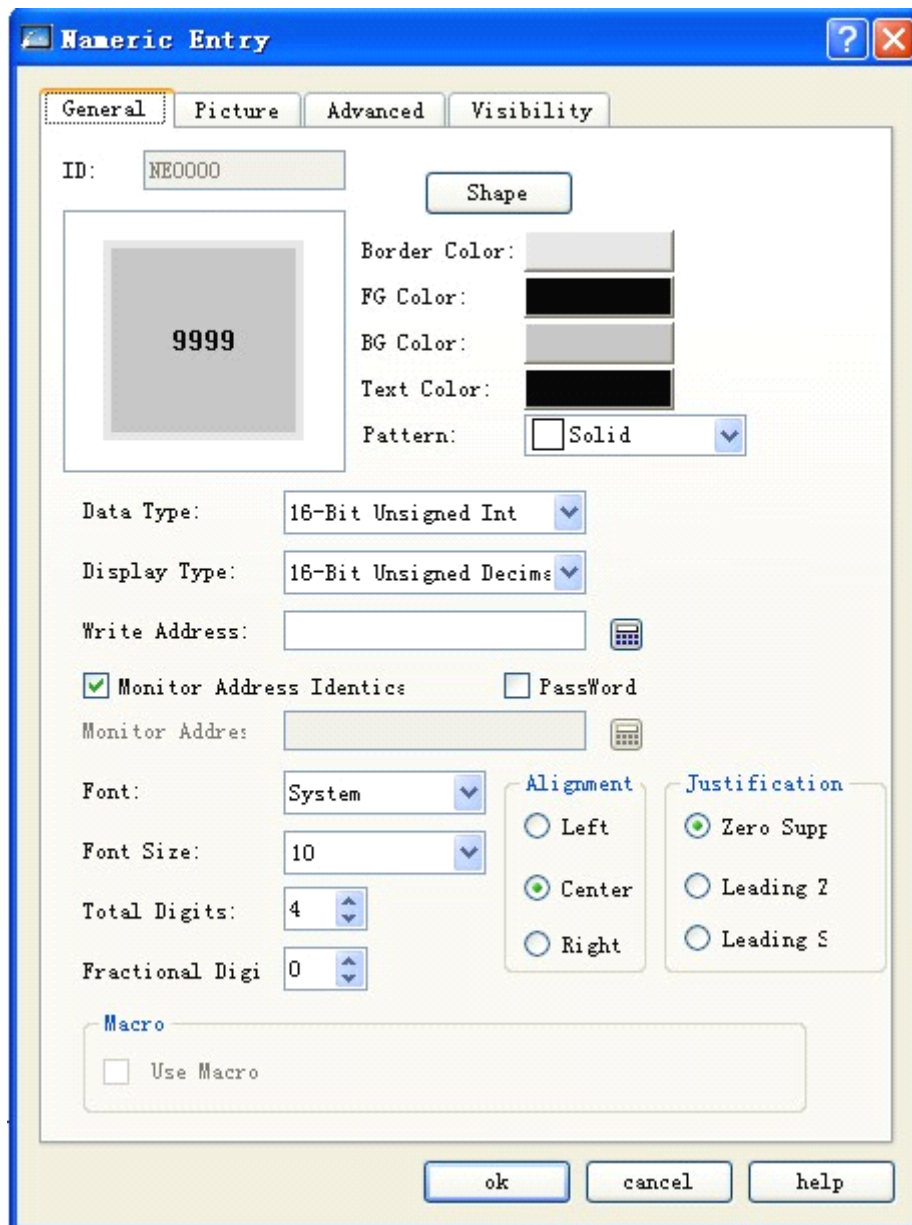

Figure 4-100: Numeric entry dialog



Refer to Bit Button control for setting of Shape, Border Color, FG Color, BG Color and Pattern.



Refer to Numeric Display control for use of Alignment, Justification, Total Digits and Fractional Digits.



To reset the contents and properties of Numeric Entry, you can double click the Numeric Entry dialog. When this control is executed in HMI, a keyboard will pop up on the screen for users to enter the data. See Figure 4-101.

Min: 0		Max: 7			
1	2	3	4	5	Del
6	7	8	9	0	Esc
00	.	+/-	Clr	Enter	

Figure 4-101: Number entering keyboard



When 32-digit data type is chosen for Numeric Display, the save address occupies two characters. For example, when writing data to data register of Siemens PLCs, and the write address is V10, the occupied addresses of the data register are V10 and V11. If you try using other controls to monitor the value of V11, there may be errors. Thus, pay attention to 32-digit data type to avoid mis-operation over data and address.



Fractional digits: Setting of this parameter will impact the data display effect. If the data type chosen is 16/32-digit positive integer or 16/32-digit integer, the number displayed will be the return number subject to decimal point left movement by the number of digits as set in this parameter. For example, if the return number is 212 and the number of fractional digits set here is 2, then 2.12 will be displayed. If the data type chosen is 32-digit floating point number, then the decimal point will not be moved but only the set fractional digits will be displayed. For example, if the return number is 2.123 and the number of fractional digits set here is 2, then 2.12 will be displayed.



Total digits: The sum of the number of integer digits and fractional digits. If the integer length of the number to be displayed is longer than the set value, the integer length displayed will be the integer length of the actual number. For example, if the return number is 2123, the data length is 2 and the number fractional digits are 1, then 212.3 will be displayed.

- Password input: If this option is chosen, the characters entered by the user will be displayed as “*” during the entering and display process.
- If “Use Macro” option is checked, a list of macros will be displayed, and you can choose a macro so that this macro will be executed when the Numeric Entry button is pressed. Only successfully compiled macros are displayed in the drop-down list.
- Advanced tab of Numeric Entry: This tab is mainly used to set Gain, Offset and Range Check (checking whether the data entered exceed the range set) of the data entered. Besides, there are also Touch Availability and Notification options in this tab, which have the same functions as the corresponding options in Bit Button control.

Click the Advanced tab, and then a dialog as shown in 4-102 will appear.

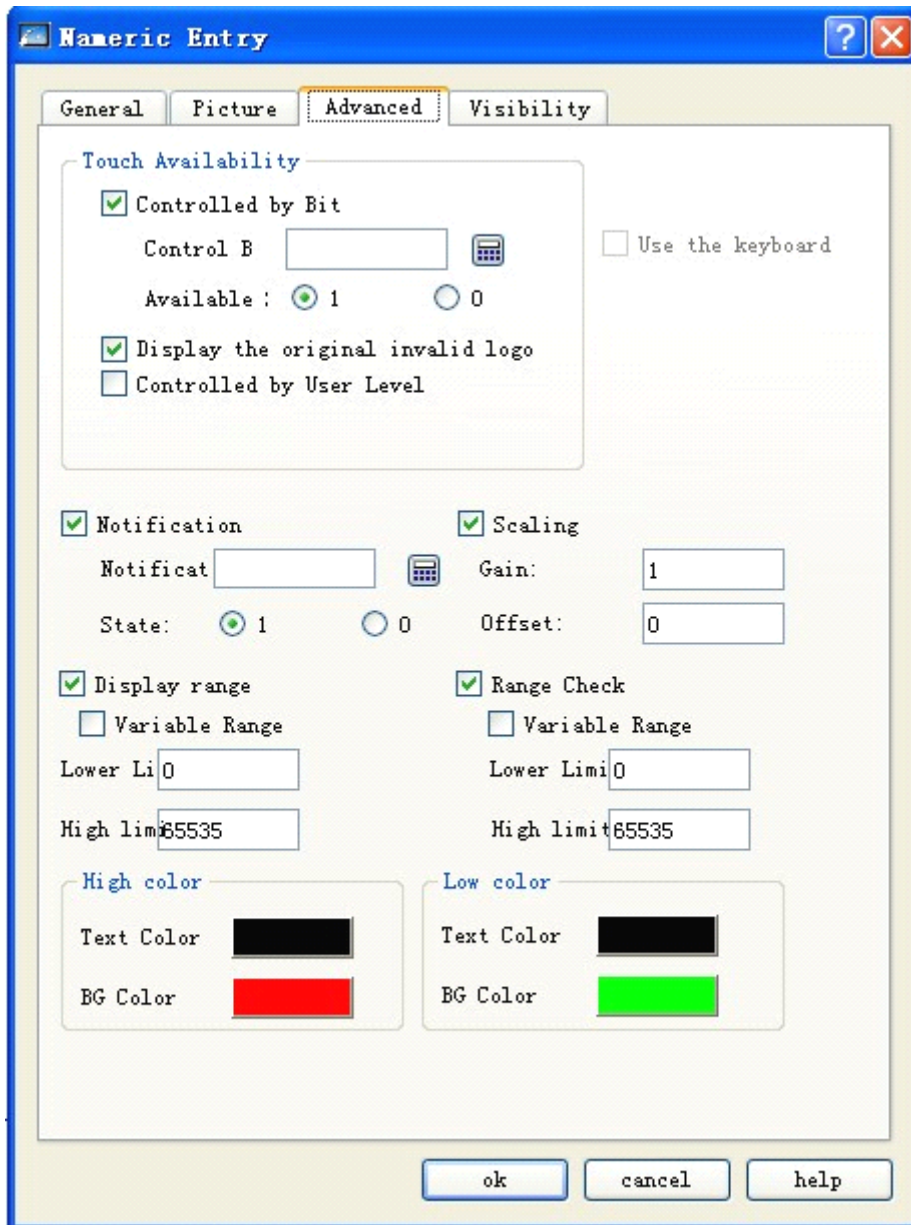

Figure 4-102: Advanced tab of numeric entry

- Bit controlled: If this option is chosen, the control will be touchable only when specified conditions are met, that is the address value of the control bit is equal to the valid state value.

For example, if the address of Control Bit is LB1 and the Valid State is 1, then the Number Entering control will be touchable in simulation or screen when and only when the value of LB1 is equal to 1.

- Display Invalidation sign: When this option is chosen, and the control is not touchable, the control will be covered by the picture set in Use Sign option in Touch Screen Parameter Setting, indicating that this control is not touchable.
- Effective level controlled: You can choose several options basing on the actual needs. After setting, the touch level of this control will be compared with the Default User Level in the User Password Setting in the Touch Screen Parameter Setting to determine whether the control is touchable.

For example, if option 2 and 3 are chosen in the Effective Level Controlled in the Advanced Tab of the control, and the User Password Setting in the Touch Screen Parameter Setting is as shown in Figure 4-103:

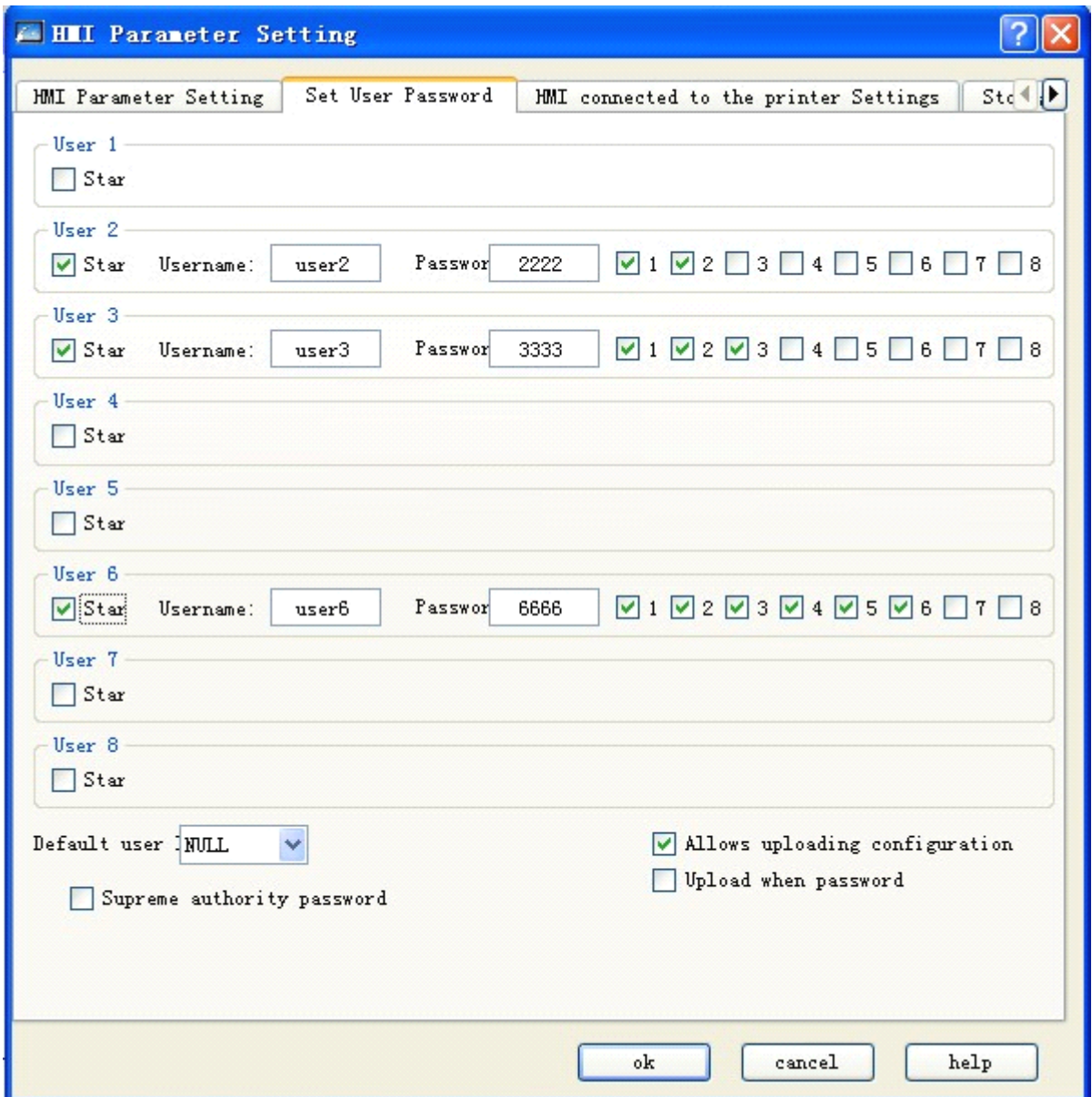

Figure 4-103: User Password setting in the touch screen parameter setting

Then: if Default User Level is NULL, this control is not touchable, and in this case you can use Change User Level in Function buttons to change the default level. For example, if the password entered by the user is 6666, corresponding to User Level 6, but the user chooses only option 1, not matching option 2 or 3, so the system will prompt that the password is incorrect; When the password entered by the user is 2222 or 3333, as both users have option 2, matching option 2 or 3, the password is valid and this control will be changed to a touchable control. If the Default User Level is user 2 to 3, then both user levels have option 2 to match the touching conditions, and then this control is touchable in simulation or initialized screen; If the Default User Level is user 3, then this user level does not have an option to match the touching conditions, and then this control is not touchable in simulation or initialized screen.

- Notification: When the control is touchable, if you click this control and enter a value in the pop-up keyboard, the system will write a user-specified state value (1 or 0) to the Notification Bit address set by the user.

- Scaling: When this option is chosen, the value of the write address = (value entered by the user using the pop-up keyboard – offset) / gain; the displayed value (value of the monitored address) = value of the monitored address x gain + offset.
- Range display: If this option is chosen, you can set the lower limit, higher limit, lower level color and higher level color, and then value of the monitored (read) address will be reflected with different colors in the set range.
 - ◆ Variable range: The values of Lower Limit and Higher Limit are changing, depending on the address entered by the user.
 - ◆ Lower limit: When the value of the monitored (read) address is lower than this limit, the pattern color and background color of the control will be the pattern color and background color set in the Lower Level Color.
 - ◆ Higher limit: When the value of the monitored (read) address is higher than this limit, the pattern color and background color of the control will be the pattern color and background color set in the higher Level Color.
 - ◆ After setting of the properties, click OK button, and then the mouse shape will become a cross. Now you can draw a rectangle in the screen by clicking the mouse and thus add this control into the screen.
- Range check: Mainly used to check the value entered by the user to ensure it does not exceed the maximum and minimum values set by the user.
- After setting of the properties, click OK button, and then the mouse shape will become a cross. Now you can draw a rectangle in the screen by clicking the mouse and thus add this control into the screen.

4.5.10 ASC character display of SKWorkshop

ASC Character Display is used to display the ASC characters in the connected device.

Click ASC Character Display icon  in the tool bar, and then a dialog as shown in Figure 4-104 will appear.

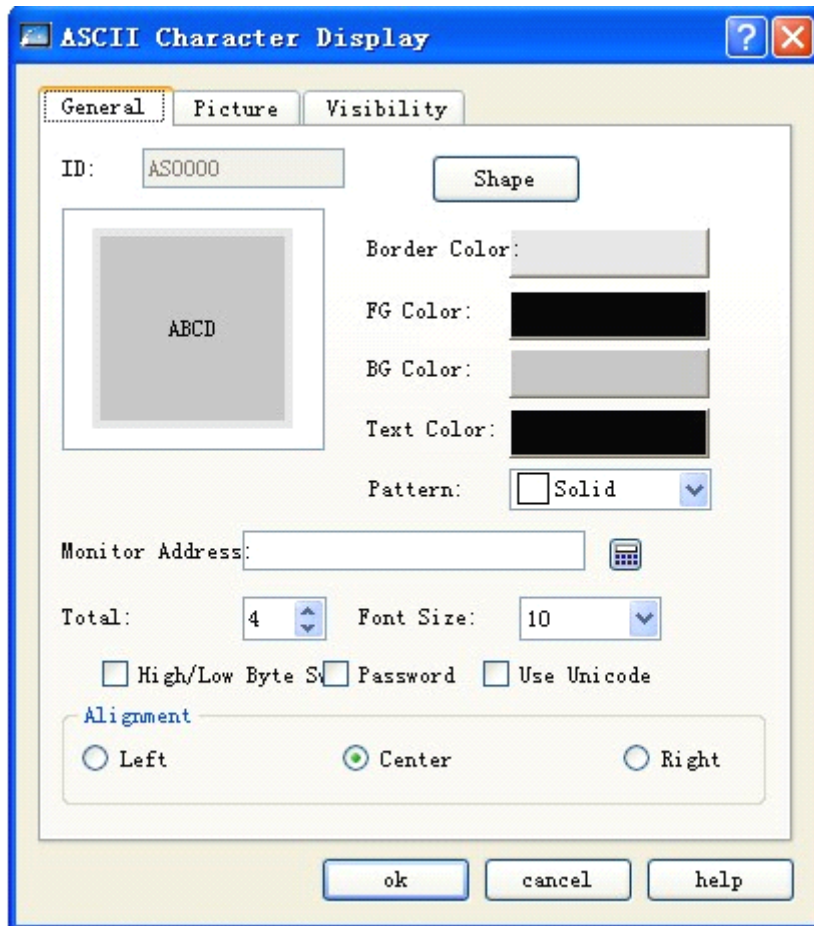

Figure 4-77: ASC character display dialog

In this dialog you can set the monitor address of the connected device to be displayed, font size of the texts to be displayed, and some other properties.

- Monitor: The control reads the value of a specified address and displays it on the control.
- Total word number: Maximum number of characters that can be displayed for the monitored address.
- Font size: Size of the characters to be displayed.
- Swap between higher and lower bytes: Change the higher bytes of the monitored address with the lower bytes.
- Password: If this option is chosen, the control does not display specific characters but “*” instead.
- Use UNICODE: Display the value of the monitored address with Unicode codes.
- Align: Align the displayed characters on the left, in the middle or on the right basing on user selection.



Refer to Bit Button control for setting of Shape, Border Color, FG Color, BG Color and Pattern.



If transparent option is chosen, the BG color setting will be ineffective.



Refer to Bit Button control for use of the Visibility tab.

4.5.11 ASCII character entry of SKWorkshop

Click ASCII Character Entry icon  in the tool bar, and then a dialog as shown in Figure 4-105 will appear.

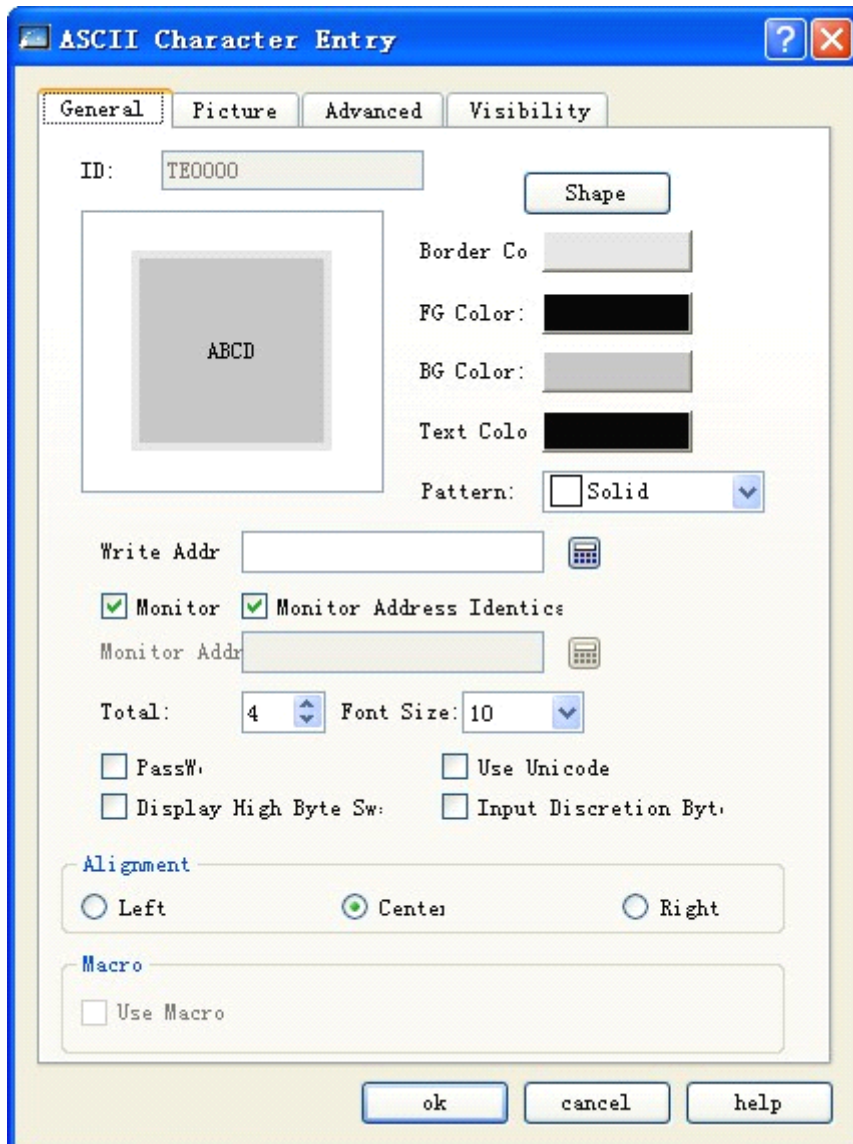

Figure 4-105: ASC character entry dialog

- Write address: The address where the ASCII texts entered by the user will be saved.
- Monitor: The control reads the value of a specified address and displays it on the control.
- Monitoring address is same to write-in address: read and write is the same address; monitoring address is same to write-in address.
- Monitoring address: the address to read.
- Total word number: Maximum number of characters that can be displayed for the monitored address.

- Font size: Size of the characters to be displayed.
- Swap between higher and lower bytes: Change the higher bytes of the monitored address with the lower bytes.
- Password: If this option is chosen, the control does not display specific characters but “*” instead.
- Use UNICODE: Display the value of the monitored address with Unicode codes.
- Align: Align the displayed characters on the left, in the middle or on the right basing on user selection.
- After setting of the properties, click OK button, and then the mouse shape will become a cross. Now you can draw a rectangle in the screen by clicking the mouse and thus add this control into the screen.
- Macro: If “Use Macro” option is checked, a list of macros will be displayed, and you can choose a macro so that this macro will be executed when the Multi-state switch is pressed. Only successfully compiled macros are displayed in the drop-down list.



Pay attention when selecting Write Address. For example, when writing ASCII characters to data register of Siemens PLCs, and the write address is V10, the occupied addresses of the data register are V10 and the subsequent continuous addresses. The length of the occupied addresses is determined by the total character number. If the total character number is 12, then the address from V10 to V21 will be occupied. If you try using other controls to monitor the value of the occupied address, there may be errors. Thus, pay attention to ASCII character display to avoid mis-operation over data and address.



Other options in General tab of this control are the same as those in ASCII Character Display.



Refer to Bit Button control for use of the Advanced and Visibility tabs.

4.5.12 Bar graph of SKWorkshop

The main function of Bar Graph control is to present the real-time change in the data in the form of bars so that you can see the change clearly and easily.

Bar Graph can present the change in the data saved in the data register of PLC or other connected devices, or present directly the real-time change of all analog quantities on the process flow. See Figure 4-106.

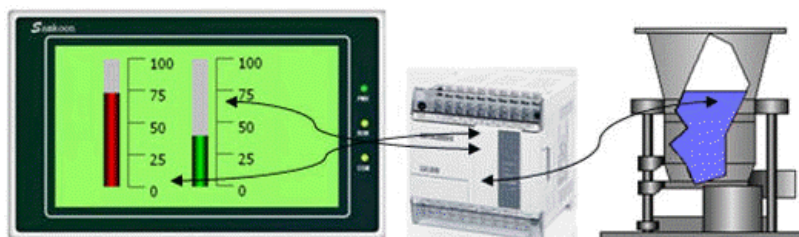



Figure 4-106

The steps to insert a bar graph and modify properties of a bar graph are as follows:

1. Click Bar Graph icon  in the tool bar or the Bar Graph command in Tool menu, and then a dialog as shown in Figure 4-107 will appear.
2. In the pop-up dialog, set properties of the bar graph and click OK.
 - BG Color: Background color of the bar graph.

- Border color: Border color of the bar graph. Setting of border color in Figure 4-107 is invalid, and you can choose another graph in Shape and then choose the border color to see the change.
- Transparent: Set transparent background border for the bar graph.
- Direction: The rolling direction of the bar graph, including upward, downward, leftward and rightward.
 - Upward: When the value of the monitor address increases, the bar rolls from the bottom to top.
 - Downward: When the value of the monitor address increases, the bar rolls from top to bottom.
 - Leftward: When the value of the monitor address increases, the bar rolls from right to left.
 - Rightward: When the value of the monitor address increases, the bar rolls from left to right.
- Data type: Data type of the read address value, either word address or double word address.
- Monitored address: Address of the data register presented by the bar graph, the same to read address.
- Max: The maximum value of the monitored (read) address that can be presented by the bar graph. When the value of the monitored (read) address is higher than this value, the bars will be full and will not reflect the change in the value of the monitor address.
- Min: The minimum value of the monitored (read) address that can be presented by the bar graph. When the value of the monitored (read) address is lower than this value, the bars will be empty and will not reflect the change in the value of the monitor address.
- Variable range: When this option is chosen, the values of Max and Min are changing, depending on the address entered by the user. Data type of the address is the same as the Data Type chosen by the user.
- Bipolar Bar: Bars that can extend to both sides along with the change in the value of the data register.
- Middle point: Middle point value of the bipolar bar.

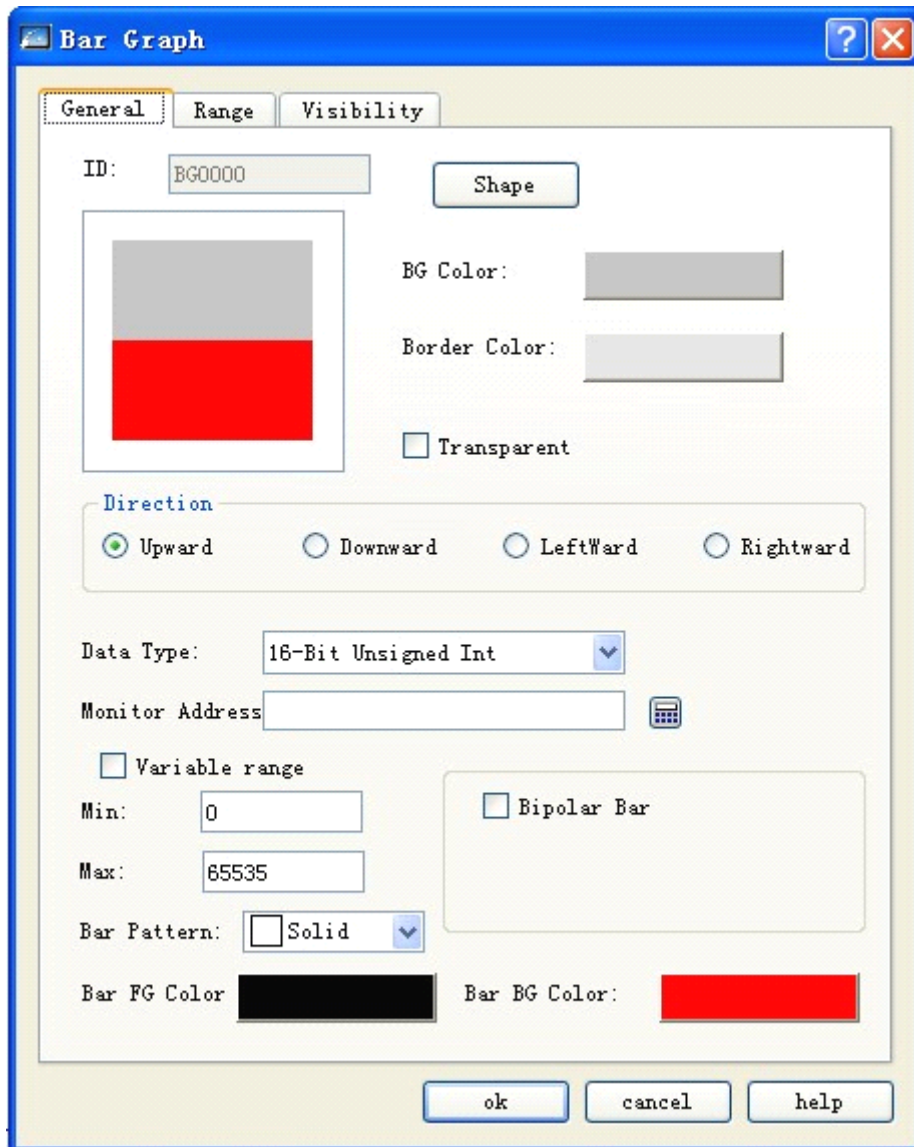

Figure 4-107: Bar graph dialog

For example, if the Max is 100, the Min is 10, the Direction is Upward, and this Bipolar Bar option is checked, a “Middle Value” entry will appear, and you can enter a number here as the mid point value. For example, if 70 is entered, then the bars change as shown in Figure 4-108 when the value of the monitor address increases from 0.

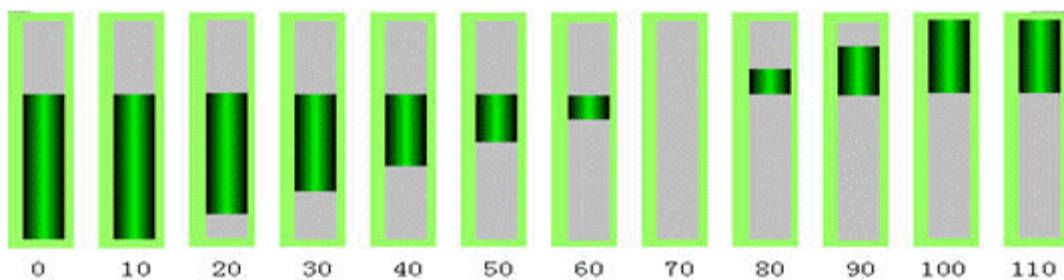

Figure 4-108

3. Modifying bar graph: Move the mouse to the bar graph and left click, and then 8 small green dots will appear around the bar graph. Move the mouse to a dot, press down the left key and drag the mouse to change the size of the bar.

Range tab of Bar Graph:

This tab is mainly used to display the value of the monitor address with different graph color and background color within preset range. See Figure 4-109.

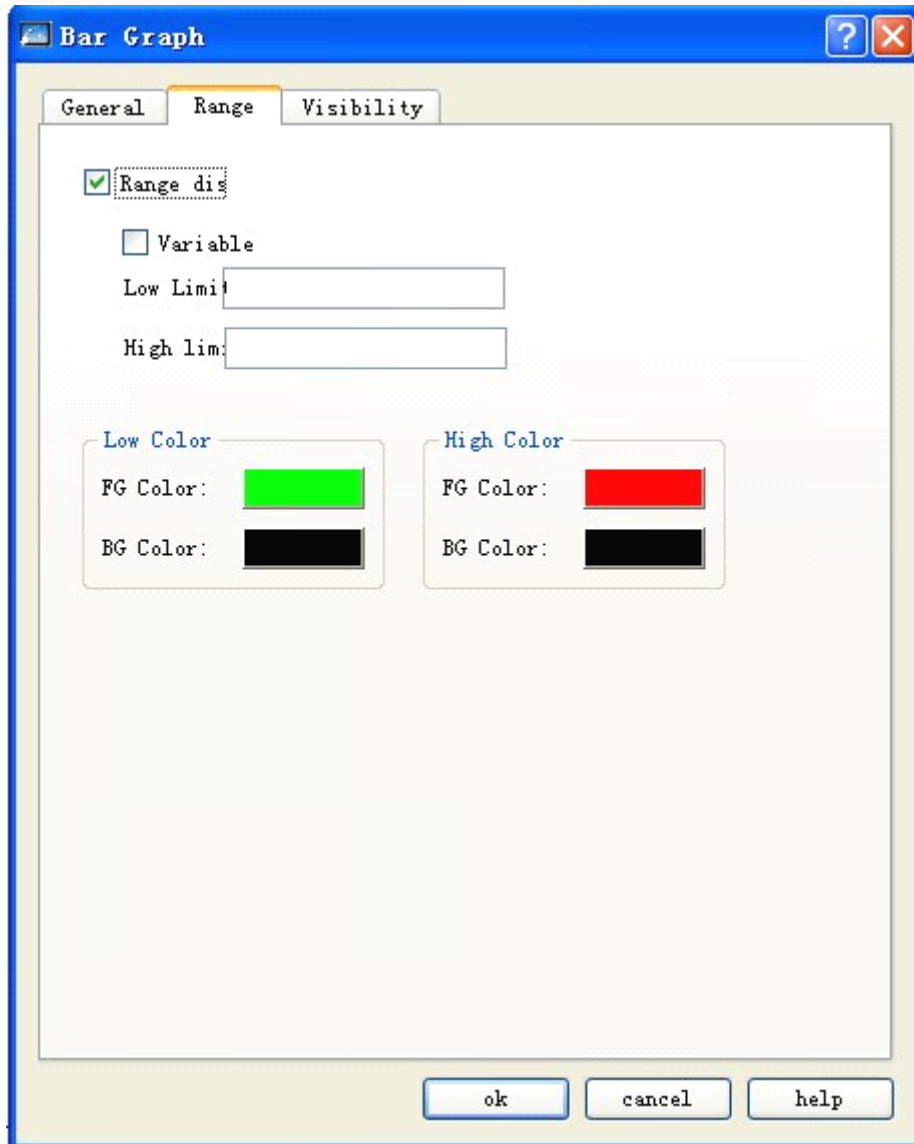

Figure 4-109: Range tab of bar graph

- Range display: If this option is chosen, you can set the lower limit, higher limit, lower level color and higher level color, and then value of the monitored (read) address will be reflected with different colors in the set range.
- Variable range: The values of Lower Limit and Higher Limit are changing, depending on the address entered by the user.
- Lower limit: When the value of the monitored (read) address is lower than this limit, the pattern color and background color of the control will be the pattern color and background color set in the Lower Level Color.

- Higher limit: When the value of the monitored (read) address is higher than this limit, the pattern color and background color of the control will be the pattern color and background color set in the higher Level Color.
- After setting of the properties, click OK button, and then the mouse shape will become a cross. Now you can draw a rectangle in the screen by clicking the mouse and thus add this control into the screen.



When the value of the monitored (read) address is higher than the lower limit and lower than the higher limit, the pattern color and background color of the bar graph will be the pattern color and background color set in the General tab.



Refer to Bit Button control for use of the Visibility tab.

4.5.13 Time display of SKWorkshop

Time Display control is mainly used to display system time. Click Time Display control icon  in the tool bar, and then a dialog as shown in Figure 4-110 will appear.

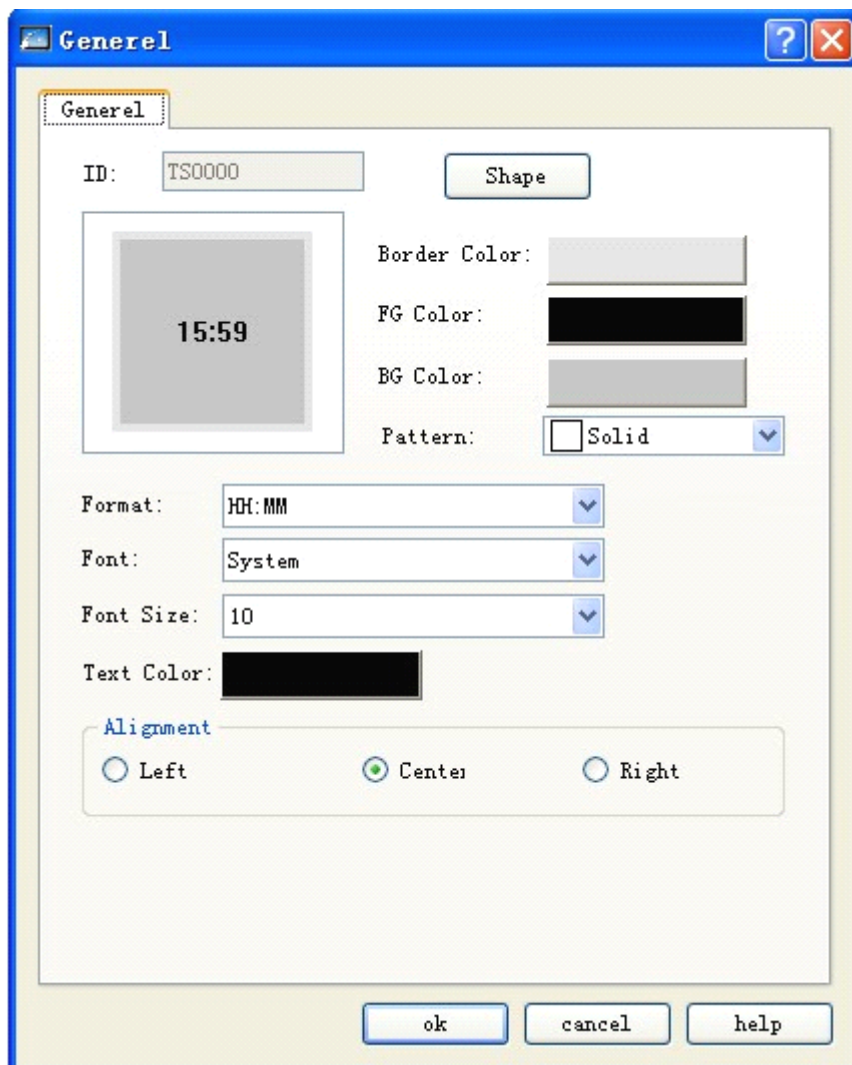

Figure 4-110: Time display dialog



Refer to Bit Button control for setting of Shape, Border Color, FG Color, BG Color and Pattern.

- Format: Format of time display, including two formats, that is:

HH:MM Hour: Minute

HH:MM:SS Hour: Minute: Second

HH-MM-SS Hour-Minute-Second

HH-MM Hour-Minute

- Font: Here you can choose common font or digital font.
- Font size: Here you can change the font size according to actual needs.
- Text color: Here you can change the color of the time display text.
- Alignment: Here you can have the time displayed on left side, on right side or in the middle.

After setting of these parameters, click OK, and then the mouse will become . Draw a rectangle in the picture area by left clicking the mouse, and then the control will be displayed.

4.5.14 Date display of SKWorkshop

Date Display control is mainly used to display system date. Click Date Display control icon  in the tool bar, and then a dialog as shown in Figure 4-111 will appear.

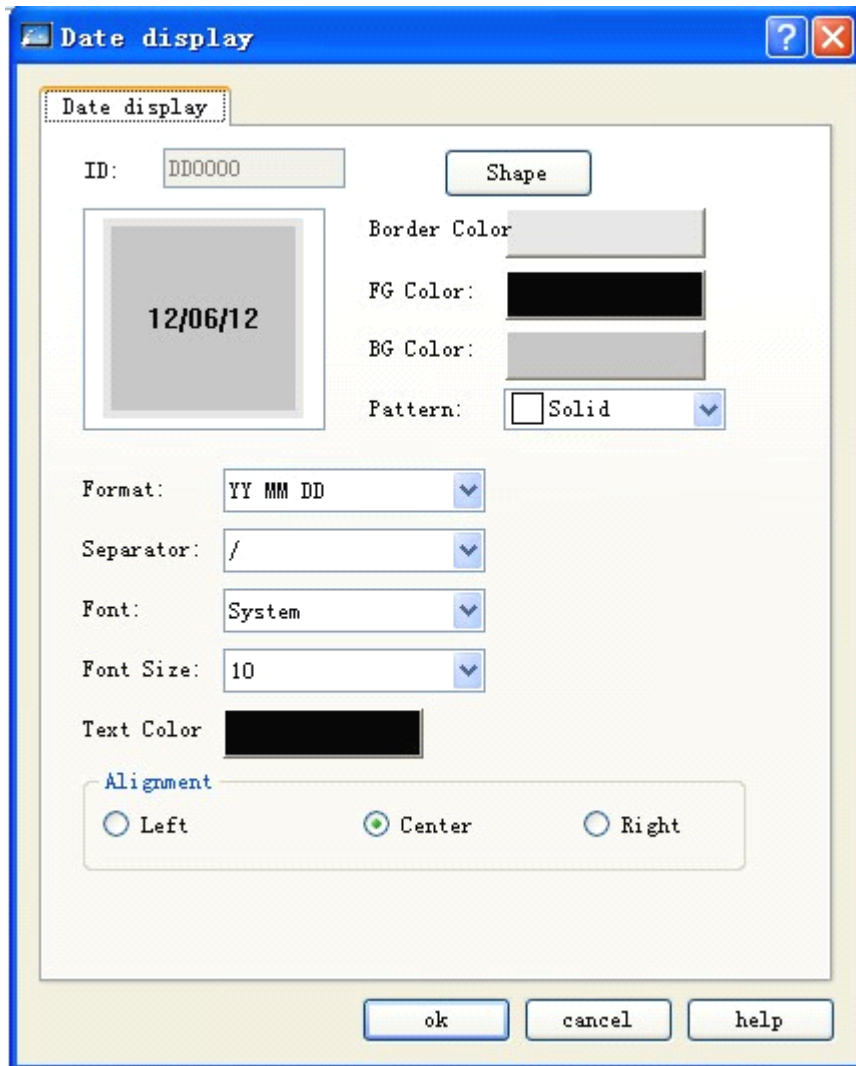

Figure 4-111: Date display dialog

Format: Format of date display, including 9 formats, for example

➤ Separated by “/”

- | | |
|-----------------------------|------------------------------|
| YY/MM/DD : Year-month-day | YYYY/MM/DD : Year-month-day |
| MM/DD/YY : Month-day-year | MM/DD/YYYY: Month-day-year |
| DD /MM /YY : Day-month-year | DD /MM /YYYY: Day-month-year |

➤ Separated by “.”

- | | |
|-----------------------------|------------------------------|
| YY/MM/DD : Year-month-day | YYYY/MM/DD : Year-month-day |
| MM/DD/YY : Month-day-year | MM/DD/YYYY: Month-day-year |
| DD /MM /YY : Day-month-year | DD /MM /YYYY: Day-month-year |

➤ Separated by “-”

- | | |
|---------------------------|-----------------------------|
| YY/MM/DD : Year-month-day | YYYY/MM/DD : Year-month-day |
| MM/DD/YY : Month-day-year | MM/DD/YYYY: Month-day-year |

DD /MM /YY : Day-month-year DD /MM /YYYY: Day-month-year

- Font: Font of the text displayed
- Font size: Here you can change the font size according to actual needs.
- Text color: Here you can change the color of the date display text.
- Alignment: Here you can have the date displayed on left side, on right side or in the middle.
- After setting of these parameters, click OK, and then the mouse will become . Draw a rectangle in the picture area by left clicking the mouse, and then the control will be displayed.



Refer to Bit Button control for setting of Shape, Border Color, FG Color, BG Color and Pattern.

4.5.15 Day-of-week display of SKWorkshop

Day-of-week Display control is mainly used to display day of week. Click Day-of-week Display control icon  in the tool bar, and then a dialog as shown in Figure 4-112 will appear.

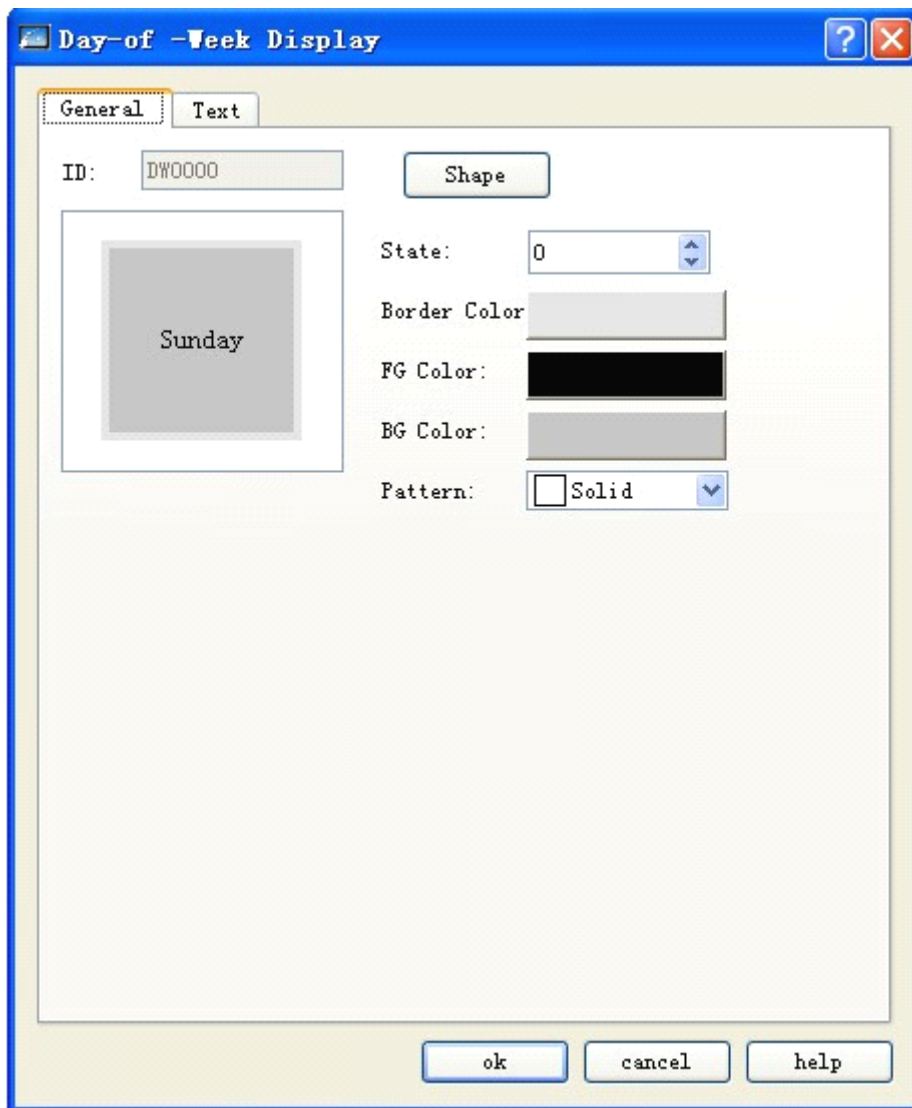

Figure 4-112: Day-of-week display dialog

- State: You can set different border colors, foreground colors, background colors and patterns for different states by changing the value of the state.



Refer to Bit Button control for setting of Shape, Border Color, FG Color, BG Color and Pattern.

Click Text tab, and you can modify text display properties here, such as the text to be displayed (such as changing Sunday to Chinese), border interval, font size, text color, word interval, line interval, blink and position. See Figure 4-113 for Text tab of Day-of-Week Display.

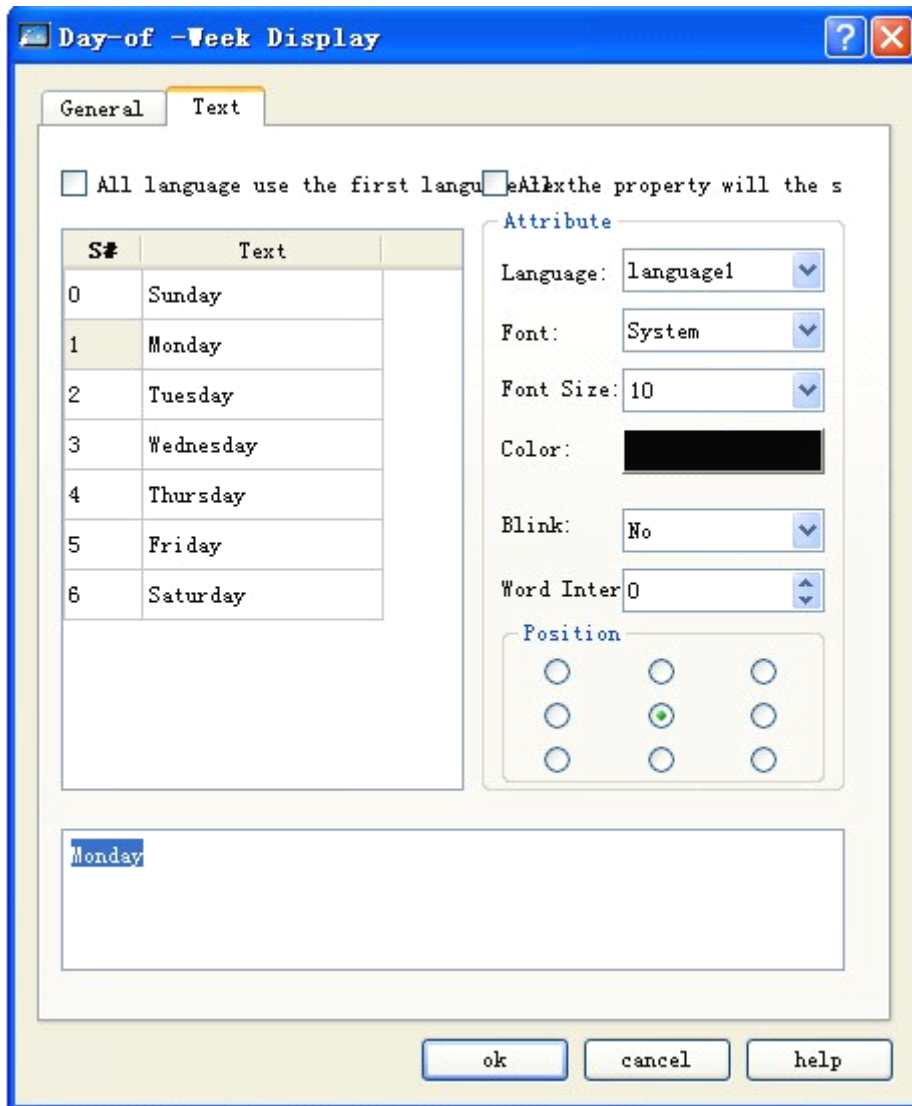

Figure 4-113: Text tab of day-of-week display

- Text of the first language used for all languages: This option is used for multiple languages cases that are when the total numbers of languages is more than 1 in the Language option of the Project Manager. If this option is chosen, the language of the control will not be changed along with the language switch.
- Language: This option is used for multiple languages cases. You can choose different languages and enter different texts under different states, getting prepared for multiple language controls. Thus, when Switch Language option is chosen in the function buttons, and a target language is chosen, all the text controls in the screen will use specified language after clicking this function button. For different languages, text contents, font and font size may be different, but color, word space and position are the same.
- Font: Font of the text contents entered. You may choose different fonts for different states or languages.
- Font size: Font size of the text contents entered. You may choose different font sizes for different states or languages.

Color, word space and position: Used to set the text color, word space and alignment mode under the current state. When the total numbers of languages is more than 1 in the Language option of the Project Manager, and the language other than

language 1 is chosen, these three function options will be invalid, and the same text color, word space and position as that in language 1 will be applied.



To modify the contents of the text, first choose the item to be modified, and then type in the new text in the edit box below.

- After setting of these parameters, click OK, and then the mouse will become . Draw a rectangle in the picture area by left clicking the mouse, and then the control will be displayed.

4.5.16 Static picture of SKWorkshop

Static Picture control is mainly used to display a picture, either from the library of the system or from other files with different formats. You can choose the picture source according to actual needs. The picture loaded by this control can be used as a background of a graph to beautify the project interface.

1. Click Static Picture icon  in the tool bar, and a dialog as shown in Figure 4-114 will appear.

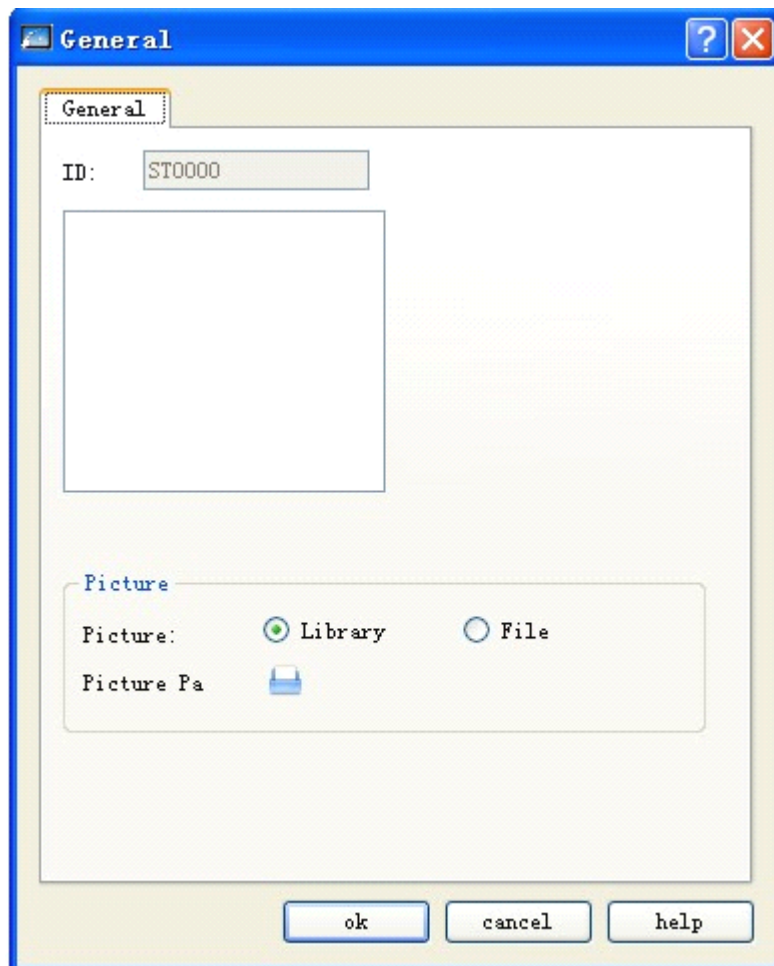



Figure 4-114: Static picture dialog

2. After a picture is chosen, click OK and then the mouse shape will become a cross. Click on any point in the screen and then you can add the chosen picture into the screen.

- The size of the picture inserted can be adjusted. Choose the picture, move the mouse to a small green dot, press down the left key of the mouse, and drag the mouse to adjust the picture to a suitable size. SKWorkshop supports a wide range of picture formats, including JPG, BMP, JIF, WMF, EMF and GIF.

4.5.17 Picture display of SKWorkshop

Picture Display is an extension of Static Picture control, as Static Picture can only display one picture but Picture Display can display up to 32 pictures. Picture Display can have different definitions basing on different state types chosen by user. The operation steps are as follows:

Click Picture Display icon  in the tool bar, and then a dialog as shown in Figure 4-115 will appear.

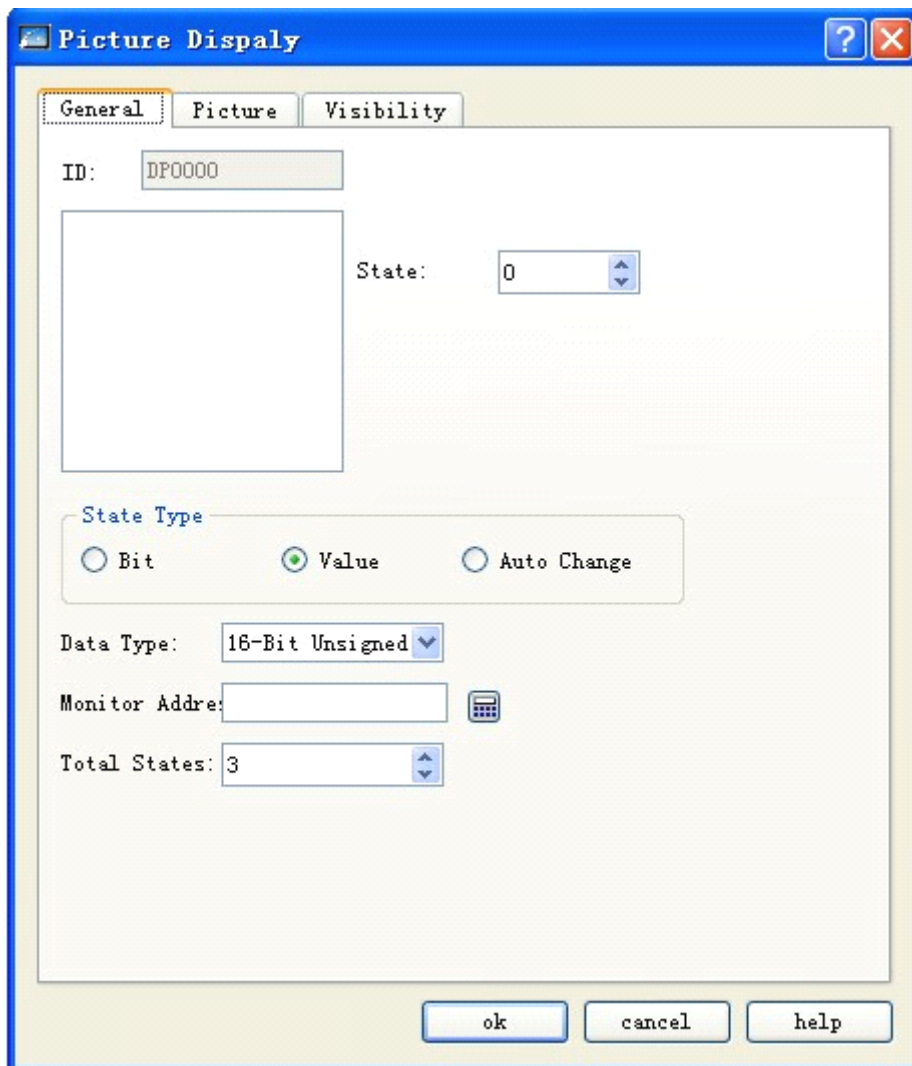

Figure 4-115: Picture display dialog

- Bit: When this option is checked, there are totally two states, that are 0 and 1, and the monitored address can be bit address only. Then, this control will display corresponding picture basing on 0/1 state of the monitored address.
- Value: When this option is checked, the total number of states can be up to 32, and the different pictures can be displayed basing on the value of the monitored address. If the value of the monitored address is 0, picture of state 1 will be displayed, and so forth.

- Auto change: When this option is checked, the total number of states can be up to 32, and the control needs not to display picture basing on the value of the monitored address, but display pictures in turn within the range of the total state number set by the user after the user defines a picture for each state, sets “Auto Change Frequency” and downloads the setting to HMI.



Picture tab of Picture Display is similar to Picture tab of Multi-state Lamp, so you can refer to the latter for reference.



Refer to Bit Button control for the use of Visibility tab.

- After setting of these parameters, click OK, and then the mouse will become . Draw a rectangle in the picture area by left clicking the mouse, and then the control will be displayed.

4.6 New functions of SKWorkshop

This chapter mainly introduces the use of the new controls of SKWorkshop.

4.6.1 Fan chart of SKWorkshop

The functions of fan chart (also called pie chart) are similar to the functions of meter. It is used to read the value of the monitored address and present it onto the control. The presentation area can be indicated in Foreground Color, Background Color and Pattern. The icon of this control in the toolbar is . Click this icon, and then a dialog as shown in Figure 4-116 will pop up:

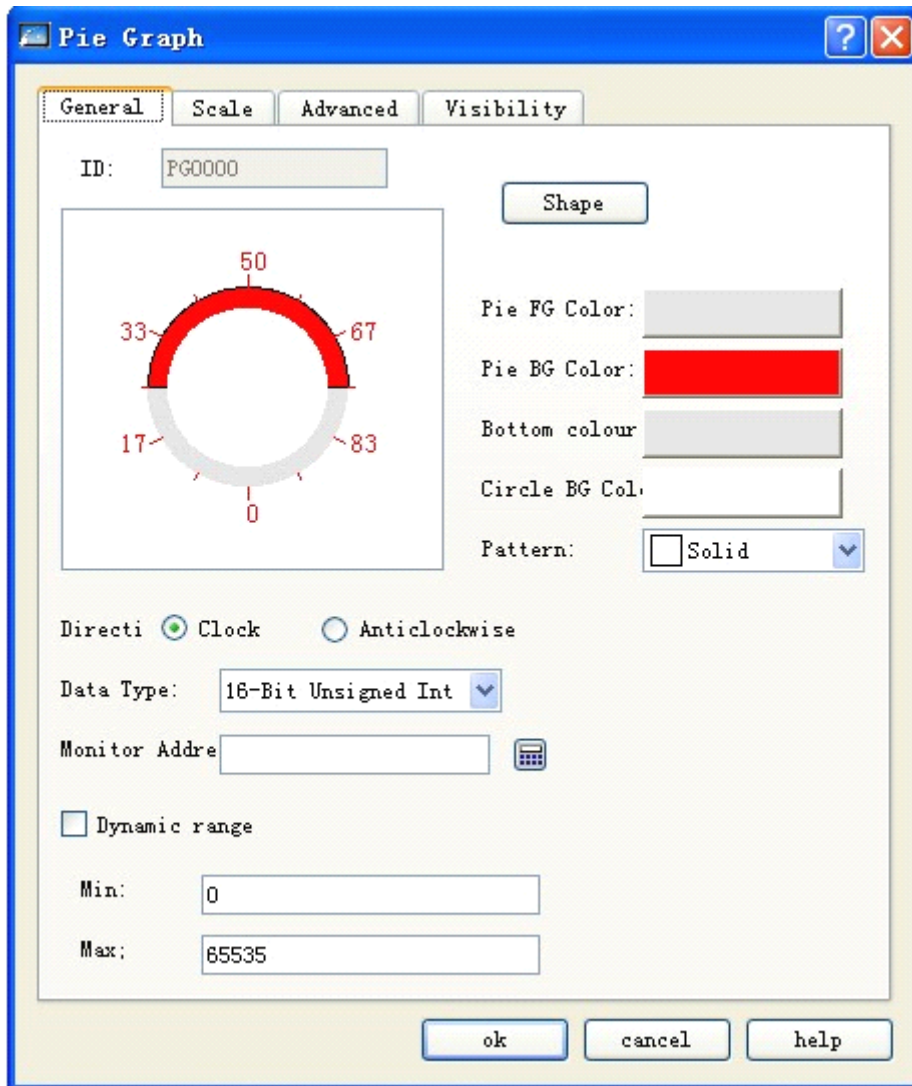

Figure 4-116: General tab of fan chart

Scale tab of fan chart is shown in Figure 4-117:

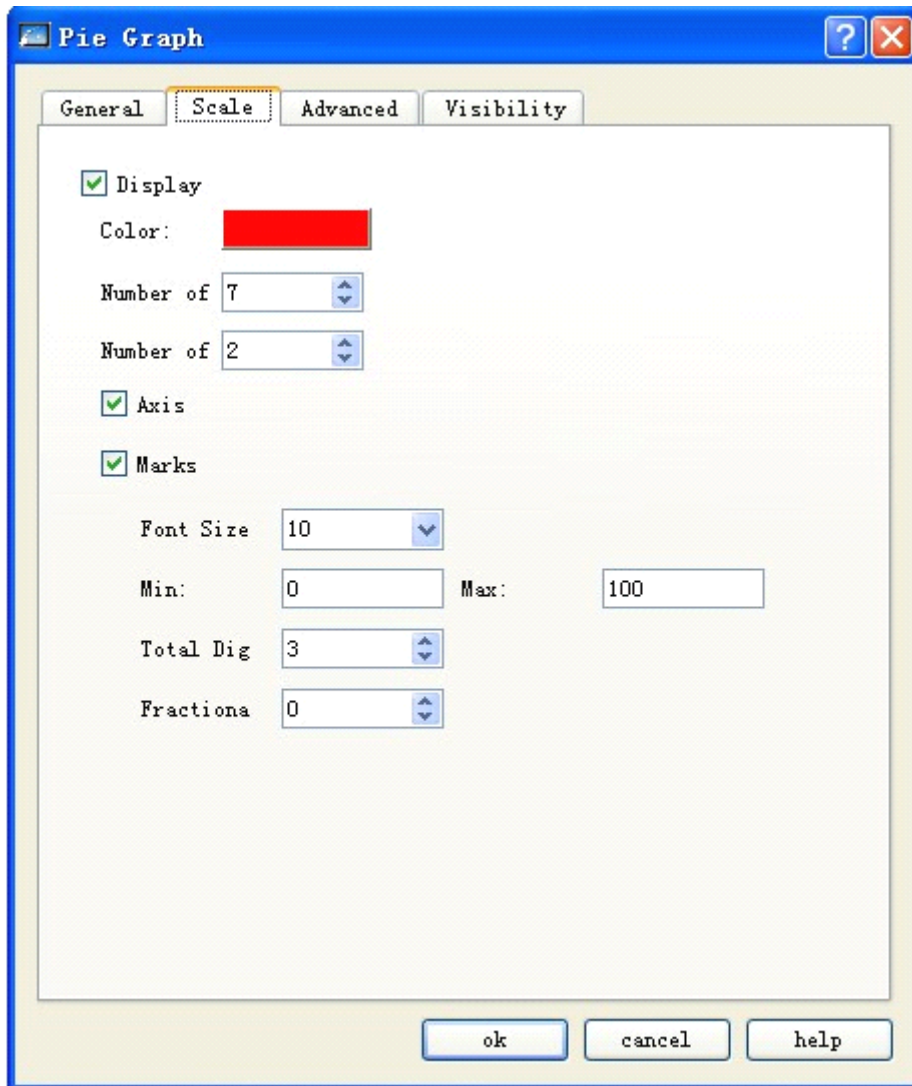



Figure 4-117: Scale tab of fan chart

- Refer to the Scale tab of Meter for the parameter setting in this tab.
- Refer to the Advanced tab of Numerical Value Display control for the parameter setting in the Advanced tab.

4.6.2 SKWorkshop Step button of SKWorkshop

Function of step button is to switch over the state of the control in return after each clicking and write the corresponding value into the write address. The icon of this control in the toolbar is . Click this icon, and then a dialog as shown in Figure 4-118 will pop up:

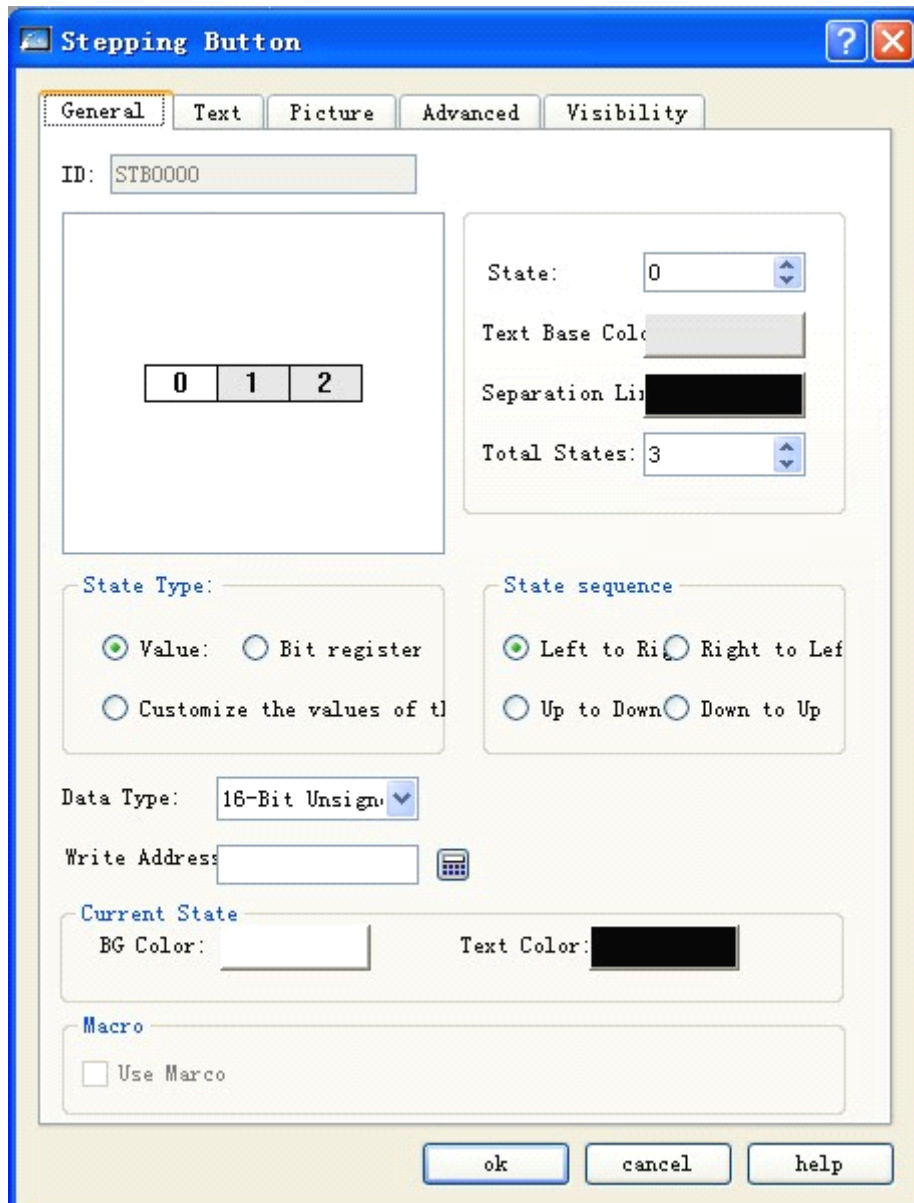

Figure 4-118: General tab of step button

- State sequence: Text arrangement sequence of the control. For example, if the total number of states is 3, the texts of state 0, 1 and 2 are respectively 0, 1 and 2.

From left to right: Horizontal placement of the control, and from left to right arrangement of the texts. If this option is chosen, the text sequence is 0,1,2.

From right to left: Horizontal placement of the control, and from left to right arrangement of the texts. If this option is chosen, the text sequence is 2,1,0.

From top down: Vertical placement of the control, and from top down arrangement of the texts. If this option is chosen, the text sequence is 0,1,2.

From bottom up: Vertical placement of the control, and from bottom up arrangement of the texts. If this option is chosen, the text sequence is 2,1,0.

- State type: Refer to the state type of Multi-state lamp.

- Current state: Set the background color and text color of the text under the current state.
- Refer to the Text and Picture tabs of Multi-state Lamp for the parameter setting in Text and Picture tabs.
- Refer to the Advanced tab of Bit Button for the Advanced tab.

- For example, if the Data Type is Numerical Value, the write address is LW1, the total number of states is 3, and the texts of state 0, 1 and 2 are respectively 0, 1 and 2, then: when clicking repeatedly the control after downloading to HMI, the control will switch over among the three states 0-2, and write the corresponding value into LW1.

4.6.3 Radio button of SKWorkshop

The function of radio button that when you click a state, the control will switch to this state and write the corresponding value under the state into the write address. The icon of this control in the toolbar is . Click this icon, and then a dialog as shown in Figure 4-119 will pop up:

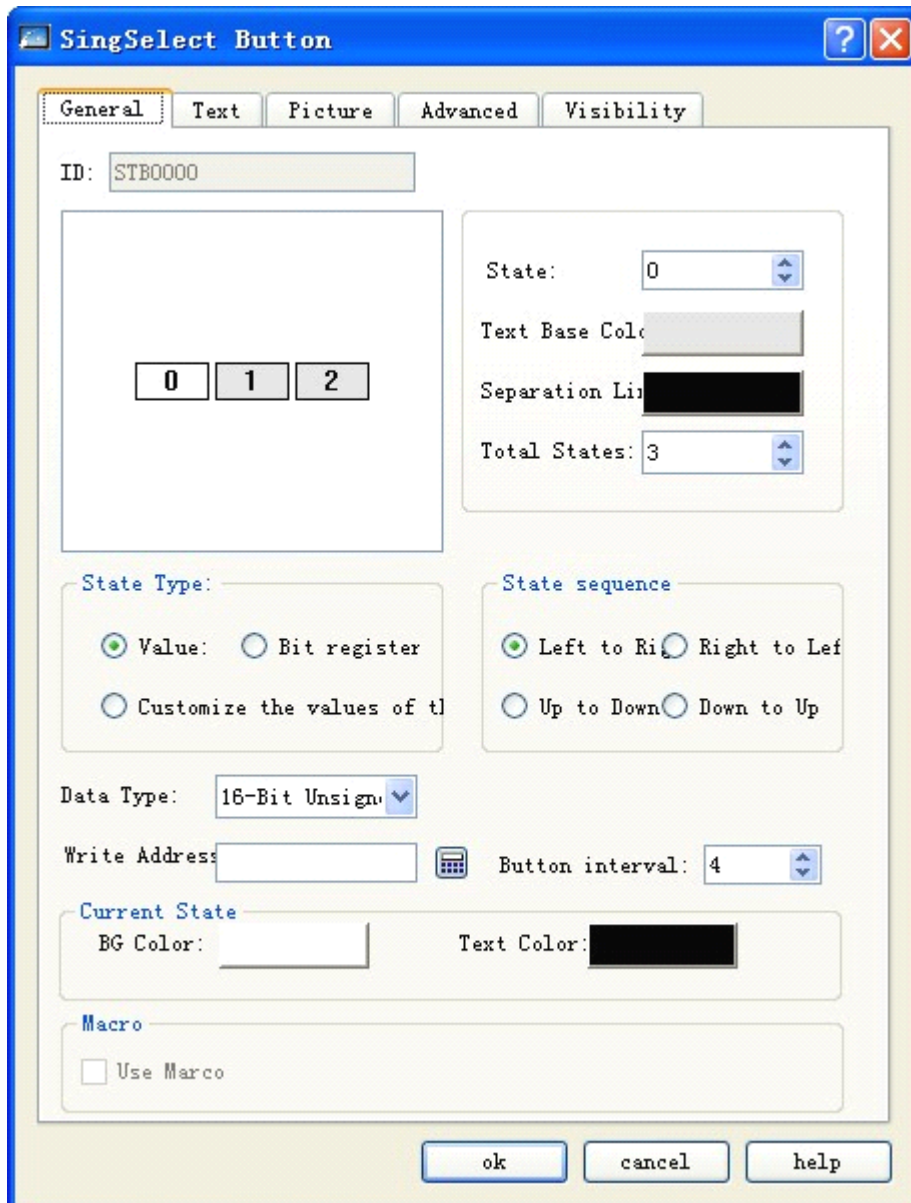

Figure 4-119: General tab of radio button

- State sequence: Text arrangement sequence of the control. For example, if the total number of states is 3, the texts of state 0, 1 and 2 are respectively 0, 1 and 2.

From left to right: Horizontal placement of the control, and from left to right arrangement of the texts. If this option is chosen, the text sequence is 0,1,2.

From right to left: Horizontal placement of the control, and from left to right arrangement of the texts. If this option is chosen, the text sequence is 2,1,0.

From top down: Vertical placement of the control, and from top down arrangement of the texts. If this option is chosen, the text sequence is 0,1,2.

From bottom up: Vertical placement of the control, and from bottom up arrangement of the texts. If this option is chosen, the text sequence is 2,1,0.

- State type: Refer to the state type of Multi-state Lamp.

- Current state: Set the background color and text color of the text under the current state.
- Refer to the Text and Picture tabs of Multi-state Lamp for the parameter setting in Text and Picture tabs.
- Refer to the Advanced and Visibility tabs of Bit Button for the Advanced and Visibility tabs.

4.6.4 Dropdown box of SKWorkshop

Dropdown box object can display multiple items in a list, and you can view and choose items in such list. Once an item is chosen, the corresponding value will be written to the control address of the character register.

The icon of this control in the toolbar is . Click this icon, and then a dialog as shown in Figure 4-120 will pop up:

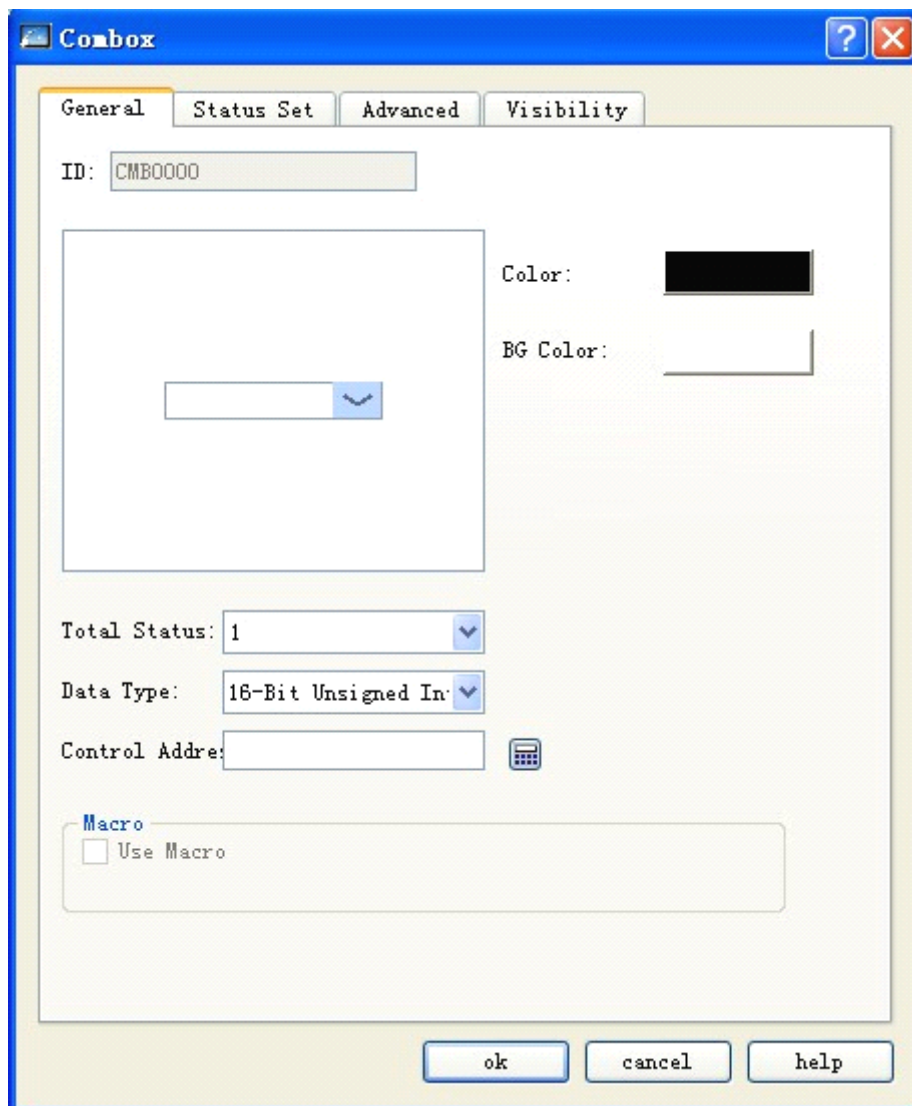

Figure 4-120: General tab of dropdown box

- Total state number: Set total number of states of this object. Each item is a state, and will be displayed in the list. This number can be write to the control address.
- Background color: Background color of this object.

- Text color: Text color of this object.
- Control address: Write address.
- Use macro: If this option is chosen, macros chosen by the user will be executed if the object is touchable.

State setting tab: This tab shows all states/items, texts and numerical values. To change the item number, choose Total State Number in the Item List Setting tab. Click State Setting tab, and then a dialog as shown in Figure 4-121 will appear:

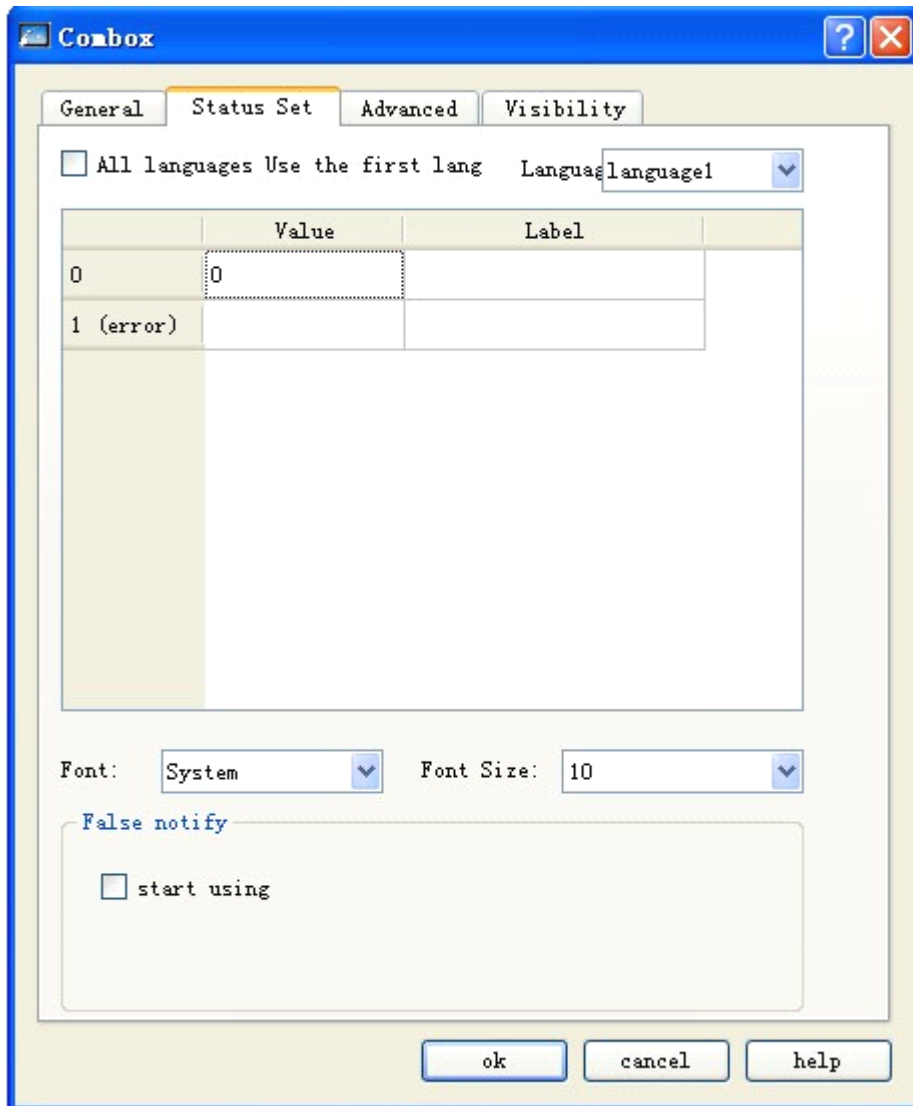



Figure 4-121: State Setting tab of dropdown box

- Language: Use unified Font and Font Size for all states; For different languages there may be different Font and Font Size settings.
- State: The system will list all the items used at present, and each item indicates a state and will be displayed in the list. This field is read only.
- Value: You may set value for each item basing on the following rules:

- a. [Read]: If the system detects any change in the contents of the Control Address, the object will check the contents and the value and choose the first conforming item. If no item is conforming, it will jump to error state and trigger the error notification bit (if any).
 - b. [Write]: When you choose an item, the system will write its value into the control address.
- Lable: You can set texts for each item, and the Item List object will display the texts of all the items in a list for view and selection by you.
 - Error notification:
 - a. For example, if the Item Number is set to be 8, then 8 will be the error state. Similarly, if the Item Number is set to be 11, then 11 will be the error state.
 - b. When an error state occurs, the dropdown list will display the text of the error state.
 - When an error state occurs, the system will set specific bit to ON/Off (written to Error Notification Address). Notification of this bit register can be used to trigger an action to correct the error.
 - Refer to the Advanced tab of Bit Button for Advanced tab and Visibility tab.

4.6.5 Slider analog switch of SKWorkshop

Slider analog switch: Change the value of corresponding character register address by dragging the slider.

The icon of this control in the toolbar is . Click this icon, and then a dialog as shown in Figure 4-122 will pop up:

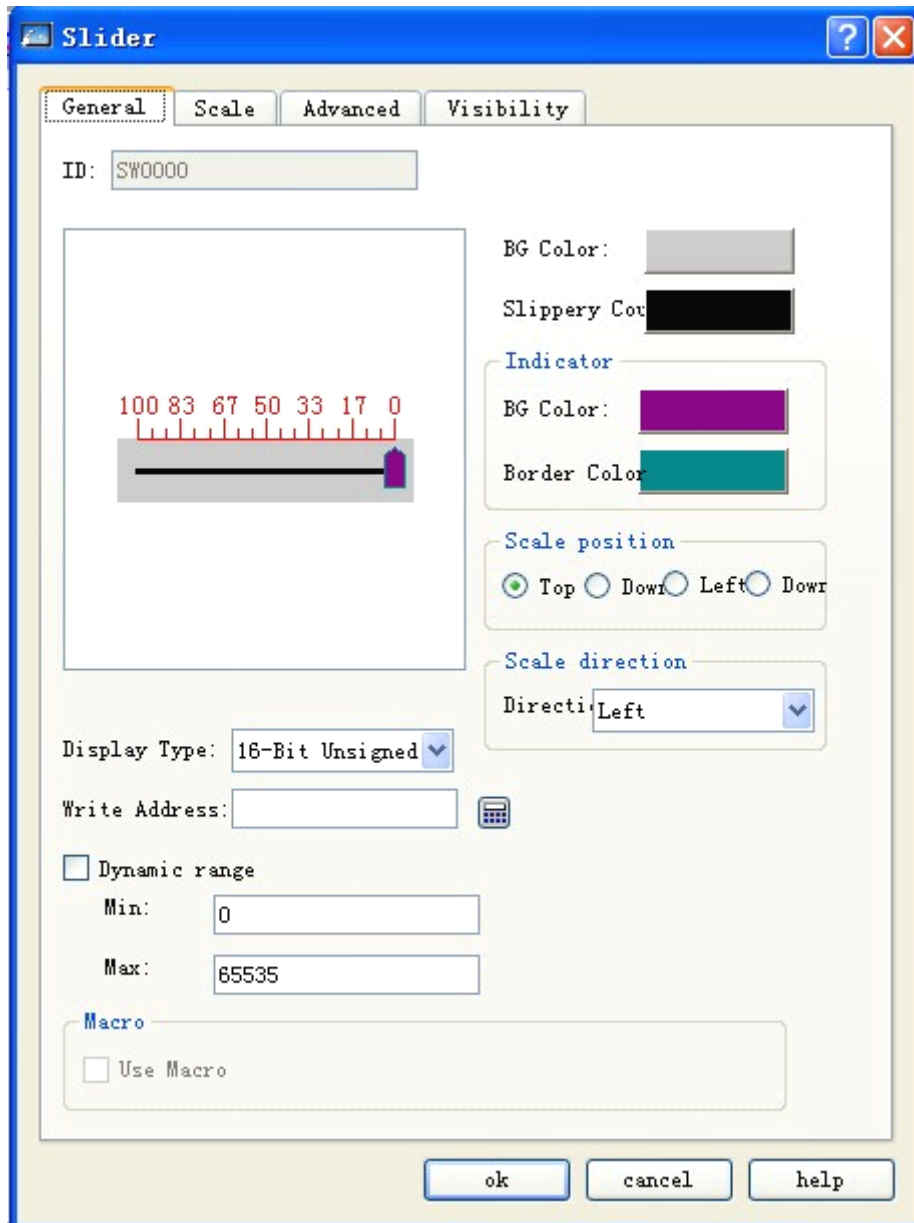



Figure 4-122: General tab of slider analog switch

- Scale position: Change the position of the scale markings by choosing different options.
- Scale direction: Change the direction of the scale markings by choosing different options.
- Write address: When the slider is dragged, the set value of the current write address can be written and displayed on a real-time basis.
- Dynamic range: If this option is chosen, the values of the maximum and minimum are determined dynamically by the address chosen by the user. Otherwise they will be determined by the type of the Data Type chosen by the user.
- Refer to Scale tab of Meter for the settings in Scale tab.
- Refer to Advanced tab of Bit Button for the Advanced tab and Visibility tab.

4.6.6 Animation of SKWorkshop

Animation: You may define the movement track of an element, and control the state of the element and its position in the movement track by changing the data in the character register. The system uses two consecutive registers to control animation element. The first is used to control the state of the element while the second to control position of the element.

The icon of this control in the toolbar is . After clicking the icon, you can specify movement points of the control in the screen (note: Up to 64 track points can be specified). Right click the mouse to end the point specifying process.

Double click this control, and then a dialog as shown in Figure 4-123 will pop up:

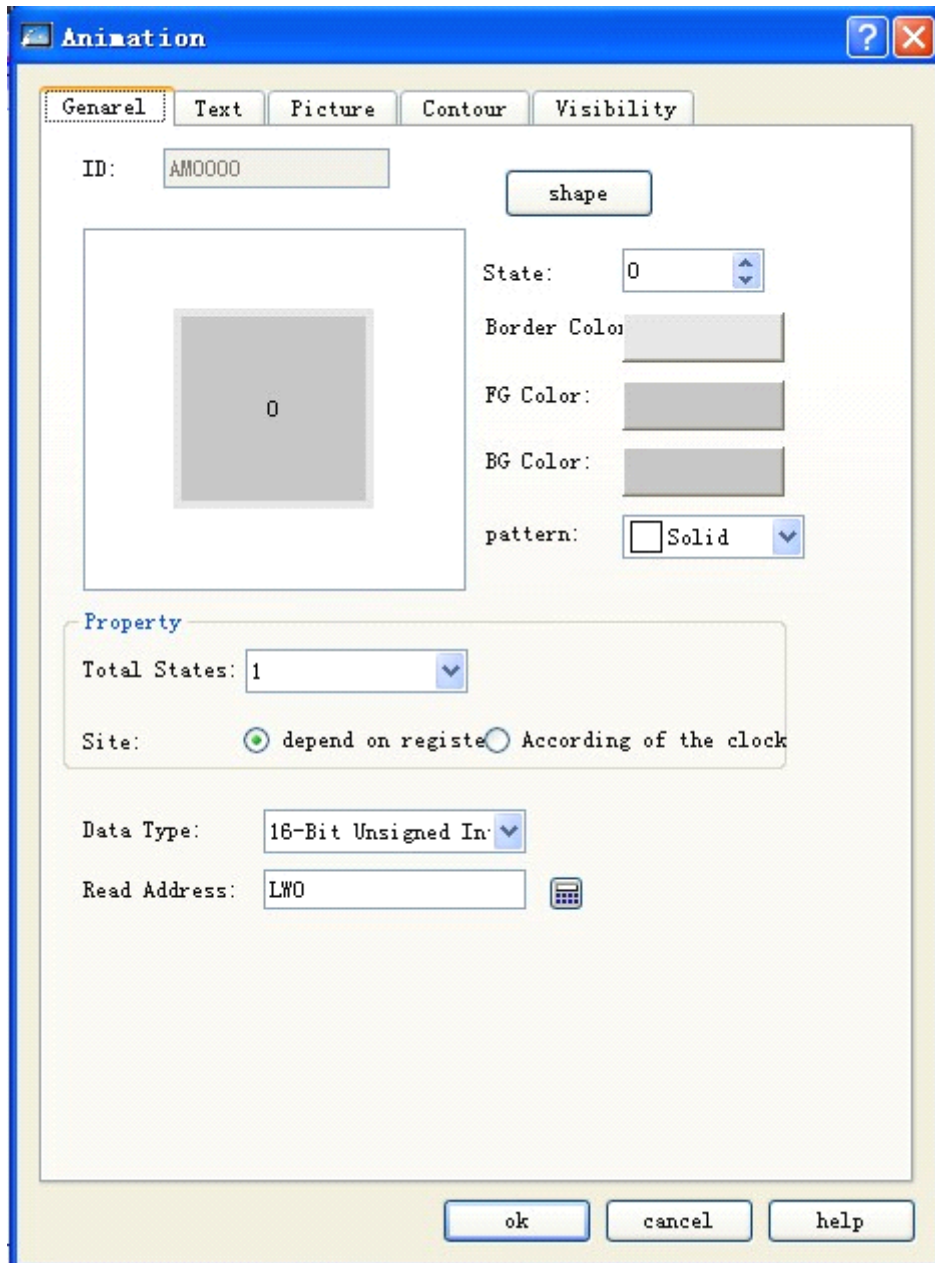

Figure 4-123: General tab of animation

- State number: Set number of states of the element.

➤ Position

- ◆ Depending on Register: When this option is chosen, the state and position of the element will be controlled by the data in register.
- ◆ Read address: If the state and position of the element are controlled by the data in register, you must set the read address for the state and the position correctly. The formats of read address are as follows:

Data Format	Status Address of Control Element	Position Address of Control Element
16-bit format	Address	Address+1
32-bit format	Address	Address+2

For example, if the register is [LW100] and the data format is 16-bit positive integer, then [LW100] will determine the state of the element and [LW101] will determine the display position of the element. Taking Figure 4-124 for example, [LW100] = 2 and [LW101] = 1, so the state of the element is 2 and the position is 1.

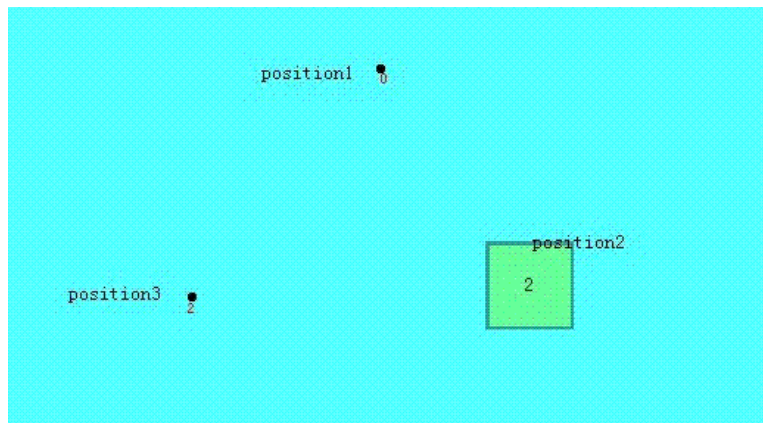

Figure 4-124

- ◆ By clock: If you do not choose Depending on Register but By Clock for the element, then the element will change its state and display position automatically. In this case, Auto Control Position is used to set the changing mode of the state and the display position.

Speed: The speed of position changing, in 0.1s. For example, if the value of this option is set to 10, then the element will change a position every 1 second.

Return: We assume there are four positions, respectively position 0, position 1, position 2 and position 3. If this option is not chosen, after the element moves to the last position (position 3), it will move immediately to position 0 and then repeat the original position changing mode, as shown below:

position 0-> position 1-> position 2-> position 3-> position 2-> position 1-> position 0...

If this option is chosen, after the element moves to the last position (position 3), it will move in reverse direction till position 0 and then repeat the original position changing mode, as shown below:

position 0-> position 1-> position 2-> position 3-> position 2-> position 1-> position 0...

State switch: The manner of state changing. You can choose Based on Position or Based on Time. If Based on Position is chosen, the state will change along with position. If Based on Time is chosen, the position and state will change along the points specified in the screen. [Switch frequency] determines the frequency of the state switching, as shown in Figure 4-125.

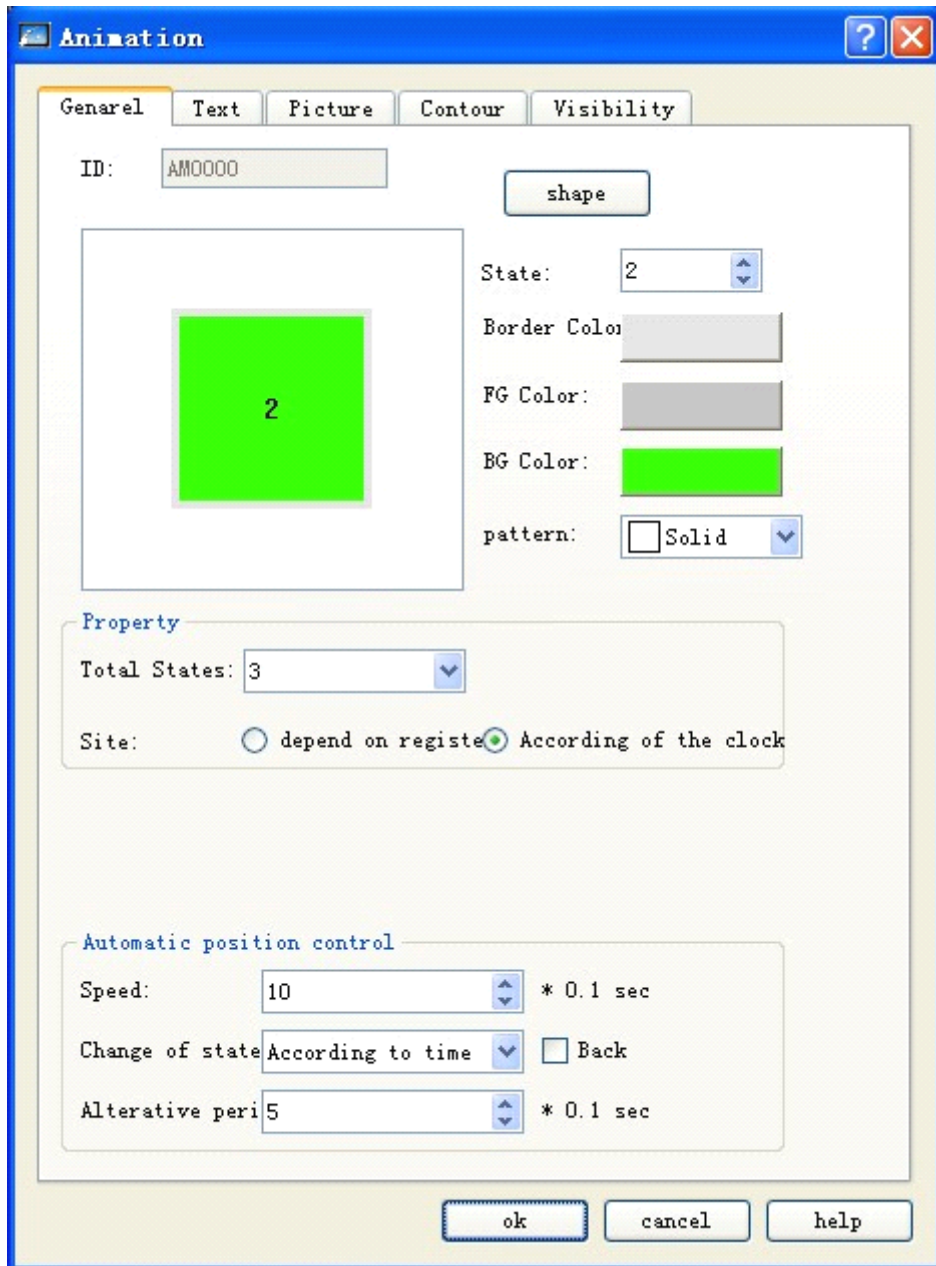
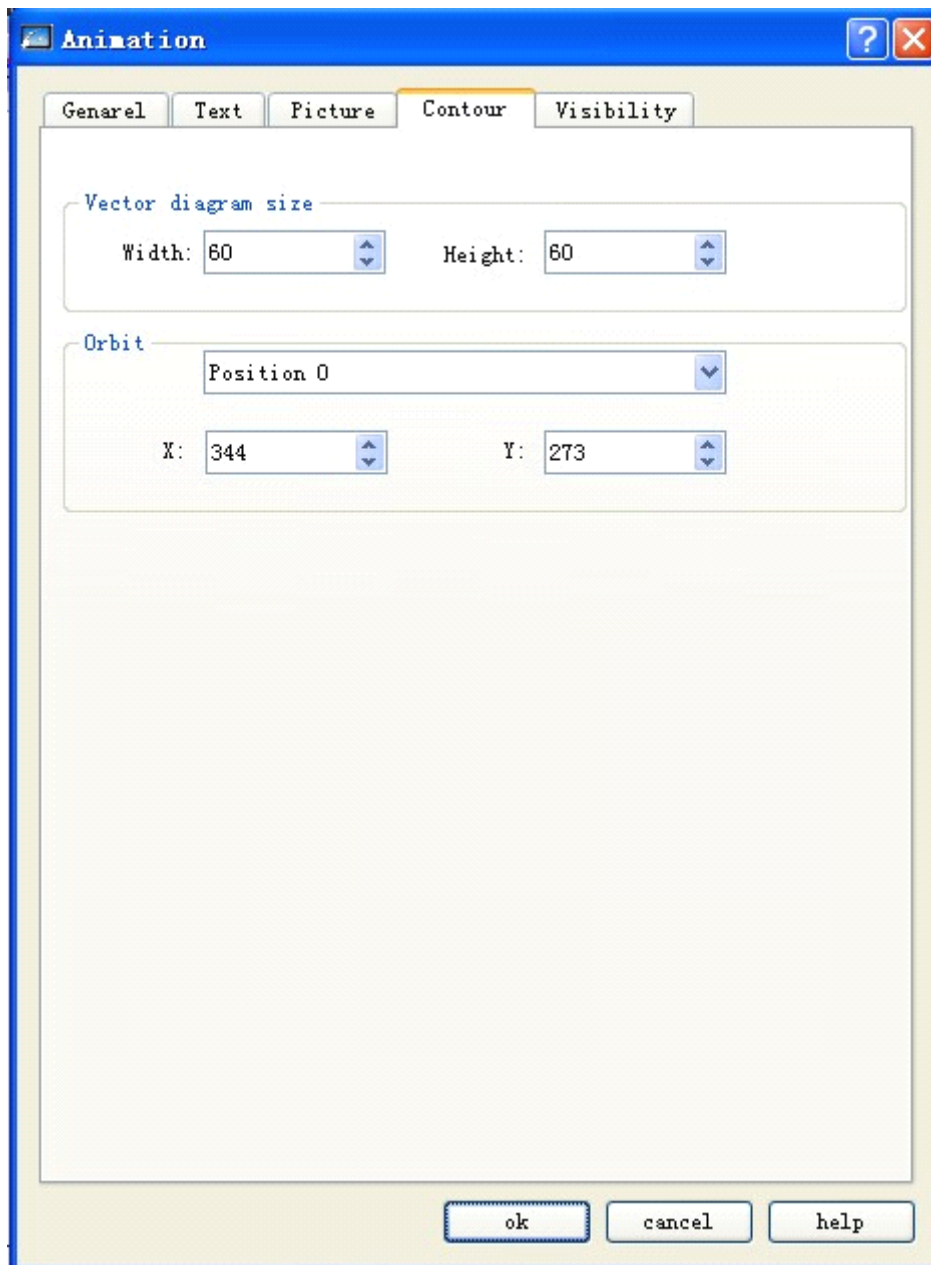

Figure 4-125: Auto control position

Profile tab:



Vectogram size:

Width: Width of the graph control set in the General tab.

Height: Height of the graph control set in the General tab.

Track: Adjust the position of track points by choosing different points.

- Refer to Text and Picture tabs of Multi-stage Lamp for the Text and Picture tabs.
- Refer to Visibility tab of Bit Button for the Visibility tab.

4.6.7 Message board of SKWorkshop

Message board: You can write words on this control. The icon of this control in the toolbar is . Click this icon, and then a dialog as shown in Figure 4-126 will pop up:.

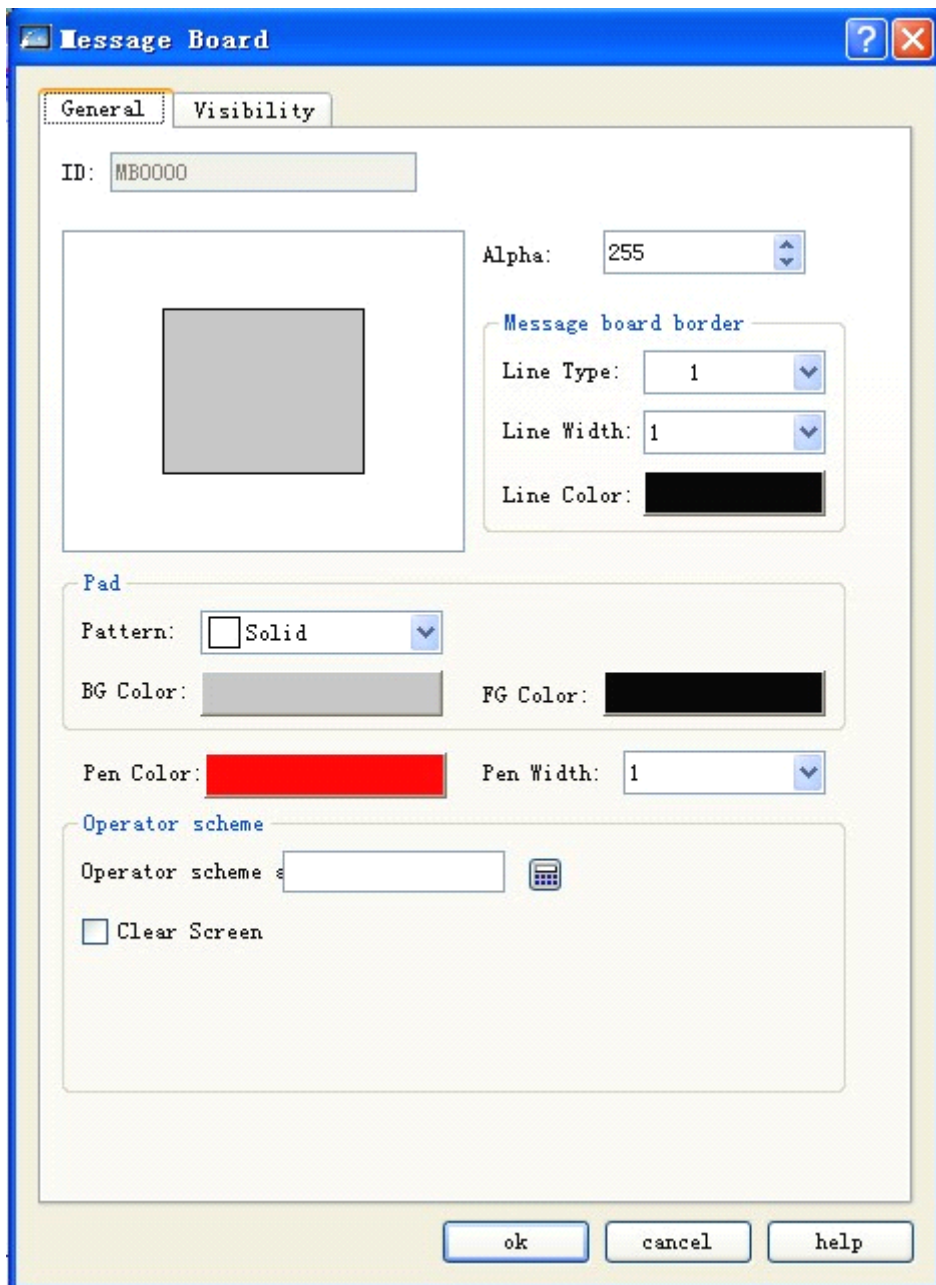



Figure 4-126: General tab of message board

- Pen color: Color of the text written in the control.
- Pen width: Width of the line of the texts written in the control.
- Operation mode:
 - Operation mode address: This address is a word address, and is valid only when the value of this address is 0 or 1. 0 indicates write operation and 1 indicates erase operation.
- Clear screen address: If the value of this address is equal to the value chosen in Clear Screen State, all the contents written on the control will be cleared automatically.
- Refer to Visibility tab of Bit Button for the Visibility tab.

4.6.8 Data group display of SKWorkshop

Data group display: A data group (or block) refers to the data in a group of continuous addresses such as LW12, LW13, LW14 and LW15. Data Group Display element can display the contents of several data groups at the same time, for example the two data groups of LW12~LW15 and RW12~RW15. You can use this to view and compare the data of different registers. It can also draw reference curves of several data groups, with the displayed point number being the horizontal axis coordinates and the each address value in each data group as the vertical axis coordinates, so as to accurately and visually get the change trend of a number in a specified period. At most 8 polygons can be displayed.

The icon of this control in the toolbar is . Click this icon, and then a dialog as shown in Figure 4-127 will pop up:

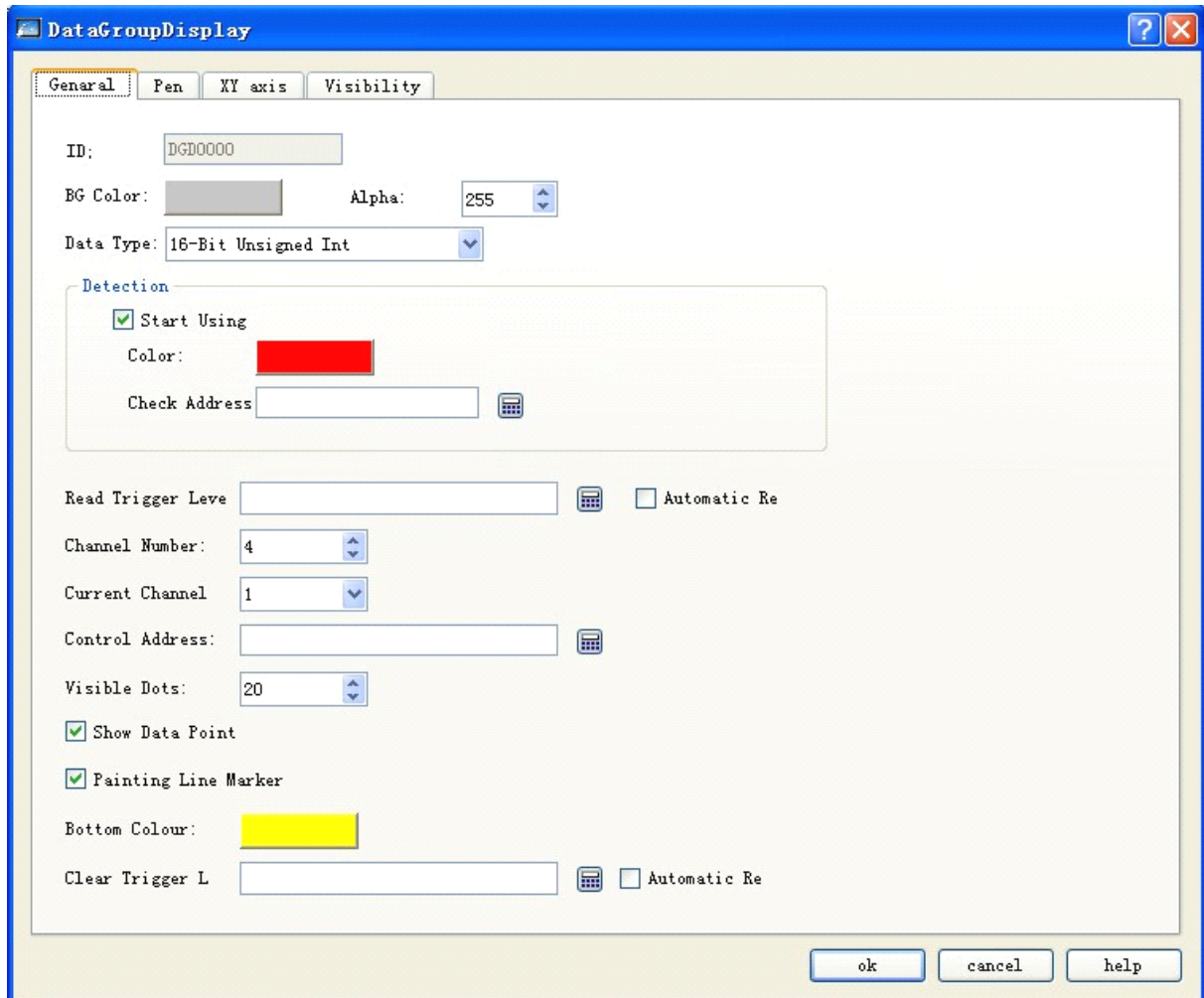

Figure 4-127: General tab of data group display

Background color: Background color of the trend chart. The change color cannot be seen until clicking OK.

Data type: Totally 7 data types are provided.

Read trigger bit: The curves will move only when this option is set to 1.

Auto reset: If the value of Read Trigger Bit address is 1, the address will be automatically set to 0 after releasing the mouse.

Channel number: Number of data groups and number of pens.

Current channel: You can set address for Control Address of different channels after choosing different channels.

➤ Control address:

The same to read address. Different control addresses for different channels.

For this address, different starting addresses can be set with different channel number. Length of address = Len *
Displayed point number (When the data type is 16-bit, len=1; when the data type is 32-bit, len=2);

For example, if the starting address of channel 1 is LW1, the data type is 32-bit integer, and the point number is 4, then
the addresses occupied by channel 1 are: LW1 LW2 LW3 ...LW8;

Displayed point number: Number of the control addresses to be read for each channel.

➤ Detection

Enable: Whether to use the detection line (reference line).

Color: Color of the detection line (reference line).

Detection address: Write the value corresponding to the current position of the detection line (reference line) into the
detection address register.

➤ For example:

If the data type is 16-bit, the channel number is 4, the displayed point number is 10, the control address of channel 1 is
LW1, the control address of channel 2 is LW100, the control address of channel 2 is LW200, and the control address of
channel 3 is RWI1, then:

Pen 1: LW1~LW10

Pen 2: LW100~LW110

Pen 3: LW200~LW210

Pen 3: RWI1~ RWI10

If the data type is 32-bit and other settings remain unchanged, then:

Pen 1: LW1~LW20

Pen 2: LW100~LW120

Pen 3: LW200~LW220

Pen 3: RWI1~ RWI20

Thus, if 32-digit data is chosen and the number of data is set to N, then the values of N addresses (adding 2 to the
address each time) can be read according to different address rules of the PLC.

Background color: Background color of the area where the pens (lines) are moving.

Clear Trigger: When the value of the Clear Trigger address changes from 0 to 1, all current pens (lines) will be cleared.
When the value of the Clear Trigger address changes from 1 to 0 or has no change, no change will be made to the pens.

Point pen: Each pen is composed of points.

Line pen: Each pen is composed of lines.

Refer to Visibility tab of Bit Button for the Visibility tab.

4.6.9 User-defined keyboard of SKWorkshop

1. Keyboard element: This control is used for user-defined keyboard to form each button of the keyboard. The icon of this control in the toolbar is . Click this icon, and then a dialog as shown in Figure 4-128 will pop up:

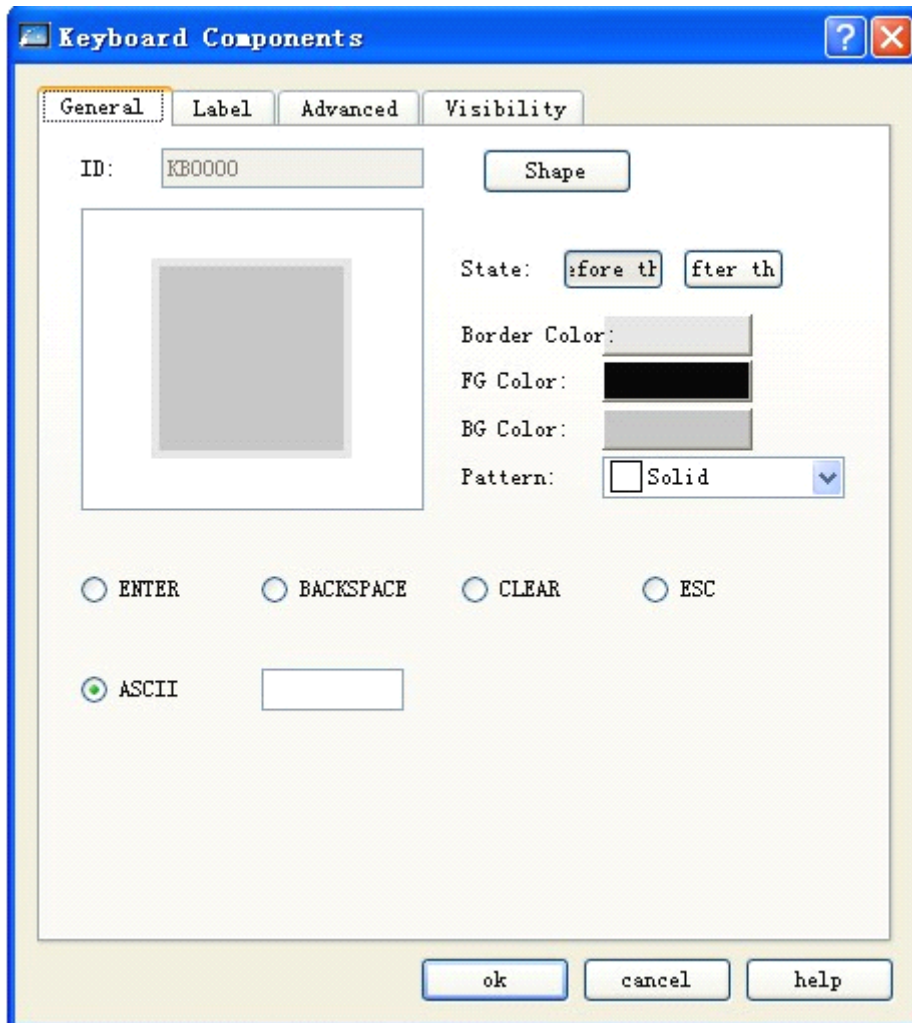

Figure 4-128: General tab of keyboard element

- State: You can set the border color, foreground color, background color and pattern for the control under different states by clicking Before Pressing and After Pressing buttons.
- ENTER: Function button used to confirm the input.
- BACKSPACE: Function button used to delete a character before the cursor.
- CLEAR: Function button used to clear all contents entered.
- ESC: Function button used to cancel the pop-up keyboard without entering any content.
- ASCII: Values entered with the keyboard element.
- Refer to Visibility tab of Word Button for the Visibility tab.

2. How to add a user-defined keyboard

You can start up the keyboard adding guide by clicking Add User-defined Keyboard in Setting menu. Following this guide you can quickly add a user-defined keyboard that has been set in the program, as shown in Figure 4-129:

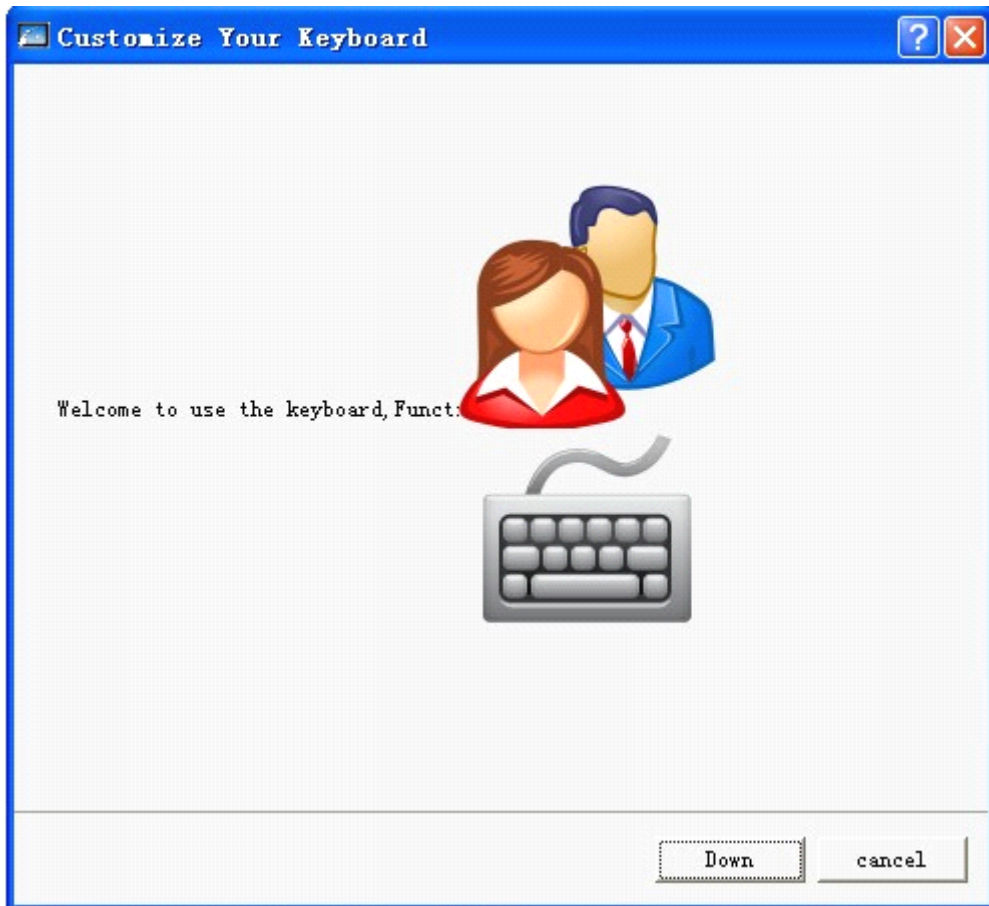

Figure 4-129: Page 1 of user-defined keyboard guide

After clicking Next, a dialog will pop up for you to select keyboard type, as shown in Figure 4-130:

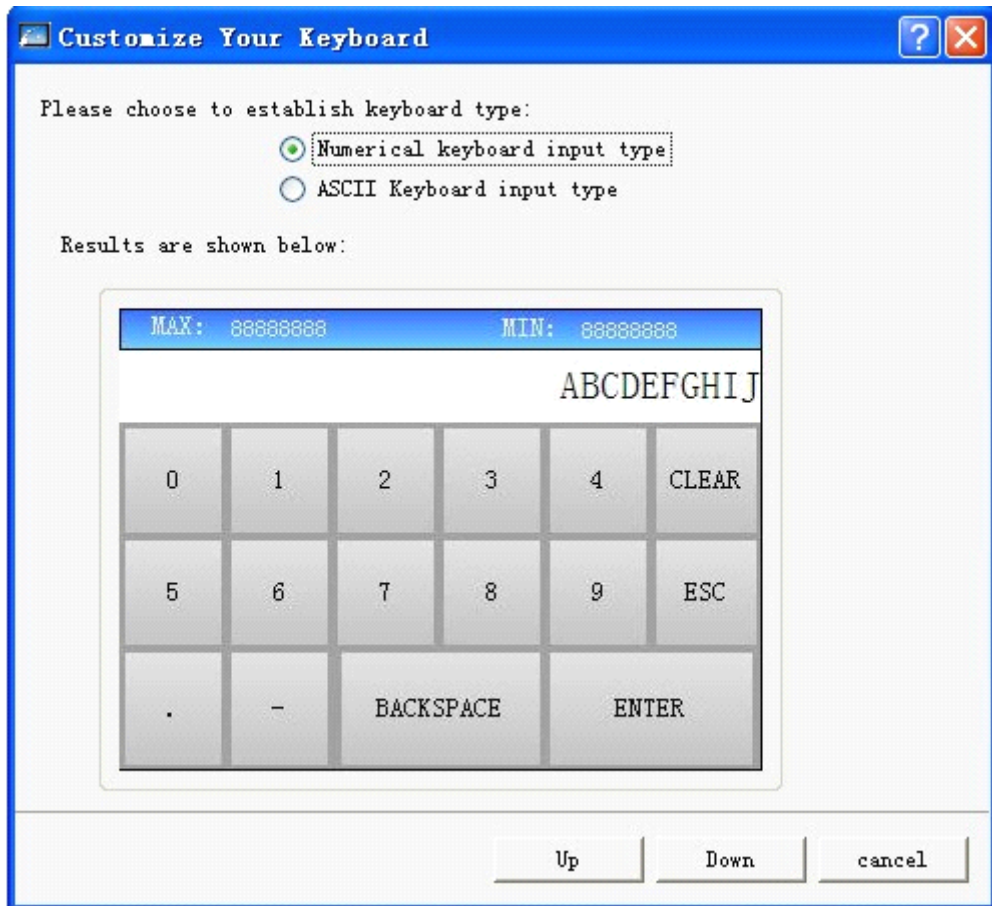

Figure 4-130: Page 2 of user-defined keyboard guide

After choosing a keyboard type, click Next, and then the system will load a predefined keyboard. Totally 9 predefined keyboards can be loaded, and you can add desired keyboards (up to 32 keyboards), as shown in Figure 4-131:

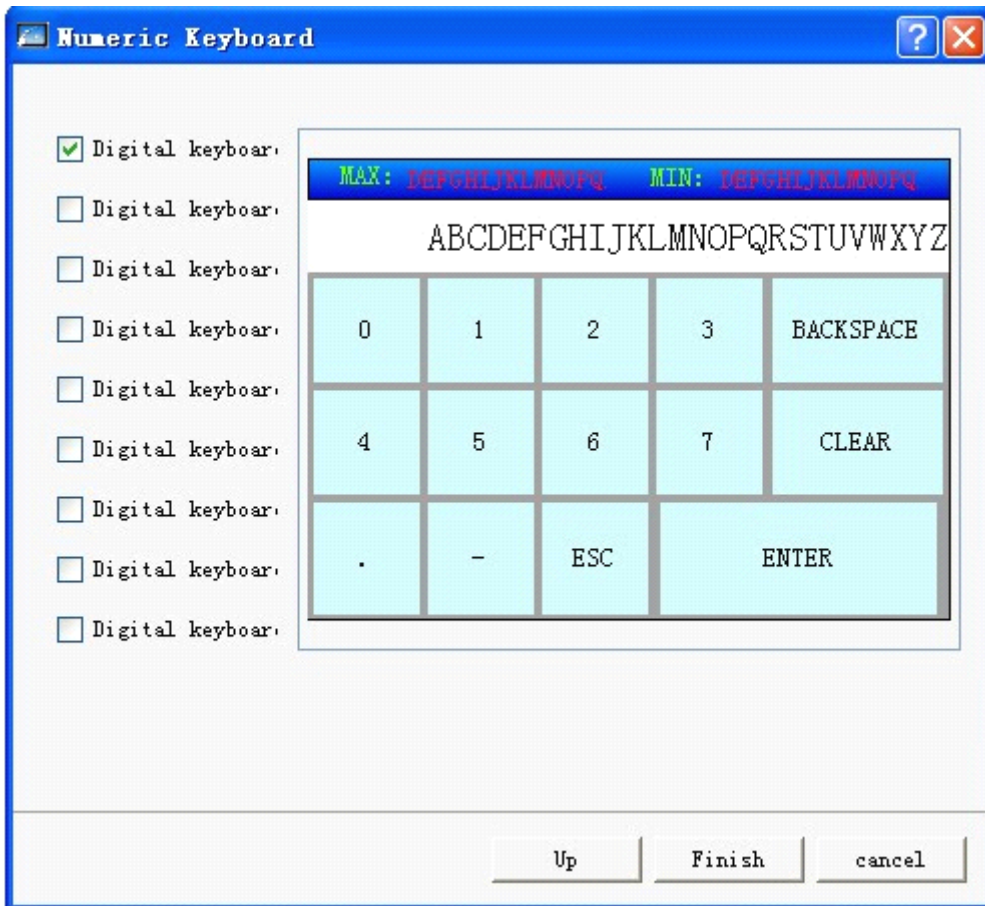

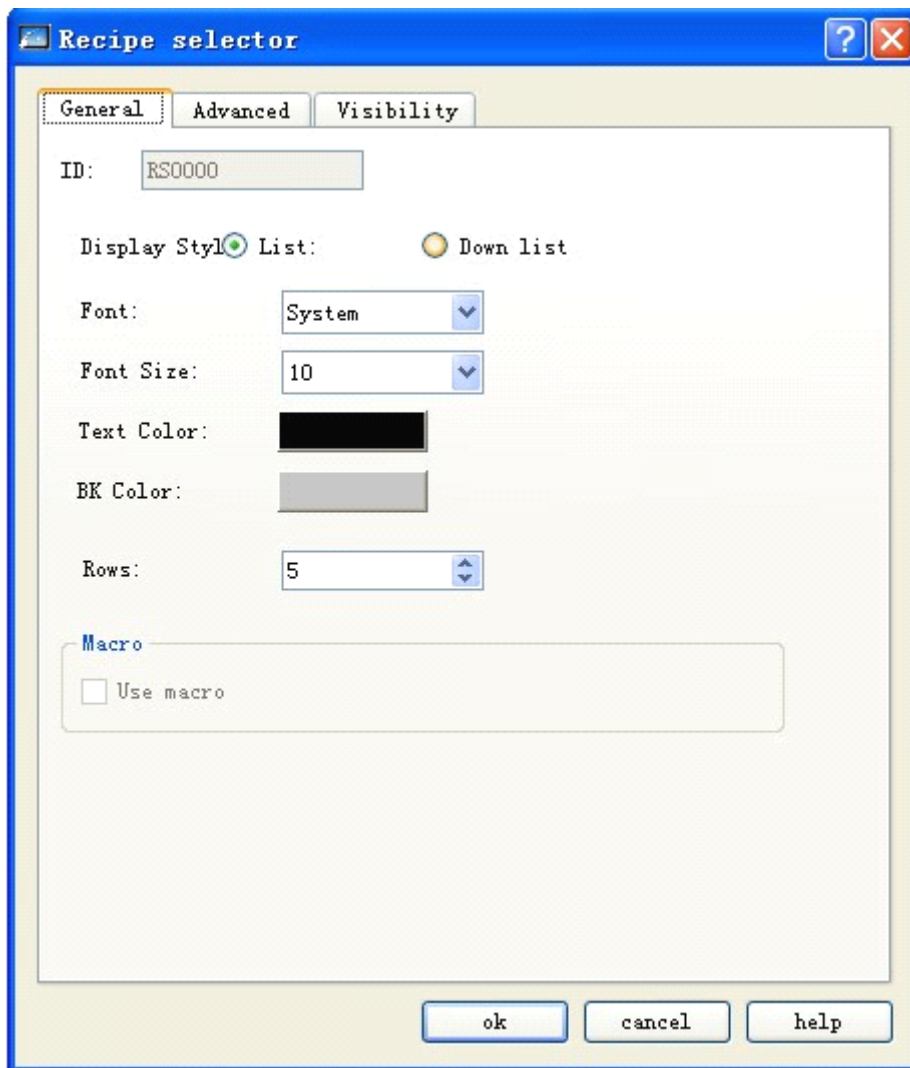

Figure 4-131: Page 3 of user-defined keyboard guide

After clicking Complete button, you can add the chosen keyboard to the project.

4.6.10 Recipe selector of SKWorkshop

The function of recipe selector is to list the names of all recipes (if any). Then, you can choose a recipe in the list and the system will write the number of this recipe into the recipe number register RWI0. Accordingly, if the value of the recipe number register RWI0 is changed, the recipe selector will point to the specified recipe name. The icon of this control in the toolbar is . Click this icon, and then a dialog as shown in the figure below will pop up:



General tab of recipe selector

- Display style:
 - List: Display all the recipe names in the form of a list.
 - Dropdown box: Display all the recipe names in the form of a dropdown box.
- The Font, Font Size, Text Color and Background Color are settings for the list box and the texts.
- Line number: This option is applicable only when List is chosen.

4.6.11 Recipe data display of SKWorkshop

The function of recipe data display is to list all data in the recipes (if any). The icon of this control in the toolbar is . Click this icon, and then a dialog as shown in the figure below will pop up:

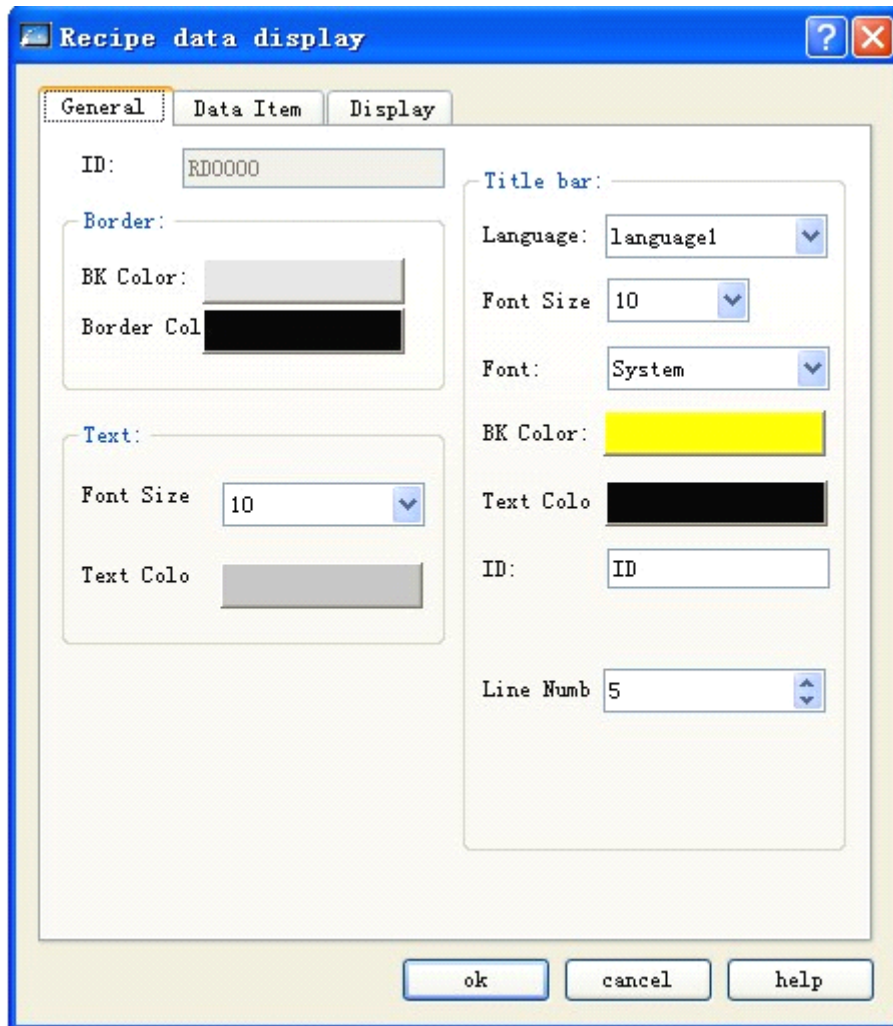

General tab of recipe data display

- The General tab contains settings of the texts and list box, and here we do not make detailed introduction to it.

Data tab is shown as follows:

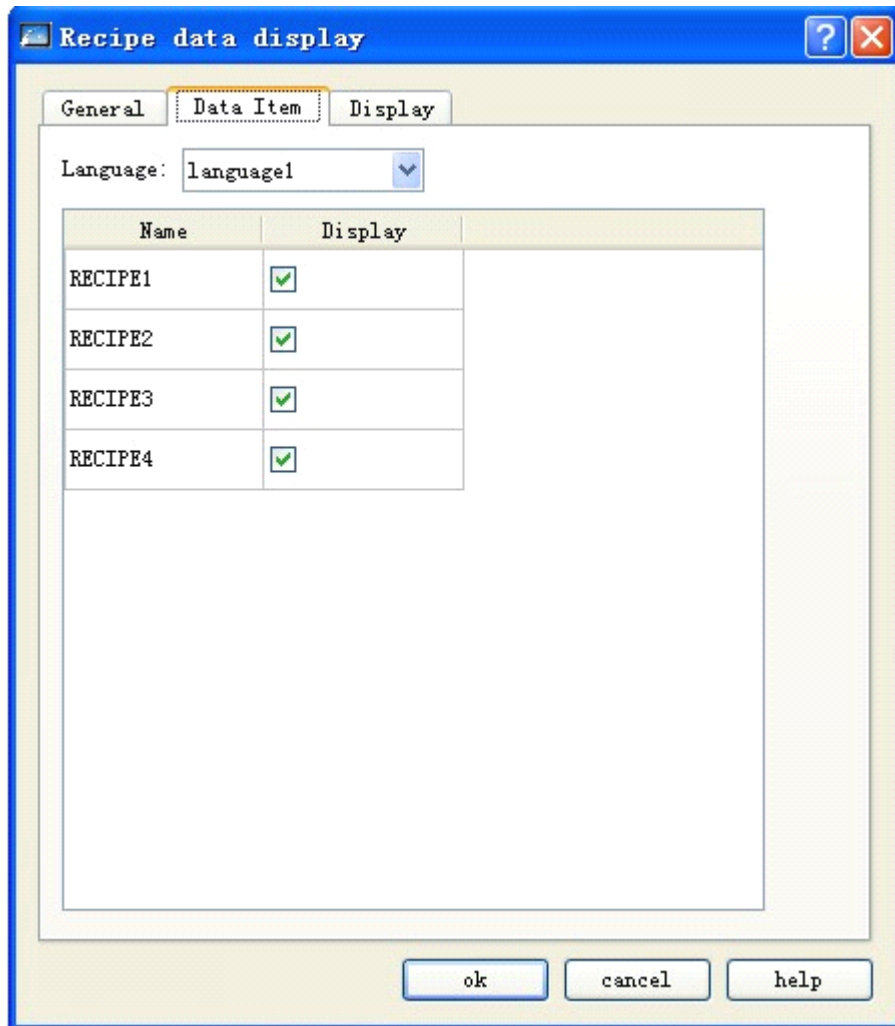

Data tab of recipe data display

- Language: Choose different languages to list the recipe names in different languages.
- Name: List all recipe names.
- Display: Whether to display a specified recipe. You can decide whether to display a recipe basing on actual needs.

4.6.12 Operation record display of SKWorkshop

Choose  in the toolbar, and set parameters of the operation record display control in the pop-up dialog as shown in Figure 4-132:

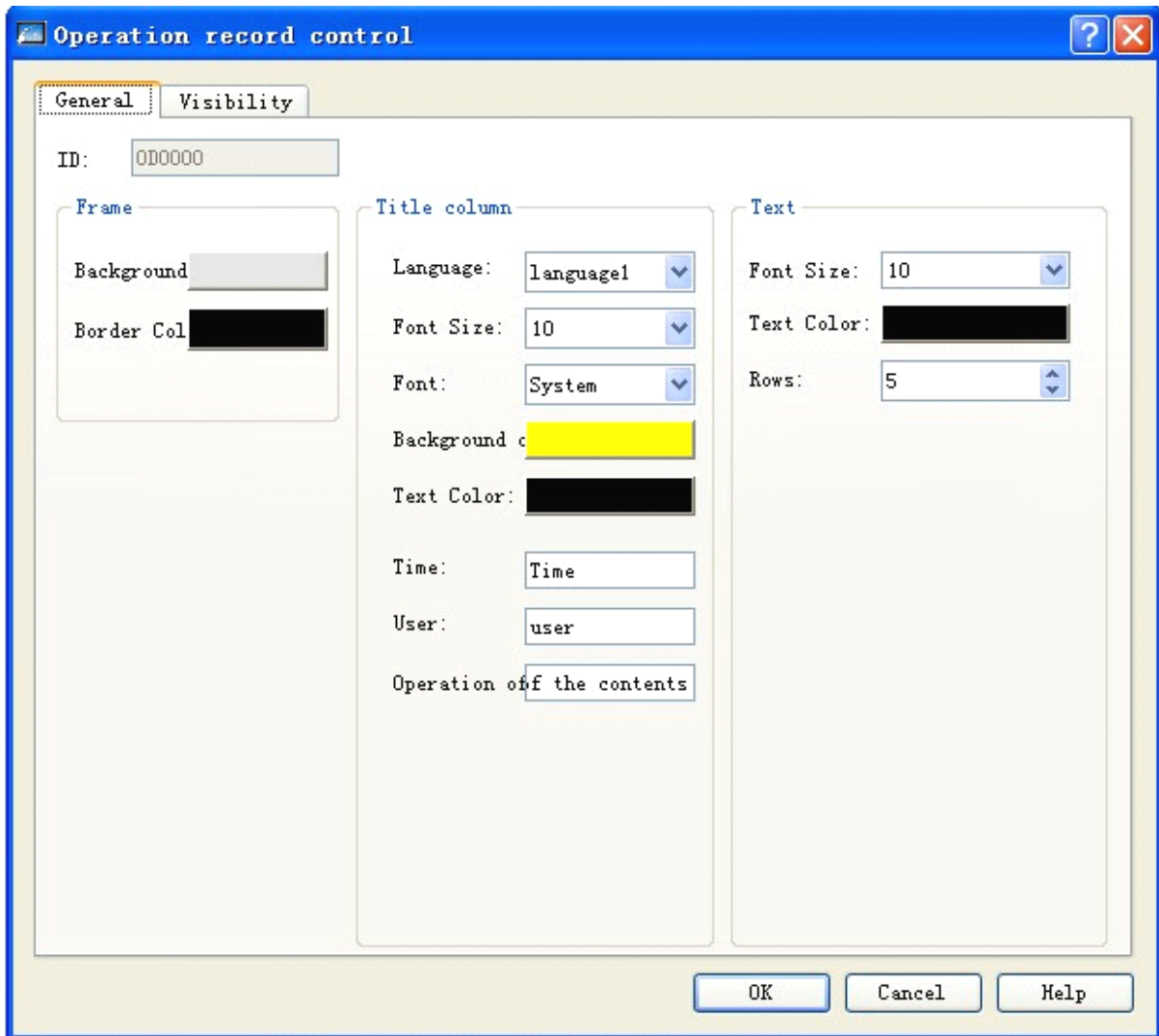

Figure 4-132: Operation record parameter setting dialog

- Background color: Set background color of the control.
- Border color: Set border color of the control.
- Language: Set the contents of the title bar if multiple languages are chosen.
- Font size: Font size of the title bar.
- Background color: Background color of the title bar.
- Word color: Word color of the title bar.
- Time: Text displayed in the time column of the title bar.
- User: Text displayed in the user column of the title bar.
- Operation contents: Text displayed in the operation content column of the title bar.
- Font size: Font size of the record text.
- Text color: Color of the record text.

- Line number: Maximum number of lines to be displayed by the control.

Note: LW60601 must be set to 1 to enable record operation of HMI.

4.7 Control operation introduction of SKWorkshop

SKWorkshop V4.0 configuration software provides powerful basic controls. When creating a configuration project, the new control will be displayed in the user area, and you can change the properties of the control by double clicking and right clicking. Position and size of control can be entered manually in the status bar below the user area or be changed by mouse dragging.

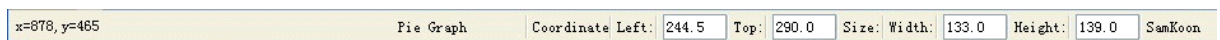

Enter address in control: When you need to set a PLC address during property setting, you can directly enter the address using keyboard. The address name is not case sensitive.

- State combination box: In the tool bar there is a State Combination Box, and here the state of Bit Button, Bit Lamp, Multistate Switch, Multistate Lamp, Graphics Move, Message Display, and Picture Display can be displayed and modified.



- When one of the above controls is chosen, its current state is displayed in the State Combination Box. You can change the current state using the drop-down menu.
- Address Find: With this function you can see the use information of an address, including a list of the controls using this address. You can double click this information item to choose the control.



- Enter an address and click Find, and then the results will be shown in the information output window.

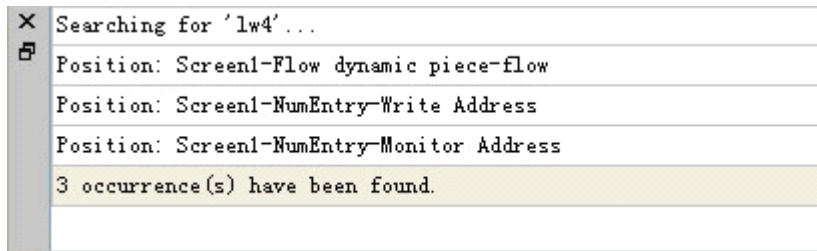

Choose a result and double click it to choose the controls using this address.

Address Table: Click Address Table, the system will give a list of the addresses used by the current project. Double click an address, a property setting dialog for the controls using this address will pop up, so that you can set the properties quickly and conveniently.



In Display Type, you can choose to display information of addresses used by a chosen screen or by all screens.

Control overlying: With control overlying, you can execute multiple controls by touching the screen once. **SKWorkshop V4.0** allows for overlying of 32 controls at most. When multiple controls are overlain and then touched, they will be executed in turn basing on the overlying layer sequence. For example, if control 1, 2 and 3 are overlain, the commands of button 1, 2 and 3 will be executed in turn after touching.

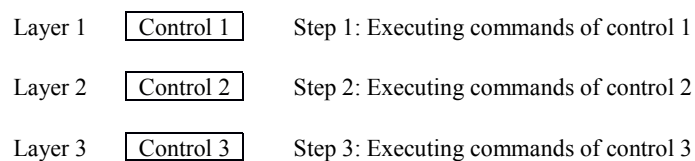

If there is a screen switch button in the overlain controls, the screen will be switched after this button is executed, and the buttons behind this screen will not be executed. Similarly, if a pop-up input keyboard is in the overlain buttons, the keyboard will pop up and the buttons behind the button will not be executed.

Layer 1	Control 1	Step 1: Executing commands of control 1
Layer 2	Data inputting	Step 2: Executing data inputting pop-up keyboard
Layer 3	Control 3	No execution

5. Macro

Macro is an advanced control method for touch screen, which provides more strong functions for touch screen. Through programming for macro command, the touch screen is given the same functions as logic and arithmetic operation with PLC. Using the macro flexibly is capable to achieve many strong functions that are unavailable for conventional components and to perfect the human-computer interface more.

SKWorkshop V4.0 provides new full macros that are different from the script language mode of other human-computer interfaces, and these macros are compatible with standard C Language (ANSI C89). As there are many literatures about C Language and this information are available easily, this chapter will not introduce syntax and basic knowledge in details to review the relevant basis of different macros but emphasize the establishment and usage of macros by instances.

This chapter will explain basic C Language briefly, relevant usage of macroinstruction and considerations.

5.1. Introduction to C language

5.1.1 Data type of C language

1. Integer

Integer includes integer constant and integer variable. The integral constant is the integer constant. In C language, there are three kinds of integer constant: octal, hexadecimal and decimal.

2. Integer constant

1. Octal integer constant

The octal integer constant must begin with 0. That is to say, 0 is the prefix of octal integer constant. Its value is 0-7. Octal constant is usually unsigned.

The followings are the legal octal:

015 (decimal:13) 0101 (decimal:65) 0177777 (decimal:65535)

The followings are the illegal octal:

256 (without prefix 0) 03A2 (contained non-octal codes) -0127(with negative sign)

2. Hexadecimal integer constant

The hexadecimal integer constant is prefixed with 0X or 0x. Its value is 0-9, A-F or a-f.

The followings are the legal hexadecimal:

0X2A (decimal:42) 0XA0 (decimal:160) 0XFFFF (decimal: 65535)

The followings are the illegal hexadecimal:

5A (without prefix 0X) 0X3H (contained non-hexadecimal codes)

3. Decimal integer constant

The octal integer constant has no prefix. Its value is 0-9.

The followings are the legal decimal:

237 -568 65535 1627

The followings are the illegal decimal:

023 (prefix 0 is forbidden) 23D (contained non-decimal codes)

In the program, these notations are distinguished by prefix. Therefore, do not mistake the prefix in writing to avoid incorrect result.

4. When the suffix of integer constant is on the 16-bit computer, its basic integer is 16-bit. Therefore, the indicated figure value is limited. The decimal unsigned constant is within 0 ~ 65535, and the signed range is -32768 ~ +32767. The unsigned octal number is ranged within 0 ~ 0177777. The unsigned hexadecimal number is within 0X0 ~ 0XFFFF or 0x0 ~ 0xFFFF. If the figure is beyond the above range, it must indicate with long integer. The long integer is suffixed with "L" or "l". For example:

Decimal long integer constant 158L (decimal: 158) 358000L (decimal: -358000)

Octal long integer constant 012L (decimal: 10) 077L (decimal: 63) 0200000L (decimal: 65536)

Hexadecimal long integer constant 0X15L (decimal: 21) 0XA5L (decimal: 165) 0X10000L (decimal: 65536).

There is no difference between long int 158L and basic int constant 158. As 158L is the long integer, C compiling system will assign 4-bit space for storage. As 158 is the long integer, C compiling system will assign 2-bit space for storage. Therefore, pay attention to operation and output format to avoid mistakes. The unsigned number can be indicated with suffix. The unsigned number of integer constant is suffixed with "U" or "u". For example: 358u, 0x38Au, 235Lu are the unsigned number. Use prefix and suffix together to indicate different figures. For example, 0XA5Lu indicates the hexadecimal unsigned long int A5 and the corresponding decimal is 165.

3. Integer variable

The integer variable can be classified as following:

1. Int

Its type specifier is int, which occupies 2 bytes in the memory. Its value is always basic integer.

2. Short int

Its type specifier is short int or short. Its occupied bytes and value range is same to basic int.

3. Long int

Its type specifier is long int or long, which occupies 4 bytes in the memory. Its value is always long integer.

4. Unsigned int

Its type specifier is unsigned.

The unsigned int can be integrated with the above three types:

- (1) The type specifier of unsigned int is unsigned int or unsigned.
- (2) The type specifier of unsigned short int is unsigned short.
- (3) The type specifier of unsigned long int is unsigned long.

All unsigned int occupies the same memory bytes with the signed int. As the sign bit is omitted, it can not indicate the negative number. The following table lists the assigned memory bytes and number range of various integers in ARM.

Type Specifier	Number Range	Assigned Bytes
Int	-2147483648~2147483647	■■■■
Short int	-2147483648~2147483647	■■■■
Signed int	-2147483648~2147483647	■■■■
Unsigned int	0~4294967295	■■■■
Long int	-922337203685477808~922337203685477807	■■■■■■■■
Unsigned long	0~18446744073709551615	■■■■■■■■

4. Integer variable declaration

The general form of variable declaration: type specifier, variable name identifier, Take examples as following:

int a,b,c; (a,b,c is integer variable)

long x,y; (x,y is long integer variable)

unsigned p,q; (p,q is unsigned integer variable)

Announcements in writing variables should be paid attention as following:

1. Several same type of variables can be allowed to indicate after the same type specifier. Space the variable names with comma. There must be a space at least between the type specifier and variable name.
2. The last variable name must be ended with ";".
3. The variable declaration must be in front of variable usage. It is always at the head of function body.

```
[Practice] //1int a,b;
short int c;
short d=100;
a=d-20;
b=a+d;
```

```
c=a+b+d;

d=d-a+c-b.
```

5. Float constant

Real constant is also called float constant. Real constant is also called float constant. In the C language, the float is indicated with decimal only. It has two forms as following: Decimal form and exponential form

1. Decimal form

It is composed with figure 0-9 and decimal point. For example: 0.0,.25,5.789,0.13,5.0,300.,-267.8230 are the legal float number.

2. Exponential form

It is composed of decimal digit, exponent symbol "e" or "E" and exponent (be integer only, symbol is possible). The basic form is an E n (a is decimal, n is decimal integer) and the value is $a \times 10^n$. For example, 2.1E5 (equal to 2.1×10^5), 3.7E-2 (equal to 3.7×10^{-2}), 0.5E7 (equal to 0.5×10^7), -2.8E-2 (equal to -2.8×10^{-2}). The following are the illegal float number: 345 (without decimal point) E7 (without figure before exponent symbol) -5 (without exponent symbol) 53.-E3 (negative sign is incorrect) 2.7E (without exponent)

The standard floating number in C language has suffix. The figure with suffix "f" or "F" is the floating number. For example, 356f and 356 is equivalent.

6. Float variable

The float variable includes single and double. Their type specifiers are float and double. In the Turbo C, the single occupies four bytes (32-bit) memory, and it is ranged between $3.4E-38 \sim 3.4E+38$, which provides seven effective figures only. The double occupies 8 bytes (64-bit) memory, and the value is ranged between $1.7E-308 \sim 1.7E+308$, which provides sixteen effective figures.

The form and written rules for float variable declaration is same with that of integer.

```
For example: float x,y; (x,y is single float)
             double a,b,c; (a,b,c is double float)
```

The float constant is not classified into single and double. All float constants are processed as double.

```
a  ■■■■
b  ■■■■■■■■
a<---33333.33333
b<---33333.333333333333;

[Practice] //float int a=32;

float b;

double d;

b=12345678;

d=b*100;
```



```
d=d+a;
```

```
d=d+58.123456;
```

7. Character

Characters include character constant and character variable.

Character constant

Character constant is a character within single quote. For example, 'a', 'b', '=', '+', ',', '?' are the legal character constants. In the C language, the character constants are always characterized as following:

1. Character constant must be included in single quote rather than double quotes or other brackets.
2. Character constant must be single character rather than character string.
3. Character may be any character in the character set. However, the figure can not be involved in numerical operation after been defined as character. For example, '5' and 5 is different. '5' is character constant that are not involved in operation.

8. Character variable

The character variable value is character constant, i.e. single character. Its type specifier is char. The form and written rules of character variable declaration is same with that of integer variable.

For example:

```
char a,b;
```

As each character variable is assigned to a byte memory, one character is saved only. The character value is kept in the memory unit with ASCII code. For example, the decimal ASCII code for x is 120, and the decimal ASCII code for y is 121. Give 'x' and 'y' to character variable a and b: a='x', b='y'. Actually, it is to store 120 and 121 BC in a and b unit:

```
a 0 1 1 1 1 0 0 0
```

```
b 0 1 1 1 1 0 0 1
```

Therefore, they can be regarded as integer. C language allows to give character value to integer variable and give integer to character variable as well. It can output character variable as integer and output integer as character. The integer is 2-byte, and character is single byte. When the integer is processed as character, the low eight bytes are involved only.

```
[Practice] //charint a=49;
```

```
char b;
```

```
char d;
```

```
b=a+10;
```

```
d=a+b;
```

```
[Practice] //char c1,c2;
```

```
c1='a';c2='b';
```

```
c1=c1-32;c2=c2-32;
```

9. Character string constant

Character string constant is a character string included in double quotes. For example: "CHINA". "C program", "\$12.5", they are legal character string constants. The character string constant is different from character constant. Their differences are described as following:

1. Character constant is included in single quotes while character string constant is included in double quotes.
2. Character constant is single character only while character string constant contains one or several characters.
3. A character can be given to a character variable, but a character string constant can not. In the C language, there is no corresponding character string variable.
4. The character constant occupies one byte in the memory. The bytes of character string constant are equal to the bytes of character string plus 1. Save character "\0" (ASCII code:0) in the increased byte. This is the ending symbol of character string. For example, the byte of "C program" in memory is C program\0. Although the character constant 'a' and character string constant "a" has one character both, their memory occupation is different.

'a' occupies one byte in the memory, which is indicated as a

"a" occupies two bytes in the memory, which is indicated as a\0 symbol constant.

10. Symbol constant

In the C language, a constant can be expressed with an identifier, which is called symbol constant. It must be defined before usage. Its general form is:

```
#define symbol constant
```

Wherein, #define is a preprocessor directive, which is called macro definition directive. It is used to define the identifier to the constant value. Upon definition, all of this identifier in the future program will be replaced by the constant value. Usually, the identifier of symbol constant is expressed with capital letter and the variable identifier is expressed with lowercase letter for distraction.

```
#define PI 3.14159

void main(){

float s,r;

r=5;

s=PI*r*r;

printf("s=%f\n",s);

}
```

It is defined by macro definition directive. PI is defined to be 3.14159, and s,r is defined to be float. $5 \rightarrow r$ $PI * r * r \rightarrow s$

Display program result float s,r. wherein, $r=5$, $s=PI*r*r$. This program is defined by macro definition directive before main function. PI is 3.14159, which substitutes for PI in the program. $s=PI*r*r$ is equivalent to $s=3.14159*r*r$. Pay attention: symbol constant is not variable. Its value can not be changed in the overall action scope. That is to say, assignment statement is forbidden to re-assign in the program.

5.1.2. Initial value of variable and type conversion

1. Initial value assignment for variable

In the program, it is usually to assign initial value for the variable. There are many methods for initial value assignment in the language program, which are called initialization. In the variable declaration, the general form of initial value assignment is:

Type specifier variable 1 = 1, variable 2 = 2,; for example:

```
int a=b=c=5;
```

```
float x=3.2,y=3f,z=0.75;
```

```
char ch1='K',ch2='P';
```

Note: no continuous assignment is forbidden in the declaration, for instance `a=b=c=5` is illegal.

2. Type conversion of variable

The variable type is convertible. There are two methods for conversion. One is automatic conversion, the other is forced conversion.

Automatic conversion

When the different types of data are involved in hybrid operation, the automatic conversion is completed by compilation system. The auto conversion should conform to the following rules:

1. If the data types involved in operation are different, first convert them into one type, then make operation.
2. Conversion is made as the data length so as to ensure the high precision. For example, when int and long is in operation, convert int into long, then make operation.
3. All float operations are double. Even the expression contains float only, it must be converted to double for operation.
4. Char and short must be converted into int for operation.
5. In the assignment operation, when the data types on both sides of assignment sign are different, the right data type will be converted to the left type. If the right data is longer than left one, it will loss a part of data. In this case, the precision will be reduces. The lost data will be rounded off.

3. Forced type conversion

The forced type conversion is achieved by type conversion operation. Its general form is (type specifier) (expression). It is used to convert the operation results into the specified type of type specifier by force. Take an example of (float) a. convert a to float (int)(x+y), convert the result of x+y into integer. In forced conversion, there are some points to be noted:

1. Type specifier and expression must be included in the bracket (the single variable may not be bracketed). If (int)(x+y) is written to be (int)x+y, it means to convert x into int and plus y.
2. Either forced conversion or auto conversion is just the temporary conversion of data length for convenience of the operation. It will not change the variable type in the data declaration.

5.1.3. Basic operator and expression

Category, priority and associativity of operator

There are many operators and expressions in C language, which is seldom in the high-level language. It is the rich operator and expression that complete the C language. This is one of main features of C language.

The operators of C language have different priorities. In addition, they have individual associativity. In the expression, the data for operation should not only conform to the priority of operators but also subjected to the associativity so as to confirm the operation direction from left to right or from right to left. This associativity is unavailable for other high-level language, which increases the complexity of C language.

Operator Category

The operators of C language can be classified as following:

1. Arithmetic operator

It is used for different data operations, including addition (+), subtraction (-), multiplication (*) and division(/) (or modular arithmetic, %), increment (++) and decrement (--).

2. Relational operator

It is used for comparison operation, including greater than (>), less than (<), equal to (==), be equal or greater than (>=), be equal or less than (<=) and unequal to (!=).

3. Logical operator

It is used for logical operation, including And (&&), Or (||) and Not (!).

4. Bit operation operator

The data for operation is taken as binary bit, including bit and (&), bit or (|), bit not (~), bit or (^), left shift (<<) and right shift (>>).

5. Assignment operator

It is used for assignment operation, including simple assignment (=), composite arithmetic assignment (+=, -=, *=, /=, %=) and composite bit operation assignment (&=, |=, ^=, >>=, <<=).

6. Conditional operator

This is a ternary operator for conditional evaluation (?:).

7. Comma operator

It is used for combining several expressions to one expression (,).

8. Pointer operator

It is used for two operations as content-of (*) and address-of (&).

9. Size-of operator

It is used for size-of operation of data.

10. Special operator

It includes bracket (), subscript [] etc.

5.1.4. One-dimensional array

In the program design, the array organizes several variables with same category in ordered form for convenience. The set containing data elements with the same category in order is called array. In C language, the array belongs to construction data. One array can be split into several array elements. These array elements are either basic data or construction data. Therefore, the array can be classified into numerical array, character array, pointer array, structure array according to the category of array element.

This section will introduce the numerical array and character array, others will be described in the successive sections. If the array type declaration uses array in C language, it must be made type declaration first. The general form of array declaration is: type specifier array name [constant expression]. Wherein, type specifier refers to any basic data or construction data. Array name refers to the array identifier defined by users. The constant expression in square bracket indicates the quantity of data elements, which is also called array length.

For example:

```
int a[10]; int array a contains 10 elements.
```

```
float b[10],c[20]; float array b contains 10 elements; float array c contains 20 elements.
```

```
char ch[20]; character array ch contains 20 elements.
```

For the array type declaration, there are several points as following:

1. The array type actually refers to the value type of array element. For the same array, the data type of all elements is the same.
2. The writing rules for array name should conform to that of identifier.
3. The array name should not be same with other variable name.

For example: void main ()

```
{
```

```
int a;
```

```
float a[10];
```

```
.....
```

```
} is incorrect
```

4. The constant expression in the square bracket refers to the element quantity. For example, a [5] indicates that array a contains 5 elements. However, its subscript is started from 0. Therefore, the five elements are a[0],a[1],a[2],a[3],a[4].
5. The square bracket can not include the element quantity of variables but symbol constant or constant expression is available. For instance:

```
#define FD 5
```

```
void main ()
{
int a[3+2],b[7+FD];
.....
}
```

} is legal. However, the following expression form is incorrect.

```
void main()
{
int n=5;
int a[n];
.....
}
```

6. It is allowed that the same type declaration can describe several arrays and several variables.

For example: `int a,b,c,d,k1[10],k2[20];`

1. Representation of array element

Array elements are the basic unit of array. It is also a variable, which is identified with array name and a subscript. The subscript indicates the sequence number of element in the array. The general form of array element is: array name [subscript]. Wherein, subscript is integer constant or integer expression only. If it has decimal, this value will be integer automatically by C programming. For example, `a[5]`, `a[i+j]`, `a[i++]` are the legal array elements. Array element is usually called subscript variable. The subscript variable could not be used unless array is defined. In C language, the subscript variable is used one by one rather than the whole array.

The general form of initialization assignment is: static type specifier array name [constant expression]=[value.....]. Wherein, static refers to the static storage type. It is specified that only static storage array and external storage array can be initialized assignment (the relevant static storage and external storage concepts will be introduced in Chapter 5) in C language. The data in { } are the initial value of each element, and the elements are spaced with comma such as `static int a[10]={ 0,1,2,3,4,5,6,7,8,9 }`, which is equivalent to `a[0]=0;a[1]=1...a[9]=9;`

2. There are several provisions for initial assignment of array in C language:

1. It is allowed to assign initial value for partial elements. When the elements in { } is less than element quantity, the initial value is assigned for the front only. For example: `static int a[10]={0,1,2,3,4}`, it indicates that the initial value will be assigned for the first 5 elements `a[0]~a[4]`, and the last 5 elements will be assigned 0 automatically.
2. Assign initial value for element one by one, and the overall assignment for array is unavailable. For example, if assigning 1 for 10 elements, it can write to be `static int a[10]={1,1,1,1,1,1,1,1,1,1}` rather than `static int a[10]=1`.
3. If the initial value assignment is unavailable for all arrays with initialization, all elements will be 0.
4. If assigning all elements, the array element quantity may not be given in the array declaration. For example: `static int a[5]={1,2,3,4,5}` can be written as `static int a[]={1,2,3,4,5}`. The dynamic assignment can be made during program execution. In this case, it can use do statement and scanf function to assign the array elements one by one.

3. Character array

The array for storing characters is called character array. The form of type declaration for character array is same to that of numerical array as previous introduction. For example: `char c[10]`. As the character and integer is similar, it can be defined as `int c[10]`, but each array element occupies 2 bytes in memory. The character array may be two-dimensional array. For instance, `char c[5][10]` is a two-dimensional character array. The character array is allowed to made initialization assignment in type declaration. Take `static char c[10]={'c',' ','p','r','o','g','r','a','m'}` as an example. After assignment, the element value is `c[0]c[1]c[2]c[3]c[4]c [5]c[6]c[7]c[8]c[9]` for array C. Wherein, `c[9]` is not assigned and assigned to 0 by system automatically. When assigning initial value for all elements, the length declaration can be omitted such as `static char c[]={'c',' ','p','r','o','g','r','a','m'}`, in which the length of C array is set to 9.

C language allows for initialization assignment for array in character string. For example, `static char c[]={'c',' ','p','r','o','g','r','a','m'}` can be written to `static char c[]="C program"` or `static char c[]="C program"` without `{}`. The assignment in character string occupies one more byte than assignment one by one. It is used to store the ending sign of character string `'\0'`. The actual storage of array c in memory is `C program\0`. Wherein, `'\0'` is added by C programming system automatically. As `'\0'` sign is adopted, the array length is not normally defined in initialization assignment of character string but processed by system automatically. If in the mode of character string, the input and output of character array becomes simple and convenient. Except the initial value assignment with character string, it can input and output the character string of one character array with `printf` function and `scanf` function at one time not requiring input/output each character with `do` statement one by one.

5.1.5 Section summary

1. C data type

Basic type, construction type, pointer type and void type

2. Classification and characteristics of basic type

Type Specifier	Byte	Number Range
Char	1	C character set
Int	4	-214783648~214783647
Short int	4	-214783648~214783647
Long integer long int	8	-922337203685477808~922337203685477807
Unsigned	4	0~4294967295
Unsigned long	8	0~1844744073709551615
Float	4	3/4E-38~3/4E+38
Double	8	1/7E-308~1/7E+308

3. Constant suffix

L or l for long int

U or u for unsigned

F or f for float

4. Constant type

Int, long int, unsigned, float, char, char string, symbol constant, and escape character

5. Data type conversion

Auto conversion

The system realizes auto conversion for the hybrid operation of different types of data, which converts from small byte data to big byte data. For the mutual assignment of different data, the system also converts automatically, which converts the right data type into left one.

Forced conversion

It is converted by forced conversion operator.

6. Priority and associativity of operator

Generally speaking, the unary operator has higher priority and the assignment operator has lower priority. The arithmetic operator has higher priority, and the relational and logical has lower priority. Most operators have left associativity, unary operator, ternary operator and assignment.

7. Expression

Expression is the formula composed with connection constant, variable and function of operator. Each expression has one value and type. The evaluation of expression is made according to the sequence specified by priority and associativity of operator.

8. Array

1. Array is the commonest data structure in program design. The array contains numerical array (int array, float array), character array and pointer array, structure array to be described later.
2. Array may be one-dimensional, two-dimensional or multi-dimensional.
3. The type declaration of array consists of type specifier, array name and array length (elements quantity of array). The array element is also called subscript variable. The array type refers to the value type of subscript variable.
4. Make array assignment with three methods: initialization assignment, dynamic assignment by inputting function and assignment statement. The numerical array can not be overall assigned, input or output with assignment statement but assigned for array element one by one with do statement.

5.2. C language programming preliminary

5.2.1. Statement of C program

The execution part of C program is constituted by statements, and the program function is also realized by execution statement. C statement is classified into five categories:

1. Expression statement
2. Control statement

3. Compound statement

4. Null statement

1. Expression statement

Expression statement consists of expression and semicolon. Its general form is expression;. Execution of expression statement is to compute the expression value. For example, x=y+z; assignment statement y+z; operate statement with addition, but the result is not kept. It has no actual significance i++. Increment 1 statement, i value increases 1.

2. Control statement

Control statement is to control the program process so as to realize various structures of program.

It is composed of special statement delimiter. There are nine control statements in C language, which can be classified into three kinds:

(1) Conditional judgment statement

if statement, switch statement

(2) Looping execution statement

do while statement, while statement, for statement

(3) Go to statement

break statement, go to statement, continue statement, return statement

3. Null statement

The statement with semicolon only is called null statement. Null statement executes nothing. In the program, null statement can be the null loop body. Take an example of while (getchar()!=\n'). For this statement, if the character input from keyboard is not Enter, it requires re-input. Here, the loop body is null statement.

4. Assignment statement

Assignment statement consists of assignment expression and semicolon. Its general form is variable = expression. Its functions and features are same to that of assignment expression. It is one of the most popular statements in the program. There are some points to be noted in the usage of assignment statement:

1. As the expression on the right of assignment sign "=" can be an assignment expression, the following form Variable=(variable=expression); is established, then the nestification is formed. Its expanded expression is Variable=Variable=...=Expression;

For example:

a=b=c=d=e=5; according to the right associativity of assignment operator, it is equivalent to: e=5 actually;

d=e;

c=d;

b=c;

a=b;

2. Pay attention to the difference between assigning initial value and statement for variable in the variable declaration. Assigning initial value to variable is a part of variable declaration. The variable with initial value assignment should be spaced with comma to other similar variable, but the assignment statement must be ended with semicolon.
3. In the variable declaration, it is forbidden to assign initial value for several variables successively. For example, the following declaration is incorrect. `Int a=b=c=5` must be written to `int a=5,b=5,c=5`. However, the assignment statement must be assigned continuously.
4. Note the difference between assignment expression and assignment statement. Assignment expression is a kind of expression, which can be used in any allowable place. But the assignment statement can not.

The following statement is legal: `if((x=y+5)>0) z=x;` the function of statement: if expression `x=y+5` is greater than 0, then `z=0`.

The following statement is illegal: `if((x=y+5;)>0) z=x;` as `x=y+5;` is a statement, it can not be used in expression.

5.2.2. Branch structure program

Relational operator and expression

In the program, it usually compares the size of two data so as to confirm the next process. The operator for comparing data size is called the relational operator. There are such relational operators in C language as following:

< less than

<= less than or equal to

> greater than

>= greater than or equal to

== equal to

!= unequal to

The relational operator is binary operator, which is left associative. Its priority is lower than that of arithmetic operator and higher than that of assignment operator. In the six relational operators, `<`, `<=`, `>`, `>=` has the same priority, which is higher than `==` and `!=`. While `==` and `!=` has the same priority.

Relational expression

The general form of relational expression is Expression Relational operator Expression. For example, `a+b>c-d,x>3/2,'a'+1<c,-i-5*j==k+1` are legal relational expression. As the expression is relational expression concurrently, the nestification may occur such as `a>(b>c),a!=(c==d)` etc. The value of relational expression is "true" and "false", which is expressed with "1" and "0".

1. Logical operator and expression

In C language, the logical operators include AND operator `&&`, OR operator `||` and NOT operator `!`. AND operator `&&` and OR operator `||` are binary operators with left associativity. NOT operator `!` is unary operator with right associativity. The priority relation between logical operator and other operators can be expressed as following:

The following can be derived depending on the priority of operator:

$a > b \ \&\& \ c > d$ is equivalent to $(a > b) \ \&\& \ (c > d)$

$!b == c \ || \ d < a$ is equivalent to $((!b) == c) \ || \ (d < a)$

$a + b > c \ \&\& \ x + y < b$ is equivalent to $((a + b) > c) \ \&\& \ ((x + y) < b)$

Evaluation of logical operation

The evaluation of logical operation may be true or false expressed with 1 and 0 individually. Its evaluation rules are as following:

1. When the two values of AND operation $\&\&$ are true, the results are true; otherwise they are false. For example, $5 > 0 \ \&\& \ 4 > 2$. As $5 > 0$ is true and $4 > 2$ is true, the corresponding result is true.
2. When one of two values involved in OR operation $\|\|$ is true, the result is true. When two values are false, the result is false. Take an example of $5 > 0 \ || \ 5 > 8$. As $5 > 0$ is true, the corresponding result is true.
3. When the NOT operation $!$ involved in operation is true, the result is false; when the involved operation is false, the result is true.

For example, the result of $!(5 > 0)$ is false.

In the logical operation value of C programming, it represents “true” with “1” and represents “false” with “0”. Vice versa, when judging a value is true or false, 0 represents false and the non-zero data represents true. For example, as 5 and 3 are non zero, the value of $5 \ \&\& \ 3$ is “true” (i.e. 1).

Another example: the value of $5 \ || \ 0$ is “true” (i.e. 1).

The general form of logical expression is Expression – Logical operator – Expression. Wherein, the expression can be logical expression as well, which forms nestification? Take the $(a \ \&\& \ b) \ \&\& \ c$ as an instance. The above expression can be written to $a \ \&\& \ b \ \&\& \ c$ according to the left associativity of logical operator. The value of logical expression is the final value of various logical operation, which represents “true” and “false” with “1” and “0” respectively.

2. if statement

The branch structure can be constituted with if statement. It makes judgment according to the given conditions so as to confirm what branch program period is to be executed. If statement of C language has three basic forms.

1. The first form is: basic form.

if (expression) statement

It's semanteme: if the expression value is true, the following statement will be executed, otherwise not.

2. The second form is if-else.

if(expression)

statement 1;

else

statement 2;

Semanteme: if the expression value is true, it will execute statement 1; otherwise statement 2.

Input two integers, and output the bigger one. Judge a and b size with if-else statement. If a is bigger, it outputs a; otherwise b.

3. The third form is if-else-if form.

In the first two forms, if statement is normally used for two branches. When there are several branches for selection, if-else-if statement is adopted. Its basic form is:

```
if(expression 1)
statement 1;
else if(expression 2)
statement 2;
else if(expression 3)
statement 3;
...
else if(expression m)
statement m;
else
statement n;
```

Semanteme: judge the expression value in sequence. When a value is true, it executes the corresponding statement. Then it executes program out of if statement. If all expressions are false, it will execute statement n. Then continue to execute the subsequent program.

There are some points to be noted in if statement:

- (1) In the three forms of if statement, the one behind if is expression. This expression is usually the logical expression or relational expression. But it may be other expressions such as assignment expression even a variable. For example, if(a=5) statement and if(b) statement are allowable. As long as the expression value is not 0, it is true. If the expression value in if(a=5)...; expression is always not 0, the subsequent statement will be executed. This kind of situation may not take place in the program, but the syntax is legal.

Another example, program segment: if(a=b)

```
printf("%d",a);
else
printf("a=0");
```

Semanteme of the statement: assign b to a. if it is not 0, this value is output; otherwise it outputs "a=0" character string. This kind of application usually occurs in the program.

- (2) In if statement, the conditional judgment expression must be included in bracket, and ended with semicolon.

- (3) In the three forms of if statement, all statements should be single statement. If a group (several) statements are required execution with conditions, this group of statements must be bracketed with {} to form a compound statement. Pay attention that no semicolon is allowed behind }.

For example:

```
if(a>b){  
a++;  
b++;  
}  
else { a=0;  
b=10;  
}
```

4. Conditional operator and conditional expression

If the single assignment statement is executed only in the conditional statement, it is usually realized by conditional expression, which not only simplifies the process but also improves the operation efficiency.

Conditional operator ? and : is a ternary operator, which means three values are involved in operation. The general form of conditional expression composed by conditional operators is:

Expression 1 ? Expression 2: Expression 3

Its evaluation rule: if the expression 1 is true, its value of expression 2 will be the value of conditional expression; otherwise, the value of expression 2 will be the value of whole conditional expression. Conditional expression is normally applied in assignment statement. For example:

```
if(a>b) max=a;  
else max=b;
```

max=(a>b)?a:b; is expressed with conditional expression. Its semanteme is: if a>b is true, assign a to max; otherwise assign b to max.

In the application of conditional expression, there are some points to be noted as following:

1. The operation priority of conditional operator is lower than that of relational operator and arithmetic operator but higher than assignment operator. Therefore, max=(a>b)?a:b can be removed the bracket to be max=a>b?a:b.
2. Conditional operator ? and : is a pair of operator, which can not be separated in application.
3. The associative direction of conditional operator is from right to left.

5.2.3. switch statement

C language provides another switch statement for selection of multiple branches. Its general form is:

```
switch(expression){
```

```

case constant expression 1: statement 1;

case constant expression 2: statement 2;

...

case constant expression n: statement n;

default: statement n+1;

}

```

Semanteme: calculate the expression value, and compare with the subsequent constant expression value one by one. When the expression value is equal to a constant expression value, the subsequent statement is executed. Then judgment is not made. Continue the statement behind all case. If the expression value is different from the constant expression behind case, it will execute the statement behind default.

There are several points to be noted in switch statement:

1. All constant expression values behind case must be different, otherwise there will be mistake.
2. Several statements are allowed behind case, and they can not be bracketed with {}.
3. The sequence of case and default clauses may be changed and will not affect the program execution.
4. Default clause may be omitted

5.2.4. Loop structure program

The loop structure is an important structure of program. When the given condition is satisfied, one program segment is executed repeatedly until the condition is unsatisfied. The given condition is called loop condition, and the program segment executed repeatedly is called loop body. C language provides many loop statements, which may compose different loop structures.

1. While statement

The general form of while statement:

```
While (expression) statement;
```

wherein, the expression is loop condition, and the statement is loop body.

Semanteme of while statement: compute the expression value. When the value is true (not 0), the loop body statement is executed.

There are some points to be noted in while statement:

1. The expression of while statement is usually the relational expression or logical expression. As long as the expression value is true (not 0), it can continue loop.
2. If the loop body contains one or more statements, it must be bracketed with {} to form the compound statement.
3. Note the loop conditions to avoid endless loop.

2. Do-while statement

General form of do-while statement:

do statement;

while (expression);

Wherein, the statement is loop body, and the expression is the loop condition.

Semanteme of do-while statement:

First execute the loop body statement for one time, then judge the expression value. If the value is true (not 0), the loop is continuous; otherwise the loop ends.

The difference between do-while statement and while statement is that do-while executes first and judges late. Therefore, do-while will execute the loop body for one time at least. But while statement judges first and executes late. If the condition is unsatisfied, the loop body statement is not executed for one time.

while statement and do-while statement is usually mutual re-write.

In this example, the loop condition is rewritten to be $\neg n$. Otherwise, one more loop will be executed.

There are some points to be noted in do-while statement:

1. In the if statement and while statement, no semicolon is added behind the expression; while the expression of do-while statement must be ended with semicolon.
2. do-while statement may be composed to the nested loop and nested with while statement mutually.
3. The loop body between do and while is made up of several statements, and bracketed with {} to form a compound statement.
4. When converting do-while and while statement mutually, pay attention to modify the loop control conditions.

5.2.5. for statement

For statement is a kind of loop statement with stronger function and wider application provided by C language. Its general form is:

For (Expression 1;Expression 2;Expression 3)

statement;

Expression1: it is usually to assign initial value to loop variable, and it is assignment expression. It also allows to assign initial value to loop variable except for statement. In this case, the expression may be omitted.

Expression 2: it is usually the loop condition, and it is relational expression or logical expression.

Expression 3: it is usually for modifying the value of loop variable, and it is assignment statement.

These three expressions may be comma expression. That is to say, each expression can be composed with several expressions. Three expressions are options and can be omitted.

The “statement” in general form is loop body statement. Semanteme of for statement is:

1. First, calculate the value of expression 1.

2. Then, compute the value of expression 2. If the value is true (not 0), loop body is executed once more; otherwise exit the loop.
3. Calculate the value of expression 3 and return to execute step 2 again. During the for process, expression 1 is calculated for one time, and expression 2 and 3 may repeat for several times. The loop body may be executed for many times or not executed.

There are several points to be noted in for statement:

1. Each expression in for statement can be omitted, but the semicolon must exist. For example:

<1>for(expression; expression) expression is omitted

<2>for(expression; expression;)expression is omitted

<3>for(;expression; expression) all expression is omitted

2. When the loop variable has assigned initial value, Expression 1 may be omitted as shown in Example 3.27. If Expression 2 or 3 is omitted, the endless loop may be caused. In this case, the loop should be ended in loop body.

3. The loop body may be void statement.

```
#include" stdio.h"

void main(){

int n=0;

printf("input a string:\n");

for(;getchar()!='\n';n++);

printf("%d",n);

}
```

In this example, the expression 1 in for statement is omitted, and the expression 3 is not for modifying loop variable but for inputting the characters counting. Thus, the counting that should be completed in loop body has completed in the expression. Therefore, the loop body is void statement. Pay attention, the semicolon behind void statement is essential. If this semicolon is missed, the following printf statement will be executed as loop body. On the other hand, if the loop body is not void statement, it is forbidden to add semicolon behind the bracket of expression. In this case, the loop body will be regarded as void statement and not executed repeatedly. All of these are the common mistakes in programming, which must be attached great importance.

5.2.6. break statement

Break statement is used in switch statement or loop statement only. It is for exiting switch statement or local loop and directing to the subsequent program. As the transferring direction of break statement is specific, the statement marks are not required. The general form of break statement is break. As shown in the above example, the break statement is used in switch statement and for statement for skip. Break statement provides several exits for loop statement, which makes programming more flexible and convenient in some circumstances.

5.2.7. continue statement

Continue statement is used in loop body only.

Its general form is continue;

Semanteme: finish this loop and not execute the other statement behind continue statement in the loop body any more, turn to judge and execute the next loop condition. Pay attention: this statement only ends the loop on this layer and will not exit the loop.

5.2.8 Section summary

1. From the execution process, the program is basically classified into three basic structures: sequence structure, branch structure and loop structure.
2. The most basic unit in program execution is statement. There are five kinds of statements in C language:
 - (1) Expression statement any expression and semicolon forms the expression statement. The general expression statement is assignment statement.
 - (2) Function call statement the function call and semicolon constitutes the function call statement.
 - (3) Control statement it is used for control program process, and composed of special statement delimiter and required expression. It mainly includes conditional judgment execution statement, loop execution statement, go to statement etc.
 - (4) Compound statement it is composed by several statements included in {}. Compound statement is regarded as single statement. It can be used in any place allowing statement such as loop body.
 - (5) Void statement it is composed by semicolon only without actual function.
3. Relational expression and logical expression are two important expressions, which are mainly used for judgment of conditional execution and loop execution.
4. C language provides many forms of conditional statement to form the branch structure.
 - (1) if statement is mainly for one-way selection.
 - (2) if-else statement is mainly for two-way selection.
 - (3) if-else-if statement and switch statement are for multiway selection.These forms of conditional statement are normally mutual substituted.
5. C language provides three loop statements.
 - (1) For statement is mainly used to assign initial value for loop variable, step increment and loop structure of loop times.
 - (2) The loop times and control condition can be confirmed during loop process, and the confirmed loop may use while or do-while statement.
 - (3) Three loop statements can be nested mutually to form the nested loop. The loops may be in parallel but not crossed.
 - (4) Branch statement can transfer the process out of loop body, but it can not transfer process from outside to loop body.

(5) Avoid endless loop in the loop program. That is to say, the loop variable must be ensured to be modified during operation. Change the loop condition to be false gradually, thus finish the loop.

6. Statement summary in C language

Name	General Form
Simple statement	Expression statement;
Void statement	;
Conditional statement	if(expression)statement; if(expression)statement 1; else statement 2; if(expression 1)statement 1; else if(expression 2) statement 2...else statement n;
switch statement	switch(expression){ case constant statement: statement...default: statement; }
loop statement	while statement while(expression)statement; for statement for(expression 1; expression 2; expression 3) statement; break statement break; continue statement continue; return statement return(expression);

5.3. Macro function introduction

5.3.1. How to use macro function for programming

This section will introduce the basic functions of macro and describe the relevant control functions and application method briefly.

There are ways to access macro:

Method 1: select "Setting (S) -> Macro" from the menu as shown in Figure 5-1 (macro menu), and pop up interface as shown in Figure 5-1(macro editor).



Figure 5-1 (Macro Menu)

Method 2: click shortcut button “Macro” as shown in Figure 5-2 (Macro button), and pop up interface as shown in Figure 5-3 (Macro Editor).



Figure 5-2 (Macro Button)

5.3.2. Function button introduction in macro editor

The functional controls are arranged in macro editor window as shown in Figure 5-3 (Macro Editor).



Figure 5-3 (Macro Editor)

<1> Button function description:

1. **New add:** new create a macro.
2. **Delete:** delete the selected macro.
3. **Edit:** edit the selected macro (same with double click macro)
4. **Copy:** select one macro and click “copy” to copy the selected macro.
5. **Paste:** paste the copied contents, and the suffix of macro name adds one automatically.
6. **Description:** pop up the macro description.
7. **Close:** close or exit the current dialog box.

- ◀> **“Compile success” window:** for recording all macro names with successful compilation in project as shown in (5-3). Select one and double click to enter into macro edition.
- ◀> **“Unfinished compile” window:** for recording all unfinished compile macro name in project as shown in (5-3). Select one and double click to enter into macro edition.

5.3.3. How to new create macro

Click “new add” button and pop up the dialog box of macro compiler as shown in Figure 5-4 (Macro Compiler)

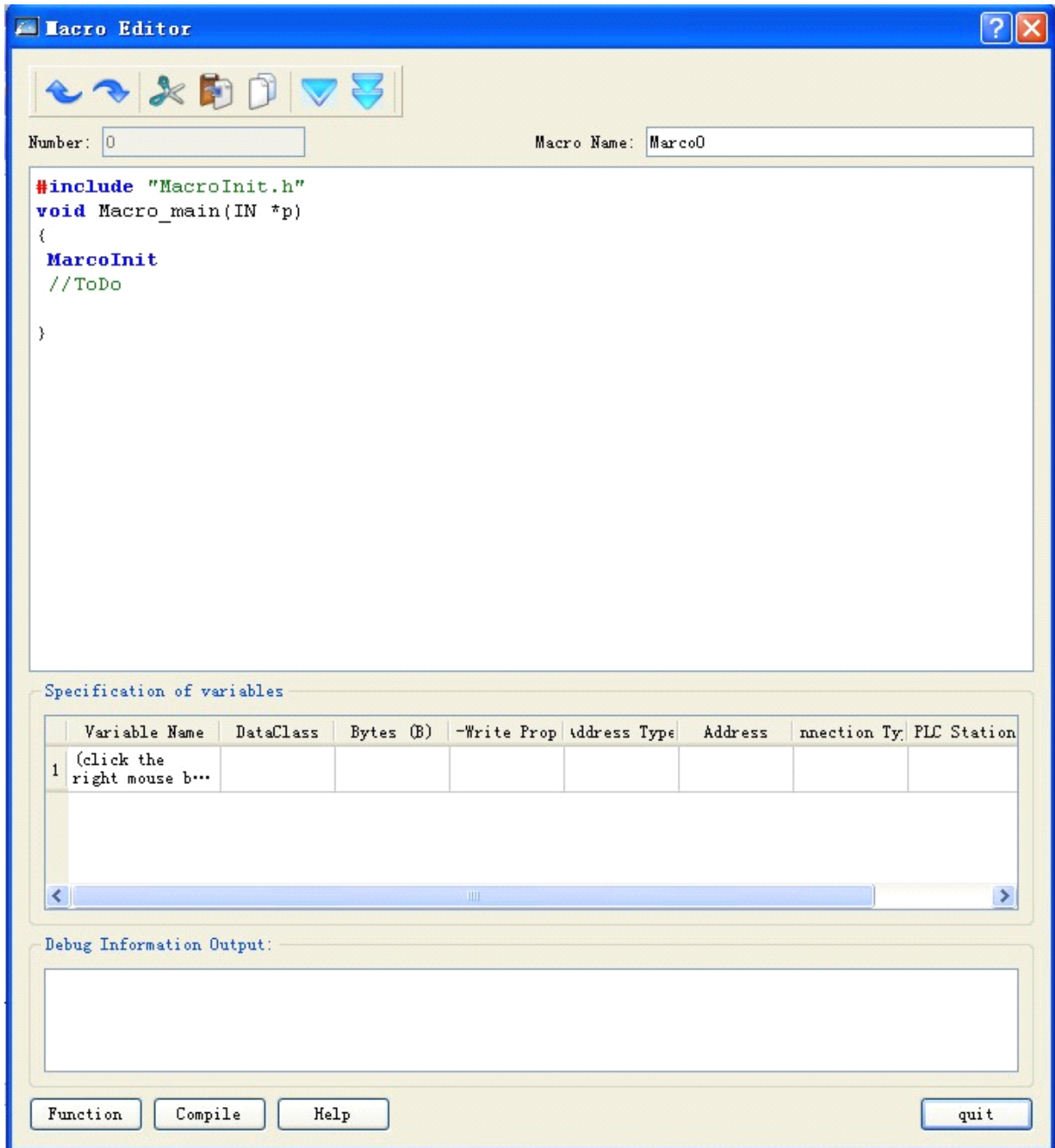

Figure 5-4 (Macro Compiler)

Button Function Description

Compile: Compile the current macro source code, and check the syntax error.

Function: Insert the selected library function at the cursor location in the edition window of source code.

Close: Close the current dialog box.

Description: pop up the help instruction of macro usage.

Instructions:

Instruction 1: convention introduction of program compilation

Create the source program of C language conforming to ANSI C standard in the edition window.

Instruction 2: information output window

The window outputs the information of compilation and connection state of program. Users may make debugging and modification according to the information prompt.

Instruction 3: close/open window

In the variable setting, users can right click the edition window of source code, and it will pop up the shortcut as Figure 5-5 (window close/open). Click “close/display variable setting window” and “close/display information output window” to close/open the corresponding window. Users can adjust the edition box size as required.

Instruction 4: variable setting

Variable name: input the variable name required in the program.

Data class: select the corresponding data class of variable name so as to distribute the corresponding memory size.

Word length: set the occupied memory of corresponding variable automatically depending on the data class.

Read/write: set the read-write property of variable in the memory cell of touch screen.

Address: the defined physical memory address of variable in the touch screen.

<u>U</u> ndo	Ctrl+Z
<u>R</u> edo	Ctrl+Y
<hr/>	
<u>C</u> ut	Ctrl+X
<u>C</u> opy	Ctrl+C
<u>P</u> aste	Ctrl+V
De <u>l</u> ete	
<hr/>	
S elect All	Ctrl+A

Figure 5-5 Shortcut menu



: Variable setting instruction: when the external requires interaction with touch screen such as data exchange and data acquisition, it provides the interface to change the behavior characteristics of touch screen dynamically.



: Special tips: the variables required in the program should be put in the variable definition part (the variable definition starts from code).

5.3.4. How to insert library function in the program

Click "function" button and pop up the dialog box as Figure 5-6. Select the corresponding library function in the function name list box, click "confirm" button and the function will be inserted to the cursor location of edition window automatically.

The functions, parameter types and other detailed instruction of library function refer to Appendix 1.

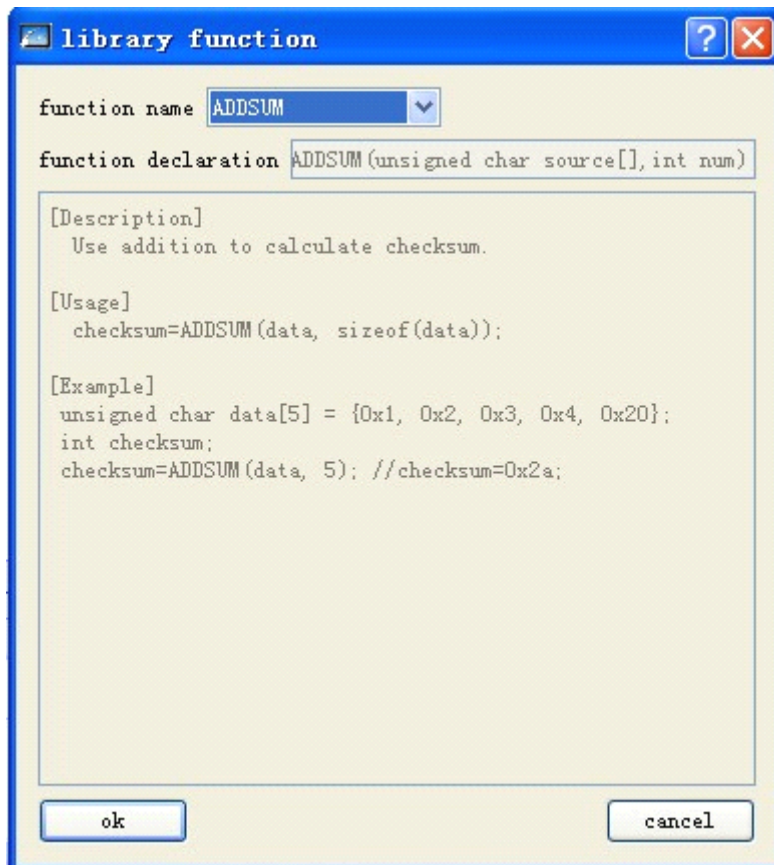

Figure 5-6 (Function Selection)

5.3.5 How to use internal storage area in macro

SKWorkshop configuration software provides the operation interface for HMI internal storage area. Users can make direct operations for the internal storage area in the macro. Detailed methods have two kinds:

1. Access storage area with keywords

LocalBit: reference of internal storage area LB;

LocalWord: reference of internal storage area LW;

RWIWord: reference of internal storage area RWI .

The keyword can be used directly in macro. For example:

```
if(LocalBit[5])
{
LocalWord[1]=0;
}else
{
LocalWord[1]=1;
}
```

2. Establish a linkage between variable and internal storage area by setting of variable. Detailed usage refers to macro instance.

5.4. QuickStart: A simple macroblock

5.4.1. Source code design of macro

Let us come to compile a simple macroblock. New create a project and select the corresponding touch screen model. This macroblock will realize simple operations as following: make initialization for “numeral entry display” control with array element value of char source[4] = { 2, 3, 4, 5} by Init macro, then read the external input data by “numeral entry display” control, then trigger ADDSUM macro by pressing “=” button, and display the execution result through “numeral entry display” control. Detailed operations are shown as following:

Step 1 <Create a macro>

Click the circled icon “macro” shortcut button and pop up the dialog box as shown in Figure 5-7 (Macro Editor).

Step 2: <Create macro Init>

Click “new add” button in the window of macro editor, and pop up the dialog box as Figure 5-8 (Macro Editor). Input tag name (Init) in the edition box “tag name” and the source program code as shown in Figure 5-9 (code edition of macro compiler).

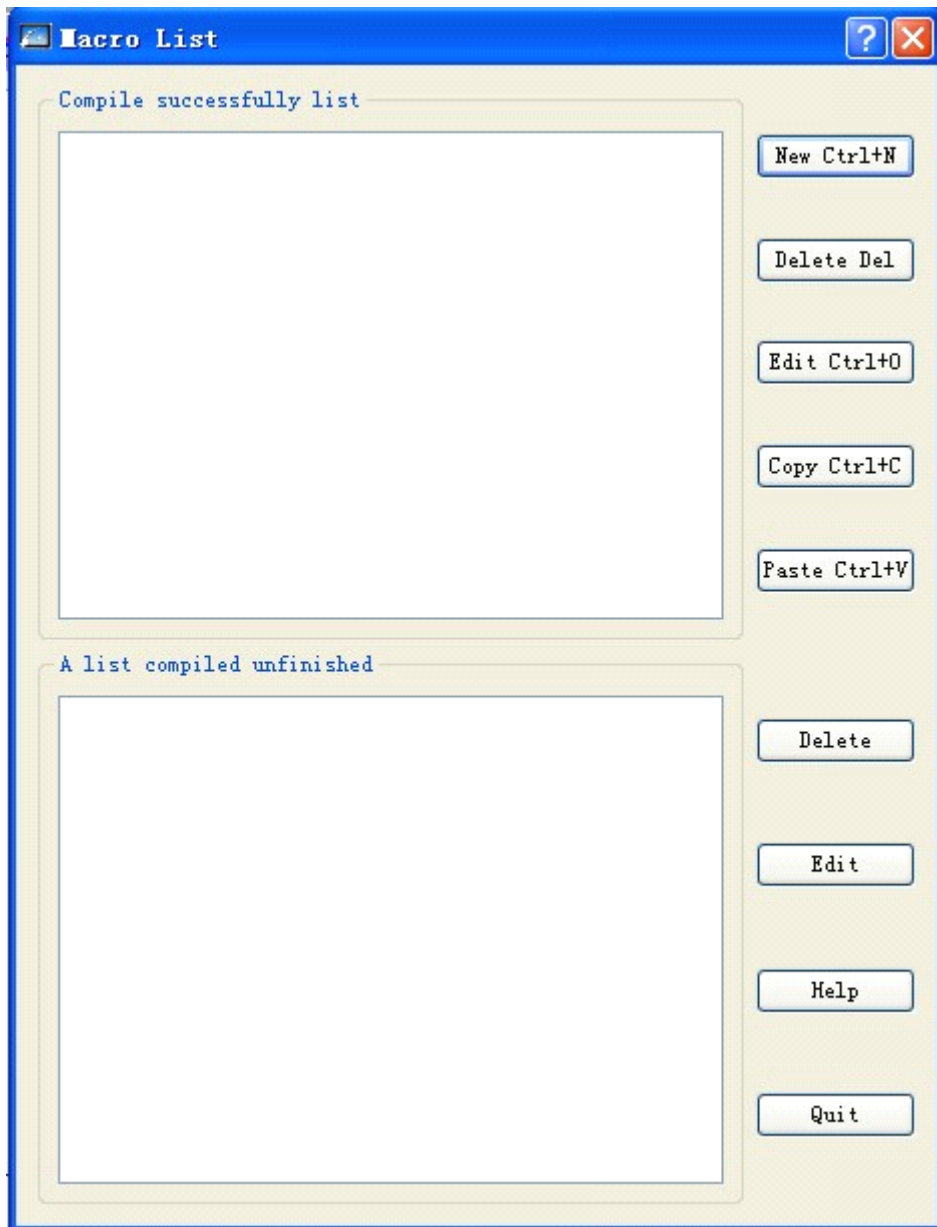

Figure 5-7 (Macro Editor)

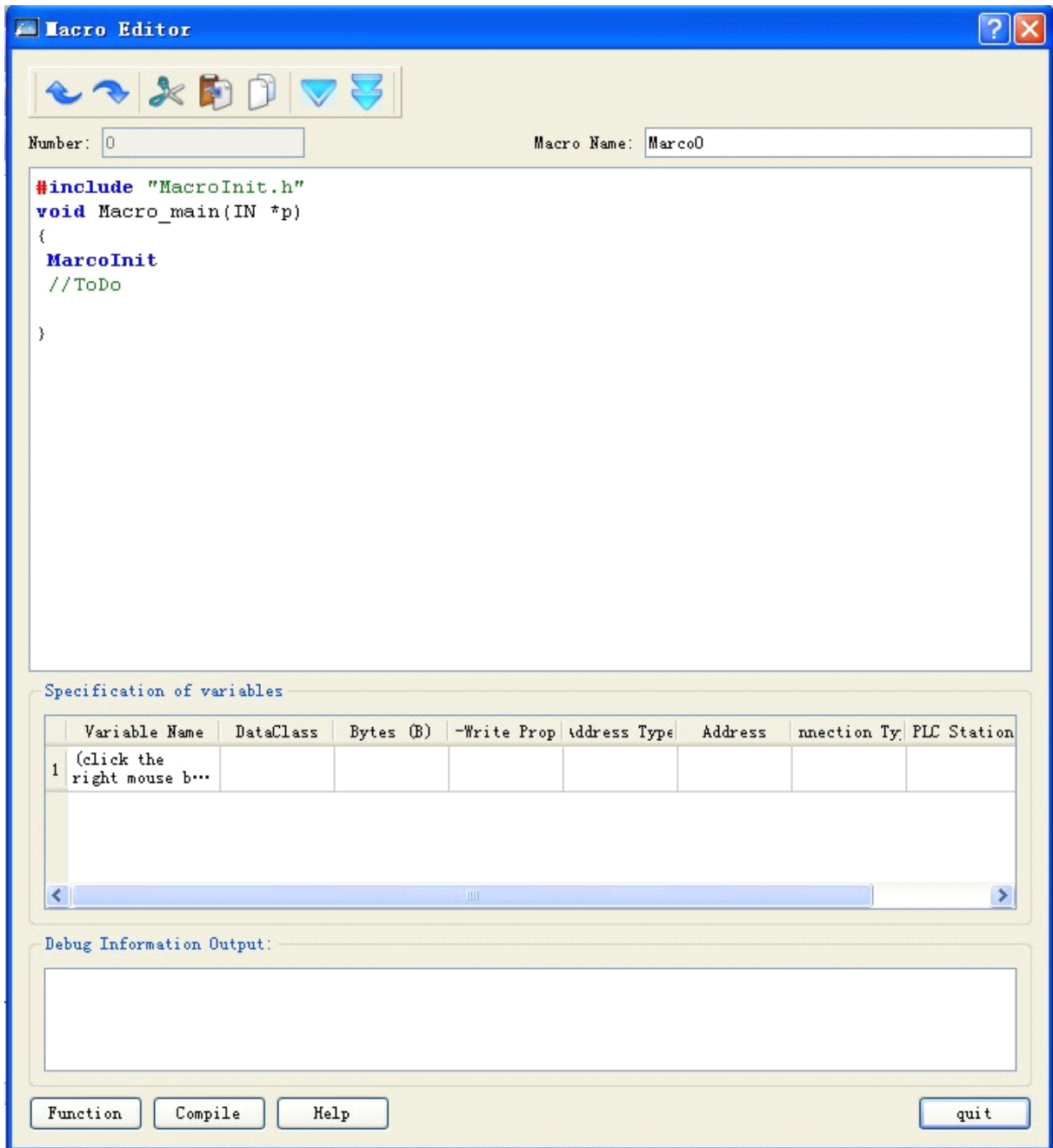

Figure 5-8 (Macro Compiler)



: Macro name is composed with Arabic numerals (0-9), English characters (a-z, A-Z) and underscore (_). As shown in Figure 5-9 (Macro Compiler), input the contents in the following circle.

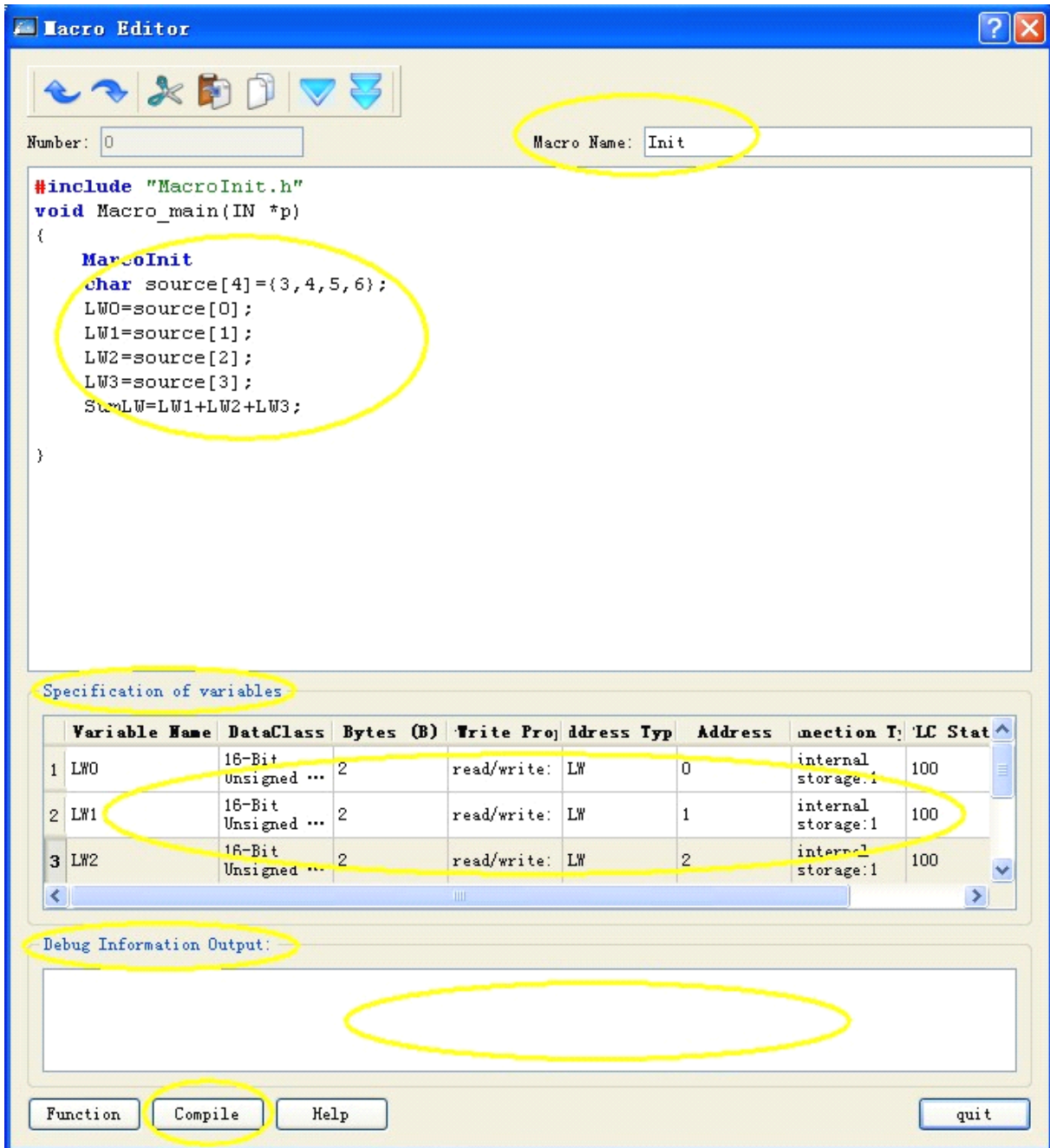

Figure 5-9 (Code Compile in Macro Compiler)

Step 3: <Tag Setting>

As shown in Figure 5-8 (variable setting), it records the tag name, tag type and other property settings. Double click the “tag name” window or right click the shortcut menu to select “new tag”, and pop up the dialog box as shown in Figure 5-10 (Macro Code Tag)

Make settings for the tag property in Figure 5-10 (Macro Code Tag). Then click “OK” to save the settings.

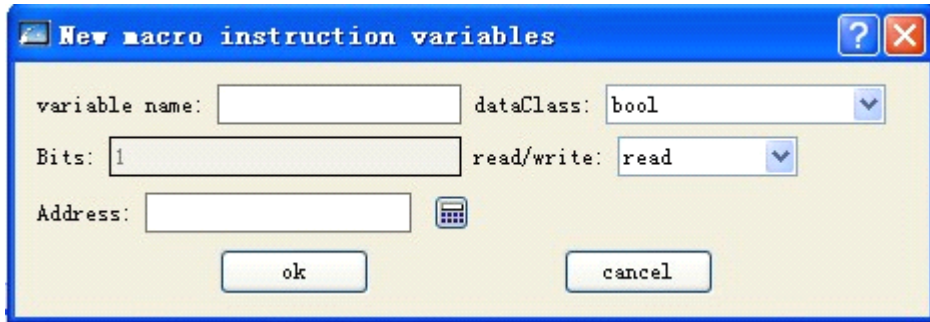

Figure 5-10 (Macro Code Tag)

Tag Name : input LW0,LW1,LW2,LW3,SumLW respectively in the tag name;

Data Type : set 16-bit integer

Read-write : select readable and writable (read-write) ;

Address : LW0=0,LW1=1,LW2=2,LW3=3,SumLW=4;

After setting completes, it is shown as following (Figure 5-11).

	Variable Name	DataClass	Bytes (B)	Write Pro	address Typ	Address	location	LC Stat
1	LW0	16-Bit Unsigned ...	2	read/write:	LW	0	internal storage:1	100
2	LW1	16-Bit Unsigned ...	2	read/write:	LW	1	internal storage:1	100
3	LW2	16-Bit Unsigned ...	2	read/write:	LW	2	internal storage:1	100

Figure 5-11 (Variable Setting)

Step 4: <Compile source file>

After the above steps, the next is compilation. Click compile button as following (Figure 5-12), and complete save, compile, connection and error check functions automatically.

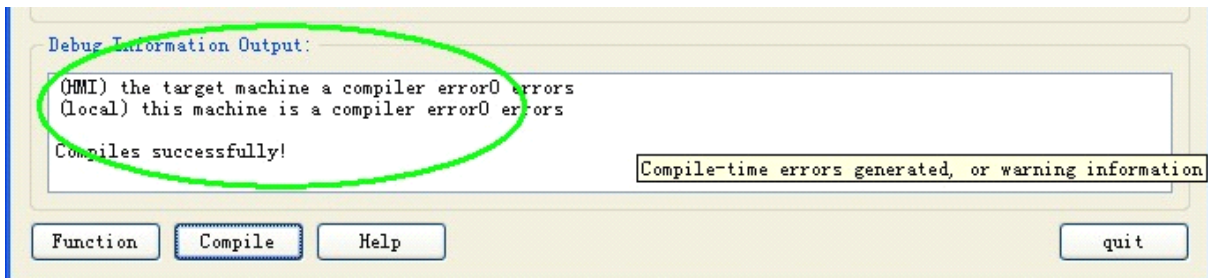

Figure 5-12 (Information Output Window)

When the information output window outputs “0 errors! Compile success!”, it indicates the macro has established successfully. In addition, it will be added into the successful compiled list box automatically. Otherwise, it will prompt the

error and add into failed compiled list box. Then users may make modification, edition even compilation for the compiled program.

Step 5: <Create macro ADDSUM>

Create macro ADDSUM as specified from step 2-step 4 as shown in Figure 5-13 (create macro ADDSUM).

- <1>: input “ADDSUM” in the macro name.
- <2>: input the circled contents in the code compilation window.
- <3>: set the corresponding tag property in the tag setting window.
- <4>: click compile button.

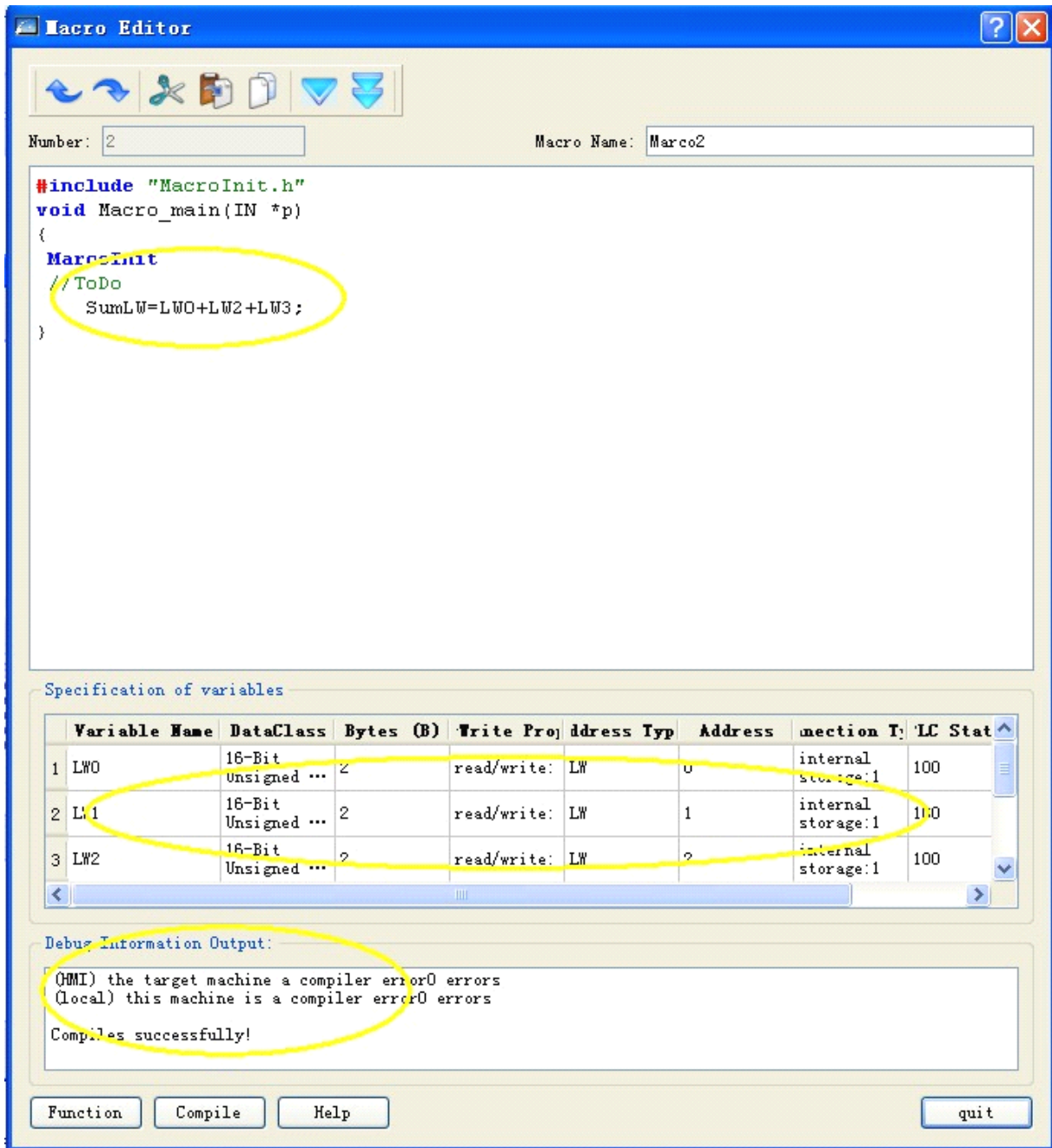

Figure 5-13 (Create Macro ADDSUM)

Step 6: <compile control>

<1>. Put the corresponding control in the project menu and adjust the size as Figure 5-14.

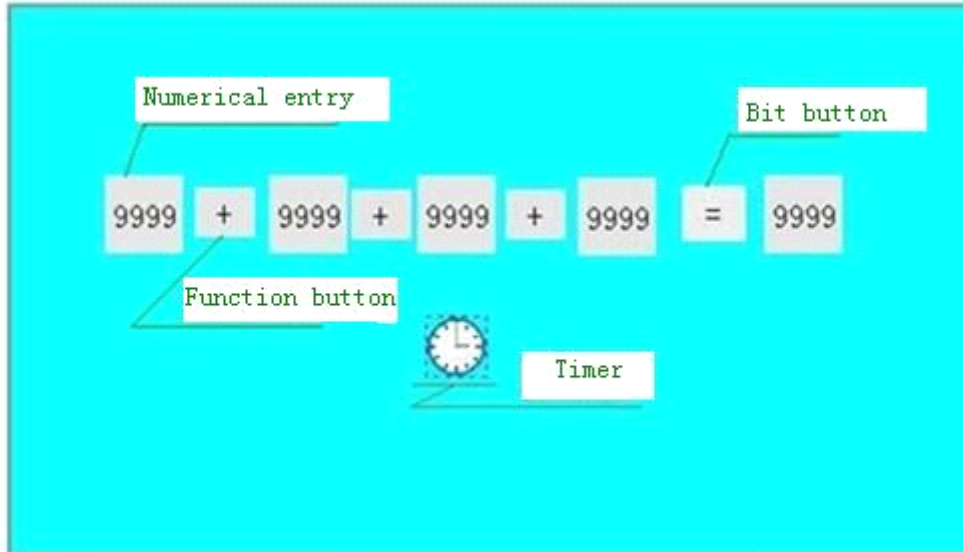

Figure 5-14 (Control Layout)

<2>. Set the corresponding control property

Right click the control of “numeral entry display” and set the write-in address of control property as shown in Figure 5-15.

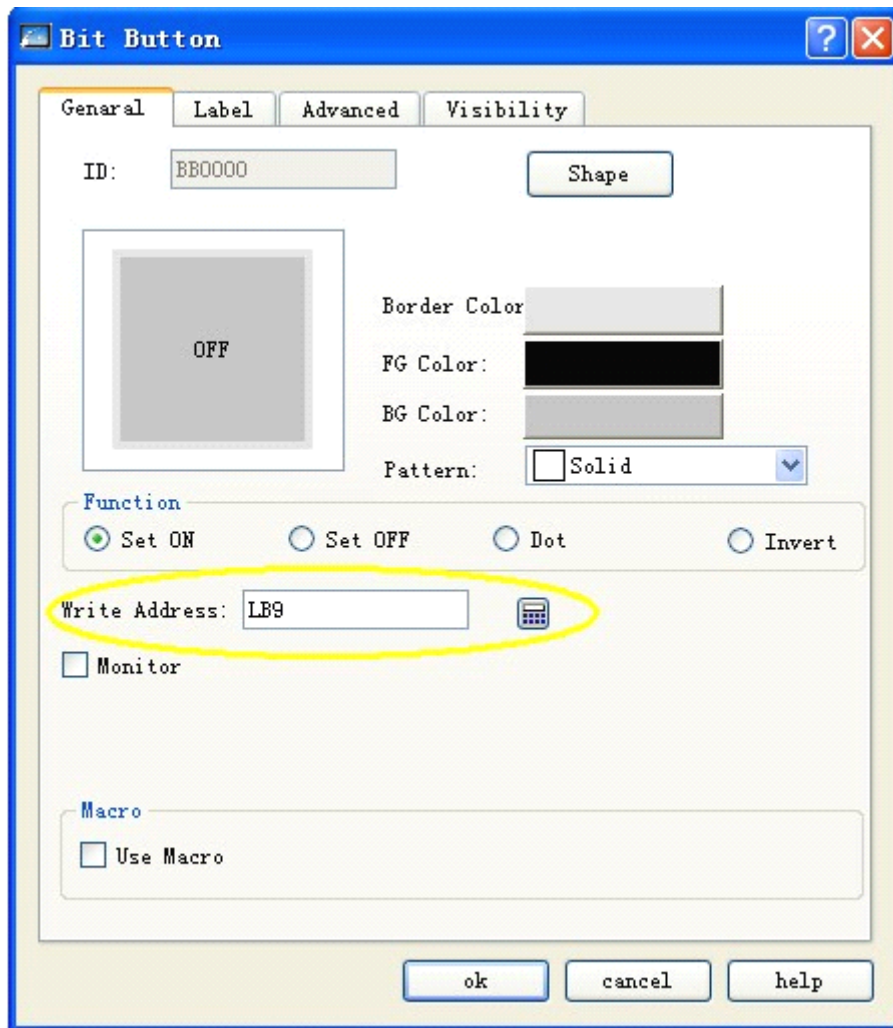

Figure 5-15 (Numeral entry Display Property Setting)

Keep the consistency of LW0,LW1,LW2,LW3,SumLW variable address and the corresponding control “write address” (Figure 10-15) (bit LW0,LW1,LW2,LW3,LW4 respectively). Click “OK” button to save the setting.

<3>.Set bit button control property as figure

Select “bit button” control, right click it, and pop up the dialog box as Figure 5-16 (Bit Button). Make settings as the circled prompt. Click “OK” to save the settings.

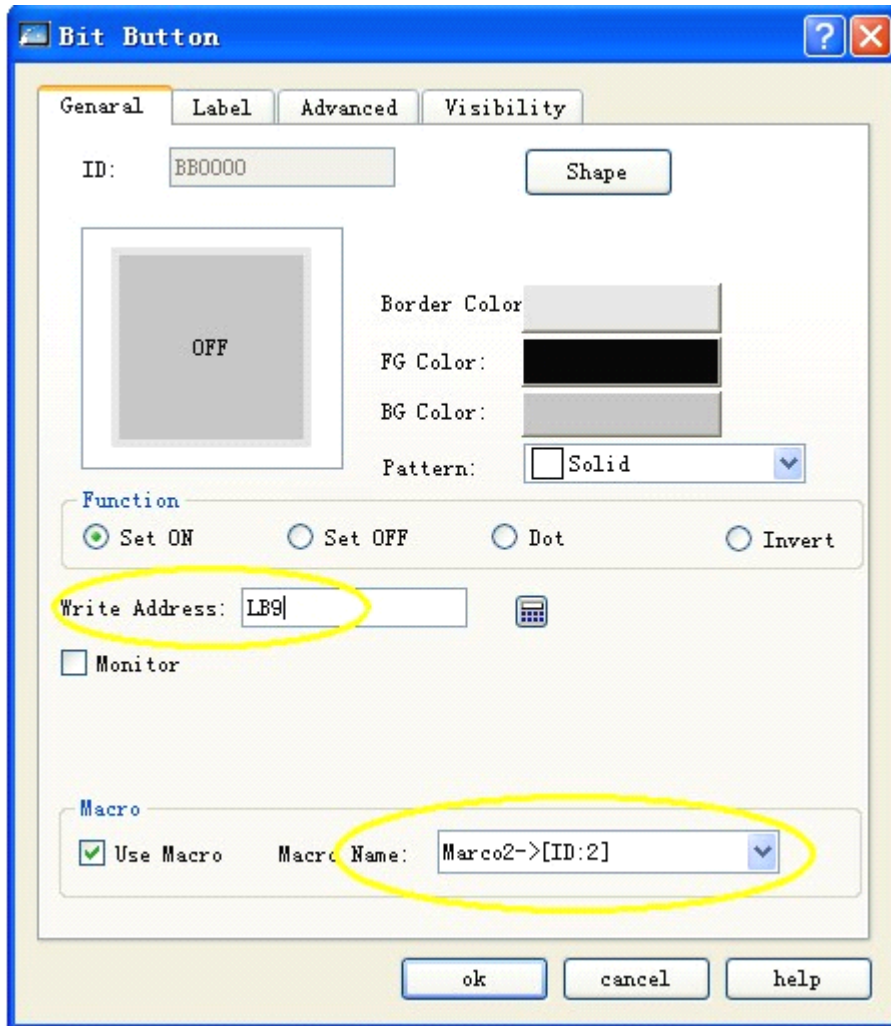

Figure 5-16 (Bit Button)

<4>.Timer property setting

Select the timer and right click it, and pop up the dialog box of timer property as Figure 5-17. Select the macro name Init and click “OK” to save the settings.

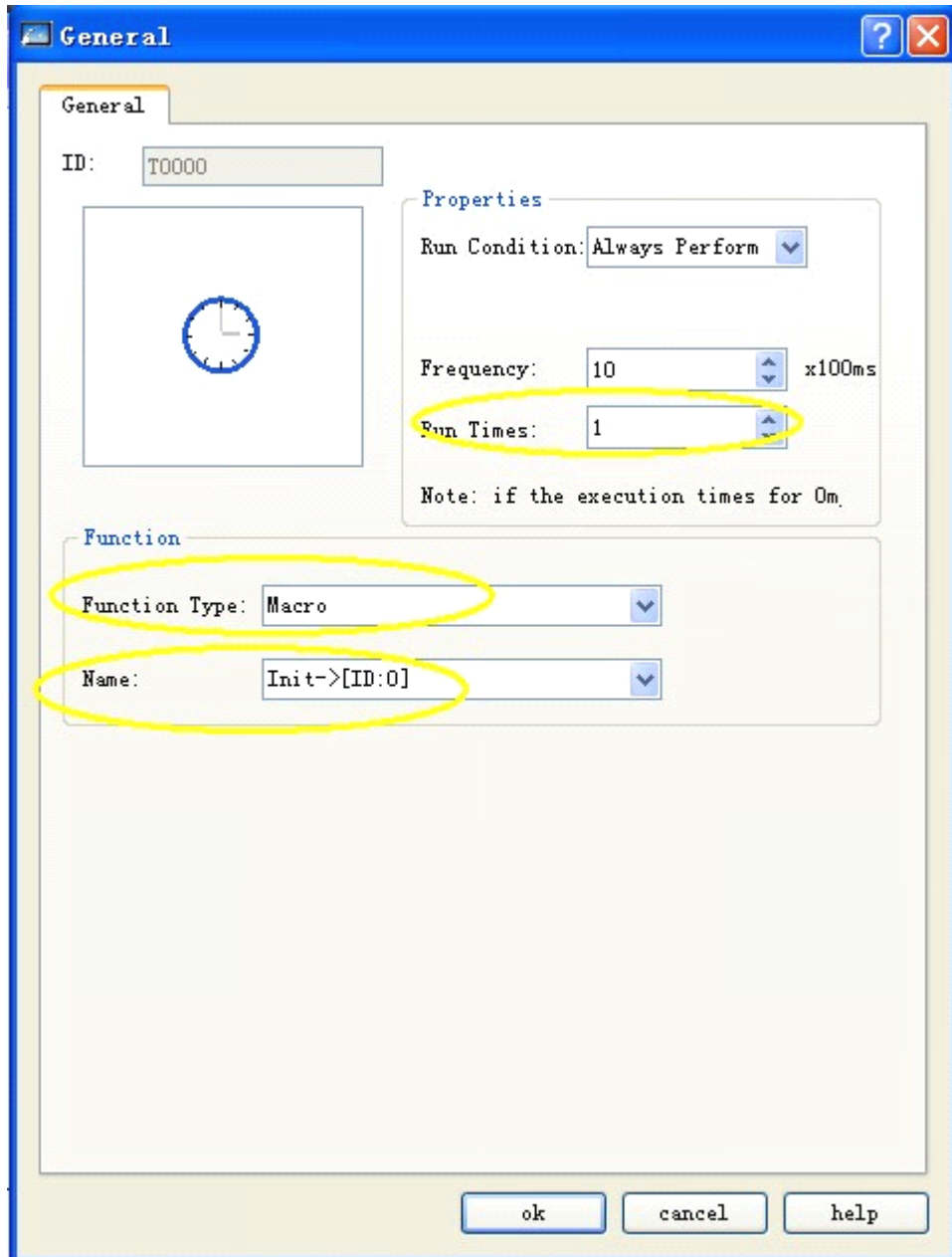

Figure 5-17 (Timer Property Setting)

↔. Select “label” →”text” in the function button, and input “+” character in the text box as Figure 5-18.

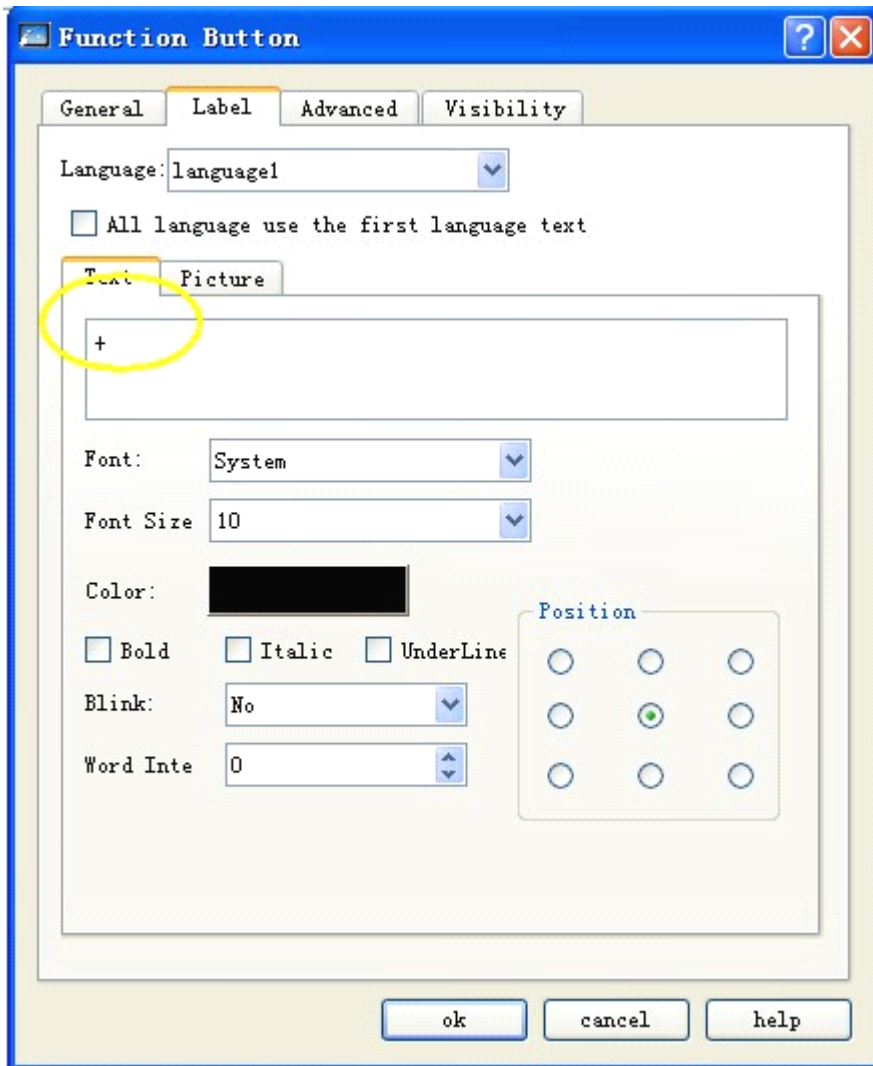

Figure 5-18 (Function Button Property Setting)

Step 7: <Compile general project and download to touch screen>

Complete the above setting and save the project for next compilation. Then download the project to touch screen through USB.

<1> : Click “√” in the red circle as Figure 5-19, and execute the project compilation;



Figure 5-19 (General Project Compile)

<2> : Select “download (D) ->USB (D)” from menu, and select “download” in the dialog box. Complete download and restart the touch screen, **or click the function button of “compile download” shortcut in black circle to complete operation by one step.**

Step 8: <Result Test>

After the touch screen is restarted, it will display as following Figure 5-20. This is because the macro Init is executed at startup. This directive is the result that the timer triggers to execute macro Init.

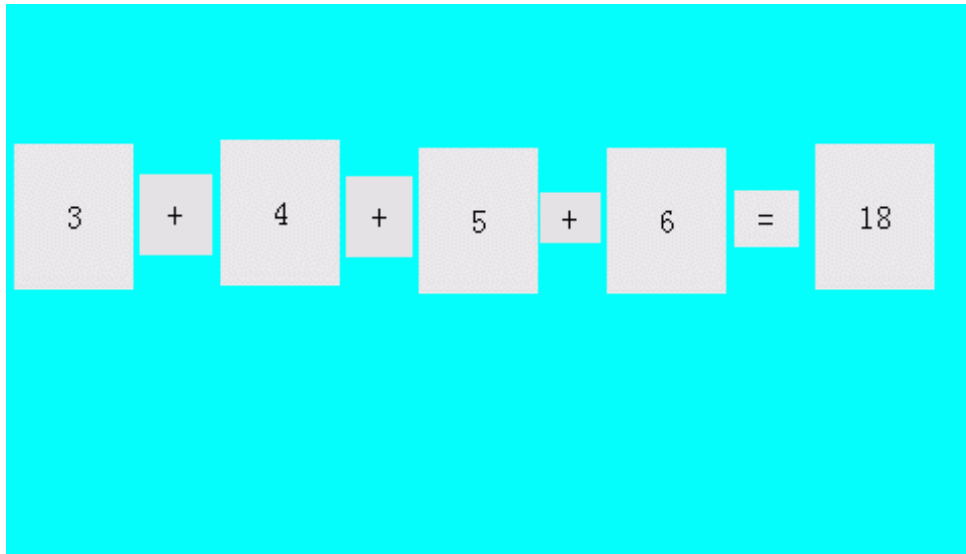

Figure 5-20 (Display Initial Numerals)

Enter data as “31, 42, 53, 64” into the “numeral entry display respectively; click “=” to execute ADDSUM. Then it will output the execution result 190. The final effect is shown as Figure 5-21.

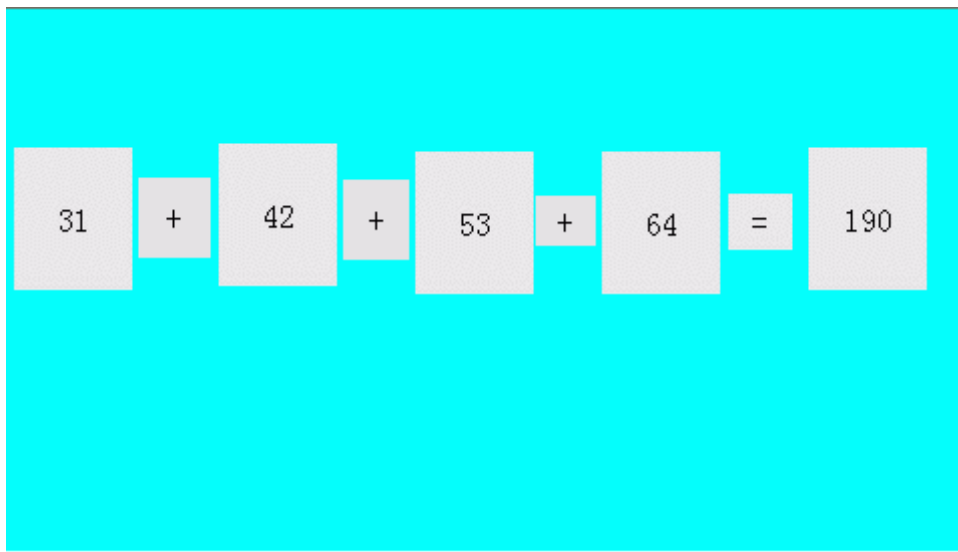

Figure 5-21 (Result Display)

To the end of this section, all required functions as macro edition, compilation, download and test have been completed smoothly, and a simple macroblock runs in normal condition.

5.5. Appendix 1

1. ADDSUM

[Description]

Use addition to calculate checksum.

[Usage]

```
Checksum=ADDSUM (data, sizeof (data));
```

[Example]

```
char data[5] = {0x1, 0x2, 0x3, 0x4, 0x20};  
  
int checksum;  
  
checksum=ADDSUM(data, 5); // checksum=0x2a;
```

2. ASCII2DEC

[Description]

Convert a string to a decimal value.

[Usage]

```
result=ASCII2DEC(source, sizeof (source));
```

[Example]

```
char source [4] = {'2', '3', '4', '5'};  
  
short result;  
  
result=ASCII2DEC(source , 4); // result=2345
```

3. ASCII2FLOAT

[Description]

Convert a string to a floating value.

[Usage]

```
result=ASCII2FLOAT(source, sizeof (source));
```

[Example]

```
char source[4] = {'5', '.', '7', '8'};  
  
float result;  
  
result=ASCII2FLOAT(source,4); // result = 5.78
```

4. ASCII2HEX

[Description]

Convert a string to a hexadecimal value.

[Usage]

```
result=ASCII2HEX(source, sizeof(source));
```

[Example]

```
char source[5] = {'1','6','3','4'};
short result;
result=ASCII2HEX(source,4);// result = 0x1634
```

5. BCD2BIN**[Description]**

Convert a BCD value to a BIN value.

[Usage]

```
result=BCD2BIN(source);
```

[Example]

```
short source = 0x2648;
short result;
result=BCD2BIN(source);// result = 1234
```

6. BIN2BCD**[Description]**

Convert a binary value to a BCD value.

[Usage]

```
result=BIN2BCD(source);
```

[Example]

```
short source = 1234;
short result;
result=BIN2BCD(source);// result = 0x1234
```

7. CRC**[Description]**

Get 16-bit CRC.

[Usage]

```
bit_CRC=CRC(source, sizeof(source));
```

[Example]

```
char source[5] = {0x1, 0x2, 0x3, 0x4, 0x5};
short bit_CRC;
```

```
bit_CRC=CRC(source,5);
```

8. DEC2ASCII

[Description]

Convert a decimal value to a string.

[Usage]

```
result= DEC2ASCII(source, sizeof(source));
```

[Example]

```
short source = 5678;

char *result;

result= DEC2ASCII(source,4);

// result[0] == '5', result[1] == '6', result[2] == '7', result[3] == '8'
```

9. FLOAT2ASCII

[Description]

Convert a floating value to a string.

[Usage]

```
result=FLOAT2ASCII(source);
```

[Example]

```
float source = 56.8;

char result[4];

result=FLOAT2ASCII(source);

//result[0] = '5',result[1] = '6',result[2] = '.',result[3] = '8'
```

10. GETBIT

[Description]

Get bit value.

[Usage]

```
result = GETBIT(source, bit_pos );
```

[Example]

```
short source = 0x5, bit_pos = 0 ,result;

result = GETBIT(source,bit_pos);// result == 1
```

11. GETCHARS

//This function is applied for free port communication only.

[Description]

Get data from communication port.

PortID--Serial Port ID,COM1=0, COM2=1

Success return the count of chars, fail return -1

[Usage]

```
GETCHARS(PortID, Data);
```

[Example]

```
char Data[20];  
  
int Length,checksum,PortID,Result;  
  
Length=5;  
  
PortID=0;  
  
Result=GETCHARS(PortID,Data);
```

12. HEX2ASCII

[Description]

Convert a hexadecimal value to a string.

[Usage]

```
HEX2ASCII(source, result[start]);
```

[Example]

```
short source = 0x5678;  
  
char *result;  
  
result = HEX2ASCII(source);  
  
//result[0] = '5', result[1] = '6', result[2] = '7', result[3] = '8'
```

13. HIBYTE

[Description]

Retrieve the high byte from the low word of a specified value.

[Usage]

```
result=HIBYTE(source);
```

[Example]

```
short source = 0x1234,result;  
  
result=HIBYTE(source);// result = 0x12
```

14. HIWORD

[Description]

Retrieve the high word from the specified value.

[Usage]

```
result=HIWORD(source);
```

[Example]

```
int source = 0x45232568,result;  
result=HIWORD(source);// result = 0x1234
```

15. INVBIT

[Description]

Set specific bit to be inverted (ON->OFF, OFF->ON).

[Usage]

```
result = INVBIT(source, bit_pos )
```

[Example]

```
short source = 0x6, bit_pos =1 ,result;  
result=INVBIT(source, bit_pos);// result = 4
```

16. LOBYTE

[Description]

Retrieve the low byte from the specified value.

[Usage]

```
result=LOBYTE(source);
```

[Example]

```
short source = 0x1234,result;  
result= LOBYTE(source);// result = 0x34
```

17. LOWORD

[Description]

Retrieve the low word from the specified value.

[Usage]

```
result=LOWORD(source);
```

[Example]

```
int source = 0x12345678,result;  
result=LOWORD(source);// result == 0x5678
```

18. PUTCHARS //This function is applied for free port communication only.**[Description]**

Send data to communication port.

PortID--Serial Port ID,COM1=0, COM2=1

[Usage]

```
PUTCHARS(PortID, Data, Length);
```

[Example]

```
char Data[5] = {0x02, 0x30, 0x31, 0x4d, 0x5e};  
int Length,checksum,PortID;  
Length=5;  
PortID=0;  
PUTCHARS(PortID,Data, Length);
```

19. SWAPB**[Description]**

Swap the low byte and high byte of the specified value.

[Usage]

```
result=SWAPB(source);
```

[Example]

```
short source = 0x1234,result;  
result=SWAPB(source);// result = 0x3412
```

20. SWAPW**[Description]**

Swap the low word and high word of the specified value.

[Usage]

```
result=SWAPW(source);
```

[Example]

```
int source = 0x12345678, ;
```

```
int result;

result=SWAPW(source);// result = 0x56781234
```

21. SETBIT

[Description]

Set specific bit to be ON or OFF.

[Usage]

```
result = SETBIT(source,bit_pos,1);
```

[Example]

```
short source = 0x4;

short bit_pos = 2, result;

result = SETBIT(source,bit_pos,1);// result = 1
```

22. XORSUM

[Description]

Use XOR to calculate checksum.

[Usage]

```
checksum = XORSUM(source, sizeof(source));
```

[Example]

```
char source[5] = {0x1, 0x20, 0x3, 0x48, 0x5};

short checksum;

checksum = XORSUM(source, 5); // checksum =0x6f
```

23. DELAY

[Description]

Set a delayed time ;

[Usage]

```
void DELAY(int dwMilliseconds);
```

[Example]

```
int dwMilliseconds=1000;

DELAY(dwMilliseconds);//delay 1000 milliseconds;
```

24. GETBUFFERLENGTH

//This function is applied for free port communication only.

[Description]

Get buffer length from communication port.

PortID--Serial Port ID,COM1=0, COM2=1,

Success return buffer length, fail return -1.

[Usage]

```
int GETBUFFERLENGTH(PortID);
```

[Example]

```
int bufferlen,PortID;
```

```
PortID=0;
```

```
bufferlen=GETBUFFERLENGTH(PortID).
```

25. CLEARBUFFER**//This function is applied for free port communication only.****[Description]**

Clear buffer of communication port.

PortID-- allows to Serial Port ID,COM1=0, COM2=1

Success return 1, fail return 0

[Usage]

```
int CLEARBUFFER(PortID);
```

[Example]

```
int Clearresult,PortID;
```

```
PortID=0;
```

```
Clearresult=GETBUFFERLENGTH(PortID);
```

6. SKWorkshop off-line simulation

This Chapter mainly gives the introduction of usage and steps for offline simulation.

6.1 Offline simulation of SKWorkshop

Use SKWorkshop self-contained function of off-line simulation to verify the correctness of configuration screen before transmitting screen into HMI and connecting HMI with connection device.

- Operation process:

Save currently edited project and select the off-line simulation command in download menu to pop up the window of off-line simulation. In this window, you can use mouse to click other than touch screen to realize partial functions of touch screen, as shown in figure 6-1.

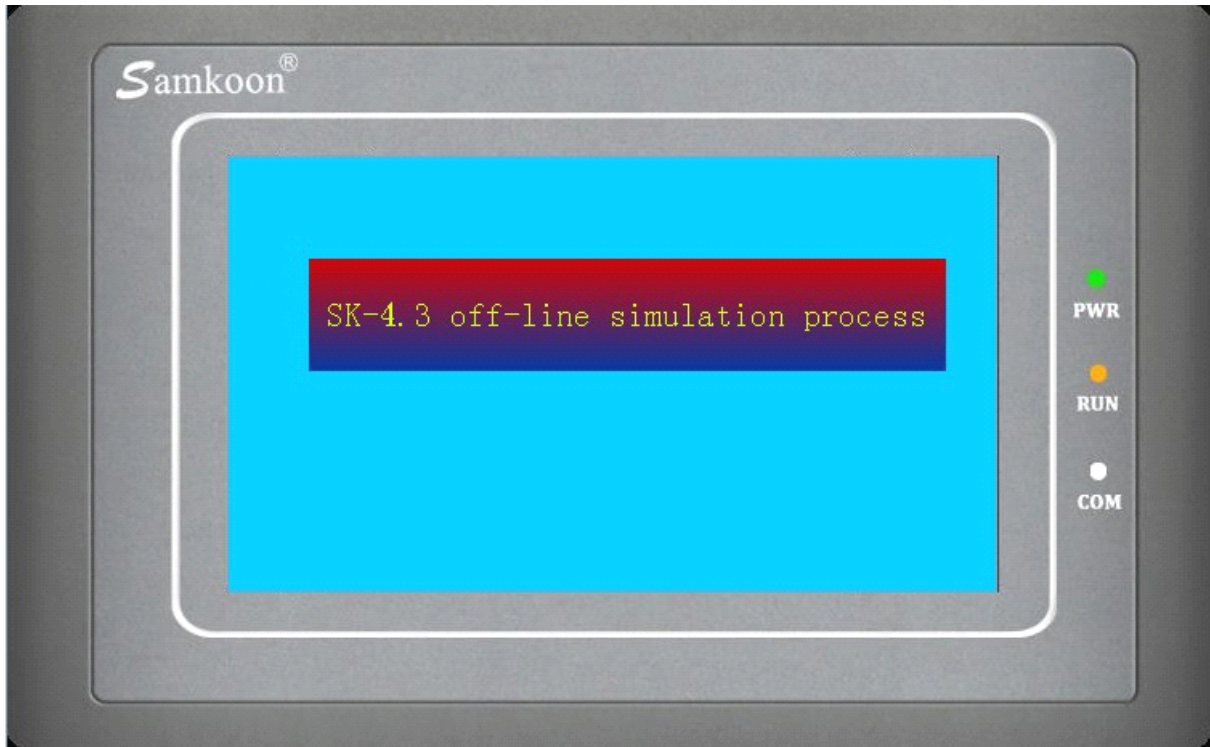
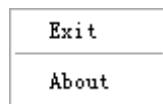

Figure 6-1 Diagram of SK-4.3A off-line simulation

In simulation window, select the right key to pop up following menu:



Exit: close window of off-line simulation; when the current window of WINDOWS displays off-line simulation, you can also press ESC on keyboard to exit off-line simulation

About: about dialog box.



You can close off-line simulation through taskbar "Right Key" – "Close".

- Example of off-line simulation

As shown in figure 6-2 below, you can carry out the off-line simulation of edited configuration. Use mouse to click value display and input. It can be seen that pointer of instrument panel points to 70 if you enter 70. The project designer can better check and find some problems in project configuration screen through off-line simulation, such as the correctness of selected monitoring address and relationship between controls, to ensure good preparations.

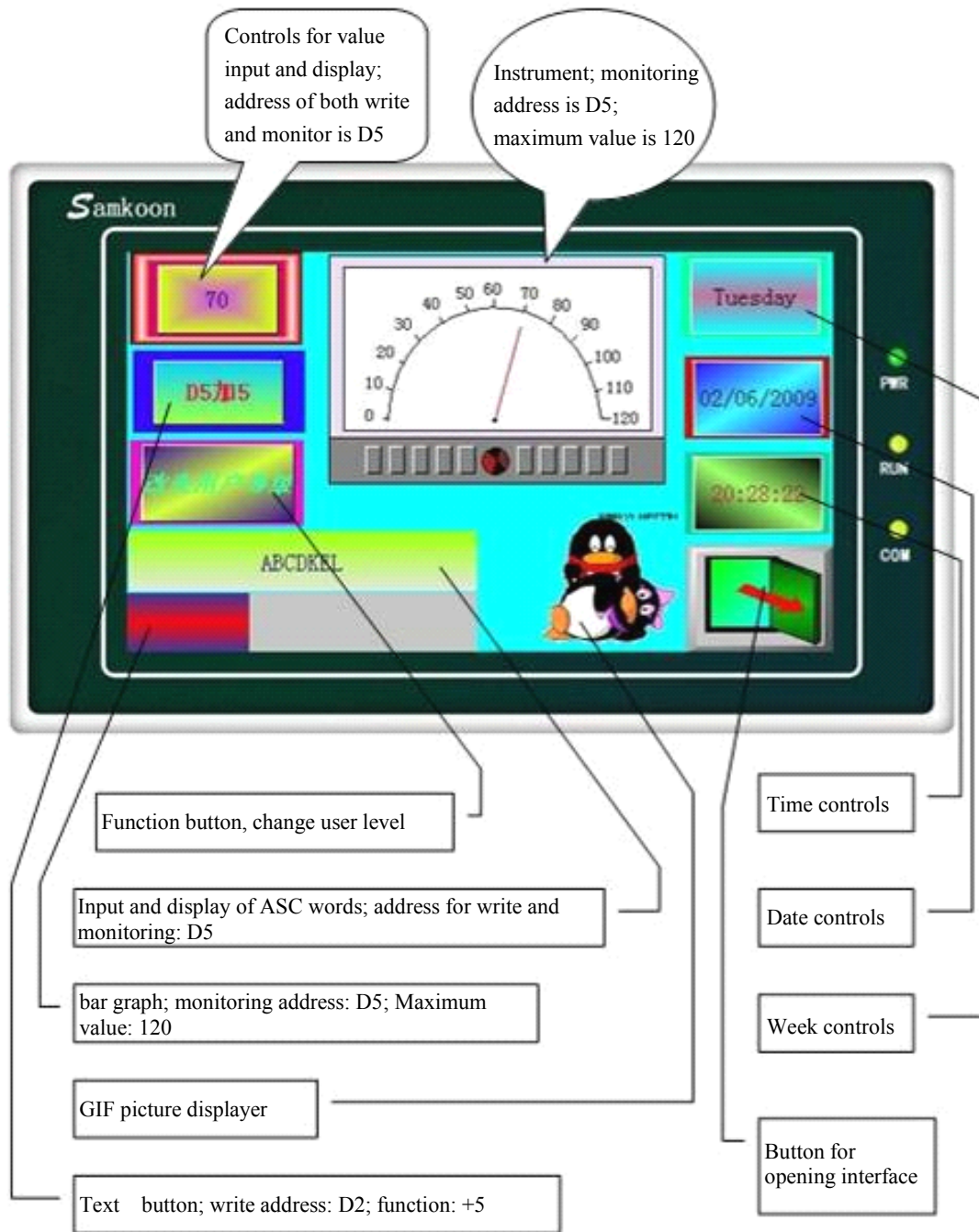



Figure 6-2 Example of SK-4.3A off-line simulation

- The following is the operation step for off-line simulation.
- √ Users without installation of SKWorkshop4.0 install the software firstly.
- √ Double click the shortcut icon SKWorkshop.exe on desktop.
- √ Select the icon  for new item or "File" – "New Project" in menu bar to pop up the dialog box as shown in figure 6-3.

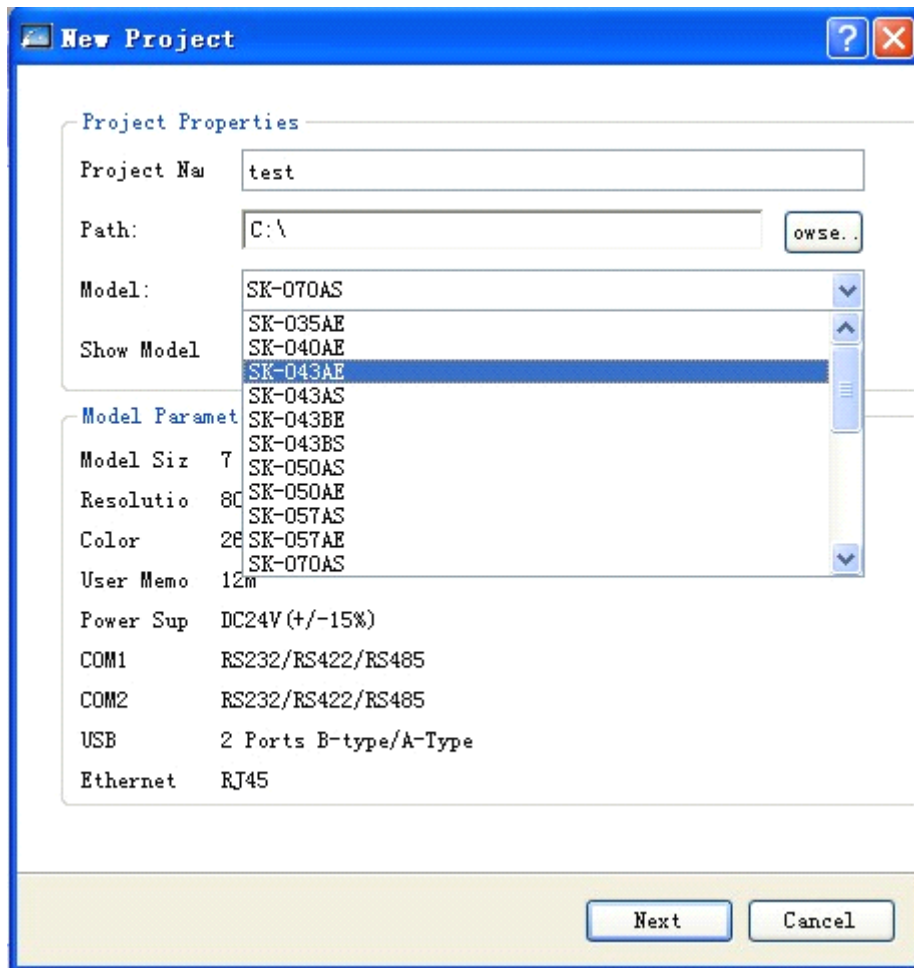

Figure 6-3 Dialing box of new project

- ✓ Enter project name in column “Project Name”; select one saving position for the project in column "Position"; select “SK-043AS in column “Model Selection” (The 4.3-inch HMI is just taken for example. Users can select other models as required); select “Horizontal” in column “Display Mode” (Users can select vertical display as required). After finishing the setting, information just set by users will display in the below module “Model Parameter”. Users can click “Next” after confirmation to pop up the dialog box as shown in figure 6-4.

✓

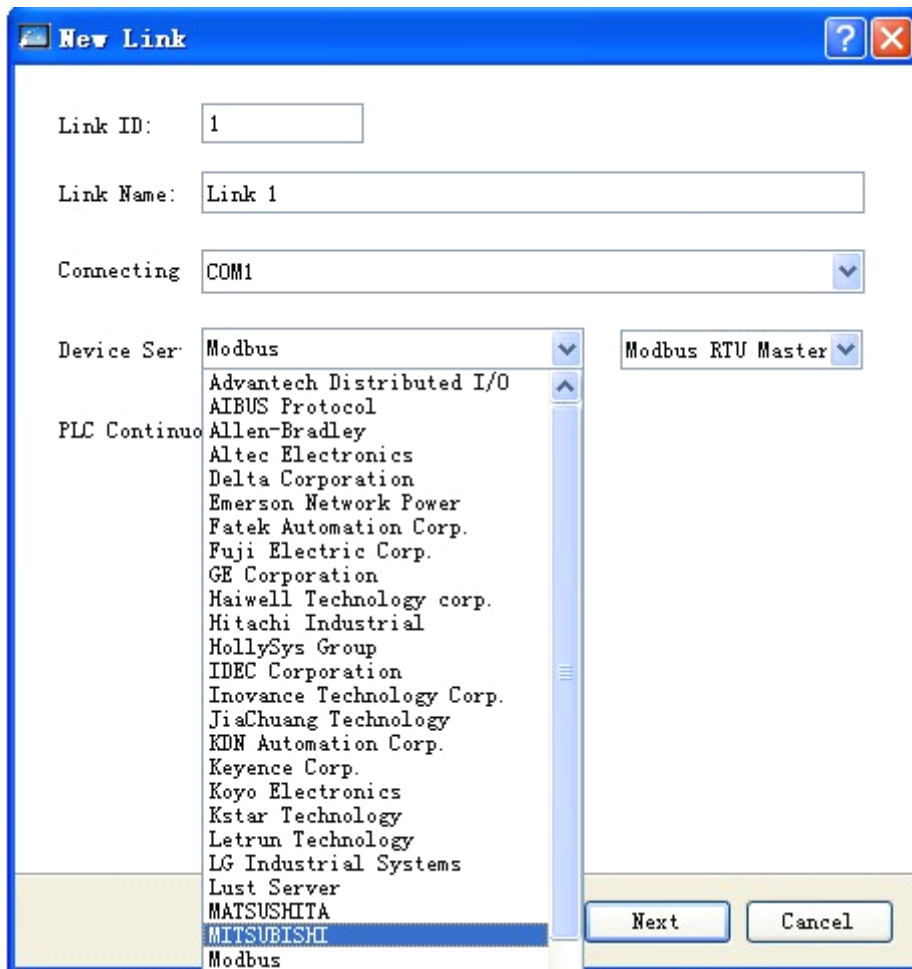

Figure 6-4 Dialog box for communication connection setting of new item

In this example, Mitsubishi PLC is taken as device. Users can select PLC of other models in option “Device Service” as required and select different model of the PLC behind the option. After completion of setting, click “Next” to pop up the dialog box as shown in figure 6-5.

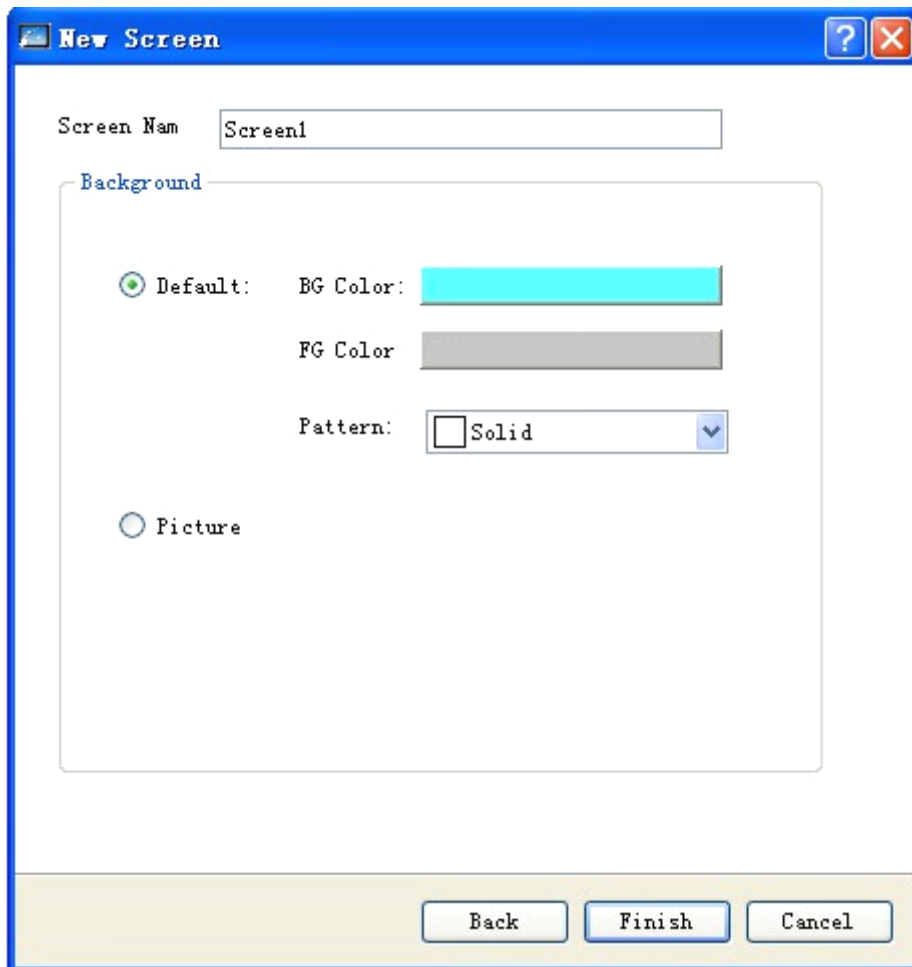

Figure 6-5 Dialog box of adding new screen for new project

In this dialog box, users can change name of screen in column "Screen Name" and background color of screen in column "Background Color". After completion of setting, click "Finish" to finish creation of project, as shown in figure 6-6.

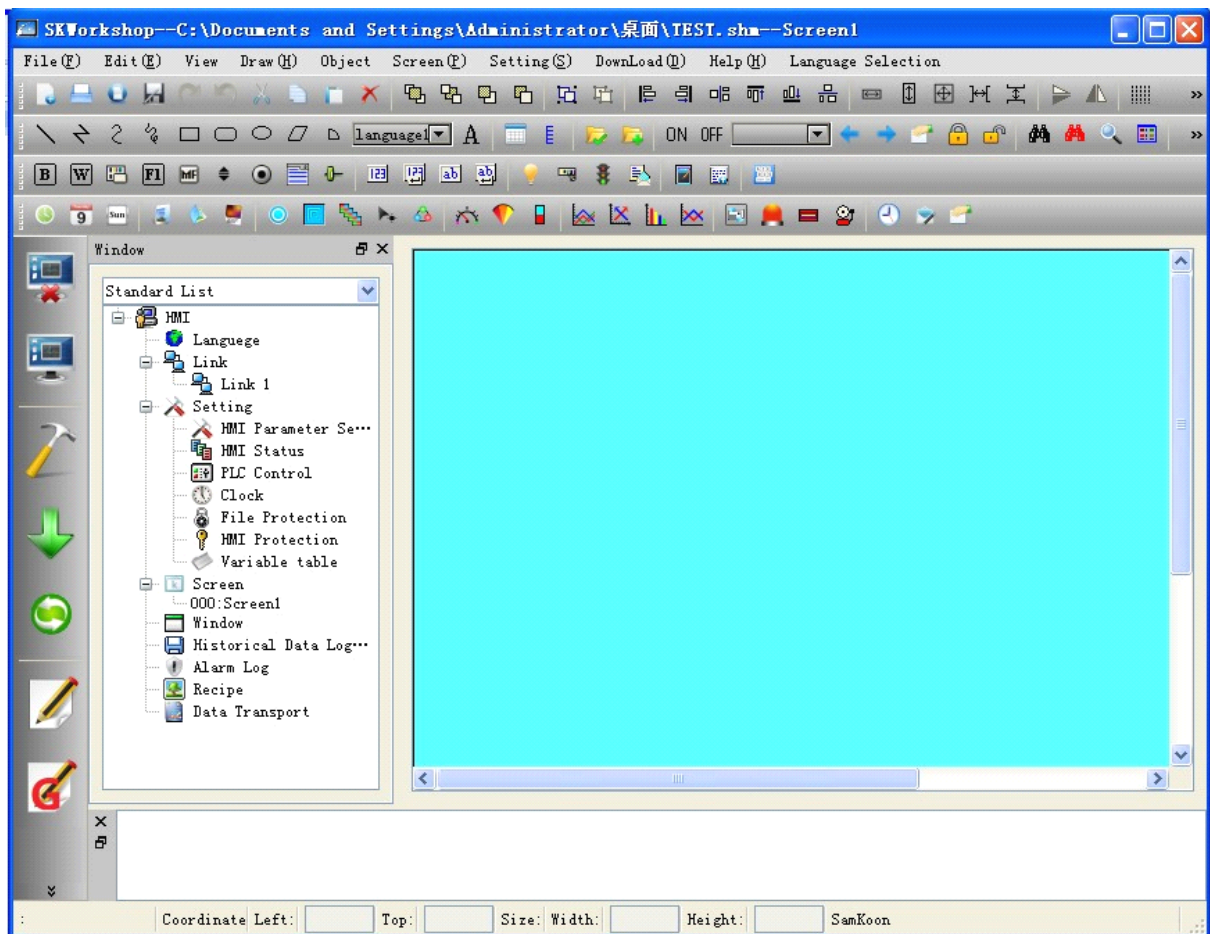

Figure 6-6 Project screen after completed creation of new project

Add controls into project:

- ✓ Click icon “Value Input Display” in toolbar. Set appearance, background color, foreground color, pattern and other attributes of the controls in popped up dialog box. The “Write Address” is D5. And select the option “Monitoring address is same to write address”. Value of all other attributes is default value. Click the button “OK” to display the controls on screen.
- ✓ Click the icon “Word Button” to pop up a dialog box. Then, set appearance, background color, foreground color, pattern and other attributes of the controls in the box. Select “+” in module “Function”. “Write Address” is D5. Enter “5” in column “Constant”. Usually, other attributes of page are of default values. Click the page tab “Label” and enter “D5+5” in box “Text” of page “Text”. Click “OK” to display the controls on screen.
- ✓ Click the icon “Bar Graph” in toolbar to pop up a dialog box. Then, set background color, color sample of bar graph and background color sample of bar graph. Select “Rightwards” in direction module. The monitoring address is D5. Maximum and minimum values are respectively 0 and 200. Value of other attributes is default value. Click “OK” to display the controls on screen.
- ✓ Click the icon “ASC word input and display” in toolbar. Then, set appearance, background color, foreground color, pattern and other attributes of the controls in popped-up dialog box. The write address is D2. And select options “Monitor” and “Monitoring address is same to write address”. Adjust the total number of words to 20. Values of other attributes are default value. Click “OK” to display the controls on screen.



in the offline simulation, the available functions for buttons are as following: “previous recipe”, “next recipe”, “current recipe save”, “user level change”, “user level log off” and “touch sound ON/OFF”. The “historical alarm

dialog box”, “historical data displayer”, “historical trend chart”, “timer” and “macro” on the toolbar can not be simulated.

- ✓ The creation method of other controls is same to previous introduction. Therefore, detailed description is not given again. After setting attribute of all controls, click “Save” to save the project. Then, select “Off-line Simulation” in menu "Download" of menu bar, as shown in figure 6-7.

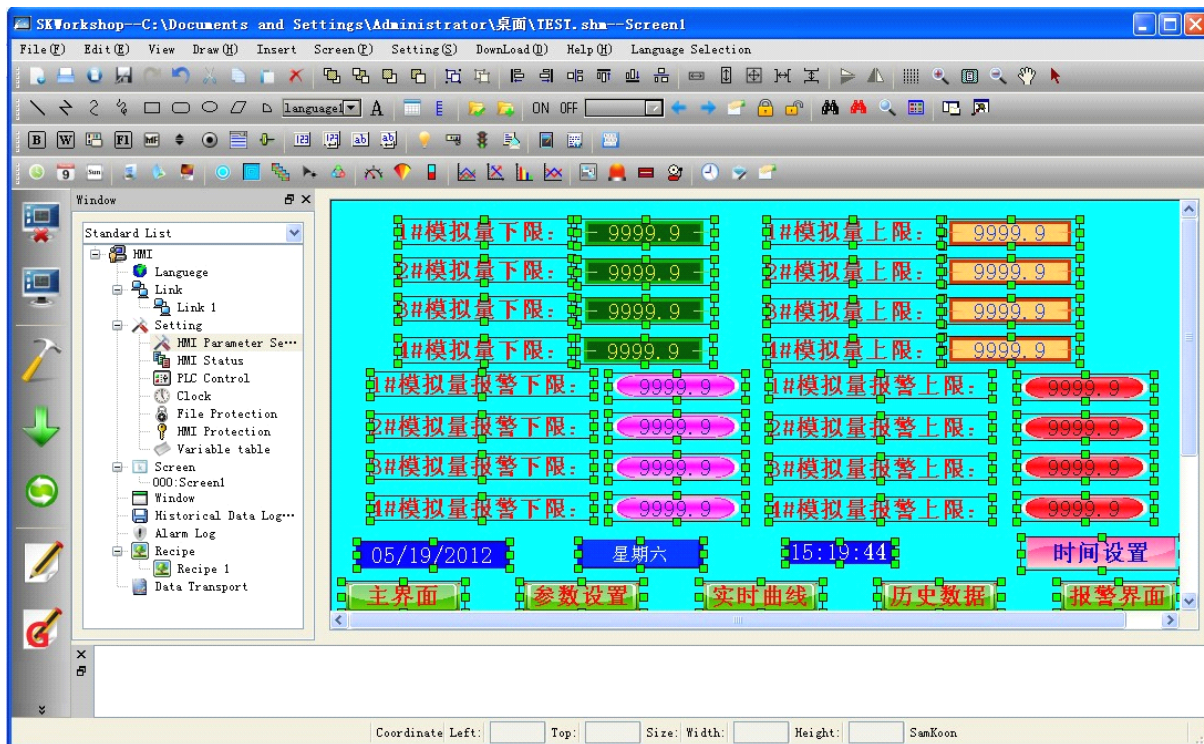

Figure 6-7 Edited project

- ✓ Click “Save” to save the project. Then, select “Off-line Simulation” in option “Download” in menu bar to pop up a screen as shown in figure 6-2. The introduction of off-line simulation example ends.

6.2. On-line simulation of SKWorkshop

If you have no SK series HMI, you can use on-line simulation to realize communication through personal computer, plc and other related devices. When using this function, the personal computer simulates the operation status of touch screen, which can debug the correctness of your configuration software and carry out related test if touch screen has fault. For configuration operation of on-line simulation, please refer to that of off-line simulation.

Connection with plc is needed for on-line simulation. At the time of operating on-line simulation, please ensure that the cable connected with plc and computer can perform normal communication. The service time of online simulation function is 30 minutes. It will exit simulation automatically after 30 minutes of program running.



Usually, the cable used by plc for on-line simulation is download line, i.e. cable connected with plc programming software, other than communication cable for plc connected with touch screen. Please contact us for technical support as soon as possible if communication is blocked.

7. System setting of SKWorkshop

7.1. Setting of communication screen of SKWorkshop

The setting of communication screen means to set the communication parameter of touch screen and connecting device. SK-12.1A, SK-10.4A, SK-10.2A, SK-8.0A, SK-7.2A, SK-7.0A, SK-7.2A, SK-5.7A, SK-5.7C, SK-5.7F have COM1 and COM2 two ports and can communicate with two different PLC at the same time. The parameter of each communication screen has to be set. SK-5.0A, SK-4.3A, SK-4.0A, SK-3.5A have one port, use COM1 in software and can communicate with one connecting device.

- ◆ Double click “link 1” in the “link”, and pop up the dialog box as shown in Figure 7-1:

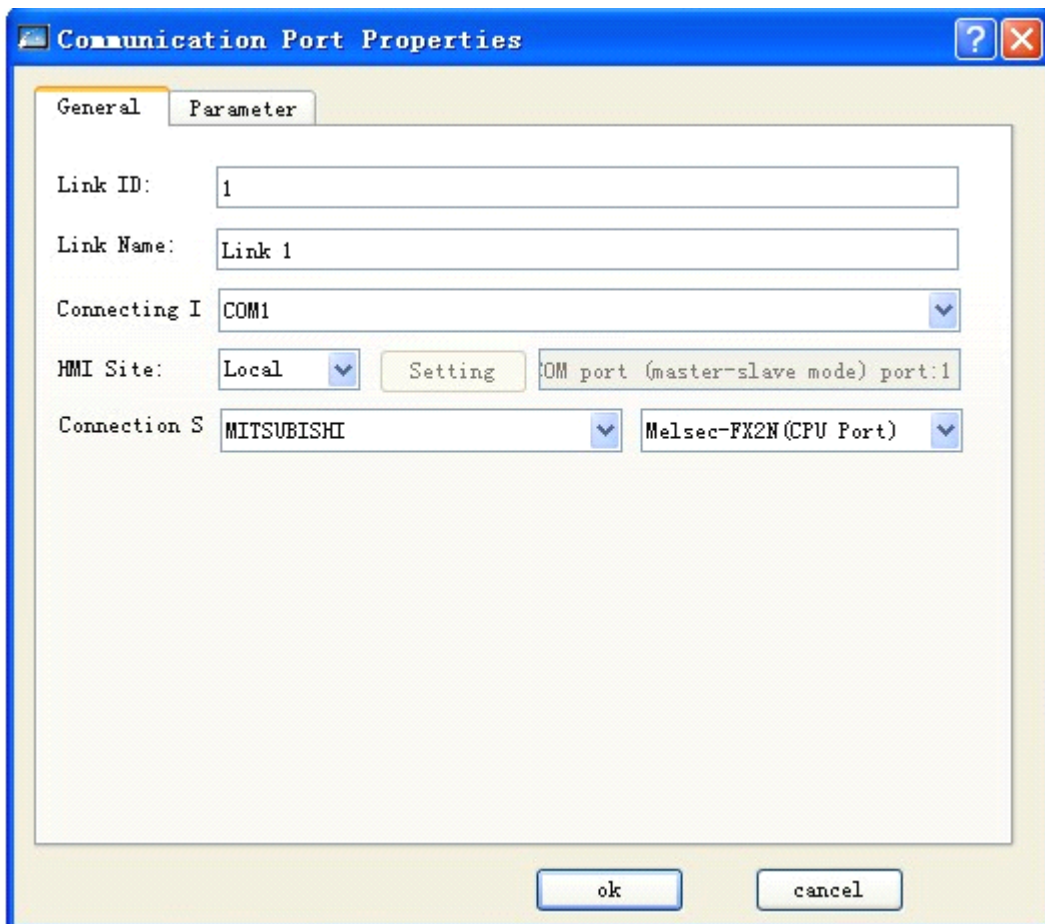

Figure 7-1 Dialog box for setting of COM1 communicate screen

Users can obtain different types of PLC in option "Device Service" in page and still can acquire different models of the PLC in its rear option. Besides, users can change “Connection Name” and “Interval of PLC Contiguous Address”.

- ◆ Click the tab “Parameter” in the dialog box, as shown in figure 7-2.

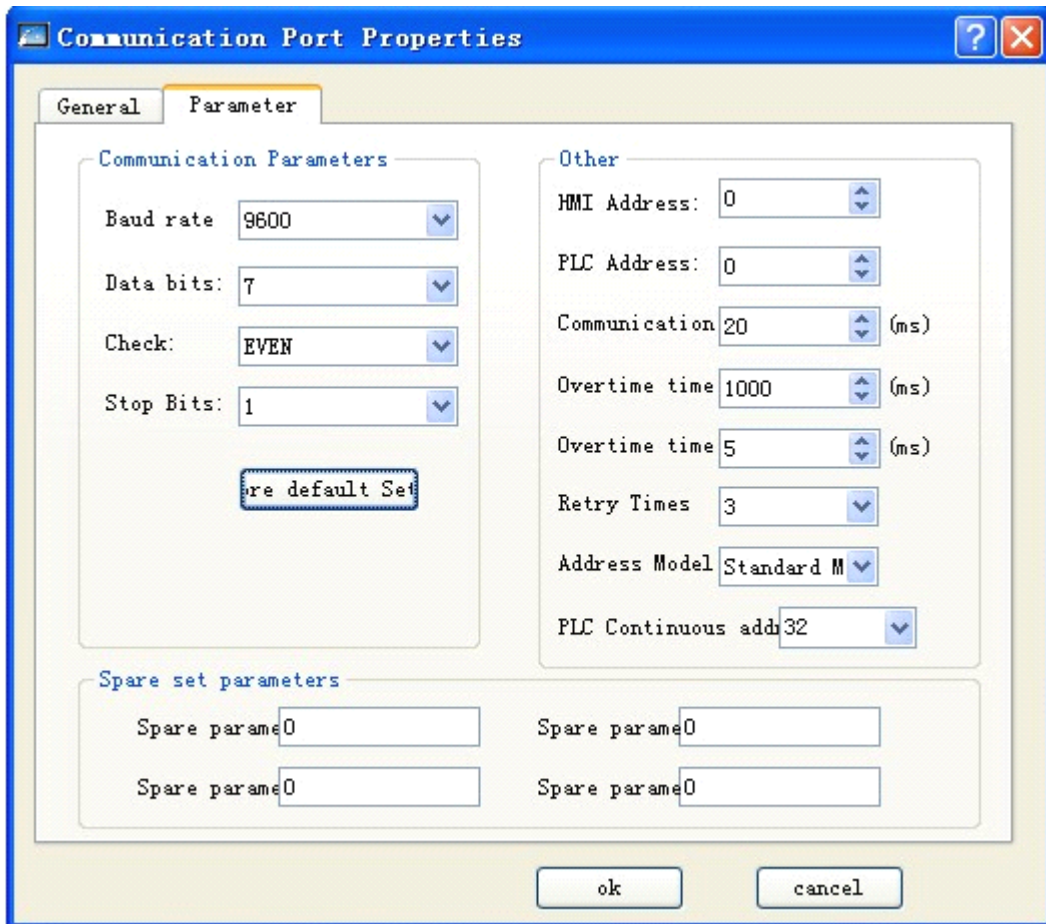

Figure 7-2 Parameter setting of COM1 communication screen

Parameter setting:

Device service: manufacturer, brand and CPU model of PLC.

Model: model of PLC

Baud rate: 1200/2400/4800/9600/19200/38400/57600/115200/187.5k

Parity check: odd check/even check/no check

Data bit: 7/8

Stop bit: 1/2

Communication mode: RS232/485/422

7.2. Setting of SKWorkshop

Let's come to some settings of HMI. It is also important for project configuration. We can change HMI system settings in a narrative way to achieve the expected effect of users.

7.2.1 Language of SKWorkshop

Language: this option possesses the multilingual function. Double click the option, and pop up the following dialog box:

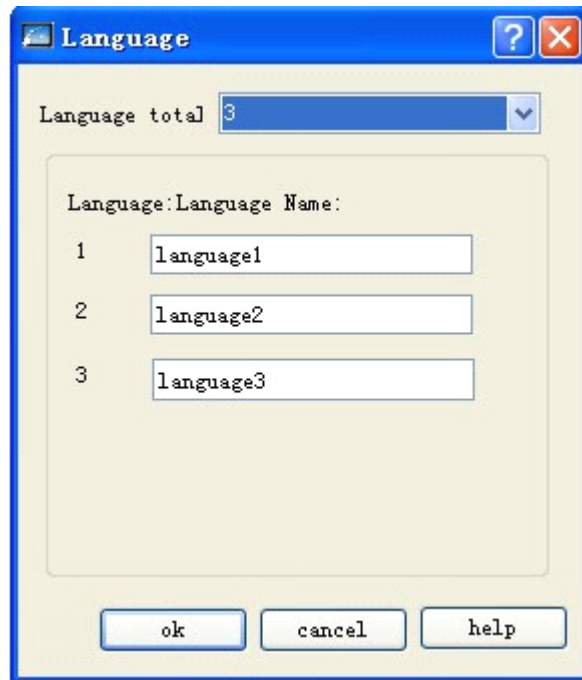

- Language sum: five languages are available for setting.
- Language name: the users can set a simple and concise language name as requirements.

Let's illustrate how to realize multilingual function in the following sections.

For example:

1. As shown in above figure, the language quantity for setting is 3, and the language name is default. Create a control with text entry such as screen button; select language 1 in the drop down list; enter "language 1 – Simplified Chinese" in the text, and set the font size, color and other attribute value. Select language 2 in the drop down list, and then enter "language 2- English" in the text. Select language 3 in the drop down list, and enter "language 3-Japan" in the text. Details are shown as following figure:

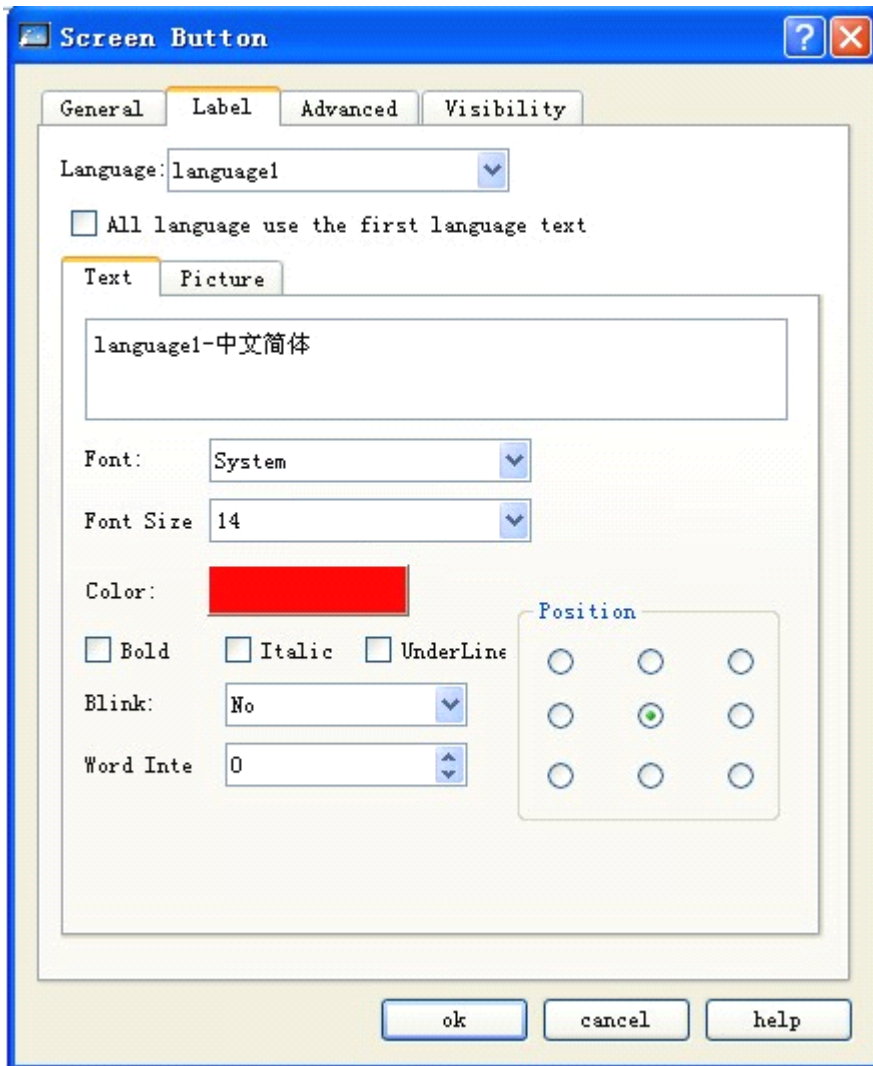

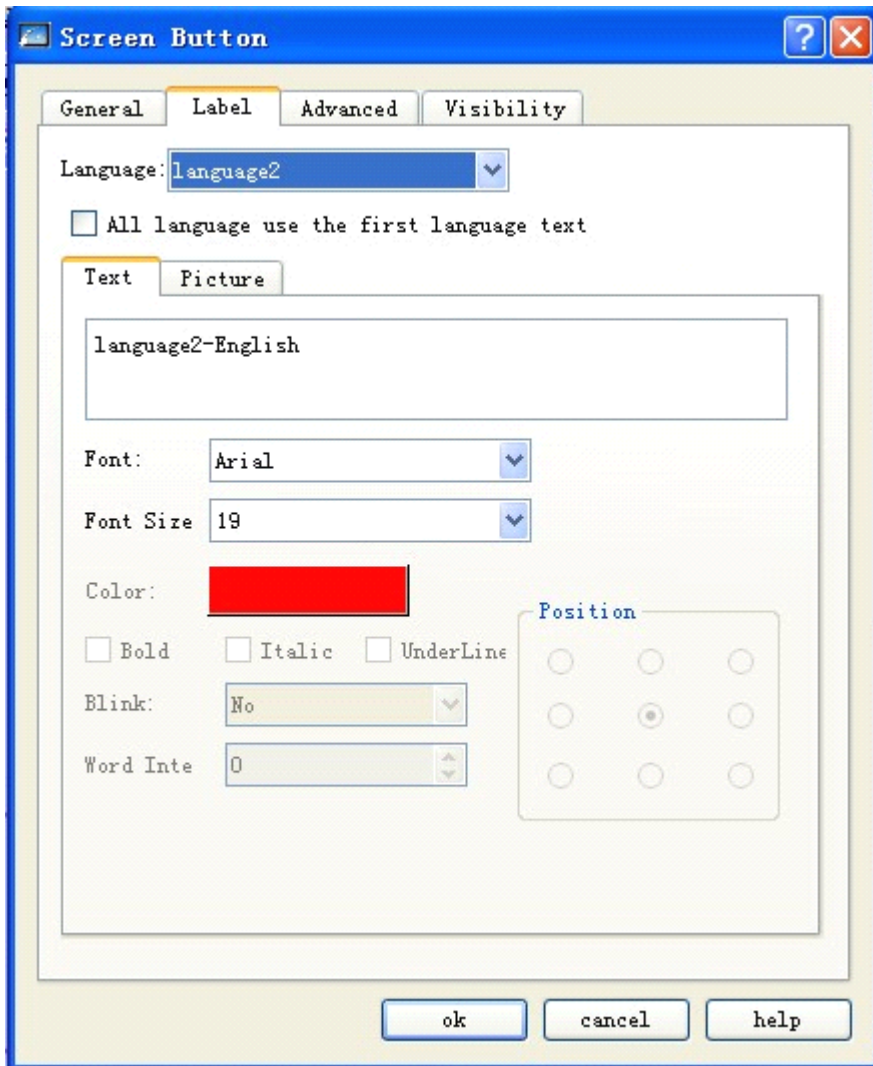

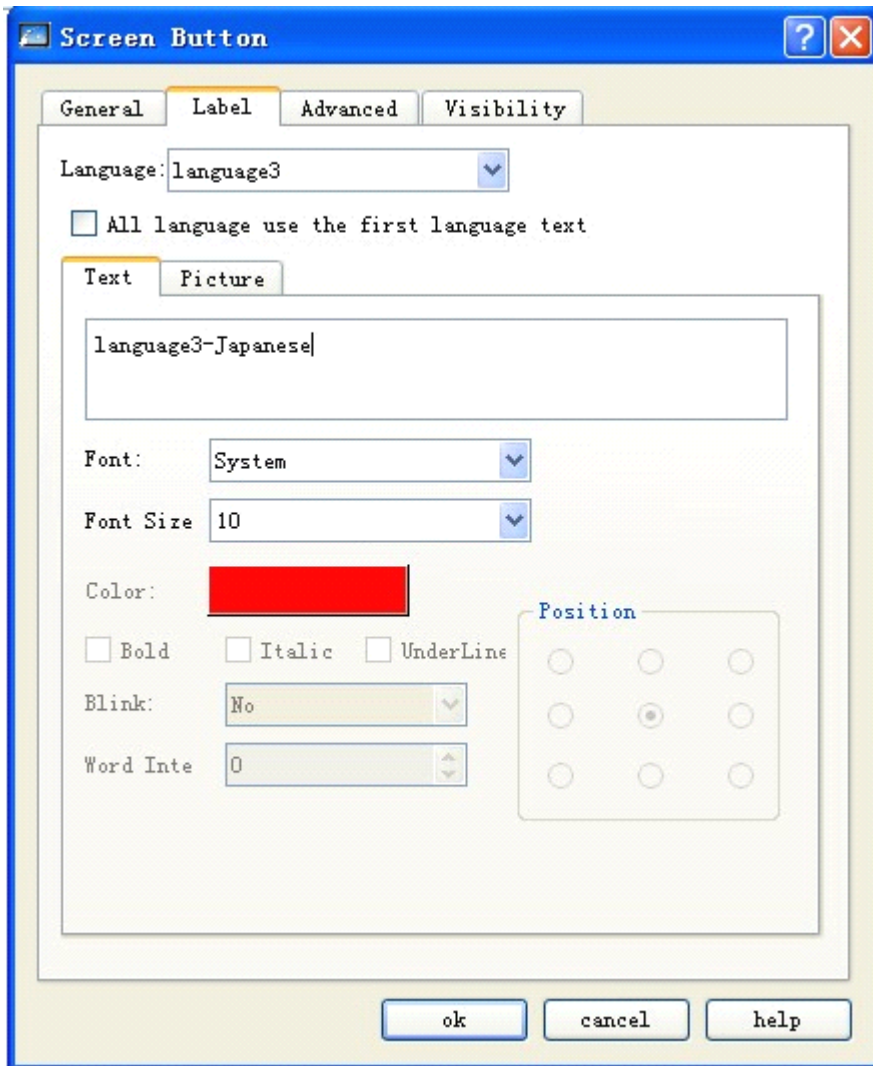

- Click “confirm” button after settings finish, and the mouse will become a cross shape. Click on the screen to add the screen button and adjust the size of control button. Then, build three function buttons, and the text entry of “mark” for each function button is described as following: select language 1 in the drop down list of language, and enter “present language 1 – Simplified Chinese” in the text; select language 2 in the drop down list of language, and enter “present language 2 – English” in the text; select language 3 in the drop down list of language, and enter “present language 3 – Japan” in the text. The “function” option on the “general” page of each function button should be “language switch”, the “language” option is language 1, language 2 and language 3 respectively.

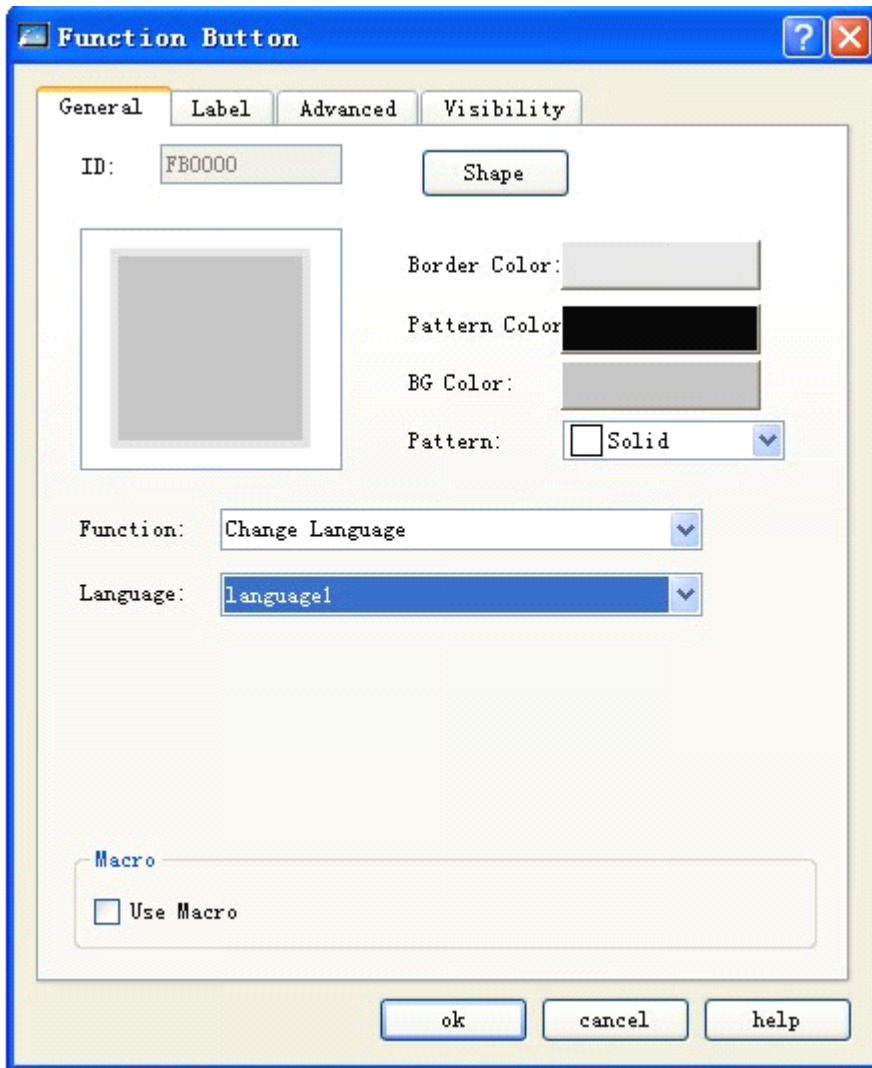

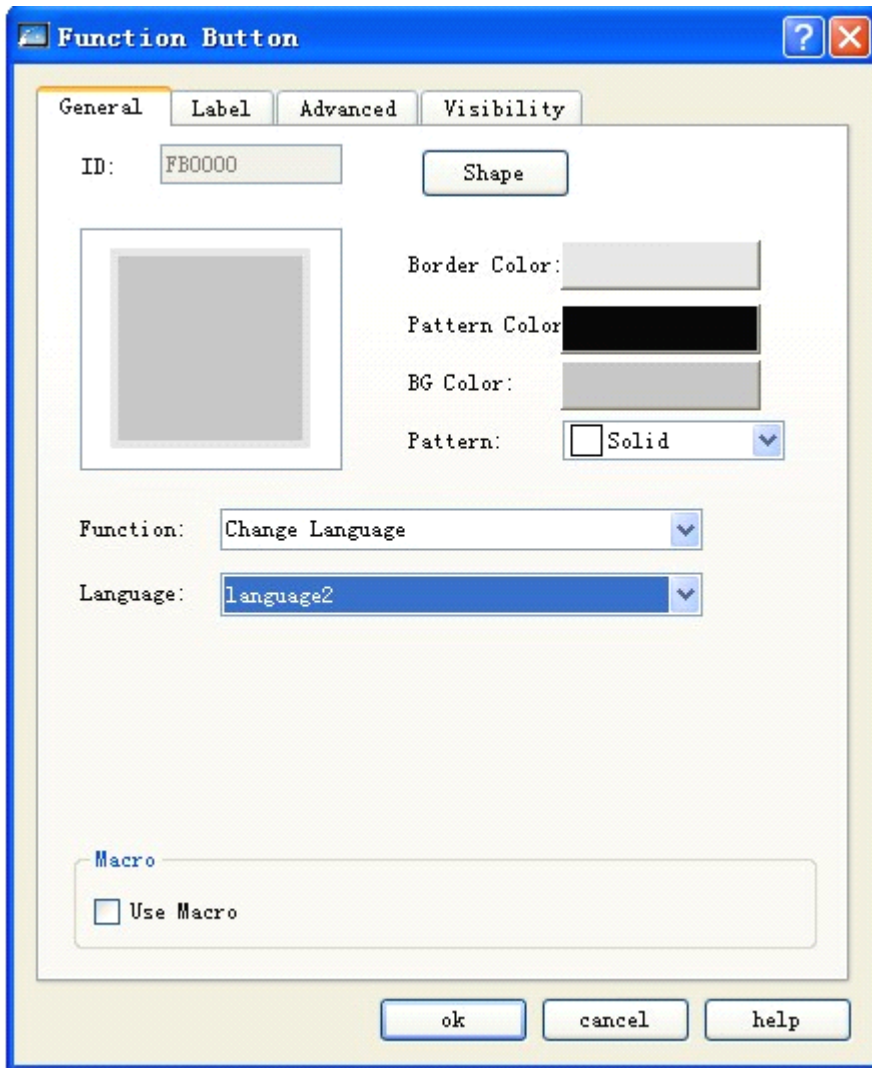

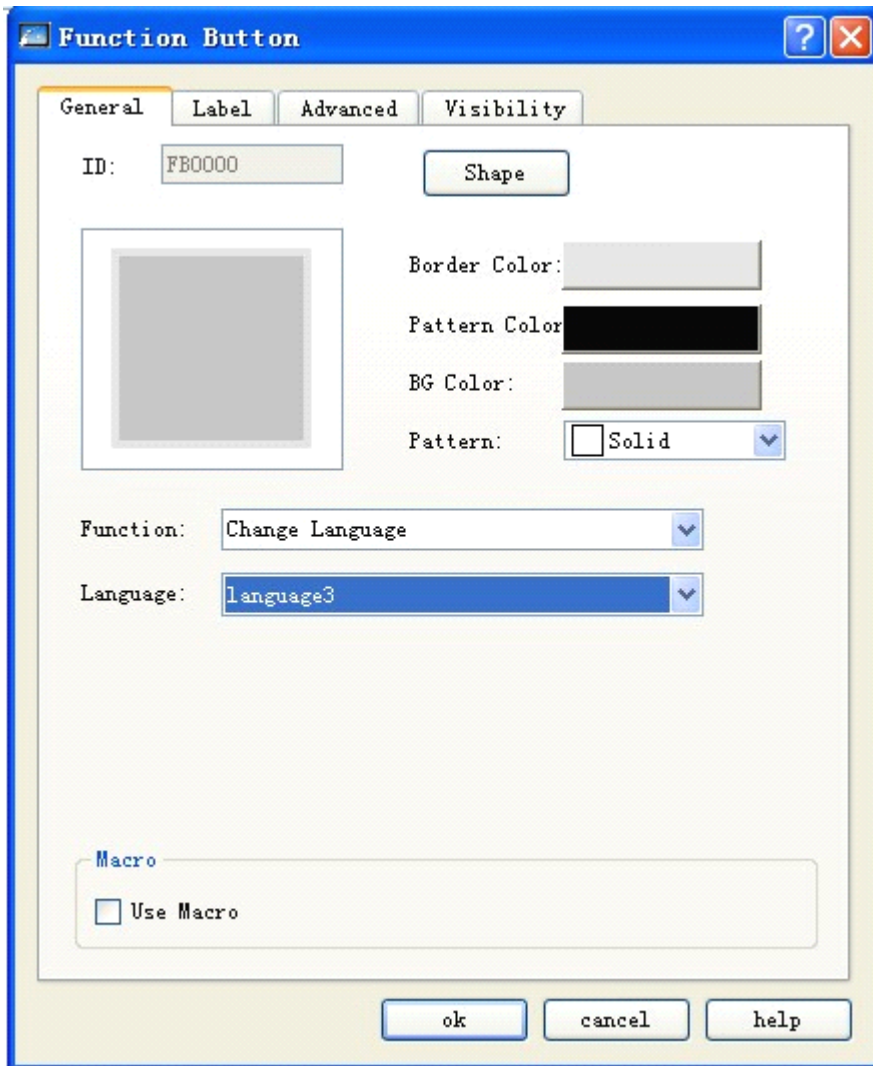

3. After setting finishes, save the project as shown in following figure:

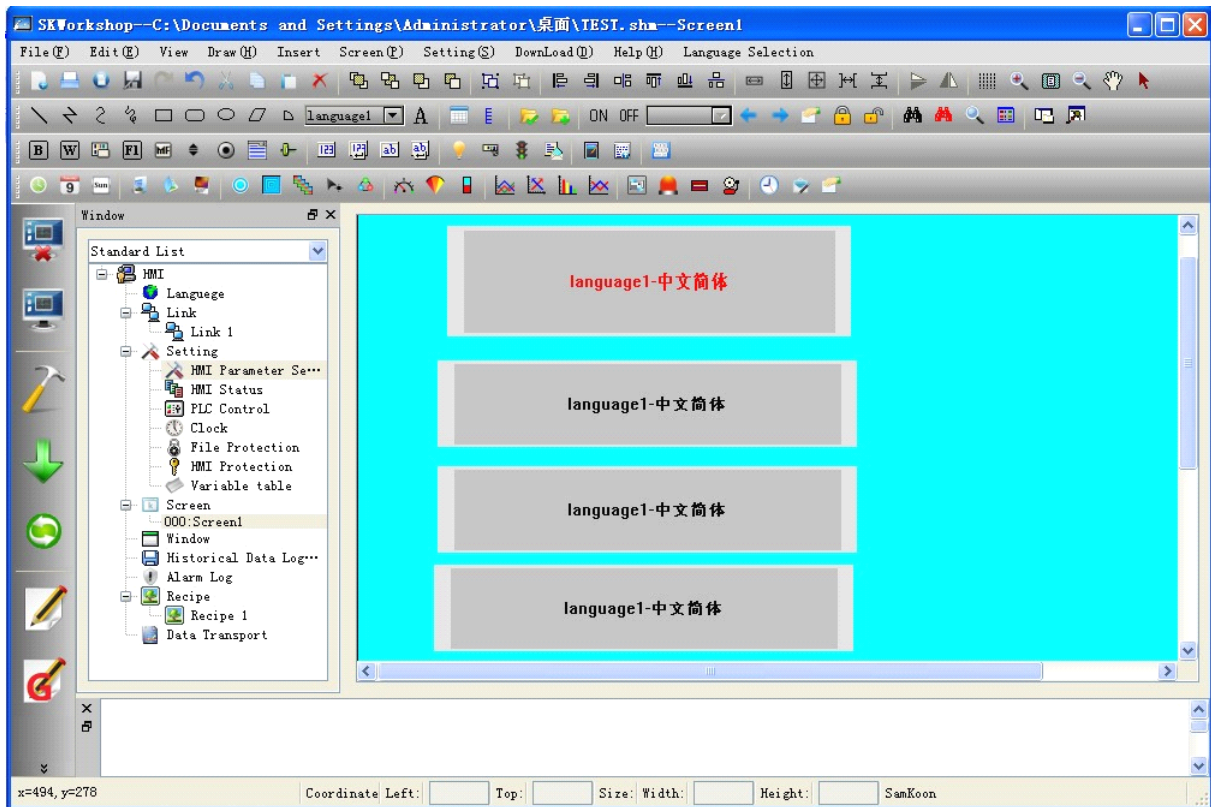

4. Simulate (or download to HMI): when the users click button 1, button 2 and button 3 separately, all controls with text in the project will display in the text at defined language, which is shown as following figure:

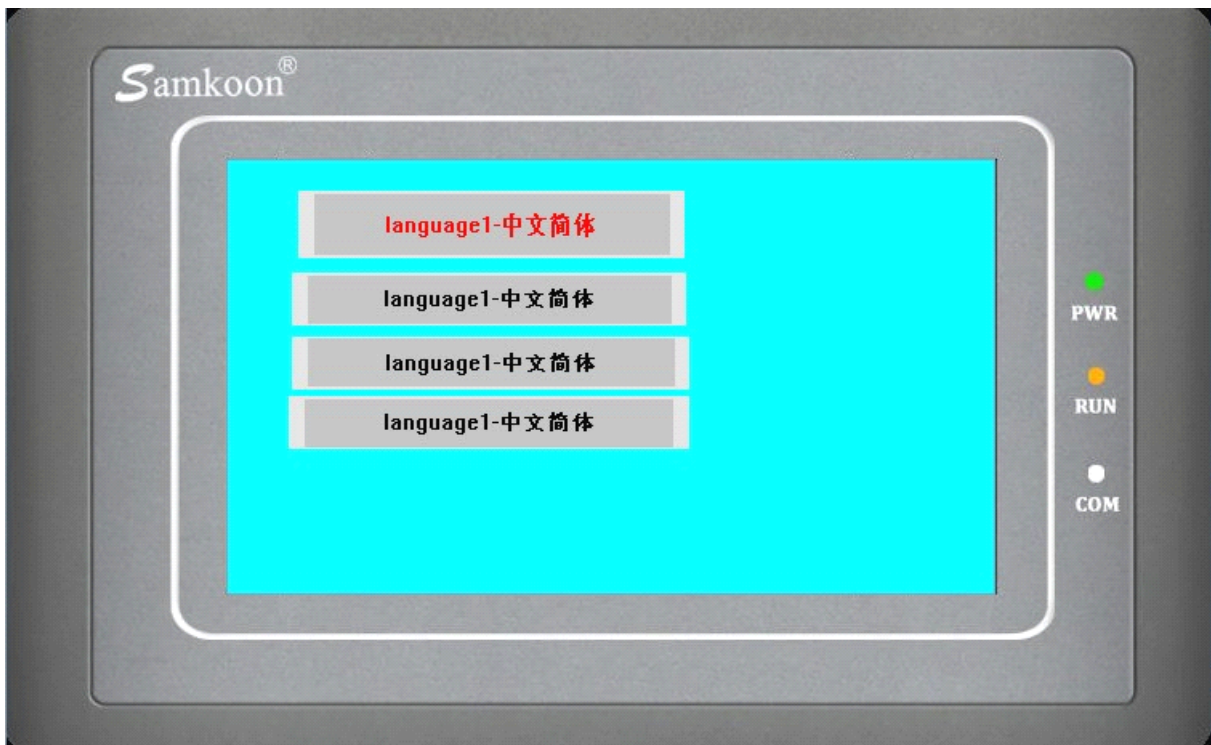

The above figure is the state at language 1 by clicking button 1

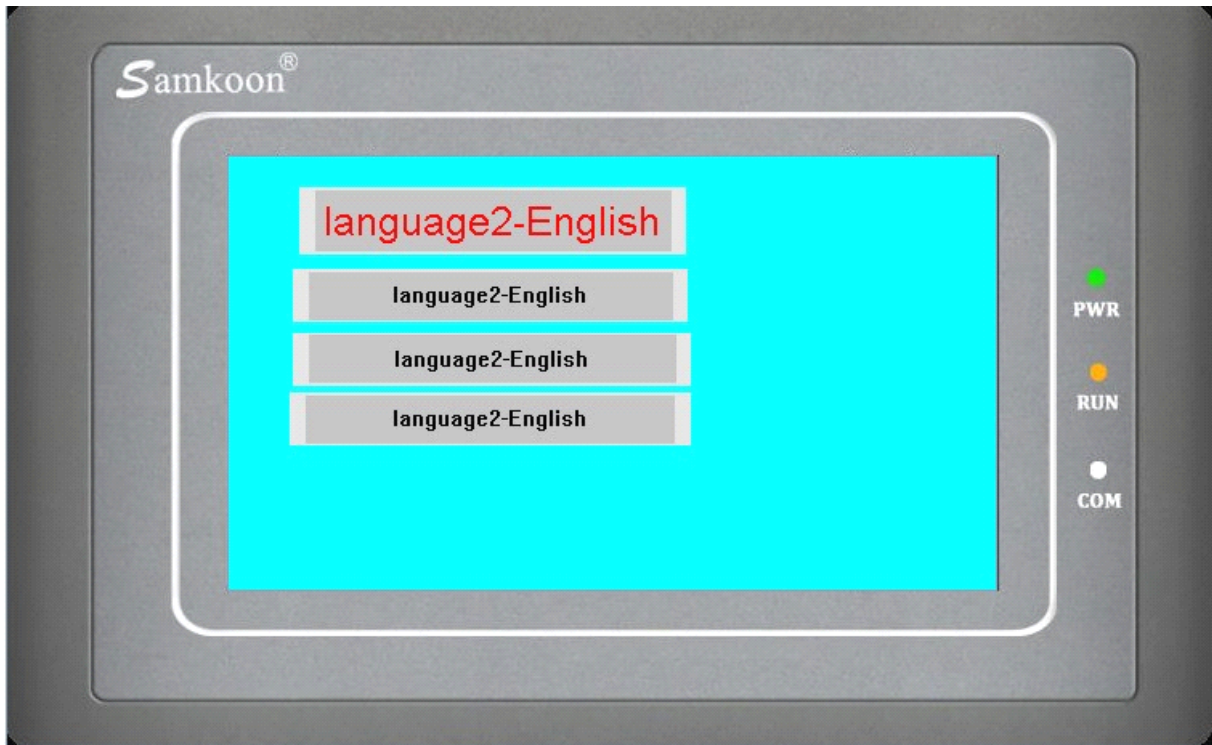

The above figure is the state at language 2 by clicking button 2

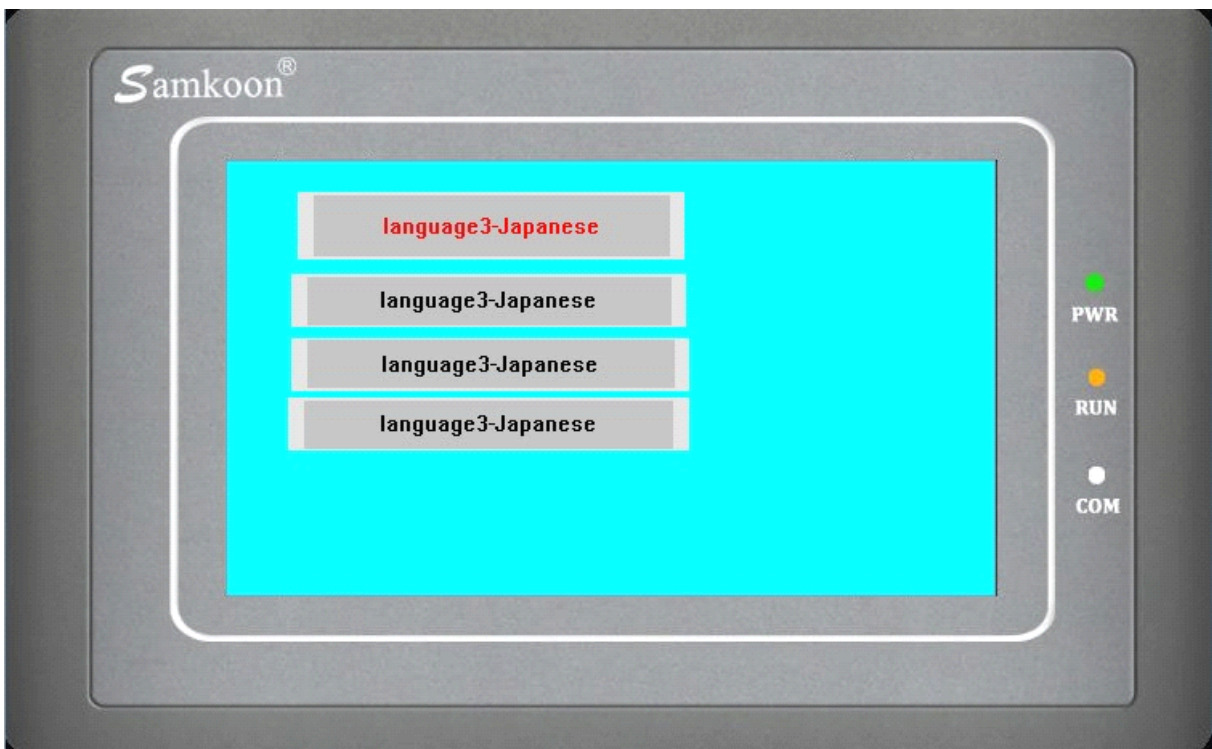

The above figure is the state at language 3 by clicking button 3

To realize the multilingual function of the overall project, it has to enter the different contents for different languages in each control or each objective with text entry (the operation is same to item 1). In this case, the project can be switched to the specified language while the “language switch” of function button is used.

7.2.2 Parameter setting of touch screen of SKWorkshop

The HMI model selected for project can be designated at the time of project establishment and also be changed at configuration. The HMI model currently used in project can be altered through selecting the parameter setting command of touch screen in project manager.

- ◆ Double click the option “Parameter Setting of Touch Screen” in “Project Manager” to pop up a dialog box as shown in figure 6-0.

Parameter Setting:

1. The parameters can be set and changed from the drop down list or by double clicking the touch screen setting in the project manager. Then it will pop up the dialog box as shown in Figure 7-3:

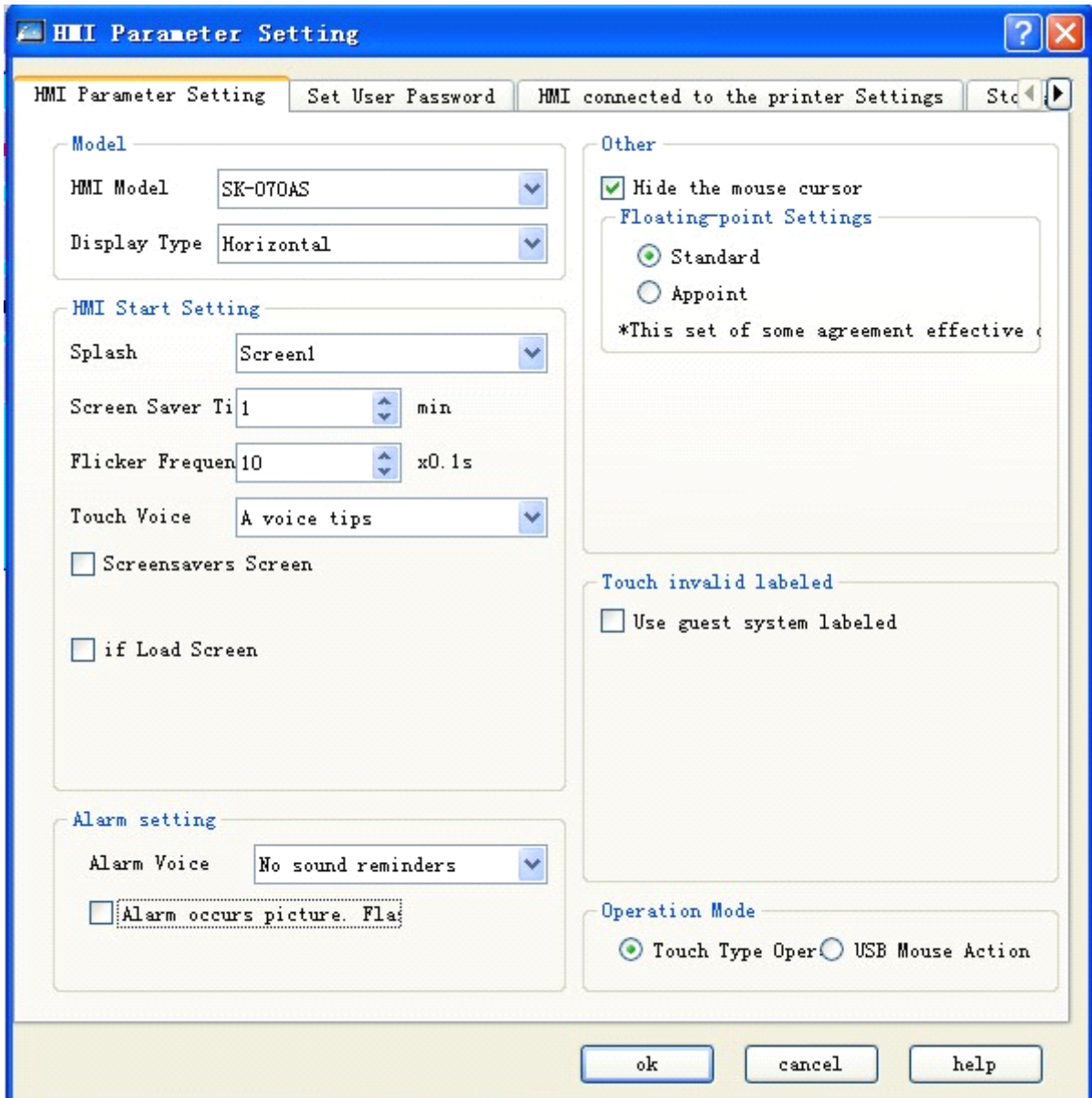

Figure 7-3 General setting box for touch screen parameters

- Touch screen model: change the touch screen model by changing the option.
Model description: the meaning of each character, such as SK-070AS.
SK: indicating the SK series of Samkoon.

070: indicating the 7-inch screen of SK series. The figure is HMI dimension.

A: indicating the model, there are C model, D model and F model additionally. Different kinds of HMI have different resolutions.

S: indicating the HMI model is standard; E indicates economic HMI.

- Display mode: to adjust the horizontal or vertical display mode.
- Startup setting of touch screen
 - ◆ Start screen: the startup screen while the touch screen is powered on
 - ◆ Screen saver time: the set screen saver time
 - ◆ Flicker frequency: make setting of flicker frequency for the object or control with flickering mark, which can be changed the speed by direct entry and clicking spin button.
 - ◆ Alarm sound: if the alarm is set, the touch screen may make a sound to inform of users. There are two options as “with sound” and “without sound” in the right drop down list.
 - ◆ Touch sound: it can set the touch screen sound from the right drop down list.
 - ◆ Screensaver picture: select one picture as the screensaver picture. You can exit the screensaver picture by touching the touch screen.
 - ◆ Load picture: if there is the option, it will display the selected loading picture after the touch screen if powered on. When it remains the setting time, it will shift to the startup screen, which may give some hints or considerations for users in the screen.
 - ◆ Flicker screen in alarm: when there makes alarm, the background with alarm control or alarm bar screen will be replaced by “screen background color”. The flicker frequency is same with the above description.
- Other settings
 - ◆ Hide mouse cursor: it is display cursor or not.
 - ◆ Floating number setting: [standard]: the high byte of floating number is in front and the low byte is behind; [defined]: confirm the high and low byte position as required by users.
 - ◆ No data mark:
 - Value object: the control that displayed in communication failure (i.e. numeric display control, numeric input control etc.). [Stay] means to maintain the original display; [clear] means to clear the displayed text of the control; [#] means to display the text with symbol “#”; [?] means to display the text with symbol “?”.
 - Character object: the control that displayed in communication failure (i.e. ASCII display control, ASCII input control etc.). [Stay] means to maintain the original display; [clear] means to clear the displayed text of the control; [?] means to display the text with symbol “?”.
- Touch invalid sign: if selecting “customized mark”, it means to mark the control is uncontrollable with the selected picture of users on the control when the controllable control is unavailable.
- Operation mode: make operations by touch or USB mouse.

2. The user password setting is shown as Figure 7-2:

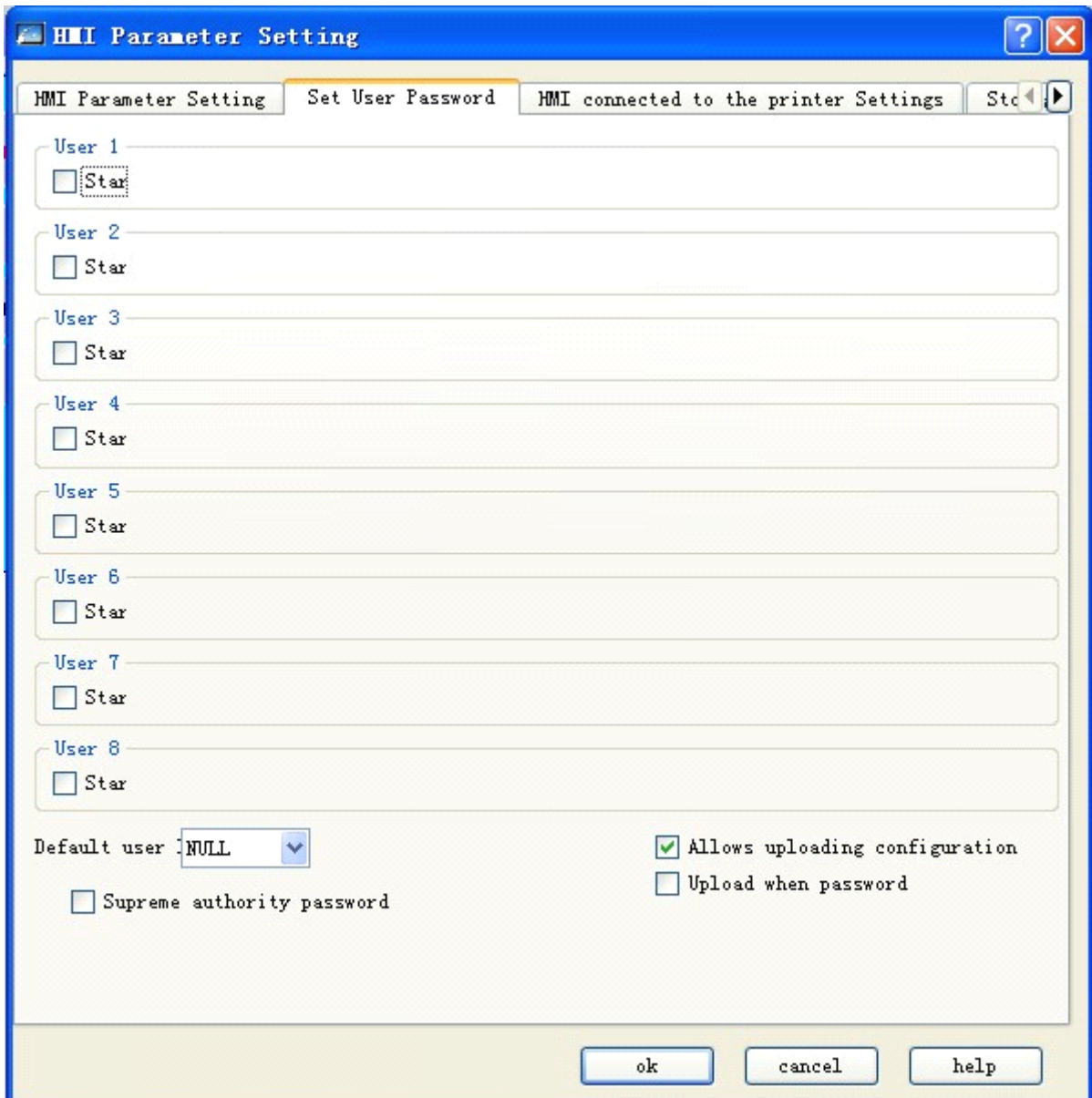

Figure 7-2 User password setting in touch screen parameter setting

- This page includes 8 user passwords, and each password has 8 levels for option.
- Default user level: the current user level defaults NULL.
- Uploading configuration: if this option is selected, the project can be uploaded from HMI to PC; otherwise not.
- Enter password in uploading: it requires password in project uploading.
- Highest permission password: this password can start the controls at all permission level.
- Enabling upload: this password can upload the HMI configurable project to PC.
- Permission operation: this password can make operations at all permissions.

3. The connection setting between touch screen and printer is shown as Figure 7-3:

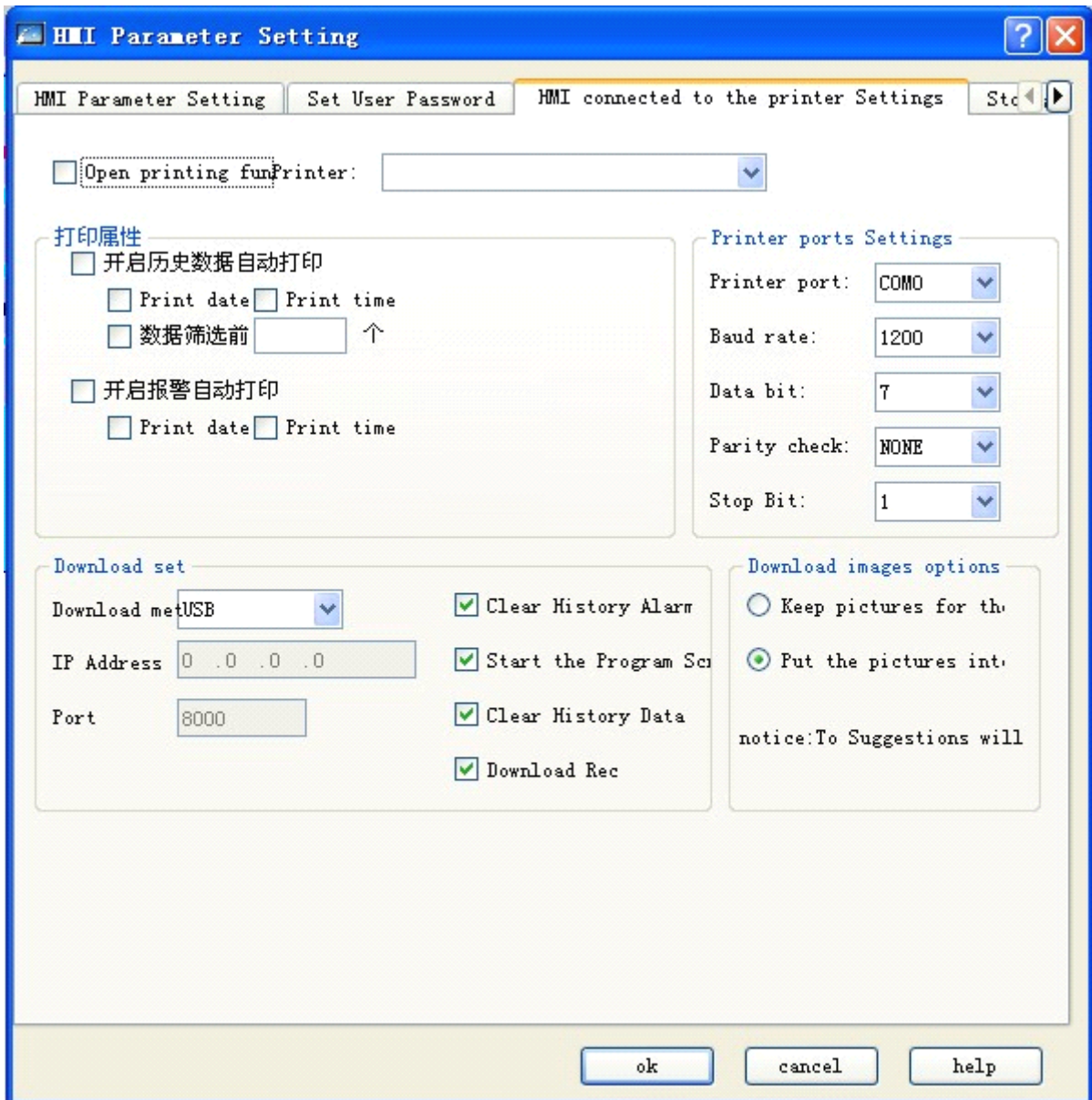

Figure 7-3 Connection setting between touch screen and printer

- This page displays some parameter setting when HMI connects printer. The users may make the corresponding configuration as the printer model.
- Download setting:
 - Download mode: users can select USB or Ethernet downloading as required. If the Ethernet is selected, it has to set IP address and port number (IP address and port number refers to that of HMI).
 - Clear historical alarm records: whether to clear the historical HMI alarm information in downloading.
 - Bootstrap screen after downloading: whether to restart the interface after downloading.
 - Clear historical data records: whether to clear the historical HMI data information in downloading.
 - Recipe downloading: whether to download the current project recipe into HMI.
- Downloading picture option:
 - Save picture as original format: if this option is selected, the original format is remained in downloading.
 - Convert picture into JPG: convert all pictures selected by users into JPG, and download into HMI.

(Note: as BMP format occupies larger, it is recommended to use the option “convert picture into JPG”)

4. The settings of “storage position & system alarm” are shown as Figure 7-4:

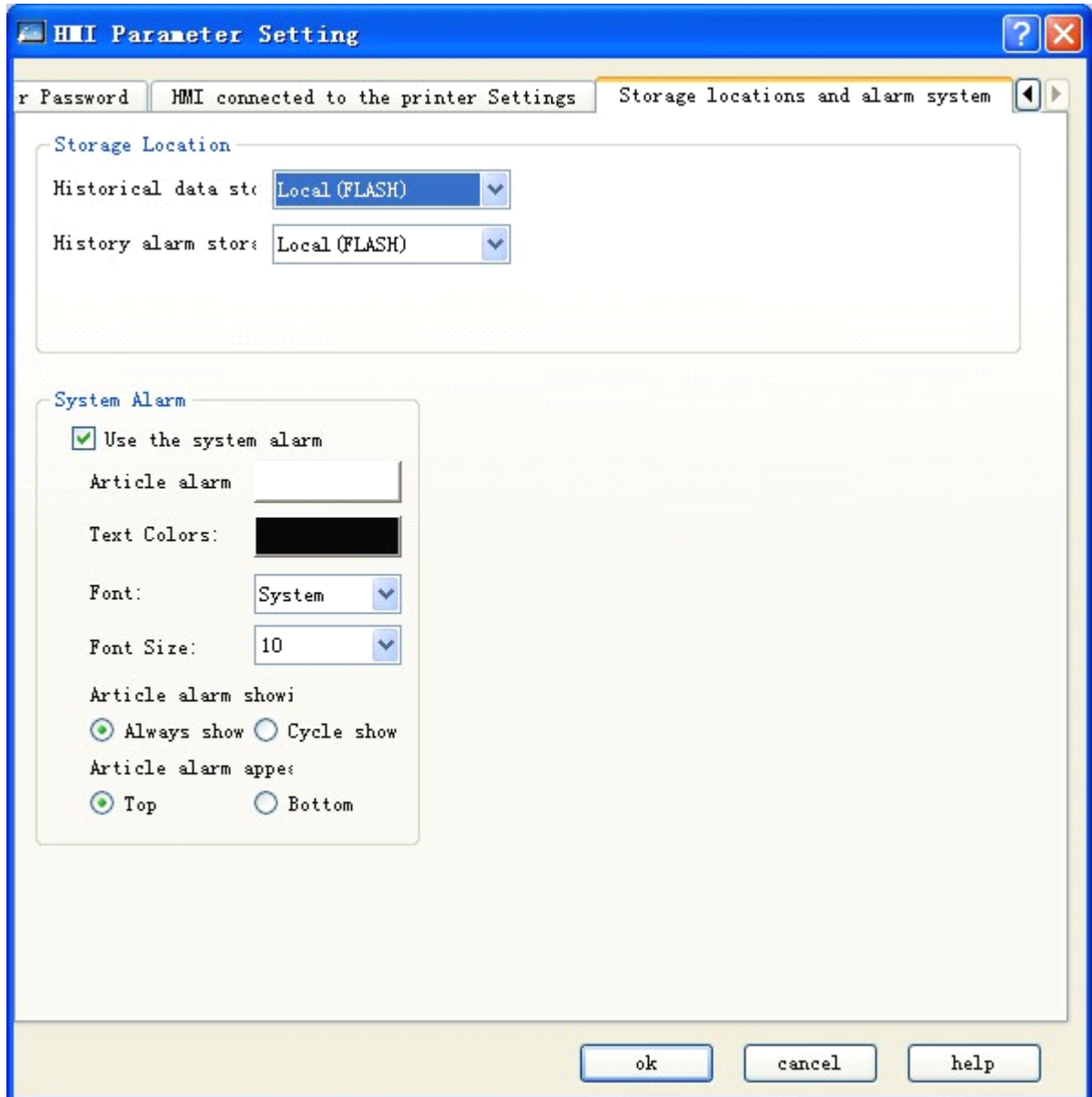

Figure 7-4 Setting page of storage position & system alarm

- Storage position: the position to save the historical data, historical alarm and screenshot. There are three options as “Local (FLASH)”, “U disk” and “SD card” for storage. It defaults to store the data in FLASH.
- System alarm
 - Use system alarm: whether the system alarm function is used or not. According to the system alarm options set by users, the screen top or bottom will display the current alarm information when there is alarm.
 - The background color, text color, font and font size in alarm bar are the property options in system alarm setting. Users can set these items as required.
 - Display mode of alarm bar: “always display” means the alarm displays all the time; “periodic display” means the alarm displays or disappears during a certain period.
 - Alarm bar position: select the position of alarm bar.



The screen saver time is effective only if screen saver is enabled. After the screen saver picture appears, you can simply touch the screen to go back the original screen.

7.2.3 HMI status of SKWorkshop

HMI status setting means to write current HMI status information into PLC data register.

- ◆ Double click the option “HMI Status” in “Project Manager” to pop up a dialog box as shown in figure 7-5.

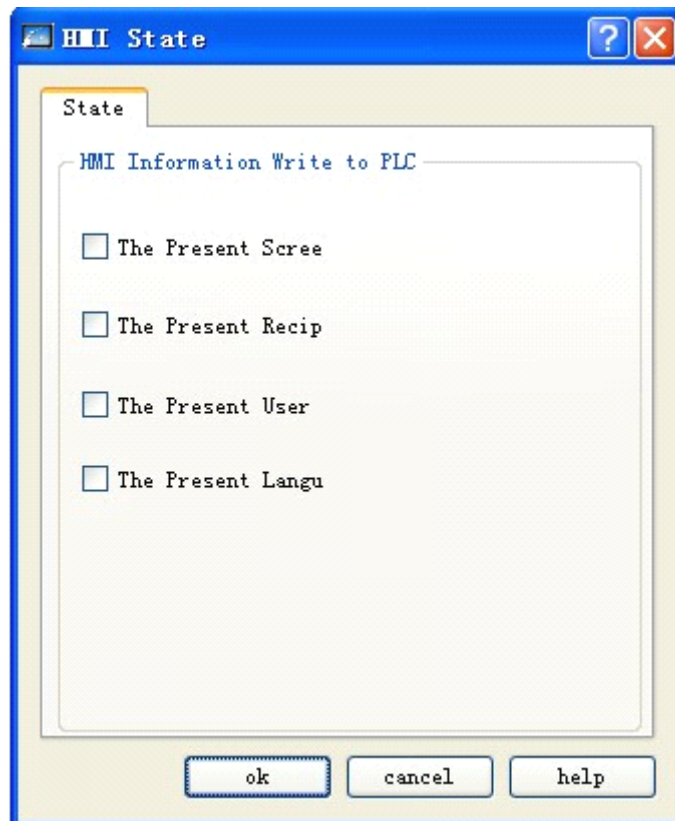

Figure 7-5 Setting of HMI status

Serial number of current screen: Write the serial number of current HMI screen into PLC.

Serial number of current recipe: when there is recipe, write the serial number of current recipe into PLC.

Current user level: write current user level into PLC.

Present language: that is to enter the present language number into PLC.

Click "OK" to finish setting of HMI status.

7.2.4 PLC control of SKWorkshop

PLC control concludes switching of PLC control screen, change of user level, recipe alteration and operation of write recipe.

Double click the option “PLC Control” in “Project Manager” to pop up a dialog box as shown in figure 7-6.

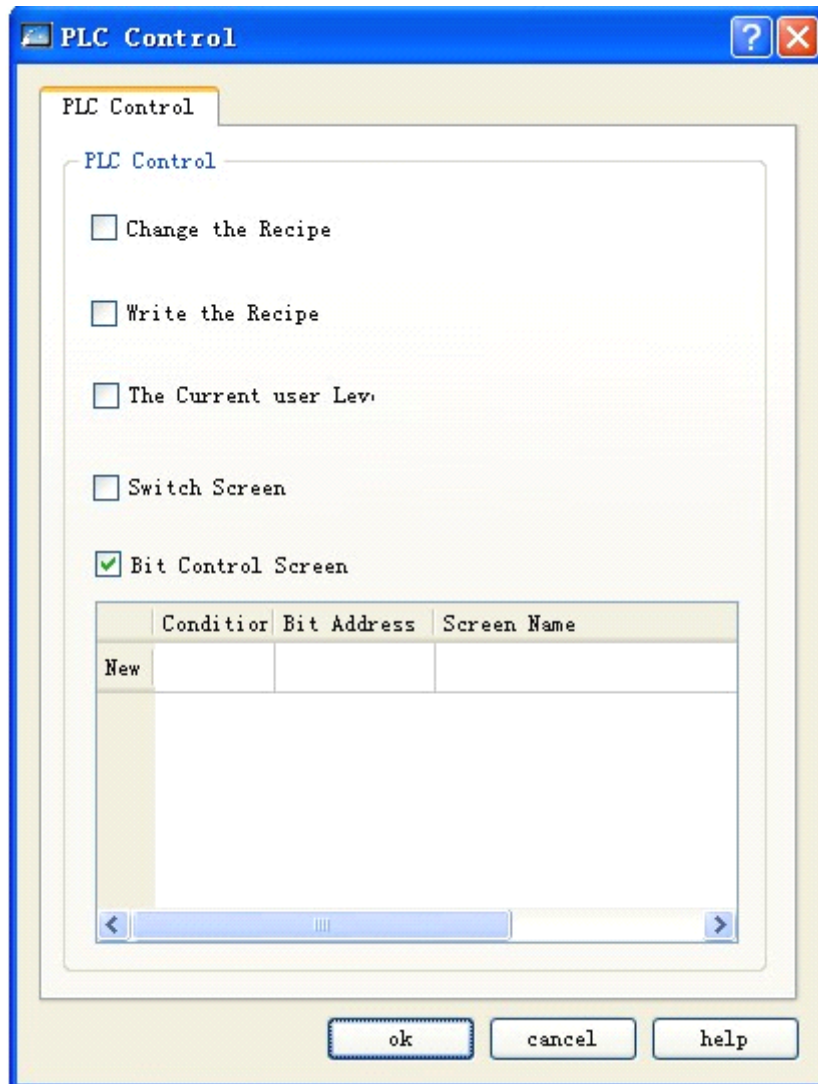

Figure 7-6 Dialog box of PLC control

- Control recipe change: HMI changes recipe as the address of “control recipe change”.
- Control recipe write-in: HMI controls the recipe write-in as the address of “control recipe write-in”.
- Control the current user level: HMI controls the current user level as the address of “control the current user level”.
- Word-control screen switching: it means the word address controls the screen switching. HMI switches the screen as the address of “control screen switching”. If the address value is n, it means to jump to screen n.
- Bit-control screen switching: double click “new create” line, and pop up the dialog box as Figure 7-7:

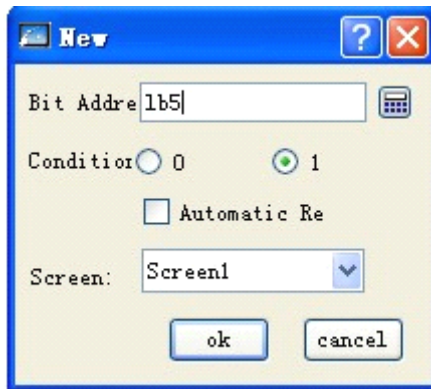

Figure 7-7 The dialog box of new creating a bit-control screen switching

Enter the “bit address”, select the satisfied “condition” and screen, and click "confirm". Then one bit-control screen will be added in Figure 7-6. Details refer to Figure 7-8.

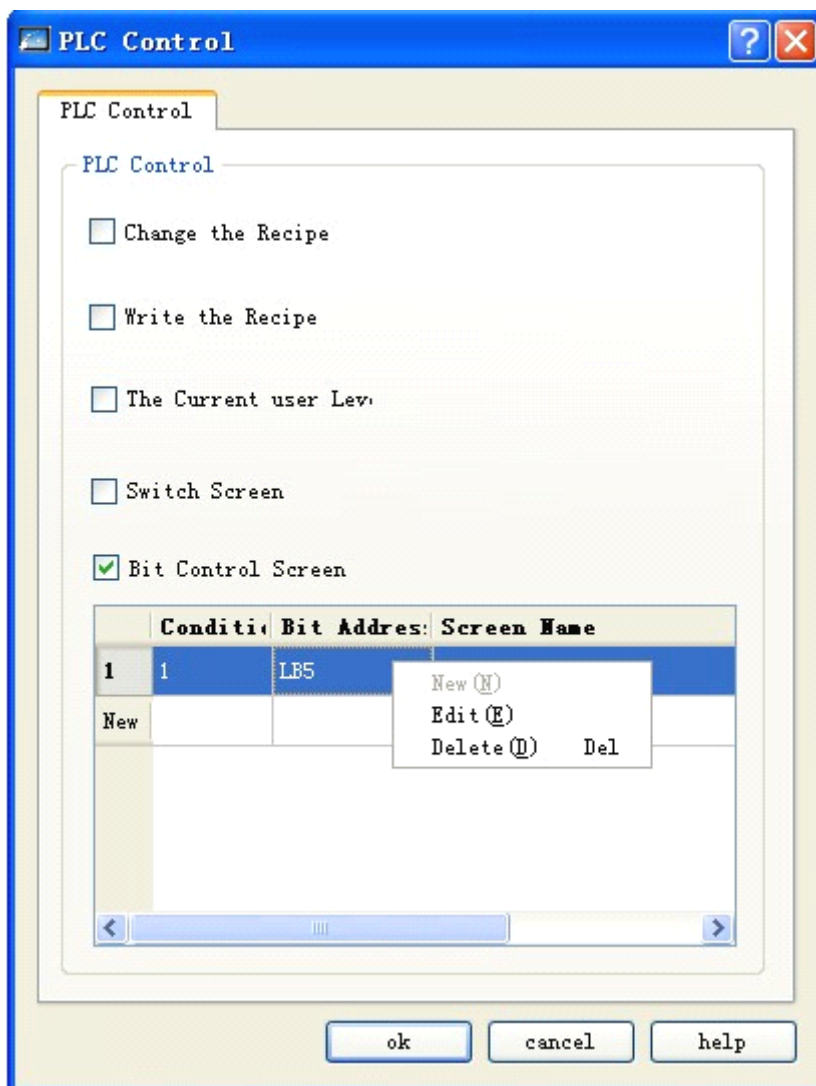

Figure 7-8 The dialog box of new creating a bit-control screen switching

In the same way, a number of bit control screens can be created. The sequence of bit-control screen switching is made number. Right click the bit-control information, and pop up the right-click menu as “create”, “edit” and “delete” for users.

Details refer to Figure 7-8. When the address LB5 is 0, it will jump to screen 1.

Click “confirm” button, and PLC control setting is finished.

7.2.5 Clock of SKWorkshop

Clock setting includes three functions: download the system clock to HMI, write time to PLC and synchronize time with PLC.

- ◆ Double click the option “Clock” in “Project Manager” to pop up a dialog box as shown in figure 7-9.

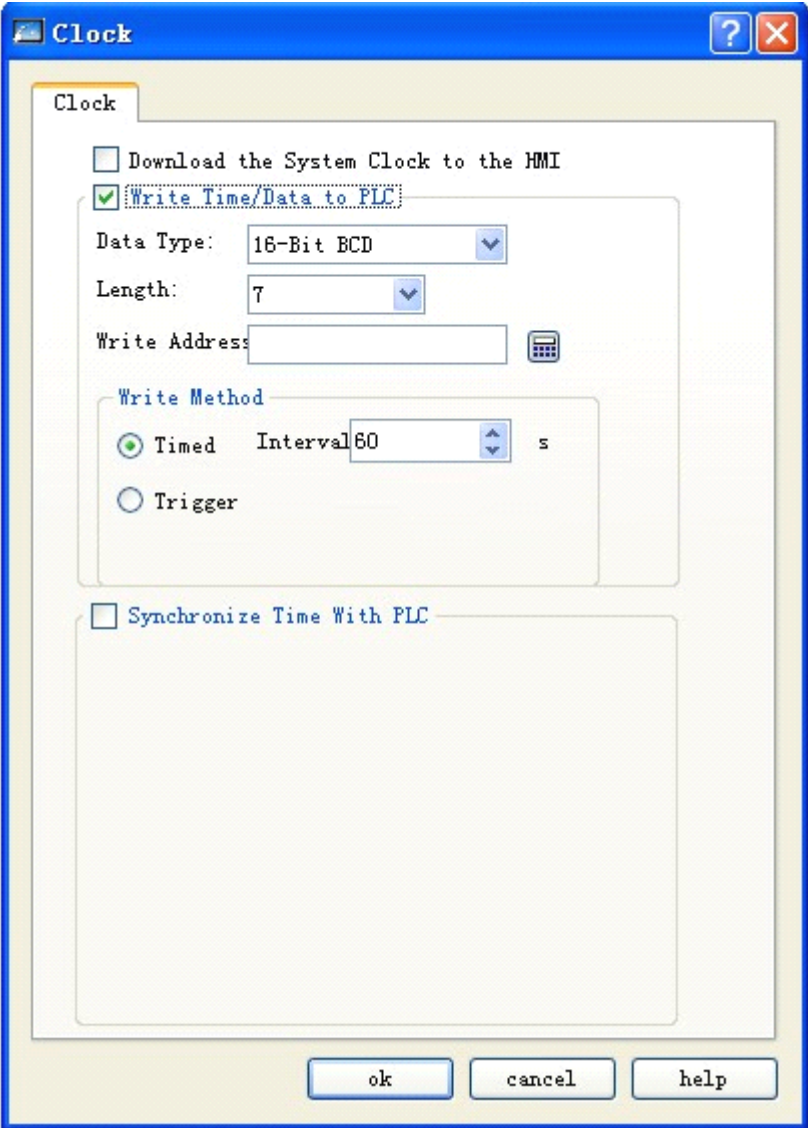

Figure 7-9 Dialog box of clock setting

Download the system clock to HMI: whether download the clock information of system into HMI.

Write time to PLC:

- Data type and length are default value.
- Write address: write the time information of system to corresponding PLC address.
- Write mode:
 - Timed: Treat the set time interval to be time unit; Write the time information of system to corresponding PLC address circularly.
 - Triggered: Write the time information of system to corresponding PLC address when the trigger address bit is 1.

Synchronize time with PLC:

- Data type and length are default value.
- Read address: read information in PLC address.
- Read mode:
 - Timed: Treat the set time interval to be time unit; write the time information of system to corresponding PLC address circularly.
 - Triggered: Write the time information of system to corresponding PLC address when the trigger address bit is 1.

7.2.6 File protect of SKWorkshop

It means that whether the file requires a password to open.

- ◆ Double click the option “Protect File” in “Project Manager” to pop up a dialog box as shown in figure 7-10.



Figure 7-10 Dialog box of file protection

You can set password when file needs a password to open. Double click the option “Protect File” in “Project Manager”. Select “Use Password to Protect File” in popped-up dialog box and enter password in the corresponding column. Then, click “OK” to pop up the dialog box of password conformation.

When the user closes the project and opens it again, it will pop up the password input box shown as Figure 7-11:



Figure 7-11 Password input confirmation box

The file can be opened only when password is entered by user.

7.2.7 HMI protect of SKWorkshop

The main function of HMI protect: users can set that HMI can be used normally within a time limit; if the time set by user is exceeded, HMI will skip to the designated screen set by user in advance, making HMI cannot be used again. If you want to reuse the HMI, users have to enter the correct unlock password through the function “HMI Unlock” in function button.

- ◆ Double click the option “HMI Protect” in " Project Manager " to pop up the dialog box as shown in figure 7-12.

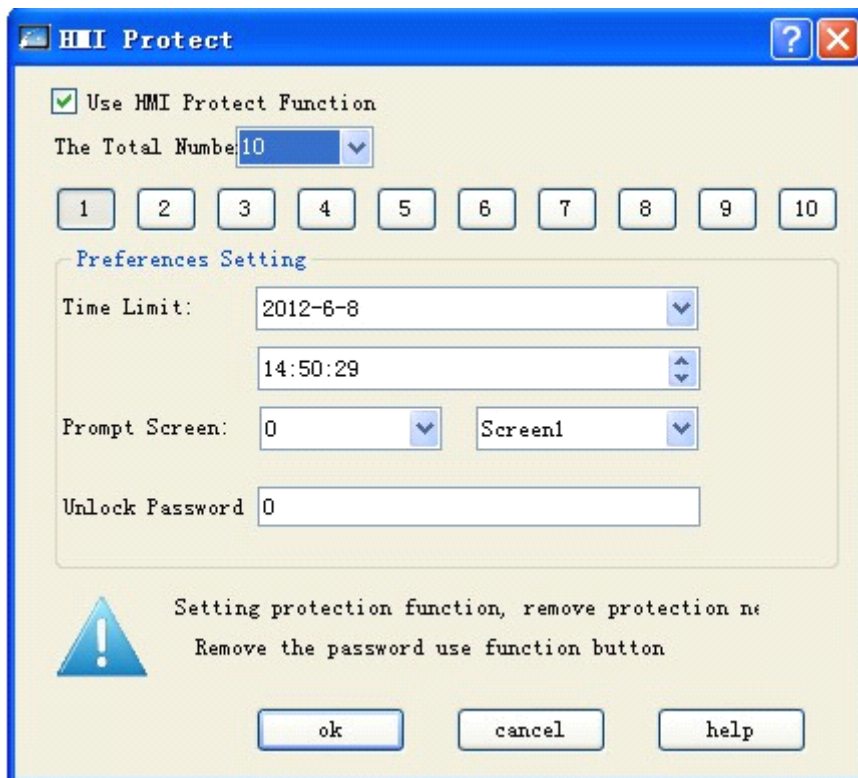



Figure 7-12 Dialog box of HMI protect

- ◆ Take an example to describe the use method of this function:
 - Select “Use HMI Protect Function”
 - Suppose the “Total Number of Password-level” is set to 3 in the dialog box; then, click 1 button icon 1 and select application date in column “Time limit” of “Parameter Setting”, suppose to be 2009-04-01; enter application

time in next column, suppose to be 12-00-00; select the prompt screen when time limit is reached in option “Prompt Screen”, suppose to be screen 1; enter unlock password in option “Unlock Protection Password”, suppose to be 1111. Now, setting of level 1 HMI protect is finished.

- As above, click 2 button icon  . select application date in column “Time limit” of “Parameter Setting”, suppose to be 2009-04-05; enter application time in next column, suppose to be 12-00-00; select the prompt screen when time limit is reached in option “Prompt Screen”, suppose to be screen 2; enter unlock password in option “Unlock Protection Password”, suppose to be 2222. Now, setting of level 2 HMI protect is finished.
- As above, click 3 button icon  . select application date in column “Time limit” of “Parameter Setting”, suppose to be 2009-04-10; enter application time in next column, suppose to be 12-00-00; select the prompt screen when time limit is reached in option “Prompt Screen”, suppose to be screen 3; enter unlock password in option “Unlock Protection Password”, suppose to be 3333. Now, setting of level 3 HMI protect is finished.
- Click "OK" when the setting of level 3 HMI protect is finished.

Suppose today is 2009-04-01 08-00-00. Therefore, the time limit for level 1 HMI protect is 2009-04-01 12-00-00. There is some time before the time limit. Therefore, HMI still can be used normally. Suppose after 4 hours, i.e. to 2009-04-01 12-00-00, HMI will automatically skip to the screen 1 set by user in advance. If user wants to continue to use the HMI and hope HMI still can operate other screens, user can add one function button in this screen (screen 1) and select the function “Unlock HMI”. When the time limit of level 1 HMI protect is reached, click the function button and enter the unlock password of level 1 protect in the popped up password entering box. Here, the unlock password is 1111.

HMI can be used normally when level 1 HMI password is unlocked. Suppose the current time is 2009-04-05 12-00-00, which has reached to the set level 2 HMI protect. Therefore, HMI will automatically adjust to set HMI protect screen (screen 2). Like previous operation, users have to use function button, select “Unlock HMI” and enter level 2 protect password (2222). Only in this way, the HMI can be used normally.

Therefore, we set level 3 HMI protect here. As above, when the time is 2009-04-10 12-00-00, to ensure the normal use of HMI, users still have to use function button, select “Unlock HMI” and enter level 3 protect password (3333).

When password of 3 levels has been unlocked, HMI protection is invalid and HMI can be used normally.

Examples are taken above to describe the operation of HMI protect function. Operation for setting of different password levels is similar. Users can refer to above descriptions.

7.2.8 Variable table control of SKWorkshop

Variable setting: the definition tag corresponds to one address. When the tag is used, it means the corresponding address of tag is used. To configure the variable setting, double click the “variable table” in the “project manager”, and pop up the dialog box as Figure 7-13:

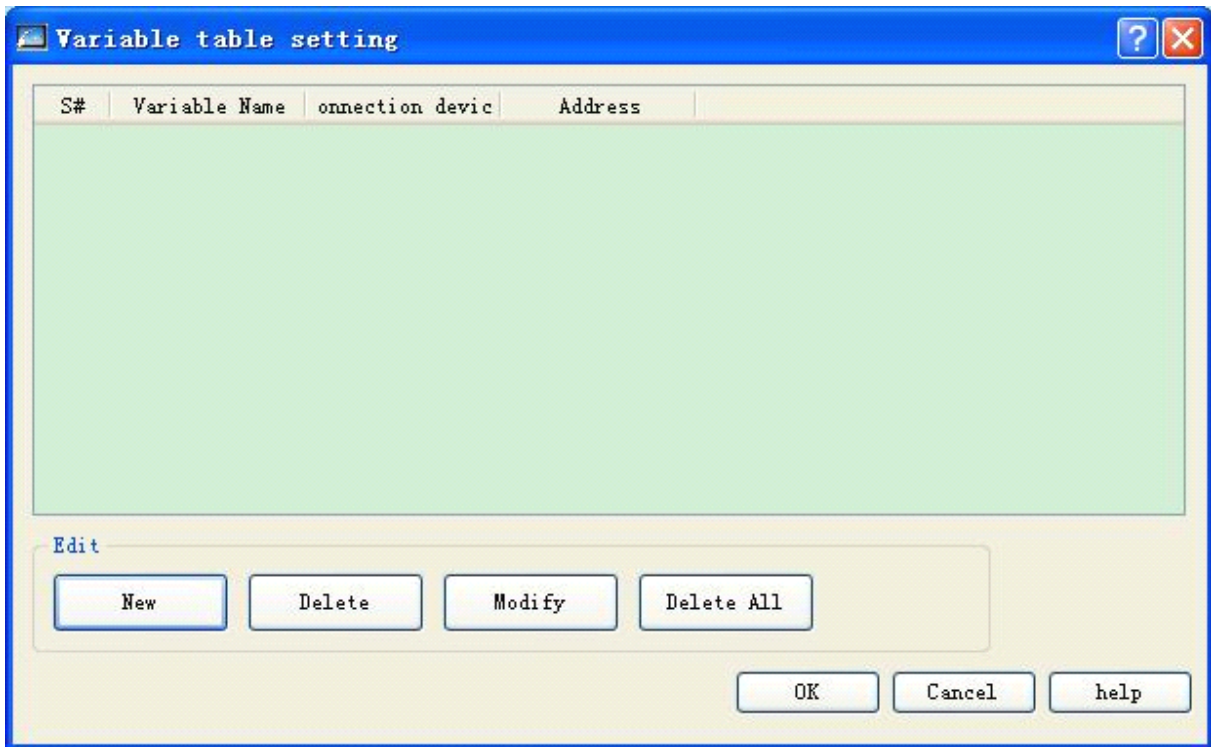

Figure 7-13 Dialog box of variable table setting

- Add: add a new variable tag.
- Delete: delete the selected variable tag.
- Modify: modify the variable tag, or double click the selected variable tag.
- Delete all: delete all variable tags.

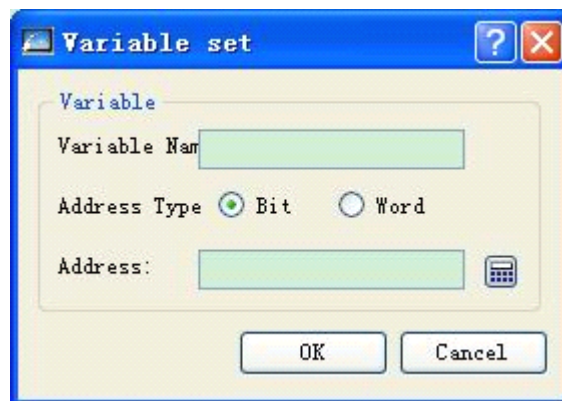

Figure 7-14 The dialog box of new creating a bit-control screen switching

- Variable name: set the name of new variable.
- Address type: select the data type of address.
- Address: select the connection address.

7.3. Screen of SKWorkshop

Screen operation means to operate page. Create a new screen operation, as shown in figure 7-15.

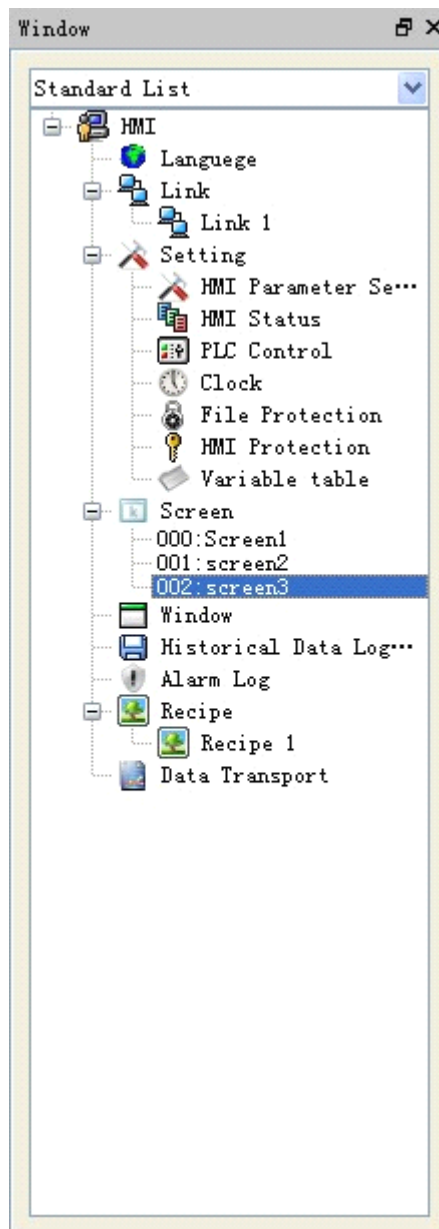

Figure 7-15 Screen option of right Key

Click the root “Screen” with right key. Then, click “Add Screen” in popped up menu to pop up the dialog box of new screen. In this dialog box, set “Screen Name” and “Background Color”. Then, click "OK" to add one screen.

There are two ways to open other screens: 1. double click screen name in “Project Manager”; 2. click screen name with right key and select “Open” in popped up menu.

Delete screen: click screen name with right key and select "Delete" in popped up menu to delete the screen.

View screen attribute: 1. click screen name with right key and select “Attribute” in popped up menu to pop up dialog box of attribute setting; or 2. select “Screen Attribute” in option "Screen" of menu bar to view or modify.

Copy screen: right click the screen name, and select “copy” in the pop up screen to copy the screen; set the new screen name and click “confirm” to complete.

7.4. Window of SKWorkshop

Method of adding new window is same to that of adding new screen. The operation of "Open", "Delete" or "View Window Attribute" is also same to that of screen. Users can refer to previous screen operations. The dialog box of window attribute setting is as shown in figure 7-16.

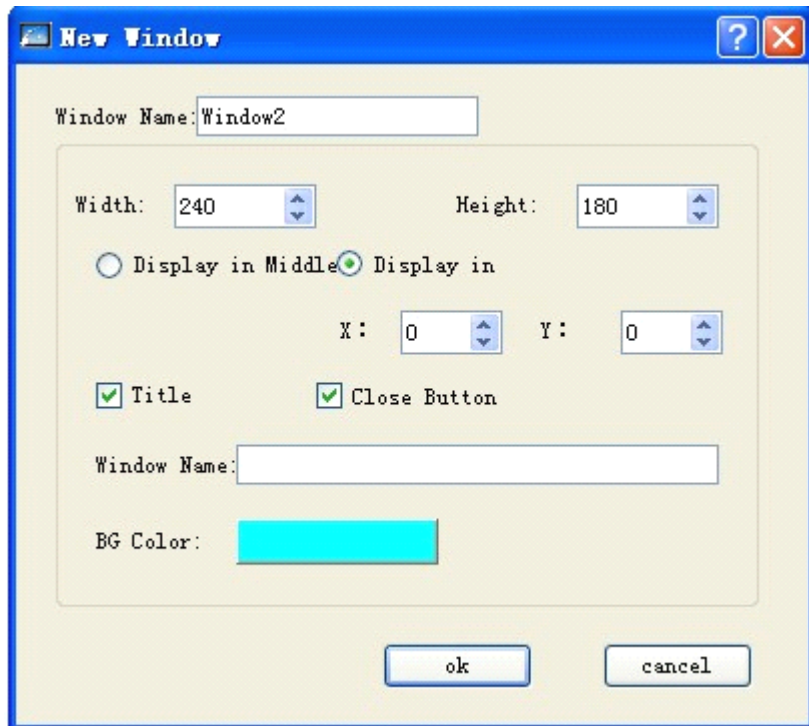

Figure 7-16 Dialog box of Window attribute

Height and width: Respectively used to set the height and width of window.

Display in middle: The popped up window displays in the middle of HMI.

Display in: When the option "Display in" is selected, the window displays in the location with X coordinate and Y coordinate points set by user. The origin of coordinates is upper left corner of HMI screen.

Title: Select the option "Title" and enter title name in column "Title Name" to pop up a window with title bar.

Close button: Whether the window has button for closing.

Background color: Used to change the background color of window.

7.5. Historical data collector of SKWorkshop

"Historical Data Collector" is used together with "Historical Record Displayer" in toolbar. The former one is mainly used for parameter setting and the latter one is used to display the accessed historical data.

If no new "Historical Data Collector" has been established, you can create a new one, just like creating a new screen, i.e. click "Historical Data Collector" with right key and select "Add Historical Data Collector" in popped up menu to create a

new historical data collector (notice: only one historical data collector can be newly created at most. Otherwise, the error prompt box will be popped up). Double click “Historical Data Collector 0” in "Project Manager" to pop up the dialog box as shown in figure 7-17.

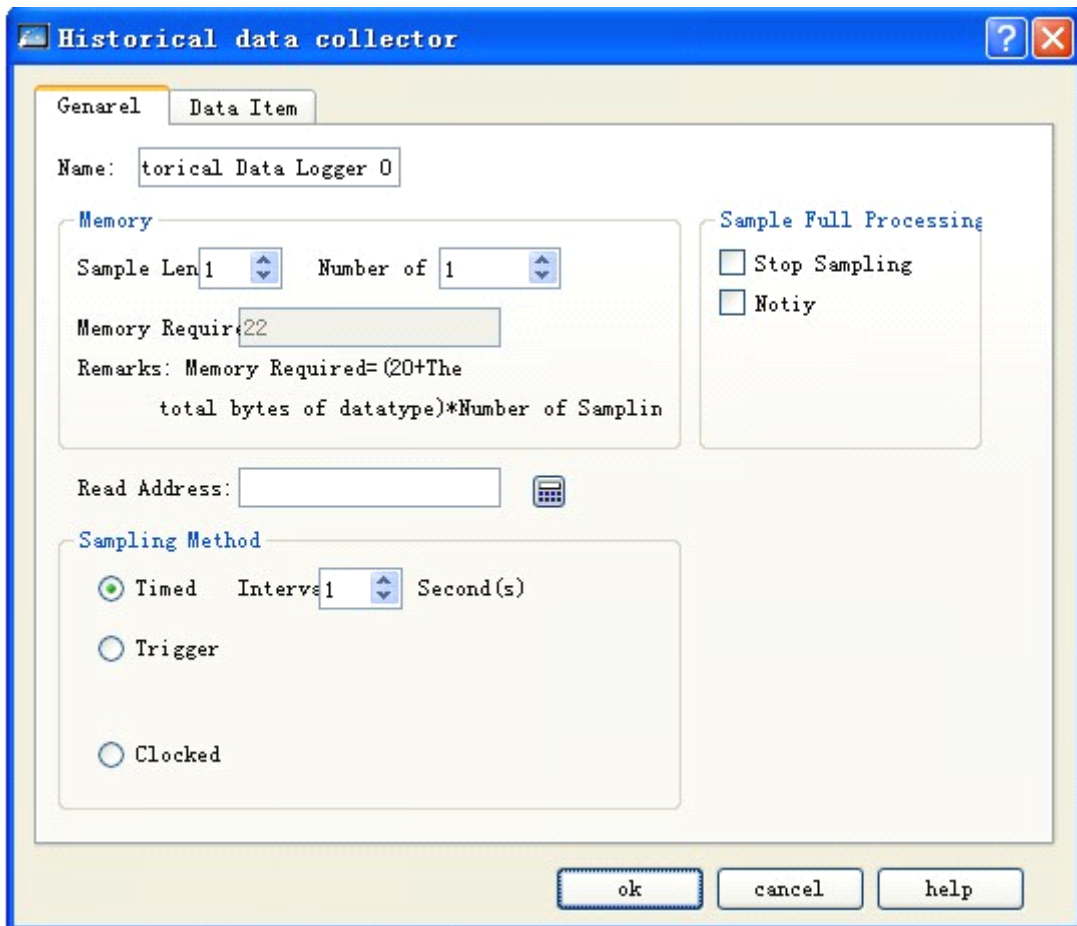

Figure 7-17 Dialog box of historical data collector

- Name: user can change the name displayed in project manager as required.
- Sample length: number of data read from memory each time.
- Number of sampling: times of data extraction.



The method to calculate the required memory: $\text{required memory} = (20 + \text{total bytes of data types for all data items}) * \text{total samples}$

Wherein, “20” refers to the total bytes of time or date;

“Total bytes of data types for all data items” refers to the sum of data type of selected address on the “data item” page.

The example is shown as Figure 6-14:

- Supposing the data type of each item is a 16-bit positive integer, the total bytes of data types for all data items should be $2+2+2+2+2$. That is to say, the total bytes of data types for all data items are equal to 10. Then, the

required memory is $(20+10)*2=60$. Wherein, 16-bit data type occupies 2 bytes, and 32-bit data type occupies 4 bytes.

b. Supposing the data type of LH1 and LH3 is a 32-bit positive integer (when the data type of LH1 and LH3 is a 32-bit positive integer, the address on "data item" page is arranged as LH0, LH1, LH3, LH5, LH6), the total bytes of data types for all data items should be $2+4+4+2+2$. That is to say, the total bytes of data types for all data items are equal to 14. Then, the required memory is $(20+14)*2=68$.

- Read address: read initial address of data (be introduced in details in page "Data Item").
- Sampling method:
 - √ Timed: start to read data with time interval set by user.
 - √ Triggered: start to read data when the trigger address value is 1.
 - √ Clocked: start to read data with time interval set by user.
- Sample full processing
 - √ Stop sampling: if this option is selected, when the sampling times is equal to the set "Number of Sampling", stop reading data from memory. If this option is not selected, when the sampling times is equal to the set "Number of Sampling", continue to read data from memory. However, the last group of data will be removed, and the new acquired data will be added behind.
 - √ Notice: when current sampling current is "Full Limit" of total sampling time, inform to set address to 1.

Click the tab "Data Item" to set attributes of the page, as shown in figure 7-18.

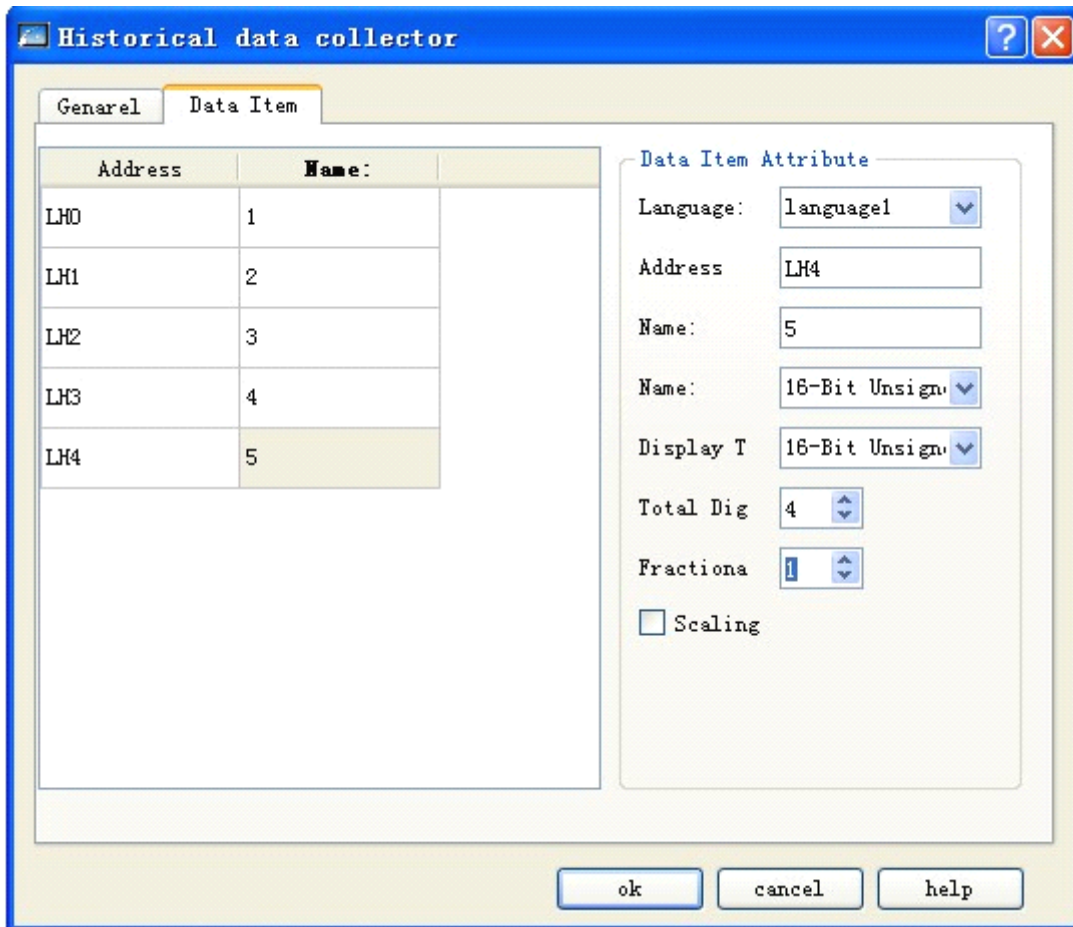

Figure 7-18 Data item of historical data collector

User can set the corresponding attribute for the item in right “Data Item Attribute” through clicking each item in list box. Following, we take example to describe it in details.

If user sets read address to LW1 and sample length to 5 in page “General”, after clicking the tab “Data Item”, five columns of data are added in the list box. Content of address column is LH0-LH4 and name column is empty. User can click each line firstly and then set name, data type, display type, total digits, fractional digits, scaling or not and other attributes for each item in right “Data Item Attribute”.

Suppose name of LH0-LH4 is set as shown in figure 6-14; the data type and “scaling” or not of LH0-LH4 are set as follows (other attributes are default value):

- LH0-16 positive integer select scaling, gain 3, offset 2
- LH1-32 positive integer select scaling, gain 2, offset 1
- LH2-16 integer not select scaling
- LH3-32 integer not select scaling
- LH4-floating number select scaling, gain 4, offset 5

After completion of setting, we have set “Read Address” to be LW1 and “Sample Length” to be 5 in general page previously. Therefore, we have to read five groups of address value continuously starting from “Read Address”. The concrete address to be read depends on the data type of each item in page “Data Item”.

If the data type of each item is set to 16 digits, the sampled address is continuous; if data type is 32 digits, the sampled address is discontinuous. If “Scaling” is selected for some item, the finally sampled value = read address value × gain + offset.

If the data type and scaling of each item has been set, addresses to be read are respectively as follows:

LH0-LW1 (16-digit data, read address +1) LH0 final value = LW1 address value ×3+2

LH1-LW2 (32-digit data, read address +2) LH1 final value = LW2 address value ×2+1

LH2-LW4 (16-digit data, read address +1) LH2 final value = LW4 address value

LH3-LW5 (32-digit data, read address +2) LH3 final value = LW5 address value

LH4-LW7 (32-digit data, read address +2) LH4 final value = LW1 address value ×4+5

Click “OK” after the completion of setting. Click the icon “Historical Record Displayer” in toolbar and set the display line to be 5 in popped up dialog box. Values of all other attributes are default value.

A table will generate automatically in screen after clicking "OK", as shown in figure 7-19.

Time	Date	kui	看	3	4	5

Figure 7-19 Display data table in historical data collector

Above table has following applications:

- √ Date: read date of some address value.
- √ Time: read time of some address value.
- √ Column “kui”: display value of LW1 address read at some time.
- √ Column “View”: display value of LW2 address read at some time.
- √ Column 3: display value of LW4 address read at some time.
- √ Column 4: display value of LW5 address read at some time.
- √ Column 5: display value of LW7 address read at some time.

For example, the read address is LW2; the sampling length is 3; the sampling sum is 10; the time interval is 1 s when “sampling mode” is “time” triggered; each data type on the “data item” page is defaulted.

✓ When the “stop sampling” in “disposal as full” is not selected,

it will read LW1, LW2 and LW3 once every other 1 second. As the total sampling is 10 groups, it reads out 10 groups of data at the 10th second. As the “stop sampling” is not selected, it will continue to read data. As the three properties of “sampling

length”, “sampling sum” and “data type” needs a fixed memory to save the data, when the data group reaches to “sampling sum”, the first acquired data is removed and the latter data will move up in sequence. At last, the new acquired data will fill in the last item (this is similar with 10 people queuing for tickets. If one people got the ticket and left, a new one will queue at the least. But the total people remain 10 people).

- ✓ When the “stop sampling” in “disposal as full” is selected, the only difference is that it will read data no longer if the acquired data reaches to sampling sum.

To view the acquired data visually, the two controls as “[historical trend chart](#)” or “[historical data display](#)” on the tool bar can be used.

7.6. Alarm setting of SKWorkshop

Let’s come to SKWorkshop alarm setting. SKWorkshop alarm setting includes digit alarm login and analogy alarm login. When the alarm login is set, the users may view the alarm category and alarm time and date by alarm control or dynamic alarm bar.

7.6.1 Digital alarm log of SKWorkshop

Alarm setting is used to display alarm information. Alarm controls and dynamic alarm bar (In fact, alarm controls and dynamic alarm bar respectively display the alarm information of "Digital Alarm" and “Analog Alarm”) can be used normally only when alarm setting is configured. It can set up 10 items of digit alarm information at most.

- Select “Alarm Log” in project manager to set digital alarm and analog alarm, as shown in figure 7-20.

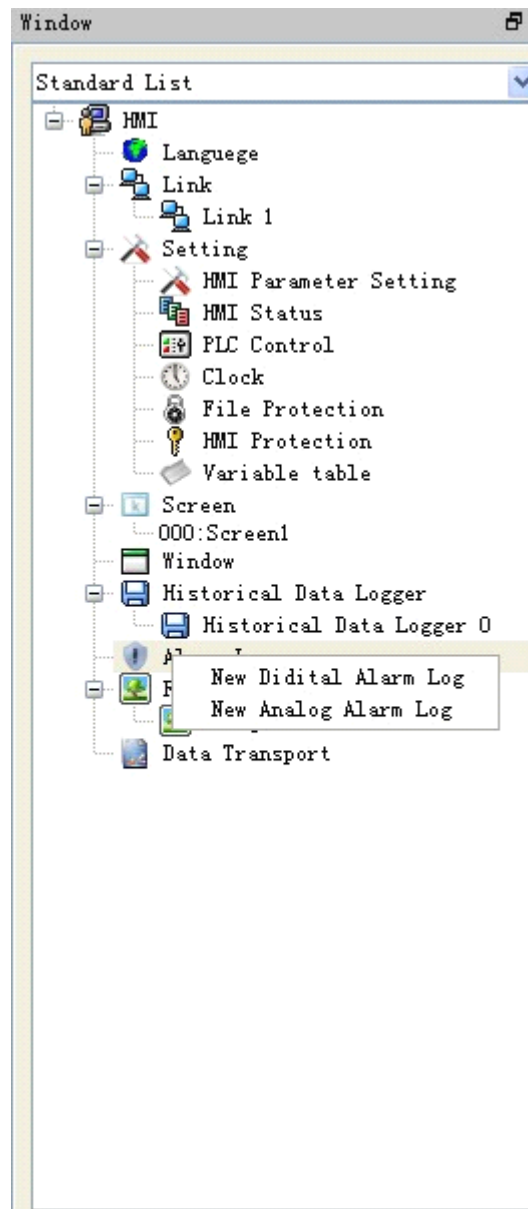

Figure 7-20 Select alarm log

- Double click the option “Digital Alarm Log” in unfolded option of alarm log to open the dialog box of digital alarm setting, as shown in figure 7-21.

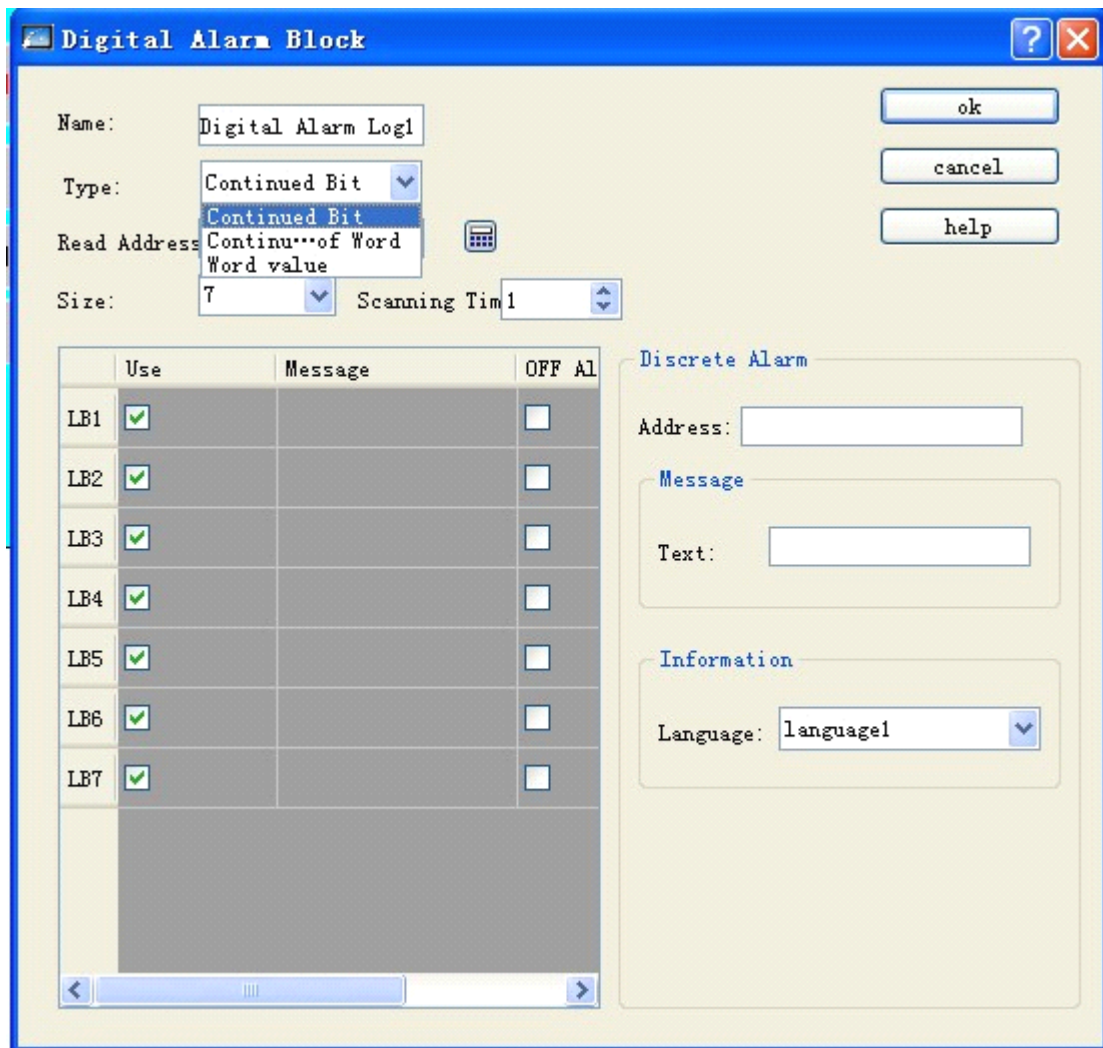

Figure 7-21 The dialog box of digit alarm at “continuous digit”

The operation step of digital alarm is as follows:

- Firstly, enter the bit address to be alarmed in column “Read Address”. Suppose it is set to internal address LB1 here.
- Select total number of alarms in option “Block Size”, i.e. total number of digit addresses, which are continuous here. Suppose the length is set to be 6 here.
- Users can set the “Scanning time” of digit alarm as required, i.e. scanning frequency.
- Click some option in list box. Then, move mouse to the edit box “Text” in right module “Message” and enter text information in it, i.e. alarm content. Suppose information set here (i.e. alarm content) is as shown in figure 6-17.
- Meaning of option “Use”: if the option “Use” of some item is selected, the alarm information can be displayed in “Alarm Controls” or “Dynamic alarm bar” only when the corresponding address of the item is 1; if the option “Use” of some item is not selected, the alarm information will not be displayed in “Alarm Controls” or “Dynamic alarm bar” even if the corresponding address of the item is 1; if the item address is 0, the alarm information will not display in " Alarm Controls " or “Dynamic alarm bar” no matter the option "Use" is selected or not.
- OFF alarm: if the option is selected, it will make alarm when the corresponding address is 0 (OFF value); otherwise it makes alarm when the address is 1 (ON value). It defaults to make alarm while the address is 1 (ON).

Let’s take an example. Suppose the “continuous digit” is selected as type.

- Suppose LB1 address value is 0, the alarm information will not display in " Alarm Controls " and "Dynamic alarm bar" no matter the option "Use" is selected or not.
- Suppose LB1 address value is 1 and option "Use" is not selected, the alarm information will display in neither "Alarm Controls" nor "Dynamic alarm bar".
- Suppose LB1 address value is 1 and option "Use" is selected, the alarm information will display in both "Alarm Controls" and "Dynamic alarm bar".
- Click "OK" to finish the setting of digital alarm. Users can make six digit buttons, the addresses of which are respectively LB1-LB6 and all function of which is selected to "Alternative". Put one "Alarm Controls" and one "Dynamic alarm bar" controls on screen and carry out off-line simulation for them. Click some digit button to see whether alarm information is displayed in "Alarm Controls" and "Dynamic alarm bar".

The example of off-line simulation is carried out as shown in figure 7-22.

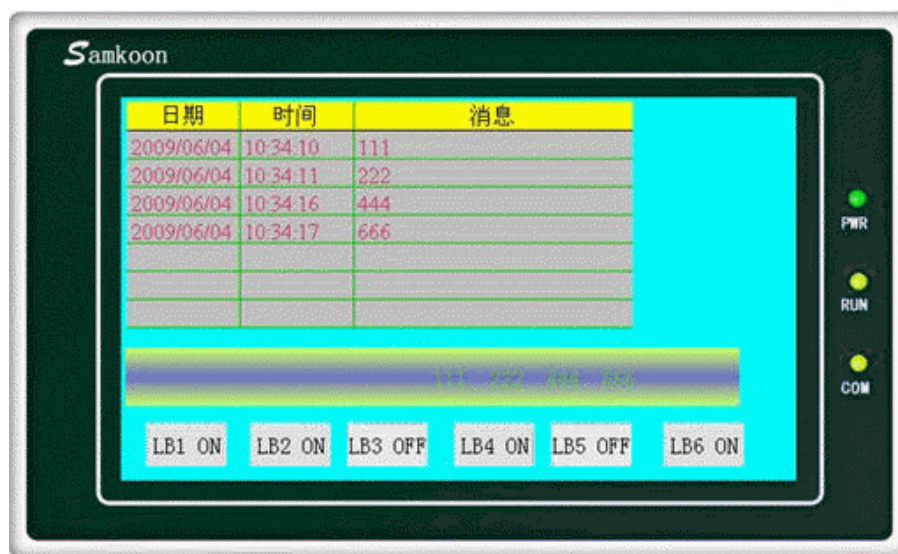

Figure 7-22 Off-line simulation example of digit alarm

If the type is "continuous digit", it is shown as Figure 7-23:

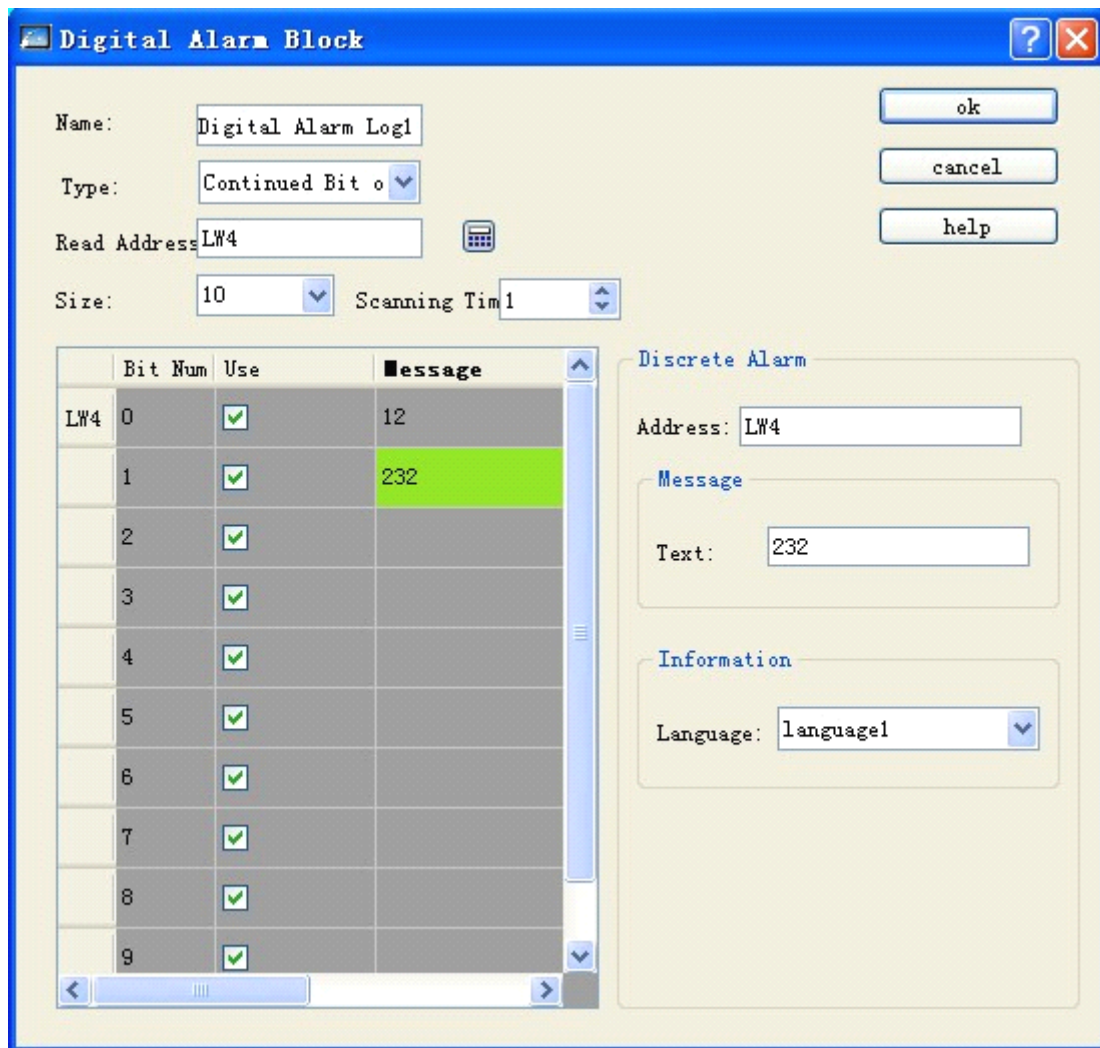

Figure 7-23 The dialog box of digit alarm at “continuous digit”

- ◆ That is to say, when a “digit number” (bit number) of the address is used, it makes alarm at bit 1.

If the type is “word value”, it is shown as Figure 7-24.

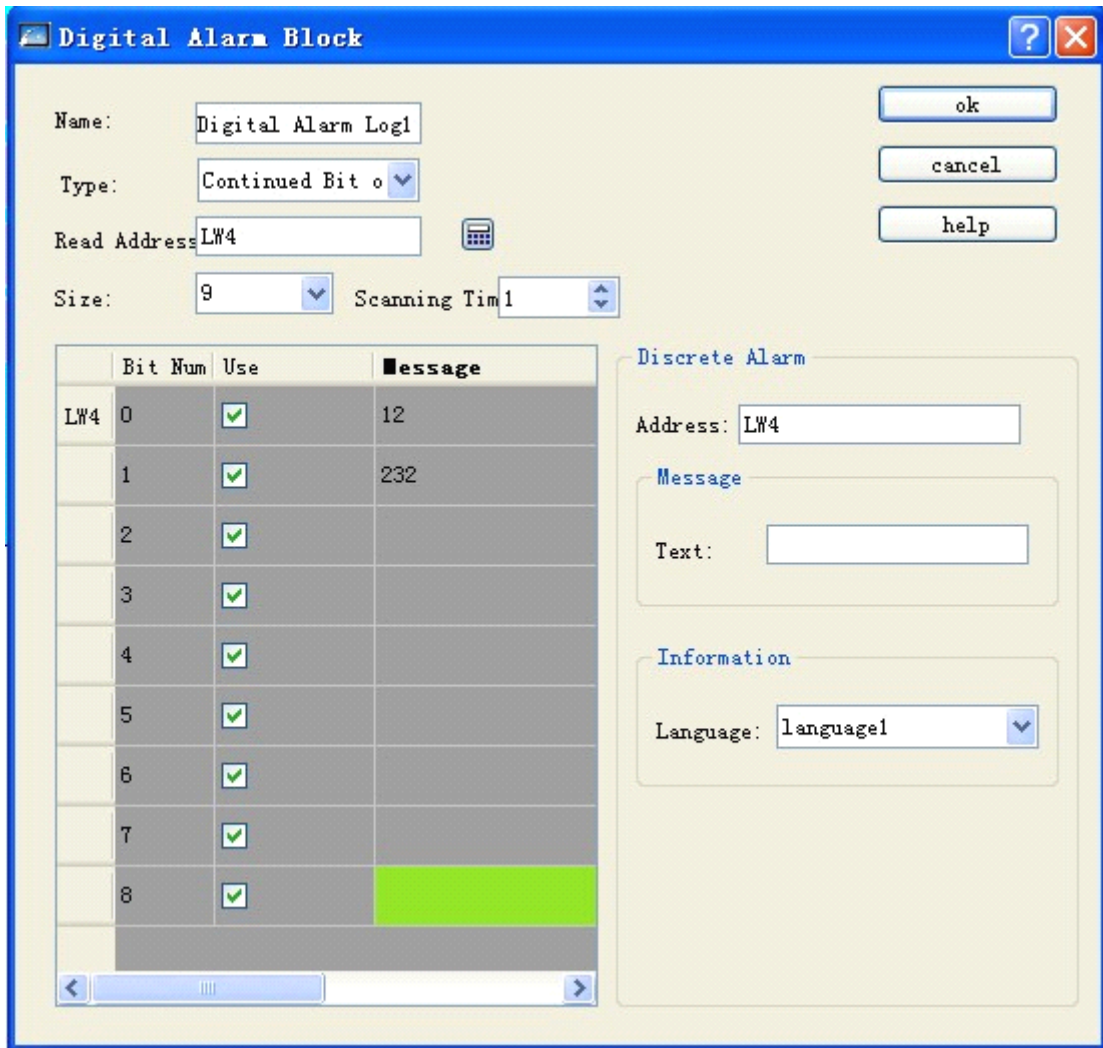

Figure 7-24 The dialog box of digit alarm at “word value”

- ◆ That is to say, when a value of the address is used, it makes alarm while the address value is equal to the value selected in the table.

In figure 7-22, an "Alarm Controls" is put in screen. The number of its text lines is set to 7 and other attribute values are default. Then, a "Dynamic alarm bar" is put. Its attribute setting is as shown in figure 7-25.

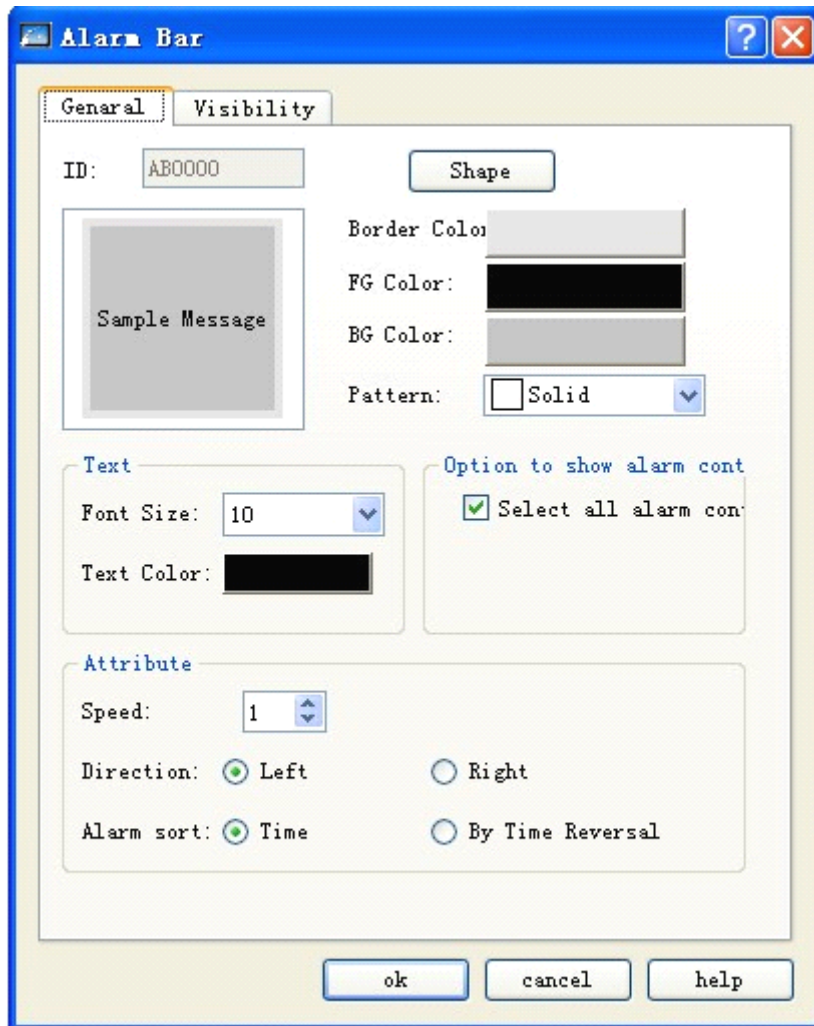

Figure 7-25 Dialog box for attribute setting of dynamic alarm bar

Six digit button controls are put finally. The write address of digit button controls is LB1-LB6. And “Alternative”, “Monitoring” and “Monitoring address is same to write address” are set for each digit button controls. After completion of setting, click the button “Save” in toolbar to save the project. Operate the option “Off-line Simulation” in “Download” in menu bar and click digit buttons of addresses LB1, LB2, LB4 and LB6. Then, you can see that the alarm information of LB1, LB2, LB4 and LB6 in “Digital Alarm” is displayed in both “Alarm Controls” and “Dynamic alarm bar”. When click LB1, LB2, LB4 and LB6 again, all values of them are 0 due to “Alternative” function set for digit button. And the alarm information of LB1, LB2, LB4 and LB6 in “Digital Alarm” is displayed in neither “Alarm Controls” nor “Dynamic alarm bar”.

- **Language:** It can input different alarm information for different languages. When the users employ “language switching” function in the “function button”, it can switch to the defined language.

7.6.2 Analog alarm log of SKWorkshop

Double click the option “Analog Alarm Log” in unfolded option of alarm log to open the dialog box of analog alarm setting, as shown in figure 7-26.

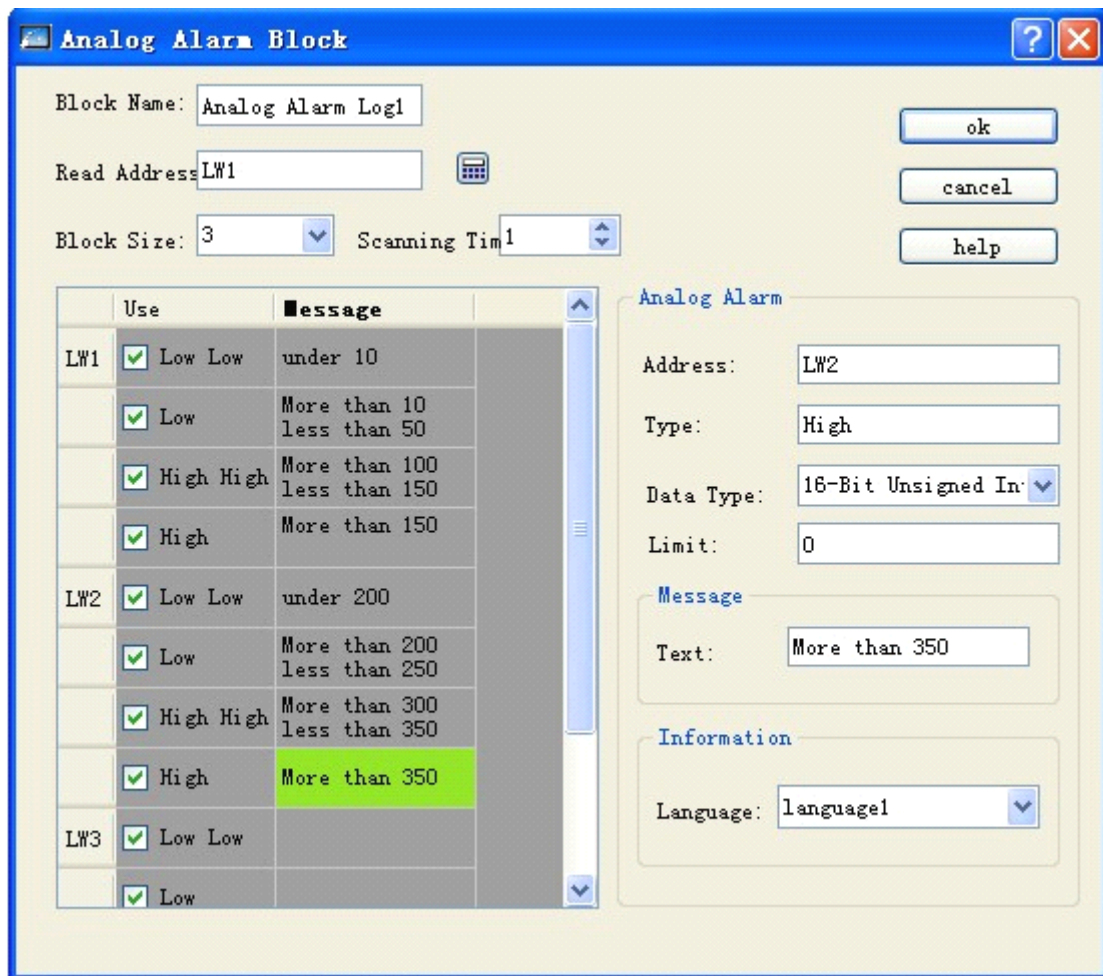

Figure 7-26 Dialog box of analog alarm log

If users need analog alarm, the operation step of is as follows:

- Firstly, enter the address to be alarmed in column “Read Address”. Suppose it is set to internal address LW1 here.
- Select the total number of alarms in option “Block Size”, i.e. total number of addresses. The mode of read address has something to do with data type selected by users. In the beginning, each address is default to 16-digit data type. The initially read address is continuous. But users can alter the data type of each address. As shown in figure 6-20, LW1 address value is selected to 32-digit positive integer and both LW3 and LW4 are 16-digit positive integer. Therefore, when selecting 32-digit data for some address, the address read following is equal to previous address plus 2; if 16-digit data type is selected, the address read following is equal to previous address plus 1.
- Users can set the “Scanning Time” of analog alarm as required, i.e. scanning frequency.
- Click every item in list box. Move mouse to right “Limit” and enter one data into it. Then, move mouse to the edit box “Text” in right module “Message” and enter the corresponding text information in the box, i.e. alarm content. Suppose the information set here (i.e. alarm content) is as shown in figure 7-24. From this figure, we can see that each address value can be divided into 4 areas (i.e. data subarea of alarm address): low low, low, high and high high. In following content, we take address LW1 for example to describe the meaning of these 4 areas (all the option “Use” for four options of address LW1 is selected), as shown in figure 7-27.

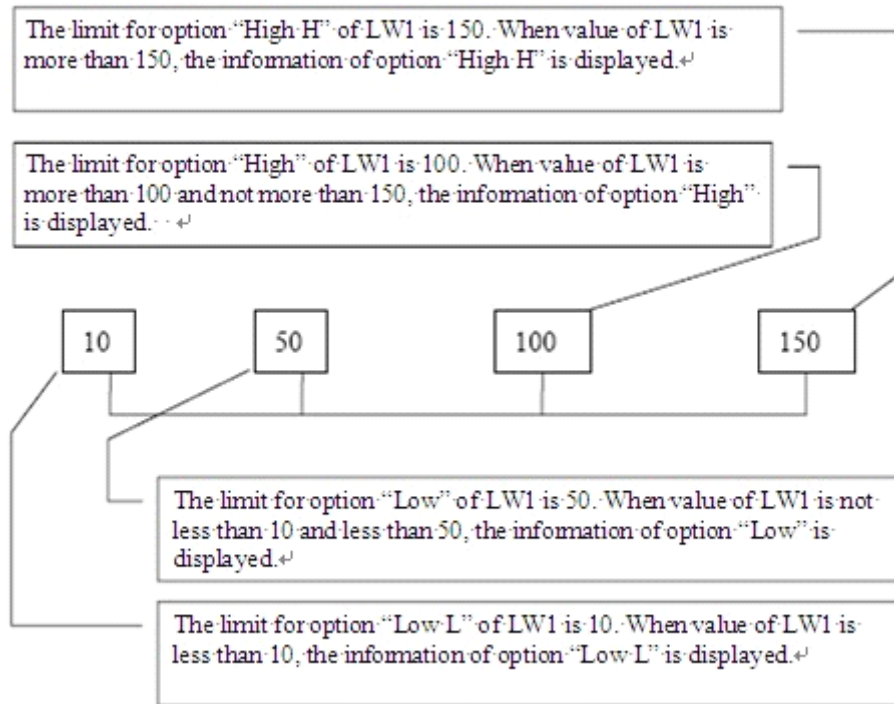



Figure 7-27 Area division of four address values of LW1

- √ Low L: when the address value of item is less than its limit and option "Use" is selected, the alarm information of the item is displayed in "Alarm Controls" or "Dynamic Alarm".
- √ Low: when the item value is equal to or greater than the limit for option "Low L" and is less than limit for option "Low" and the option "Use" is selected, the alarm information of the item is displayed in "Alarm Controls" or "Dynamic Alarm".
- √ High: when the item value is more than limit for option "High" and less than or equal to limit for option "High H" and the option "Use" is selected, the alarm information of the item is displayed in "Alarm Controls" or "Dynamic Alarm".
- √ High H: when the address value of item is more than its limit and option "Use" is selected, the alarm information of the item is displayed in "Alarm Controls" or "Dynamic Alarm".
- Click some item in list box. The meaning of option "Use" selected or not is same to that in "Digital Alarm Log". Users can refer to "Use" in "Digital Alarm Log"

7.7. Alarm display controls of SKWorkshop

Select  in toolbar and set the display content and parameter of alarm bar in its dialog box, as shown in figure 7-28.

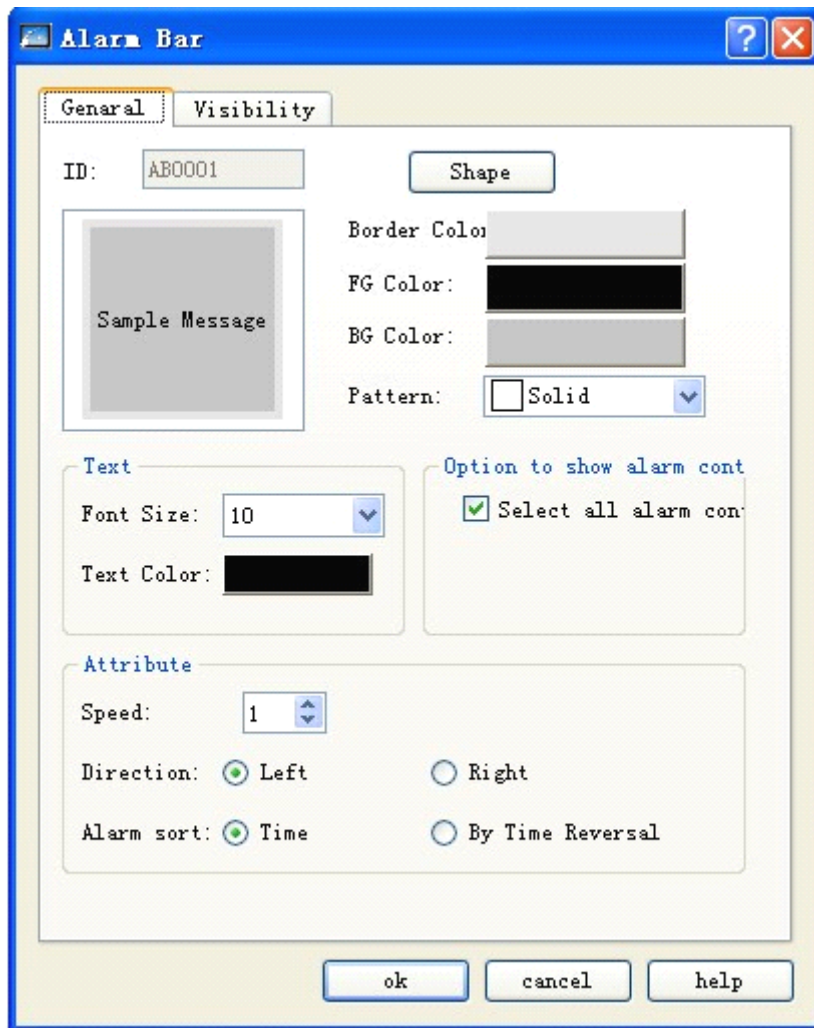

Figure 7-28 Dialog box of alarm bar

- Speed: movement speed of alarm content;
- Direction: select the movement direction of alarm bar: from right to left or left to right;
- Alarm sort: select the time sort of alarm content.

Select alarm controls in toolbar and set the content and parameter of alarm display in its dialog box, as shown in figure 7-29.

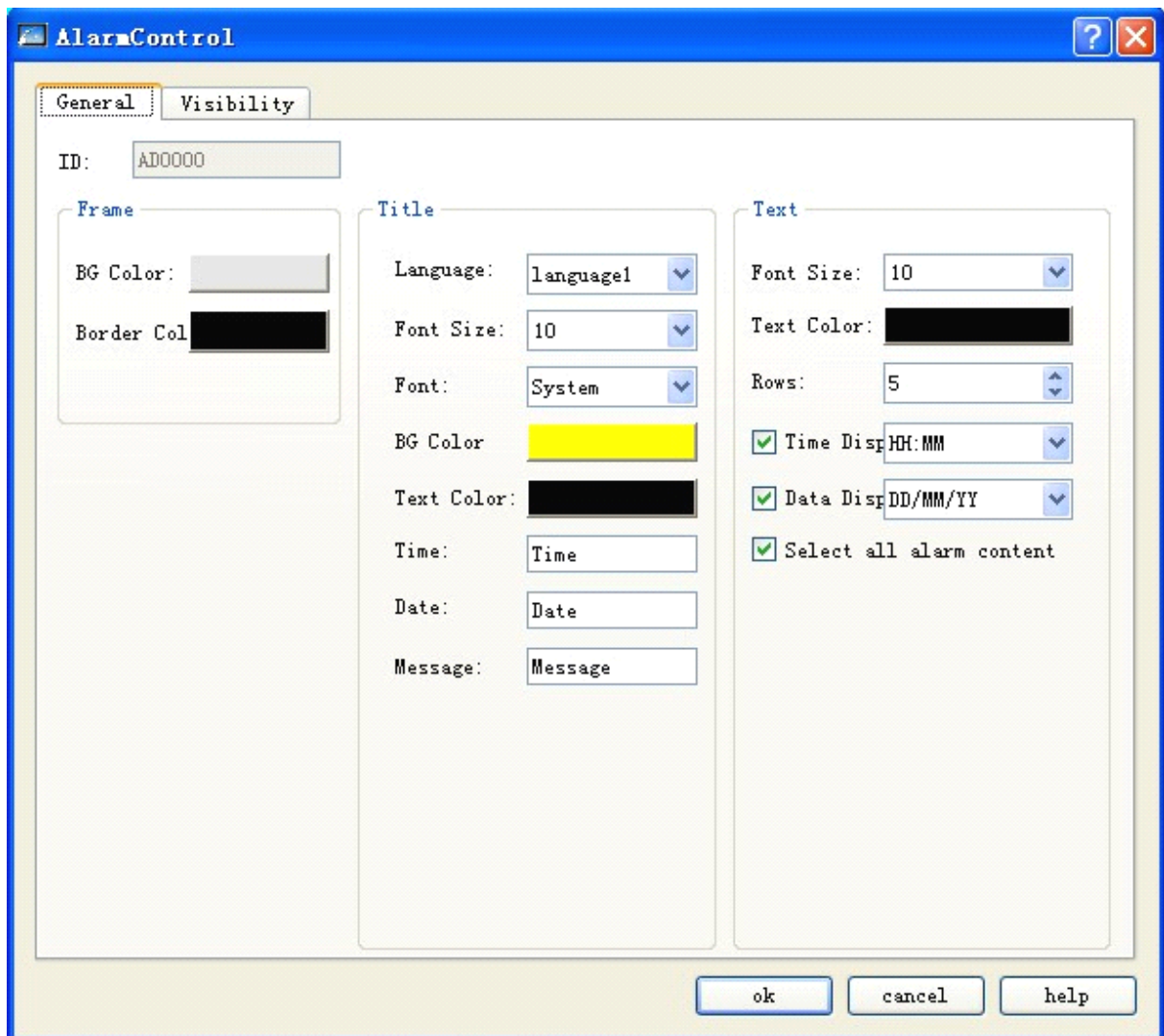

Figure 7-29 Dialog box of alarm controls

7.8. Recipe configuration of SKWorkshop

In manufacturing field, recipe describes the proportional relation of different ingredients used for production of some product, which is a set of parameter setting values corresponding to some variables during manufacturing. For example, the bakehouse has a basic ingredient recipe for bread production, which lists all compositions used during bread production (e.g. water, flour, sugar, egg and sesame oil, etc.) and all optional ingredients (e.g. fruit, nutlet and chocolate chips, etc.). All of these optional ingredients can be added to basic recipe to produce various kinds of bread. For another example, in steel plant, a recipe may be a set of machine parameter setting. For batch processing device, one recipe may be used to describe different steps during batch processing.

One device can be used to produce bread and also cake. The bread includes sweet one and salty one. Cake has cream one and chocolate one. Here, the proportional relation of ingredients for bread manufacturing is called recipe and the proportional relation of ingredients for production of salty or sweet bread called one file. It is clear that the recipe record is included in recipe file.

The function of recipe configuration is provided in SKWorkshop. You can enter the dialog box of recipe configuration through recipe setting in menu bar or recipe in project manager, as shown in figure 7-30.

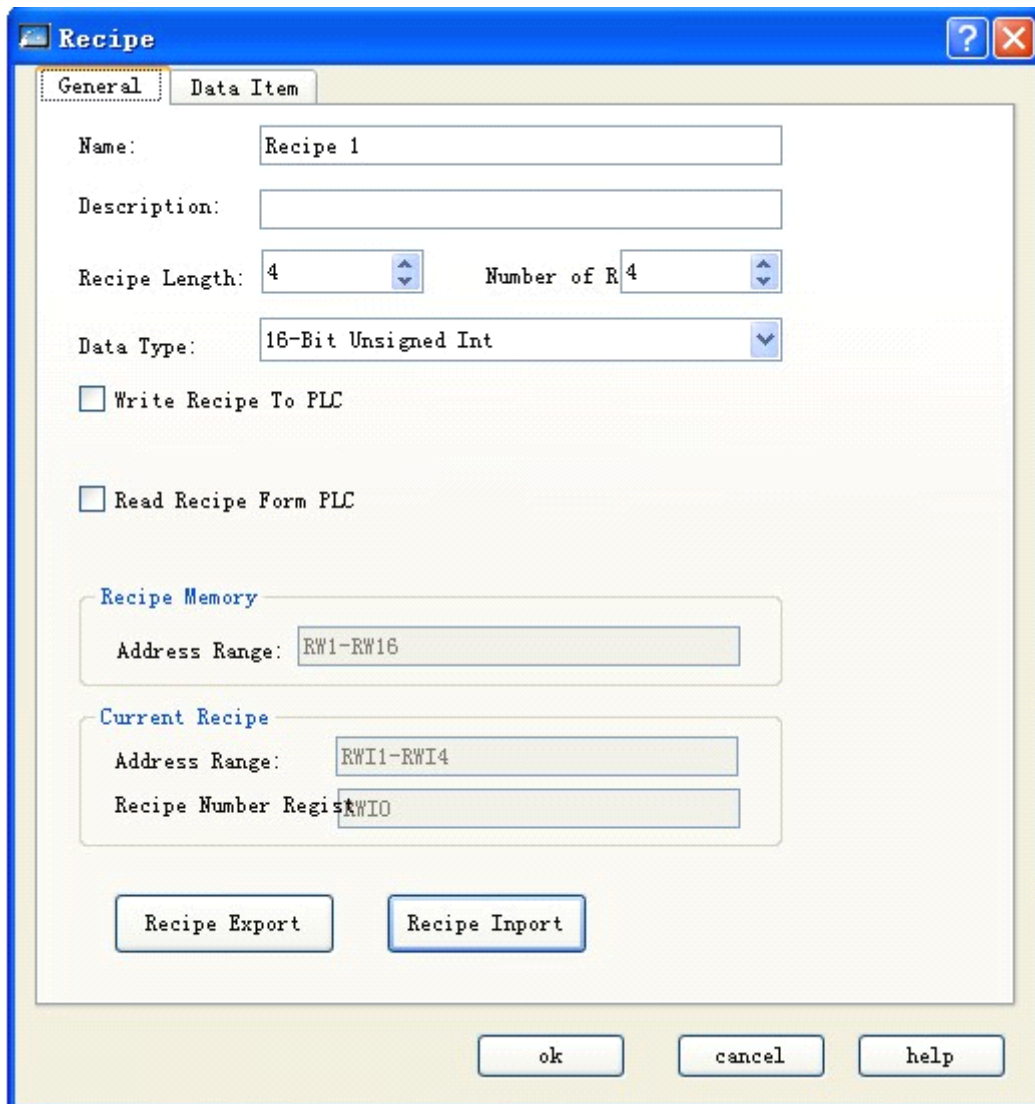

Figure 7-30 Dialog box of recipe attribute setting

- √ Name: Name of current recipe file; only one group of file is supported temporarily;
- √ Description: Name description and explanation of current recipe file;
- √ Recipe length: Length and quantity of current recipe read record address. Address of recipe record table is sorted in order, which is generated by system automatically and cannot be changed. The number of address can reach up to 4096;
- √ Number of recipe: Recipe quantity, which can reach up to 512;

Note: recipe length * data type bytes * recipe sum =512KB

- √ Data type: Data type of data register;
- √ Write recipe to PLC: Set address of related data register of recipe and PLC;
- √ Read recipe from PLC: Set address of related data register of recipe and PLC;

- √ Recipe memory: Memory addresses range of recipe in HMI, which is generated automatically and cannot be changed;
- √ Current recipe: Both memory address in HMI and data register in PLC of recipe are generated automatically in order, which cannot be changed;
- √ Recipe number register: Recipe number is generated automatically in order and cannot be changed, which corresponds to the order of recipe name in data item.

The recipe data item is as shown in figure 7-31:

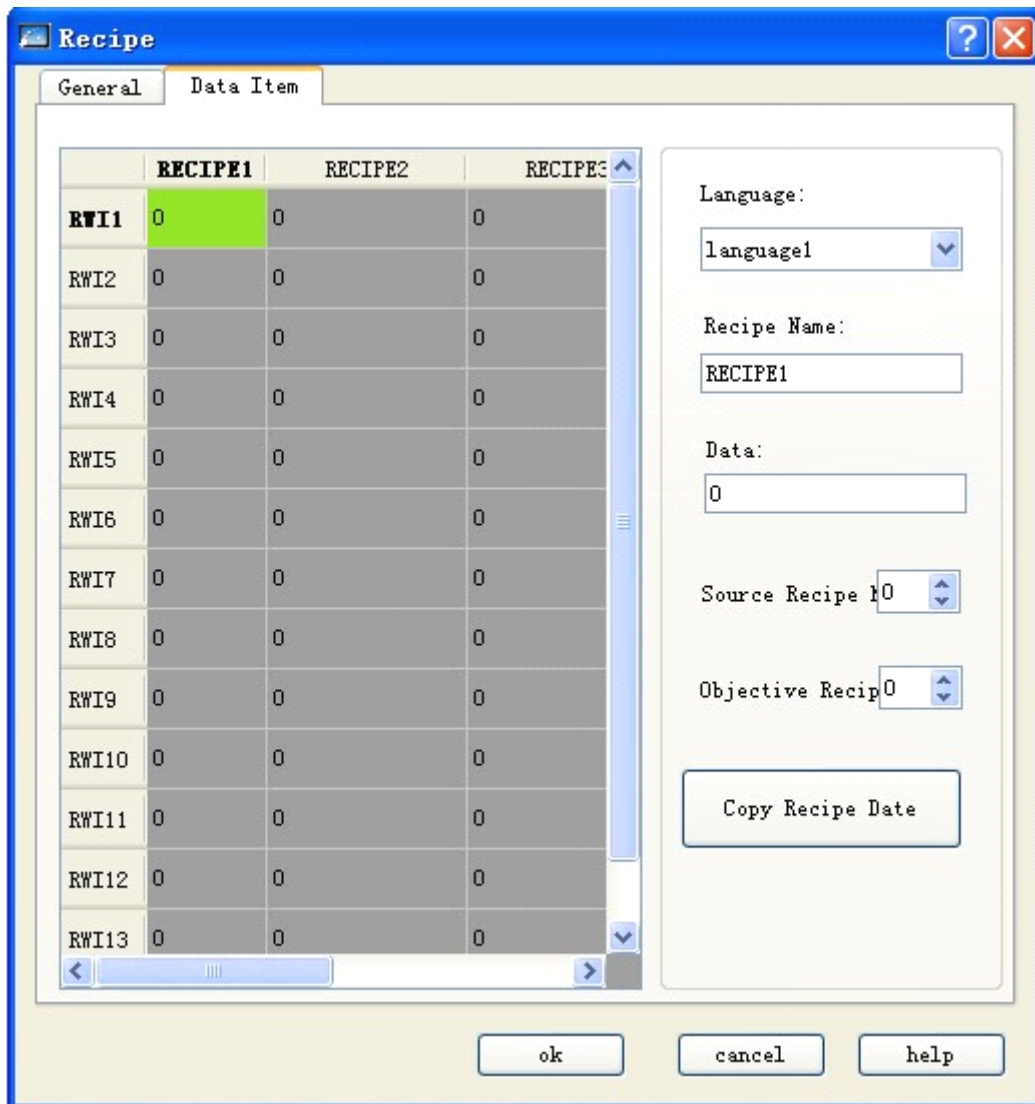

Figure 7-31 Screen of recipe data item

- √ Name: Name of current recipe;
- √ Data: Data write and display of each address in current recipe;
- √ Copy recipe data: Copy data in source recipe number into objective recipe number; after entering, click “OK” to save current recipe; click “Cancel” to exit current dialog box. After the completion of recipe configuration, you can design screen and operate recipe in HMI.

Example of concrete recipe application:

1. Establish recipe configuration according to above mentioned method, as shown in figure 7-32 below.

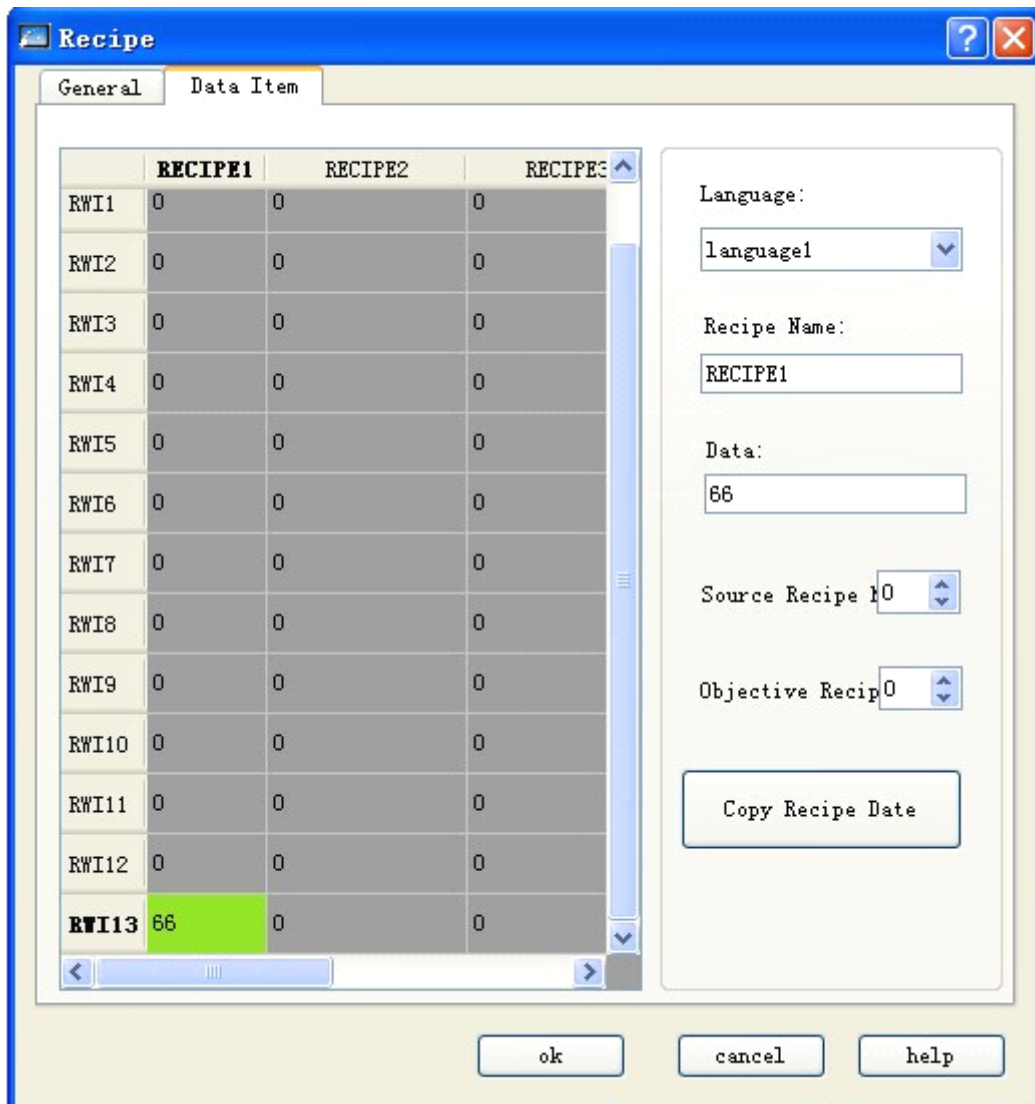



Figure 7-32 Function of recipe data copy

This recipe includes 4 sub-recipes in all. Each recipe has 16 members. The store address is memory addresses RWI:1-RWI:16 of HMI.

2. After completion of recipe configuration, display recipe on screen and carry out alteration, or directly download recipe to PLC. Therefore, the following several important function controls will be used.

√ Recipe display: click value display/input . For operations, please refer to "Value Display/Input".
 Select address of internal memory area to be RWI:0. You can create controls of value display and input on screen. Value of input and display is just recipe number. If value of RWI0 is 0, it means that the recipe number is 1; if value is 1, the recipe number is 2, and so forth.

√ Click function button : for operations, please refer to "Function Button".

Through related function setting in function button, buttons as Write Recipe to PLC, Read Recipe from PLC, Save Recipe, Previous Recipe and Next Recipe can be established on screen.

3. The screen shown in figure 7-33 can be finished as per above mentioned operations:

If all addresses written into monitoring are D0, recipe length is 16 and total number is 4.

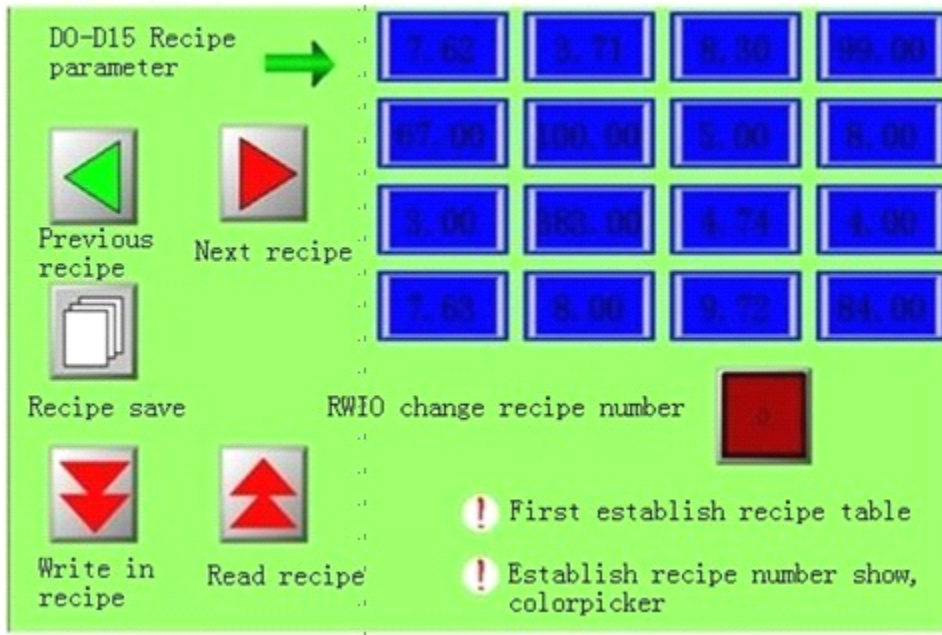

Figure 7-33 Recipe effect diagram

All data of recipe can be changed, saved, read and written conveniently through setting function button together with value display/input. Users have to pay attention to the following several points when using recipe:

- √ The recipe table has to be established firstly.
- √ Pay attention to selection of data type when writing required recipe parameter to recipe table. 16-digit data occupies one word and 32-digit data occupies two words. The selection of data type shall be consistent when selecting controls, especially notice the use of 32-digit data address. The 32-digit data occupies two words. Therefore, it is necessary to prevent data address from overlap when entering address into write address and monitor address.
- √ Address RWIO is fixed, which can only be used to change recipe number and cannot be used in any other places. Besides, when value of RWIO is 0, it standards for first recipe number, and so forth.
- √ Recipe parameter address is continuous.

7.9. Setting of global macro of SKWorkshop

Set one successfully compiled macro to be global macro. When the configuration begins to run, i.e. execute this macro instruction, the instruction shall be executed in the whole operation course with no limit from screen. 64 global macros can be set at most. When multiple global macros are set, they will be executed according to the set serial number at the time of installation.

Click “Global Macro” in menu "Set" to pop up a dialog box as shown in following figure.

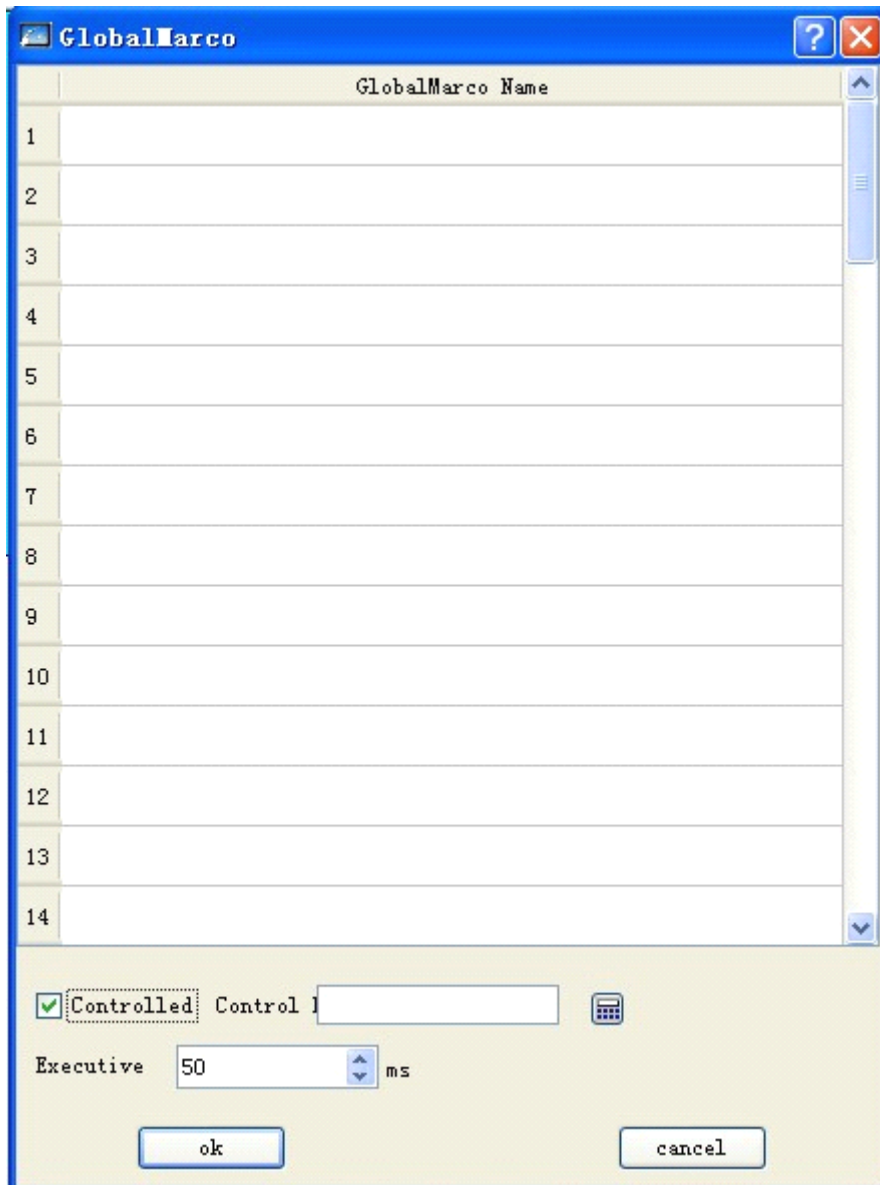

Click the list item and list out the compiled macro name. Set the “bit control” and “executive frequency” for the macro. Then, the selected macro will execute in configuration operation as the overall macro.

7.10. Setting of initial macro of SKWorkshop

Set one successfully compiled macro instruction to be initial macro. When the configuration begins to run, i.e. execute the macro instruction, it is not limited by screen. 64 initial macros can be added at most. When multiple initial macros are set, they will be executed according to the set serial number at the time of installation.

- ◆ Click “Initial Macro” in menu "Set" to pop up the dialog box as shown in figure below:

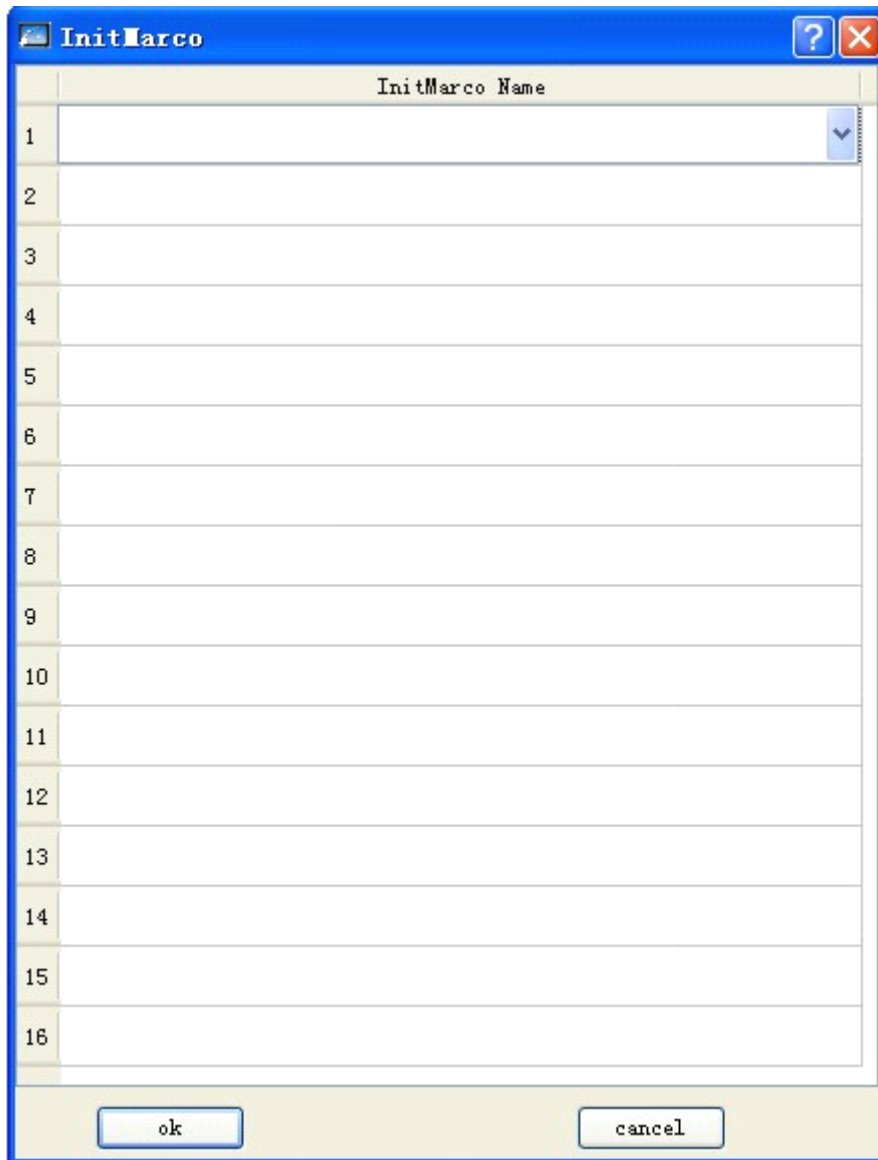

Click the list item to list all successfully compiled macro names. Then, the selected macro instruction will be treated as initial macro to be executed during configuration operation.

8. System reserved register of SKWorkshop

This Chapter makes presentation of registers retained in SKWorkshop system.

SKWorkshop keeps some registers for special purpose. Users have to use these registers according to related instructions. These registers include LB (local memory bit), LW (local memory register) and RWI (recipe index).

LB: LB0~LB65535, LB50000- LB51999 belongs to power-off held area;

LW: LW0~LW65535, LW50000- LW51999 belongs to power-off held area;

RWI: RWI0~RWI65535;

8.1. LB

Address	Description	Note	Read/Write Property
60000-60099	ON Initialize to ON	These bits can be initialized to be ON at system startup.	R/W
60100	Recipe download	Trigger the bit and write the current RWI data into device. Reset it after completion.	R/W
60101	Recipe upload	Trigger the bit and read the recipe from device into RWI register area. Reset it after completion.	R/W
60102	Recipe save	Trigger the bit and write the recipe from RWI into FLASH. Reset it after completion.	R/W
60103	Recipe download instruction	When the recipe is being written into device, this bit is ON; it becomes OFF after completion.	R
60104	Recipe upload instruction	When the recipe is being read into device, this bit is ON; it becomes OFF after completion.	R
60105	Restart HMI	Trigger it to restart the system	R
60106	Backlight control	Enable the bit ON to close LCD backlight, and enable it OFF to open LCD backlight	R/W
60107	COM1 communication status	ON – the communication is normal; OFF – the communication is failed or is not existed.	R
60108	COM2 communication status	ON – the communication is normal; OFF – the communication is failed or is inexistence.	R
60109	Storage of COM1 communication parameter changes	Trigger the bit to store the changed communication parameters into FLASH; it is OFF after completion.	R/W
60110	Storage of COM2 communication parameter changes	Trigger the bit to store the changed communication parameters into FLASH; it is OFF after completion.	R/W
60111	Confirmation of system parameter changes	Trigger the bit to store the changed communication parameters into FLASH; it is OFF after completion.	R/W
60112	Window of abnormal communication	ON – allow to popup abnormal window OFF – prohibit to popup abnormal window	R/W
60113	Control of mouse curse	ON – appear the mouse cursor OFF- prohibit mouse cursor (for touching only)	R/W
60114	USB connection status	ON – USB device is connected OFF – no USB device is connected	R
60115	Connection status of SD card	ON – SD card device is connected OFF – no SD card device is connected	R
60116	Touch sound	Whether it makes sound in touching or mouse clicking	R/W
60117	Alarm sound	Whether it makes sound in alarm	R/W
60118	Clear the historical	Clear the historical alarm records (auto reset)	R/W

	alarm records		
60119	Clear the operation records	Clear the operation records (auto reset)	R/W
60120	Clear the historical data records	Clear the historical data records (auto reset)	R/W
60121	Re-load recipe	When re-loading the recipe data at current number, this bit is ON; it becomes OFF after completion.	R/W
60123	Save historical alarm	ON – save the historical alarm records into disk OFF – after completion	R/W
60124	Save historical data	ON – save the historical data records into disk OFF – after completion	R/W
60125	Send historical alarm files to SD card	Send historical alarm files to SD card, and auto OFF after completion	R/W
60126	Send historical data files to SD card	Send historical data files to SD card, and auto OFF after completion	R/W
60127	Send historical alarm files to U disk	Send historical alarm files to U disk, and auto OFF after completion	R/W
60128	Send historical data files to U disk	Send historical data files to U disk, and auto OFF after completion	R/W
60129	Send current project to U disk	Send current project to U disk, and auto OFF after completion	R/W
60130	Send current project to SD card	Send current project to SD card, and auto OFF after completion	R/W
60133	User logout	ON – cancel the user logout, and cancel auto reset	R/W
60135	Save the user level password	ON – write the current modified user level password into file OFF – auto reset after completion	R/W
60141	Real-time alarm occurs	When there is real-time alarm, this bit is ON.	R
60142	System under screen saver status	When it is under screen saver, this bit is ON.	R
60143	Copy operation records to U disk	When it is ON, it sends the operation records to U disk. It becomes auto OFF at completion.	R/W
60144	Copy operation records to SD card	When it is ON, it sends the operation records to SD card. It becomes auto OFF at completion.	R/W

8.2. LW



Address	Description	Note	Read/Write Property
60000	Local time second	Bcd code, range of effective value: 0-59	R/W

60001	Local time minute	Bcd code, range of effective value: 0-59	R/W
60002	Local time hour	Bcd code, range of effective value: 0-23	R/W
60003	Local time day	Bcd code, range of effective value: 1-31	R/W
60004	Local time month	Bcd code, range of effective value: 1-12	R/W
60005	Local time year	Bcd code, range of effective value: 0-9999	R/W
60006	Local time week	Bcd code, range of effective value: 1-7	R/W
60007	System operation time - hour	System has operated for __ hours	R
60008	System operation time - minute	System has operated for __ minutes	R
60009	System operation time - second	System has operated for __ seconds	R
60010	Number of current picture window	Current screen number	R
60011	Buzzer status	0 – close, 1 – open	R
60012	Current language	Corresponding language number	R
60013	Allowable upper limit of numerical input	The allowable upper input limit when the keyboard is disconnected; ASC display	R
60023	Allowable lower limit of numerical input	The allowable lower input limit when the keyboard is disconnected; ASC display	R
60033	Input data displayed in keyboard	Characters input from keyboard, ASC display	R
60065	Users login the current system	Current user number	R
60066	Login user password in current system	Display the password of current user, 16 characters	R
60074	Login user name in current system	Display the name of current user, 32 characters	R
60090	User 1 enabled/disabled	0 – deactivate, 1 – activate	R
60091	User 2 enabled/disabled	0 – deactivate, 1 – activate	R
60092	User 3 enabled/disabled	0 – deactivate, 1 – activate	R
60093	User 4 enabled/disabled	0 – deactivate, 1 – activate	R
60094	User 5 enabled/disabled	0 – deactivate, 1 – activate	R
60095	User 6	0 – deactivate, 1 – activate	R

	enabled/disabled		
60096	User 7 enabled/disabled	0 – deactivate, 1 – activate	R
60097	User 8 enabled/disabled	0 – deactivate, 1 – activate	R
60098	Name of user 1		R
60114	Name of user 2		R
60130	Name of user 3		R
60146	Name of user 4		R
60162	Name of user 5		R
60178	Name of user 6		R
60194	Name of user 7		R
60210	Name of user 8		R
60226	Password of user 1		R
60234	Password of user 2		R
60242	Password of user 3		R
60250	Password of user 4		R
60258	Password of user 5		R
60266	Password of user 6		R
60274	Password of user 7		R
60282	Password of user 8		R
60290	Screensaver time	Display the screensaver time defined in configuration	R/W
60291	Flickering period of indicator lamp	Indicate the flickering period of light control; the minimum is 0.1, and the unit is s.	R/W
60292	X position in touch	The position of coordinate X in touch	R
60293	Y position in touch	The position of coordinate Y in touch	R
60294	Z position without touch	The position of coordinate X without touch	R
60295	Y position without touch	The position of coordinate Y without touch	R
60296	Touch status	1 – touch, 0 - release	R
60297	COM1 check	Communication parameter: check, 0-NONE,1-EVEN, 2-ODD	R/W
60298	COM1 baud rate	Communication parameter: baud rate, 0-1200,1-2400,2-4800,3-9600,4-19200,5-25600,6-115200,7-187.5K	R/W
60299	COM1 stop bit	Communication parameter: stop bit, 0-1stops,1-2stops	R/W
60300	COM1 data length	Communication parameter: data length, 0-7bits,1-8bits	R/W

60301	HMI address of COM1	Communication parameter: HMI address	R/W
60302	PLC address of COM1	Communication parameter: PLC address	R/W
60303	PLC continuous address interval of COM1	The max continuous address length acquired in single communication	R/W
60304	COM1 communication time	Communication delay time	R/W
60305	COM1 retry times	System retry times in abnormal communication	R/W
60306	COM1 address mode	Address mode: 0 – standard mode, 1 – extension mode	R
60307	COM1 communication timeout	Set the communication timeout, the unit is ms	R/W
60308	Current waiting time in COM1 communication	Current waiting time of communication; the unit is ms	R/W
60309	Current retry times in COM1 communication	Current retry times of communication	R/W
60310	PLC brand of COM1	Communication parameter: set manufactures for PLC connection	R
60311	PLC model of COM1	Communication parameter: the model is CPU model	R
60312	COM2 check	Communication parameter: check, 0-NONE,1-EVEN,2-ODD	R/W
60313	COM2 baud rate	Communication parameter: baud rate, 0-1200,1-2400,2-4800,3-9600,4-19200,5-25600,6-115200,7-187.5K	R/W
60314	COM2 stop bit	Communication parameter: stop bit, 0-1stops,1-2stops	R/W
60315	COM2 data length	Communication parameter: data length, 0-7bits,1-8bits	R/W
60316	HMI address of COM2	Communication parameter: HMI address	R/W
60317	PLC address of COM2	Communication parameter: PLC address	R/W
60318	PLC continuous address interval of COM2	The max continuous address length acquired in single communication	R/W
60319	COM2 communication time	Communication delay time	R/W
60320	COM2 retry times	System retry times in abnormal communication	R/W
60321	COM2 address mode	Address mode: 0 – standard mode, 1 – extension mode	R
60322	COM2 communication	Set the communication timeout; the unit is ms	R/W

	timeout		
60323	Current waiting time in COM2 communication	Current waiting time of communication; the unit is ms	R/W
60324	Current retry times in COM2 communication	Current retry times in communication	R/W
60325	PLC brand of COM2	Communication parameter: set manufacturer for PLC connection	R
60326	PLC model of COM2	Communication parameter: the model is CPU model	R
60327	Historical alarm items	The recorded historical alarm sum	R
60329	Historical record items	The recorded historical records sum	R
60331	Touch sound	Whether it makes sound in touch or mouse clicking	R
60332	Alarm sound	Whether it makes sound in alarm	R
60333	Keyboard language switching	0 – Chinese keyboard, 1 – English keyboard; for standard keyboard	R/W
60334	CPU utilization rate	The utilization rate of current system in CPU operation	R
60335	Current luminance of backlight	Current luminance of backlight	R/W
60336	HMI remain storage capacity	Remain FLASH storage capacity used by current HMI	R
60337	Current project creation time – year	Current project file creation time – year	R
60338	Current project creation time – month	Current project file creation time – month	R
60339	Current project creation time – day	Current project file creation time – day	R
60340	Current user language	Set the current language	W
60359	Copy the historical alarm within specified number to U disk at 1		R/W
60360	Copy the historical alarm within specified number to SD card at 1		R/W
60361	Copy the historical alarm within specified time to U		R/W

	disk at 1		
60362	Copy the historical alarm within specified time to SD card at 1		R/W
60363	Export the start number of historical alarm		R/W
60365	Export the end number of historical alarm		R/W
60367	Export the start time of historical alarm	6 words in length as year, month, day, hour, minute, second	R/W
60373	Export the end time of historical alarm	6 words in length as year, month, day, hour, minute, second	R/W
60379	Export the historical alarm to U disk; file name at SD card	24 characters in length	R/W
60409	Copy the historical data within specified number to U disk at 1		R/W
60410	Copy the historical data within specified number to SD card at 1		R/W
60411	Copy the historical data within specified time to U disk at 1		R/W
60412	Copy the historical data within specified time to SD card at 1		R/W
60413	Export the start number of historical data		R/W
60415	Export the end number of historical data		R/W
60417	Export the start time of historical data	6 words in length as year, month, day, hour, minute, second	R/W
60423	Export the end time of historical data	6 words in length as year, month, day, hour, minute, second	R/W
60429	Export the historical data to U disk; file	24 characters in length	R/W

	name at SD card		
60441	Modify the password cache of user 1	16 characters in length	R/W
60449	Enable modifying password of user 1	Modify the password of user 1 to cache region password at 1; auto reset after completion	R/W
60451	Modify the password cache of user 2	16 characters in length	R/W
60459	Enable modifying password of user 2	Modify the password of user 2 to cache region password at 1; auto reset after completion	R/W
60461	Modify the password cache of user 3	16 characters in length	R/W
60469	Enable modifying password of user 3	Modify the password of user 3 to cache region password at 1; auto reset after completion	R/W
60471	Modify the password cache of user 4	16 characters in length	R/W
60479	Enable modifying password of user 4	Modify the password of user 4 to cache region password at 1; auto reset after completion	R/W
60481	Modify the password cache of user 5	16 characters in length	R/W
60489	Enable modifying password of user 5	Modify the password of user 5 to cache region password at 1; auto reset after completion	R/W
60491	Modify the password cache of user 6	16 characters in length	R/W
60499	Enable modifying password of user 6	Modify the password of user 6 to cache region password at 1; auto reset after completion	R/W
60501	Modify the password cache of user 7	16 characters in length	R/W
60509	Enable modifying password of user 7	Modify the password of user 7 to cache region password at 1; auto reset after completion	R/W
60511	Modify the password cache of user 8	16 characters in length	R/W
60519	Enable modifying password of user 8	Modify the password of user 8 to cache region password at 1; auto reset after completion	R/W
60520	HMI model	40 characters	R
60540	bootloader version	40 characters	R
60560	Operating system version	40 characters	R
60580	Software version	40 characters	R
60600	Operating records enabled	Operating records is recorded at 1	R/W
60601	Operating records items	Display the current operating record items	R

8.3. RWI:

Address	Description	Note
RWI0	Recipe number register	Display recipe designated by recipe number
RWI1	Recipe memory address	The corresponding recipe data can be displayed in RWI when designating recipe number.

9. Connection method of SKWorkshop multi-screen multi-unit

This Chapter presents the multipoint connection methods of Samkoon SK series touch screen, including one-unit multi-screen connection, one-screen multi-unit connection and practical function penetration connection.

9.1 One-unit multi-screen connection method of SKWorkshop

Samkoon SK series touch screen can connect with PLC in the form of "one device with multiple screens" through MODBUS communication protocol. All touch screens connect with each other one by one. The first screen is connected with PLC. You can set all touch screens to be slave station and PLC to be primary station. Double click "com1 connection" in project manager to pop up attribute setting window of communication port. In option "General" of this window, select Modbus RTU for option "Device/Server" and Modbus RTU Slave in right area. Alternatively, set the first touch screen connected with PLC to be primary station and other screens and PLC to be slave station. Therefore, when setting attribute of communication port for first touch screen, it is necessary to select Modbus RTU for option "Device/Server" and Modbus RTU Master in right area. Besides, it is required to change mode to expanded mode in option "Parameter" of this window and distribute address of touch screen. In this way, the touch screen as slave station also can obtain PLC data through the first screen even if they are not directly connected with PLC. For both above methods, only primary station can communicate with slave station. Slave stations cannot communicate with each other.

- When PLC is primary station and all touch screens are slave station:
 1. The communication port RS232 connected with PLC, connection method and system setting are as shown in figures 8-1, 8-2 and 8-3.

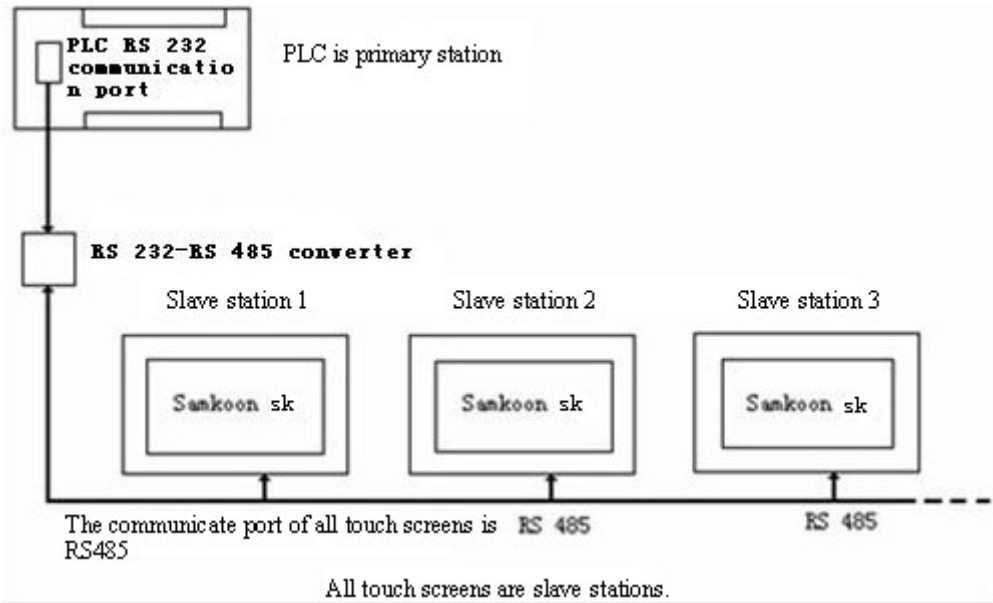

Figure 8-1 Schematic diagram of connection mode "One device with multiple screens" When PLC (RS232) is primary station

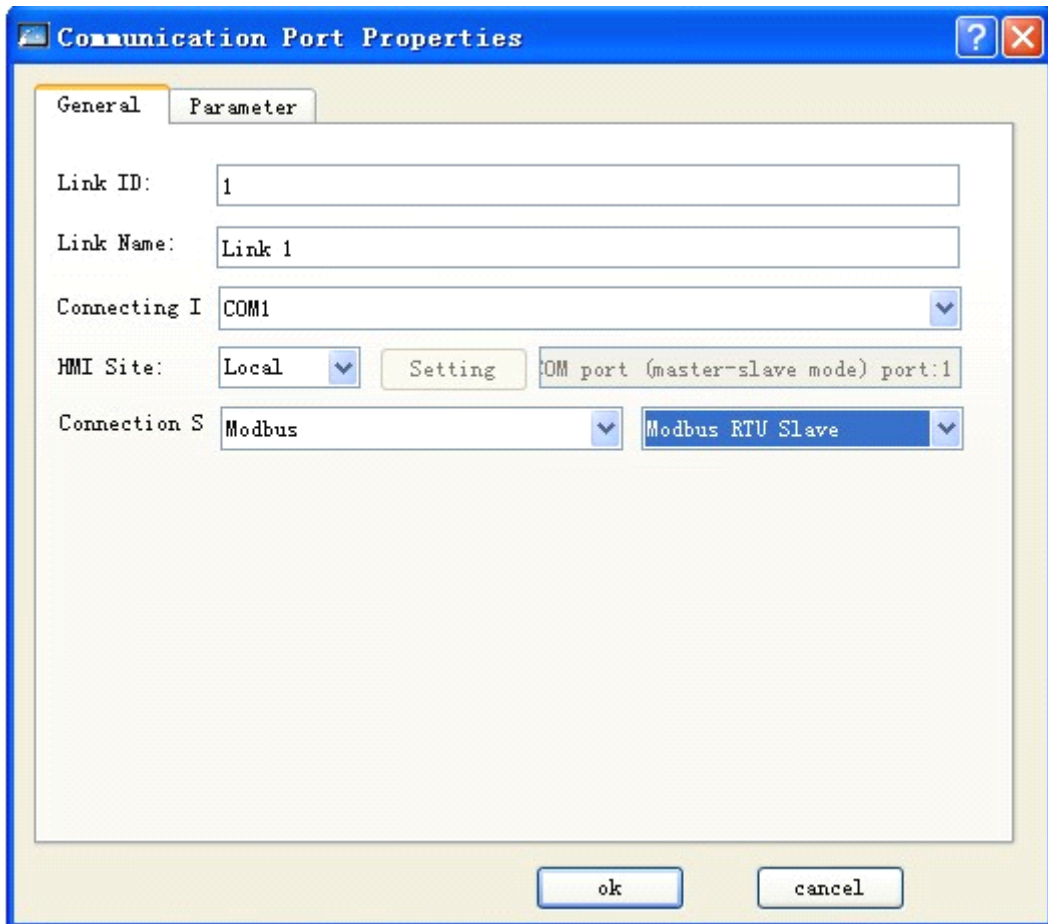

Figure8-2 Select MODBUS protocol and select to be slave station

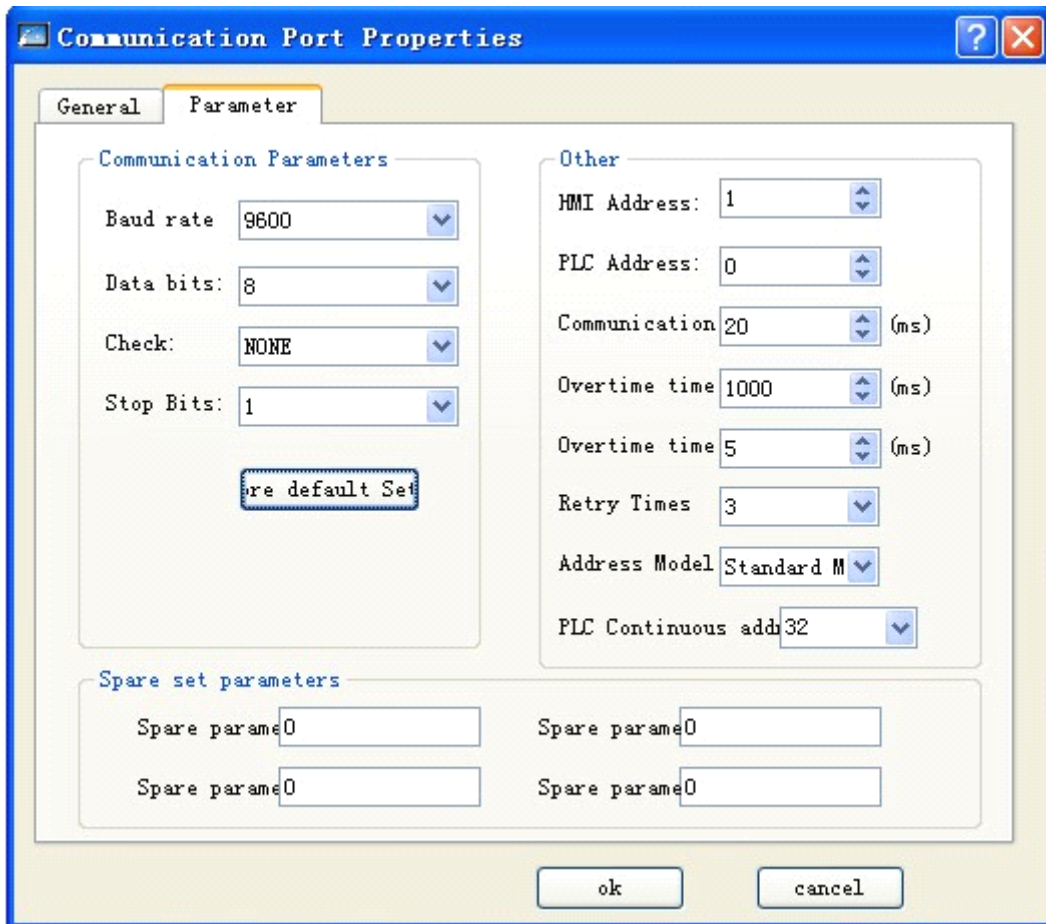

Figure 8-3 Distribute station address for touch screen

- The communication port connected with PLC is RS485 with connection mode as shown in figure 8-4.

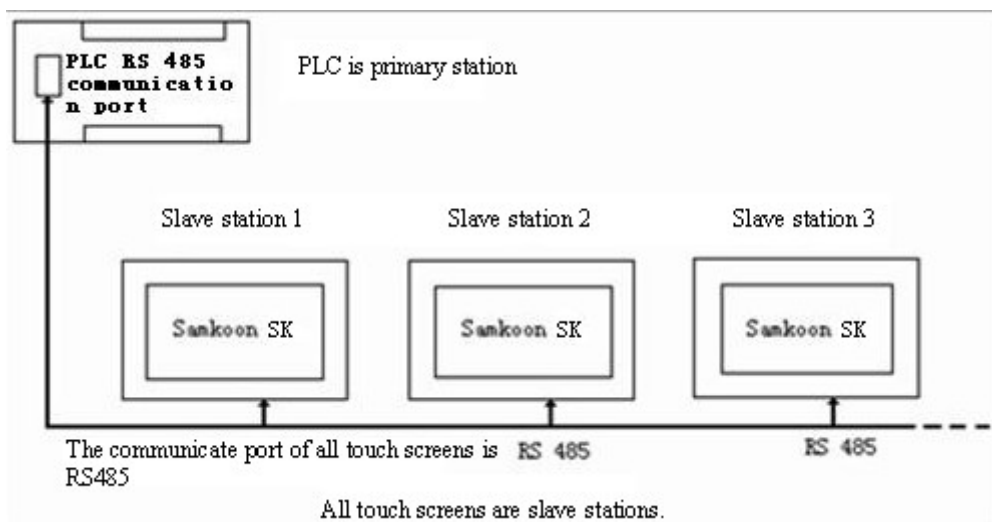

Figure 8-4 Schematic diagram of connection mode “One device with multiple screens” When PLC (RS485) is primary station

When the communication port of PLC is RS485, all touch screens are slave stations. The system setting is same to the case when the communication port is RS232. Please refer to figures 8-2 and 8-3 for operation.

When Samkoon SK series touch screens are treated as slave station, 255 touch screens can be connected at most. However, pay attention that when the quantity of touch screen connected exceeds some limit, the response speed may become low.

- When the first touch screen is primary station, all other screens and PLC are slave station:

1. The communication port RS232 connected with PLC, connection method and system setting of host are as shown in figures 8-5, 8-6 and 8-7.
- 2.

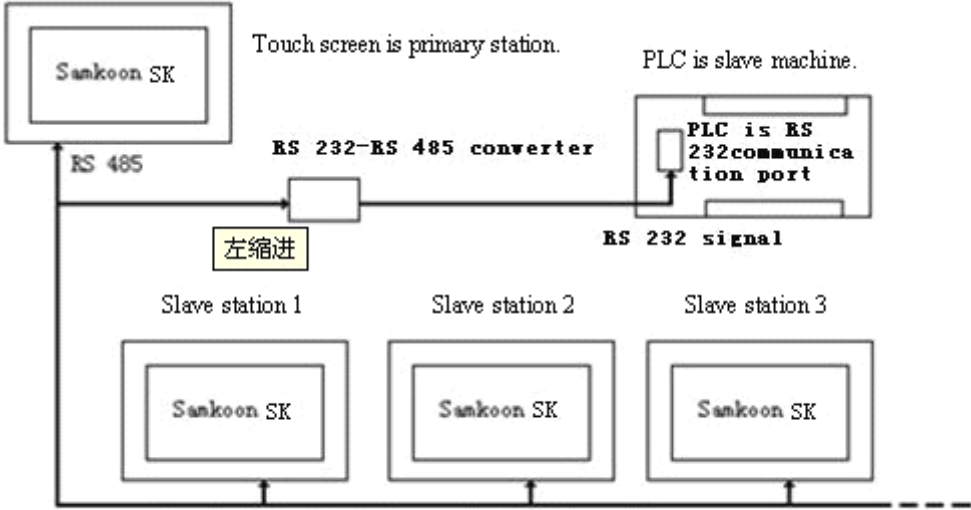

Following touch screens are slave stations with same communication port RS 485.

Figure 8-5 Schematic diagram of connection mode “One device with multiple screens” When PLC (RS232) is slave station

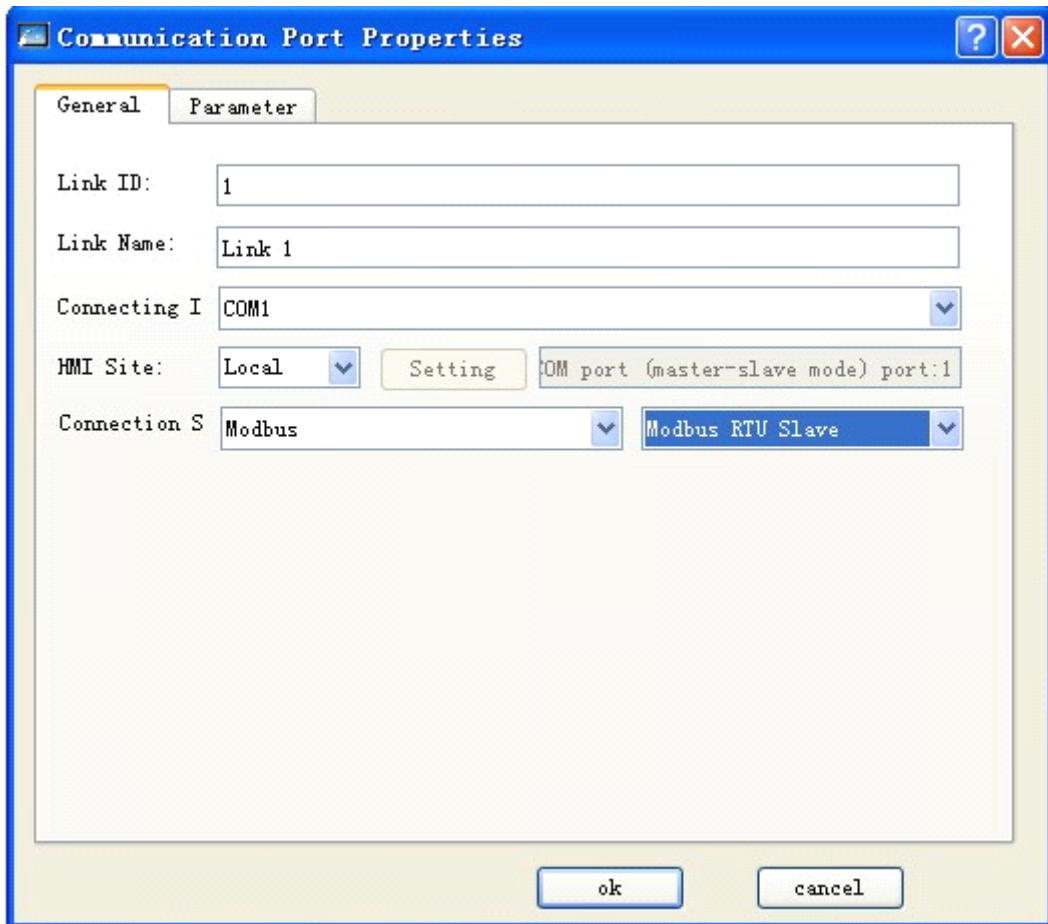

Figure 8-6 First touch screen selects MODUBUS protocol and is selected to be primary station

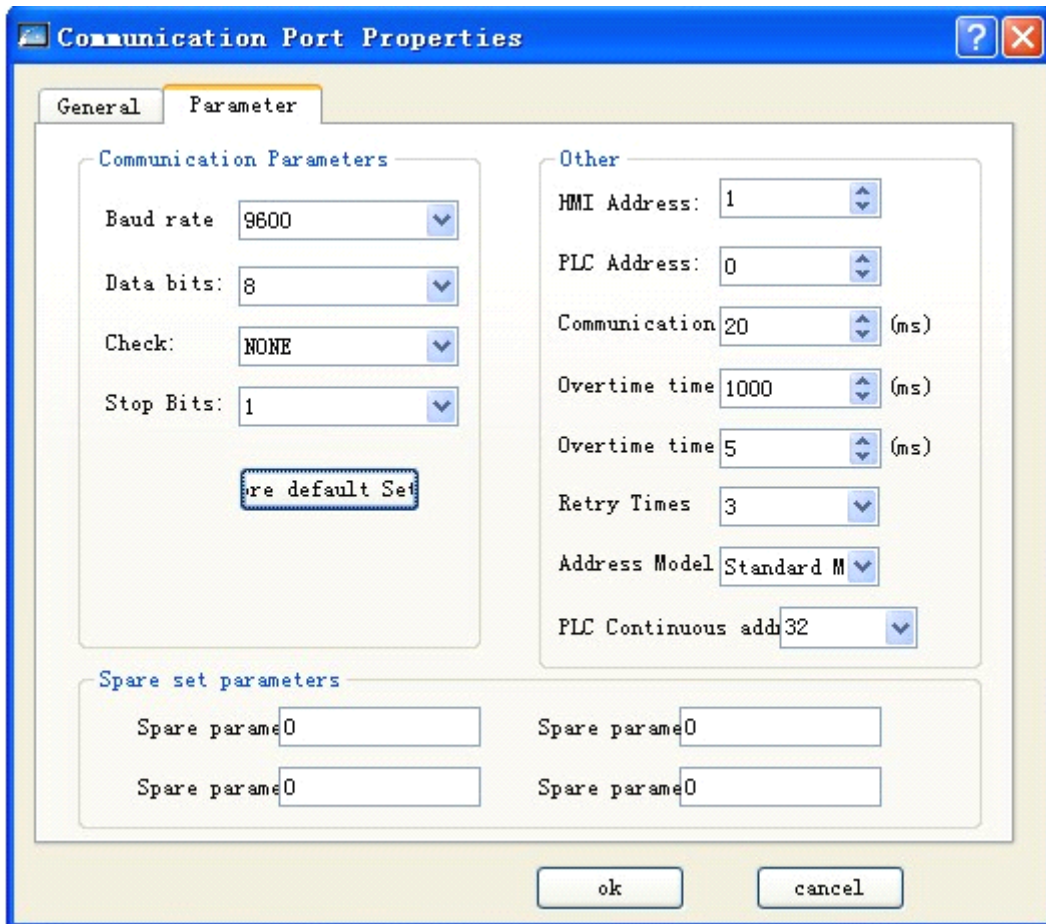

Figure 8-7 Select expanded mode when first touch screen is primary station

Refer to figures 8-2 and 8-3 to set the system of touch screen as slave station.



: RS232 cannot support the connection mode of multi-drop. Therefore, when PLC in mode “one device with multiple screens” doesn’t support port RS485, it is necessary to configure communication adapter to convert RS485 signal into RS232 signal.



: When Samkoon SK series touch screen is selected to be primary station in mode “one device with multiple screens”, the address mode of touch screen as primary station have to be set to “Expanded Mode”.

9.2 One-screen multi-unit connection method of SKWorkshop

Samkoon SK series touch screen can not only be connected in mode "one device with multiple screens", but also can connect with PLC in the form of “one screen with multiple device” through MODBUS communication protocol, which means that one touch screen can directly operate the register address of multiple PLCs connected with it, only if PLC supports MODBUS communication protocol. At the time of system setting, it is necessary to select Modbus RTU for option “Device/Server” and Modbus RTU Master in right area in option “General” of communication port attribute of touch screen, making touch screen be primary station and all PLCs be slave station. Using touch screen to operate register address means to operate the corresponding register address in PLC supporting MODBUS protocol. All register names of PLC supporting MODBUS protocol can correspond to the register name in MODBUS protocol. The connection method and system setting of touch screen are as shown in figures 8-8, 8-9 and 8-10.

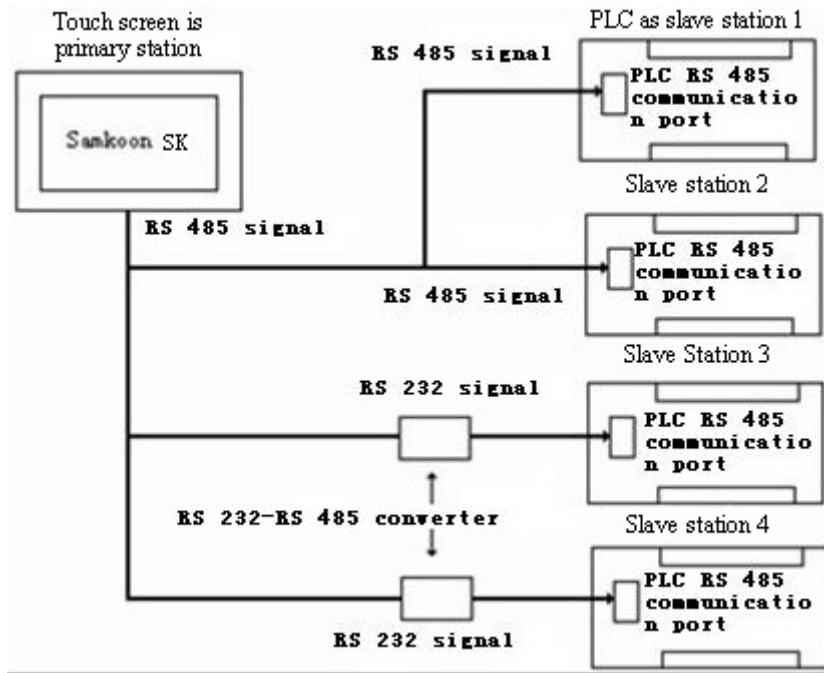

Figure 8-8 Connection mode of "One screen with multiple devices"

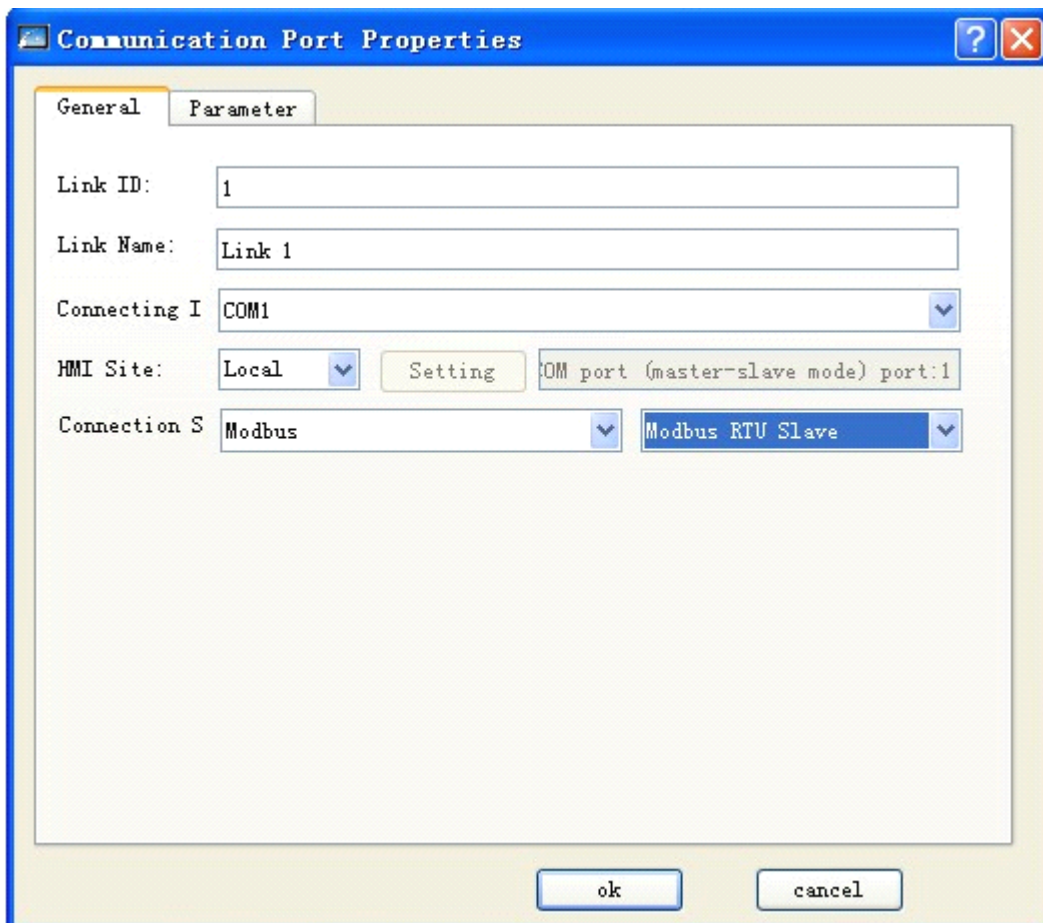

Figure 8-9 Select touch screen as primary station

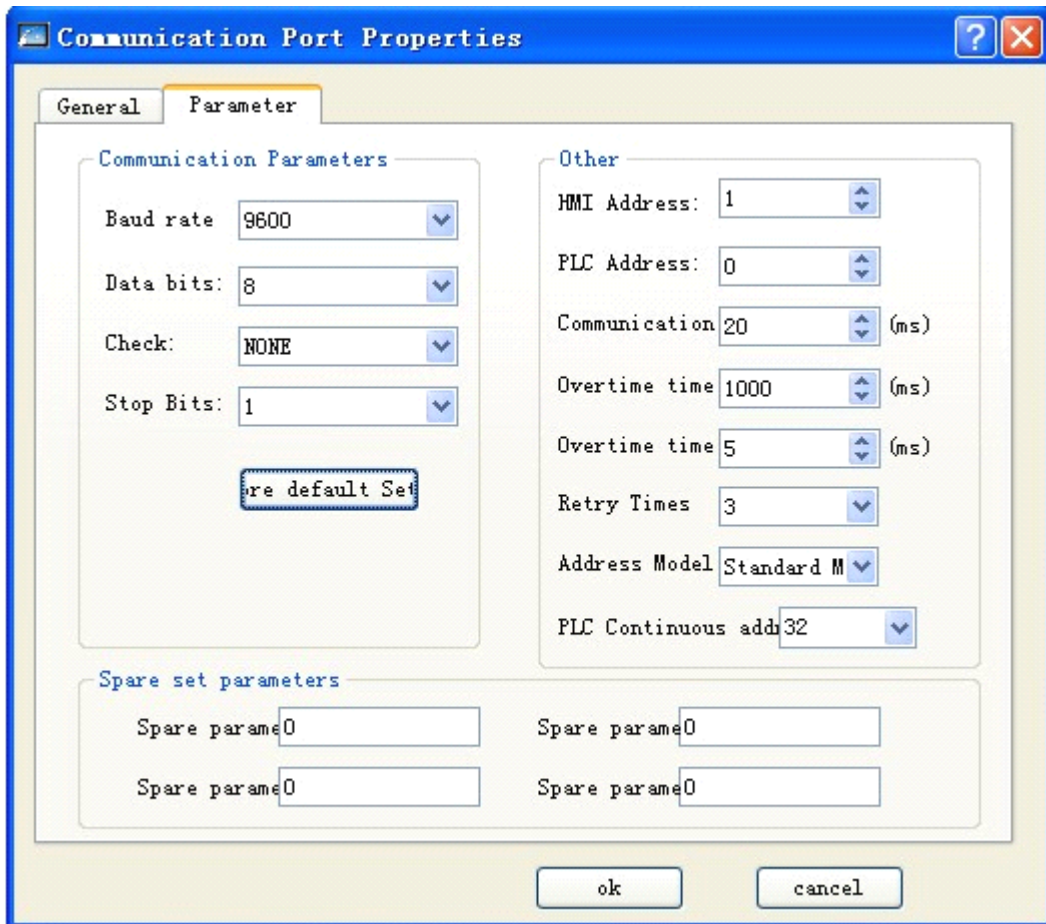

Figure 8-10 Select expanded mode when touch screen is primary station

PC address in communication port attribute will become invalid when the system is set as per above method. When user clicks input address on some controls, the address input window as shown in figure 8-11 will pop up. Select the drop-down menu on left of register name. The number selected after clicking the drop-down menu is just the slave station address of PLC.



Figure 8-11 Address entry Window



RS232 cannot support the connection mode of multi-drop. Therefore, when PLC in mode “one screen with multiple devices” doesn’t support port RS485, it is necessary to configure communication adapter to convert RS485 signal into RS232 signal.

9.3 Penetration connection method of SKWorkshop

SK series touch screen also supports a special connection method. The remote one HMI could realize monitoring and control for PLC or other control devices via another HMI serial port (this HMI connects PLC or other control devices). At this time, it is equivalent that two or more control ends may operate for subordinated devices. The penetration function is a very practical function provided by SK series HMI.

Before using the penetration, you have to learn the two nouns as following:

- ◇ Local: the HMI that connects to PLC or other control devices.
- ◇ Remote: other HMI with penetration function that connects to local.

To realize penetration function, the local HMI should have double serial ports. The connection diagrams in penetration function are shown as Figure 8-12 and Figure 8-13:

Two-screen penetration:

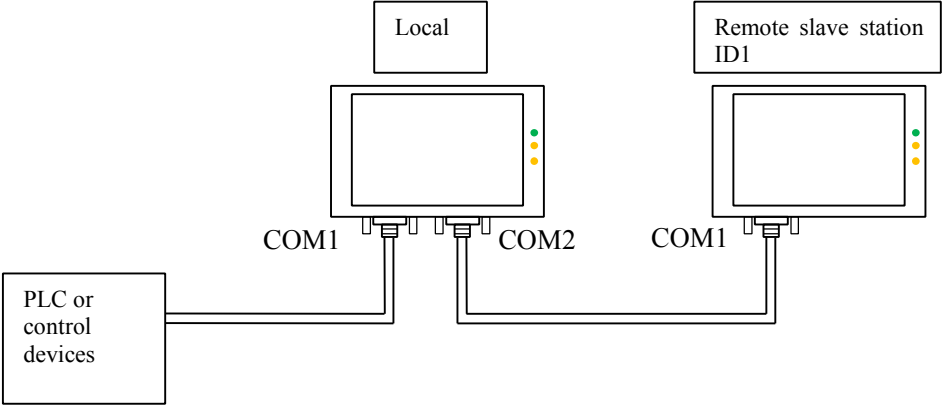

Figure 8-12 connection diagram of two-screen penetration

Multi-screen penetration:

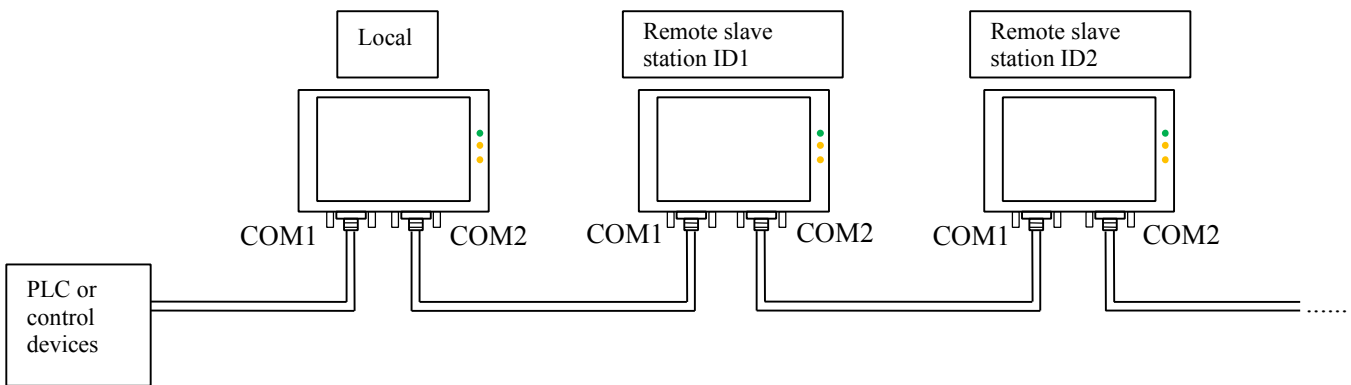

Figure 8-13 connection diagram of multi-screen penetration

■ Local HMI: software setting

Double click the created connection, and pop up communication port property setting. Select COM1 in connection port. Taking MITSUBISHI penetration as an example, the COM1 connection of HMI is MITSUBISHI FA2N PLC. The communication parameters in communication parameter should be consistent with that of PLC or connection device shown as Figure 8-14 and Figure 8-15:

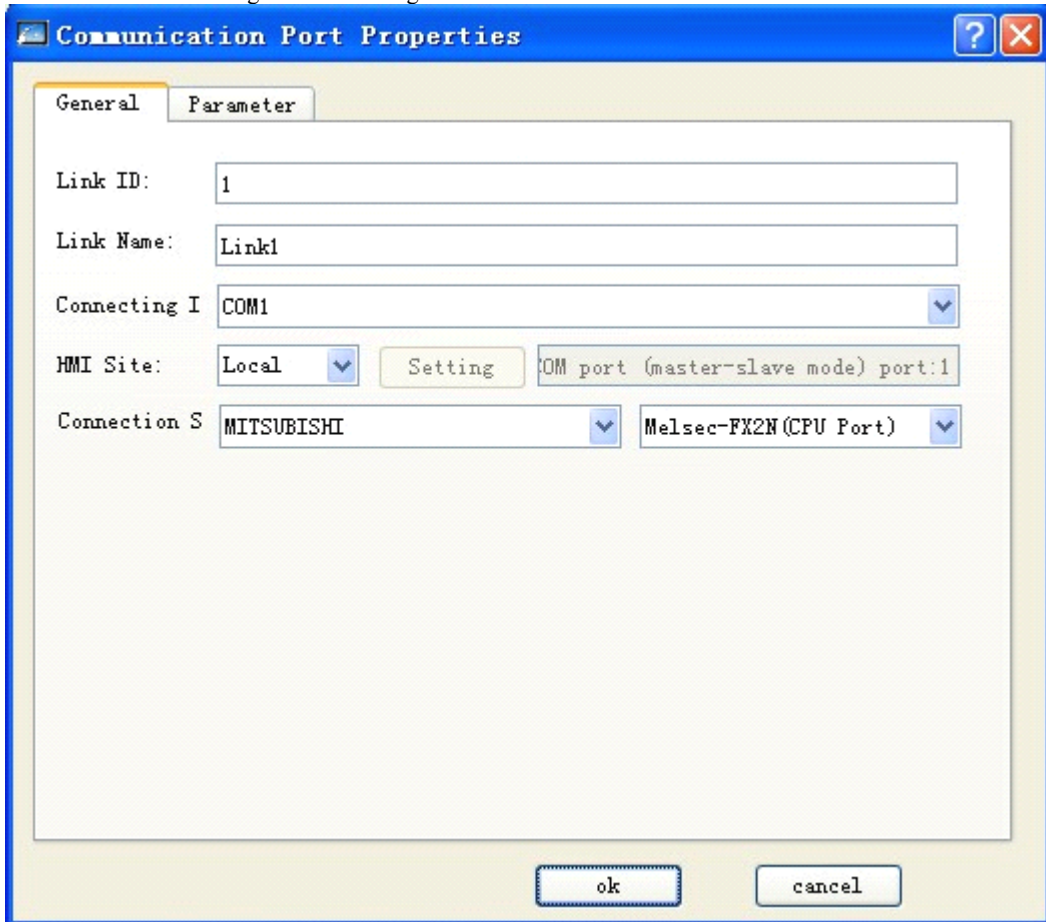

Figure 8-14: General page of property setting for local HMI communication port

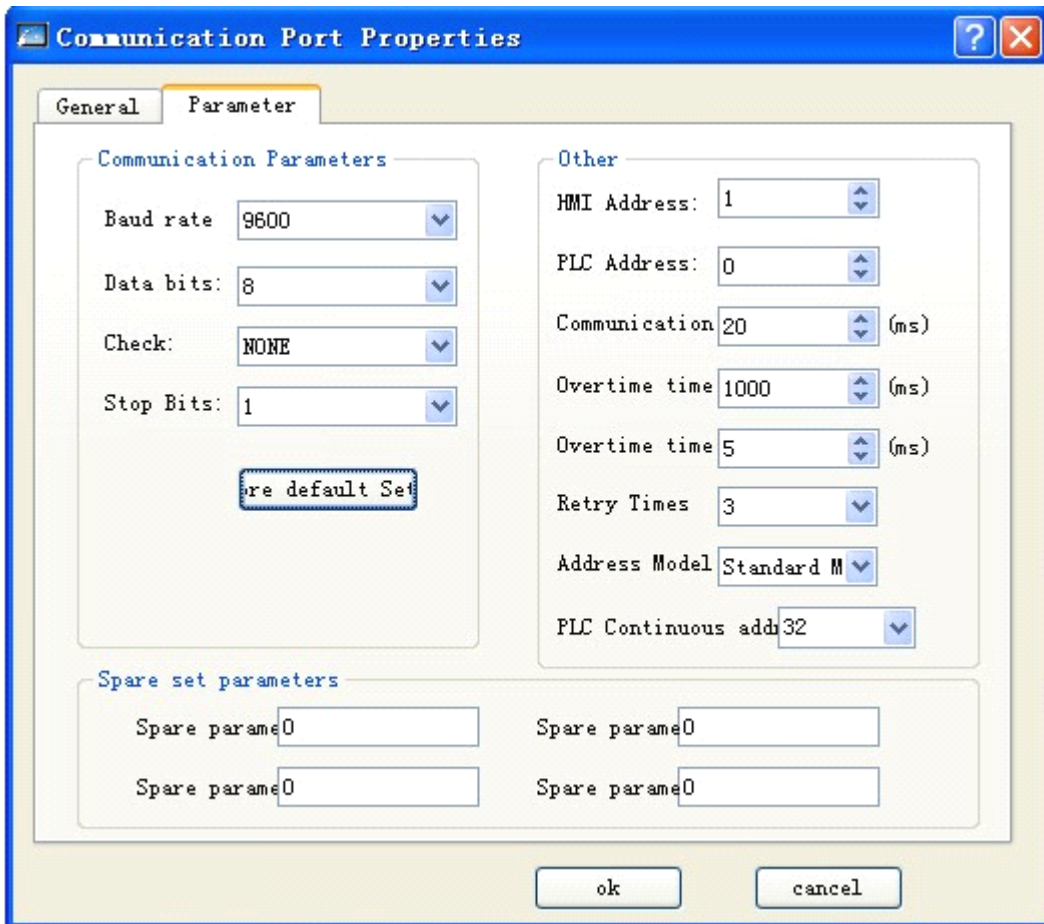

Figure 8-15: Parameter page of property setting for local HMI communication port

New create a connection, select COM2 in the connection port; select Samkoon in the connection service; select Penetrate on the right. The parameter is recommended to 19200, 8, NONE, 1, which is shown as Figure 8-16 and Figure 8-17:

- ✓ Note: the communication parameter should be consistent with that of connected remote slave station ID, and the data bit can be 8 only.

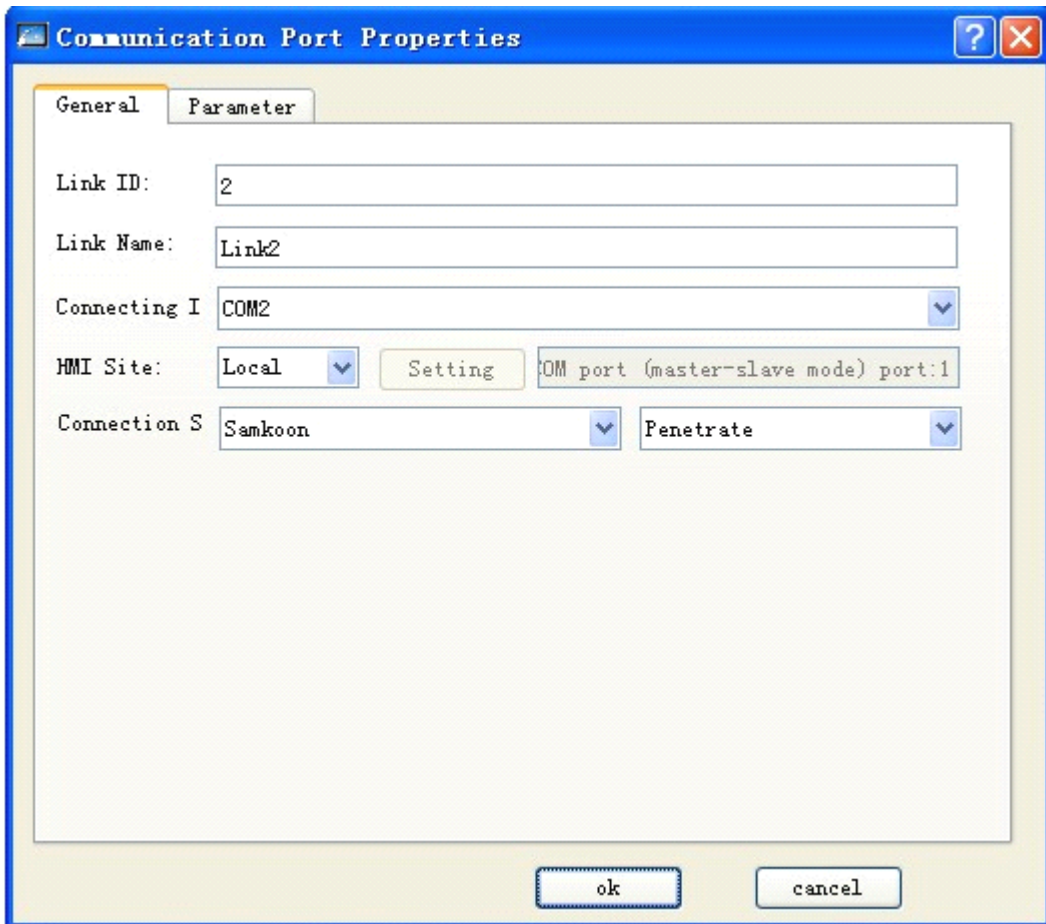

Figure 8-16: General page of property setting for local HMI communication port

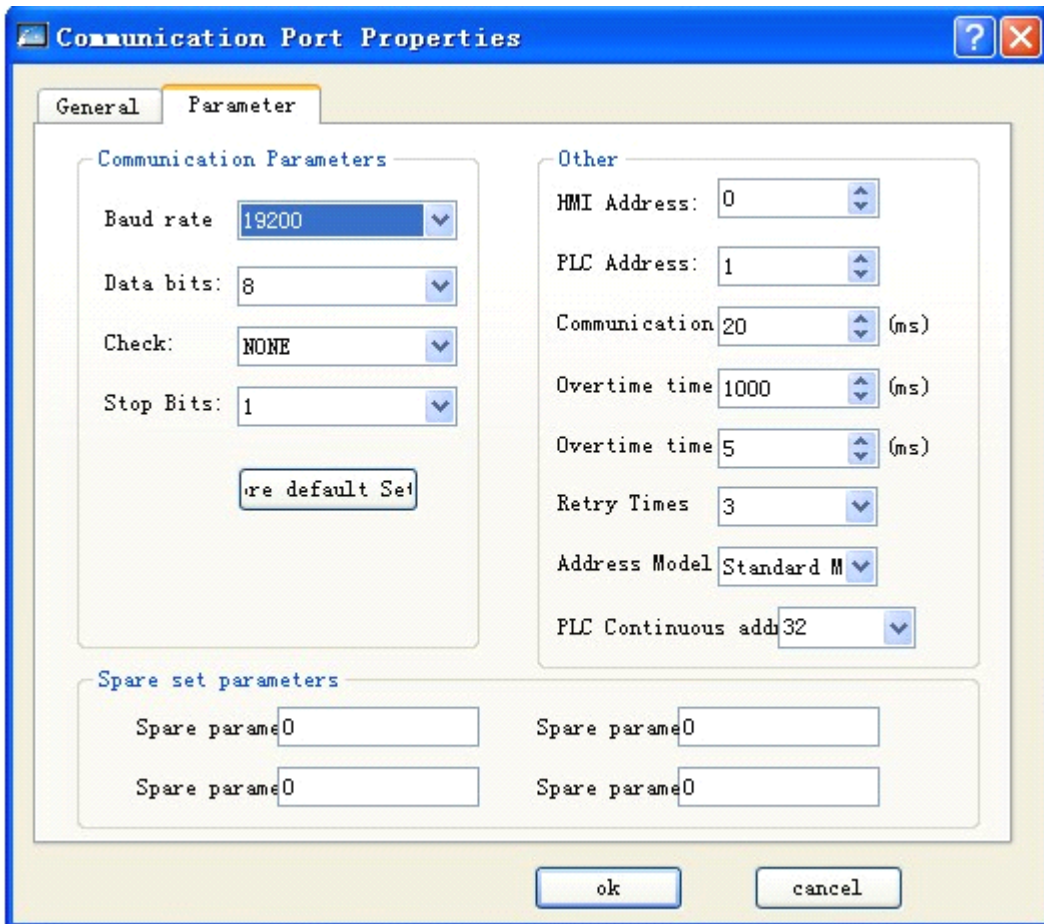

Figure 8-17: Parameter page of property setting for local HMI communication port

Other parameters are defaulted. Then the local HMI parameter setting is completed.

- Remote HMI: software setting
 Double click the created connection, and pop up communication port property setting. Select COM1 in connection port. Select HMI position as remote. The communication parameters should be consistent with the parameter setting whose connection port is COM2 (as Figure 8-17). The remote HMI setting is shown as Figure 8-18 and Figure 8-19.
 - ✓ Note: the communication parameter should be consistent with that of connected Samkoon-Penstrate in the local, and the data bit can be 8 only.

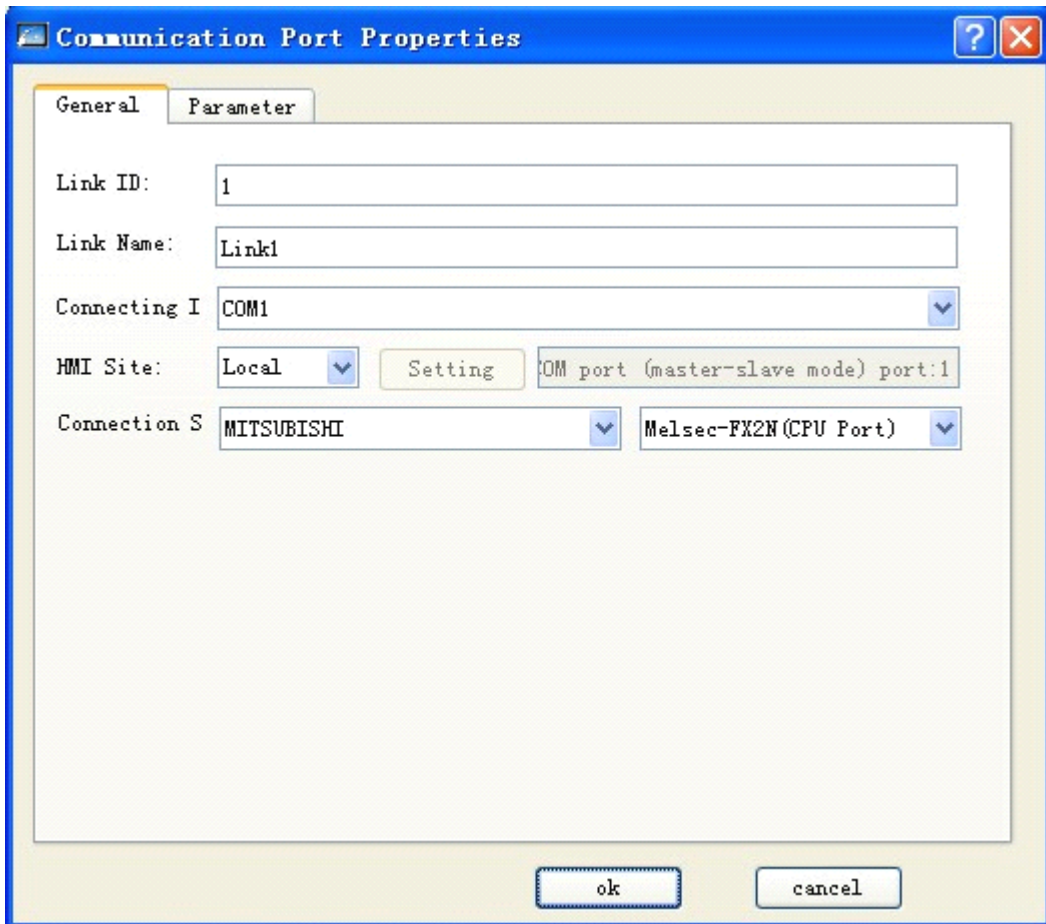

Figure 8-18: General page of property setting for remote HMI communication port

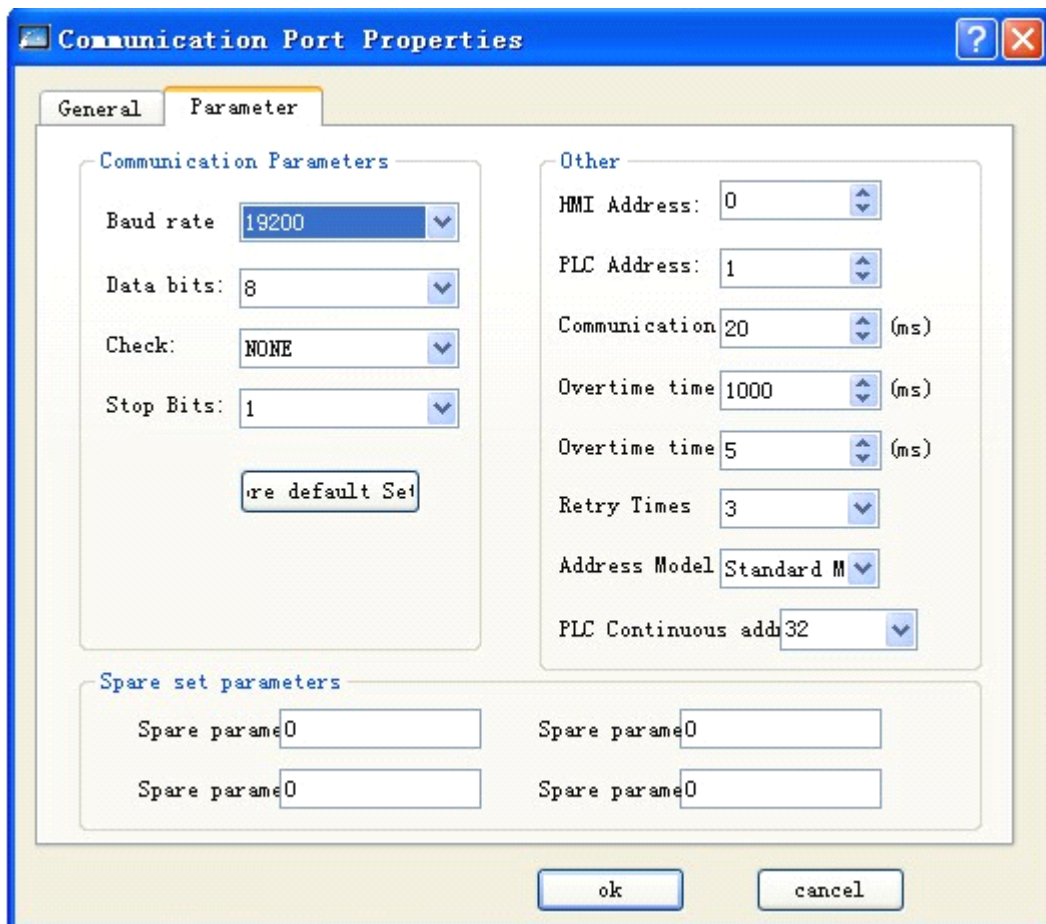

Figure 8-19: Parameter page of property setting for local HMI communication port

Other parameters are defaulted. Then the remote HMI parameter setting is completed.

- ✓ Note: the above setting is the software setting for two-screen penetration.
- ✓ Note: in multi-screen penetration, the COM2 setting in remote HMI is same to that of local, and the like.
- ✓ Note: as all communication data will be changed with PLC through local COM1, the communication speed in multi-screen connection will become slow.

10. Device driver of SKWorkshop

This Chapter will make a detailed introduction of devices to connect with SK series touch screen of Shenzhen Samkoon Automation Technology Co., Ltd.

It is important to set the I/O drive for configuration. The devices to connect with SK series touch screen of Shenzhen Samkoon Automation Technology Co., Ltd include PLC, single-chip, transducer and some other industrial control devices. SK series touch screen can establish communication connection with PLC from most manufacturers in the world, including MITSUBISHI, OMRON, SIEMENS, ALLEN-BRADLEY, MATSUSHITA, DELTA, FATEK etc. In addition, it can monitor and control some special industrial control devices via special protocols as MODBUS RTU/ASCII, HOSTLINK and some customized protocols.

The I/O driver of different PLC for each manufacturer is made into file. When the users specify a PLC in establishing item, the system will know what drivers to be used, and other complicated programming is not required by engineering designer.

SKWorkshop is the matched configuration software of SK series touch screen from Shenzhen Samkoon Automation Technology Co., Ltd. Through the configuration, it can realize convenient operations for various types of register or relay for

most PLC or devices. The operation mode includes read only, write only, and read-write, which is able to satisfy all requirements of your industrial control.

For the convenience to connect different devices, Shenzhen Samkoon Automation Technology Co., Ltd could develop device drives according to the requirements of user, which requires the users to provide corresponding protocol documents of communication devices only. Any users for the requirement can contact with Shenzhen Samkoon Automation Technology Co., Ltd listed in the manual.

PLC supported by SK series touch screens:

Manufacturers (Brand)	Model	Communication Protocol	Connection Mode
Advantech Distributed I/O	ADAM-4017, ADAM-4060	Advantech special protocol	Direct connection (serial port)
AIBUS device manufacture	AI series	AIBUS protocol	Direct connection (serial port)
Allen-Bradley Rockwell	MicroLogix series	DF1 protocol	Direct connection (serial port)
Altec Electronics	AL series	Altec special protocol	Direct connection (serial port)
Delta Corporation	DVP series	Delta special protocol	Direct connection (serial port)
Emerson Network Power	EC series	Emerson special protocol	Direct connection (serial port)
Fatek Automation Corporation	FB series	Fatek special protocol	Direct connection (serial port)
Fuji Electric Corporation	NB series	Fuji special protocol	Direct connection (serial port)
GE Corporation	GE SNP-X/CCM device	GE special protocol	Direct connection (serial port)
Haiwell Technology Corporation	E/S/H series	Haiwell special protocol	Direct connection (serial port)
Hitachi Industrial	E/EH series	Hitachi special protocol	Direct connection (serial port)
HollySys Group	LM series	hollySys special protocol	Direct connection (serial port)
IDEC Corporation	FC4A/FC5A series	IDEC special protocol	Direct connection (serial port)
Inovance Technology Corporation	H1u/H2u series	Inovance special protocol	Direct connection (serial port)
JiaChuang Technology	JiaChuang device	JiaChuang special protocol	Direct connection (serial port)
KDN Automation Corporation	K3 series	KDN special protocol	Direct connection (serial port)
Keyence Corporation	KV-1000/700 KV-L20(R), KV-10/16/24/40 KV-P16	Keyence special protocol	Direct connection (serial port)
Koyo Electronics	SN series	Koyo special protocol	Direct connection (serial port)
Kstar Technology	Kstar master-slave device	Kstar special protocol	Direct connection (serial port)
Letrun Technology	LC series	Letrun special protocol	Direct connection (serial port)

LG Industrial Systems	Master-K series	LG special protocol	Direct connection (serial port)
Matsushita	FP series	Matsushita special protocol	Direct connection (serial port)
Mitsubishi	Melsec-FX/FX2N/FX3U/FX3G, Melsec-Q_C24N series	Mitsubishi special protocol	Direct connection (serial port)
Modbus device	RTU/ASCII master-slave device, RTU TCP/IP master-slave device	Modbus protocol	Direct connection (serial port)
Modicon Corporation	NEZA/TWIDO/M218 series	Modbus protocol	Direct connection (serial port)
Nanda Auto Technology	NA-200/NA-400 series	Nanda Auto special protocol	Direct connection (serial port)
Omron	C/CPM series, CS/CJ series	Omron special protocol	Direct connection (serial port)
Samkoon technology		Customized protocol	Direct connection (serial port)
SEARI	VP series	SEARI special protocol	Direct connection (serial port)
Shimaden	MR13	Shimaden special protocol	Direct connection (serial port)
Siemens	S7-200(PPI), S7-300(MPI)	Siemens special protocol	Direct connection (serial port)
TaiAn Technology	TP03 series	TaiAn special protocol	Direct connection (serial port)
TaiLing Electric	DX series	TaiLing special protocol	Direct connection (serial port)
Techwayson Technology	V series	Techwayson special protocol	Direct connection (serial port)
Vigor Electric Corporation	V/VH/VB/M series	Vigor special protocol	Direct connection (serial port)
Xinje Electronic	XC/XCM series	Xinjie special protocol	Direct connection (serial port)
Yokogawa Electric Corporation	FA-M3 series	Yokogawa special protocol	Direct connection (serial port)
ZhengHang Electronics	A4/A5 series	ZhengHang special protocol	Direct connection (serial port)

✧ Pin definition of serial port (COM1/COM2) for SK series touch screen

The serial port for SK series touch screen uses 9-pin trapezoid male connector and the connected cable is 9-pin trapezoid female connector. Detailed pin definition is shown as following table.

SK series touch screen COM1/COM2	
1	
2	RX
3	TX
4	KZ
5	GND
6	RX-
7	RX+

8	TX-
9	TX+

- RX: RS232 communication receiving end
- TX: RS232 communication transmitting end
- KZ: control terminal
- GND: grounding terminal
- RX-: RS422 communication receiving-
- RX+: RS422 communication receiving+
- TX-: RS422 communication sending-/RS485 communication B
- TX+: RS422 communication sending+/RS485 communication

Note ·2/3/5 terminal is used in RS232 communication;
·6/7/8/9 terminal is used in RS422 communication;
·8/9 terminal is used in RS485 communication.

10.1. AIBUS device driver

This device driver is used by SKWorkshop series touch screen to read and write the data or status of AIBUS device through AIBUS protocol. It establishes serial port communication with the connection port of AIBUS device through the serial port device of SK series touch screen so as to operate AIBUS device. Please read carefully this Chapter and relative technical manual of AIBUS device before using the driver.

How to establish connection with AIBUS device

1. Hardware connection

Connection cable:
RS232

SK series touch screen COM1/COM2		AIBUS device	
2	RX	Pin customization	TX
3	TX	Pin customization	RX
5	GND	Pin customization	GND

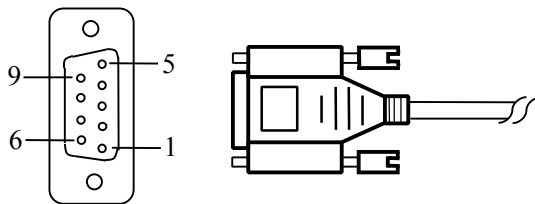

SK series touch screen uses 9P trapezoid female-connector. The pin at AIBUS device terminal is defined as AIBUS device.

RS422

SK series touch screen COM1/COM2		AIBUS device	
6	RX-	Pin customization	TX-
7	RX+	Pin customization	TX+
8	TX-	Pin customization	RX-
9	TX+	Pin customization	RX+

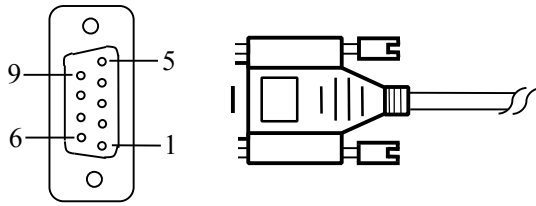

SK series touch screen uses 9P trapezoid female-connector. The pin at AIBUS device terminal is defined as AIBUS device. RS485

SK series touch screen COM1/COM2		AIBUS device	
8	TX-	Pin customization	B
9	TX+	Pin customization	A

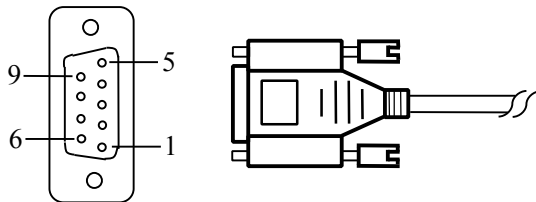

SK series touch screen uses 9P trapezoid female-connector. The pin at AIBUS device terminal is defined as AIBUS device.

2. Software setting

- ✓ Select AIBUS Protocol in the connection device service.
- ✓ Select the corresponding item in the connection device service according to the PLC model or supporting protocol.
- ✓ Make sure the communication parameters and PLC station number of touch screen is consistent with that of AIBUS device.
- ✓ Please refer to relative technical documents of AIBUS device for device setting.

Default connection parameters of SK series touch screen

Setting Item	Default Parameters	Setting Range
PLC	AIBUS Protocol	AIBUS Protocol
Communication port	RS232	RS232/RS422/RS485
Baud rate	9600	1200/2400/4800/9600/19200/38400/57600/115200
Data bit length	8	7/8
Parity check bit	NONE	EVEN/ODD/NONE
Stop bit length	1	1/2
PLC station number	1	1~255
HMI station number	0	0~255

Support functions	Yes/No
Offline simulation	Yes
Online simulation	Yes
Extension mode	Yes

3. Operable register and address range

Register Name	Address Format	Input Range	Remark
---------------	----------------	-------------	--------

Parameter	ddd	0~255	Word: parameter item
PV	d	0	Word: output value
SV	d	0	Word: setting value
MV	d	0	Word: status value
Status	d	0	Word: status value

Note

- d indicates decimal, and the input range is 0-9;
- "word" in the remark indicates the register can be used as word only.
- Different device models may support different register names and the range may be different. Detailed names and range refer to the relative technical documents for connected device.

10.2. Allen-Bradley device driver

This device driver is used by SKWorkshop series touch screen to read and write the data or status of Allen-Bradley (AB) series PLC register through Allen-Bradley DF1 protocol. It establishes serial port communication with the connection port of Allen-Bradley (AB) series PLC through the serial port device so as to operate Allen-Bradley (AB) series PLC. Please read carefully this Chapter and relative technical manual of Allen-Bradley (AB) series PLC before using the driver.

How to establish connection with Allen-Bradley (AB) series PLC

1. Hardware connection

Connection cable:
RS232

SK series touch screen COM1/COM2		Allen-Bradley(AB)	
2	RX	7	TX
3	TX	4	RX
5	GND	8	GND

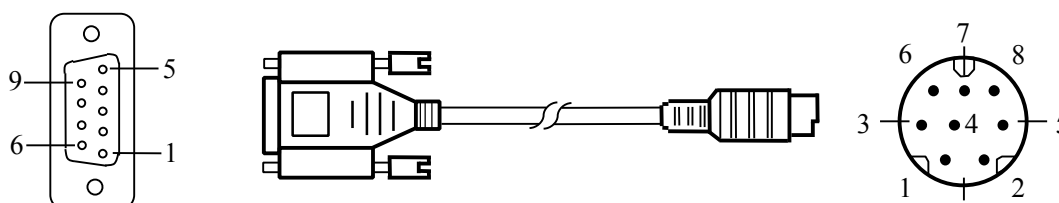

SK series touch screen uses DB9F connector. AB device terminal is MD8M.

2. Software setting

- ✓ Select Allen-Bradley in the connection device service.
- ✓ Select the corresponding item in the connection device service according to the PLC model or supporting protocol.
- ✓ Make sure the communication parameters and PLC station number of touch screen is consistent with that of PLC.
- ✓ Please refer to relative technical documents for PLC setting.

Default connection parameters of SK series touch screen

Setting Item	Default Parameters	Setting Range
PLC	MicroLogix DF1_CRC	MicroLogix DF1_CRC/MicroLogix DF1_BCC
Communication port	RS232	RS232/RS422/RS485
Baud rate	19200	1200/2400/4800/9600/19200/38400/57600/115200
Data bit length	8	7/8
Parity check bit	NONE	EVEN/ODD/NONE

Stop bit length	1	1/2
PLC station number	1	1~31
HMI station number	0	0~255

Support functions	Yes/No
Offline simulation	Yes
Online simulation	Yes
Extension mode	No

3. Operable register and address range

Register Name	Address Format	Input Range	Remark
I	1:ddd/o	1:0/0~1:255/7	Bit: input image register, read only
O	0:ddd/o	0:0/0~0:255/7	Bit: output image register
B	ddd:ddd/o	3:0/0~255:255/7	Bit: bit storage
S_Bit	2:ddd/o	2:0/0~2:255/7	Bit: system status bit
N_Bit	ddd:ddd/o	7:0/0~255:255/7	Bit: bit of data register word
S	2:ddd	2:0~2:255	Bit: system status word
N	ddd:ddd	7:0~255:255	Word: data register
F	ddd:ddd	8:0~255:255	Word: float register
T_ACC	ddd:ddd	4:0~255:255	Word: ACC value of timer
T_PRE	ddd:ddd	4:0~255:255	Word: PRE value of timer
C_ACC	ddd:ddd	5:0~255:255	Word: ACC value of counter
C_PRE	ddd:ddd	5:0~255:255	Word: PRE value of counter

- Note
- d indicates decimal, and the input range is 0-9;
 - O indicates octal, and the input range is 0-7;
 - “Bit” in the remark indicates the register can be used as bit only;
 - ”word” in the remark indicates the register can be used as word only;
 - “Read only” in the remark indicates the register can be read only rather than write-in;
 - Different device models may support different register names and the range may be different. Detailed names and range refer to the relative technical documents for connected device.

10.3. Delta device driver

This device driver is used by SKWorkshop series touch screen to read and write the data or status of Delta DVP series PLC register. It establishes serial port communication with the connection port of Delta DVP series PLC through the serial port device so as to operate Delta DVP series PLC. Please read carefully this Chapter and relative technical manual of Delta DVP series PLC before using the driver.

How to establish connection with Delta DVP series PLC

1. Hardware connection

Connection cable:
RS232

SK series touch screen COM1/COM2		Delta DVP series
RX	5	TX
TX	4	RX
GND	8	GND

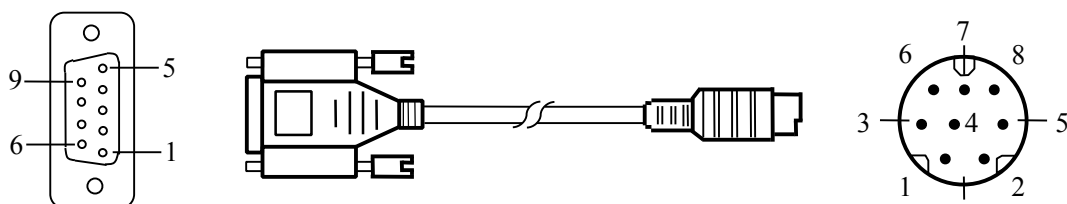

SK series touch screen uses DB9F connector. Delta DVP series PLC terminal is MD8M.

RS485

SK series touch screen COM1/COM2	Delta DVP series
8	TX-
9	TX+

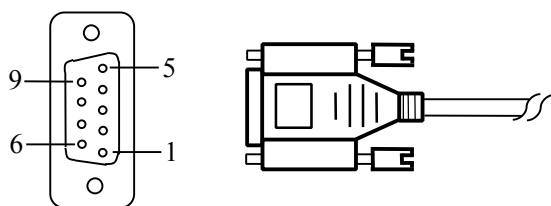

SK series touch screen uses DB9F connector. Delta DVP series PLC terminal is two-wire terminal.

2. Software setting

- ✓ Select Delta Corporation in the connection device service
- ✓ Select the corresponding item in the connection device service according to the PLC model or supporting protocol.
- ✓ Make sure the communication parameters and PLC station number of touch screen is consistent with that of PLC.
- ✓ Please refer to relative technical documents of Delta DVP series PLC for device setting.

Default connection parameters of SK series touch screen

Setting Item	Default Parameters	Setting Range
PLC	Delta DVP Series	Delta DVP Series
Communication port	RS232	RS232/RS422/RS485
Baud rate	9600	1200/2400/4800/9600/19200/38400/57600/115200
Data bit length	7	7/8
Parity check bit	EVEN	EVEN/ODD/NONE
Stop bit length	1	1/2
PLC station number	1	0~255
HMI station number	0	0~255

Support functions	Yes/No
Offline simulation	Yes
Online simulation	Yes
Extension mode	Yes

3. Operable register and address range

Register Name	Address Format	Input Range	Remark
X	ooo	0~377	Bit: input contact, read only
Y	ooo	0~377	Bit: output contact

M	dddd	0~4095	Bit: auxiliary relay
S	dddd	0~1023	Bit: internal relay
T	ddd	0~255	Bit: timer status
C	ddd	0~255	Bit: counter status
D	dddd	0~9999	Word: data register
TV	ddd	0~255	Word: current value of timer
CV	ddd	0~199	Word: current value of counter
CV32	ddd	200~255	Double words: current value of 32-bit counter

- Note
- d indicates decimal, and the input range is 0-9;
 - O indicates octal, and the input range is 0-7;
 - “Bit” in the remark indicates the register can be used as bit only;
 - ”word” in the remark indicates the register can be used as word only;
 - ”double words” in the remark indicates the data type of register in configuration must be 32-bit;
 - “Read only” in the remark indicates the register can be read only rather than write-in;
 - Different device models may support different register names and the range may be different. Detailed names and range refer to the relative technical documents for connected device.

10.4. Emerson device driver

This device driver is used by SKWorkshop series touch screen to read and write the data or status of Emerson EC series PLC register. It establishes serial port communication with the serial port of Emerson EC series PLC through the serial port of touch screen so as to operate Emerson EC series PLC. Please read carefully this Chapter and relative technical manual of Emerson EC series before using the driver.

How to establish connection with Emerson EC series PLC

1. Hardware connection

Connection cable:
RS232

SK series touch screen COM1/COM2		Emerson EC series	
2	RX	5	TX
3	TX	4	RX
5	GND	3	GND

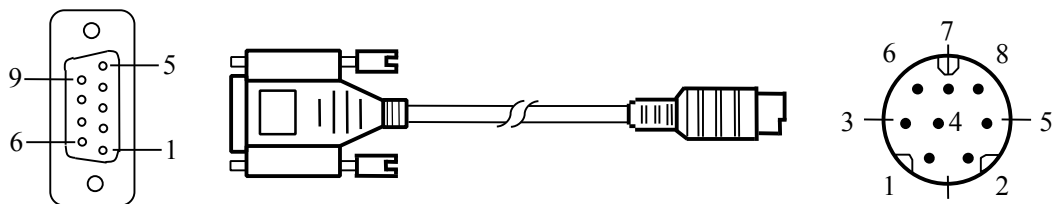

SK series touch screen uses DB9F connector. Emerson EC series PLC terminal is MD8M.

2. Software setting

- ✓ Select Emerson Network Power in the connection device service.
- ✓ Select the corresponding item in the connection device service according to the PLC model or supporting protocol.
- ✓ Make sure the communication parameters and PLC station number of touch screen is consistent with that of PLC.
- ✓ Please refer to relative technical documents of Emerson EC series PLC for device setting.

Default connection parameters of SK series touch screen

Setting Item	Default Parameters	Setting Range
PLC	EC Series (RTU)	EC Series (RTU)

Communication port	RS232	RS232/RS422/RS485
Baud rate	19200	1200/2400/4800/9600/19200/38400/57600/115200
Data bit length	8	7/8
Parity check bit	EVEN	EVEN/ODD/NONE
Stop bit length	1	1/2
PLC station number	1	0~255
HMI station number	0	0~255

Support functions	Yes/No
Offline simulation	Yes
Online simulation	Yes
Extension mode	Yes

3. Operable register and address range

Register Name	Address Format	Input Range	Remark
X	ooo	0~377	Bit: input contact, read only
Y	ooo	0~377	Bit: output contact
M	dddd	0~7999	Bit: internal relay
SM	ddd	0~255	Bit: special internal relay
S	ddd	0~999	Bit: step relay
T	ddd	0~255	Bit: timer status
C	ddd	0~255	Bit: counter status
D	dddd	0~7999	Word: data register
SD	ddd	0~255	Word: special data register
TV	ddd	0~255	Word: current value of timer
CV	ddd	0~255	Word: current value of counter
Z	dd	0~15	Word: indexed addressing register

- Note**
- d indicates decimal, and the input range is 0-9;
 - O indicates octal, and the input range is 0-7;
 - “Bit” in the remark indicates the register can be used as bit only;
 - ”word” in the remark indicates the register can be used as word only;
 - “Read only” in the remark indicates the register can be read only rather than write-in;
 - Different device models may support different register names and the range may be different. Detailed names and range refer to the relative technical documents for connected device.

10.5. Fatek device driver

This device driver is used by SKWorkshop series touch screen to read and write the data or status of Fatek FB series PLC register. It establishes serial port communication with the serial port of Fatek FB series PLC through the serial port of touch screen so as to operate Fatek FB series PLC. Please read carefully this Chapter and relative technical manual of Fatek FB series PLC before using the driver.

How to establish connection with Fatek FB series PLC

1. Hardware connection

Connection cable:
RS232



COM1/COM2		series	
2	RX	1	TX
3	TX	2	RX
5	GND	4	GND

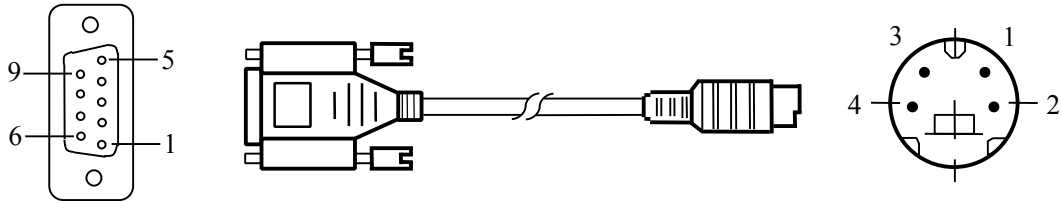

SK series touch screen uses DB9F connector. Fatek FB series PLC terminal is MD8M.

2. Software setting

- ✓ Select Fatek Automation Corp. in the connection device service
- ✓ Select the corresponding item in the connection device service according to the PLC model or supporting protocol.
- ✓ Make sure the communication parameters and PLC station number of touch screen is consistent with that of PLC.
- ✓ Please refer to relative technical documents of Fatek FB series PLC for device setting.

Default connection parameters of SK series touch screen

Setting Item	Default Parameters	Setting Range
PLC	Fatek FB Series	Fatek FB Series
Communication port	RS232	RS232
Baud rate	9600	1200/2400/4800/9600/19200/38400/57600/115200
Data bit length	7	7/8
Parity check bit	EVEN	EVEN/ODD/NONE
Stop bit length	1	1/2
PLC station number	1	0~255
HMI station number	0	0~255

Support functions	Yes/No
Offline simulation	Yes
Online simulation	Yes
Extension mode	Yes

3. Operable register and address range

Register Name	Address Format	Input Range	Remark
X	dddd	0~9999	Bit: input contact, read only
Y	dddd	0~9999	Bit: output relay
M	dddd	0~9999	Bit: internal relay
S	dddd	0~9999	Bit: step relay
T	dddd	0~9999	Bit: timer status, read only
C	dddd	0~9999	Bit: counter status, read only
R	dddd	0~9999	Word: data register
D	dddd	0~9999	Word: data register
TR	dddd	0~9999	Word: current value of timer
CR	dddd	0~9999	Word: current value of counter

F	dddd	0~9999	Word: file register
DRC	ddd	200~255	Double-word: current value of 32-bit counter

- Note
- d indicates decimal, and the input range is 0-9;
 - O indicates octal, and the input range is 0-7;
 - “Bit” in the remark indicates the register can be used as bit only;
 - ”word” in the remark indicates the register can be used as word only;
 - ”double words” in the remark indicates the data type of register in configuration must be 32-bit;
 - “Read only” in the remark indicates the register can be read only rather than write-in;
 - Different device models may support different register names and the range may be different. Detailed names and range refer to the relative technical documents for connected device.

10.6. Fuji device driver

This device driver is used by SKWorkshop series touch screen to read and write the data or status of Fuji NB series PLC register. It establishes serial port communication with the serial port of Fuji NB series PLC through the serial port of touch screen so as to operate Fuji NB series PLC. Please read carefully this Chapter and relative technical manual of Fuji NB series PLC before using the driver.

How to establish connection with Fuji NB series PLC

1. Hardware connection

Connection cable:
RS422

SK series touch screen COM1/COM2		Fuji NB series	
6	RX-	4	TX-
7	RX+	3	TX+
8	TX-	6	RX-
9	TX+	5	RX+

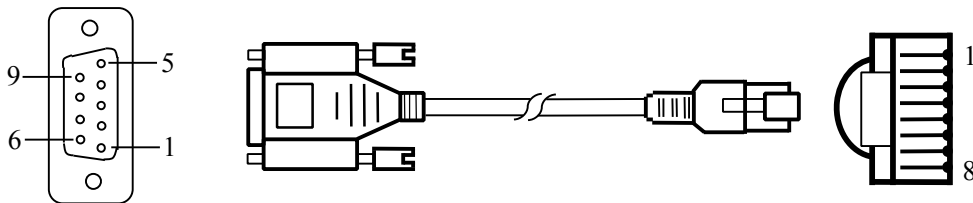

SK series touch screen uses DB9F connector. Fuji NB series PLC terminal is RJ45.

2. Software setting

- ✓ Select Fuji Electric Corporation in the connection device service
- ✓ Select the corresponding item in the connection device service according to the PLC model or supporting protocol.
- ✓ Make sure the communication parameters and PLC station number of touch screen is consistent with that of PLC.
- ✓ Please refer to relative technical documents of Fuji NB series PLC for device setting.

Default connection parameters of SK series touch screen

Setting Item	Default Parameters	Setting Range
PLC	Fuji NB Series	Fuji NB Series
Communication port	RS422	RS422
Baud rate	19200	1200/2400/4800/9600/19200/38400/57600/115200
Data bit length	8	7/8
Parity check bit	ODD	EVEN/ODD/NONE
Stop bit length	1	1/2
PLC station number	0	0~255

HMI station number	0	0~255
--------------------	---	-------

Support functions	Yes/No
Offline simulation	Yes
Online simulation	Yes
Extension mode	Yes

3. Operable register and address range

Register Name	Address Format	Input Range	Remark
X	hhh	0~7ff	Bit: input contact, read only
Y	hhh	0~7ff	Bit: output contact
M	hhhh	0~7fff	Bit: internal relay
SM	hhhh	8000~81ff	Bit: internal relay
L	hhh	0~5ff	Bit: lock-up relay
S	hh	0~ff	Bit: step relay
T	hhh	0~1ff	Bit: timer status
C	hh	0~ff	Bit: counter status
D	hhhh	0~7fff	Bit: data register
SD	hhhh	8000~80ff	Bit: data register
TV	hhh	0~1ff	Word: current value of timer
CV	hh	0~ff	Word: current value of counter

- Note
- h indicates hexadecimal, and the input range is 0-9, a-f;
 - O indicates octal, and the input range is 0-7;
 - “Bit” in the remark indicates the register can be used as bit only;
 - ”word” in the remark indicates the register can be used as word only;
 - “Read only” in the remark indicates the register can be read only rather than write-in;
 - Different device models may support different register names and the range may be different. Detailed names and range refer to the relative technical documents for connected device.

10.7. GE device driver

This device driver is used by SKWorkshop series touch screen to read and write the data or status of GE Fanuc series PLC register. It establishes serial port communication with the serial port of GE Fanuc series PLC through the serial port of touch screen so as to operate GE Fanuc series PLC. Please read carefully this Chapter and relative technical manual of GE Fanuc series PLC before using the driver.

How to establish connection with GE Fanuc series PLC

1. Hardware connection

Connection cable:
RS232

SK series touch screen COM1/COM2		GE Fanuc series	
2	RX	4	TX
3	TX	3	RX
5	GND	8	GND

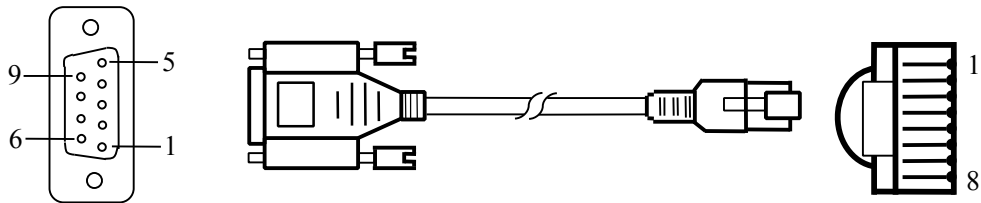

SK series touch screen uses DB9F connector. GE Fanuc series PLC terminal is RJ45.

2. Software setting

- ✓ Select GE Corporation in the connection device service
- ✓ Select the corresponding item in the connection device service according to the PLC model or supporting protocol.
- ✓ Make sure the communication parameters and PLC station number of touch screen is consistent with that of PLC.
- ✓ Please refer to relative technical documents of GE Fanuc series PLC for device setting.

Default connection parameters of SK series touch screen

Setting Item	Default Parameters	Setting Range
PLC	GE Fanuc SNP-X	GE Fanuc SNP-X/ GE Fanuc CCM
Communication port	RS232	RS232/RS422/RS485
Baud rate	19200	1200/2400/4800/9600/19200/38400/57600/115200
Data bit length	8	7/8
Parity check bit	ODD	EVEN/ODD/NONE
Stop bit length	1	1/2
PLC station number	0	0~255
HMI station number	0	0~255

Support functions	Yes/No
Offline simulation	Yes
Online simulation	Yes
Extension mode	No

3. Operable register and address range

Register Name	Address Format	Input Range	Remark
%I	dddd	1~10000	Bit: Discrete Input
%Q	dddd	1~10000	Bit: Discrete Output
%M	dddd	1~10000	Bit: Internal Use
%S	ddd	1~128	Bit: System Use, Read only
%SA	ddd	1~128	Bit: System Use, Read only
%SB	ddd	1~128	Bit: System Use, Read only
%SC	ddd	1~128	Bit: System Use, Read only
%T	ddd	1~256	Bit: Temporary Status
%G	ddd	1~7680	Bit: Genius? Global
%AI	dddd	1~10000	Word: Analog Input
%AQ	dddd	1~10000	Word: Analog Output
%R	dddd	1~32640	Word: Register memory

Note

- d indicates decimal, and the input range is 0-9;
- O indicates octal, and the input range is 0-7;

- “Bit” in the remark indicates the register can be used as bit only;
- ”word” in the remark indicates the register can be used as word only;
- “Read only” in the remark indicates the register can be read only rather than write-in;
- Different device models may support different register names and the range may be different. Detailed names and range refer to the relative technical documents for connected device.

10.8. HaiWell device driver

This device driver is used by SKWorkshop series touch screen to read and write the data or status of Haiwell E/S/H series PLC register. It establishes serial port communication with the serial port of Haiwell E/S/H series PLC through the serial port of touch screen so as to operate Haiwell E/S/H series PLC. Please read carefully this Chapter and relative technical manual of Haiwell E/S/H series PLC before using the driver.

How to establish connection with Haiwell E/S/H series PLC

1. Hardware connection

Connection cable:
RS232

SK series touch screen COM1/COM2		HaiWell E/S/H series	
2	RX	2	TX
3	TX	1	RX
5	GND	3	GND

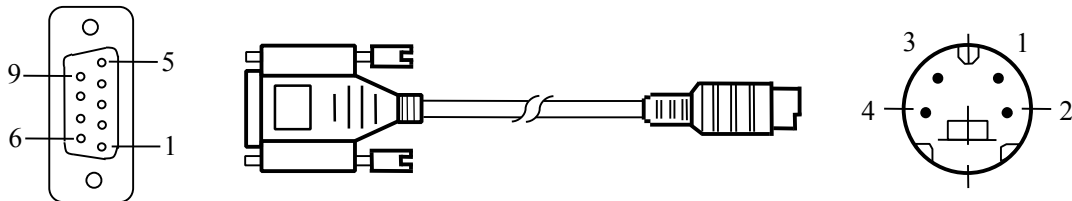

SK series touch screen uses DB9F connector. Haiwell E/S/H series PLC terminal is MD4M.

2. Software setting

- ✓ Select Haiwell Technology Corp. in the connection device service
- ✓ Select the corresponding items in the connection device service according to the PLC model or supporting protocol.
- ✓ Make sure the communication parameters and PLC station number of touch screen is consistent with that of PLC.
- ✓ Please refer to relative technical documents of Haiwell E/S/H series PLC for device setting.

Default connection parameters of SK series touch screen

Setting Item	Default Parameters	Setting Range
PLC	Haiwell E/S Series	MicroLogix DF1_CRC/MicroLogix DF1_BCC
Communication port	RS232	RS232/RS422/RS485
Baud rate	19200	1200/2400/4800/9600/19200/38400/57600/115200
Data bit length	8	7/8
Parity check bit	NONE	EVEN/ODD/NONE
Stop bit length	2	1/2
PLC station number	1	1~31
HMI station number	0	0~255

Support functions	Yes/No
Offline simulation	Yes
Online simulation	Yes

Extension mode	No
----------------	----

3. Operable register and address range

Register Name	Address Format	Input Range	Remark
I	1:ddd/o	1:0/0~1:255/7	Bit: input image register, read only
O	0:ddd/o	0:0/0~0:255/7	Bit: output image register
B	ddd:ddd/o	3:0/0~255:255/7	Bit: bit memory
S_Bit	2:ddd/o	2:0/0~2:255/7	Bit: system status bit
N_Bit	ddd:ddd/o	7:0/0~255:255/7	Bit: bit of data register word
S	2:ddd	2:0~2:255	Word: system status word
N	ddd:ddd	7:0~255:255	Word: data register
F	ddd:ddd	8:0~255:255	Word: float register
T_ACC	ddd:ddd	4:0~255:255	Word: ACC value of timer
T_PRE	ddd:ddd	4:0~255:255	Word: PRE value of timer
C_ACC	ddd:ddd	5:0~255:255	Word: ACC value of counter
C_PRE	ddd:ddd	5:0~255:255	Word: PRE value of counter

- Note**
- d indicates decimal, and the input range is 0-9;
 - “Bit” in the remark indicates the register can be used as bit only;
 - ”word” in the remark indicates the register can be used as word only;
 - “Read only” in the remark indicates the register can be read only rather than write-in;
 - Different device models may support different register names and the range may be different. Detailed names and range refer to the relative technical documents for connected device.

10.9. Hitachi device driver

This device driver is used by SKWorkshop series touch screen to read and write the data or status of Hitachi E/EH series PLC register. It establishes serial port communication with the serial port of Hitachi E/EH series PLC through the serial port of touch screen so as to operate Hitachi E/EH series PLC. Please read carefully this Chapter and relative technical manual of Hitachi E/EH series PLC before using the driver.

How to establish connection with Hitachi E/EH series PLC

1. Hardware connection

Connection cable:
RS232

SK series touch screen COM1/COM2		Hitachi E/EH series	
2	RX	5	SD
3	TX	6	RD
5	GND	1	SG
		4	PHL
		7	DR

4-7
Short
conne
ction

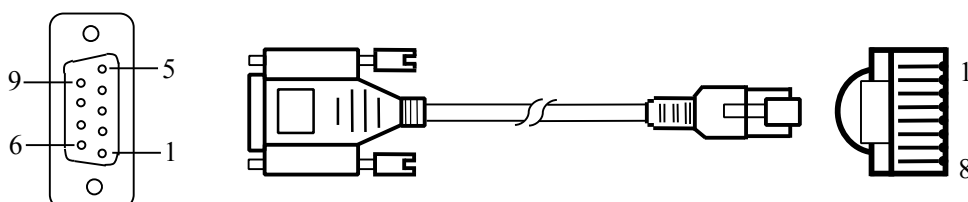

SK series touch screen uses DB9F connector. AB device terminal is RJ45.

2. Software setting

- ✓ Select Hitachi Industrial in the connection device service.
- ✓ Select the corresponding item in the connection device service according to the PLC model or supporting protocol.
- ✓ Make sure the communication parameters and PLC station number of touch screen is consistent with that of PLC.
- ✓ Please refer to relative technical documents of Hitachi E/EH series PLC for device setting.

Default connection parameters of SK series touch screen

Setting Item	Default Parameters	Setting Range
PLC	Hitachi E/EH Series	Hitachi E/EH Series
Communication port	RS232	RS232/RS422/RS485
Baud rate	19200	1200/2400/4800/9600/19200/38400/57600/115200
Data bit length	7	7/8
Parity check bit	EVEN	EVEN/ODD/NONE
Stop bit length	1	1/2
PLC station number	0	0~255
HMI station number	0	0~255

Support functions	Yes/No
Offline simulation	Yes
Online simulation	Yes
Extension mode	Yes

3. Operable register and address range

Register Name	Address Format	Input Range	Remark
X	hhhh	0~ffff	Bit: external switch value input, read only
Y	hhhh	0~ffff	Bit: external switch value output
M	hhhh	0~ffff	Bit: internal relay
R	hhhh	0~ffff	Bit: internal register
T	hhhh	0~ffff	Bit: timer status
L	hhhh	0~ffff	Bit: link relay
WX	hhhh	0~ffff	Word: external switch value input
WY	hhhh	0~ffff	Word: external switch value output
WM	hhhh	0~ffff	Word: internal relay
WR	hhhh	0~ffff	Word: internal register
WL	hhhh	0~ffff	Word: link relay
TC	hhhh	0~ffff	Word: current value of timer/counter

Note:

- h indicates hexadecimal, and the input range is 0-9, a-f;
- "word" in the remark indicates the register can be used as word only;
- "Bit" in the remark indicates the register can be used as bit only;
- "Read only" in the remark indicates the register can be read only rather than write-in;
- Different device models may support different register names and the range may be different. Detailed names and range refer to the relative technical documents for connected device.

10.10. HollySys device driver

This device driver is used by SKWorkshop series touch screen to read and write the data or status of HollySys LM series PLC register. It establishes serial port communication with the serial port of HollySys LM series PLC through the serial port of touch screen so as to operate HollySys LM series PLC. Please read carefully this Chapter and relative technical manual of HollySys LM series PLC before using the driver.

How to establish connection with HollySys LM series PLC

1. Hardware connection

Connection cable:
RS232

SK series touch screen COM1/COM2		HollySys LM series	
2	RX	3	TX
3	TX	2	RX
5	GND	5	GND

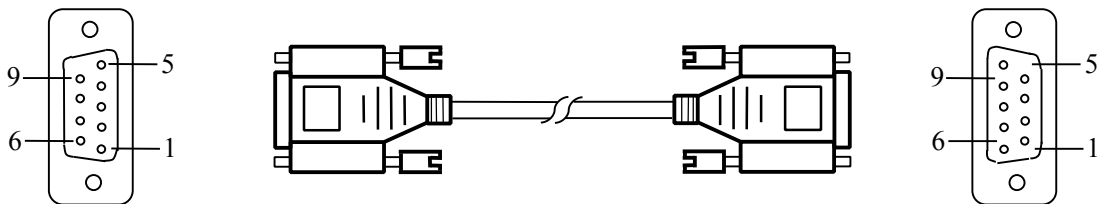

SK series touch screen uses DB9F connector. HollySys LM series PLC terminal is DB9M.

2. Software setting

- ✓ Select HollySys Group in the connection device service
- ✓ Select the corresponding item in the connection device service according to the PLC model or supporting protocol.
- ✓ Make sure the communication parameters and PLC station number of touch screen is consistent with that of PLC.
- ✓ Please refer to relative technical documents of HollySys LM series PLC for device setting.

Default connection parameters of SK series touch screen

Setting Item	Default Parameters	Setting Range
PLC	HollySys LM Series	HollySys LM Series
Communication port	RS232	RS232/RS422/RS485
Baud rate	38400	1200/2400/4800/9600/19200/38400/57600/115200
Data bit length	8	7/8
Parity check bit	NONE	EVEN/ODD/NONE
Stop bit length	1	1/2
PLC station number	51	0~255
HMI station number	0	0~255

Support functions	Yes/No
Offline simulation	Yes
Online simulation	Yes
Extension mode	No

3. Operable register and address range

Register Name	Address Format	Input Range	Remark
IX	ddd.o	0.0~511.7	Bit: I storage area, read only
QX	ddd.o	0.0~511.7	Bit: Q storage area

MX	dddd.o	0.0~7816.7	Bit: M storage area
IW	ddd	0~510	Word: I storage area, 8-bit register, each word for two addresses
QW	ddd	0~510	Word: Q storage area, 8-bit register, each word for two addresses
MW	dddd	0~8190	Word: M storage area, 8-bit register, each word for two addresses

- Note**
- d indicates decimal, and the input range is 0-9;
 - O indicates octal, and the input range is 0-7;
 - "word" in the remark indicates the register can be used as word only;
 - "Bit" in the remark indicates the register can be used as bit only;
 - "8-bit register" in the remark indicates that the address space for the adjacent two words in register is 2;
 - "Read only" in the remark indicates the register can be read only rather than write-in;
 - Different device models may support different register names and the range may be different. Detailed names and range refer to the relative technical documents for connected device.

10.11. IDEC device driver

This device driver is used by SKWorkshop series touch screen to read and write the data or status of Macro Smart FC4A/FC5A series PLC register. It establishes serial port communication with the serial port of Macro Smart FC4A/FC5A series PLC through the serial port of touch screen so as to operate Macro Smart FC4A/FC5A series PLC. Please read carefully this Chapter and relative technical manual of Macro Smart FC4A/FC5A series PLC before using the driver.

How to establish connection with Macro Smart FC4A/FC5A series PLC

1. Hardware connection

Connection cable:
RS232

SK series touch screen COM1/COM2		Macro Smart FC4A/FC5A	
2	RX	3	TX
3	TX	4	RX
5	GND	6	GND
		7	GND
		6-7 short connect ion	

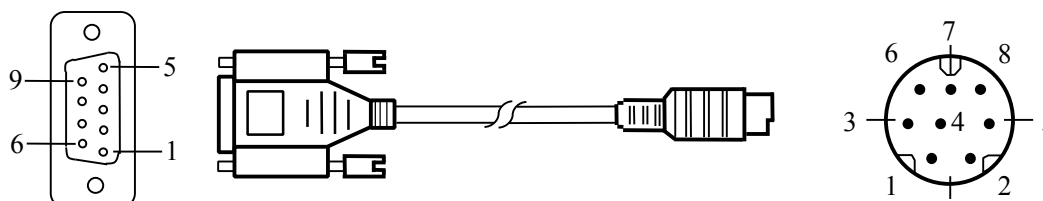

SK series touch screen uses DB9F connector. Macro Smart FC4A/FC5A series PLC terminal is MD8M.

2. Software setting

- ✓ Select Allen-Bradley in the connection device service.
- ✓ Select the corresponding item in the connection device service according to the PLC model or supporting protocol.
- ✓ Make sure the communication parameters and PLC station number of touch screen is consistent with that of PLC.
- ✓ Please refer to relative technical documents of Macro Smart FC4A/FC5A series PLC for device setting.

Default connection parameters of SK series touch screen

Setting Item	Default Parameters	Setting Range
PLC	Macro Smart FC4A	Macro Smart FC4A/ Macro Smart FC5A

Communication port	RS232	RS232/RS422/RS485
Baud rate	9600	1200/2400/4800/9600/19200/38400/57600/115200
Data bit length	7	7/8
Parity check bit	EVEN	EVEN/ODD/NONE
Stop bit length	1	1/2
PLC station number	1	0~255
HMI station number	0	0~255

Support functions	Yes/No
Offline simulation	Yes
Online simulation	Yes
Extension mode	No

3. Operable register and address range
Macro Smart FC4A

Register Name	Address Format	Input Range	Remark
I	ddd	0~255	Bit: external switch value input, read only
Q	ddd	0~255	Bit: external switch value output
M	dddd	0~1023	Bit: internal relay
SM	ddd	0~215	Bit: internal register
R	ddd	0~255	Word: shift register
D	ddd	0~1299	Word: data register
TV	ddd	0~127	Word: current value of timer
CV	ddd	0~127	Word: current value of counter

Macro Smart FC5A

Register Name	Address Format	Input Range	Remark
I	ddd	0~255	Bit: external switch value input, read only
Q	ddd	0~255	Bit: external switch value output
M	dddd	0~2047	Bit: internal relay
SM	ddd	0~215	Bit: internal register
R	ddd	0~255	Word: shift register
D	ddd	0~42000	Word: data register
TV	ddd	0~255	Word: current value of timer
CV	ddd	0~255	Word: current value of counter

-
- Note
- d indicates decimal, and the input range is 0-9;
 - “Bit” in the remark indicates the register can be used as bit only;
 - ”word” in the remark indicates the register can be used as word only;
 - “Read only” in the remark indicates the register can be read only rather than write-in;
 - Different device models may support different register names and the range may be different. Detailed names and range refer to the relative technical documents for connected device.
-

10.12. Inovance device driver

This device driver is used by SKWorkshop series touch screen to read and write the data or status of Inovance H1u/H2u series PLC register. It establishes serial port communication with the serial port of Inovance H1u/H2u series PLC through the serial port of touch screen so as to operate Inovance H1u/H2u series PLC. Please read carefully this Chapter and relative technical manual of Inovance H1u/H2u series PLC before using the driver.

How to establish connection with H1u/H2u series PLC

1. Hardware connection

Connection cable:
RS422

SK series touch screen COM1/COM2		Inovance H1u/H2u series	
6	RX-	4	TX-
7	RX+	7	TX+
8	TX-	1	RX-
9	TX+	2	RX+

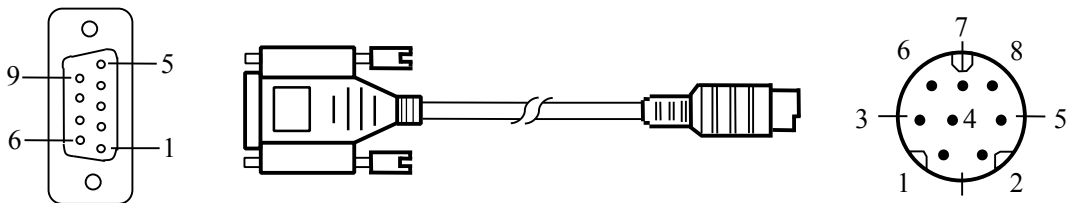

SK series touch screen uses DB9F connector. Inovance H1u/H2u series PLC terminal is MD8M.

2. Software setting

- ✓ Select Inovance Technology Corp in the connection device service
- ✓ Select the corresponding item in the connection device service according to the PLC model or supporting protocol.
- ✓ Make sure the communication parameters and PLC station number of touch screen is consistent with that of PLC.
- ✓ Please refer to relative technical documents of Inovance H1u/H2u series PLC for device setting.

Default connection parameters of SK series touch screen

Setting Item	Default Parameters	Setting Range
PLC	H1u/H2u	H1u/H2u
Communication port	RS422	RS232/RS422/RS485
Baud rate	9600	1200/2400/4800/9600/19200/38400/57600/115200
Data bit length	7	7/8
Parity check bit	EVEN	EVEN/ODD/NONE
Stop bit length	1	1/2
PLC station number	0	0~255
HMI station number	0	0~255

Support functions	Yes/No
Offline simulation	Yes
Online simulation	Yes
Extension mode	No

3. Operable register and address range

Register Name	Address Format	Input Range	Remark
---------------	----------------	-------------	--------

X	oooo	0~377	Bit: input coil, read only
Y	oooo	0~377	Bit: output coil
M	dddd	0~7999	Bit: intermediate relay
SM	dddd	8000~8999	Bit: special intermediate relay
S	dddd	0~999	Bit: status bit
T	dddd	0~256	Bit: timer status
C	dddd	0~256	Bit: counter status
D	dddd	0~7999	Word: register
SD	dddd	8000~8999	Word: special register
TV	dddd	0~255	Word: current value of timer
CV	dddd	0~199	Word: current value of counter
CV32	dddd	200~255	Double-word: current value of 32-bit counter

- Note
- d indicates decimal, and the input range is 0-9;
 - O indicates octal, and the input range is 0-7;
 - "word" in the remark indicates the register can be used as word only;
 - "double words" in the remark indicates the data type of register in configuration must be 32-bit;
 - "Bit" in the remark indicates the register can be used as bit only;
 - "Read only" in the remark indicates the register can be read only rather than write-in;
 - Different device models may support different register names and the range may be different. Detailed names and range refer to the relative technical documents for connected device.

10.13. Keyence device driver

This device driver is used by SKWorkshop series touch screen to read and write the data or status of Keyence KV/VisualKV series PLC register. It establishes serial port communication with the serial port of Keyence KV/VisualKV series PLC through the serial port of touch screen so as to operate Keyence KV/VisualKV series PLC. Please read carefully this Chapter and relative technical manual of Keyence KV/VisualKV series PLC before using the driver.

How to establish connection with Keyence KV/VisualKV series PLC

1. Hardware connection

Connection cable:
RS232

SK series touch screen COM1/COM2		Keyence KV/VisualKV series	
2	RX	2	TX
3	TX	4	RX
5	GND	3	GND

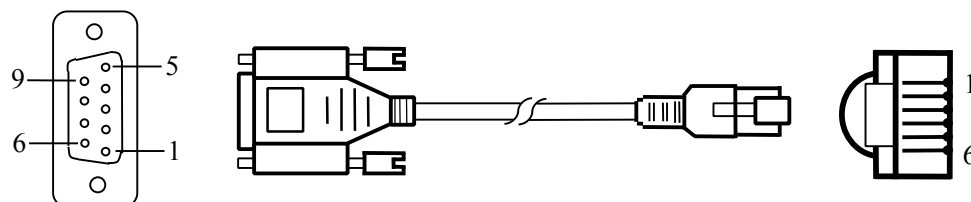

SK series touch screen uses DB9F connector. Keyence KV/VisualKV series PLC terminal is MD8M.

2. Software setting

- ✓ Select Keyence Corporation in the connection device service
- ✓ Select the corresponding item in the connection device service according to the PLC model or supporting protocol.
- ✓ Make sure the communication parameters and PLC station number of touch screen is consistent with that of PLC.
- ✓ Please refer to relative technical documents of Keyence KV/VisualKV series PLC for device setting.

Default connection parameters of SK series touch screen

Setting Item	Default Parameters	Setting Range
PLC	KV-1000/700 KV-L20(R)	KV-1000/700 KV-L20(R)/ KV-10/16/24/40 KV-P16
Communication port	RS232	RS232/RS422/RS485
Baud rate	9600	1200/2400/4800/9600/19200/38400/57600/115200
Data bit length	8	7/8
Parity check bit	EVEN	EVEN/ODD/NONE
Stop bit length	1	1/2
PLC station number	0	0~255
HMI station number	0	0~255

Support functions	Yes/No
Offline simulation	Yes
Online simulation	Yes
Extension mode	No

3. Operable register and address range
KV-1000/700 KV-L20(R)

Register Name	Address Format	Input Range	Remark
R	dddDD	0~59915	Bit: input/output relay
MR	dddDD	0~99915	Bit: internal auxiliary relay
LR	dddDD	0~99915	Bit: lock-up relay
CR	ddDD	0~3915	Bit: control relay
T	dddd	0~3999	Bit: timer
C	dddd	0~3999	Bit: counter
DM	dddddd	0~65534	Word: data storage
EM	dddddd	0~65534	Word: expanding data storage
FM	dddddd	0~32766	Word: file register
TM	ddd	0~511	Word: temporary data storage
CM	dddddd	0~11998	Word: control storage
TV	dddd	0~3999	Word: current value of timer
CV	dddd	0~3999	Word: current value of counter

KV-10/16/24/40 KV-P16

Register Name	Address Format	Input Range	Remark
RLY	dddDD	0~99915	Bit: relay
T	dddd	0~999	Bit: timer
C	dddd	0~999	Bit: counter
DM	dddddd	0~9999	Word: data storage
TM	ddd	0~99	Word: temporary data storage
TV_c	dddd	0~999	Word: current value of timer
TV_p	dddd	0~999	Word: preset value of timer
CV_c	dddd	0~999	Word: current value of counter
CV_p	dddd	0~999	Word: preset value of counter

CTH	dddd	0~9	Word: current value of high-speed counter
-----	------	-----	---

- Note
- d indicates decimal, and the input range is 0-9;
 - DD indicates the hexadecimal, and the input range is 0-15;
 - "word" in the remark indicates the register can be used as word only;
 - "Bit" in the remark indicates the register can be used as bit only;
 - Different device models may support different register names and the range may be different. Detailed names and range refer to the relative technical documents for connected device.

10.14. Koyo device driver

This device driver is used by SKWorkshop series touch screen to read and write the data or status of Koyo SN series PLC register. It establishes serial port communication with the serial port of Koyo SN series PLC through the serial port of touch screen so as to operate Koyo SN series PLC. Please read carefully this Chapter and relative technical manual of Koyo SN series PLC before using the driver.

How to establish connection with Koyo SN series PLC

1. Hardware connection

Connection cable:
RS232

SK series touch screen COM1/COM2		Koyo SN series	
2	RX	4	TX
3	TX	3	RX
5	GND	1	GND

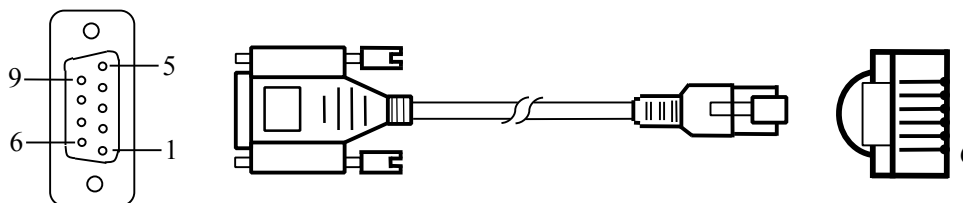

SK series touch screen uses DB9F connector. Koyo SN series PLC terminal is 6-pin crystal plug.

2. Software setting

- ✓ Select Koyo Electronics in the connection device service.
- ✓ Select the corresponding item in the connection device service according to the PLC model or supporting protocol.
- ✓ Make sure the communication parameters and PLC station number of touch screen is consistent with that of PLC.
- ✓ Please refer to relative technical documents of Koyo SN series PLC for device setting.

Default connection parameters of SK series touch screen

Setting Item	Default Parameters	Setting Range
PLC	Koyo SN Series	Koyo SN Series
Communication port	RS232	RS232/RS422/RS485
Baud rate	9600	1200/2400/4800/9600/19200/38400/57600/115200
Data bit length	8	7/8
Parity check bit	ODD	EVEN/ODD/NONE
Stop bit length	1	1/2
PLC station number	1	0~255
HMI station number	0	0~255
Support functions	Yes/No	

Offline simulation	Yes
Online simulation	Yes
Extension mode	Yes

3. Operable register and address range

Register Name	Address Format	Input Range	Remark
I	ooo	0~377	Bit: input relay, read only
O	ooo	0~377	Bit: output relay
M	oooo	0~1177	Bit: auxiliary relay
SP	ooo	0~777	Bit: special auxiliary relay
S	ooo	0~177	Bit: step relay
T	ooo	0~177	Bit: timer
C	ooo	0~177	Bit: counter
R	ooooo	0~13777	Word: data register
TR	ooooo	0~13777	Word: current value of timer
CR	ooooo	0~13777	Word: current value of counter
SR	ooooo	0~13777	Word: special data register

- Note
- O indicates octal, and the input range is 0-7;
 - "word" in the remark indicates the register can be used as word only;
 - "double words" in the remark indicates the data type of register in configuration must be 32-bit;
 - "Bit" in the remark indicates the register can be used as bit only;
 - "Read only" in the remark indicates the register can be read only rather than write-in;
 - Different device models may support different register names and the range may be different. Detailed names and range refer to the relative technical documents for connected device.

10.15. LG device driver

This device driver is used by SKWorkshop series touch screen to read and write the data or status of LG Master-K series PLC register. It establishes serial port communication with the serial port of LG Master-K series PLC through the serial port of touch screen so as to operate LG Master-K series PLC. Please read carefully this Chapter and relative technical manual of LG Master-K series PLC before using the driver.

How to establish connection with LG Master-K series PLC

1. Hardware connection
Connection cable:
RS232- use CNet protocol

SK series touch screen COM1/COM2		LG Master-K	
2	RX	7	TX
3	TX	4	RX
5	GND	5	GND

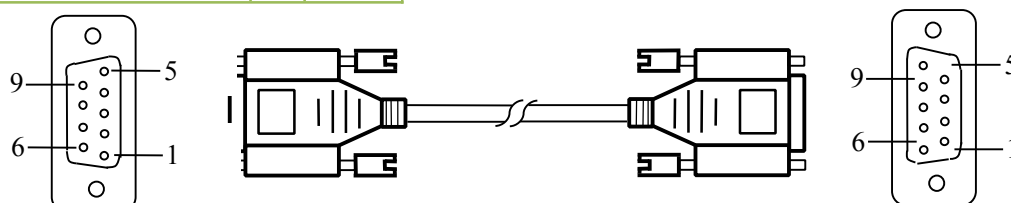

SK series touch screen uses DB9F connector. LG Master-K series PLC terminal is DB9M.

RS232- use KLoader protocol

SK series touch screen COM1/COM2		LG Master-K	
2	RX	3	TX
3	TX	2	RX
5	GND	5	GND

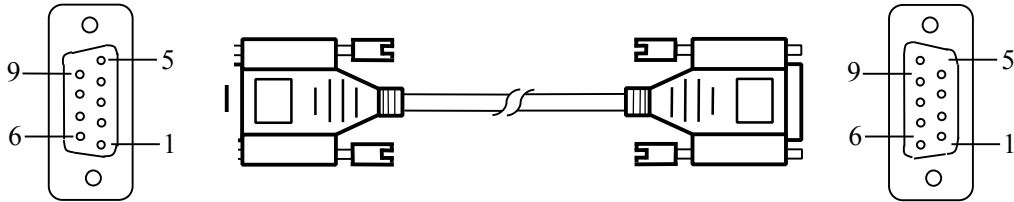

SK series touch screen uses DB9F connector. LG Master-K series PLC terminal is DB9M.

RS485

SK series touch screen COM1/COM2		LG Master-K	
8	TX-	B	
9	TX+	A	

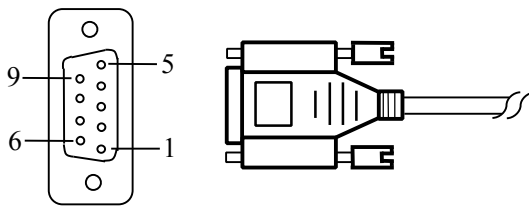

SK series touch screen uses DB9F connector. LG Master-K series PLC terminal is two-wire connector.

RS232-K10S1

SK series touch screen COM1/COM2		LG Master-K	
2	RX	4	TX
3	TX	1	RX
5	GND	6	GND

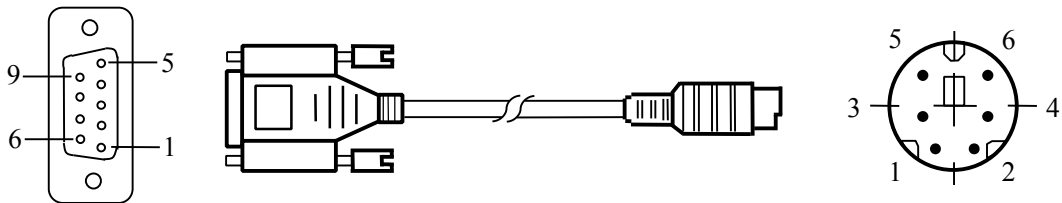

SK series touch screen uses DB9F connector. LG Master-K series PLC terminal is MD6M.

2. Software setting

- ✓ Select LG Industrial Systems in the connection device service.
- ✓ Select the corresponding item in the connection device service according to the PLC model or supporting protocol.
- ✓ Make sure the communication parameters and PLC station number of touch screen is consistent with that of PLC.
- ✓ Please refer to relative technical documents of LG Master-K series PLC for device setting.

Default connection parameters of SK series touch screen

Setting Item	Default Parameters	Setting Range
--------------	--------------------	---------------

PLC	LG Master-K Cnet	LG Master-K Cnet/K Loader/K10s1
Communication port	RS232	RS232/RS422/RS485
Baud rate	19200	1200/2400/4800/9600/19200/38400/57600/115200
Data bit length	8	7/8
Parity check bit	NONE	EVEN/ODD/NONE
Stop bit length	1	1/2
PLC station number	0	0~255
HMI station number	0	0~255

Support functions	Yes/No
Offline simulation	Yes
Online simulation	Yes
Extension mode	Yes

3. Operable register and address range

Register Name	Address Format	Input Range	Remark
P	dddh	0~255f	Bit: input/output region
M	dddh	0~255f	Bit: auxiliary relay
K	dddh	0~255f	Bit: protective relay
L	dddh	0~255f	Bit: link relay
F	dddh	0~255f	Bit: special relay
T	ddd	0~255	Bit: timer relay
C	ddd	0~255	Bit: counter relay
D	dddd	0~9999	Word: data register
TV	ddd	0~255	Word: current value of timer
CV	ddd	0~255	Word: current value of counter

- Note
- d indicates decimal, and the input range is 0-9;
 - h indicates hexadecimal, and the input range is 0-9, a-f;
 - "word" in the remark indicates the register can be used as word only;
 - "Bit" in the remark indicates the register can be used as bit only;
 - Different device models may support different register names and the range may be different. Detailed names and range refer to the relative technical documents for connected device.

10.16. Matsushita device driver

This device driver is used by SKWorkshop series touch screen to read and write the data or status of Matsushita FP series PLC register. It establishes serial port communication with the serial port of Matsushita FP series PLC through the serial port of touch screen so as to operate Matsushita FP series PLC. Please read carefully this Chapter and relative technical manual of Matsushita FP series PLC before using the driver.

How to establish connection with Matsushita FP series PLC

1. Hardware connection
Connection cable:
RS232-FP0/FP2/FP2SH/FPM

SK series touch screen COM1/COM2		Matsushita FP series	
2	RX	2	TX

3	TX	4	RX
5	GND	3	GND

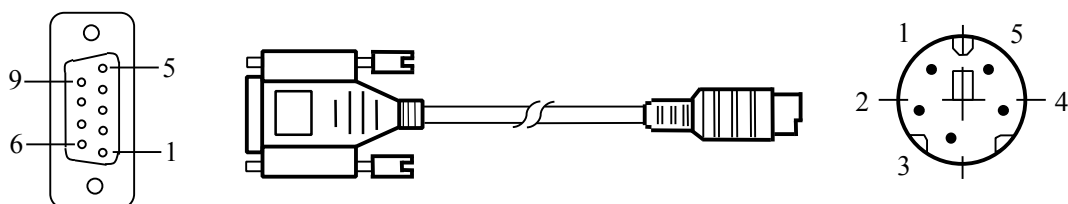

SK series touch screen uses DB9F connector. Matsushita FP series PLC terminal is MD5M.
RS422-FP1

SK series touch screen COM1/COM2		Matsushita FP series	
6	RX-	2	TX-
7	RX+	5	TX+
8	TX-	3	RX-
9	TX+	6	RX+

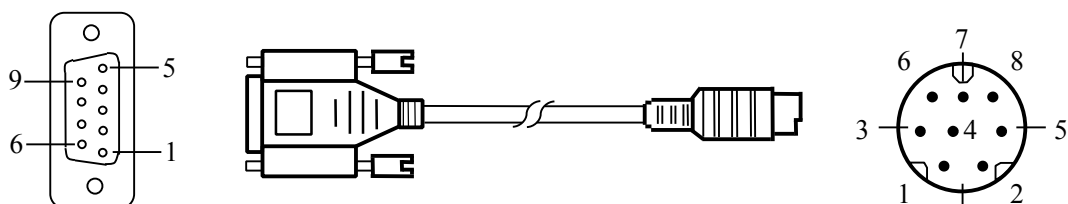

SK series touch screen uses DB9F connector. Matsushita FP series PLC terminal is MD8M.

2. Software setting

- ✓ Select MATSUSHITA in the connection device service.
- ✓ Select the corresponding item in the connection device service according to the PLC model or supporting protocol.
- ✓ Make sure the communication parameters and PLC station number of touch screen is consistent with that of PLC.
- ✓ Please refer to relative technical documents of Matsushita FP series PLC for device setting.

Default connection parameters of SK series touch screen

Setting Item	Default Parameters	Setting Range
PLC	FP Series	FP Series
Communication port	RS232	RS232/RS422/RS485
Baud rate	9600	1200/2400/4800/9600/19200/38400/57600/115200
Data bit length	8	7/8
Parity check bit	ODD	EVEN/ODD/NONE
Stop bit length	1	1/2
PLC station number	1	0~255
HMI station number	0	0~255

Support functions	Yes/No
Offline simulation	Yes
Online simulation	Yes
Extension mode	No

3. Operable register and address range

Register Name	Address Format	Input Range	Remark
X	ddddh	0~9999f	Bit: external input, read only
Y	ddddh	0~9999f	Bit: external output
R	ddddh	0~9999f	Bit: internal relay
L	ddddh	0~9999f	Bit: link relay
T	dddd	0~9999	Bit: timer status, read only
C	dddd	0~9999	Bit: counter status, read only
WX	dddd	0~9999	Word: external input, read only
WY	dddd	0~9999	Word: external output
WR	dddd	0~9999	Word: internal relay
WL	dddd	0~9999	Word: link relay
DT	dddd	0~9999	Word: data register
LD	dddd	0~9999	Word: link register
FL	dddd	0~9999	Word: file register

- Note**
- d indicates decimal, and the input range is 0-9;
 - h indicates hexadecimal, and the input range is 0-9, a-f;
 - "word" in the remark indicates the register can be used as word only;
 - "Bit" in the remark indicates the register can be used as bit only;
 - "Read only" in the remark indicates the register can be read only rather than write-in;
 - Different device models may support different register names and the range may be different. Detailed names and range refer to the relative technical documents for connected device.

10.17. Mitsubishi device driver

This device driver is used by SKWorkshop series touch screen to read and write the data or status of Melsec FXxn/Q00J/C24N series PLC register. It establishes serial port communication with the serial port of Melsec FXxn/Q00J/C24N series PLC through the serial port of touch screen so as to operate Melsec FXxn/Q00J/C24N series PLC. Please read carefully this Chapter and relative technical manual of Melsec FXxn/Q00J/C24N series PLC before using the driver.

How to establish connection with Melsec FXxn/Q00J/C24N series PLC

1. Hardware connection

Connection cable:

RS422- Melsec-FXxn/FX3U/3G

SK series touch screen COM1/COM2		Melsec-FXx n	
6	RX-	4	TX-
7	RX+	7	TX+
8	TX-	1	RX-
9	TX+	2	RX+

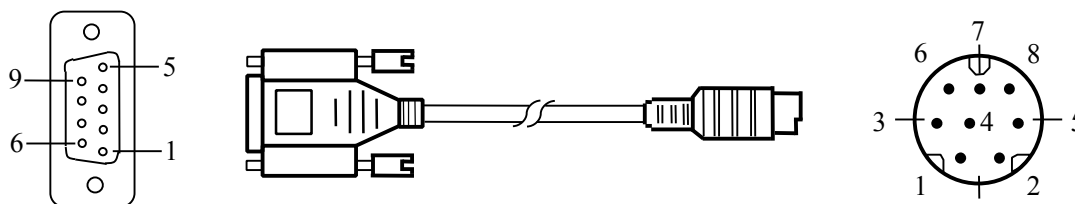

SK series touch screen uses DB9F connector. Melsec FXxn series PLC terminal is MD8M.

RS232- Melsec-Q00J

SK series touch screen COM1/COM2		Q00J CPU	
2	RX	2	TX
3	TX	1	RX
5	GND	3	GN D

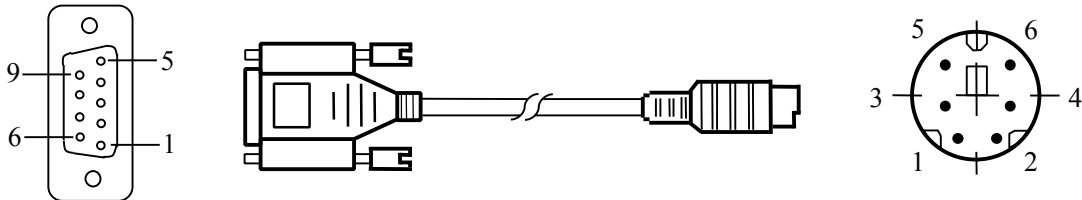

SK series touch screen uses DB9F connector. Melsec Q00J series PLC terminal is MD8M.

RS232- Melsec-QC24N module

SK series touch screen COM1/COM2		Q00J CPU	
2	RX	3	TX
3	TX	2	RX
5	GND	5	GN D

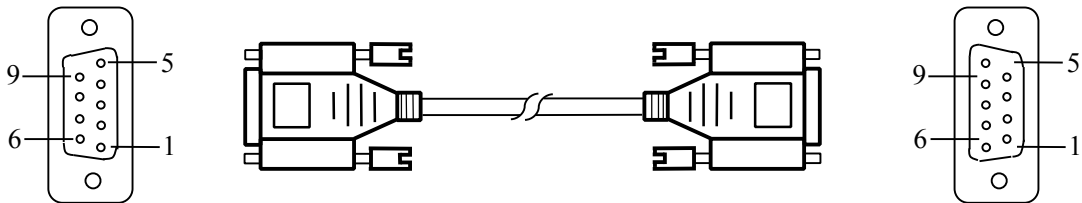

SK series touch screen uses DB9F connector. Melsec QC24N module terminal is DB9M.

2. Software setting

- ✓ MITSUBISHI。 Select MITSUBISHI in the connection device service.
- ✓ Select the corresponding item in the connection device service according to the PLC model or supporting protocol.
- ✓ Make sure the communication parameters and PLC station number of touch screen is consistent with that of PLC.
- ✓ Please refer to relative technical documents of Melsec FXxn/Q00J/C24N series PLC for device setting.

Default connection parameters of SK series touch screen

Setting Item	Default Parameters	Setting Range
PLC	Melsec-FX2N	Melsec-FX/ FX2N/ FX3U/3G /Q_ C24N Q00J
Communication port	RS232	RS232/RS422/RS485
Baud rate	9600	1200/2400/4800/9600/19200/38400/57600/115200
Data bit length	7	7/8
Parity check bit	EVEN	EVEN/ODD/NONE
Stop bit length	1	1/2
PLC station number	0	0~255
HMI station number	0	0~255

Support functions	Yes/No

Offline simulation	Yes
Online simulation	Yes
Extension mode	No

3. Operable register and address range
Melsec-FXxn/FX3U/3G

Register Name	Address Format	Input Range	Remark
X	oooo	0~377	Bit: input coil, read only
Y	oooo	0~377	Bit: output coil
M	dddd	0~7999	Bit: intermediate relay
SM	dddd	8000~8999	Bit: special intermediate relay
S	dddd	0~999	Bit: status bit
T	dddd	0~256	Bit: timer status
C	dddd	0~256	Bit: counter status
D_Bit	dddd.dd	0.00~7999.15	Bit: bit of 16-bit register
D	dddd	0~7999	Word: register
SD	dddd	8000~8999	Word: special register
TV	dddd	0~255	Word: current value of timer
CV	dddd	0~199	Word: current value of counter
CV32	dddd	200~255	Double-word: current value of 32-bit counter

Melsec-Q00J/QC24N

Register Name	Address Format	Input Range	Remark
X	hhh	0~7ff	Bit: input relay, read only
Y	hhh	0~7ff	Bit: output relay
M	dddd	0~8191	Bit: internal relay
L	dddd	0~2047	Bit: lock-up relay
F	dddd	0~2047	Bit: alarm
V	dddd	0~2047	Bit: indexing relay
S	dddd	0~2047	Bit: step relay
B	hhh	0~7ff	Bit: conversion relay
SB	hhh	0~3ff	Bit: special link relay
T	ddd	0~511	Bit: timer status
C	ddd	0~511	Bit: counter status
D	dddddd	0~11135	Word: data register
W	hhh	0~7ff	Word: conversion register
SW	hhh	0~3ff	Word: special link register

- Note
- d indicates decimal, and the input range is 0-9;
 - O indicates octal, and the input range is 0-7;
 - h indicates hexadecimal, and the input range is 0-9, a-f;
 - "word" in the remark indicates the register can be used as word only;
 - "double words" in the remark indicates the data type of register in configuration must be 32-bit;
 - "Bit" in the remark indicates the register can be used as bit only;

- “Read only” in the remark indicates the register can be read only rather than write-in;
- Different device models may support different register names and the range may be different. Detailed names and range refer to the relative technical documents for connected device.

10.18. Modbus device driver

This device driver is used by SKWorkshop series touch screen to read and write the data or status of Modbus device register. It establishes serial port communication with the serial port of Modbus device through the serial port of touch screen so as to operate Modbus device. Please read carefully this Chapter and relative technical manual of Modbus device before using the driver.

How to establish connection with Modbus device

1. Hardware connection

Connection cable:
RS232

SK series touch screen COM1/COM2		Modbus device	
2	RX	Pin customization	TX
3	TX	Pin customization	RX
5	GND	Pin customization	GND

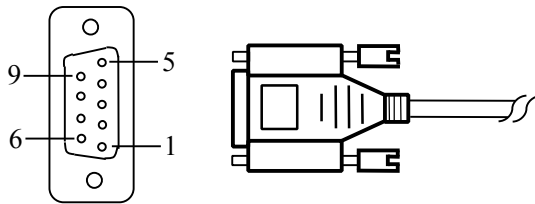

SK series touch screen uses DB9F connector. The pin at Modbus device terminal is defined as Modbus device.

RS422

SK series touch screen COM1/COM2		Modbus device	
6	RX-	Pin customization	TX-
7	RX+	Pin customization	TX+
8	TX-	Pin customization	RX-
9	TX+	Pin customization	RX+

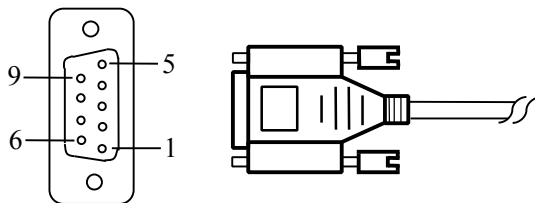

SK series touch screen uses DB9F connector. The pin at Modbus device terminal is defined as Modbus device.

RS485

SK series touch screen COM1/COM2		Modbus device	
8	TX-	Pin customization	B
9	TX+	Pin customization	A

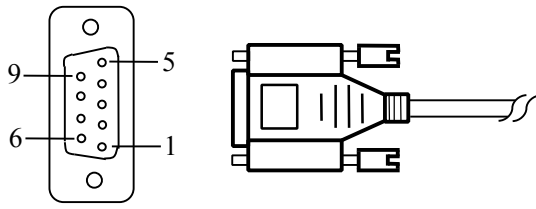

SK series touch screen uses 9P trapezoid female-connector. The pin at Modbus device terminal is defined as Modbus device.

TCP/IP(RJ45 connects directly)

SK series touch screen COM1/COM2		Modbus device	
1	TX+	3	RX+
2	TX-	6	RX-
3	RX+	1	TX+
4	BD4+	4	BD4+
5	BD4-	5	BD4-
6	RX-	2	TX-
7	BD3+	7	BD3+
8	BD3-	8	BD3-

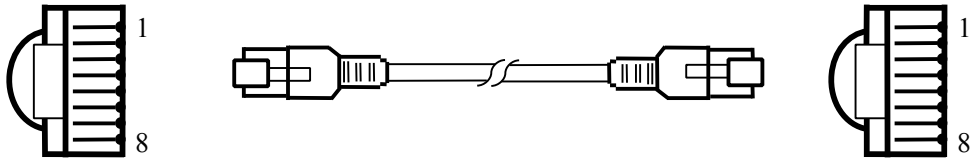

SK series touch screen uses RJ45 connector. Modbus device terminal is RJ45.

TCP/IP(RJ45 connects via router)

SK series touch screen COM1/COM2		Modbus device	
1	TX+	3	RX+
2	TX-	6	RX-
3	RX+	1	TX+
4	BD4+	4	BD4+
5	BD4-	5	BD4-
6	RX-	2	TX-
7	BD3+	7	BD3+
8	BD3-	8	BD3-

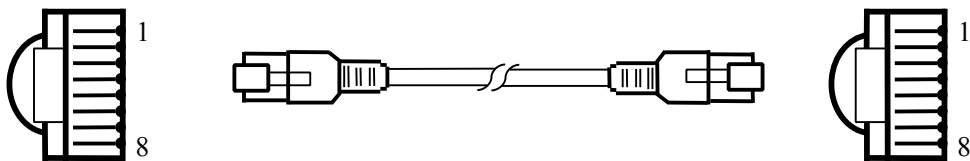

SK series touch screen uses RJ45 connector. Modbus device terminal is RJ45.

2. Software setting

- ✓ Select Modbus in the connection device service.
- ✓ Select the corresponding item in the connection device service according to the PLC model or supporting protocol.
- ✓ Make sure the communication parameters and PLC station number of touch screen is consistent with that of PLC.
- ✓ Please refer to relative technical documents of Modbus device for PLC setting.

Default connection parameters of SK series touch screen

Setting Item	Default Parameters	Setting Range
PLC	RTU Master	RTU/RTU_S/ASCII/ASCII_S Master
Communication port	RS232	RS232/RS422/RS485
Baud rate	9600	1200/2400/4800/9600/19200/38400/57600/115200
Data bit length	8	7/8
Parity check bit	NONE	EVEN/ODD/NONE
Stop bit length	1	1/2
PLC station number	1	0~255
HMI station number	0	0~255

Support functions	Yes/No
Offline simulation	Yes
Online simulation	Yes
Extension mode	Yes

Note: • The function code for writing RTU_S and ASCII_S data is 0x10 (regardless of data length);
 • if the PLC station number is 0, it is in broadcasting mode;

3. Operable register and address range

Register Name	Address Format	Input Range	Remark
0x	dddd	0~65535	Bit: output coil
1x	dddd	0~65536	Bit: input coil, read only
3x_Bit	dddd.DD	0.00~65535.15	Bit: bit of 16-bit input register, read only
4x_Bit	dddd.DD	0.00~65535.15	Bit: bit of 16-bit output register
3x	dddd	0~65535	Word: 16-bit input register, read only
4x	dddd	0~65535	Word: 16-bit output register
3x_D	dddd	0~65535	Double-word: input register, reversing to 3x double-word high/low 16-bit, read only
4x_D	dddd	0~65535	Double-word: output register, reversing to 4x double-word high/low 16-bit

Note • d indicates decimal, and the input range is 0-9;
 • DD indicates the hexadecimal, and the input range is 0-15;
 • "word" in the remark indicates the register can be used as word only;
 • "double words" in the remark indicates the data type of register in configuration must be 32-bit;
 • "Bit" in the remark indicates the register can be used as bit only;
 • "Read only" in the remark indicates the register can be read only rather than write-in;
 • Different device models may support different register names and the range may be different. Detailed names and range refer to the relative technical documents for connected device.

10.19. Modicon device driver

This device driver is used by SKWorkshop series touch screen to read and write the data or status of Modicon NEZA/TWIDO/M218 series PLC register. It establishes serial port communication with the serial port of Modicon NEZA/TWIDO/M218 series PLC through the serial port of touch screen so as to operate Modicon NEZA/TWIDO/M218 series PLC. Please read carefully this Chapter and relative technical manual of Modicon NEZA/TWIDO/M218 series PLC before using the driver.

How to establish connection with Modicon NEZA/TWIDO/M218 series PLC

1. Hardware connection

Connection cable:
RS232

SK series touch screen COM1/COM2		Modicon NEZA/TWIDO/M218	
2	RX	2	TX-
3	TX	1	TX+

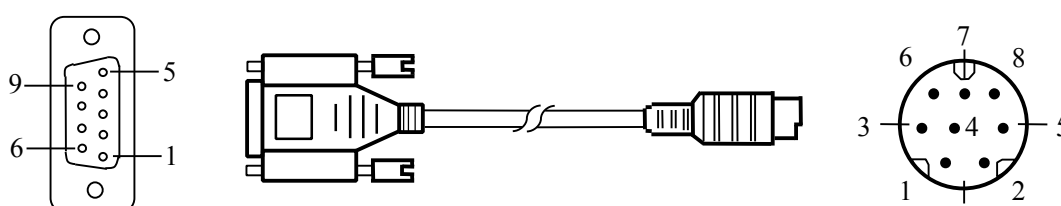

SK series touch screen uses DB9F connector. Modicon NEZA/TWIDO/M218 series PLC terminal is MD8M.

2. Software setting

- ✓ Select Modicon Corp in the connection device service
- ✓ Select the corresponding item in the connection device service according to the PLC model or supporting protocol.
- ✓ Make sure the communication parameters and PLC station number of touch screen is consistent with that of PLC.
- ✓ Please refer to relative technical documents of Modicon NEZA/TWIDO/M218 series PLC for device setting.

Default connection parameters of SK series touch screen

Setting Item	Default Parameters	Setting Range
PLC	NEZA Series	NEZA/TWIDO/M218 Series
Communication port	RS232	RS232/RS422/RS485
Baud rate	9600	1200/2400/4800/9600/19200/38400/57600/115200
Data bit length	8	7/8
Parity check bit	ODD	EVEN/ODD/NONE
Stop bit length	1	1/2
PLC station number	1	0~255
HMI station number	0	0~255

Support functions	Yes/No
Offline simulation	Yes
Online simulation	Yes
Extension mode	Yes

3. Operable register and address range

NEZA Series

Register Name	Address Format	Input Range	Remark
%MW	dddd	0~65535	Word: word data register

TWIDO Series

Register Name	Address Format	Input Range	Remark
%M	dddd	0~65535	Bit: bit data register
%MW	dddd	0~65535	Word: word data register

M218 Series

Register Name	Address Format	Input Range	Remark
%MX	dddd.o	0~131071.7	Bit: bit data register
%MW	dddd	0~65535	Word: word data register

- Note
- d indicates decimal, and the input range is 0-9;
 - O indicates octal, and the input range is 0-7;
 - "word" in the remark indicates the register can be used as word only;
 - "Bit" in the remark indicates the register can be used as bit only;
 - Different device models may support different register names and the range may be different. Detailed names and range refer to the relative technical documents for connected device.

10.20. Nanda device driver

This device driver is used by SKWorkshop series touch screen to read and write the data or status of Nanda NA-200/400 series PLC register. It establishes serial port communication with the serial port of Nanda NA-200/400 series PLC through the serial port of touch screen so as to operate Nanda NA-200/400 series PLC. Please read carefully this Chapter and relative technical manual of Nanda NA-200/400 series PLC before using the driver.

How to establish connection with Nanda NA-200/400 series PLC

1. Hardware connection

Connection cable:

RS232

SK series touch screen COM1/COM2		Nanda NA-200/400	
2	RX	3	TX
3	TX	2	RX
5	GND	5	GND

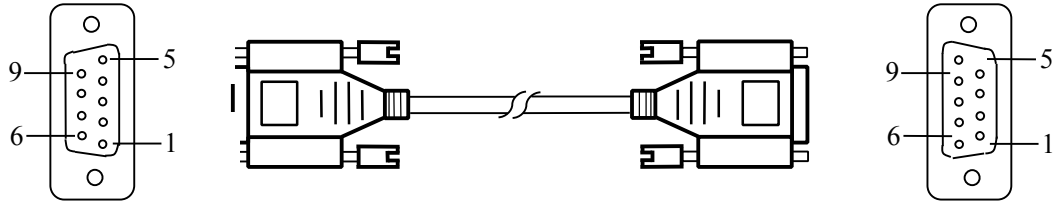

SK series touch screen uses DB9F connector. Nanda NA-200/400 series PLC terminal is DB9M.

2. Software setting

- ✓ Select Nanda Auto Technology in the connection device service.
- ✓ Select the corresponding item in the connection device service according to the PLC model or supporting protocol.
- ✓ Make sure the communication parameters and PLC station number of touch screen is consistent with that of PLC.
- ✓ Please refer to relative technical documents of Nanda NA-200/400 series PLC for device setting.

Default connection parameters of SK series touch screen

Setting Item	Default Parameters	Setting Range
PLC	Nanda NA-200	Nanda NA-200/400
Communication port	RS232	RS232/RS422/RS485
Baud rate	9600	1200/2400/4800/9600/19200/38400/57600/115200
Data bit length	8	7/8
Parity check bit	NONE	EVEN/ODD/NONE
Stop bit length	1	1/2
PLC station number	1	0~255
HMI station number	0	0~255

Support functions	Yes/No
Offline simulation	Yes
Online simulation	Yes
Extension mode	Yes

3. Operable register and address range

Nanda NA-200

Register Name	Address Format	Input Range	Remark
I	ddd	1~128	Bit: digital input, read only
Q	ddd	1~128	Bit: digital output
M	dddd	1~1024	Bit: bit register
S	ddd	1~256	Bit: system bit register
N	ddd	1~256	Bit: bit register at power off
IW	dd	1~32	Word: analog input
QW	dd	1~32	Word: analog output
MW	dddd	1~1024	Word: word register
SW	ddd	1~256	Word: system word register
NW	ddd	1~256	Word: word register at power off

Nanda NA-400

Register Name	Address Format	Input Range	Remark
I	ddd	1~2048	Bit: digital input, read only

Q	ddd	1~2048	Bit: digital output
M	dddd	1~8192	Bit: bit register
S	ddd	1~4096	Bit: system bit register
N	ddd	1~2048	Bit: bit register at power off
IW	dd	1~512	Word: analog input
QW	dd	1~512	Word: analog output
MW	dddd	1~8192	Word: word register
SW	ddd	1~2048	Word: system word register
NW	ddd	1~2048	Word: word register at power off

- Note**
- d indicates decimal, and the input range is 0-9;
 - "word" in the remark indicates the register can be used as word only;
 - "Bit" in the remark indicates the register can be used as bit only;
 - "Read only" in the remark indicates the register can be read only rather than write-in;
 - Different device models may support different register names and the range may be different. Detailed names and range refer to the relative technical documents for connected device.

10.21. Omron device driver

This device driver is used by SKWorkshop series touch screen to read and write the data or status of SYSMAC C/CPM/CS/CJ series PLC register. It establishes serial port communication with the serial port of SYSMAC C/CPM/CS/CJ series PLC through the serial port of touch screen so as to operate SYSMAC C/CPM/CS/CJ series PLC. Please read carefully this Chapter and relative technical manual of SYSMAC C/CPM/CS/CJ series PLC before using the driver.

How to establish connection with SYSMAC C/CPM/CS/CJ series PLC

1. Hardware connection

Connection cable:
RS232

SK series touch screen COM1/COM2		SYSMAC CS/CJ	
2	RX	3	TX
3	TX	3	RX
5	GND	9	GND

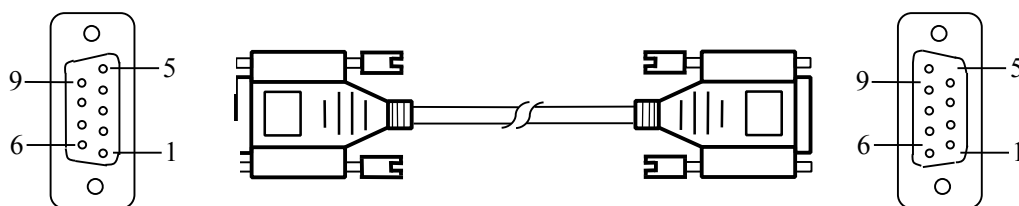

SK series touch screen uses DB9F connector. SYSMAC C/CPM/CS/CJ series PLC terminal is DB9M.

2. Software setting

- ✓ Select OMRON in the connection device service.
- ✓ Select the corresponding item in the connection device service according to the PLC model or supporting protocol.
- ✓ Make sure the communication parameters and PLC station number of touch screen is consistent with that of PLC.
- ✓ Please refer to relative technical documents of SYSMAC C/CPM/CS/CJ series PLC for device setting.

Default connection parameters of SK series touch screen

Setting Item	Default Parameters	Setting Range
PLC	SYSMAC C/CPM Series	SYSMAC C/CPM/CS/CJ Series
Communication port	RS232	RS232/RS422/RS485

Baud rate	9600	1200/2400/4800/9600/19200/38400/57600/115200
Data bit length	7	7/8
Parity check bit	EVEN	EVEN/ODD/NONE
Stop bit length	2	1/2
PLC station number	0	0~255
HMI station number	0	0~255

Support functions	Yes/No
Offline simulation	Yes
Online simulation	Yes
Extension mode	No

3. Operable register and address range
SYSMAC C/CPM Series

Register Name	Address Format	Input Range	Remark
IR_Bit	dddd.DD	0.0~4095.15	Bit: I/O relay
HR_Bit	dddd.DD	0.0~4095.15	Bit: hold relay
LR_Bit	dddd.DD	0.0~4095.15	Bit: link relay
AR_Bit	dddd.DD	0.0~4095.15	Bit: memory aid relay
T	ddd	0~255	Bit: timer status
C	ddd	0~255	Bit: counter status
IR	dddd	0~4095	Word: I/O relay
HR	dddd	0~4095	Word: hold relay
LR	dddd	0~4095	Word: link relay
AR	dddd	0~4095	Word: memory aid relay
TC	ddd	0~255	Word: timer value
DM	dddd	0~9999	Word: general data area

SYSMAC CS/CJ Series

Register Name	Address Format	Input Range	Remark
CIO_Bit	dddd.DD	0.0~3189.15	Bit: core I/O area
W_Bit	dddd.DD	0.0~6143.15	Bit: working area
H_Bit	dddd.DD	0.0~511.15	Bit: holding area
A_Bit	dddd.DD	0.0~959.15	Bit: auxiliary area, read only: 7,168Bit: A00000~A447.15
D_Bit	dddd.DD	0.0~32767.15	Bit: general data area
T	dddd	0~4095	Bit: timer status
C	dddd	0~4095	Bit: counter status
CIO	dddd	0~3189	Word: core I/O area
W	dddd	0~6143	Word: working area
H	dddd	0~511	Word: holding area
A	dddd	0~959	Word: auxiliary area, read only: 448Word: A000~A447

D	dddd	0~32767	Word: general data area
TV	dddd	0~4095	Word: current value of timer
CV	dddd	0~4095	Word: current value of counter

- Note
- d indicates decimal, and the input range is 0-9;
 - DD indicates the hexadecimal, and the input range is 0-15;
 - "word" in the remark indicates the register can be used as word only;
 - "Bit" in the remark indicates the register can be used as bit only;
 - "Read only" in the remark indicates the register can be read only rather than write-in;
 - Different device models may support different register names and the range may be different. Detailed names and range refer to the relative technical documents for connected device.

10.22. Siemens device driver

This device driver is used by SKWorkshop series touch screen to read and write the data or status of Siemens S7-200/300 series PLC register. It establishes serial port communication with the serial port of Siemens S7-200/300 series PLC through the serial port of touch screen so as to operate Siemens S7-200/300 series PLC. Please read carefully this Chapter and relative technical manual of Siemens S7-200/300 series PLC before using the driver.

How to establish connection with Siemens S7-200/300 series PLC

1. Hardware connection

Connection cable:

RS485-Siemens S7-200

SK series touch screen COM1/COM2		Siemens S7-200 series	
8	TX-	8	TX-
9	TX+	3	TX+

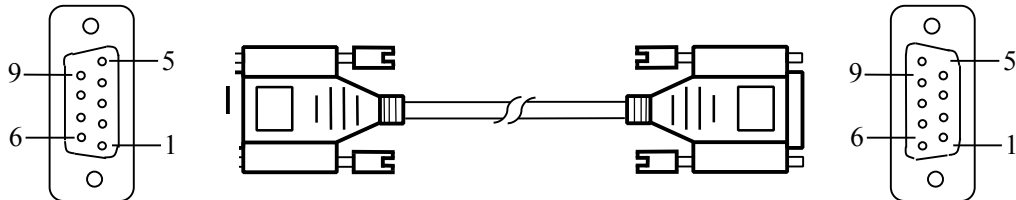

SK series touch screen uses DB9F connector. Siemens S7-200 series PLC terminal is DB9M.

RS232-Siemens S7-300

SK series touch screen COM1/COM2		Siemens S7-200 series	
2	RX	3	TX
3	TX	2	RX
5	GND	5	GND
		7	RTS
		8	CTS
		7-8 Short connection	

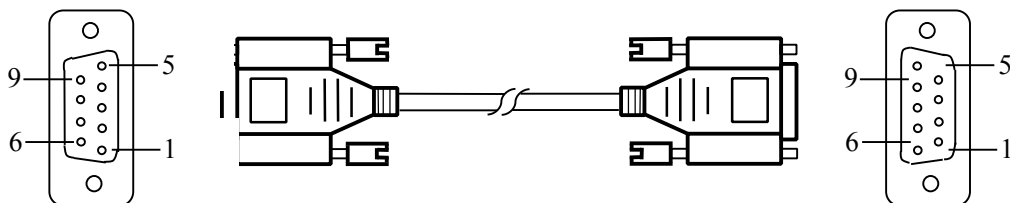

SK series touch screen uses DB9F connector. Siemens S7-300 series PLC MPI terminal is DB9M.

2. Software setting
 - ✓ Select SIEMENS in the connection device service.
 - ✓ Select the corresponding item in the connection device service according to the PLC model or supporting protocol.
 - ✓ Make sure the communication parameters and PLC station number of touch screen is consistent with that of PLC.
 - ✓ Please refer to relative technical documents of Siemens S7-200/300 series PLC for device setting.

Default connection parameters of SK series touch screen

Setting Item	Default Parameters	Setting Range
PLC	S7-200(PPI)	S7-200(PPI)/ S7-300(MPI)
Communication port	RS485	RS232/RS422/RS485
Baud rate	19200	1200/2400/4800/9600/19200/38400/57600/115200
Data bit length	8	7/8
Parity check bit	ODD	EVEN/ODD/NONE
Stop bit length	1	1/2
PLC station number	2	1~255
HMI station number	0	0~255

Support functions	Yes/No
Offline simulation	Yes
Online simulation	Yes
Extension mode	Yes: S7-200(PPI)/No: S7-300(MPI)

3. Operable register and address range
Siemens S7-200

Register Name	Address Format	Input Range	Remark
I	dd.o	0.0~4095.7	Bit: input image register, read only
Q	dd.o	0.0~4095.7	Bit: output image register
M	dd.o	0.0~4095.7	Bit: bit memory
S	dd.o	0.0~4095.7	Bit: sequence control relay
SM	ddd.o	0.0~4095.7	Bit: special bit memory, SM0.0-SM29.7 read only
T	ddd	0~255	Bit: timer status, read only
C	ddd	0~255	Bit: counter status, read only
VB_Bit	dddd.o	0.0~10239.7	Bit: bit of variable storage
IW	dd	0~4095	Word: input image register, read only, 8-bit register, each word occupies two addresses
QW	dd	0~4095	Word: output image register, 8-bit register, each word occupies two addresses
MW	dd	0~4095	Word: bit memory, 8-bit register, each word occupies two addresses
SW	dd	0~4095	Word: sequence control relay, 8-bit register, each word occupies two addresses
SMW	ddd	0~4095	Word: special bit memory, SMW0-SMW29 read only, 8-bit register, each word occupies two addresses
VB	dddd	0~10239	Word: variable storage, 8-bit register

VW	dddd	0~10238	Word: variable storage, 8-bit register, each word occupies two addresses
VD	dddd	0~10236	Double-word: variable storage, 8-bit register, each double-word occupies four addresses
TV	ddd	0~255	Word: current value of timer
CV	ddd	0~255	Word: current value of counter
AIW	dd	0~62	Word: analog input, read only, 8-bit register, each word occupies two addresses
AQW	dd	0~62	Word: analog output, write only, 8-bit register, each word occupies two addresses

Siemens S7-300

Register Name	Address Format	Input Range	Remark
I	dddd.o	0.0~4095.7	Bit: input image register
Q	dddd.o	0.0~4095.7	Bit: output image register
M	dddd.o	0.0~4095.7	Bit: bit memory
DB_Bit	DDD:dddd.o	0:0.0~255:8192.7	Bit: bit of DB block storage word, block number: DD 0~255; each block word: dddd 0~8192;bit of each word: o 0~7
IW	dddd	0~4095	Word: input image register, 8-bit register, each word occupies two addresses
QW	dddd	0~4095	Word: output image register, 8-bit register, each word occupies two addresses
MW	dddd	0~4095	Word: bit memory, 8-bit register, each word occupies two addresses
DBW	DDD:dddd	0:0~255:8192	Word: DB block storage, block number DD: 0~255; each block word dddd: 0~8192; 8-bit register, each word occupies two addresses
DBD	DDD:dddd	0:0~255:8192	Double-word: DB block storage, block number DD: 0~255; each block word dddd: 0~8192, 8-bit register, each double-word occupies four addresses

- Note
- d indicates decimal, and the input range is 0-9;
 - O indicates octal, and the input range is 0-7;
 - DDD indicates the block number, and the input range is 0-255;
 - "word" in the remark indicates the register can be used as word only;
 - "double words" in the remark indicates the data type of register in configuration must be 32-bit;
 - "Bit" in the remark indicates the register can be used as bit only;
 - "Read only" in the remark indicates the register can be read only rather than write-in;
 - Different device models may support different register names and the range may be different. Detailed names and range refer to the relative technical documents for connected device.

10.23. TaiAn device driver

This device driver is used by SKWorkshop series touch screen to read and write the data or status of TaiAn TP03 series PLC register. It establishes serial port communication with the serial port of TaiAn TP03 series PLC through the serial port of

touch screen so as to operate TaiAn TP03 series PLC. Please read carefully this Chapter and relative technical manual of TaiAn TP03 series PLC before using the driver.

How to establish connection with TaiAn TP03 series PLC

1. Hardware connection

Connection cable:
RS232

SK series touch screen COM1/COM2		TaiAn TP03 series	
2	RX	3	TX
3	TX	2	RX
5	GND	5	GND

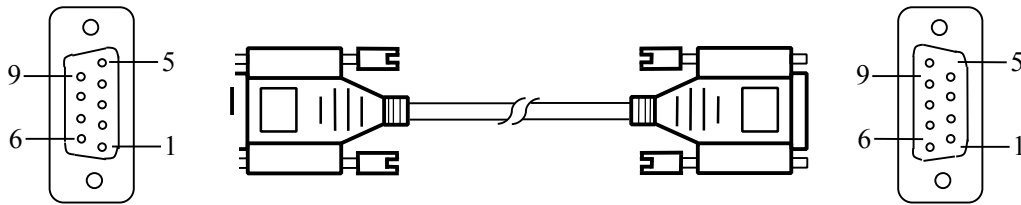

SK series touch screen uses DB9F connector. TaiAn TP03 series PLC terminal is DB9M.

2. Software setting

- ✓ Select TaiAn Technology in the connection device service.
- ✓ Select the corresponding item in the connection device service according to the PLC model or supporting protocol.
- ✓ Make sure the communication parameters and PLC station number of touch screen is consistent with that of PLC.
- ✓ Please refer to relative technical documents of TaiAn TP03 series PLC for device setting.

Default connection parameters of SK series touch screen

Setting Item	Default Parameters	Setting Range
PLC	TP03 Series	TP03 Series
Communication port	RS232	RS232/RS422/RS485
Baud rate	19200	1200/2400/4800/9600/19200/38400/57600/115200
Data bit length	8	7/8
Parity check bit	NONE	EVEN/ODD/NONE
Stop bit length	2	1/2
PLC station number	1	0~255
HMI station number	0	0~255

Support functions	Yes/No
Offline simulation	Yes
Online simulation	Yes
Extension mode	Yes

3. Operable register and address range

Register Name	Address Format	Input Range	Remark
X	ooo	0~377	Bit: input relay, read only
Y	ooo	0~377	Bit: output relay
M	dddd	0~7999	Bit: auxiliary relay
SM	dddd	8000~8511	Bit: special auxiliary relay

S	dddd	0~4095	Bit: step relay
T	ddd	0~511	Bit: timer
C	ddd	0~255	Bit: counter
D	dddd	0~7999	Word: data register
SD	dddd	8000~8511	Word: special data register
TV	ddd	0~511	Word: current value of timer
CV	ddd	0~199	Word: current value of counter
CV32	ddd	200~255	Double-word: current value of counter

- Note**
- d indicates decimal, and the input range is 0-9;
 - O indicates octal, and the input range is 0-7;
 - "word" in the remark indicates the register can be used as word only;
 - "double words" in the remark indicates the data type of register in configuration must be 32-bit;
 - "Bit" in the remark indicates the register can be used as bit only;
 - "Read only" in the remark indicates the register can be read only rather than write-in;
 - Different device models may support different register names and the range may be different. Detailed names and range refer to the relative technical documents for connected device.

10.24. TaiLing device driver

This device driver is used by SKWorkshop series touch screen to read and write the data or status of TaiLing DX series PLC register. It establishes serial port communication with the serial port of TaiLing DX series PLC through the serial port of touch screen so as to operate TaiLing DX series PLC. Please read carefully this Chapter and relative technical manual of TaiLing DX series PLC before using the driver.

How to establish connection with TaiLing DX series PLC

1. Hardware connection

Connection cable:
RS232

SK series touch screen COM1/COM2		TaiLing DX series	
2	RX	3	TX
3	TX	2	RX
5	GND	5	GND

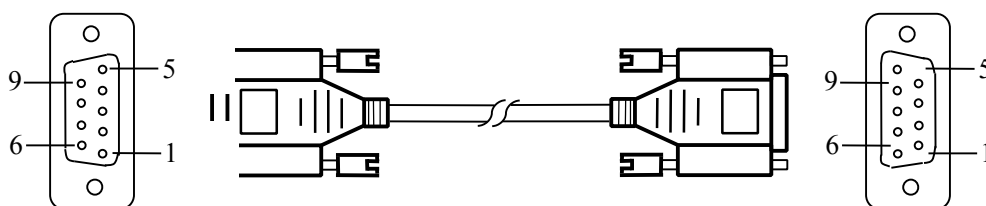

SK series touch screen uses DB9F connector. TaiLing DX series PLC terminal is DB9M.

2. Software setting

- ✓ Select TaiLing Electric in the connection device service.
- ✓ Select the corresponding item in the connection device service according to the PLC model or supporting protocol.
- ✓ Make sure the communication parameters and PLC station number of touch screen is consistent with that of PLC.
- ✓ Please refer to relative technical documents of TaiLing DX series PLC for device setting.

Default connection parameters of SK series touch screen

Setting Item	Default Parameters	Setting Range
PLC	DX Series	DX Series
Communication port	RS232	RS232/RS422/RS485

Baud rate	9600	1200/2400/4800/9600/19200/38400/57600/115200
Data bit length	8	7/8
Parity check bit	NONE	EVEN/ODD/NONE
Stop bit length	1	1/2
PLC station number	1	1~31
HMI station number	0	0~255

Support functions	Yes/No
Offline simulation	Yes
Online simulation	Yes
Extension mode	No

3. Operable register and address range

Register Name	Address Format	Input Range	Remark
X	oooo	0~377	Bit: input coil, read only
Y	oooo	0~377	Bit: output coil
M	dddd	0~7999	Bit: intermediate relay
SM	dddd	8000~8999	Bit: special intermediate relay
S	dddd	0~999	Bit: status bit
T	dddd	0~256	Bit: timer status
C	dddd	0~256	Bit: counter status
D	dddd	0~7999	Word: register
SD	dddd	8000~8999	Word: special register
TV	dddd	0~255	Word: current value of timer
CV	dddd	0~199	Word: current value of counter
CV32	dddd	200~255	Double-word: current value of 32-bit counter

- Note**
- d indicates decimal, and the input range is 0-9;
 - O indicates octal, and the input range is 0-7;
 - "word" in the remark indicates the register can be used as word only;
 - "double words" in the remark indicates the data type of register in configuration must be 32-bit;
 - "Bit" in the remark indicates the register can be used as bit only;
 - "Read only" in the remark indicates the register can be read only rather than write-in;
 - Different device models may support different register names and the range may be different. Detailed names and range refer to the relative technical documents for connected device.

10.25. Techwayson device driver

This device driver is used by SKWorkshop series touch screen to read and write the data or status of Techwayson V80 series PLC register. It establishes serial port communication with the serial port of Techwayson V80 series PLC through the serial port of touch screen so as to operate Techwayson V80 series PLC. Please read carefully this Chapter and relative technical manual of Techwayson V80 series PLC before using the driver.

How to establish connection with Techwayson V80 series PLC

1. Hardware connection

Connection cable:
RS232



2	RX	3	TX
3	TX	2	RX
5	GND	5	GND

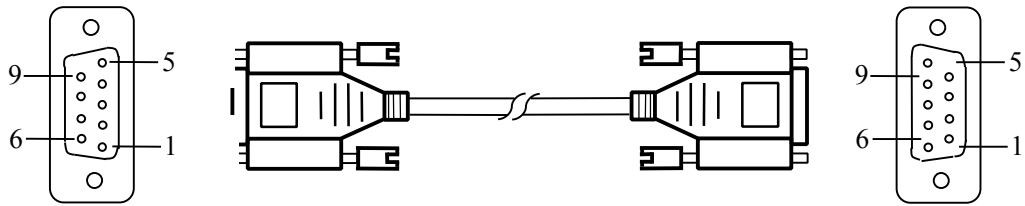

SK series touch screen uses DB9F connector. Techwayson V80 series PLC terminal is MD8M.

2. Software setting

- ✓ Select Techwayson Technology in the connection device service.
- ✓ Select the corresponding item in the connection device service according to the PLC model or supporting protocol.
- ✓ Make sure the communication parameters and PLC station number of touch screen is consistent with that of PLC.
- ✓ Please refer to relative technical documents of Techwayson V80 series PLC for device setting.

Default connection parameters of SK series touch screen

Setting Item	Default Parameters	Setting Range
PLC	Techwayson V80 Series	Techwayson V80 Series
Communication port	RS232	RS232
Baud rate	19200	1200/2400/4800/9600/19200/38400/57600/115200
Data bit length	8	7/8
Parity check bit	EVEN	EVEN/ODD/NONE
Stop bit length	1	1/2
PLC station number	1	0~255
HMI station number	0	0~255

Support functions	Yes/No
Offline simulation	Yes
Online simulation	Yes
Extension mode	Yes

3. Operable register and address range

Register Name	Address Format	Input Range	Remark
0x	dddd	1~9984	Bit: output coil
1x	dddd	1~2048	Bit: input coil, read only
3x	dddd	1~512	Word: 16-bit input register, read only
4x	dddd	1~9999	Word: 16-bit hold register

Note

- d indicates decimal, and the input range is 0-9;
- ”word” in the remark indicates the register can be used as word only;
- ”Bit” in the remark indicates the register can be used as bit only;
- ”Read only” in the remark indicates the register can be read only rather than write-in;
- Different device models may support different register names and the range may be different. Detailed names and range refer to the relative technical documents for connected device.

10.26. Vigor device driver

This device driver is used by SKWorkshop series touch screen to read and write the data or status of Vigor V/VH/VB/M series PLC register. It establishes serial port communication with the serial port of Vigor V/VH/VB/M series PLC through the serial port of touch screen so as to operate Vigor V/VH/VB/M series PLC. Please read carefully this Chapter and relative technical manual of Vigor V/VH/VB/M series PLC before using the driver.

How to establish connection with Vigor V/VH/VB/M series PLC

1. Hardware connection

Connection cable:
RS232

SK series touch screen COM1/COM2		Vigor V/VH/VB/Mv series	
2	RX	3	TX
3	TX	2	RX
5	GND	4	GND

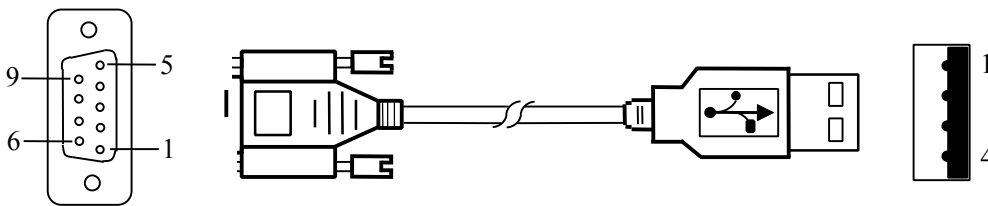

SK series touch screen uses DB9F connector. Vigor V/VH/VB/M series PLC terminal is DB9M.

2. Software setting

- ✓ Select Vigor Electric Corp. in the connection device service
- ✓ Select the corresponding item in the connection device service according to the PLC model or supporting protocol.
- ✓ Make sure the communication parameters and PLC station number of touch screen is consistent with that of PLC.
- ✓ Please refer to relative technical documents of Vigor V/VH/VB/M series PLC for device setting.

Default connection parameters of SK series touch screen

Setting Item	Default Parameters	Setting Range
PLC	V/VH/VB/M Series	V/VH/VB/M Series
Communication port	RS232	RS232/RS422/RS485
Baud rate	19200	1200/2400/4800/9600/19200/38400/57600/115200
Data bit length	7	7/8
Parity check bit	EVEN	EVEN/ODD/NONE
Stop bit length	1	1/2
PLC station number	0	0~255
HMI station number	0	0~255

Support functions	Yes/No
Offline simulation	Yes
Online simulation	Yes
Extension mode	No

3. Operable register and address range

Register Name	Address Format	Input Range	Remark
X	ooo	0~777	Bit: input contact
Y	ooo	0~777	Bit: output contact

M	dddd	0~8999	Bit: internal relay
SM	dddd	9000~9255	Bit: special internal relay
S	dddd	0~999	Bit: step relay
T	ddd	0~255	Bit: timer status
C	ddd	0~255	Bit: counter status
D	dddd	0~8999	Bit: data register
SD	dddd	9000~9255	Word: special data register
TV	ddd	0~255	Word: current value of timer
CV	ddd	0~199	Word: current value of counter
CV32	ddd	200~255	Word: current value of 32-bit counter

- Note
- d indicates decimal, and the input range is 0-9;
 - O indicates octal, and the input range is 0-7;
 - "word" in the remark indicates the register can be used as word only;
 - "double words" in the remark indicates the data type of register in configuration must be 32-bit;
 - "Bit" in the remark indicates the register can be used as bit only;
 - "Read only" in the remark indicates the register can be read only rather than write-in;
 - Different device models may support different register names and the range may be different. Detailed names and range refer to the relative technical documents for connected device.

10.27. Xinje device driver

This device driver is used by SKWorkshop series touch screen to read and write the data or status of Thinget XC/XCM series PLC register. It establishes serial port communication with the serial port of Thinget XC/XCM series PLC through the serial port of touch screen so as to operate Thinget XC/XCM series PLC. Please read carefully this Chapter and relative technical manual of Thinget XC/XCM series PLC before using the driver.

How to establish connection with Thinget XC/XCM series PLC

1. Hardware connection

Connection cable:
RS232

SK series touch screen COM1/COM2		Thinget XC/XCM series	
2	RX	5	TX
3	TX	4	RX
5	GND	8	GND

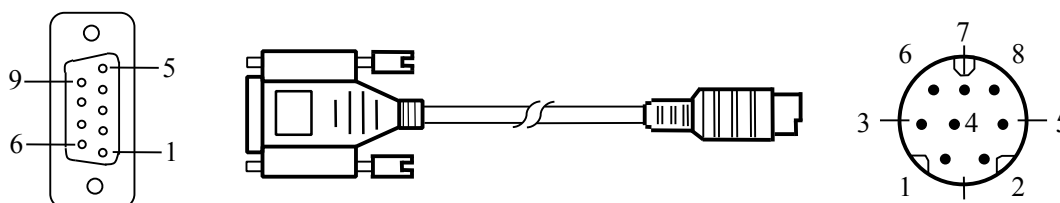

SK series touch screen uses DB9F connector. Thinget XC/XCM series PLC terminal is MD8M.

2. Software setting

- ✓ Select Xinje Electronic in the connection device service.
- ✓ Select the corresponding item in the connection device service according to the PLC model or supporting protocol.
- ✓ Make sure the communication parameters and PLC station number of touch screen is consistent with that of PLC.
- ✓ Please refer to relative technical documents of Thinget XC/XCM series PLC for device setting.

Default connection parameters of SK series touch screen

Setting Item	Default Parameters	Setting Range
--------------	--------------------	---------------

PLC	Thinget XC Series	Thinget XC/XCM Series
Communication port	RS232	RS232/RS422/RS485
Baud rate	19200	1200/2400/4800/9600/19200/38400/57600/115200
Data bit length	8	7/8
Parity check bit	EVEN	EVEN/ODD/NONE
Stop bit length	1	1/2
PLC station number	1	0~255
HMI station number	0	0~255

Support functions	Yes/No
Offline simulation	Yes
Online simulation	Yes
Extension mode	Yes

3. Operable register and address range

Register Name	Address Format	Input Range	Remark
X	dddd	0~1037	Bit: input coil
Y	dddd	0~1037	Bit: output coil
M	dddd	0~8767	Bit: internal coil
S	dddd	0~1023	Bit: flow
T	ddd	0~639	Bit: timer status
C	ddd	0~639	Bit: counter status
D	dddd	0~9023	Word: data register
TD	ddd	0~639	Word: current value of timer
CD	ddd	0~639	Word: current value of counter
FD	dddd	0~9023	Word: FlashROM register
ED	dddd	0~16383	Word: expansion internal register

Note

- d indicates decimal, and the input range is 0-9;
- "word" in the remark indicates the register can be used as word only;
- "Bit" in the remark indicates the register can be used as bit only;
- "Read only" in the remark indicates the register can be read only rather than write-in;
- Different device models may support different register names and the range may be different. Detailed names and range refer to the relative technical documents for connected device.

10.28. Yokogawa device driver

This device driver is used by SKWorkshop series touch screen to read and write the data or status of Yokogawa FA-M3 series PLC register. It establishes serial port communication with the serial port of Yokogawa FA-M3 series PLC through the serial port of touch screen so as to operate Yokogawa FA-M3 series PLC. Please read carefully this Chapter and relative technical manual of Yokogawa FA-M3 series PLC before using the driver.

How to establish connection with Yokogawa FA-M3 series PLC

1. Hardware connection
Connection cable:
RS422

SK series touch screen
COM1/COM2

Yokogawa FA-M3 series

5	GND	5	SG	4-5 short connection 220Ω resistance in series
6	RX-	4	SDB	
7	RX+	3	SDA	2-3 short connection 220Ω resistance in series
8	TX-	2	RDB	
9	TX+	1	RDA	
		6	CSA	6-7 short connection
		7	ERA	
		8	CSB	8-9 short connection
		9	ERB	

SK series touch screen uses DB9F connector. Yokogawa FA-M3 series PLC terminal is SIO.

2. Software setting

- ✓ Select Yokogawa Electric Corp in the connection device service
- ✓ Select the corresponding item in the connection device service according to the PLC model or supporting protocol.
- ✓ Make sure the communication parameters and PLC station number of touch screen is consistent with that of PLC.
- ✓ Please refer to relative technical documents of Yokogawa FA-M3 series PLC for device setting.

Default connection parameters of SK series touch screen

Setting Item	Default Parameters	Setting Range
PLC	Yokogawa FA-M3	Yokogawa FA-M3
Communication port	RS485	RS232/RS422/RS485
Baud rate	9600	1200/2400/4800/9600/19200/38400/57600/115200
Data bit length	8	7/8
Parity check bit	EVEN	EVEN/ODD/NONE
Stop bit length	1	1/2
PLC station number	1	0~255
HMI station number	0	0~255

Support functions	Yes/No
Offline simulation	Yes
Online simulation	Yes
Extension mode	No

3. Operable register and address range

Register Name	Address Format	Input Range	Remark
X	dddd	0~71664	Bit: input, discontinuous, defined by slot number
Y	dddd	0~71664	Bit: output, discontinuous, defined by slot number
M	dddd	0~16384	Bit: special relay
I	dddd	0~71024	Bit: internal relay
L	dddd	0~9984	Bit: link relay, discontinuous
D	dddd	0~8192	Word: data register
B	dddd	0~32768	Word: file register
V	dddd	0~64	Word: external switch value output
W	dddd	0~71024	Word: link relay, discontinuous

Z	dddd	0~512	Word: special register
---	------	-------	------------------------

- Note
- d indicates decimal, and the input range is 0-9;
 - "word" in the remark indicates the register can be used as word only;
 - "Bit" in the remark indicates the register can be used as bit only;
 - "Read only" in the remark indicates the register can be read only rather than write-in;
 - Different device models may support different register names and the range may be different. Detailed names and range refer to the relative technical documents for connected device.

10.29. ZhengHang device driver

This device driver is used by SKWorkshop series touch screen to read and write the data or status of ZhengHang A5 series PLC register. It establishes serial port communication with the serial port of ZhengHang A5 series PLC through the serial port of touch screen so as to operate ZhengHang A5 series PLC. Please read carefully this Chapter and relative technical manual of ZhengHang A5 series PLC before using the driver.

How to establish connection with ZhengHang A5 series PLC

1. Hardware connection

Connection cable:
RS232

SK series touch screen COM1/COM2		ZhengHang A5 series	
2	RX	2	TX
3	TX	3	RX
5	GND	5	GND

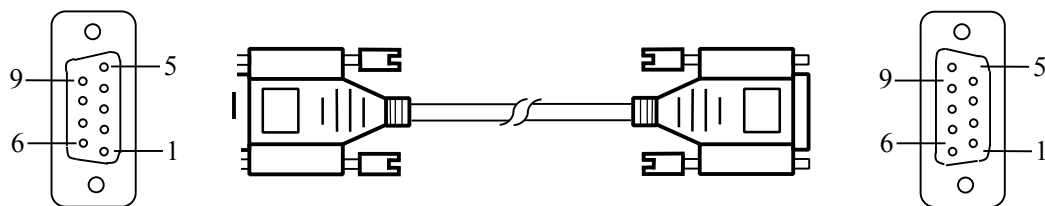

SK series touch screen uses DB9F connector. ZhengHang A5 series PLC terminal is DB9M.

2. Software setting

- ✓ Select ZhengHang Electronics in the connection device service.
- ✓ Select the corresponding item in the connection device service according to the PLC model or supporting protocol.
- ✓ Make sure the communication parameters and PLC station number of touch screen is consistent with that of PLC.
- ✓ Please refer to relative technical documents of ZhengHang A5 series PLC for device setting.

Default connection parameters of SK series touch screen

Setting Item	Default Parameters	Setting Range
PLC	A5 Series	A5 Series
Communication port	RS232	RS232/RS422/RS485
Baud rate	9600	1200/2400/4800/9600/19200/38400/57600/115200
Data bit length	8	7/8
Parity check bit	NONE	EVEN/ODD/NONE
Stop bit length	1	1/2
PLC station number	1	0~255
HMI station number	0	0~255

Support functions	Yes/No
-------------------	--------

Offline simulation	Yes
Online simulation	Yes
Extension mode	Yes

3. Operable register and address range

Register Name	Address Format	Input Range	Remark
I	dd.o	0.0~15.7	Bit: input image register, read only
Q	dd.o	0.0~15.7	Bit: output image register
M	dddd.o	0.0~4095.7	Bit: bit memory
VW	dddd	0~1998	Word: variable storage, 8-bit register, each word occupies two addresses
AIW	d	0~9	Word: analog input, read only
AQW	d	0~9	Word: analog output, write only

- Note
- d indicates decimal, and the input range is 0-9;
 - O indicates octal, and the input range is 0-7;
 - "word" in the remark indicates the register can be used as word only;
 - "Bit" in the remark indicates the register can be used as bit only;
 - "Read only" in the remark indicates the register can be read only rather than write-in;
 - Different device models may support different register names and the range may be different. Detailed names and range refer to the relative technical documents for connected device.

11. Appendix

11.1. How to export data with U-disk or SD card

SK series touch screen supports to export historical data, historical alarm and screen snap with U disk or SD card.

How to export historical data with U disk or SD card

1. Insert U disk or SD card
2. Triggering LB60125 to be ON, HMI will copy all historical alarm files to SD card.
Triggering LB60126 to be ON, HMI will copy all historical data files to SD card.
Triggering LB60127 to be ON, HMI will copy all historical alarm files to U disk.
Triggering LB60128 to be ON, HMI will copy all historical alarm files to U disk.
When the export completes, these trigger positions will reset to OFF automatically.
Please use LW register LW60359-LW60429 while exporting partial data.

How to obtain the screen shot with U disk or SD card

1. Insert U disk or SD card
2. Please select function button -> screen shot, and export to U disk or SD card in configuration.
3. While triggering the function button, HMI will save the current screen shot into corresponding storage.

- Note:
- Do not disconnect U disk or SD card during exporting;
 - Keep HMI powered during exporting;
 - Make sure your U disk or SD card has sufficient memory space.

11.2. How to update a project with U disk or SD card

SK series touch screen supports to import your project into HMI with U disk or SD card for updating HMI operational configuration.

How to update project files with U disk or SD card

1. Compile project



Run SKWorkshop, and open the project to be updated. Click , and generate the compiled file.

2. Copy the compiled file into U disk or SD card
Open SKWorkshop root directory\compile, copy project.bin into U disk or SD card.
3. Rename project.bin
Rename project.bin copied into U disk or SD card as u-disk-prj.bin.
4. Insert U disk or SD card to HMI
5. Copy files and re-update the project
After the U disk or SD card is inserted, HMI will pop up hint as following. Click YES in the window, and enter into updating.

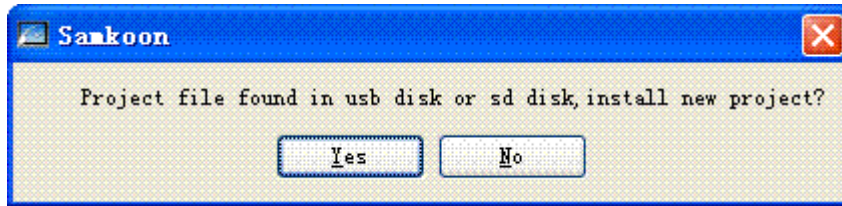

5. Restart HMI and complete updating.
Restart HMI power or click Restart button on the screen to restart HMI.

Note:

- Do not disconnect U disk or SD card during updating;
- Keep HMI powered during updating;

11.3. Image formats supported by SK series touch screen

SK series touch screen supports many image formats such as jpg, bmp, gif, png etc. However, to ensure the display efficiency, the default image is compressed and converted into JPG format in HMI (except gif display control).

If you want to keep the original format, please select the image option as “keep the original format” or “convert image to JPG” from the menu “touch screen parameter setting -> printer download setting”.

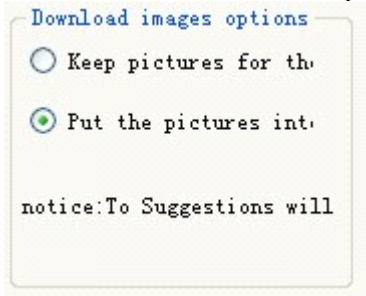

Note:

- Converting image to jpg format can save the memory control and accommodate more images.
- Using the image whose resolution is not greater than HMI screen resolution could improve display efficiency;
- The max frames of gif image are 32 frames.

11.4. Dial switch

SK series touch screen provides a dial switch. Each switch corresponds to the separate function.

Function list of dial switch

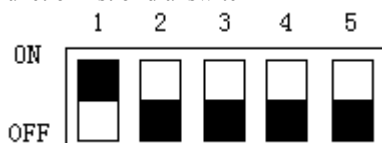

Dial switch (5-1)	Functions
00000	Normal operation mode
00001	Coordinate adjustment mode
00010	Parameter display mode
00100	Terminal mode
00101	Parameter setting mode

-
- Note:
- HMI has to be restarted after the dial switch is adjusted;
 - Please adopt the normal operation mode when using HMI in normal condition;
 - Parameter setting mode is used for setting time, luminance and IP address.
-

12. Contact

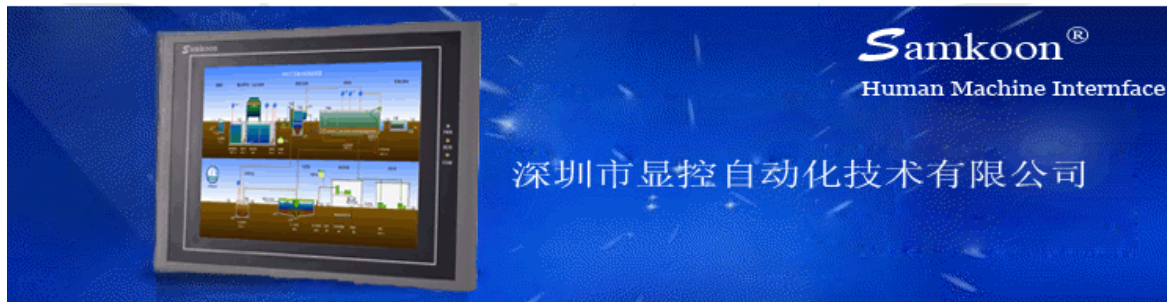

Innovation Specialty Leading Win-win

Shenzhen Samkoon Automation Technology Co., Ltd

**Address: Building C6 Hengfeng Industrial
Baoan District, Shenzhen, China.**

TEL: 0755--29419068

FAX: 0755-29455559

E-Mail: szsamkoon@163.com

Web: [Http://www.samkoon.com.cn](http://www.samkoon.com.cn)