

1

2

3

4

A

A

B

B

C

C

D

D

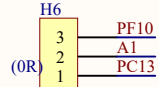

Header 3

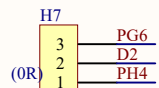

Header 3

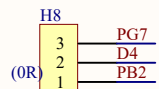

Header 3

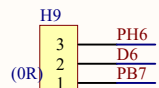

Header 3

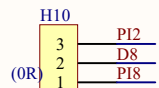

Header 3

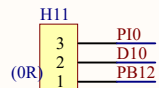

Header 3

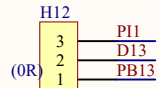

Header 3

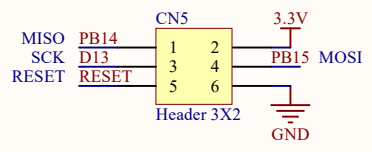
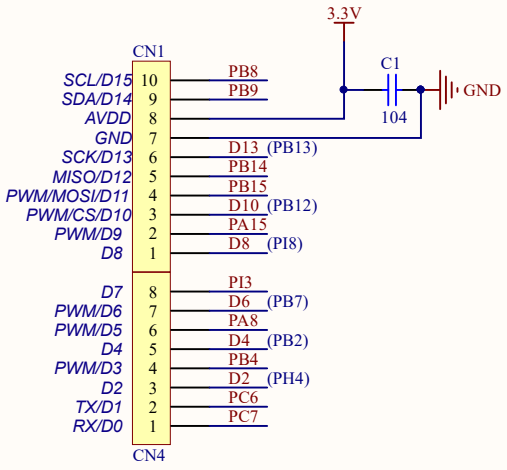
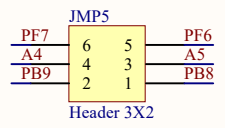
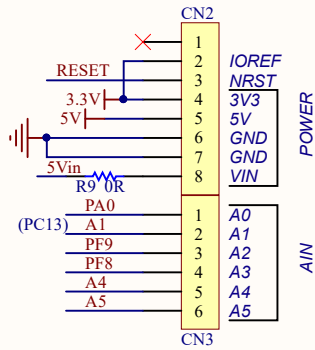

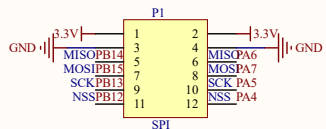

SPI2

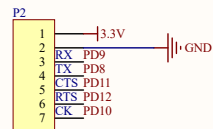

SPI1

USART3

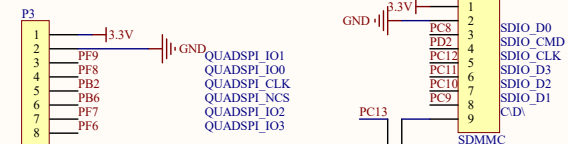

QUADSPI

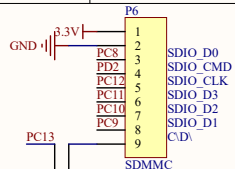

SDMMC

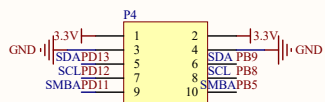
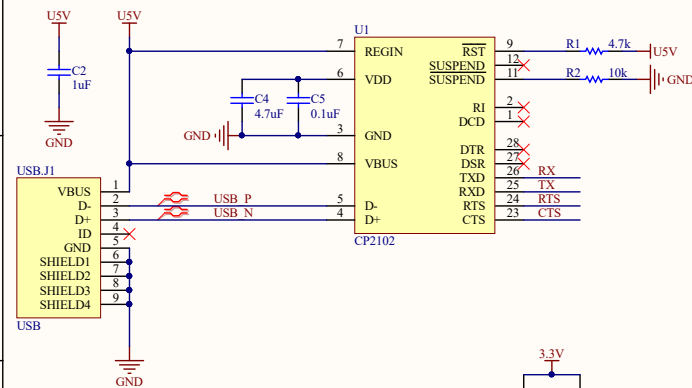

I2C2

I2C1

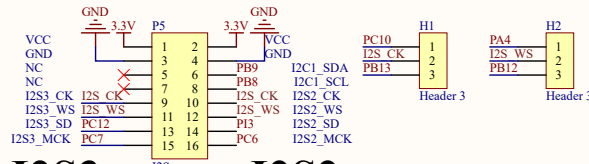

I2S3

I2S2

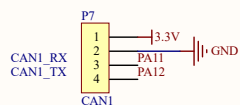

CAN1

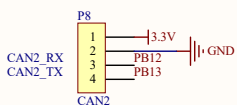

CAN2

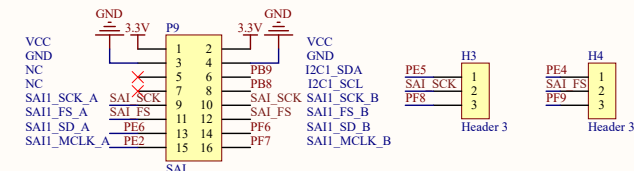

SAI\_A

SAI\_B

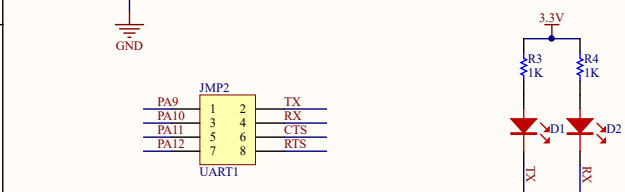

UART1

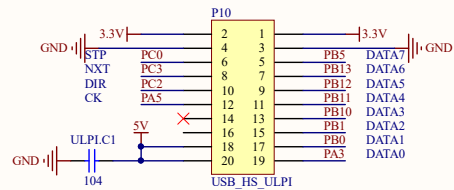

USB HS ULPI

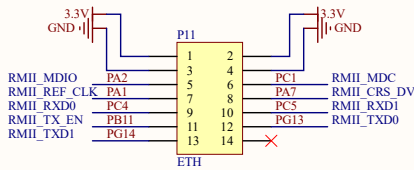

ETH

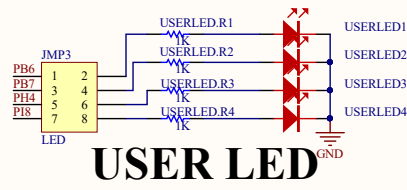

USER LED

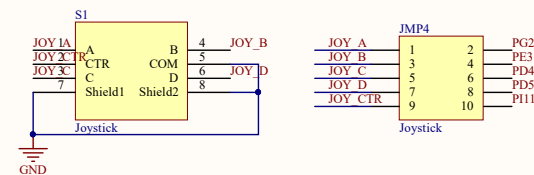

Joystick

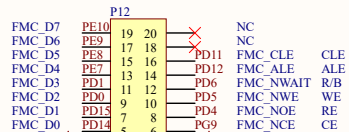

NAND FLASH

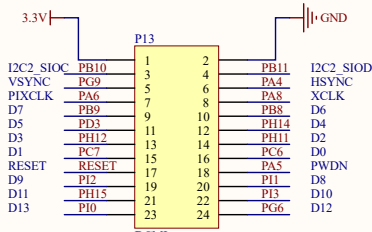

DCMI

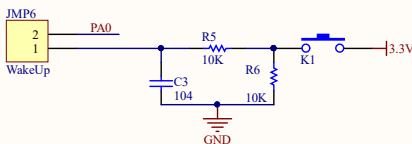

WakeUp Button

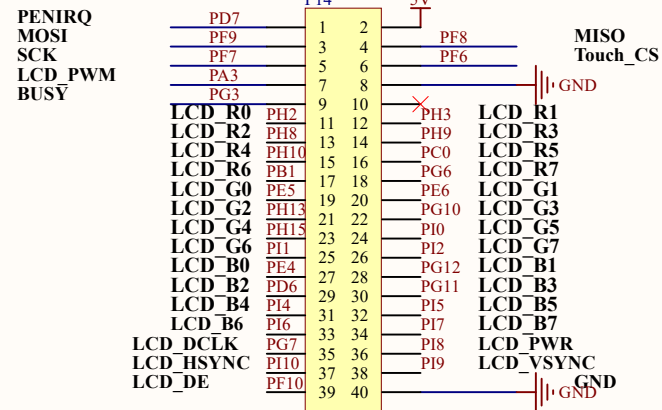

# RGB Header Interface

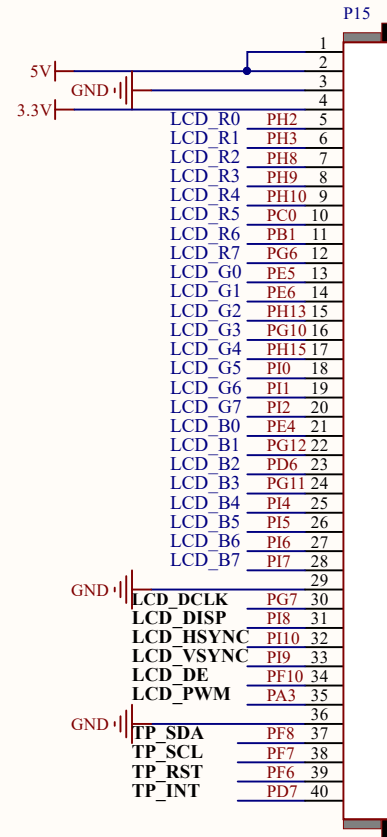

# RGB Cable Interface

# Pin Port

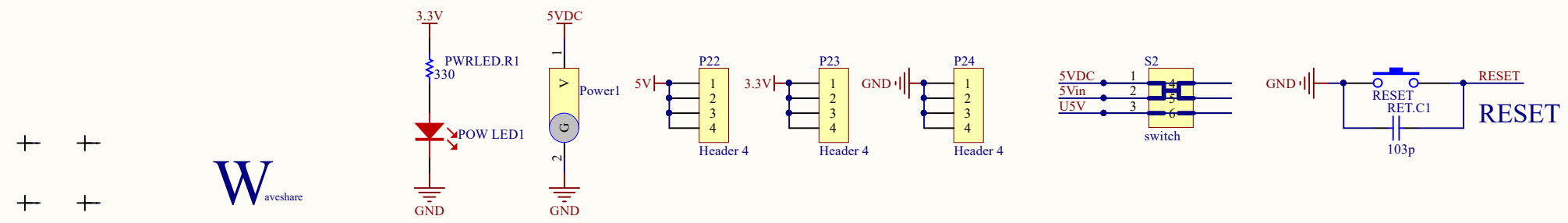
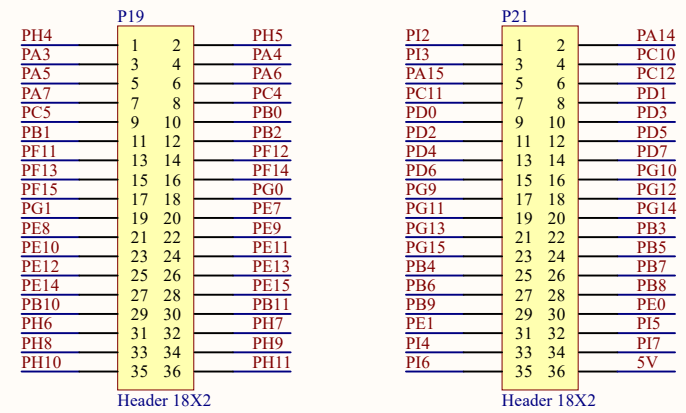
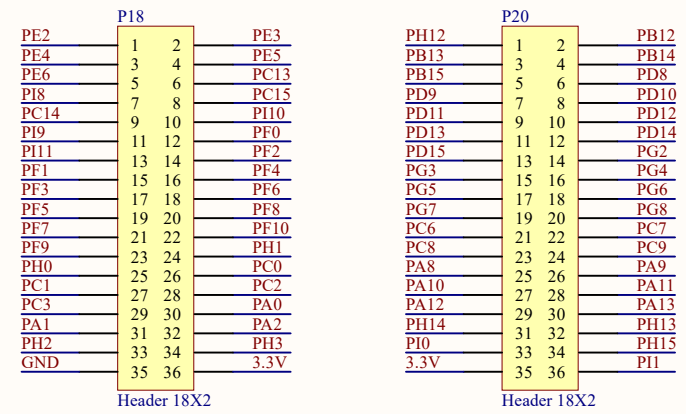
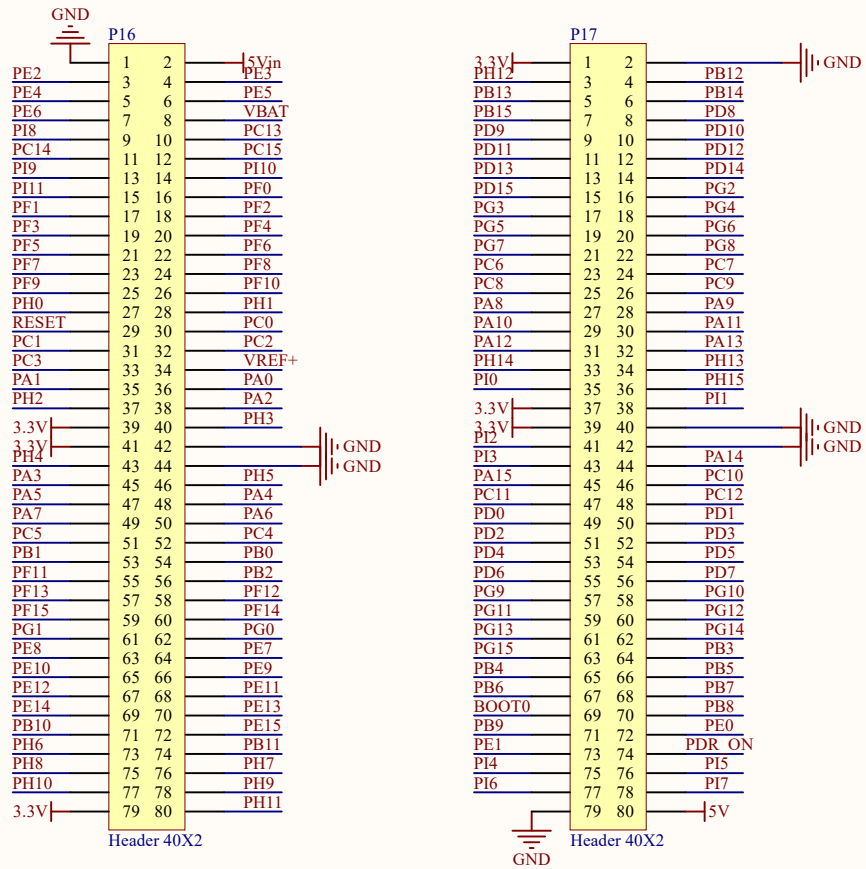

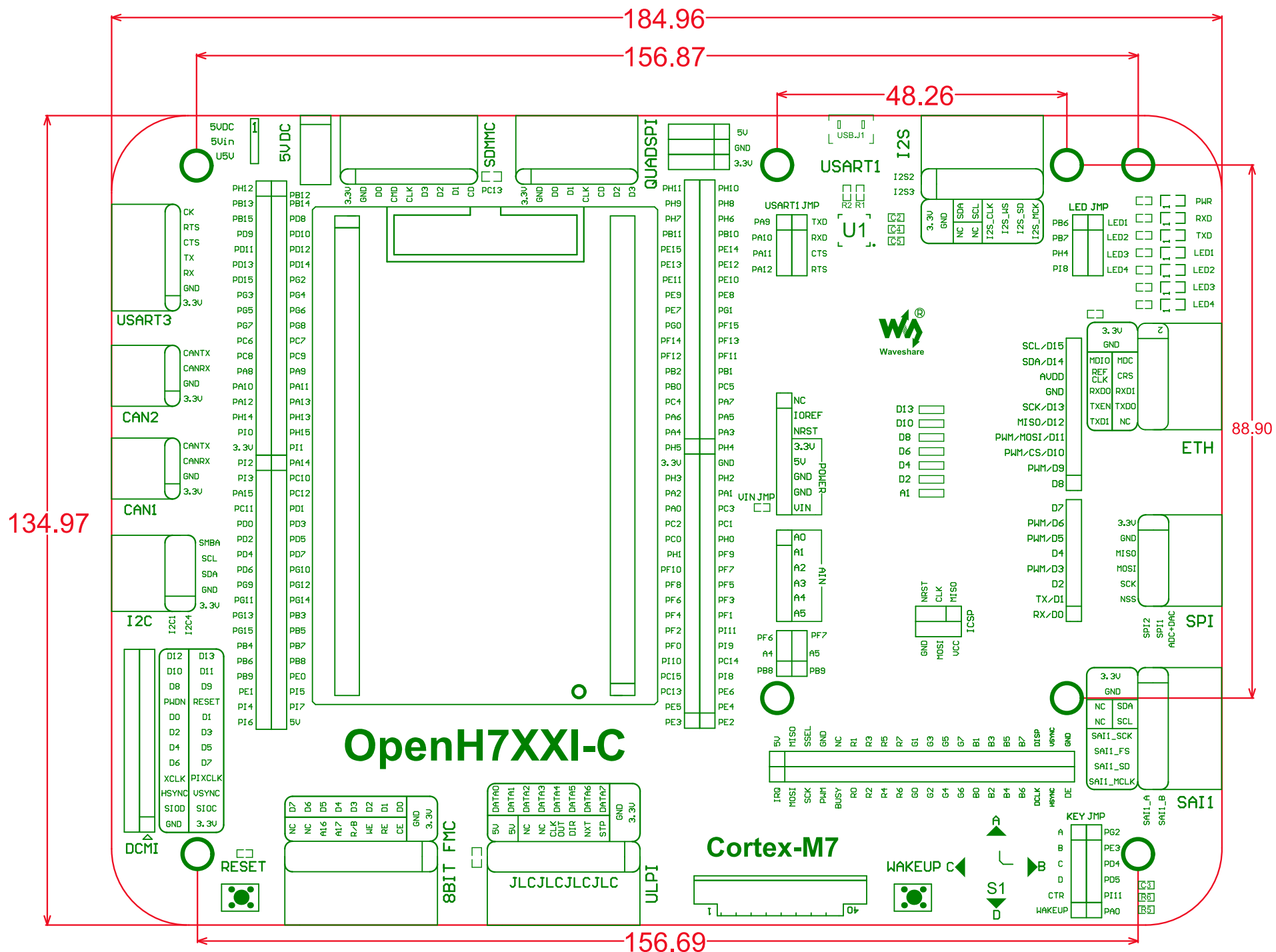

**Unit: mm**