

WizFi360 Datasheet

(Version 1.10)



 **WIZnet**

<http://www.wiznet.io>

Document Revision History

Date	Revision	Changes
2019-07-26	V0.9	Temporary Release
2019-09-02	V1.0	Edited "5. Pin Definitions" Added "5.1 Initial Value of GPIO Pins" Added "Figure3. WizFi360 Pinout"
2019-09-19	V1.01	Edited "Figure3. WizFi360 Pinout" Edited "Table4. WizFi360 Pin Function" Added "7. Peripheral Circuit Reference Design" Added "8. Recommended PCB Land Pattern" Added "9. Reflow Condition"
2019-10-10	V1.02	Edited "Table 1. Description on Power Consumption"
2019-10-18	V1.03	Edited "Figure3. WizFi360 Pinout"
2019-11-27	V1.04	Edited "Figure3. WizFi360 Pinout" Edited "Table4. WizFi360 Pin Function" Edited "Table6. Initial Value of GPIO Pins"
2019-12-11	V1.05	Edited "5. Pin Definitions" No.11 & No.19
2021-03-17	V1.06	Edited "5. Pin Definitions" No.19
2022-02-09	V1.07	Edited "5. Pin Definitions" Figure 3
2022-04-05	V1.08	Edited "2. Features"
2022-06-30	V1.09	Edited "4. Package Information" Figure 2 Edited "7. Peripheral Circuit Reference Design" Figure
2022-10-14	V1.10	Added "ISED certification number" Added "FCC ID" Added "Industry Canada statement"

Table of Contents

1. Overview	4
2. Features	4
3. Parameters	6
4. Package Information	8
4.1. WizFi360-PA	8
4.2. WizFi360-CON	8
5. Pin Definitions	9
5.1. Initial Value of GPIO Pins	10
6. Physical Dimensions	12
6.1. WizFi360-PA Dimensions	12
6.2. WizFi360-CON Dimensions	13
7. Peripheral Circuit Reference Design	14
8. Recommended PCB Land Pattern	15
9. Reflow Condition	16
10. Important Notice	17

1. Overview

WizFi360 is a low cost and low-power consumption industrial-grade WiFi module. It is compatible with IEEE802.11 b/g/n standard and supports SoftAP, Station and SoftAP+Station modes. The serial port baud rate can be up to 2Mbps, which can meet the requirement of various applications.

2. Features

- WiFi 2.4G, 802.11 b/g/n
- Support Station / SoftAP / SoftAP+Station operation modes
- Support "Data pass-through" and "AT command data transfer" mode
- Support serial AT command configuration
- Support TCP Server / TCP Client / UDP operating mode
- Support configuration of operating channel 1 ~ 13
- Support auto 20MHz / 40MHz bandwidth
- Support WPA_PSK / WPA2_PSK encryption
- Serial port baud rate up from 600bps to 2Mbps with 16 common values
- Support up to 5 TCP / UDP links
- Obtaining IP address automatically from the DHCP server (Station mode)
- DHCP service for Wireless LAN clients (AP mode)
- Support DNS for communication with servers by domain name
- Support "Keep-Alive" to monitor TCP connection
- Support "Ping" for monitoring network status
- Built-in SNTP client for receiving the network time
- Support built-in unique MAC address and user configurable
- Support firmware upgrade by UART Download / OTA (via WLAN)
- Industrial grade (operating temperature range: -40 ° C ~ 85 ° C)
- CE, FCC, KC, K-MIC(TELEC), IC, RoHS, REACH certification
- FCC ID: 2ATUB-WIZFI360PA

- WizFi360-PA IC labell

WizFi360-PA IC: 20560-WIZFI360PA

HW version(HVIN) : 1.2

Firmware Version(FVIN) : 1.1.1.9

Product Marketing Name(PMN) : WizFi360-PA

3. Parameters

Categories	Items	Values
Wireless	Wireless Standard	802.11 b/g/n
	Frequency Range	2.4GHz-2.5GHz (2400MHz~2483.5MHz)
Hardware	Serial Data Interface	3.3V TTL×1 : TXD、RXD、CTS、RTS、GND
	Operating Voltage	3.0~3.6V (Typical 3.3V)
	Operating Temperature	-40°C ~85°C
Software	WiFi Operation Modes	Station / SoftAP / SoftAP + Station
	Encryption Method	WPA_PSK/WPA2_PSK
	Operation Modes	TCP Server/TCP Client/UDP
	Configuration Mode	AT command set
	Firmware Upgrade	UART Download / OTA (via WLAN) upgrade
Certification Report		CE, FCC, KC

Table 2. Parameters

Parameter	Typical value	Unit
Input Frequency	2400~2484	MHz
Output Power		
PA Output Power at 72.2Mbps	12	dBm
PA Output Power in 802.11b	19	dBm
Sensitivity		
DSSS,1 Mbps	-95	dBm
CCK,11 Mbps	-86	dBm
OFDM,6 Mbps	-89	dBm
OFDM,54 Mbps	-73	dBm
HT20, MCS0	-89	dBm
HT20, MCS7	-71	dBm
Adjacent-channel interference (ACI)		
OFDM,6 Mbps	32	dB
OFDM,54 Mbps	15	dB
HT20, MCS0	29	dB
HT20, MCS7	10	dB

Table 3. Receiver Sensitivity

Mode	Typical	Max	Unit
Send IEEE802.11b, CCK 11Mbps, POUT = +19 dBm	230	290	mA
Send IEEE802.11g, OFDM 54Mbps, POUT = +13.5 dBm	210	-	mA
Send IEEE802.11n, OFDM MCS7, POUT = +12 dBm	210	-	mA

Receive IEEE802.11 b/g/n	100-110		mA
Standby Mode	135		uA
Modem Sleep Mode	20		mA
Light Sleep Mode	13		mA

Table 4. Description on Power Consumption

- Standby mode
 - MCU will shut down all the peripherals and CPU will be powered down too. CPU can be wake up by external WP(WAKEUP) PIN or internal Timer.
- Modem Sleep mode
 - All peripherals of the MCU will operate.
- Light Sleep mode
 - Shutdown peripheral except for UART, TIMER, RCFG GPSED

4. Package Information

4.1. WizFi360-PA

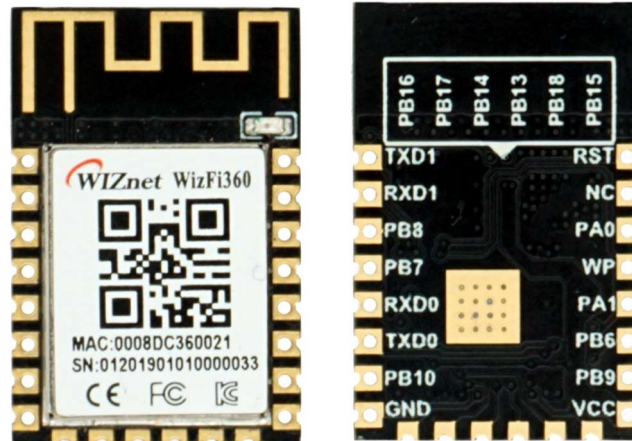

Figure 1. WizFi360-PA

- Onboard PCB antenna
- Onboard LED light, TX/RX LED
- Dimension: 24 × 16 × 3.2 (mm)

4.2. WizFi360-CON



Figure 2. WizFi360-CON

- Onboard IPEX connector for connecting antenna
- ANT pin for external antenna
- Dimension: 17 × 16 × 3.2 (mm)

5. Pin Definitions

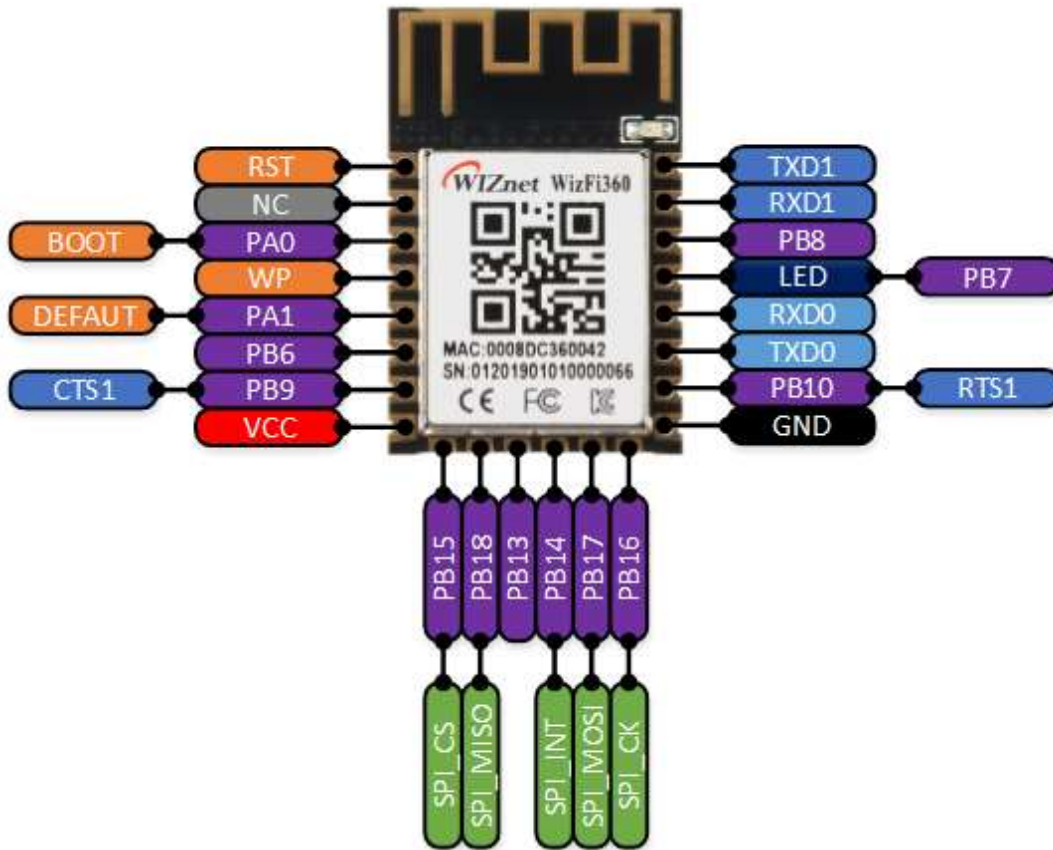

Figure 3. WizFi360 Pinout

No	Pin Name	Type	Pin Function
1	RST	I	Module Reset Pin (Active Low)
2	NC	-	Reserved
3	PA0	I/O	BOOT Pin (Active low) When power on or reset is low, it operates in Boot mode. In the normal operating mode, this pin can be controlled by AT command.
4	WP	I	WAKE-UP Pin (Active High) If the wake-up pin is high in Standby mode, the WizFi360 is reset to the normal operating mode.
5	PA1	I	Pull down over 3s for taking effect. UART1's current parameter changes to default value (please refer to the AT+UART_CUR command in WizFi360 AT command manual).
6	PB6	I/O	This pin can be controlled by AT command.
7	PB9	I	CTS Pin of UART1 If you don't use the CTS function, this pin can be controlled by AT command.
8	VCC	P	Power Pin (Typical Value 3.3V)

9	PB15	I/O	CSn Pin of SPI If you don't use the SPI function, this pin can be controlled by AT command.
10	PB18	I/O	MISO Pin of SPI If you don't use the SPI function, this pin can be controlled by AT command.
11	PB13 / SPI_EN	I/O	Enable Pin of SPI When power is applied or reset, this pin is checked to set the module mode. High or NC – UART Mode (Default) Low – SPI Mode
12	PB14	I/O	INTn Pin of SPI If you don't use the SPI function, this pin can be controlled by AT command.
13	PB17	I/O	MOSI Pin of SPI If you don't use the SPI function, this pin can be controlled by AT command.
14	PB16	I/O	CLK Pin of SPI If you don't use the SPI function, this pin can be controlled by AT command.
15	GND	I/O	Ground Pin
16	PB10	O	RTS Pin of UART1 If you don't use the RTS function, this pin can be controlled by AT command.
17	TXD0	O	TXD Pin of UART0
18	RXD0	I	RXD Pin of UART0
19	PB7	O	LED Light output (Active High). Go to High while each TX/RX packet and then back to Low. Note: It has been connected to onboard LED for WizFi360-PA
20	PB8	I/O	This pin can be controlled by AT command.
21	RXD1	I	RXD Pin of UART1
22	TXD1	O	TXD Pin of UART1

Table 5. WizFi360 Pin Function

***Note: UART1 is used for AT command and data communication. UART0 is used for debugging and firmware upgrade.**

5.1. Initial Value of GPIO Pins

This is the initial value of GPIO when using AT command to use GPIO on the WizFi360.

Pin Name	Initial Mode	Value
PA0	I	High
PB6	O	Low
PB9	O	Low
PB15	O	Low

PB18	O	Low
PB14	O	Low
PB17	O	Low
PB16	O	Low
PB10	O	Low
PB07	O	Low
PB08	O	Low

Table 6. Initial Value of GPIO Pins

6. Physical Dimensions

6.1. WizFi360-PA Dimensions

24(L) x 16(W) x 3.2(H) (± 0.1), (unit: mm)

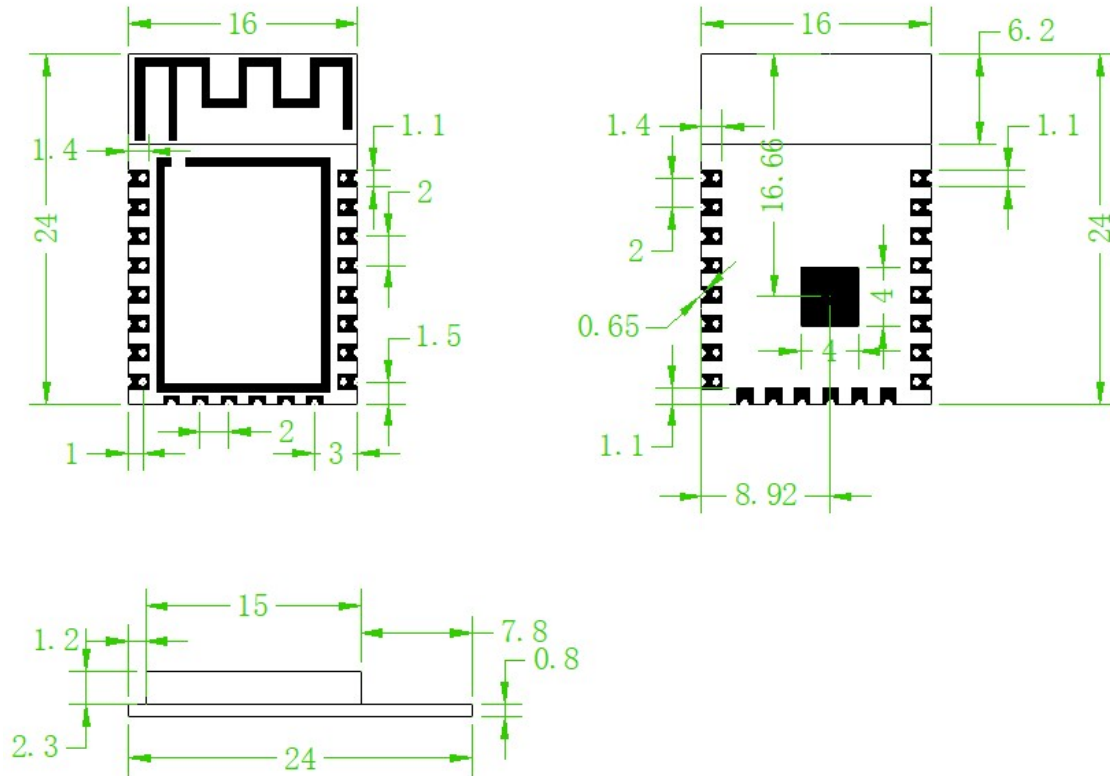

Figure 4. WizFi360-PA Physical Dimensions

6.2. WizFi360-CON Dimensions

17(L) x 16(W) x 3.2(H) (± 0.1), (unit: mm)

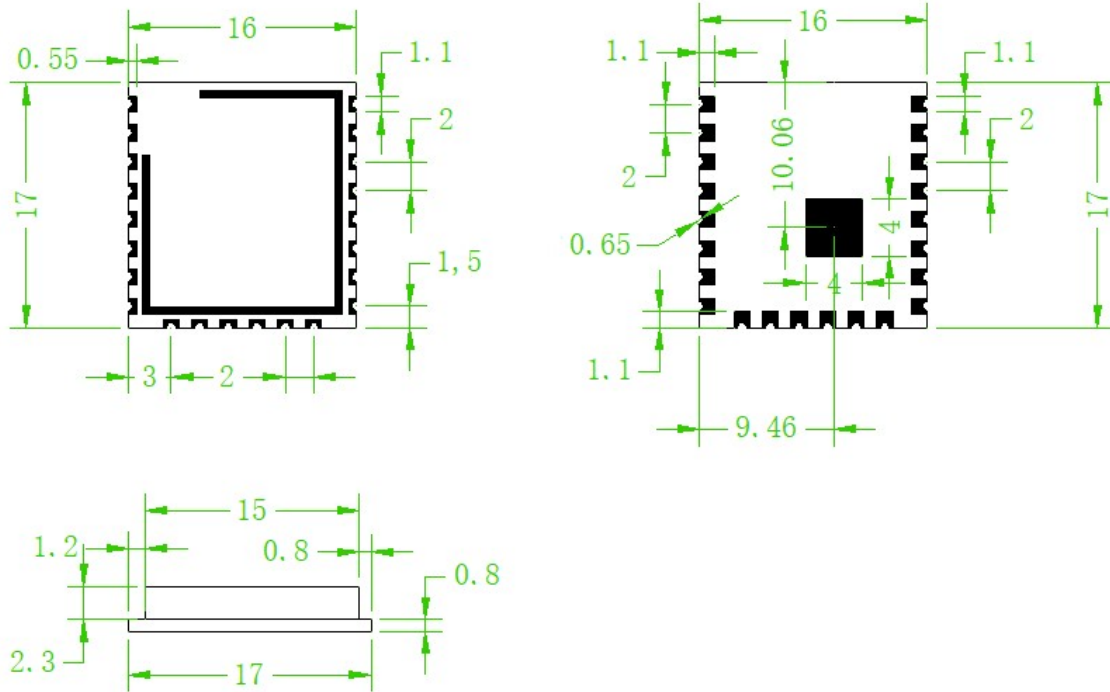

Figure 5. WizFi360-CON Physical Dimensions

7. Peripheral Circuit Reference Design

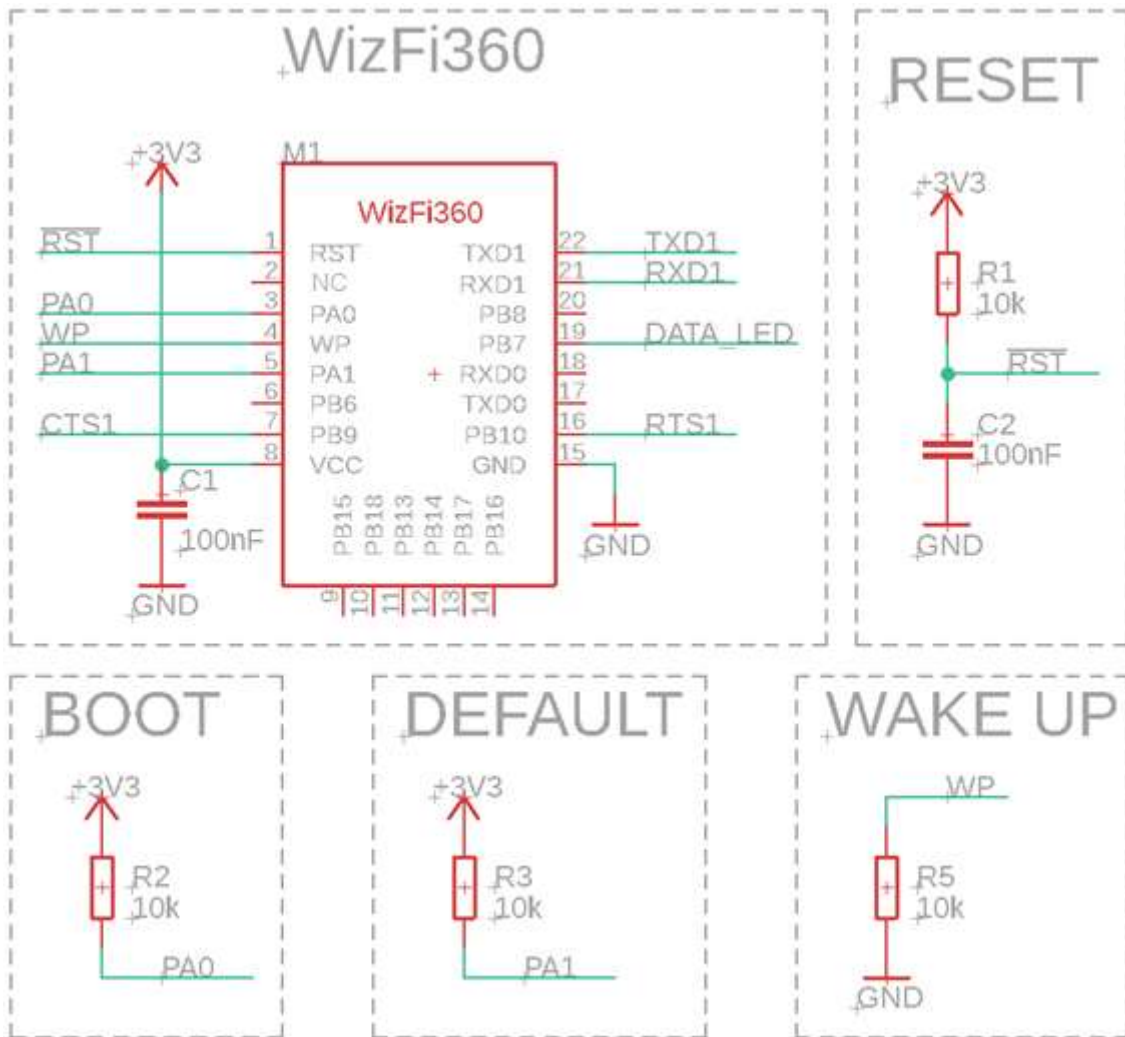

Figure 6. WizFi360 Circuit Reference Design

8. Recommended PCB Land Pattern

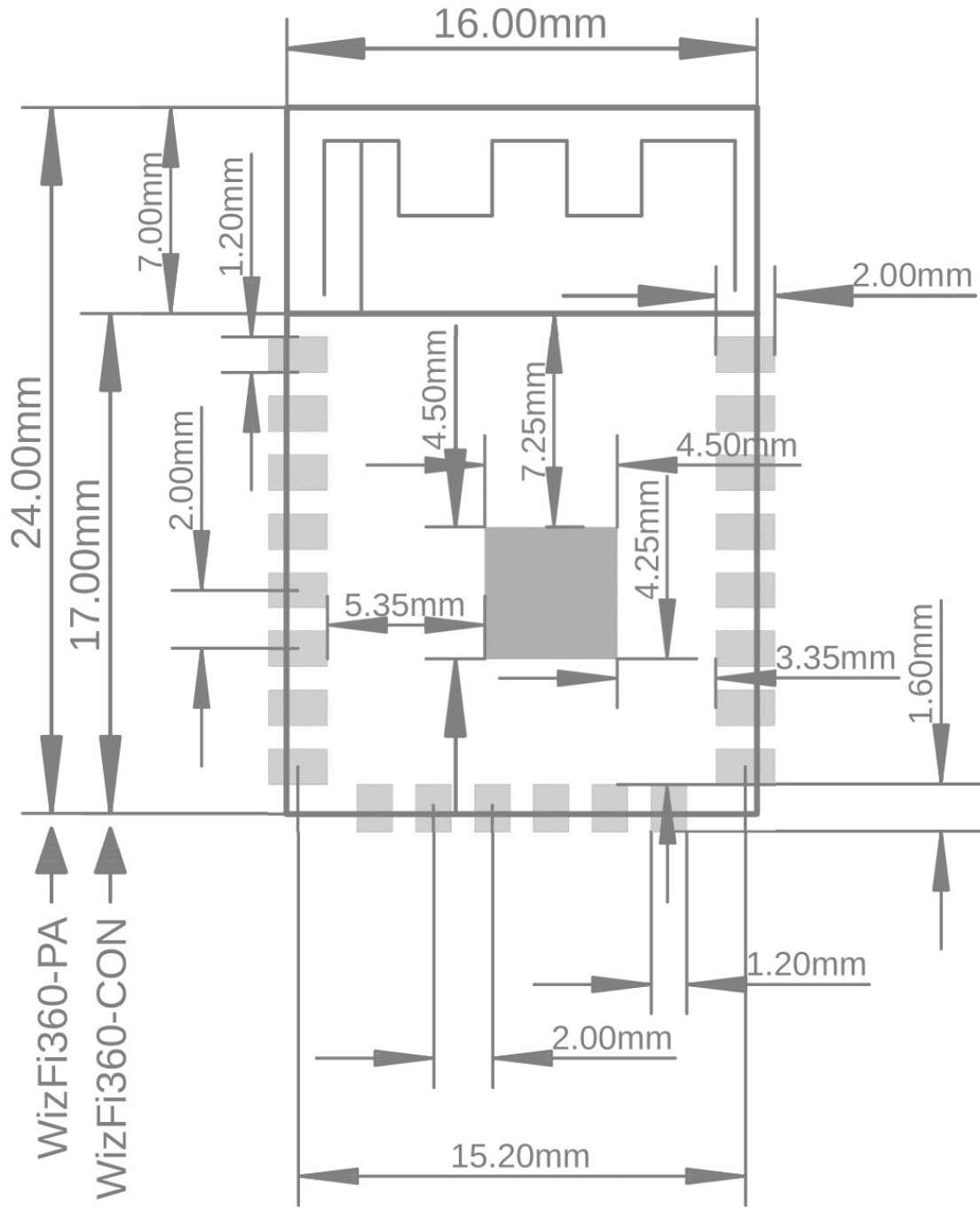

Figure 7. Recommended PCB Land Pattern of WizFi360-PA

9. Reflow Condition

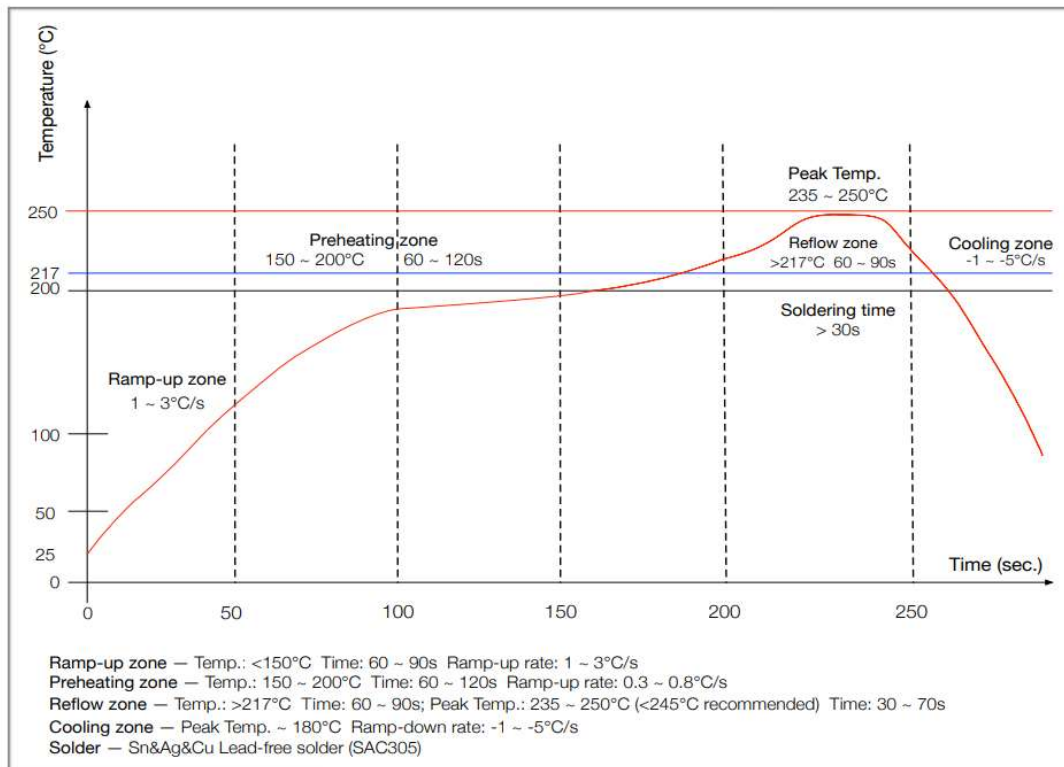

Figure 8. Reflow Condition

10. Important Notice

WIZnet reserves the right to make corrections, modifications, enhancements, improvements and other changes to its products and services at any time, and to discontinue any product or service without notice. Customers should obtain the latest relevant information before placing orders, and should verify that such information is current and complete. All products are sold subject to WIZnet's terms and conditions of sale, supplied at the time of order acknowledgment. Information relating to device applications, and the like, is intended as suggestion only and may be superseded by updates. It is the customer's responsibility to ensure that their application meets their own specifications. WIZnet makes no representation and gives no warranty relating to advice, support or customer product design.

WIZnet assumes no responsibilities or liabilities for the use of any of its products, conveys no license or title under any patent, copyright or mask work rights to these products, and makes no representations or warranties that these products are free from patent, copyright or mask work infringement, unless otherwise specified.

WIZnet products are not intended for use in life support systems/appliances or any systems where product malfunction can reasonably be expected to result in personal injury, death, severe property damage or environmental damage. WIZnet customers using or selling WIZnet products for use in such applications do so at their own risk and agree to fully indemnify WIZnet for any damages resulting from such use.

All trademarks are the property of their respective owners.

Instruction to OEM

This device complies with Industry Canada's license-exempt RSSs. Operation is subject to the following two conditions:

- (1) This device may not cause interference; and
- (2) This device must accept any interference, including interference that may cause undesired operation of the device.

This application and its antenna must not be co-located or operation in conjunction with any other antenna or transmitter. A minimum separation distance of 20cm must be maintained between the antenna and the person for this appliance to satisfy the RF exposure requirements.

Instruction à l'OEM

Ce dispositif est conforme au RSS exempté de licence d'Industrie Canada L'opération est soumise aux deux conditions suivantes:

- (1) Ce dispositif ne peut pas causer d'interférence; et
- (2) Ce dispositif doit accepter toute interférence, y compris toute interférence pouvant causer un fonctionnement indésirable de l'appareil.

Cette application et son antenne ne doivent pas être localisées ou exploitées conjointement avec une autre antenne ou émetteur. Une distance minimale de séparation de 20 cm doit être maintenue entre l'antenne et la personne de cet appareil pour satisfaire aux exigences d'exposition RF.

Copyright Notice

Copyright 2022 WIZnet Co., Ltd. All Rights Reserved.

Technical Support: <https://forum.wiznet.io/>

Sales & Distribution: sales@wiznet.io

For more information, visit our website at <http://www.wiznet.io/>