

### Voltage Regulator and Battery Charger

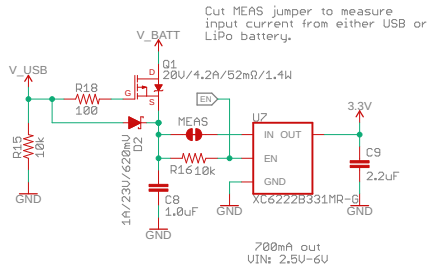

### Lithium-Polymer Battery Charger (1-cell)

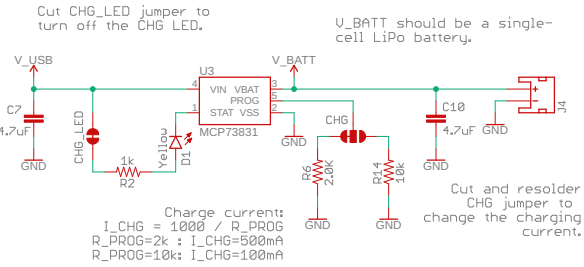

### USB-C Firmware Upload

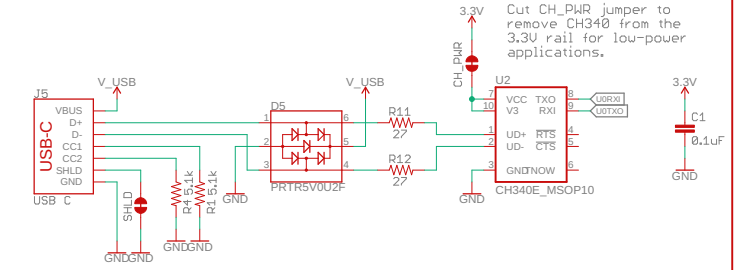

### Qwiic Connector

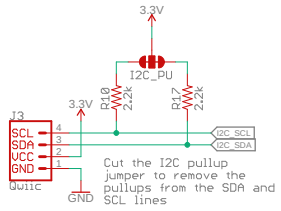

### DA16200 Module

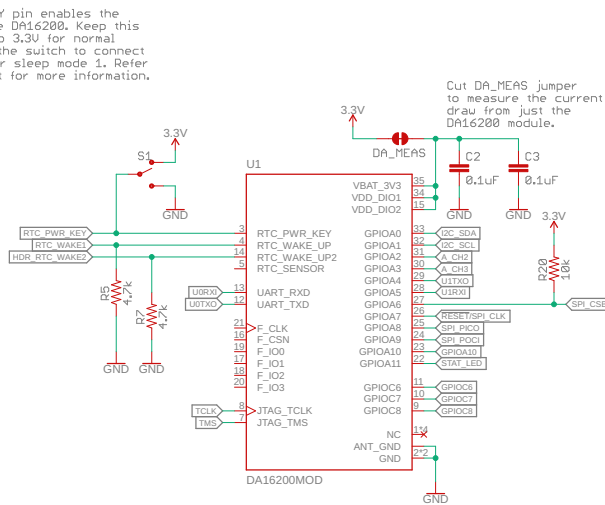

### Debug Header

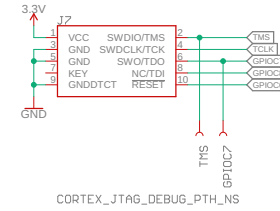

### Thing Plus

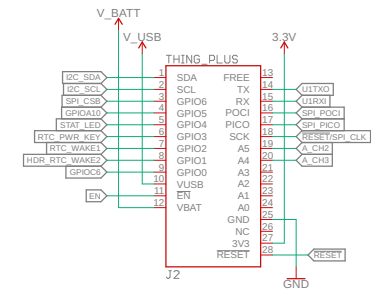

### Power LED Status LED

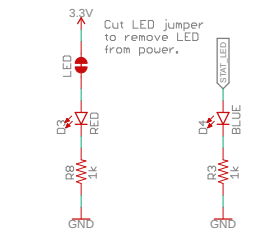

### Reset Button

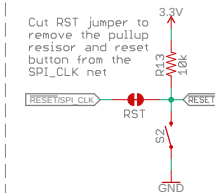

Released under the Creative Commons Attribution Share-Alike 4.0 License  
<https://creativecommons.org/licenses/by-sa/4.0/>

TITLE: DA16200_Thing_Plus	
Design by: Priyanka Makin	REV: v11
Date: 8/23/2022 5:13 PM	Sheet: 1/1