

System Regulator

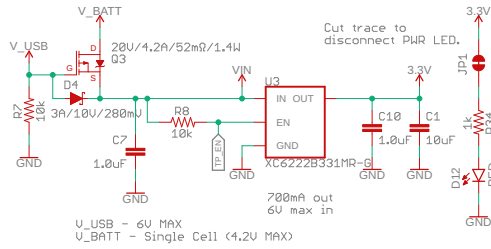

Lithium-Polymer Battery Charger

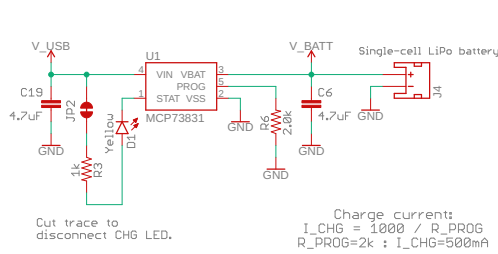

USB-to-Serial Converter

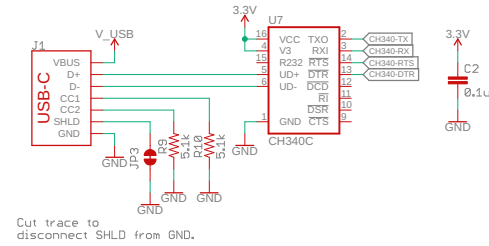

Fuel Gauge

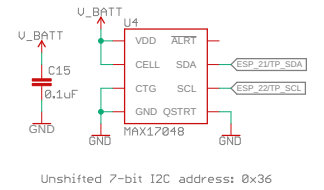

Auto-Reset

Boot Mode Configuration

Pin	Run	Bootloader	Default
I08	1	0	1
I02	x	0	0
I05	1	x	1
I04,2	0	0	0
I015	x	x	1

I012 = MDTI, I015 = MDTO

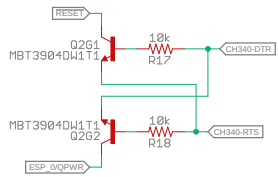

If DTR is LOW, toggling RTS from HIGH to LOW resets to run mode.
If RTS is HIGH, toggling DTR from LOW to HIGH resets to bootloader.

Espressif ESP32-WROOM

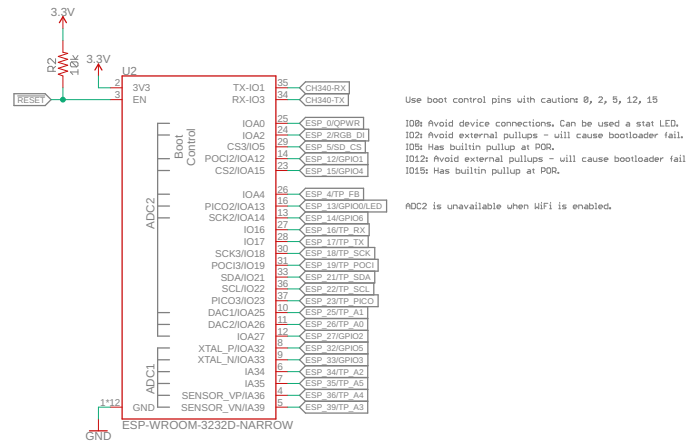

RGB Status LED

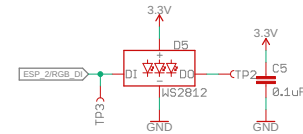

Status LED

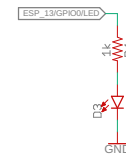

ThingPlus Form Factor

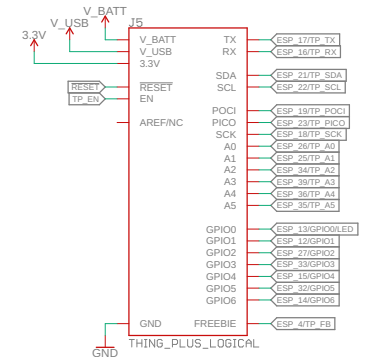

microSD Connector

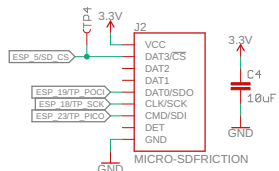

Qwiic Connector

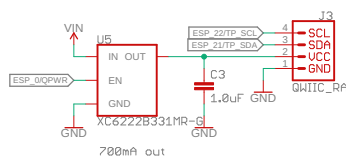

GPIO0/Boot Button

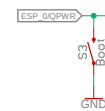

Reset Button



Released under the Creative Commons Attribution Share-Alike 4.0 License
<https://creativecommons.org/licenses/by-sa/4.0/>

TITLE: SparkFun_Thing_Plus_ESP32_WROOM_C

Design by: Nathan Seidle
 Revised by: Alex Brudner

Date: 7/7/2022 1:25 PM

REV: v10
 Sheet: 1/1