

FTDI-D10..71

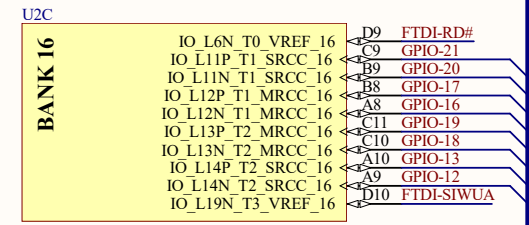

GPIO-I0..1391

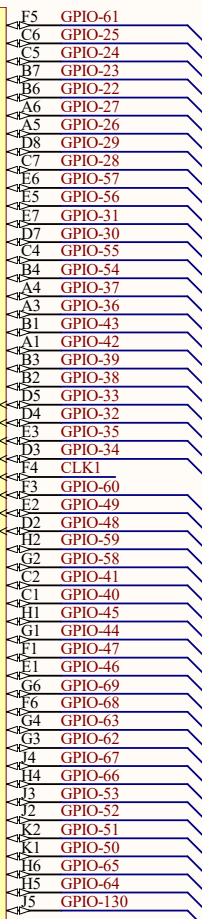
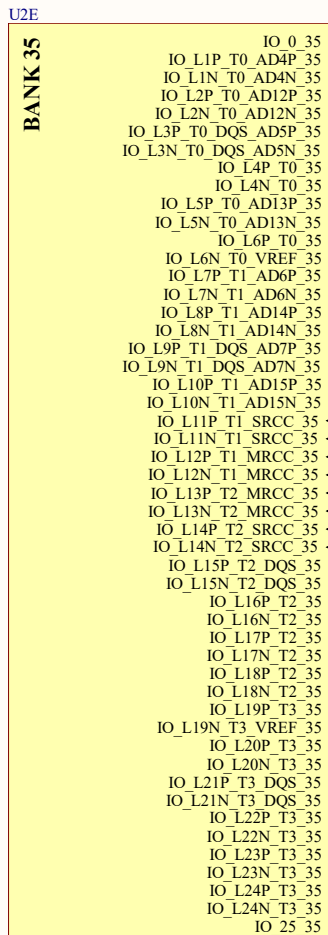
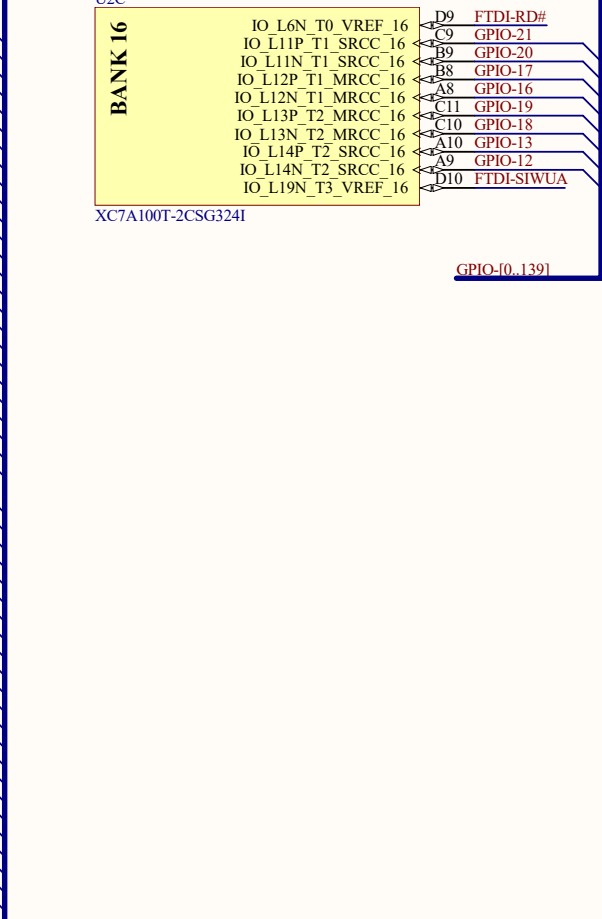

Title: NESO		Revision: V2		Numato Systems Pvt Ltd	Cannot open file D:\NumatoS chTemplate\ numatologo
Size: A4	Project: Neso.PjPcb				
Date: 12/14/2017	Time: 15:46 AM	Sheet 4 of 9			
File: FPGA_B.SchDoc					

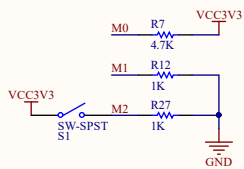
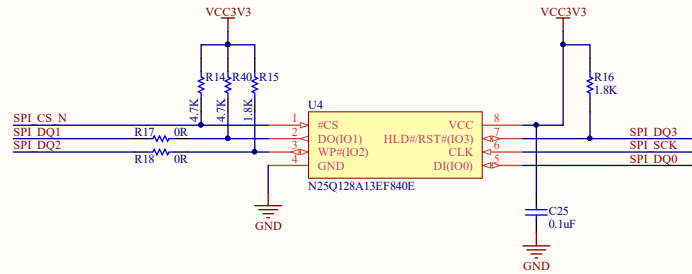
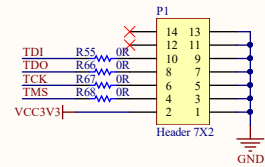
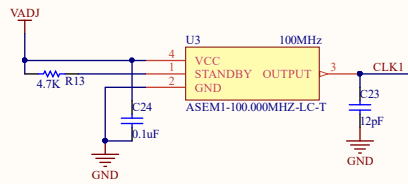
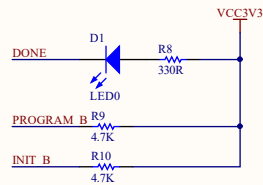
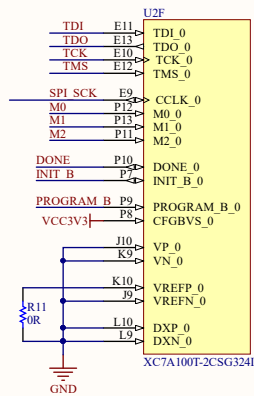

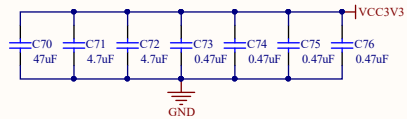
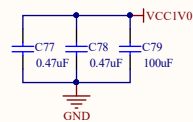
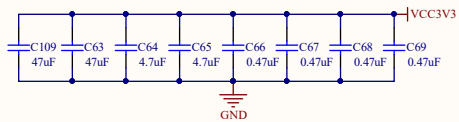
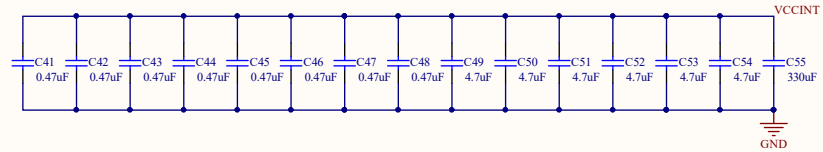
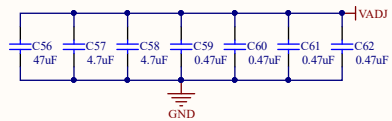
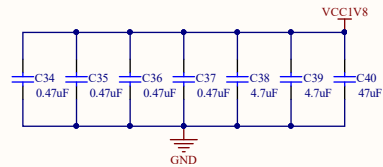
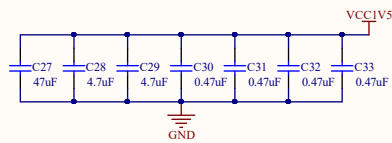
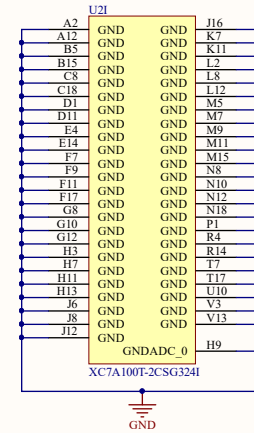
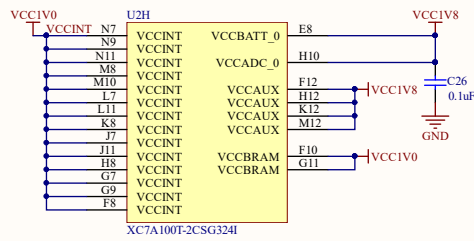
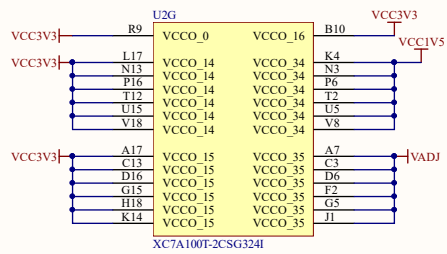

P4

GND	1	2	VCC3V3
VIN	3	4	GND
GPIO-0	5	6	GPIO-1
GPIO-2	7	8	GPIO-3
GPIO-4	9	10	GPIO-5
GPIO-6	11	12	GPIO-7
GPIO-8	13	14	GPIO-9
GPIO-10	15	16	GPIO-11
GPIO-12	17	18	GPIO-13
GPIO-14	19	20	GPIO-15
GPIO-16	21	22	GPIO-17
GPIO-18	23	24	GPIO-19
GPIO-20	25	26	GPIO-21
GPIO-22	27	28	GPIO-23
GPIO-24	29	30	GPIO-25
GPIO-26	31	32	GPIO-27
GPIO-28	33	34	GPIO-29
GPIO-30	35	36	GPIO-31
GPIO-32	37	38	GPIO-33
	39	40	
	41	42	
GPIO-34	43	44	GPIO-35
	45	46	
GPIO-36	47	48	GPIO-37
GND	49	50	GND
GND	51	52	GND
	53	54	
GPIO-38	55	56	GPIO-39
GPIO-40	57	58	GPIO-41
GPIO-42	59	60	GPIO-43
GPIO-44	61	62	GPIO-45
GPIO-46	63	64	GPIO-47
	65	66	
GPIO-48	67	68	GPIO-49
GPIO-50	69	70	GPIO-51
GPIO-52	71	72	GPIO-53
GPIO-54	73	74	GPIO-55
GPIO-56	75	76	GPIO-57
GPIO-58	77	78	GPIO-59
GPIO-60	79	80	GPIO-61
GPIO-62	81	82	GPIO-63
GPIO-64	83	84	GPIO-65
GPIO-66	85	86	GPIO-67
GPIO-68	87	88	GPIO-69
GND	89	90	GND
GND	91	92	GND
VCC3V3	93	94	VCC3V3
VCC3V3	95	96	VCC3V3

HEADER 48 X 2

P5

FTDI-BC0	1	191	2	FTDI-BC1	
VCC3V3	3	189	190	4	GND
FTDI-BC2	5	187	188	6	FTDI-BC3
GPIO-139	7	185	186	8	GPIO-138
FTDI-BC4	9	183	184	10	FTDI-BC5
GPIO-137	11	181	182	12	GPIO-136
FTDI-BC6	13	179	180	14	FTDI-BC7
GPIO-135	15	177	178	16	GPIO-134
GPIO-133	17	175	176	18	GPIO-132
GPIO-131	19	173	174	20	GPIO-130
GPIO-129	21	171	172	22	GPIO-128
GPIO-127	23	169	170	24	GPIO-126
GPIO-125	25	167	168	26	GPIO-124
GPIO-123	27	165	166	28	GPIO-122
GPIO-121	29	163	164	30	GPIO-120
GPIO-119	31	161	162	32	GPIO-118
GPIO-117	33	159	160	34	GPIO-116
GPIO-115	35	157	158	36	GPIO-114
GPIO-113	37	155	156	38	GPIO-112
GPIO-111	39	153	154	40	GPIO-110
GPIO-109	41	151	152	42	GPIO-108
GPIO-107	43	149	150	44	GPIO-106
GND	45	147	148	46	GND
GND	47	145	146	48	GND
GND	49	143	144	50	GND
GND	51	141	142	52	GND
GPIO-105	53	139	140	54	GPIO-104
GPIO-103	55	137	138	56	GPIO-102
GPIO-101	57	135	136	58	GPIO-100
GPIO-99	59	133	134	60	GPIO-98
GPIO-97	61	131	132	62	GPIO-96
GPIO-95	63	129	130	64	GPIO-94
GPIO-93	65	127	128	66	GPIO-92
GPIO-91	67	125	126	68	GPIO-90
GPIO-89	69	123	124	70	GPIO-88
GPIO-87	71	121	122	72	GPIO-86
GPIO-85	73	119	120	74	GPIO-84
GPIO-83	75	117	118	76	GPIO-82
GPIO-81	77	115	116	78	GPIO-80
GPIO-79	79	113	114	80	GPIO-78
GPIO-77	81	111	112	82	GPIO-76
GPIO-75	83	109	110	84	GPIO-74
GPIO-73	85	107	108	86	GPIO-72
GPIO-71	87	105	106	88	GPIO-70
INIT B	89	103	104	90	VCC3V3
PROGRAM B	91	101	102	92	VCC3V3
GND	93	99	100	94	GND
GND	95	97	98	96	GND

HEADER 48 X 2



Title: NESO		Revision: V2		Numato Systems Pvt Ltd	Cannot open file D:\NumatoS chTemplate\ numatologo
Size: A4	Project: Neso.PjPcb				
Date: 12/14/2017	Time: 15:47 AM	Sheet 7 of 9			
File: GPIO.SchDoc					

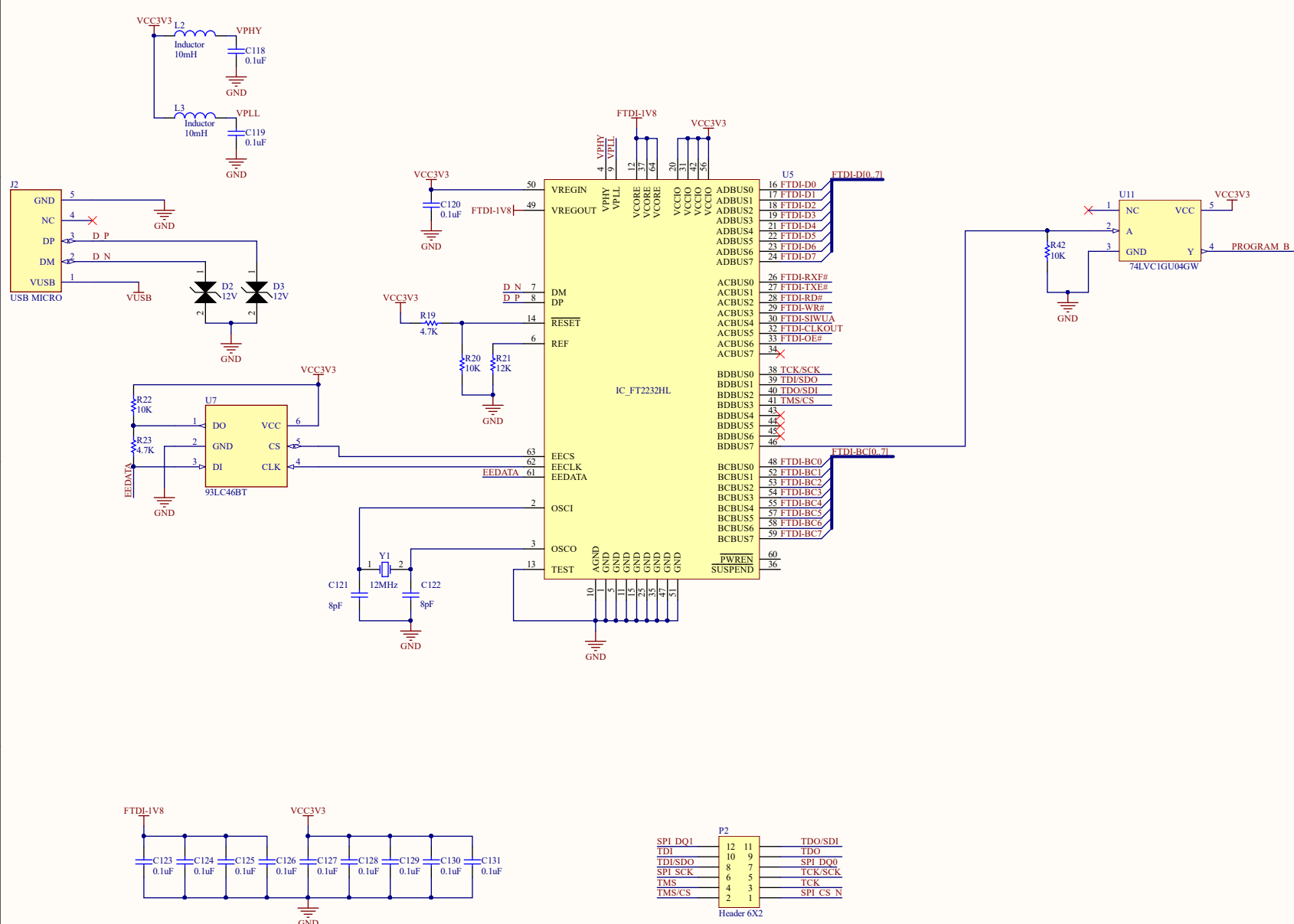

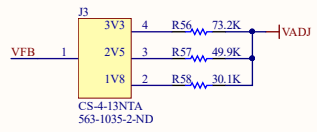
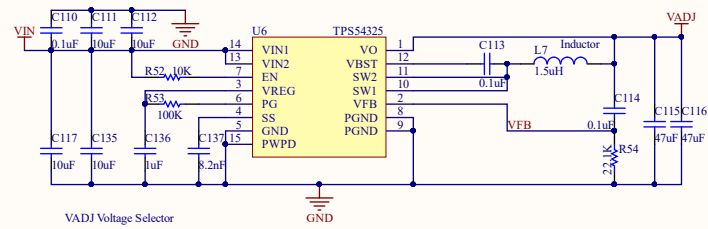
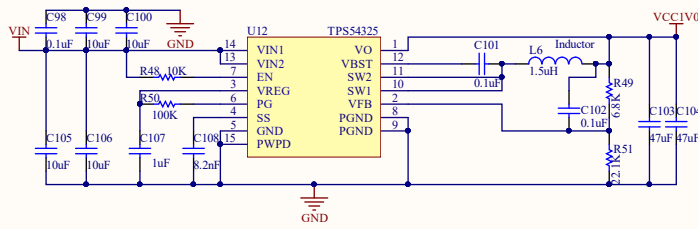
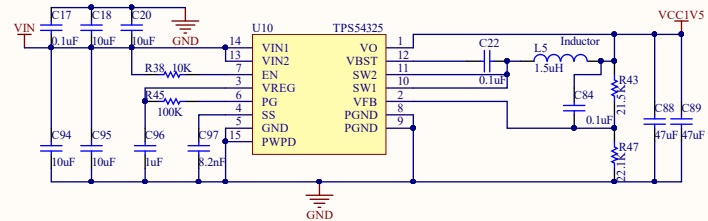
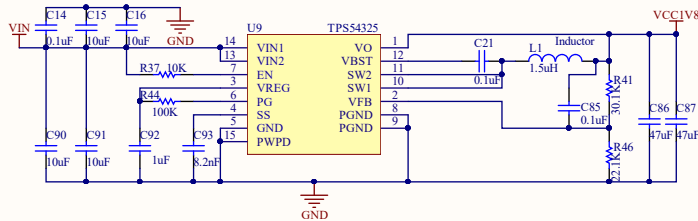
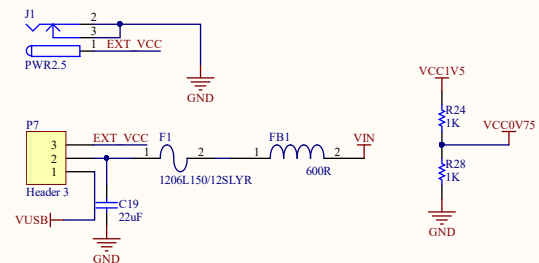
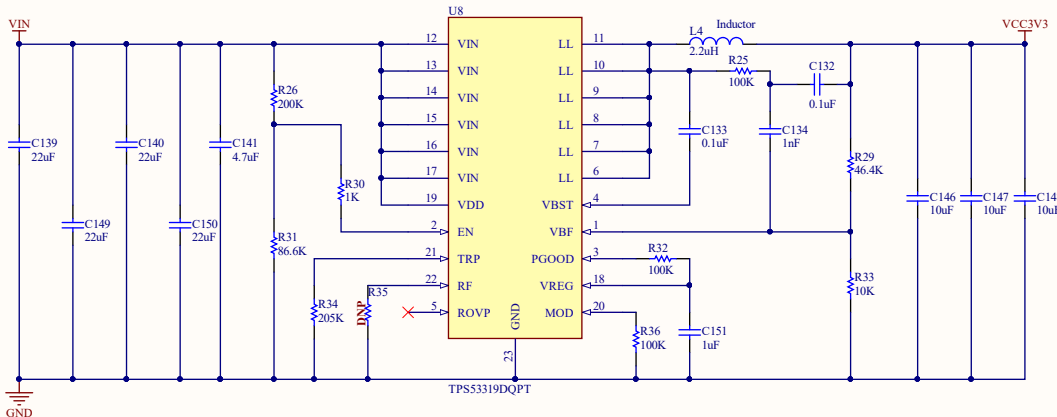

Title: NESO	Revision: V2	Numato Systems Pvt Ltd
Size: A3	Project: Neso.PjgPcb	
Date: 12/14/2017	Time: 15:47 AM	
File: PowerSupply.SchDoc	Sheet 9 of 9	

