

IOT.ZPSET1812 kit

Installer's Manual

Document
link



DECLARATION OF CONFORMITY		
Products: IOT.ZPSET1812.1 kit (light grey), IOT.ZPSET1812.2 kit (light grey w/clear cover)	Manufacturer: Kradex Krzysztof Radzikowski ul. Naddnieprzańska 32 04-205 Warszawa (Warsaw), POLAND tel. (+48 22) 613-08-88 fax. (+48 22) 812-10-68	
Product overview: Kit with a hermetic enclosure and accessories for easy installation of PCBs and IOT devices		
We hereby declare that the specified products conform with the EU Directives: 94/62/EC RoHS REACH		
Warsaw, Poland, 30.03.2021	Owner Krzysztof Radzikowski	
The latest RoHS and REACH Declarations of Conformity and CE Certificates can be downloaded online from www.kradex.com.pl		

Kradex shall not be liable for any devices assembled with the IOT.ZPSET1510 kit, as each user of the devices is solely liable for the devices installed in the kit.

Introduction

The IOT.ZPSET1510 kit and its accessories are designed for quick and easy prototyping of IOT systems, SBCs, sensors of all types, and actuator systems. The systems built with the kit are easily serviceable and modifiable with the removable baseplate, which can be replaced without removal of the kit's enclosure from the wall or post it is attached to. The main component of the kit is the hermetic enclosure made from polycarbonate (PC), part No. ZP150.100.60SU, complete with fastening lugs and a cast-in-place seal which provides a good weather seal and mechanical protection. The cable glands included with the kit and their installation holes milled in the enclosure reduce the number of assembly operations by the user, making it quicker along with the installation of the complete device unit.

Kit components

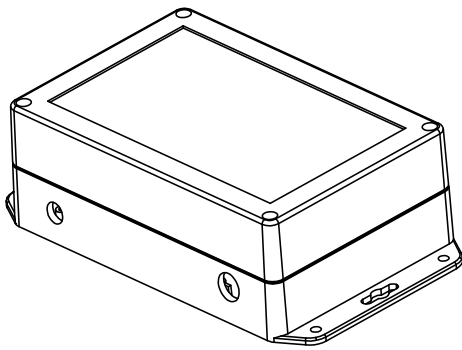

1x Enclosure, P/N ZP180.120.60SU, with pre-milled cable gland holes

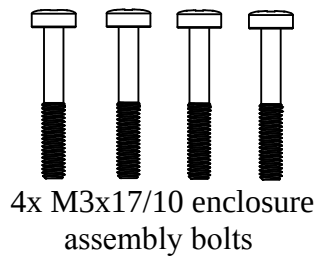

4x M3x17/10 enclosure assembly bolts

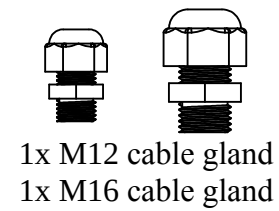

1x M12 cable gland
1x M16 cable gland

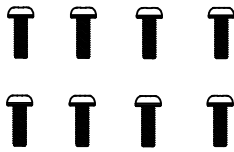

8x M2.5x6 PCB installation bolts

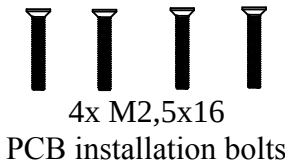

4x M2,5x16 PCB installation bolts

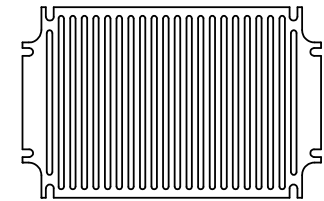

Baseplate
P/N ZMB180.120 IOT m1

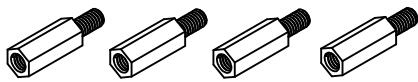

4x M2.5x10 PCB installation stand-off hex screws



4x PCB installation plastic spacers

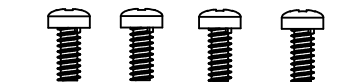

4x ø3.5/7 PCB installation plastic screws

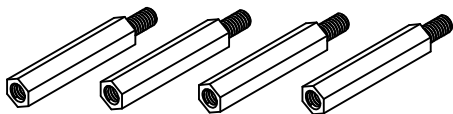

4x M2.5x20 PCB installation stand-off hex screws

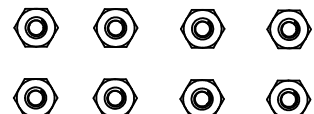

8x M2.5 PCB installation nuts

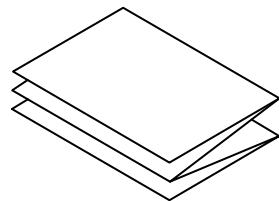

1x Installation template

Options and accessories



[Baseplate P/N ZMB180.120](#)

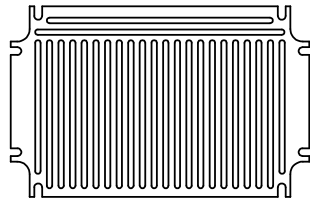

[Baseplate, P/N ZMB180.120 IOT m2](#)

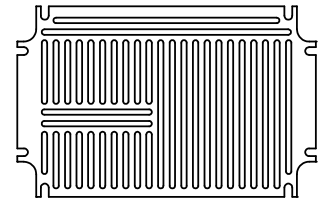

[Baseplate, P/N ZMB180.120 IOT m3](#)

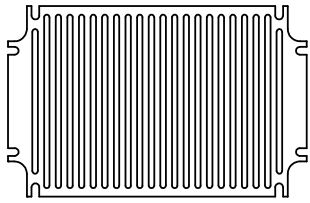

[Baseplate, P/N ZMB180.120 IOT p1](#)

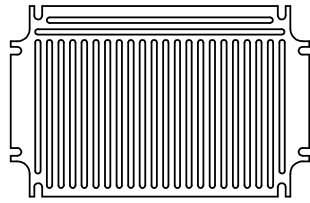

[Baseplate, P/N ZMB180.120 IOT p2](#)

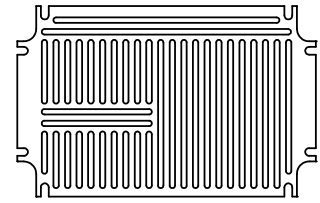

[Baseplate, P/N ZMB180.120 IOT p3](#)

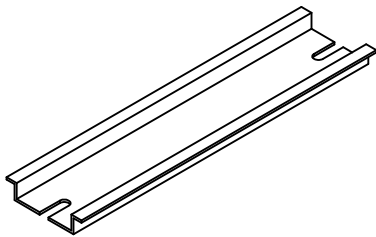

[Din mounting rail TZ35.146A](#)

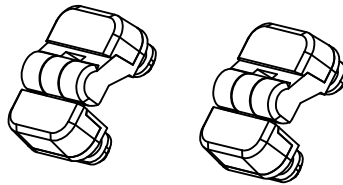

[Hinges, P/N ZHINGE20](#)

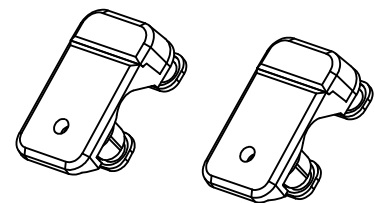

[Latch, P/N ZLATCH20](#)

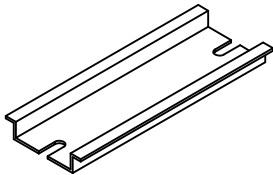

[Din mounting rail TZ35.93A](#)



[M12 cable gland](#)

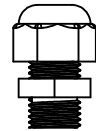

[M16 cable gland](#)

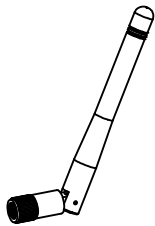

[SMA extension antenna cable, P/N Extra set of bolts and screws, P/N Z ACCS IOT SET1 U.FL IPX, with antenna](#)



[Extra set of bolts and screws, P/N Z ACCS IOT SET1](#)

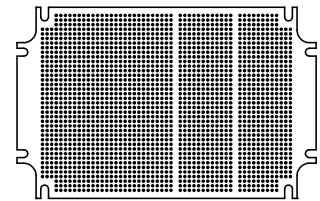

[Universal PCB, P/N ZP.180.120 PCB A](#)

Opis techniczny

Height	60.1 mm
Width	121.5 mm
Length	179.9 mm
Colour	Light grey (IOT.ZPSET1812.1), Light grey with clear cover (IOT.ZPSET1812.2)
Material	PC (polycarbonate)
Seal	Cast-in-place Fermapor K-31
Warranty	12 months, see the Terms & Conditions on www.kradex.com.pl
Technical drawings	Files to download

Example of application

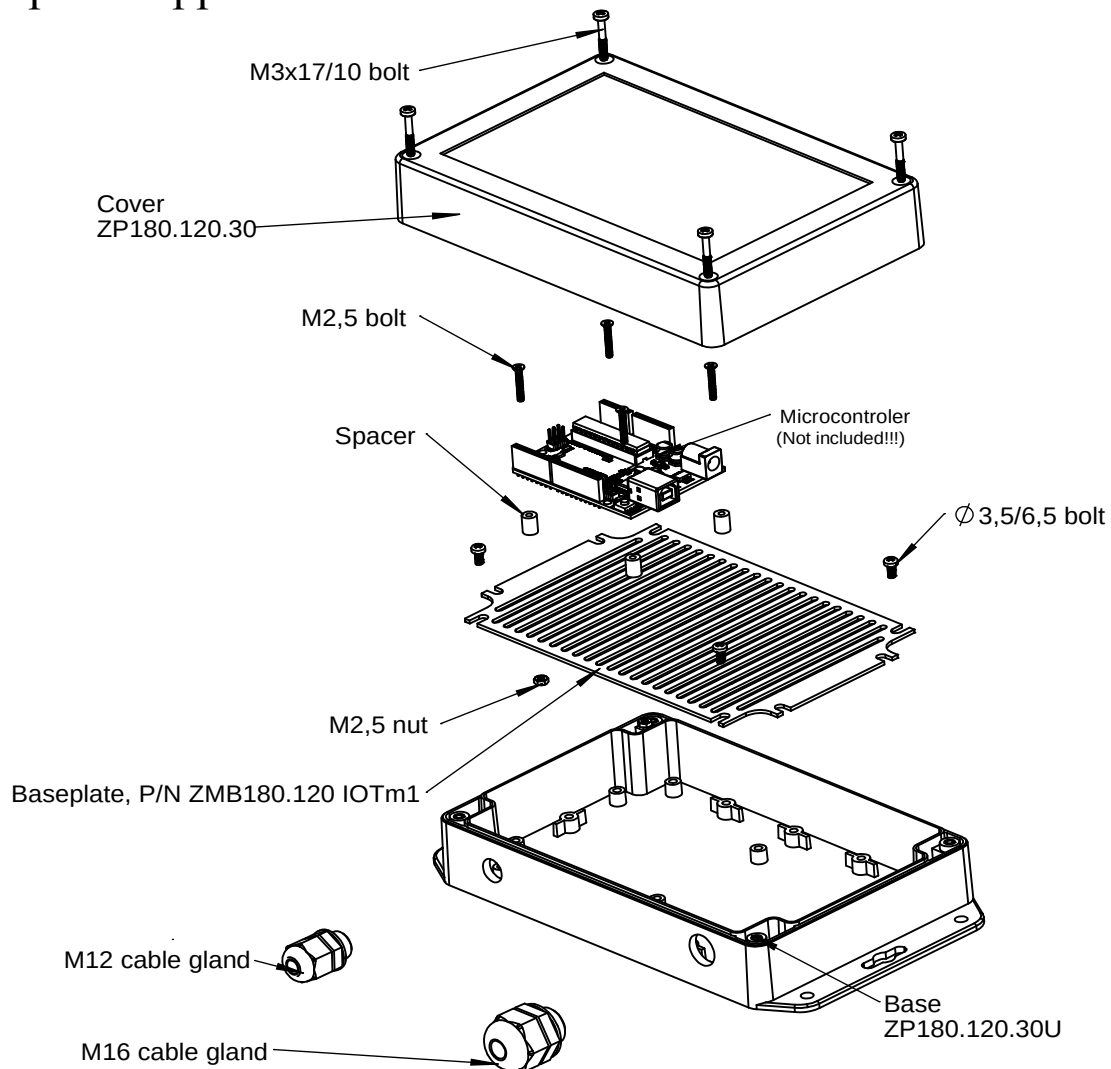

Installer's guidelines / recommendations

- Keep the temperature of the electronic components installed with the kit below 70°C in continuous duty.
- Use a passive cooling system for unattended operation.
- Do not use the clear cover for outdoor installation; if exposed to strong sunlight, the electronic components will quickly reach a high temperature which reduces their operating life and may cause failure of the components.
- If installed outdoor, the enclosure should be kept away from sunlight, e.g. with a canopy.
- Having installed the enclosure, perform full-stress thermal tests in the most adverse operating conditions, e.g. sunny weather and an ambient temperature of 35°C.

Examples of reference operating temperatures in popular SBCs

Each of the tested SBCs was exposed to the following ambient conditions:

- SBC on a bench, without the enclosure, ambient temperature 25°C.
- Indoor location, hermetically contained in the IOT.ZPSET1510.1 kit (with the cable glands installed), ambient temperature 25°C.
- Outdoor location, away from sunlight, hermetically contained in the IOT.ZPSET1510.1 kit (with the cable glands installed), ambient temperature 35°C.

Test specimens:

- Odroid C1 (stock configuration with OEM heat sink)
- Odroid C1 with a [Sunon EE40100S2-1000U-999](#) 40x40 5V fan installed on the CPU heat sink
- Odroid C2 (stock configuration with OEM heat sink)
- Odroid C2 with a [Sunon EE40100S2-1000U-999](#) 40x40 5V fan installed on the CPU heat sink
- Odroid C4 (stock configuration with OEM heat sink)
- Odroid C4 with a [Sunon EE40100S2-1000U-999](#) 40x40 5V fan installed on the CPU heat sink
- Odroid XU4 (stock configuration with OEM heat sink and a fan)
- Raspberry Pi3 (stock configuration without a heat sink)
- Raspberry Pi3 with a [set of Raspberry Pi dedicated heat sinks and a thermal compound in strip](#)
- Raspberry Pi3 with a [set of Raspberry Pi dedicated heat sinks and a thermal compound in strip](#) and a [Sunon EE40100S2-1000U-999](#) 40x40 5V fan installed in the cover on spacers over the CPU
- Raspberry Pi4 (stock configuration without a heat sink)
- Raspberry Pi4 with a [set of Raspberry Pi dedicated heat sinks and a thermal compound in strip](#)
- Raspberry Pi4 with a [double-sided, two-fan heat sink](#)

Each SBC was tested with a default operating system distribution, disabled Xorg, and (this applies to Raspberry SBCs) the CPU in performance mode.

Each test began by turning on the specimen. The test measurement results were read as output by the operating system.

Each test was completed in the following stages:

- A minimum of 1-hour CPU run without load to allow preheating and reaching an initial steady state temperature
- A minimum of 0.5-hour CPU run with 100% load on 2 cores
- A minimum of 0.5-hour CPU run with 100% load on 3 cores
- A minimum of 0.5-hour CPU run with 100% load on 4 (all) cores
- A minimum of 1-hour CPU run without load to allow cooldown and reaching a steady state temperature equal to the initial value

Note: The Raspberry Pi do not provide a correct output of the clock frequency (the cpufreq driver is incomplete) and throttle automatically and independently from the operating system when the CPU reaches approx. 80°C. If the CPU reaches 80°C, its performance is significantly reduced (the performance of the Rpi3 during the outdoor test was reduced over 2 times from the room temperature performance level).

Note: The test results are provided for reference only. The user is recommended to test the SBC with additional actuation components once installed in the final location and at the final CPU load. Kradox shall not be liable for the data specified herein or any effects of the tests performed by the users.

Recommendations for outdoor SBC applications

SBC / outdoor conditions	W/o enclosure	IOT.ZPSET1812 kit	
		Indoor	Outdoor
Odroid C1 (stock configuration with OEM heat sink)	✓	✓	✗
Odroid C1 with extra fan	✓	✓	✓
Odroid C2 (stock configuration with OEM heat sink)	✓	✗	✗
Odroid C2 with extra fan	✓	✓	✓
Odroid C4 (stock configuration with OEM heat sink)	✓	✓	✗
Odroid C4 with extra fan	✓	✓	✓
Odroid XU4 (stock configuration with OEM heat sink and a fan)	✓	✗	✗
Arduino Uno/Mega	✓	✓	✓
Raspberry Pi0 (stock configuration without a heat sink)	✓	✓	✓
Raspberry Pi3 (stock configuration without a heat sink)	✗	✗	✗
Raspberry Pi3 with extra heat sink	✓	✗	✗
Raspberry Pi3 with extra heat sink and fan	-	✓	✓
Raspberry Pi4 (stock configuration without a heat sink)	✗	✗	✗
Raspberry Pi4 with extra heat sink	✗	✗	✗
Raspberry Pi4 with an extra heat sink and 2 fans	✓	✓	✗

If the device is not required to run at high performance, it is recommended to use SBCs with a low frequency clock and passive cooling or to set an aggressive enough temperature throttle down.

Odroid C1 (stock configuration with OEM heat sink)

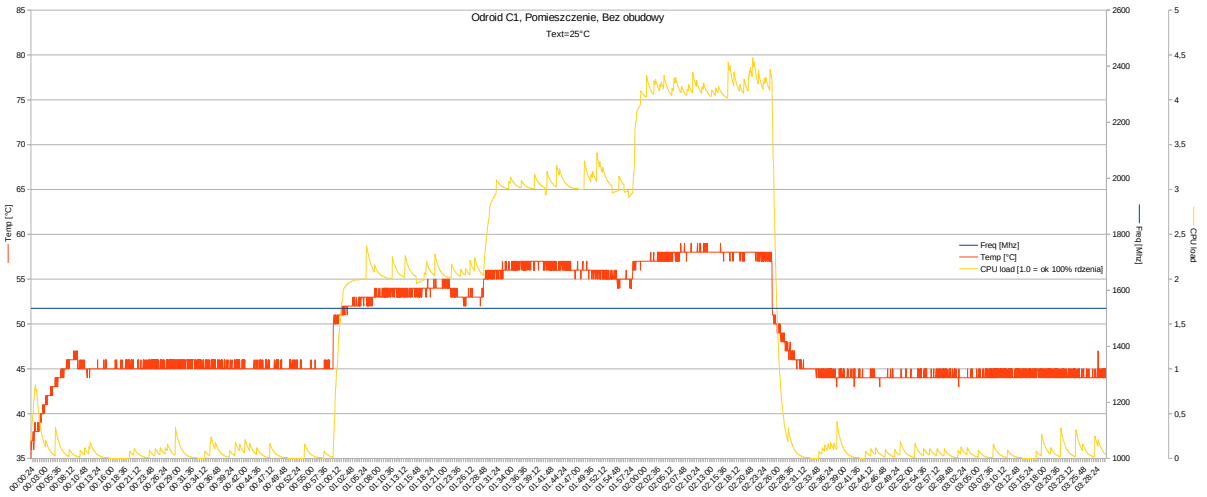

Odroid C1, indoor T=25C, w/o enclosure (bench)

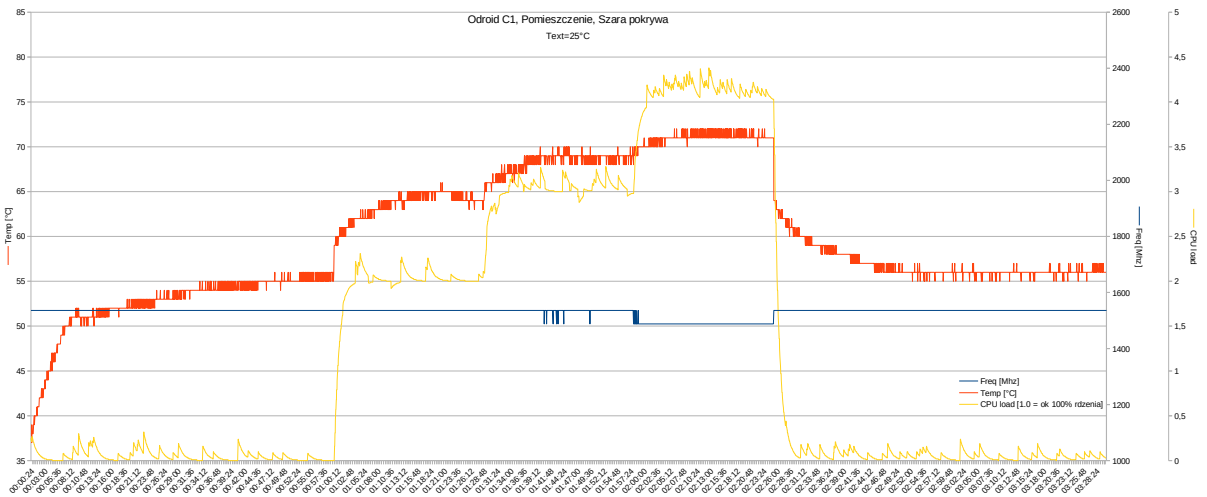

Odroid C1, indoor T=25C, IOT.ZPSET1812.1 kit (light grey)

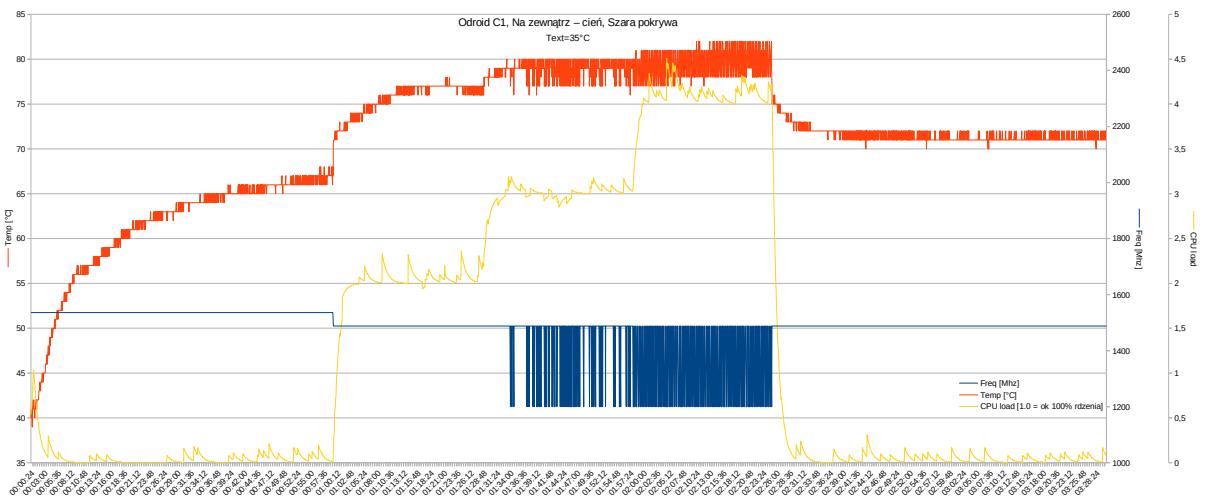

Odroid C1, outdoor, shade T=35C, IOT.ZPSET1812.1 kit (light grey)

Odroid C1 with an extra 40x40 5V fan (Sunon EE40100S2-1000U-999)

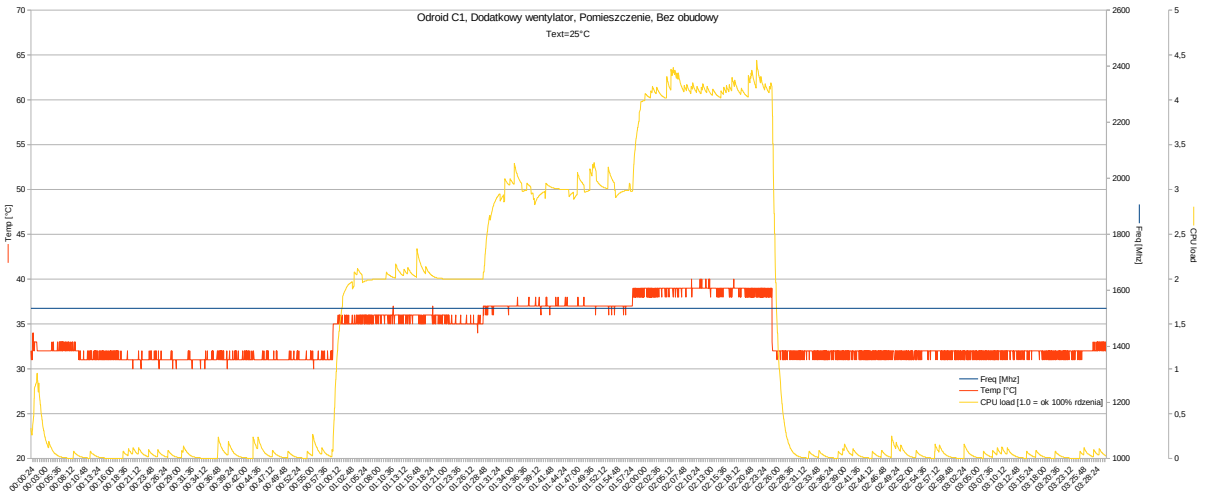

Odroid C1, extra fan, indoor T=25C, w/o enclosure (bench)

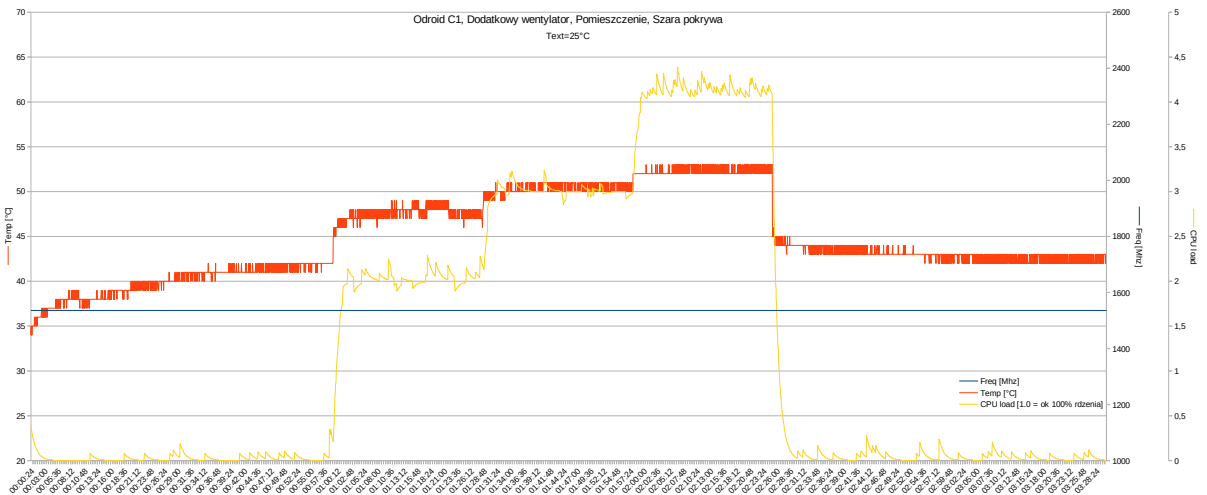

Odroid C1, extra fan, indoor T=25C, IOT.ZPSET1812.1 kit (light grey)

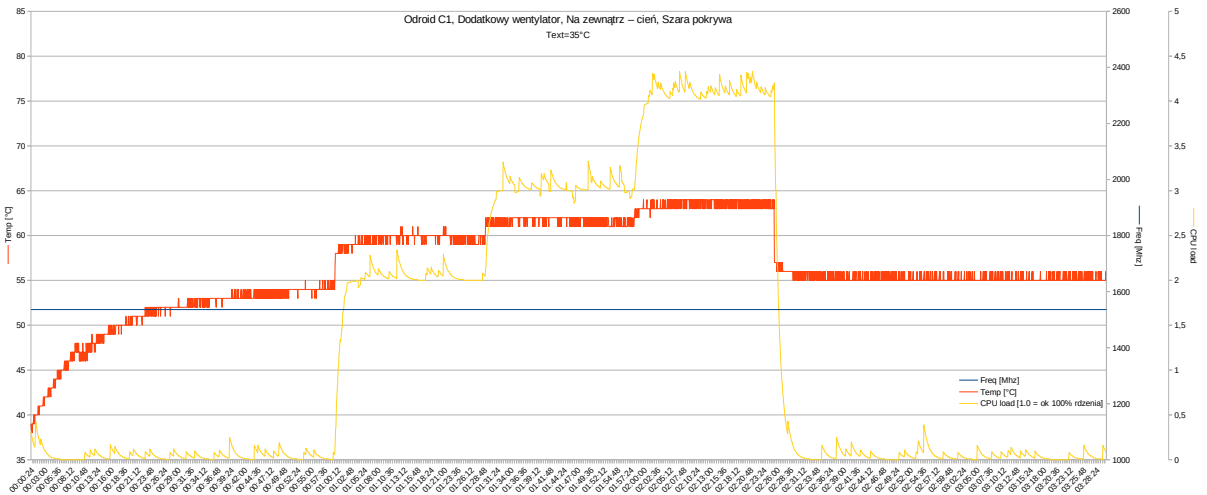

Odroid C1, extra fan, outdoor, shade T=35C, IOT.ZPSET1812.1 kit (light grey)

Odroid C2 (stock configuration with OEM heat sink)

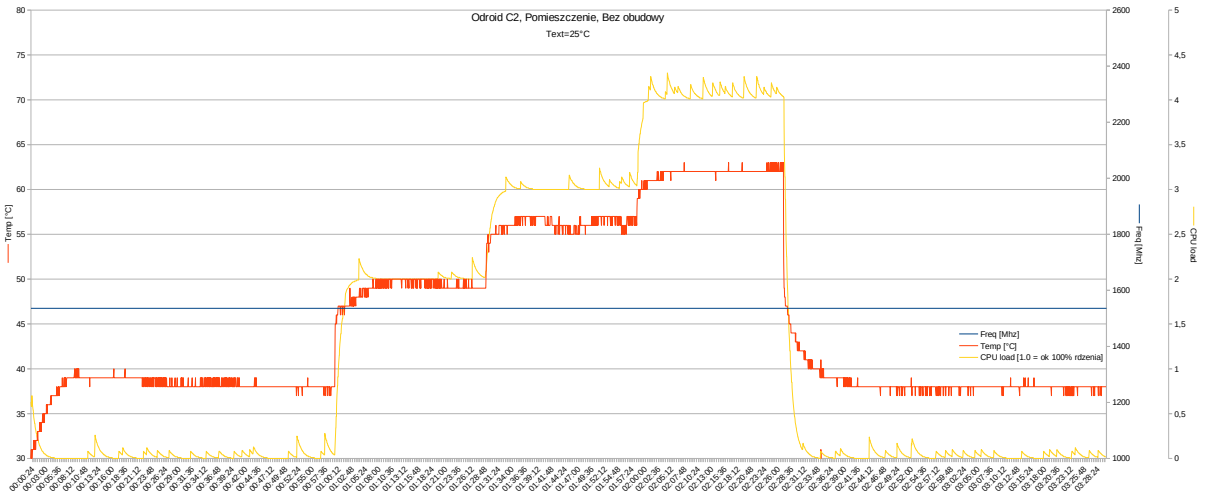

Odroid C2, indoor T=25C, w/o enclosure (bench)

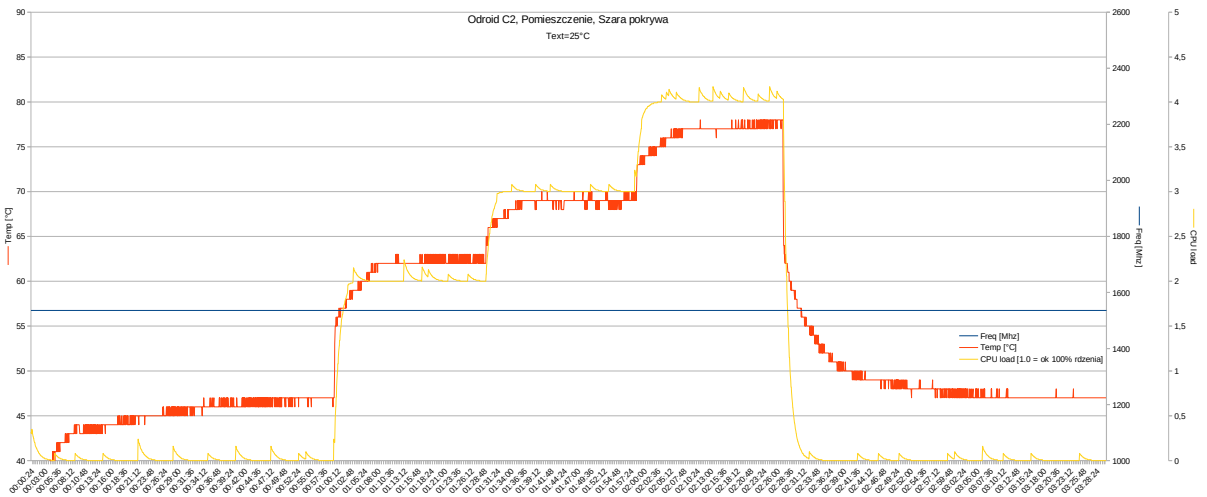

Odroid C2, indoor T=25C, IOT.ZPSET1812.1 kit (light grey)

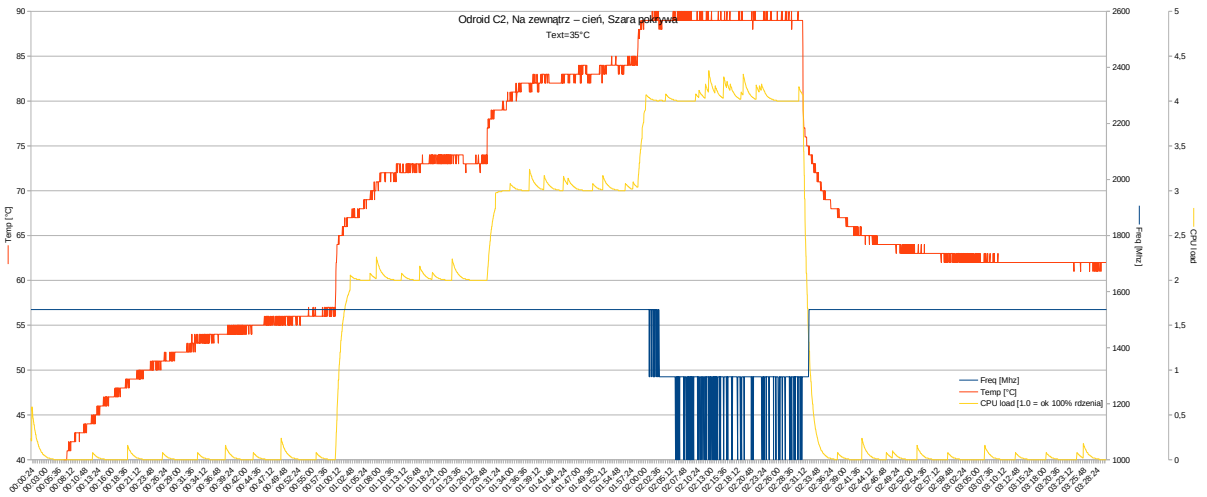

Odroid C2, outdoor, shade T=35C, IOT.ZPSET1812.1 kit (light grey)

Odroid C2 with an extra 40x40 5V fan (Sunon EE40100S2-1000U-999)

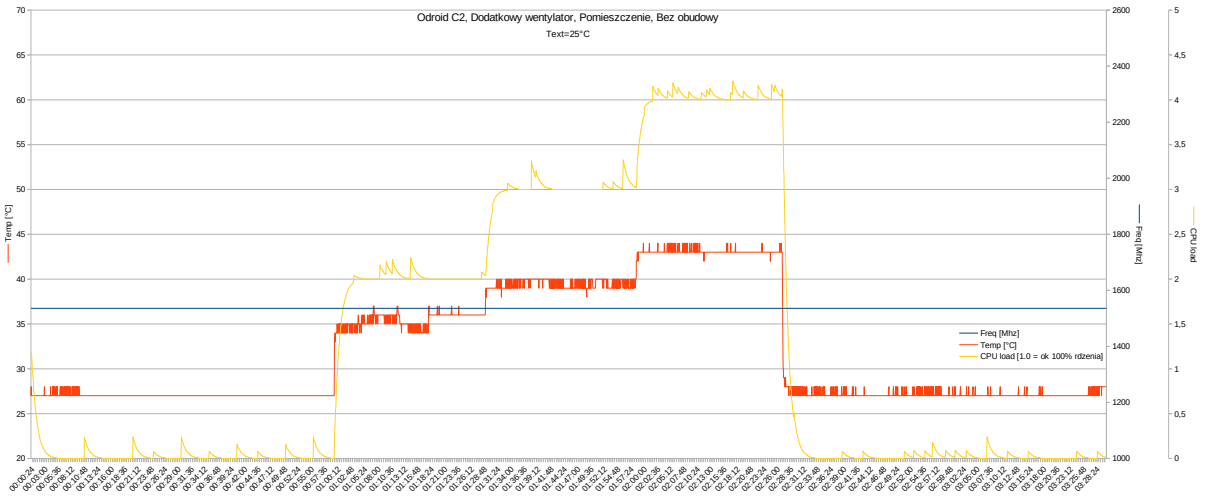

Odroid C2, extra fan, indoor T=25C, w/o enclosure (bench)

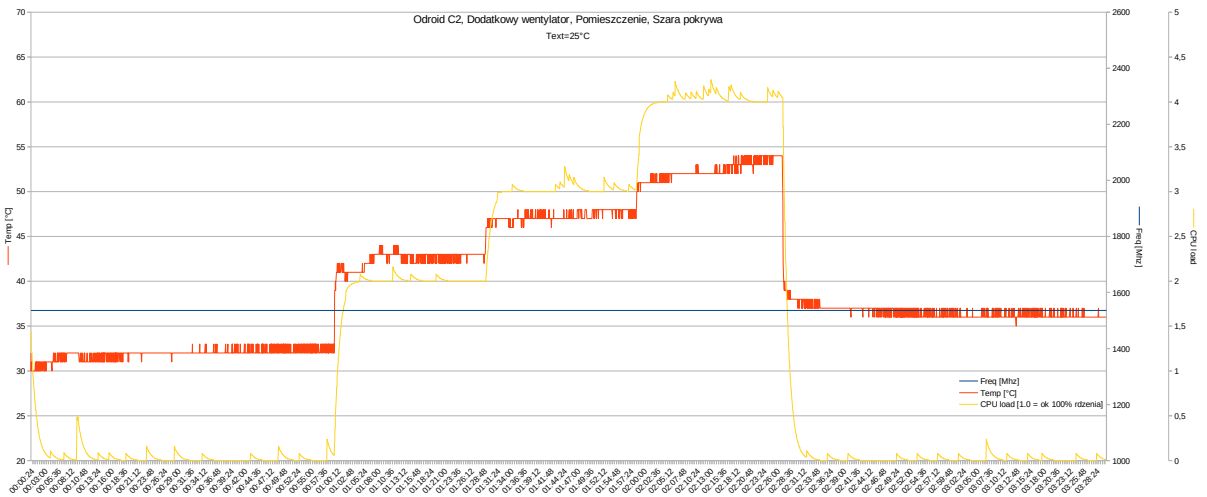

Odroid C2, extra fan, indoor T=25C, IOT.ZPSET1812.1 kit (light grey)

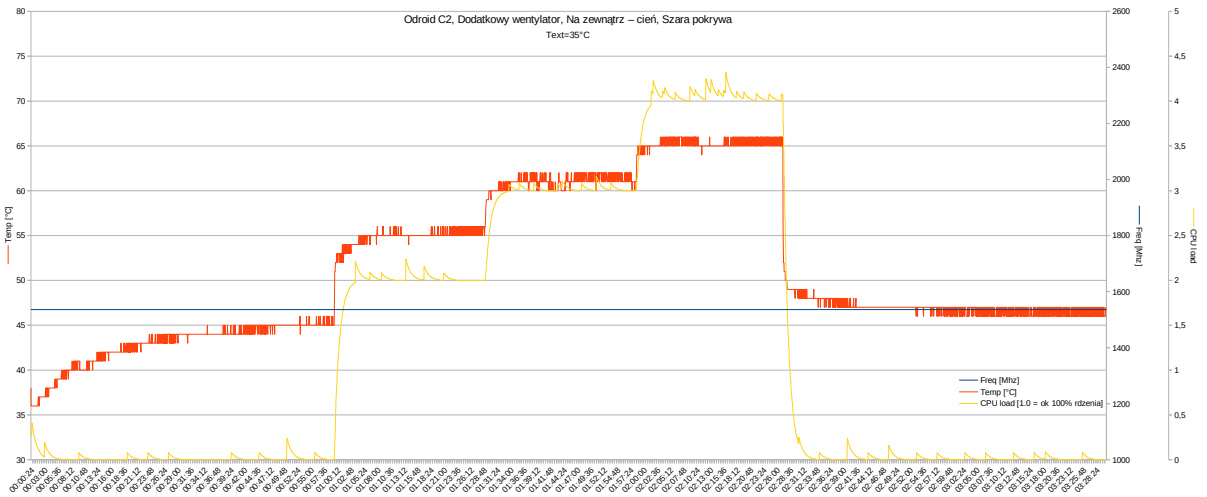

Odroid C2, extra fan, outdoor, shade T=35C, IOT.ZPSET1812.1 kit (light grey)

Odroid C4 (stock configuration with OEM heat sink)

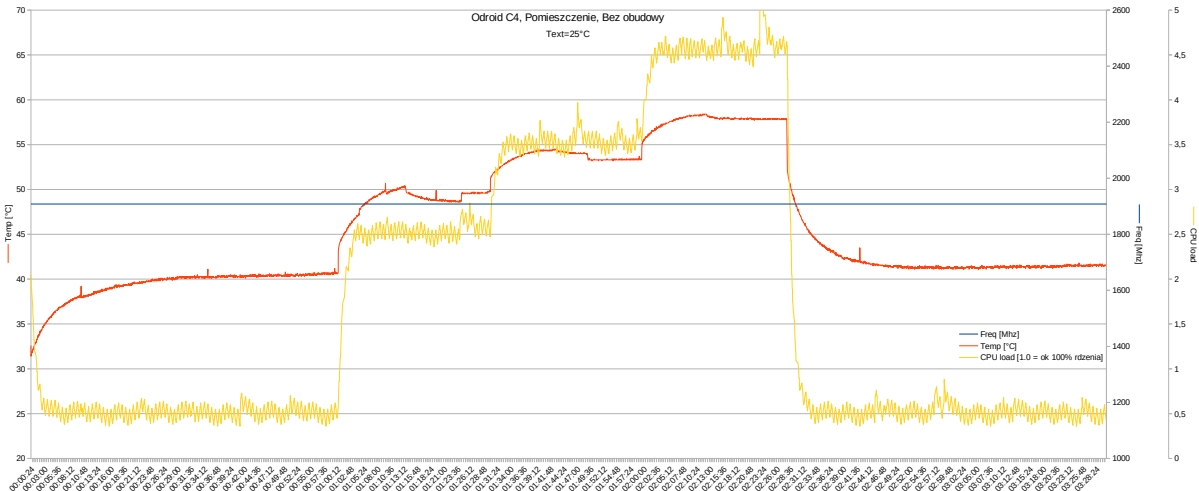

Odroid C4, indoor T=25C, w/o enclosure (bench)

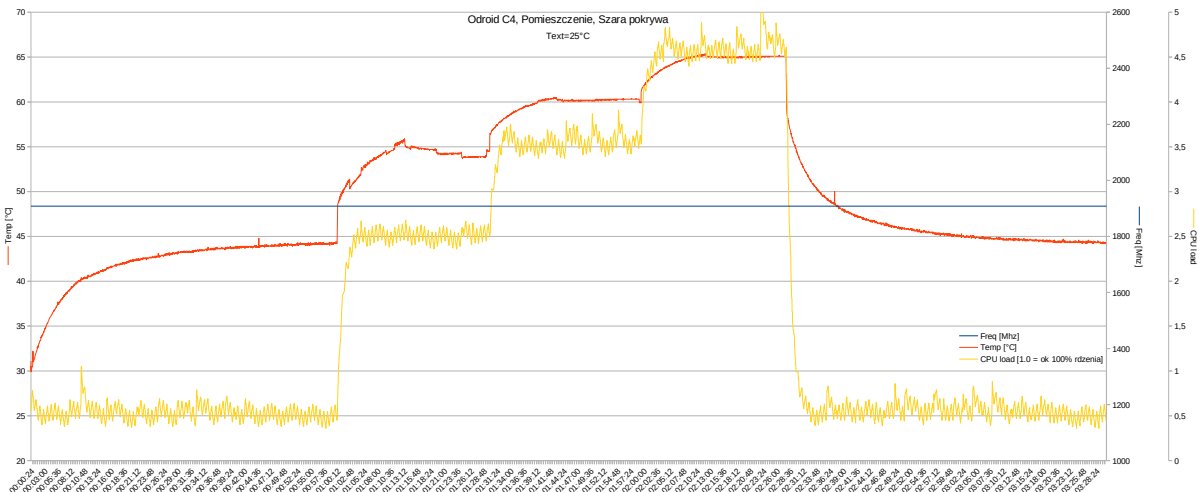

Odroid C4, indoor T=25C, IOT.ZPSET1812.1 kit (light grey)

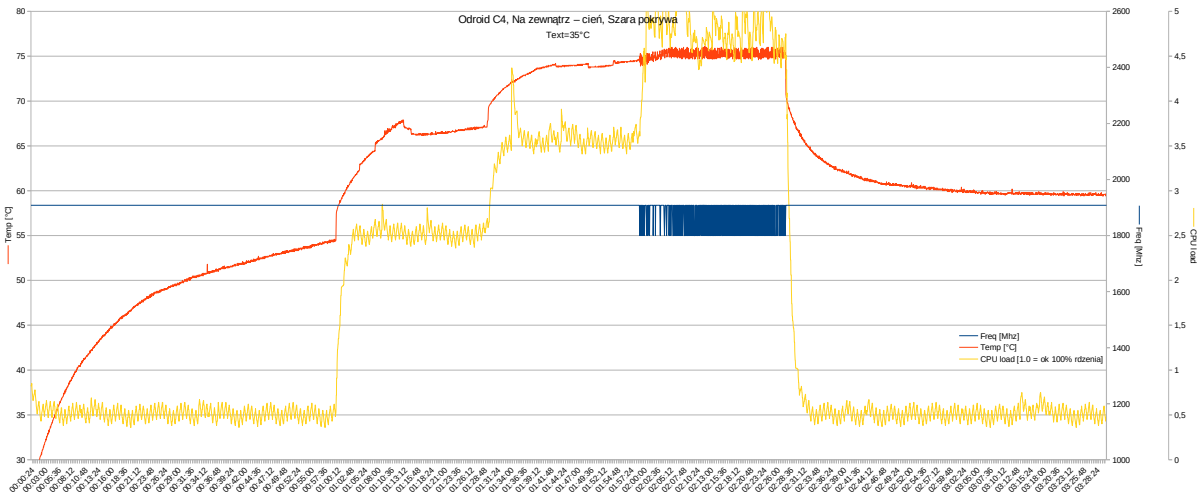

Odroid C4, outdoor, shade T=35C, IOT.ZPSET1812.1 kit (light grey)

Odroid C4 with an extra 40x40 5V fan (Sunon EE40100S2-1000U-999)

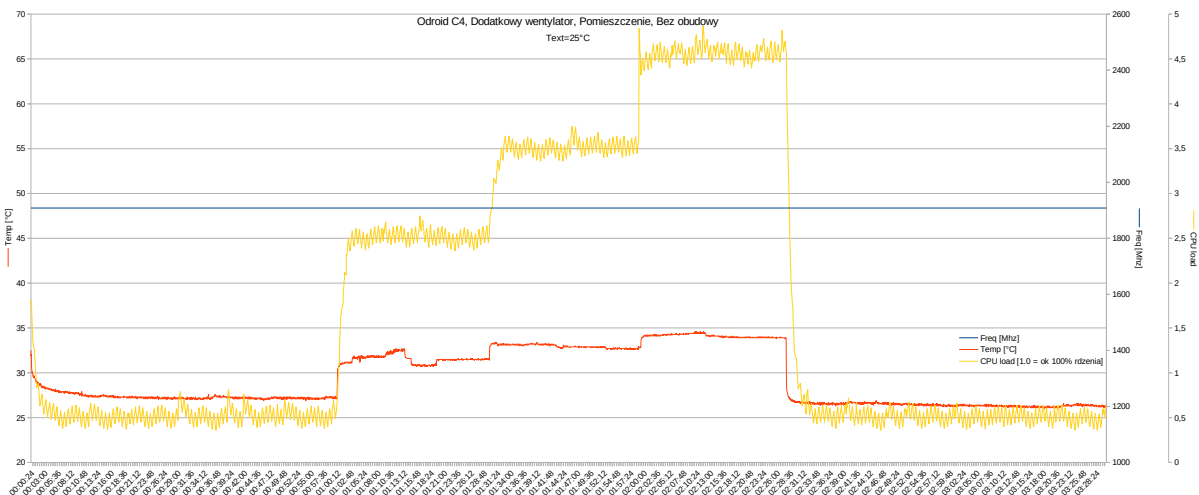

Odroid C4, extra fan, indoor T=25C, w/o enclosure (bench)

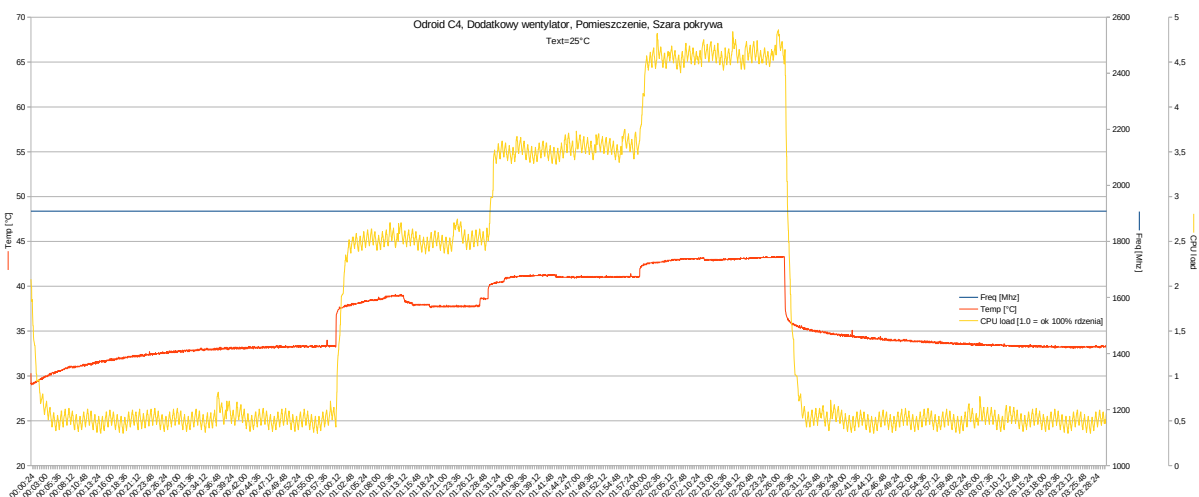

Odroid C4, extra fan, indoor T=25C, IOT.ZPSET1812.1 kit (light grey)

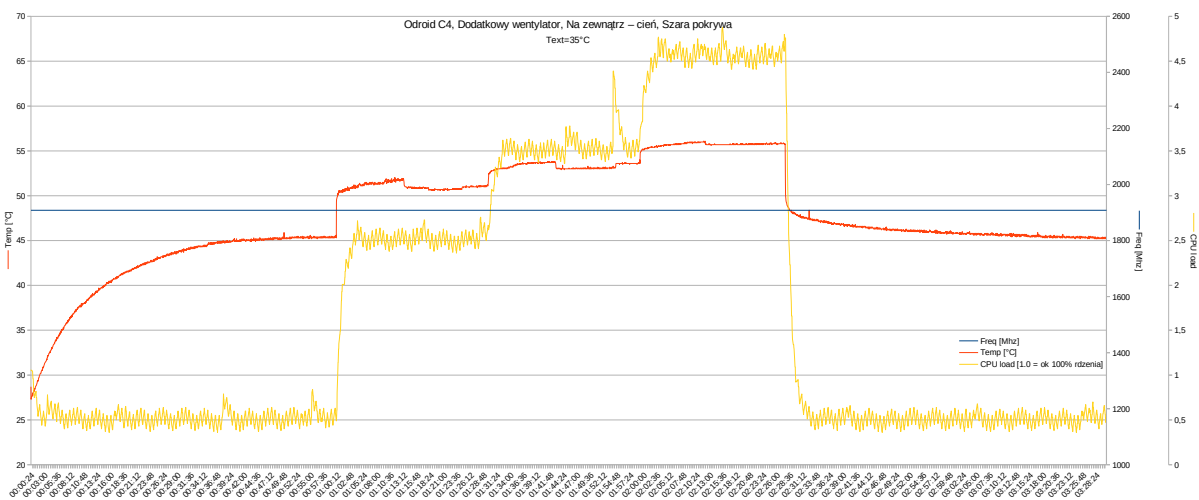

Odroid C4, extra fan, outdoor, shade T=35C, IOT.ZPSET1812.1 kit (light grey)

Odroid XU4 (stock configuration with OEM heat sink and a fan)

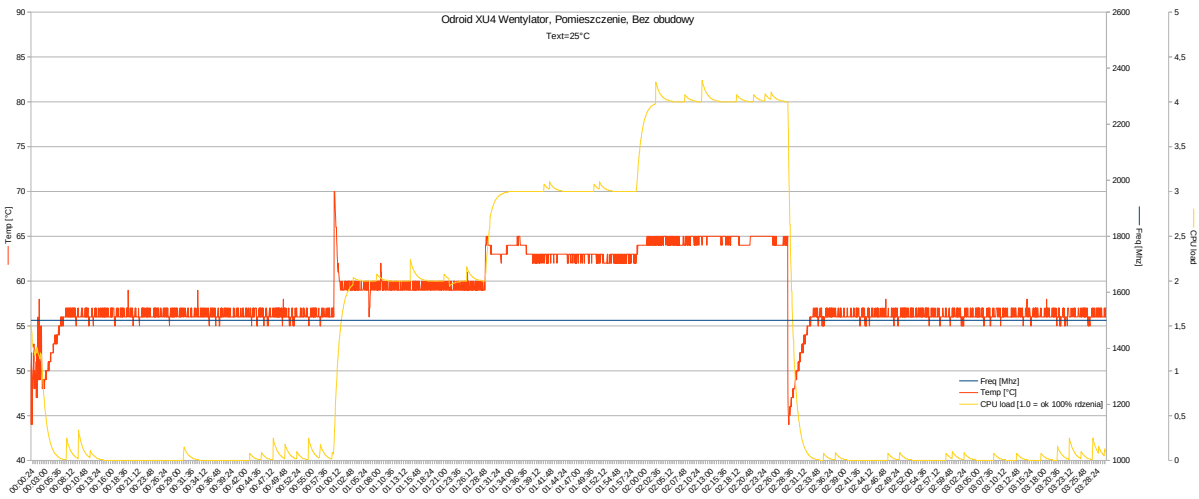

Odroid XU4, indoor T=25C, w/o enclosure (bench)

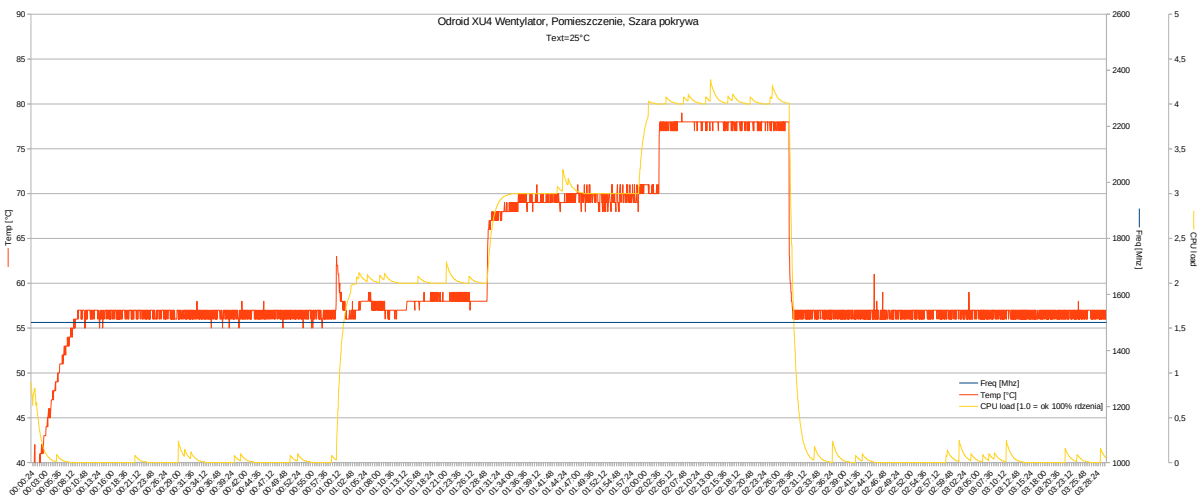

Odroid XU4, indoor T=25C, IOT.ZPSET1812.1 kit (light grey)

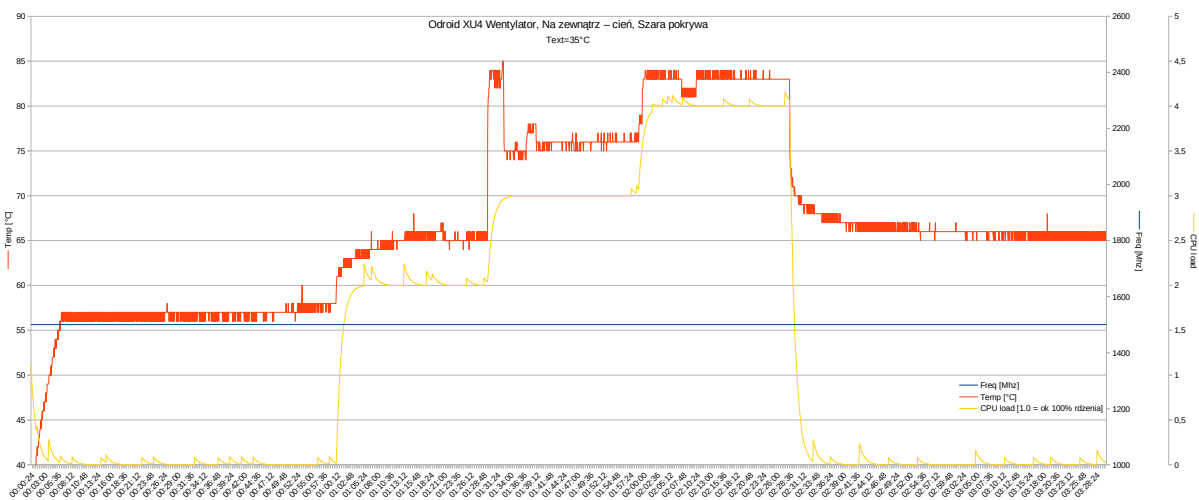

Odroid XU4, outdoor, shade T=35C, IOT.ZPSET1812.1 kit (light grey)

Raspberry Pi0 (stock configuration without a heat sink)

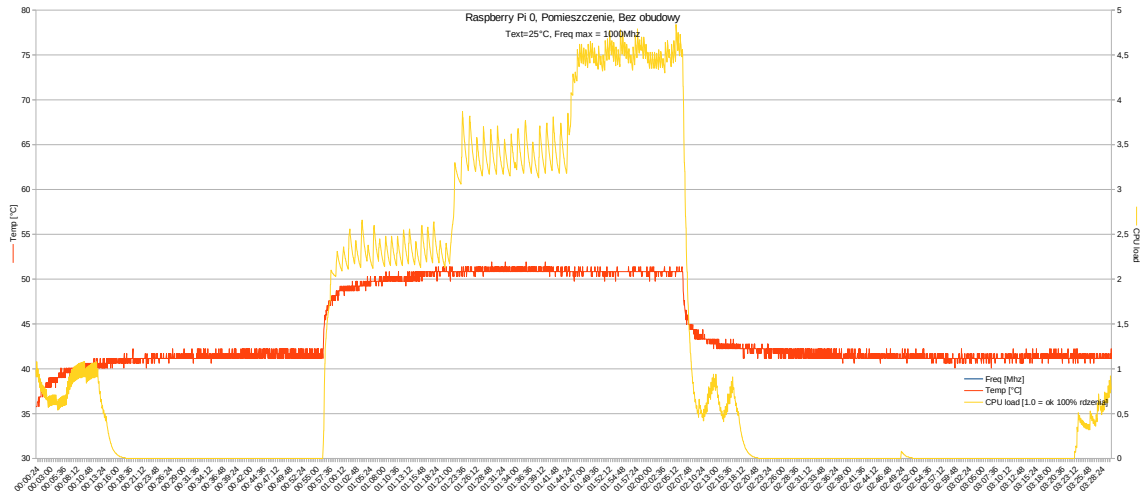

Raspberry Pi0, indoor T=25C, w/o enclosure (bench)

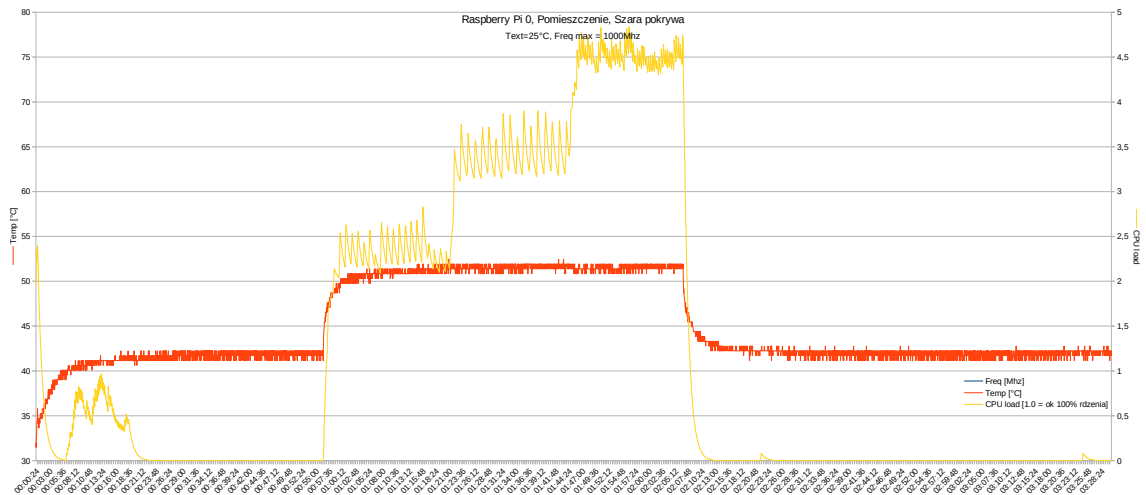

Raspberry Pi0, indoor T=25C, IOT.ZPSET1812.1 kit (light grey)

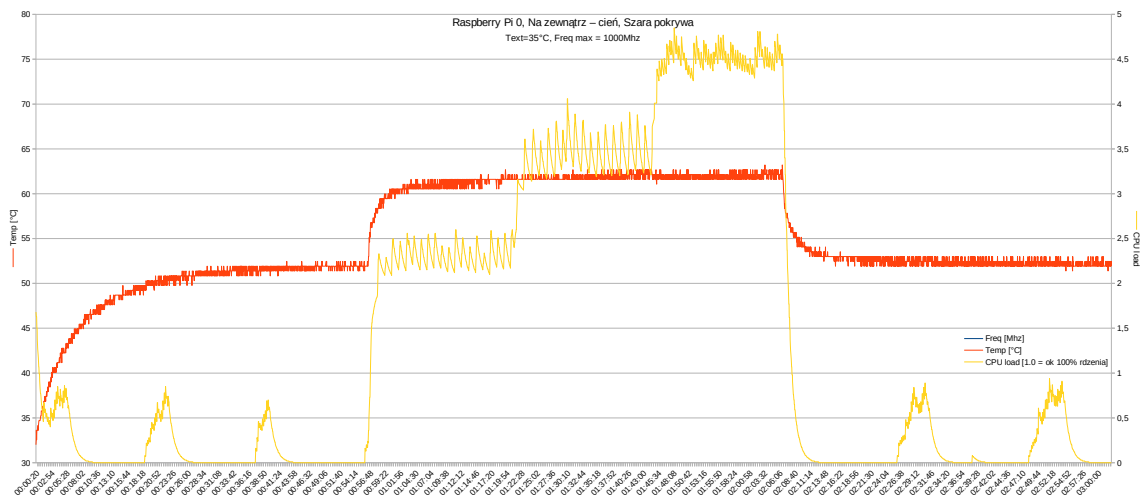

Raspberry Pi0, outdoor, shade T=35C, IOT.ZPSET1812.1 kit (light grey)

Raspberry Pi3 (stock configuration without a heat sink)

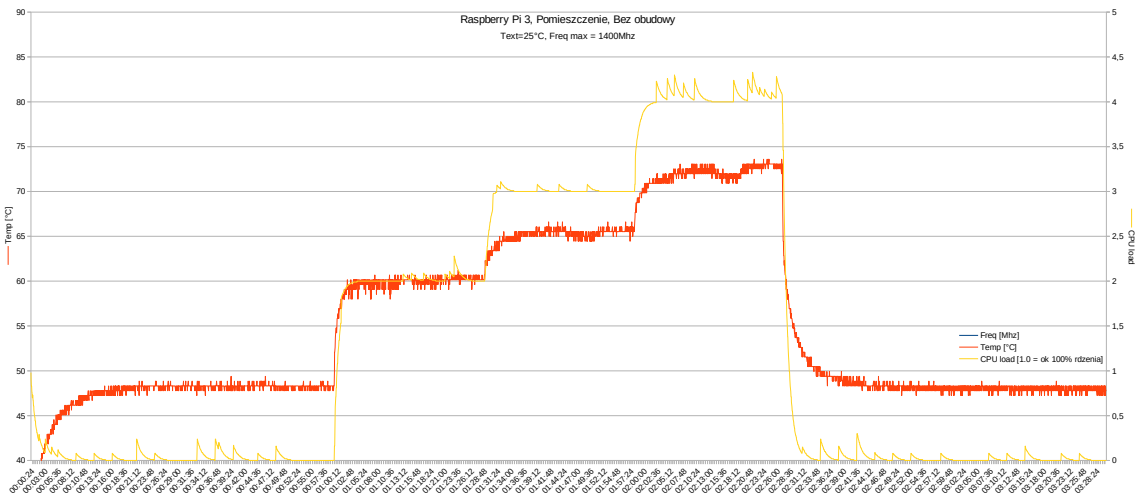

Raspberry Pi3, indoor T=25C, w/o enclosure (bench)

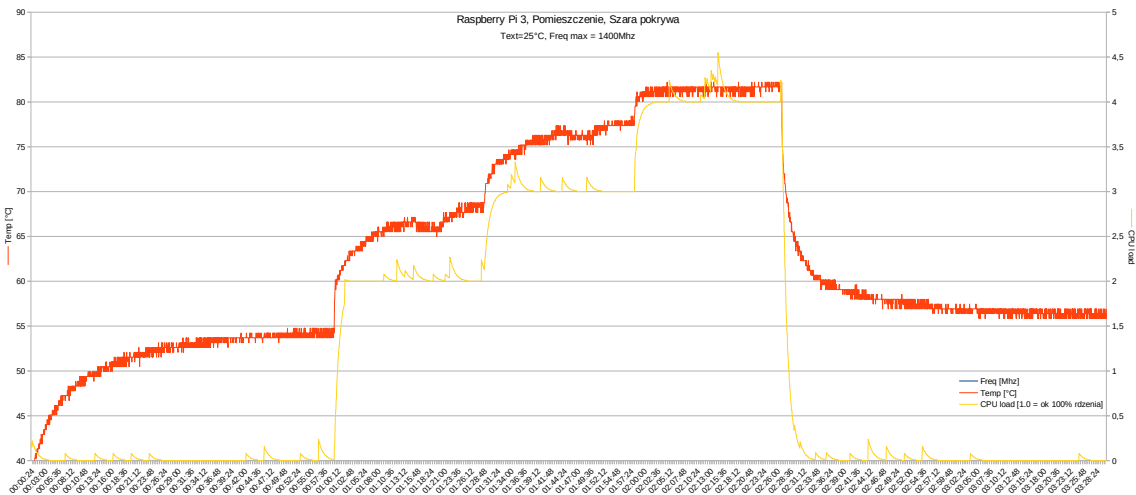

Raspberry Pi3, indoor T=25C, IOT.ZPSET1812.1 kit (light grey)

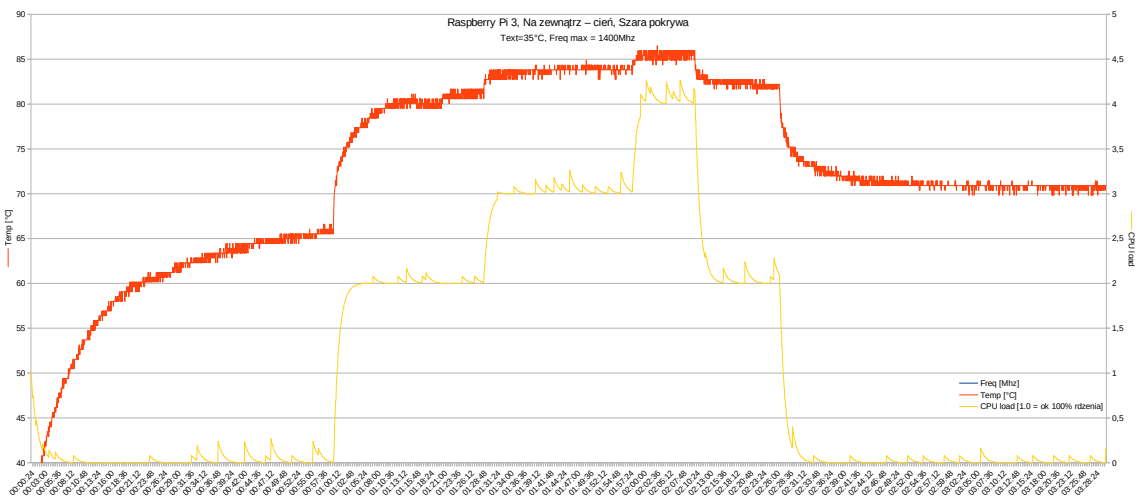

Raspberry Pi3, outdoor, shade T=35C, IOT.ZPSET1812.1 kit (light grey)

Raspberry Pi3 with extra heat sink

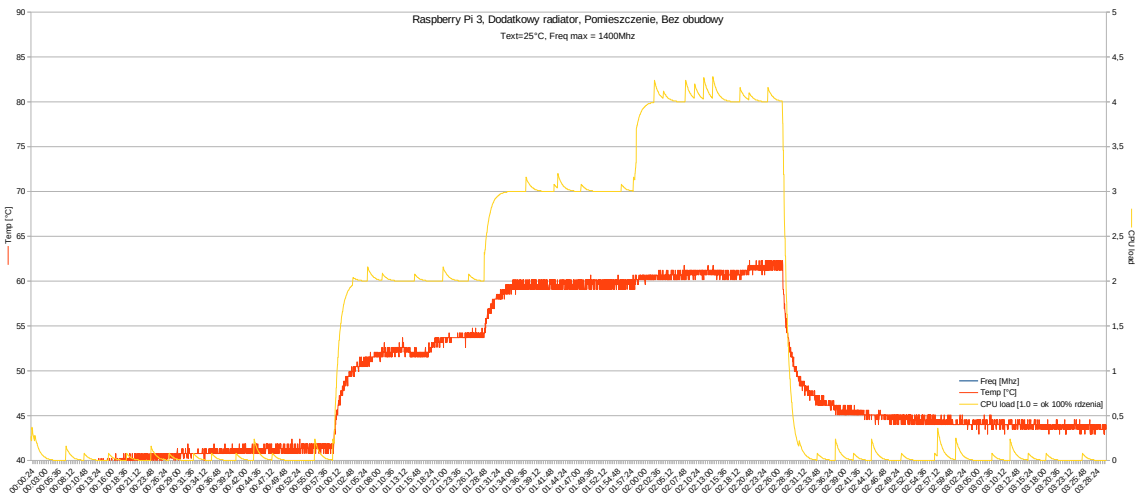

Raspberry Pi3 with extra heat sink, indoor T=25°C, w/o enclosure (bench)

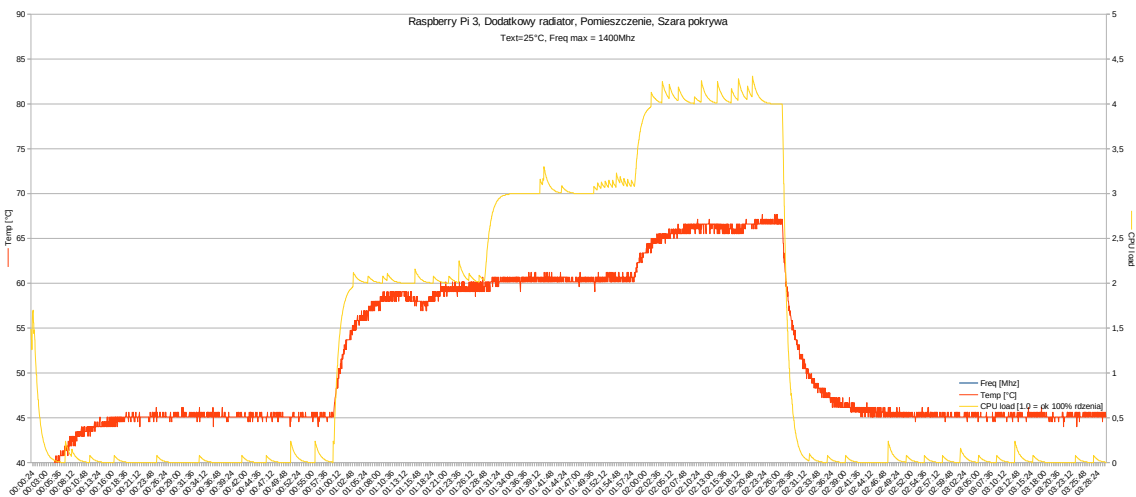

Raspberry Pi3 with extra heat sink, indoor T=25°C, IOT.ZPSET1812.1 kit (light grey)

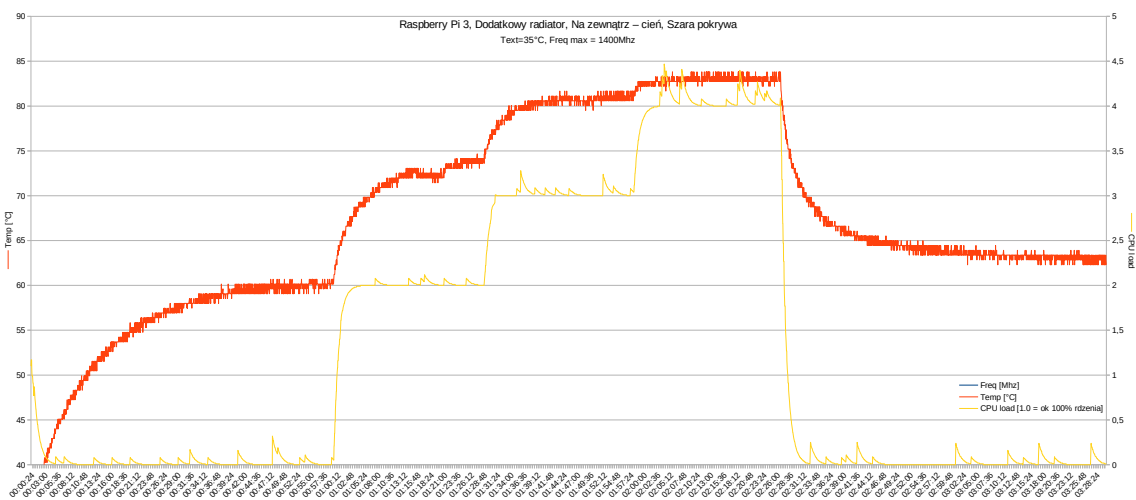

Raspberry Pi3 with extra heat sink, outdoor, shade T=35°C, IOT.ZPSET1812.1 kit (light grey)

Raspberry Pi3 with extra heat sink and a fan installed in the cover on spacers over the CPU (Sunon EE40100S2-1000U-999)

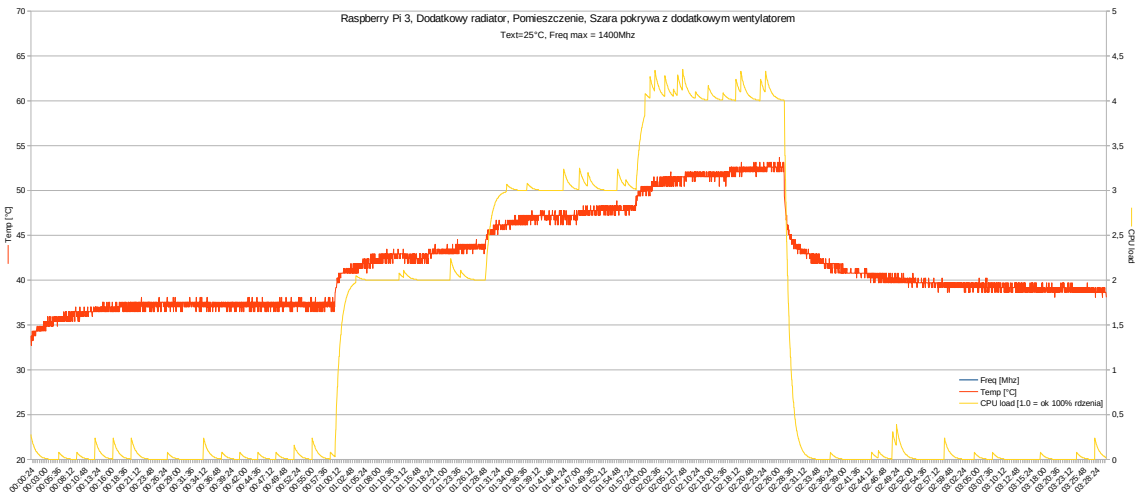

Raspberry Pi3, extra heat sink and fan, indoor T=25C, IOT.ZPSET1812.1 kit (light grey)

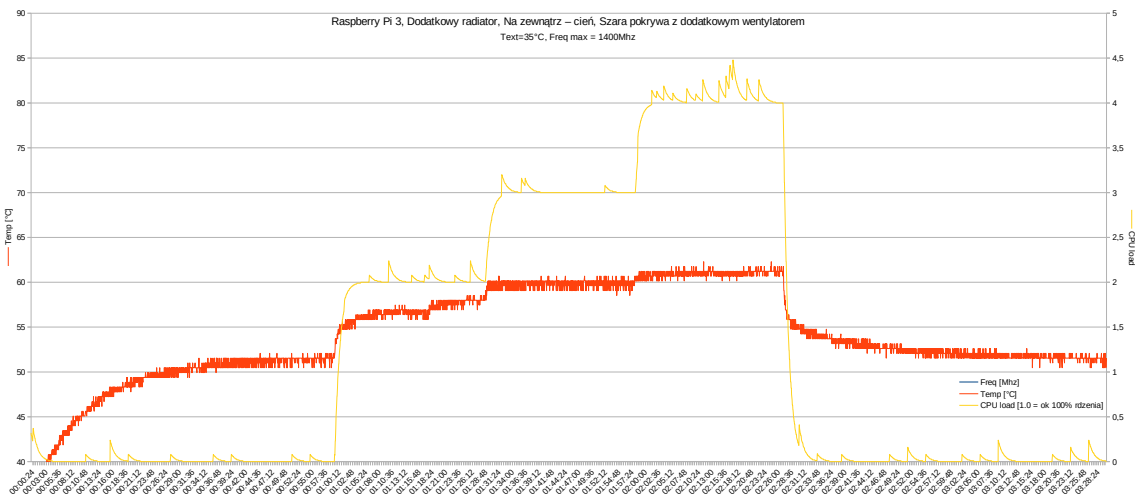

Raspberry Pi3, extra heat sink and fan, outdoor, shade T=35C, IOT.ZPSET1812.1 kit (light grey)

Raspberry Pi4 (stock configuration without a heat sink)

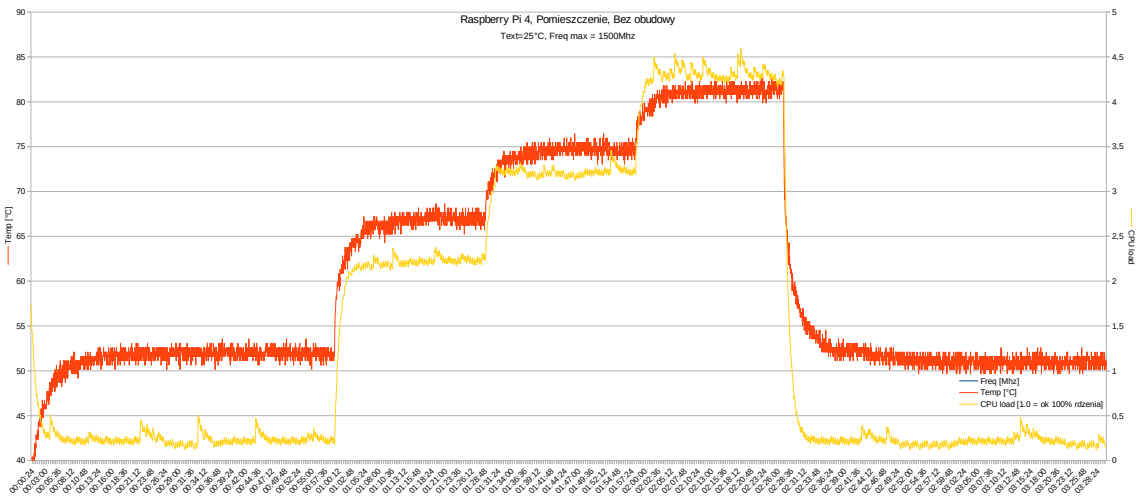

Raspberry Pi4, indoor T=25C, w/o enclosure (bench)

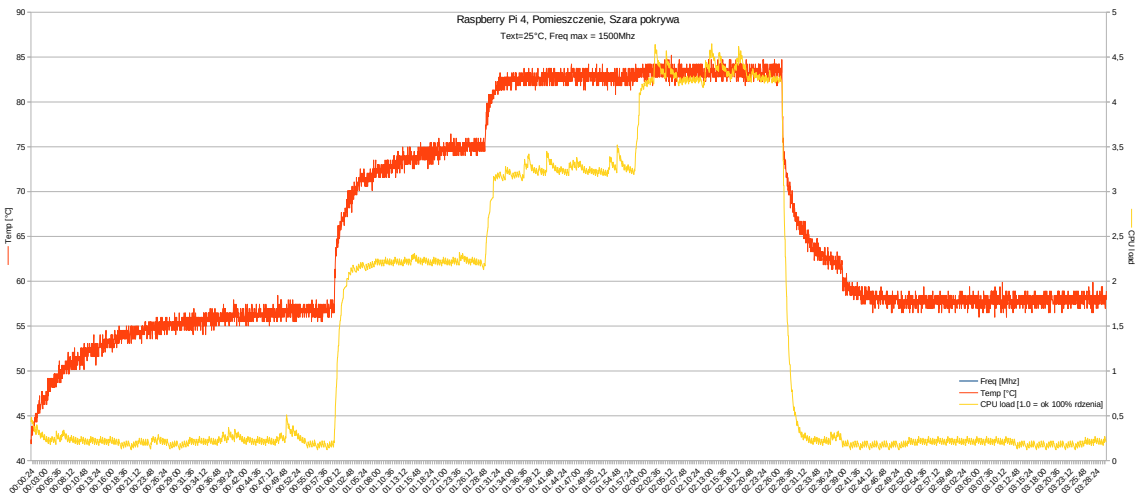

Raspberry Pi4, indoor T=25C, IOT.ZPSET1812.1 kit (light grey)



Raspberry Pi4, outdoor, shade T=35C, IOT.ZPSET1812.1 kit (light grey)

Raspberry Pi4 with extra heat sink



Raspberry Pi4 with extra heat sink, indoor T=25C, w/o enclosure (bench)

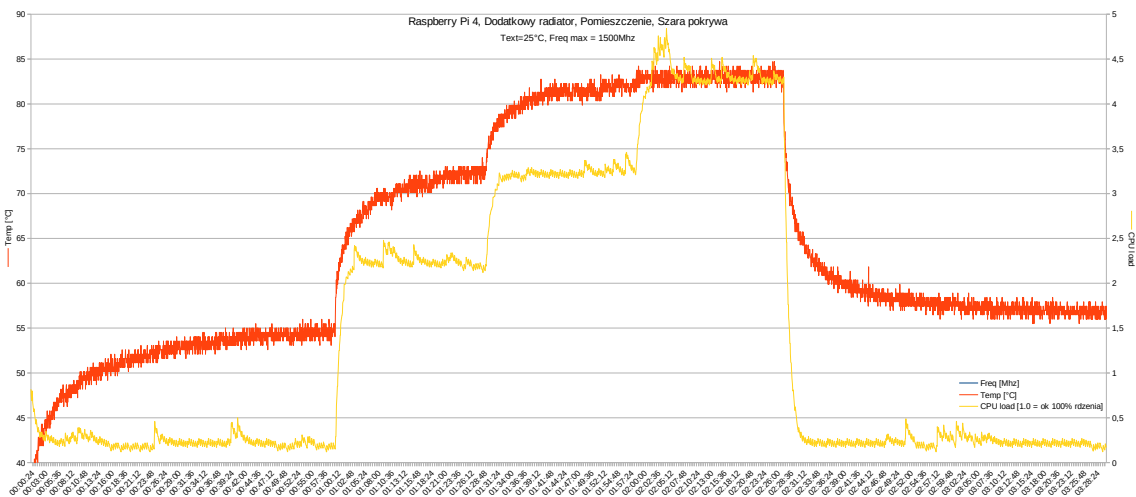

Raspberry Pi4 with extra heat sink, indoor T=25C, IOT.ZPSET1812.1 kit (light grey)

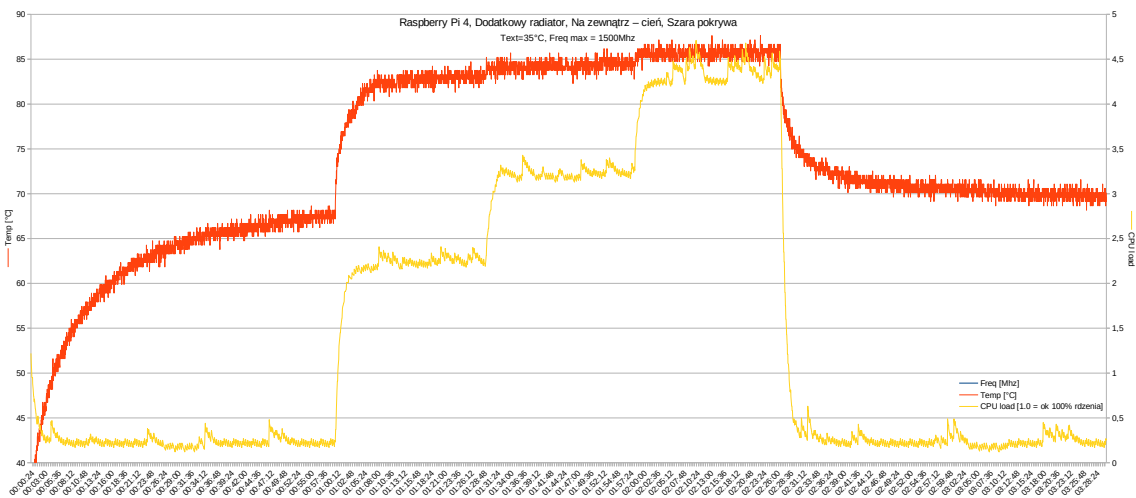

Raspberry Pi4 with extra heat sink, outdoor, shade T=35C, IOT.ZPSET1812.1 kit (light grey)

Raspberry Pi4 with an extra heat sink and 2 fans

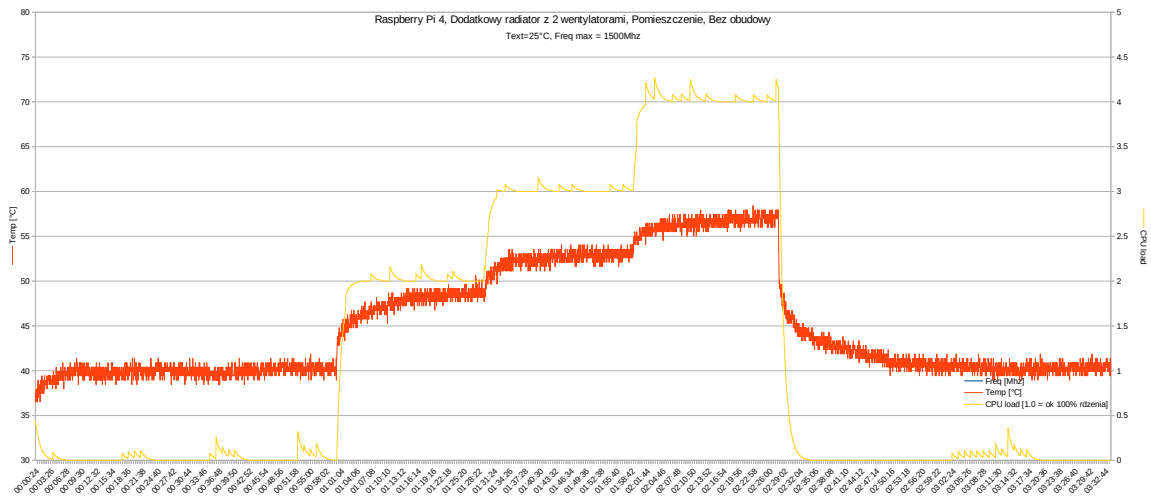

Raspberry Pi4, extra heat sink and 2 fans, indoor T=25C, w/o enclosure (bench)

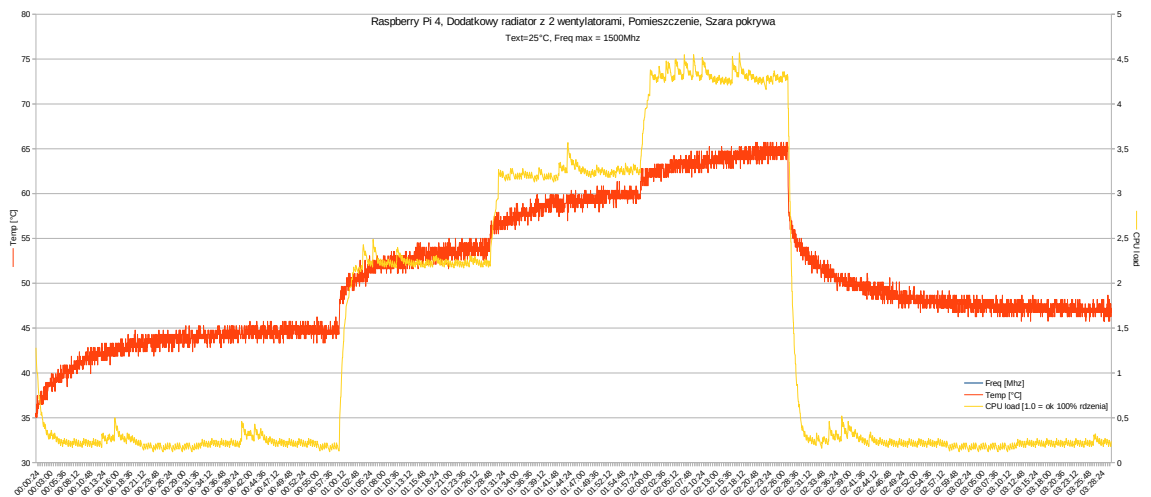

Raspberry Pi4, extra heat sink and 2 fans, indoor T=25C, IOT.ZPSET1812.1 kit (light grey)

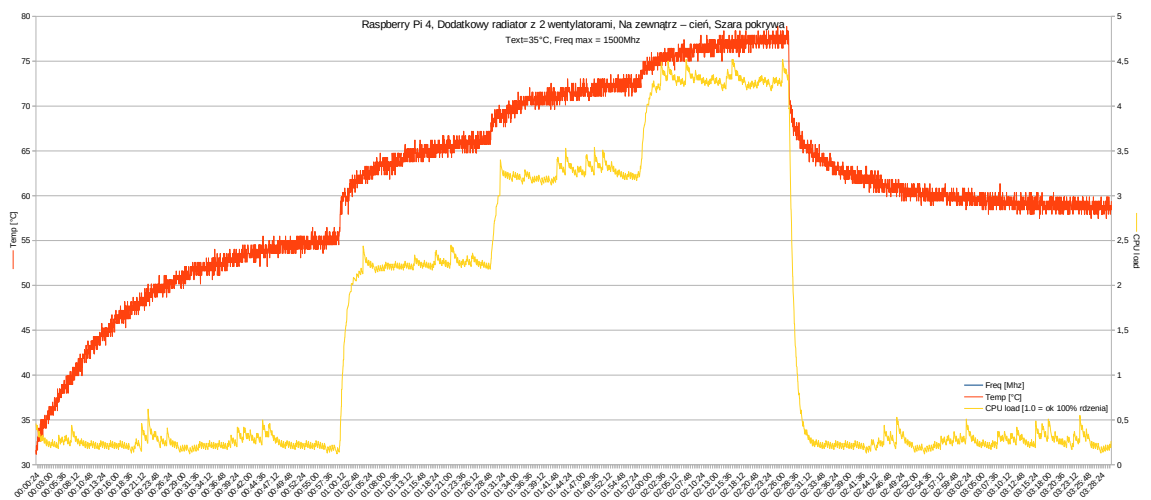

Raspberry Pi4, extra heat sink and 2 fans, outdoor, shade T=35C, IOT.ZPSET1812.1 kit (light grey)

Hole pattern template for IOT.ZPSET1812 wall-mounted installation

NOTE: Print to 100% scale

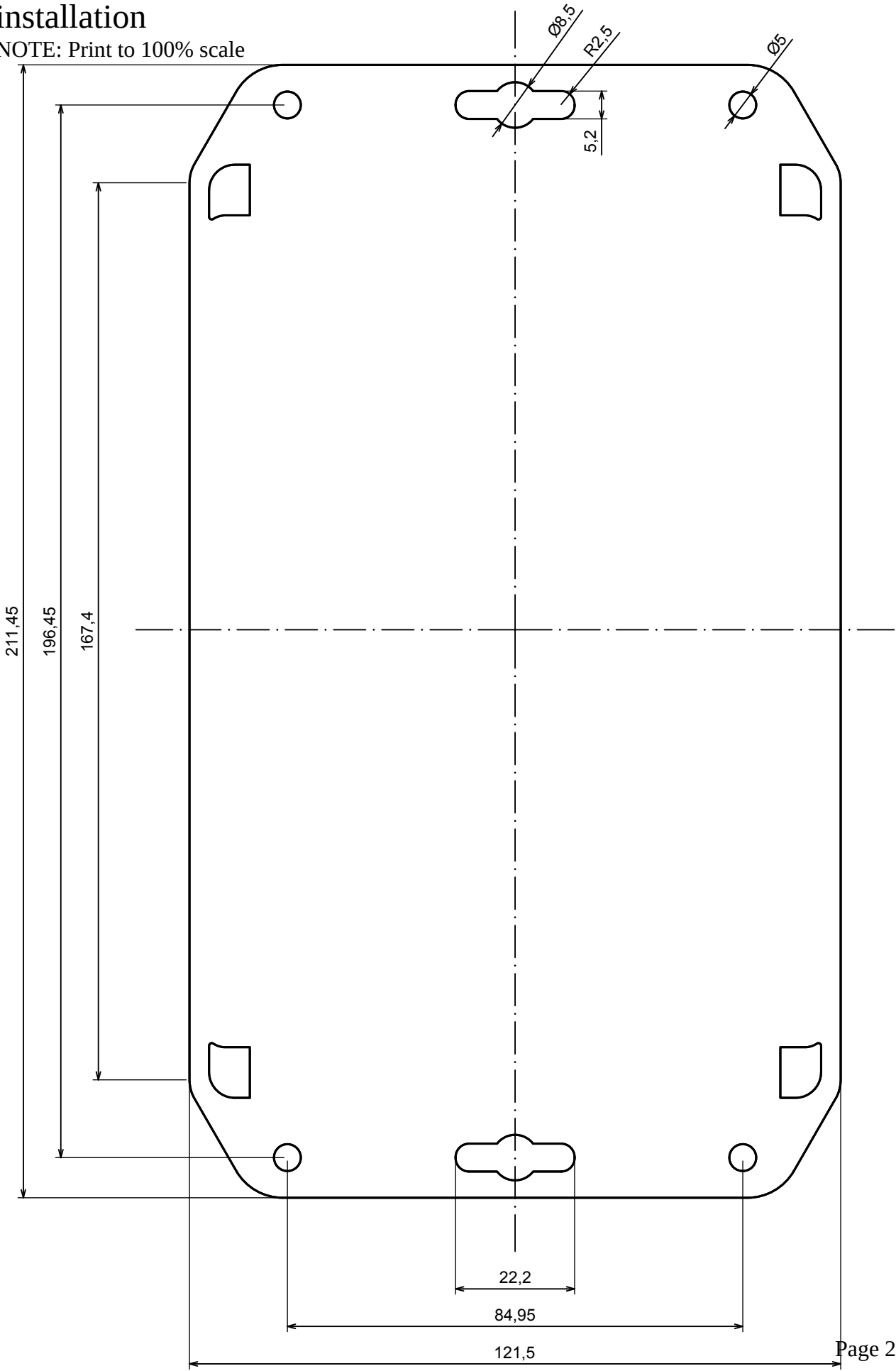

Product page:



IOT.ZPSET1812

Kradex Krzysztof Radzikowski
ul. Naddnieprzańska 32
04-205 Warszawa
POLAND
tel. (+48 22) 613-08-88
fax. (+48 22) 812-10-68
www.kradex.com.pl
kradex@kradex.com.pl