

A |

All rights reserved, Copyright Kradox 2020

Product model Enclosure IOT.ZPSET1510 - Assembly ZP150.100.60SU TM

Format: A3 Material: PC, ABS

Scale 1:2 Tolerance: +/- 0.5



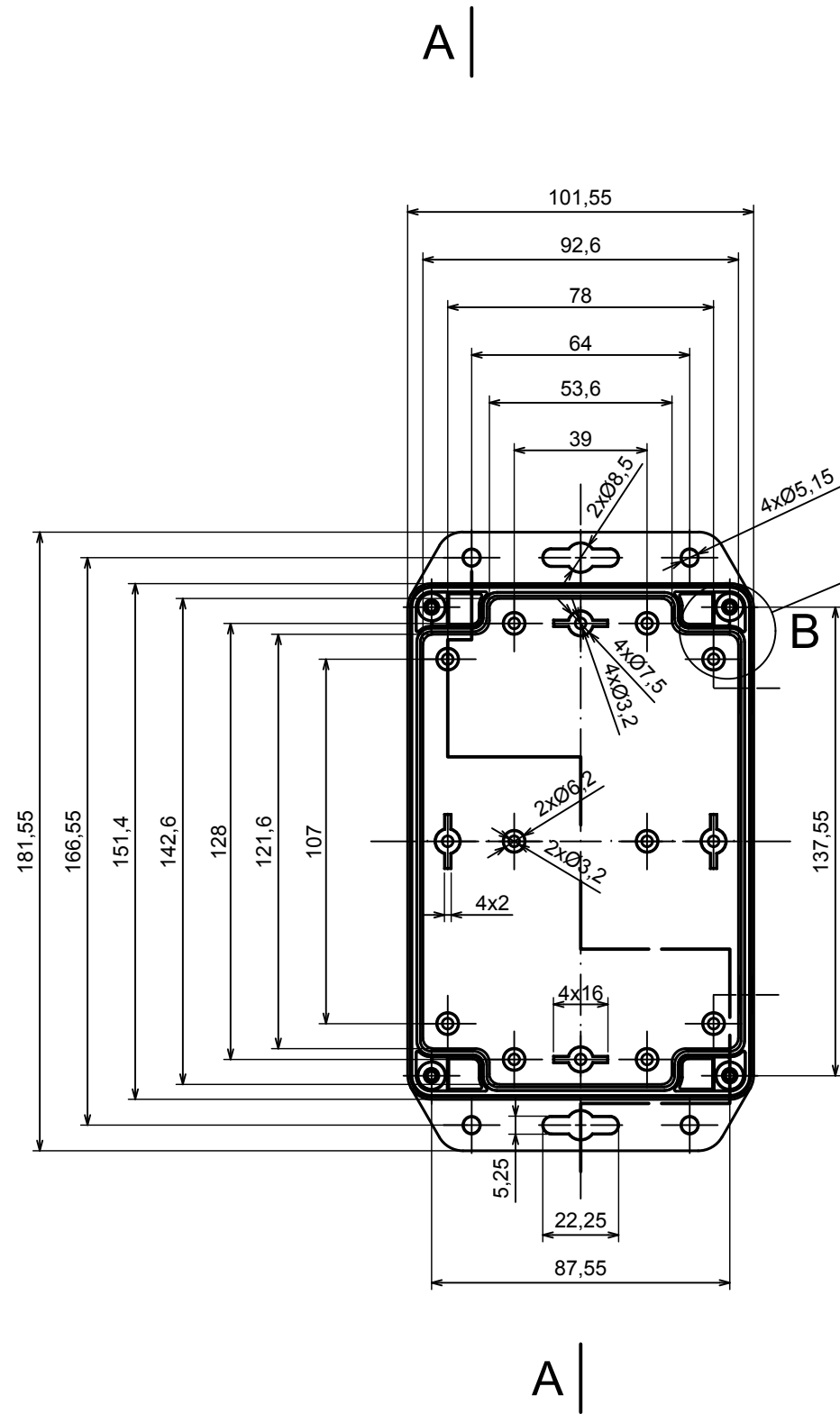

B (1:1)

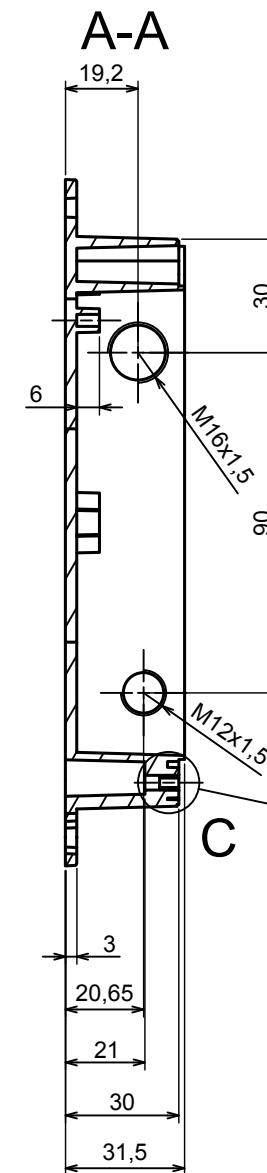
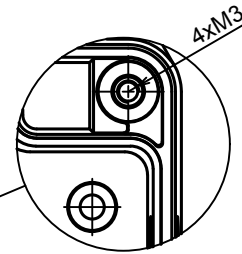

C (1:1)

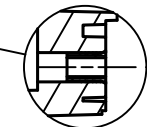

All rights reserved, Copyright Kradox 2020

Product model: Base IOT.ZPSET1510 - Base ZP150.100.30U TM

Format: A3 Material: PC, ABS

Scale 1:2 Tolerance: +/- 0.5



A |

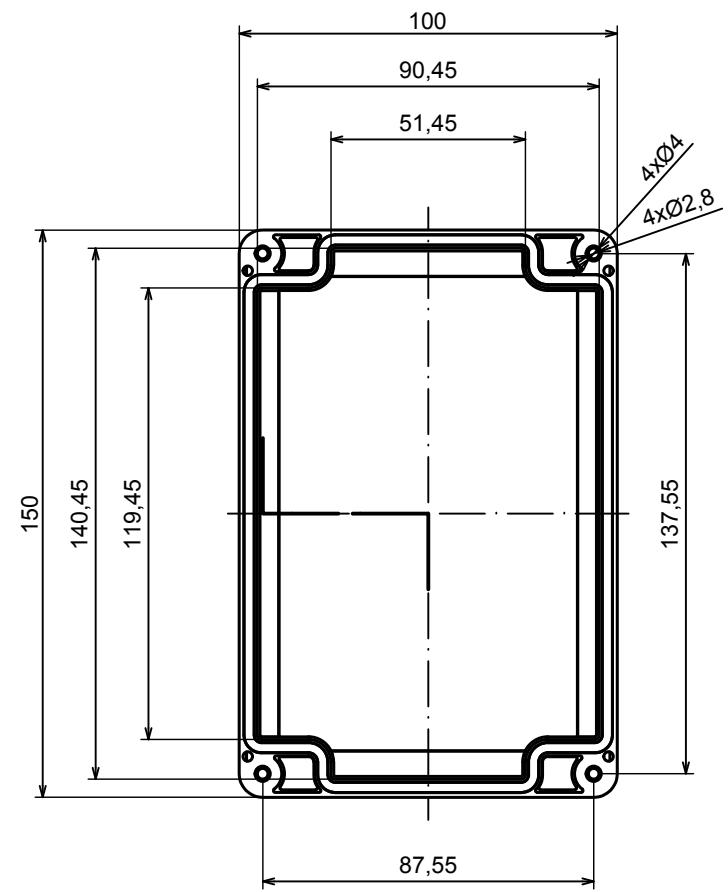

A |

A-A

B (1:1)

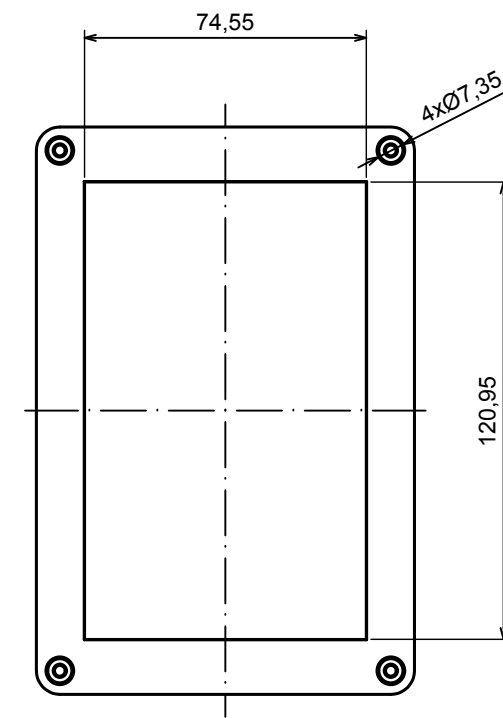
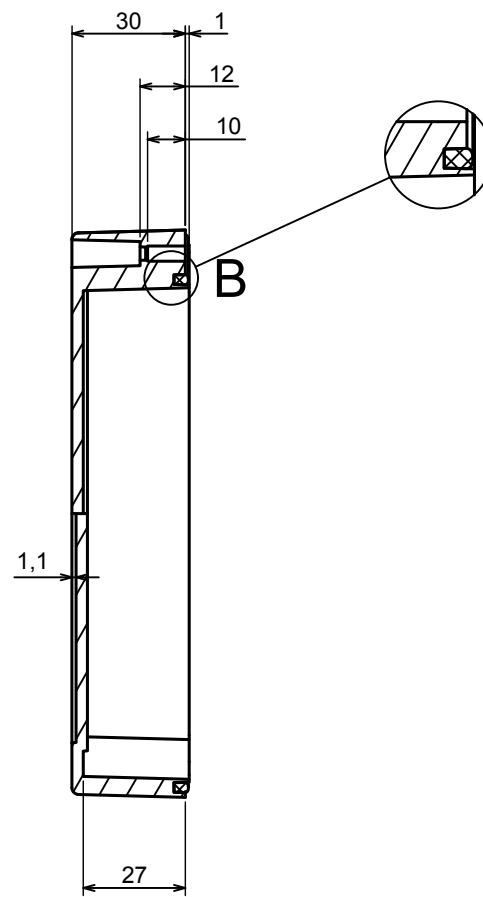

All rights reserved, Copyright Kradox 2020

Product model: Cover IOT.ZPSET1510 - Cover ZP150.100.30S

Format: A3 Material: PC, ABS

Scale 1:2 Tolerance: +/- 0.5

