



ArduCam

Camera Module for Raspberry Pi

SKU:B0390



QUICK START

8MP IMX219 Stock Lens Fixed Focus

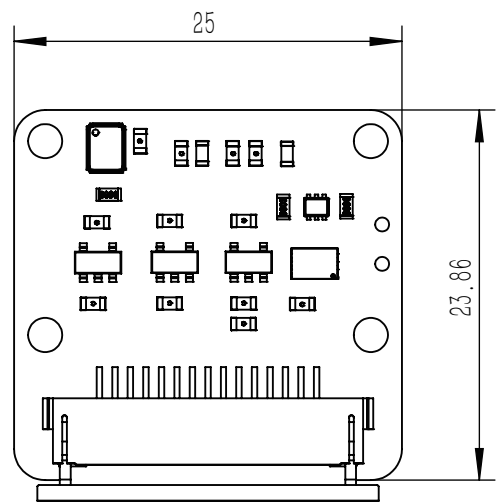
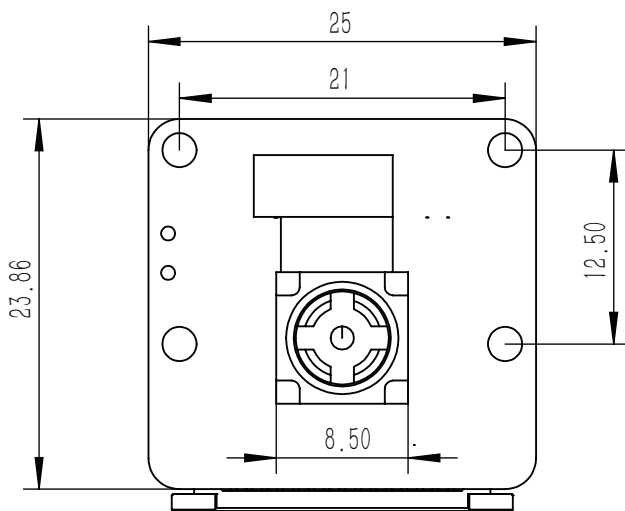
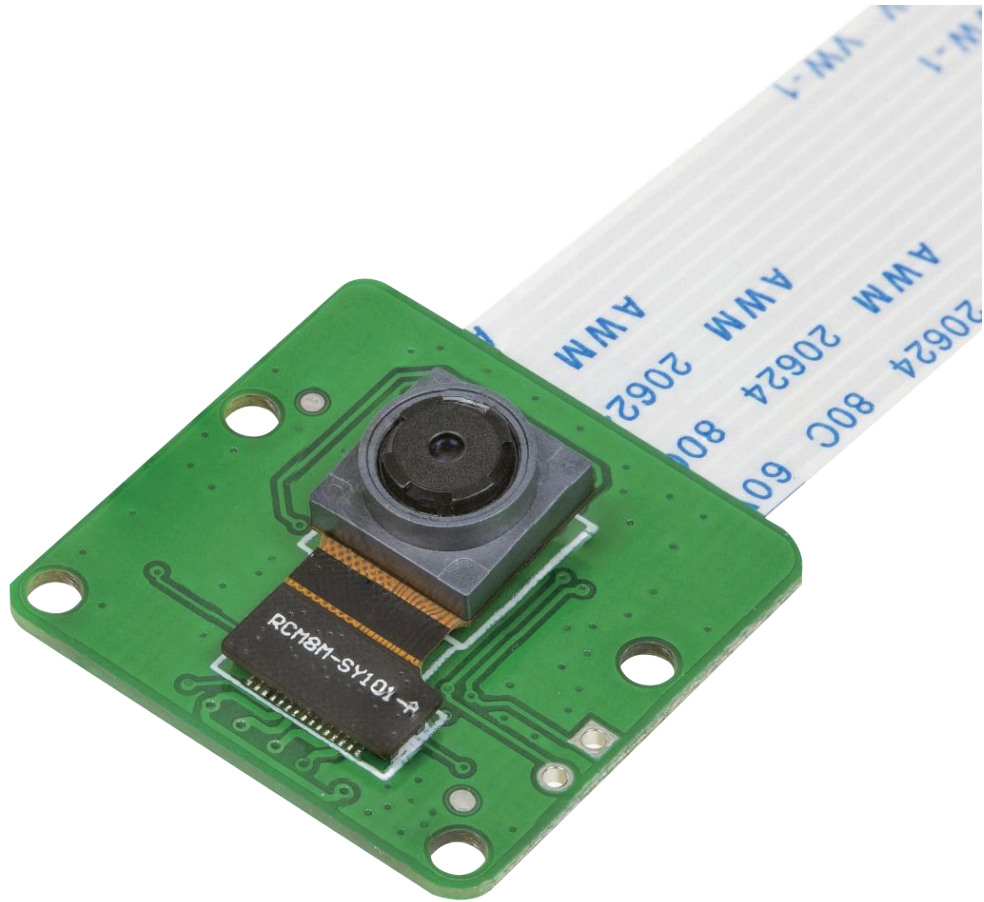

Size	25 × 24 × 9 mm
Weight	3g
Still resolution	8 Megapixels
Frame rate	1080p30, 720p60 and 640 × 480p60/90
Sensor	Sony IMX219
Sensor resolution	3280 × 2464 pixels
Sensor image area	3.68 x 2.76 mm (4.6 mm diagonal)
Pixel size	1.12 μm x 1.12 μm
Optical size	1/4"
Focal length	3.04 mm
Horizontal field of view	62.2 degrees
Vertical field of view	48.8 degrees
Focal ratio (F-Stop)	2.0

COPYRIGHT

Specifications are subject to change without notice. No part of the specifications may be reproduced in any form or by any means or used to make any derivative such as translation, transformation, or adaptation without permission from Arducam. All rights reserved.

CONNECT THE CAMERA

You need to connect the camera module to the Raspberry Pi's camera port.

- ① Locate the camera port near the USB C power connector, and gently pull up on the plastic edge.
- ② Push in the camera ribbon and make sure the silver connector is facing the Raspberry Pi camera MIPI port. Do not bend the flex cable and make sure it is firmly inserted.
- ③ Push the plastic connector down while holding the flex cable until the connector is back in place.

SOFTWARE SETTING

Power on Raspberry Pi 4B and open the Terminal (Ctrl+ALT+T)
Please make sure you are running the latest version of Raspberry Pi OS. (January 28th 2022 or later releases, Debian version: 11 (bullseye)).

For Raspbian Bullseye users running on Pi 4, please do the following:

1. Edit the configuration file: `sudo nano /boot/config.txt`
2. Find the line: `camera_auto_detect=1`, update it to:
`camera_auto_detect=0`
`dtoverlay=imx219`
3. Save and reboot.

For Bullseye users running on Pi 0-3, please also:

1. Open a terminal
2. Run *sudo raspi-config*
3. Navigate to Advanced Options
4. Enable Glamor graphic acceleration
5. Reboot your Pi.

Operating The Camera

libcamera-still is an advanced command line tool for capturing still images with the IMX219 Camera Module.

libcamera-still -t 5000 -o test.jpg

This command will give you a live preview of the camera module, and after 5 seconds, the camera will capture a single still image. The image will be stored in your home folder and named test.jpg.

-t 5000: Live preview for 5 seconds.

-o test.jpg: take a picture after the preview is over and save it as test.jpg

If you only want to see the live preview, use the following command:

libcamera-still -t 0

Please Note:

This camera module supports the latest Raspberry Pi OS Bullseye (released on Jan 28th, 2022) and libcamera apps, not for the previous Raspberry Pi OS (Legacy) users.

Other IMX219 Cameras



SKU: B0394

Optical Format: 1/2.7"

EFL: 2.8mm

F/NO.: 2.8

FoV: 75 deg (H)

IR Filter: 650nm

Low Distortion

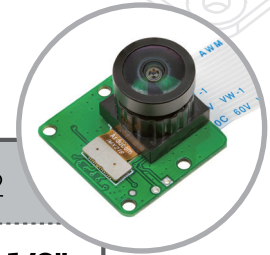

SKU: B0392

Optical Format: 1/3"

EFL: 1.3mm

F/NO.: 2.0

FoV: 175 deg (D)

IR Filter: 650nm

Wide Angle

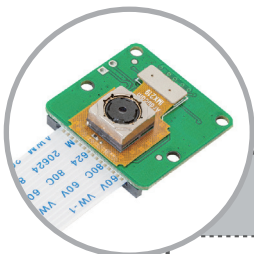

SKU: B0393

Optical Format: 1/4"

EFL: 2.8mm

F/NO.: 2.2

FoV: 77.6 deg (D)

IR Filter: 650nm

Motorized Focus

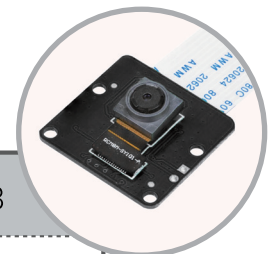

SKU: B0398

Optical Format: 1/4"

EFL: 3.04mm

F/NO.: 2.0

FoV: 62.2 deg (H)

Without IR filter

Night Vision

Extension Cable Solution

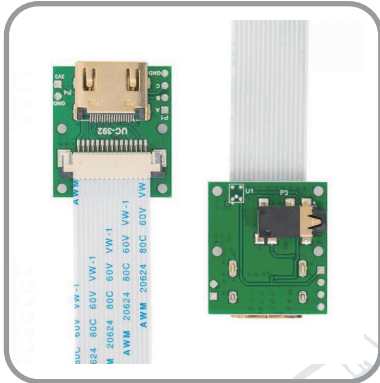

CSI to HDMI Extension Board

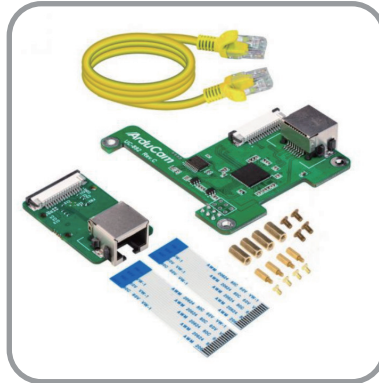

15-Meter Ethernet Cable Extension Kit



300mm Extension Cable

Camera Housing



Case, Mini Tripod Stand and 1ft/30 cm FPC Cam Cable

Tripod



Compatible with V1/V2 Cameras

Pan Tilt Platform

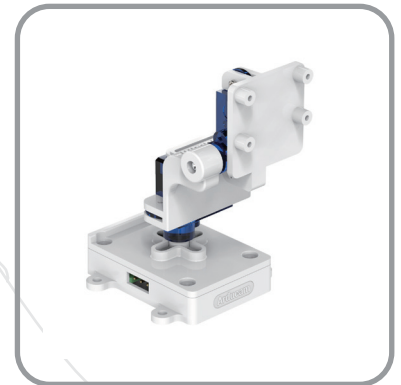

V1/V2 Compatible Pan Tilt Kit

Multi-Camera Solutions

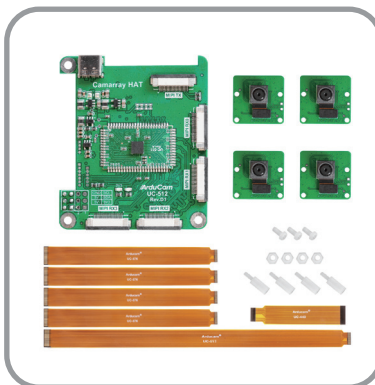

IMX219 Synchronized Quad-Camera Kit



Visit us at
www.arducam.com