

Totem Truck Top for RoboCar

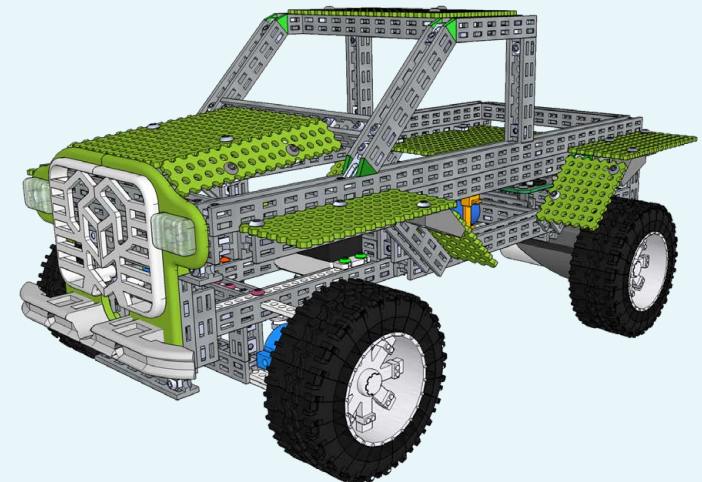

Version 2.5
Dec 2021

Starting tips.

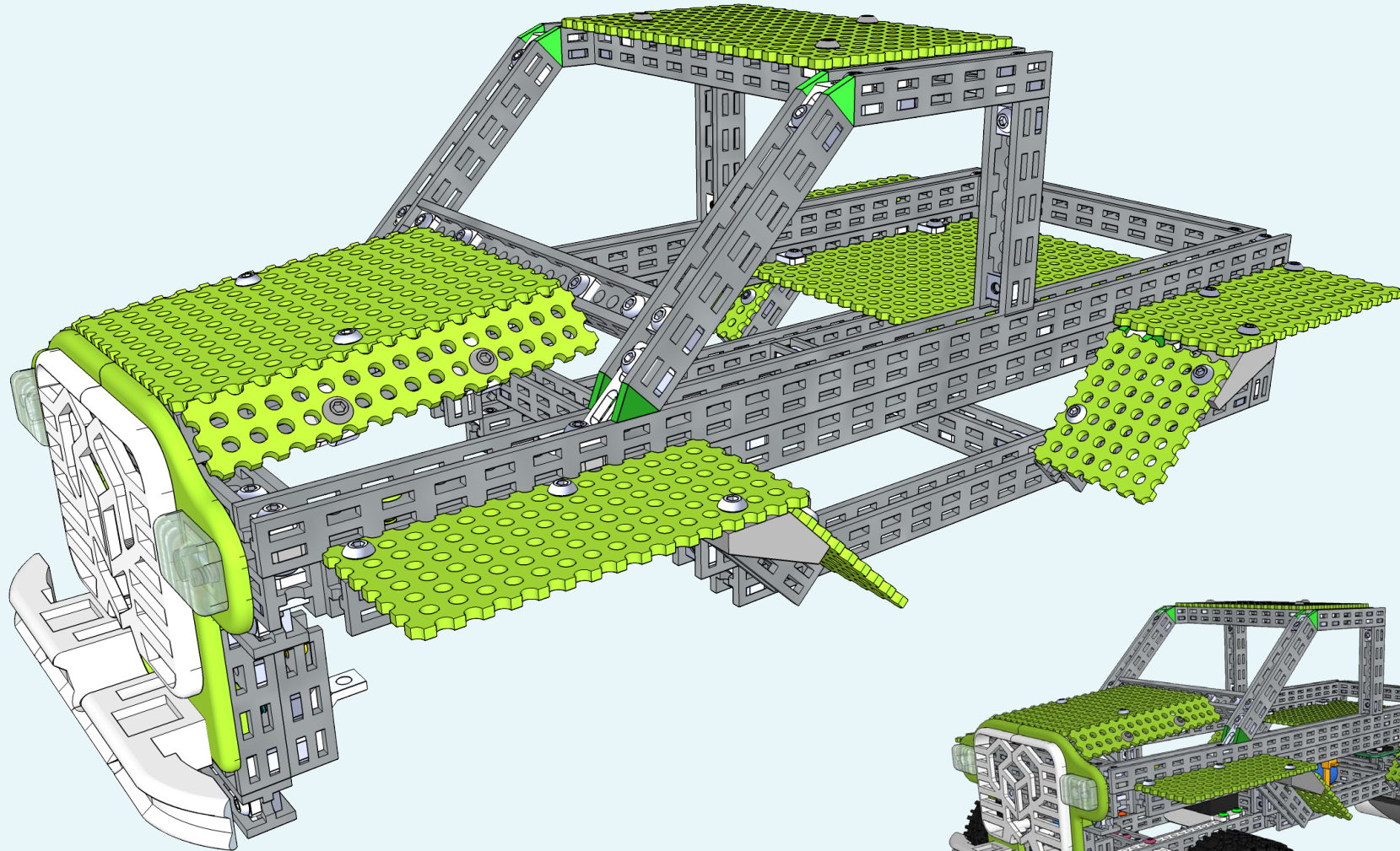
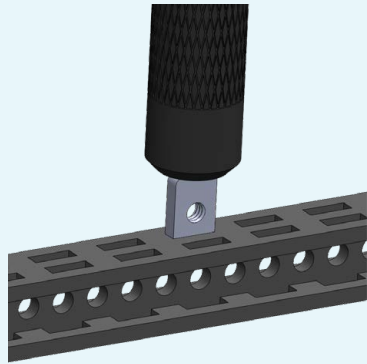

Use the back of the screwdriver to push the nuts into the slots.

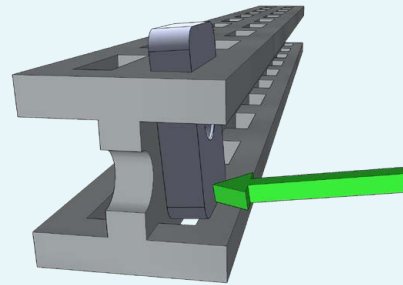

After entering the nut, it sometimes is stuck at the next slot. Use your thumb to push it straight, then continue to push it through.

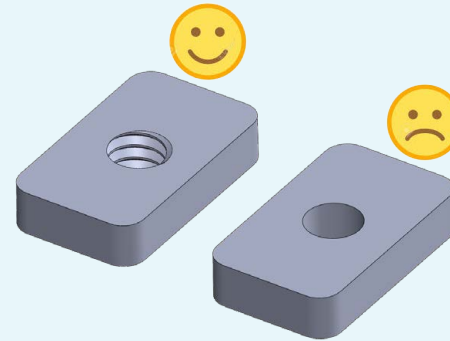

Some of the nuts (~1%) are missing threads. This is a manufacturing issue. We are trying to minimize the fault. In the mean time, we supply extra nuts in your kit. We apologize for the inconvenience.

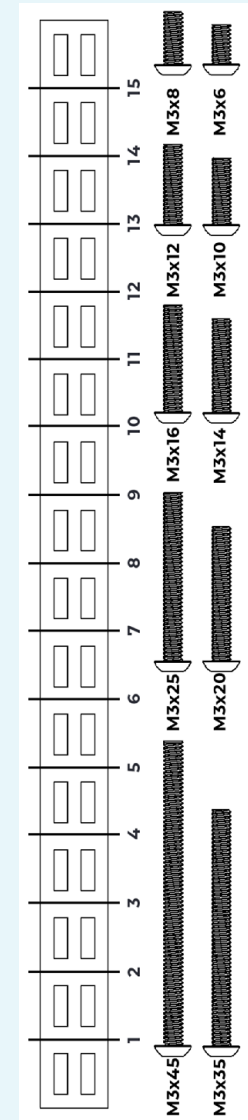

Use Beam/Bolt ruler to help you find the right lengths of the bolts and beams.

For more tips, please go to the link below:
<https://totemaker/blog/totem-mechanics-for-beginners/>

BEFORE YOU START BUILDING:

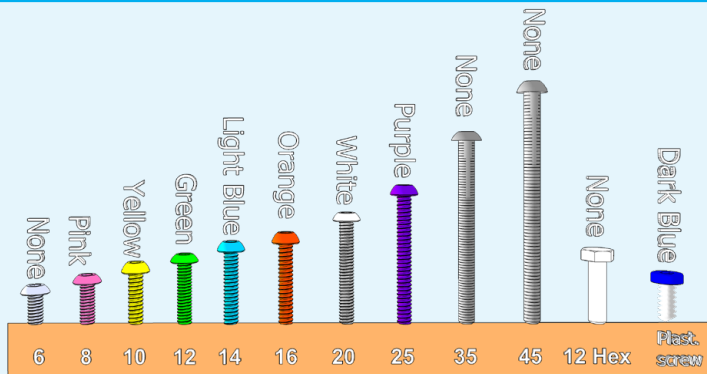

Bolt colours codes:

We have put some colours on bolts to make instructions more clear.



NOTE: 2x 8mm

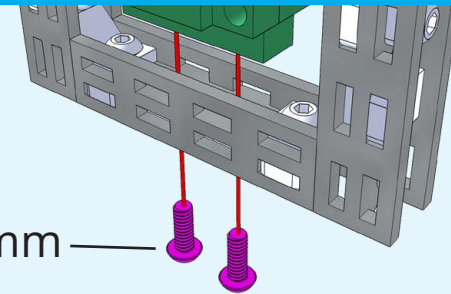

Notes for bolts other than 6mm:

When bolts that are not 6mm will be used, in addition to colours, extra notes are given in the instructions with lengths in mm.

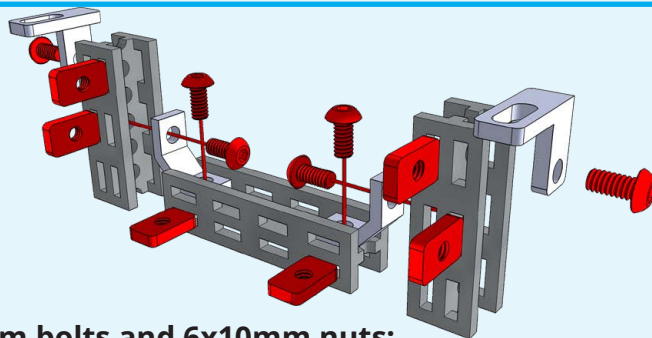

6mm bolts and 6x10mm nuts:

When starting on a building step, the 6mm bolts and 6x10 nuts are coloured **RED**. It makes it easier to see where the new bolts and nuts are placed.

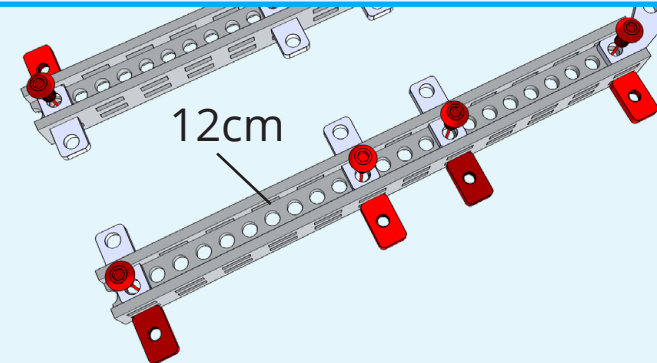

I-beams lengths.

When a new Totem beam is needed in a step, the length is indicated.

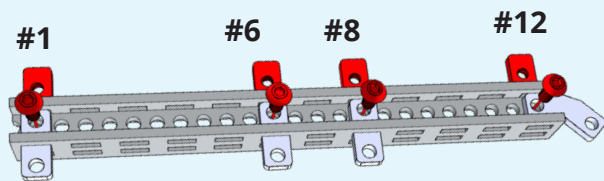

Positions for nuts with #-symbol.

When it is helpful, the slot-number is indicated in the Totem beam. Starting from #1 and counting slots.

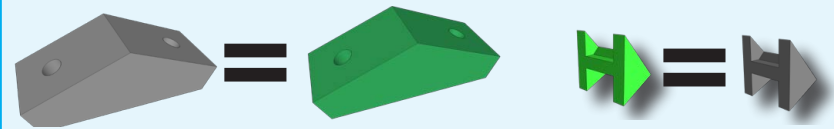

The colour of parts.

The colours of plastic parts may vary. Colours are often changed on parts to make it easier to see them in the instructions pictures.

Totem RoboCar Truck Top Parts.

153x

 Bolt M3x6

2x

 Bolt M3x10

12x

 Bolt M3x16

2x

 Bolt M3x25

153x

 Nut M3 6x10

4x

 Nut M3 5.5x5.5

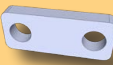
32x

 2-hole simple bracket

14x

 C-Bracket

10x

 2-hole 45 bracket

4x

 3-hole 45 degrees

1x

 L-twisted bracket

1x

 L-twisted mirror bracket

8x

 Double side filler

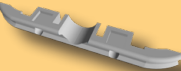
4x

 45 degree plastic bracket

1x

 Bumper

1x

 Outer Grill

1x

 Inner Grill

2x

 Headlight

PERFORATED BOARDS:

100x60mm **100x100mm**

1x **1x**

80x35mm **40x35mm** **80x60mm**

4x **4x** **1x**

80x15mm

2x

BEAMS:

2 cm	2 x
3 cm	4 x
4 cm	6 x
5 cm	2 x
6 cm	3 x
7 cm	6 x
8 cm	2 x
10 cm	8 x
12 cm	2 x
19 cm	2 x
29 cm	2 x
30 cm	2 x

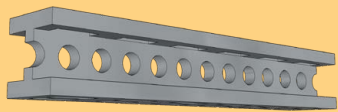

PART 1

1

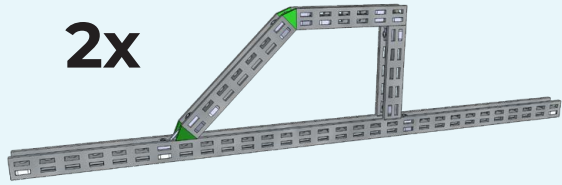

16x	26x	4x
Bolt M3x6	Nut M3 6x10	C-Bracket

2x	2x	4x
3-hole 45 degrees	2-hole 45 bracket	Double side filler

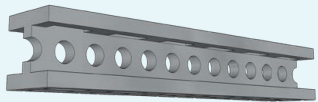

5 cm	2x
6 cm	2x
7 cm	2x
30 cm	2x

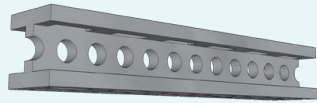

5 cm	2x
6 cm	2x

4x
Bolt M3x6
4x
Nut M3 6x10
2x
C-Bracket

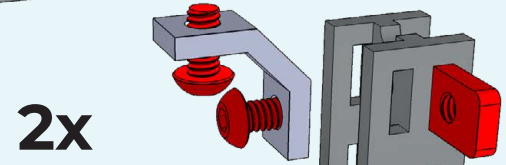
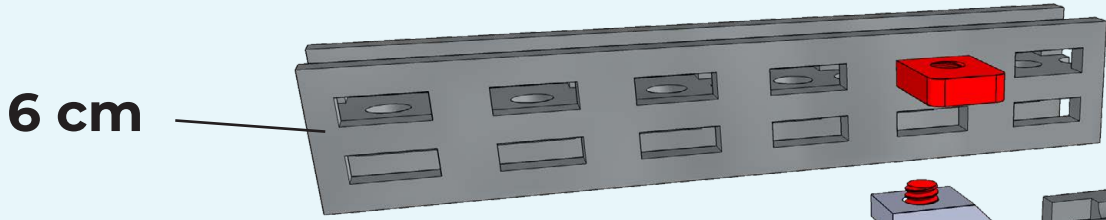

5 cm

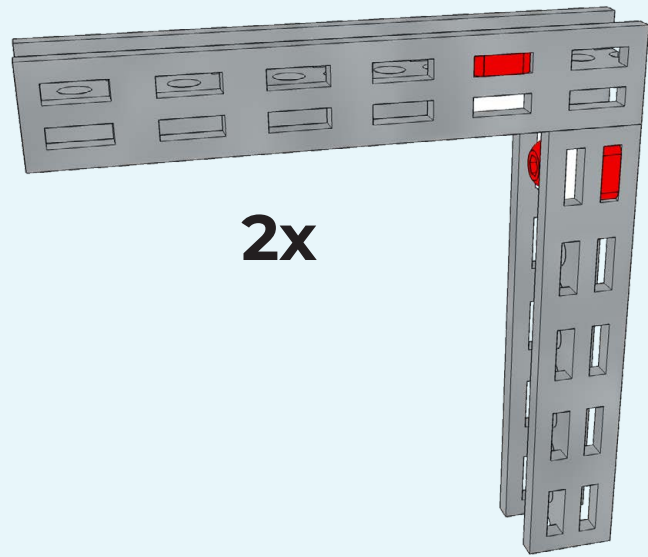

2

7 cm

2x



4x	4x	2x	2x
Bolt M3x6	Nut M3 6x10	2-hole 45 bracket	Double side filler

2x

	2x
7 cm	2x

3

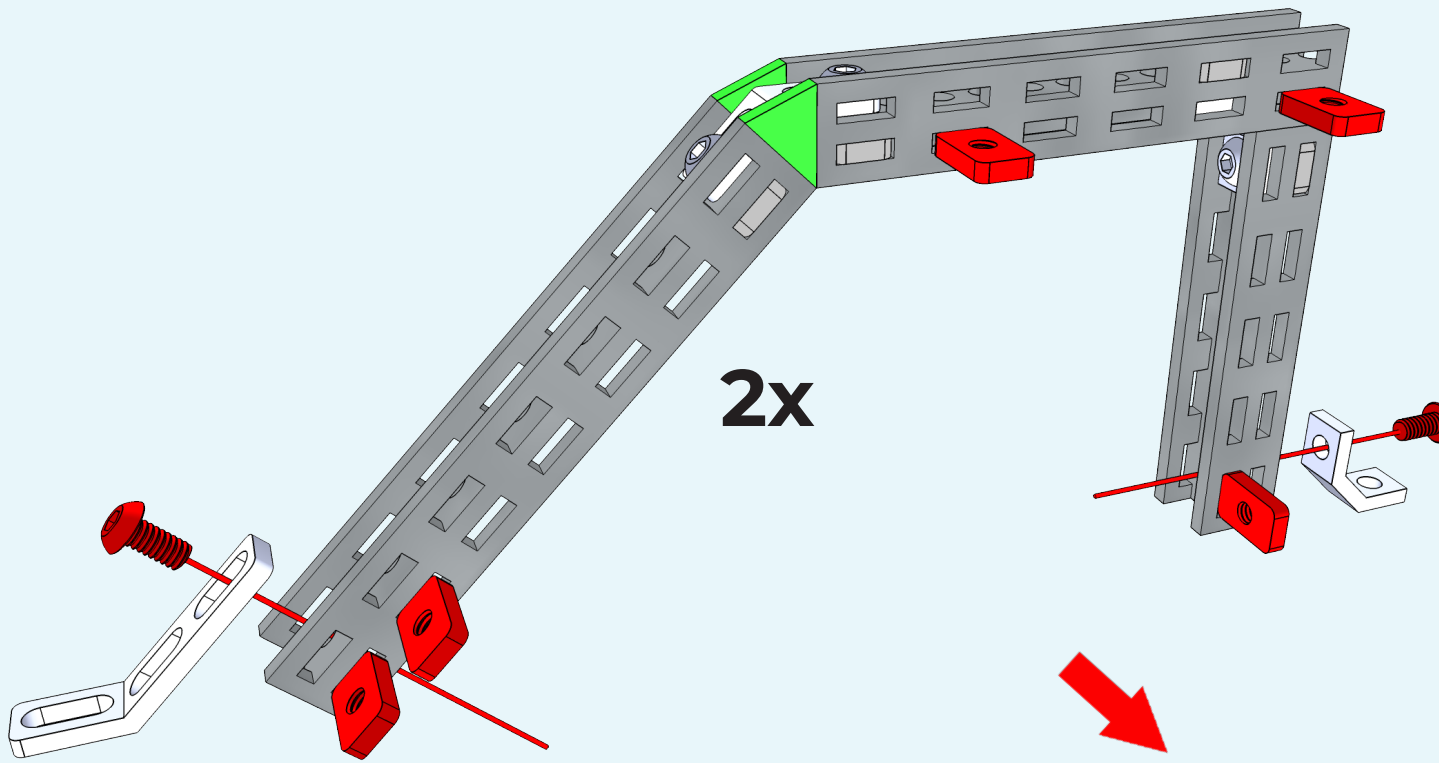

- 4x Bolt M3x6
- 10x Nut M3 6x10
- 2x C-Bracket
- 2x 3-hole 45 degrees

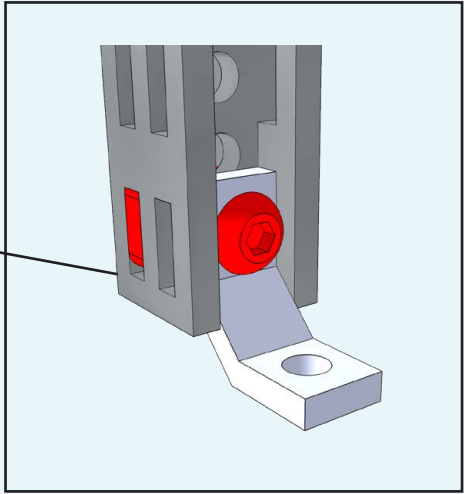
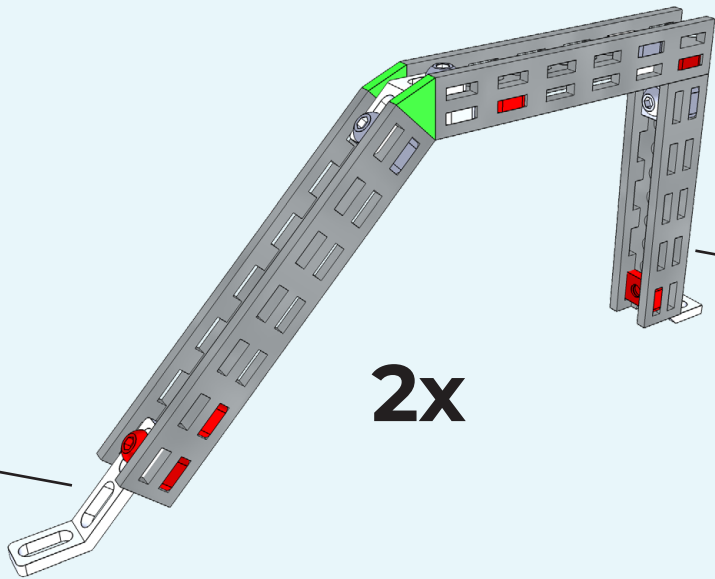
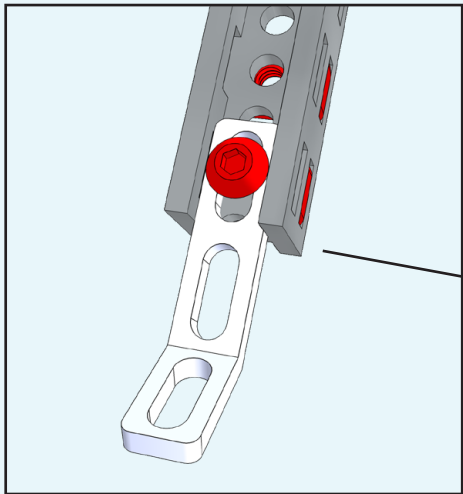

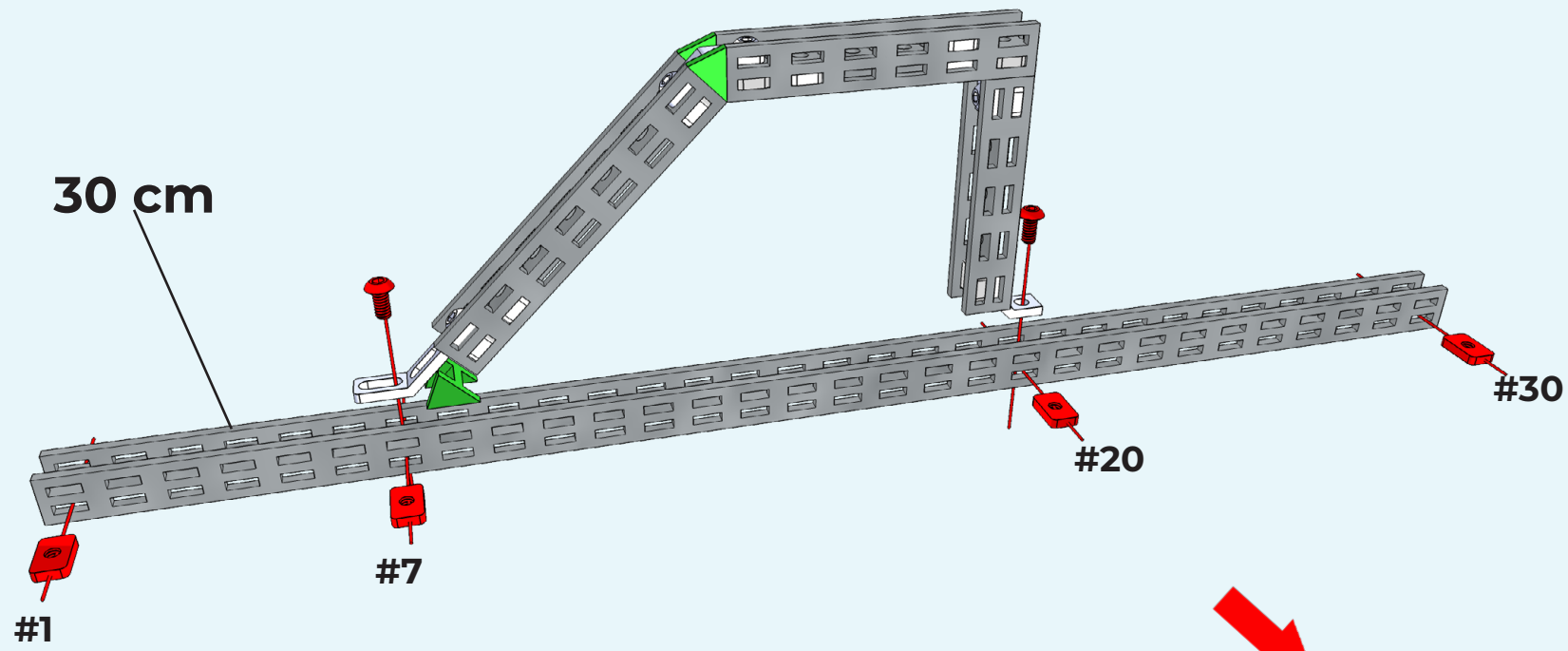

- 4x Bolt M3x6
- 8x Nut M3 6x10
- 2x Double side filler

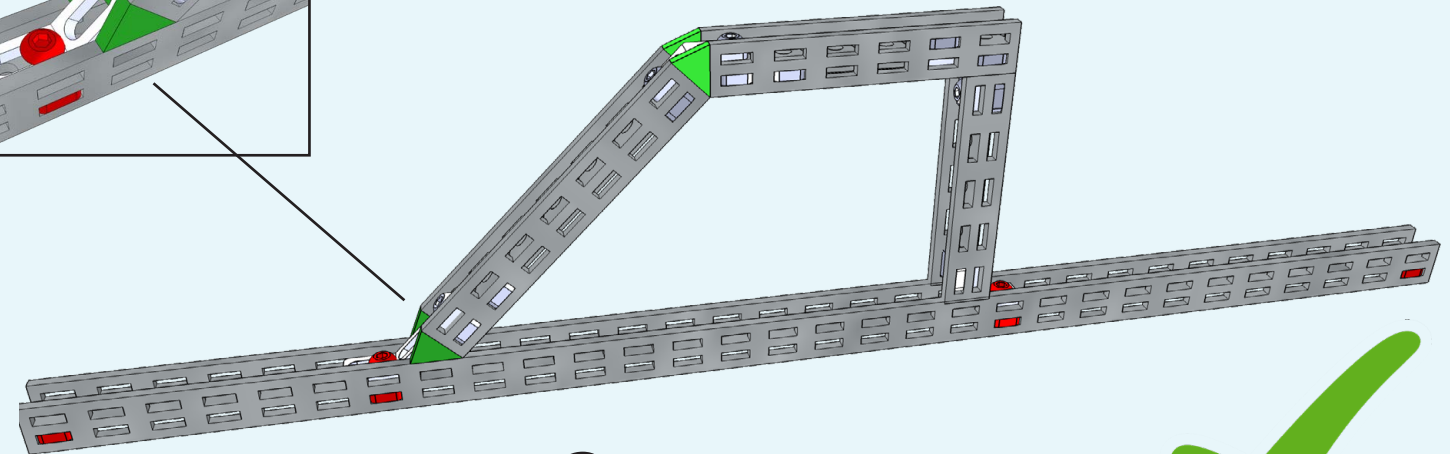
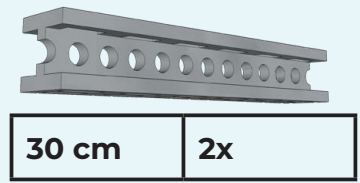
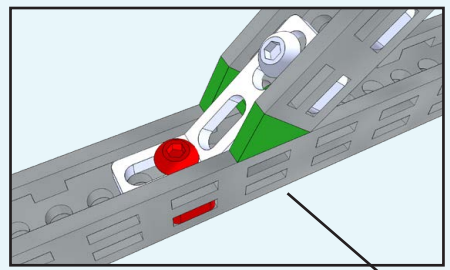

2x

PART 1



PART 2

1x

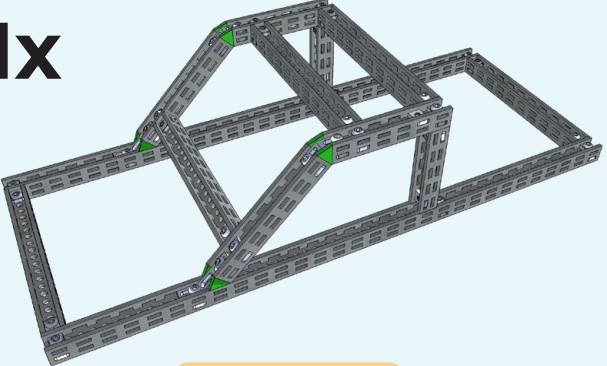

- 20x

Bolt M3x6
- 10x

Nut M3 6x10
- 10x

2-hole simple bracket

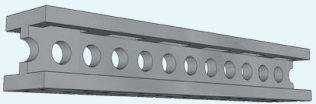

10 cm	5x
-------	----

1

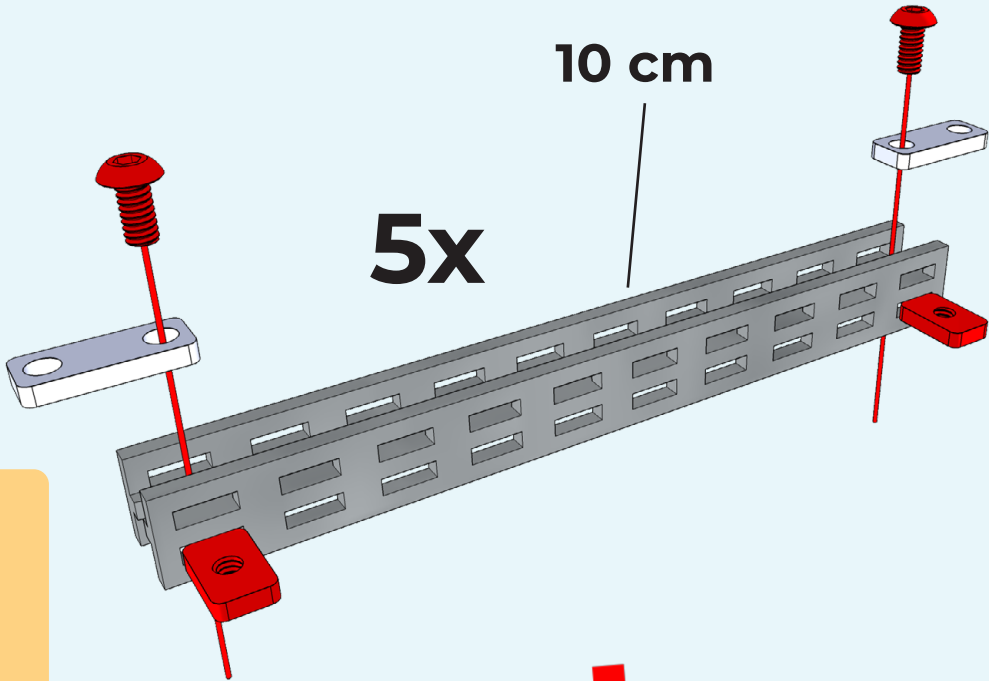

10 cm

5x

- 10x

Bolt M3x6
- 10x

Nut M3 6x10
- 10x

2-hole simple bracket

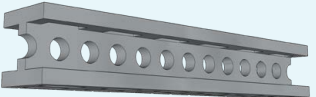

10 cm	5x
-------	----

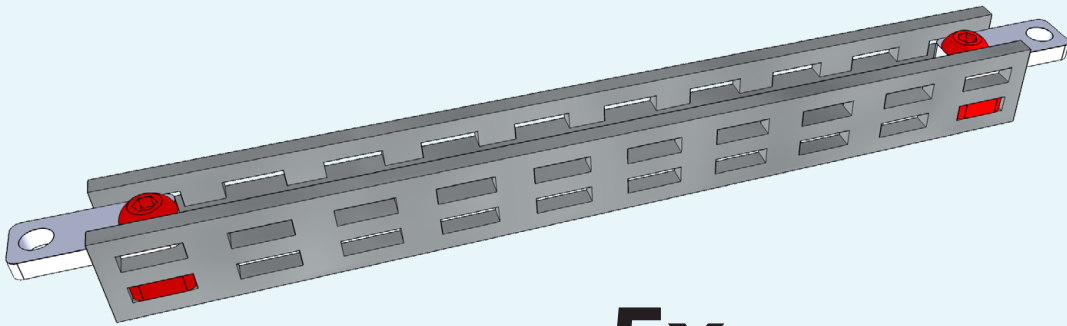

5x

2

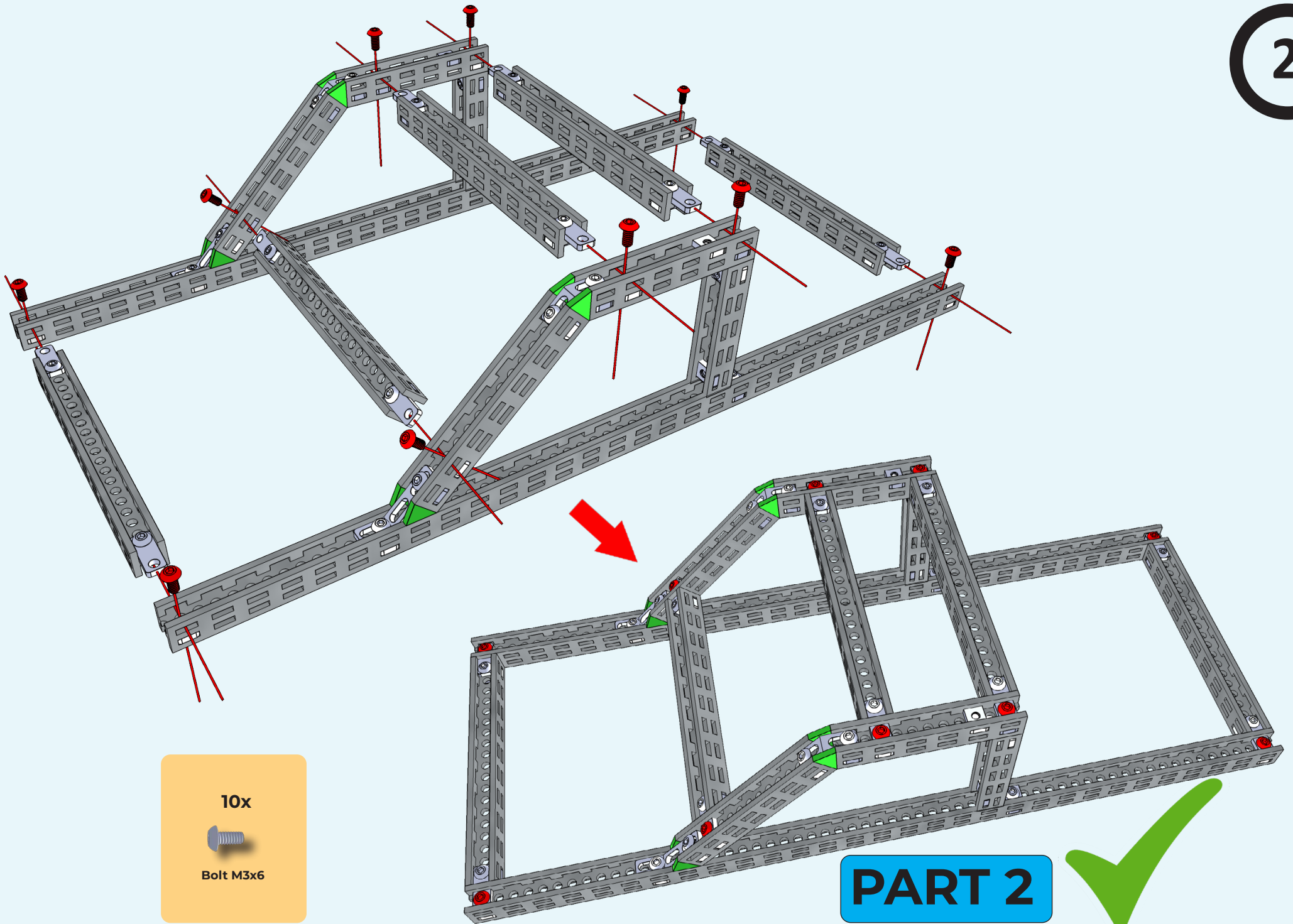

10x







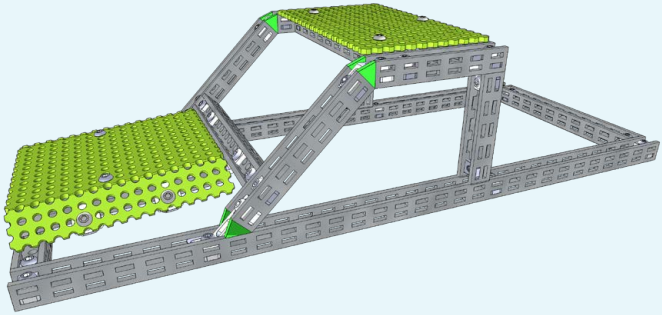

Bolt M3x6

PART 2





PART 3

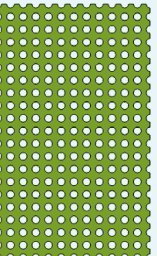

- 17x

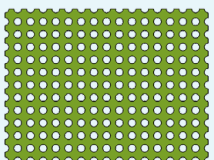
Bolt M3x6
- 2x

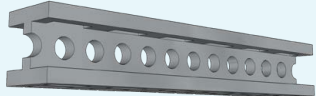
Bolt M3x16
- 19x

Nut M3 6x10
- 4x

2-hole 45 bracket
- 2x

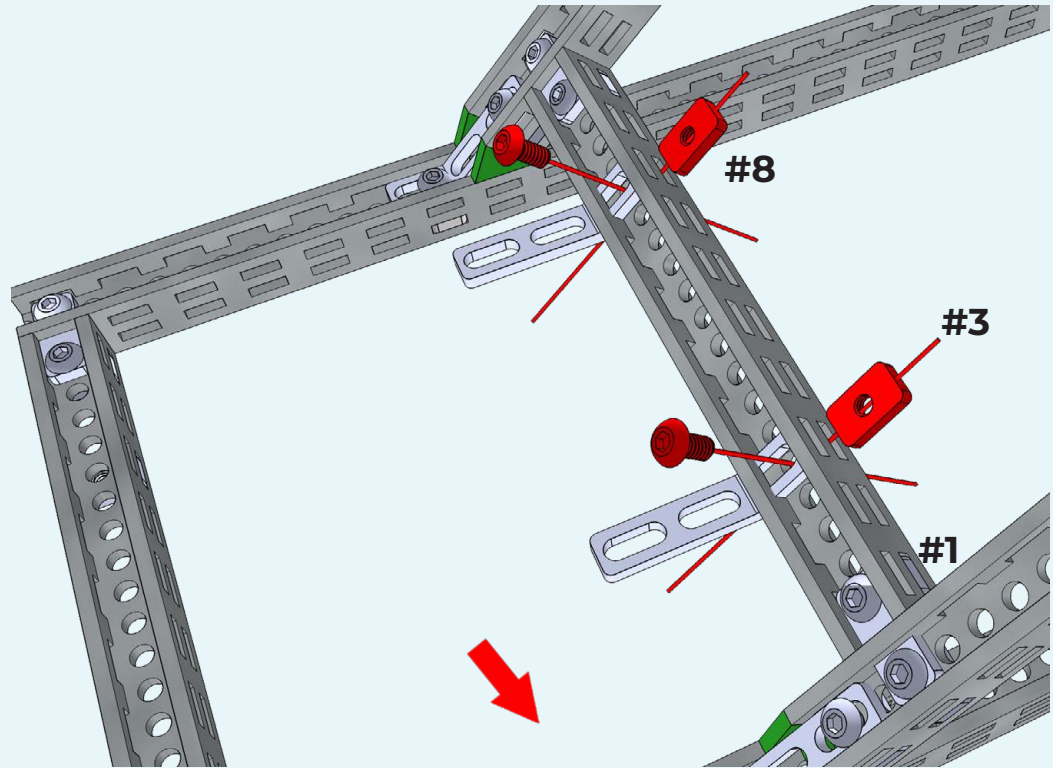
3-hole 45 degrees

- 100x60mm

1x

80x60mm

1x
- 80x15mm

2x
- 
- 8 cm

2x

1



- 2x

Bolt M3x6
- 2x

Nut M3 6x10
- 2x

3-hole 45 degrees

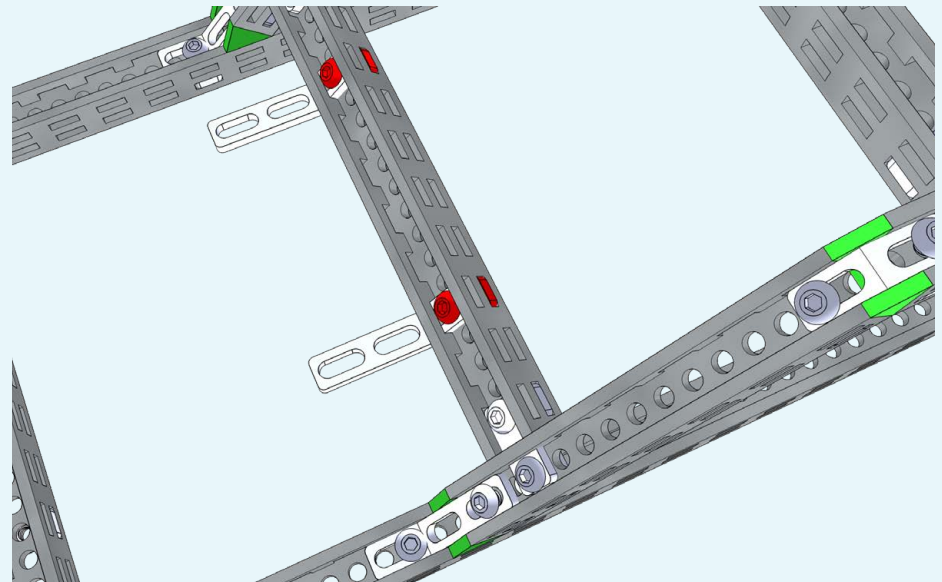

2

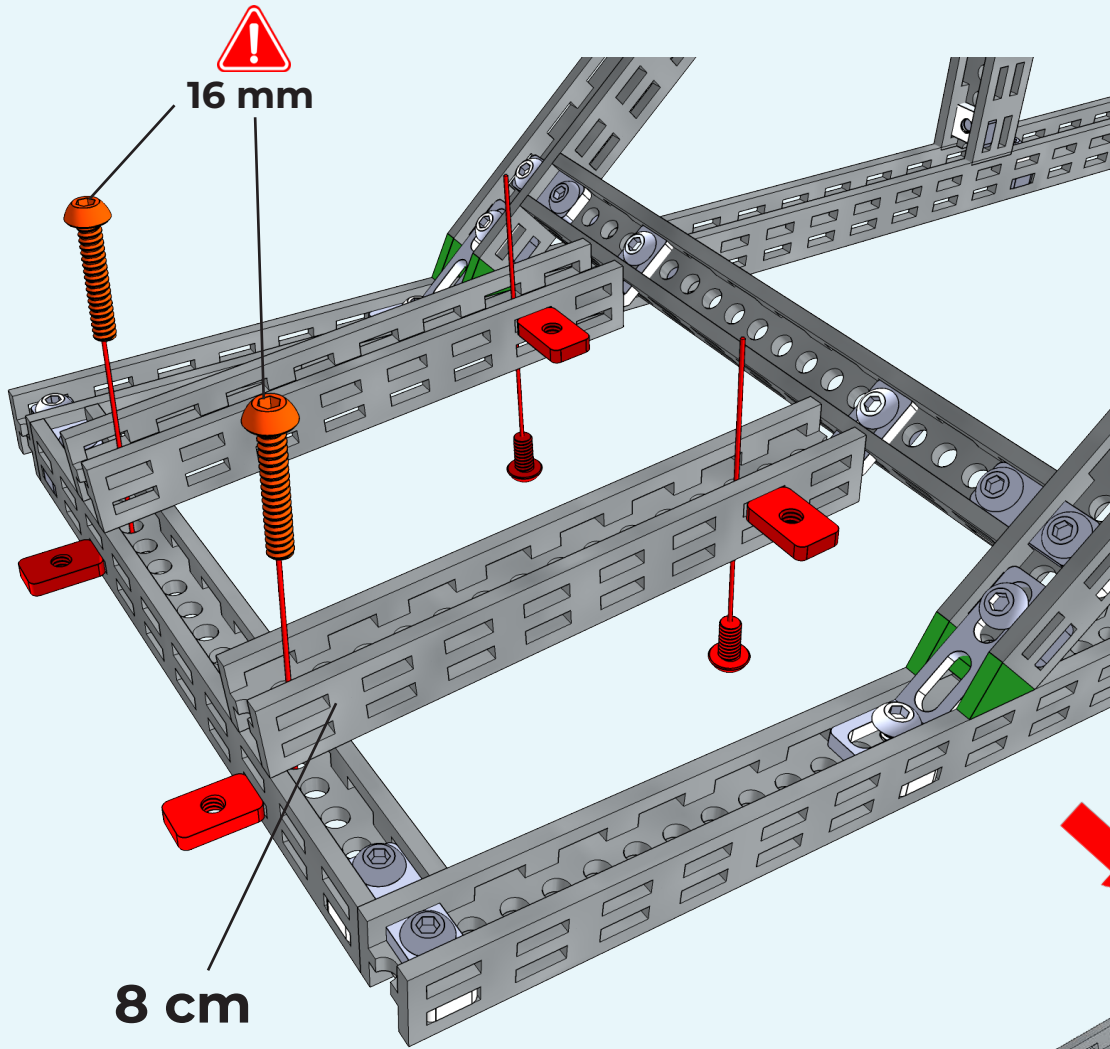

- 2x
Bolt M3x6
- 2x
Bolt M3x16
- 4x
Nut M3 6x10

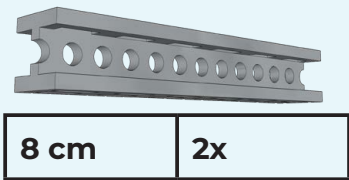

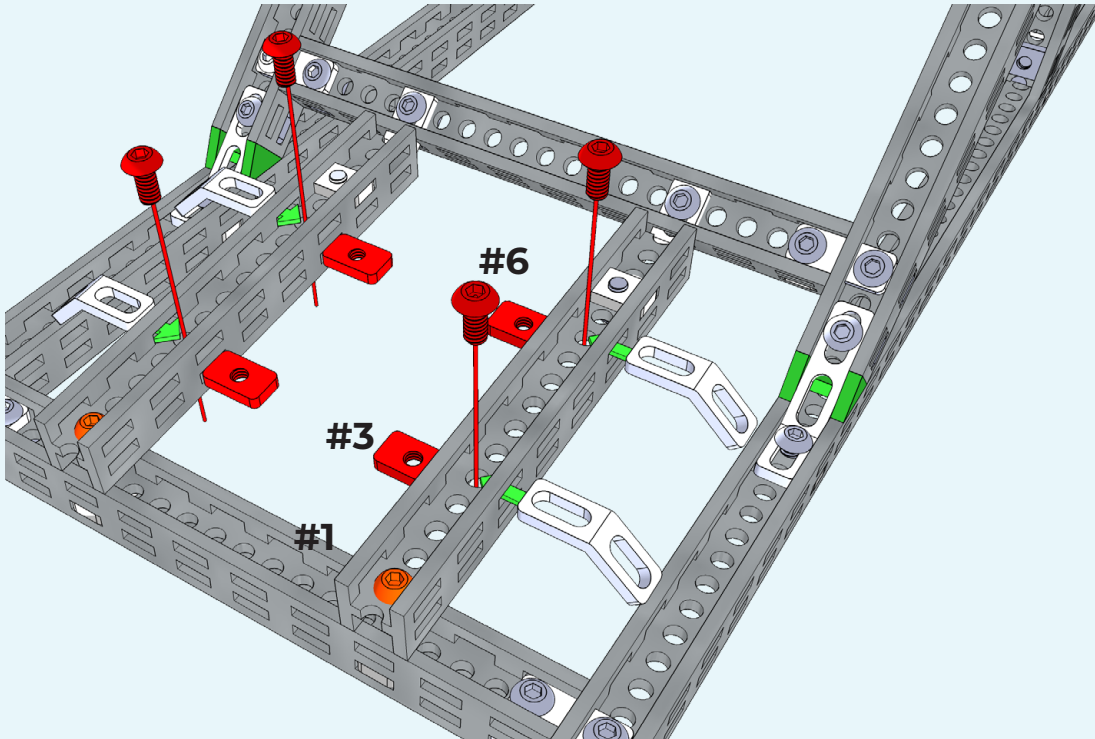

- 4x Bolt M3x6
- 4x Nut M3 6x10
- 4x 2-hole 45 bracket

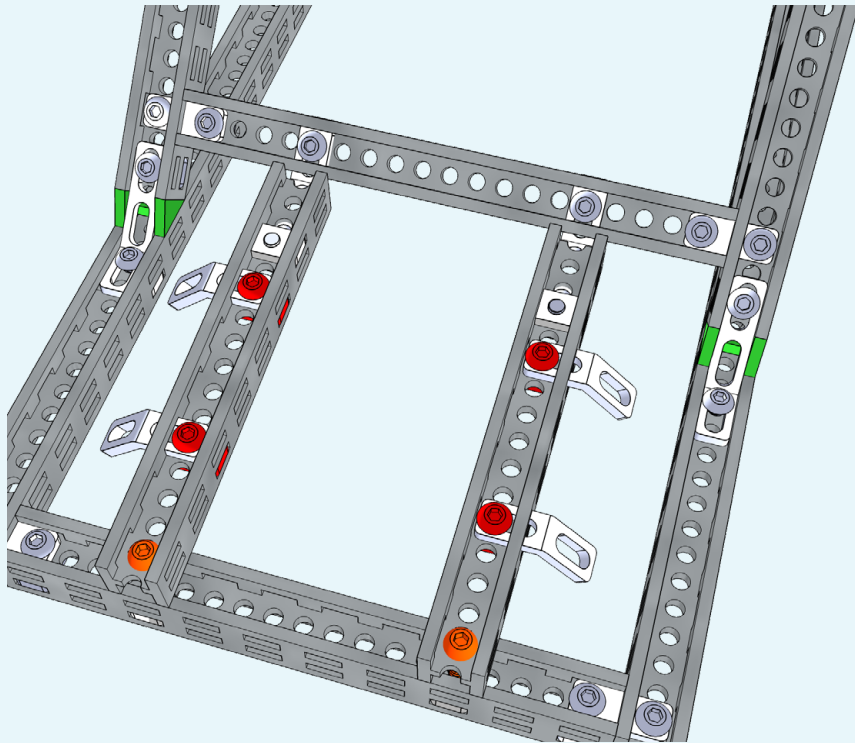
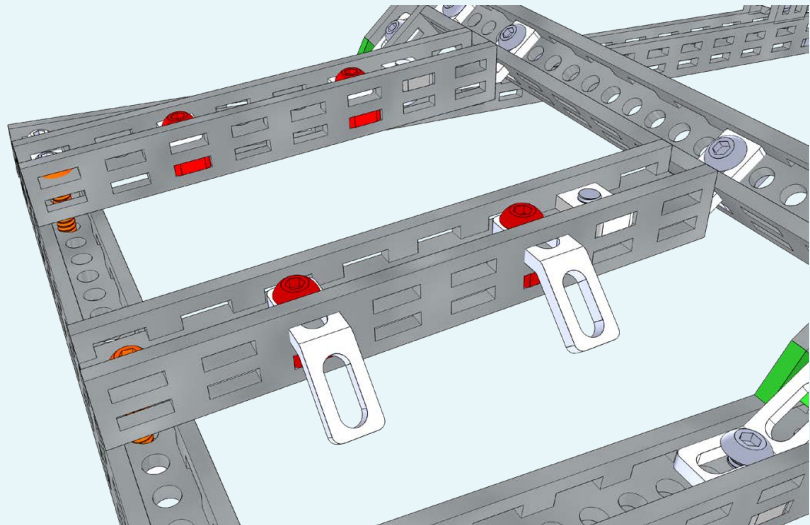

4

- 2x

Bolt M3x6
- 2x

Nut M3 6x10

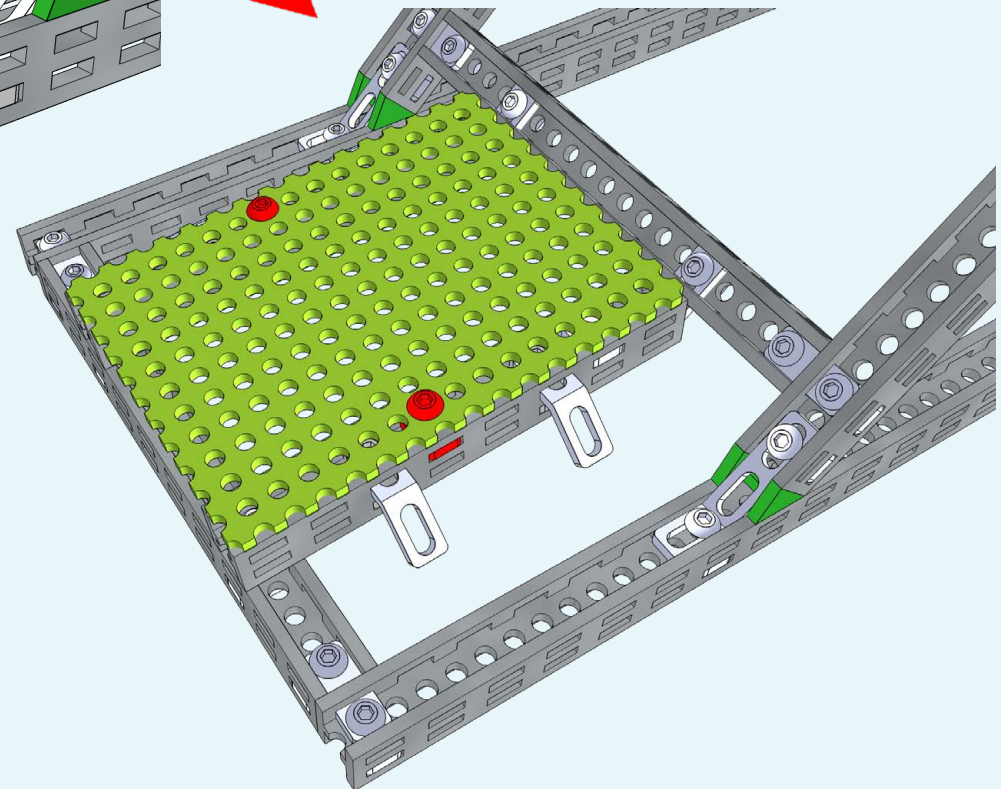
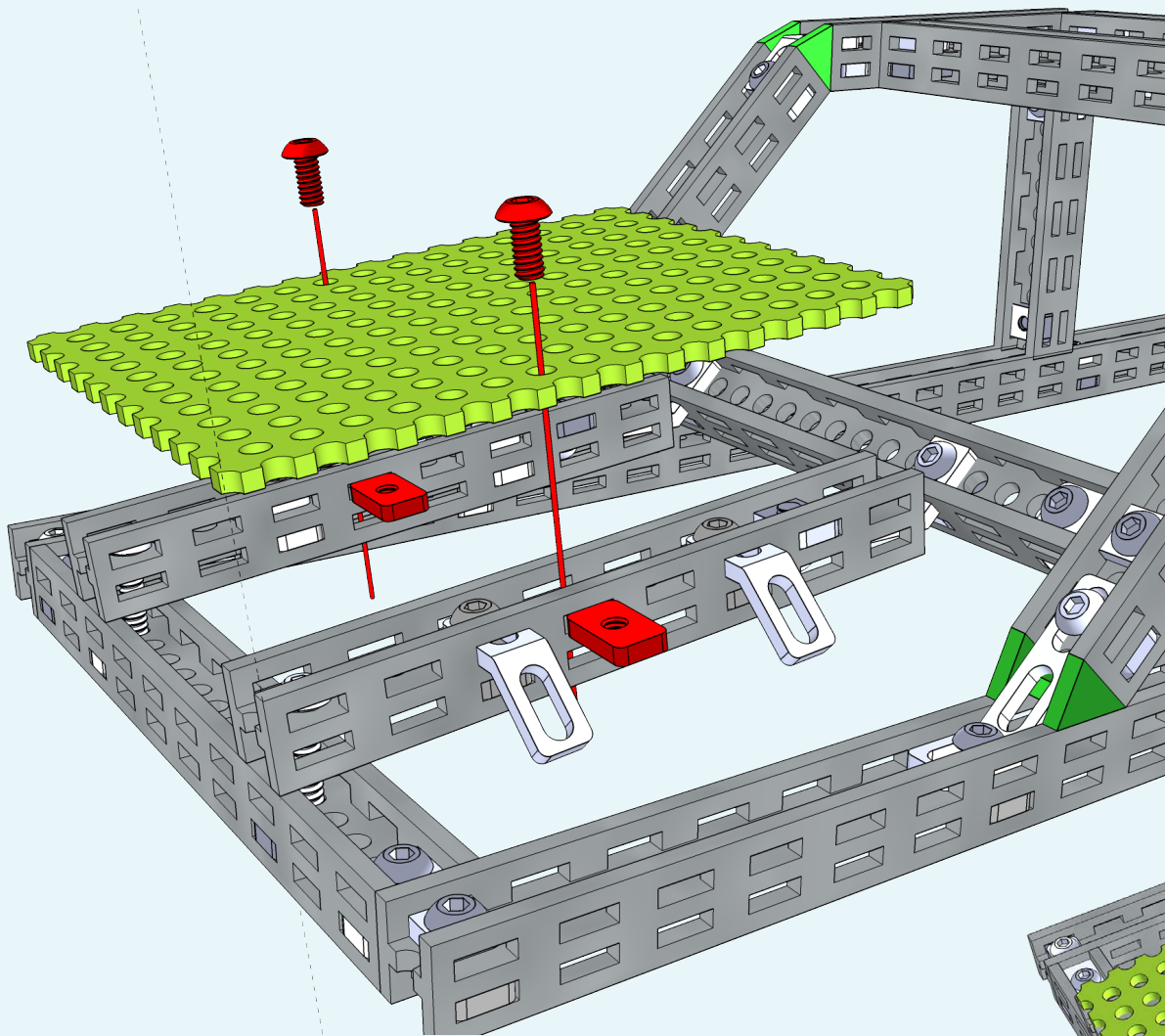
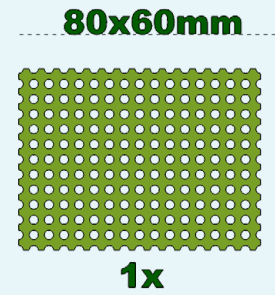

5

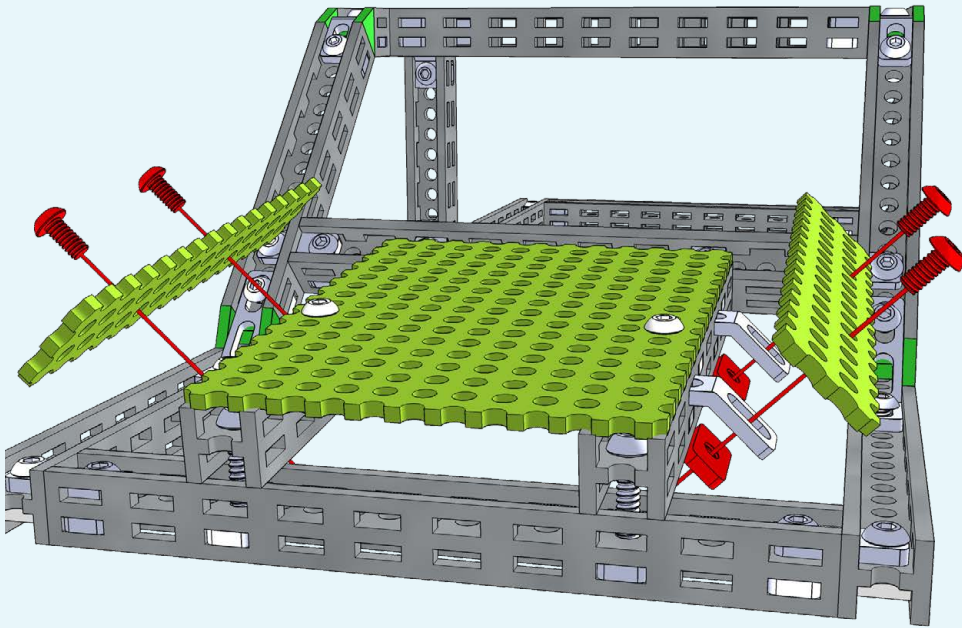

4x



Bolt M3x6

4x

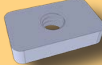

Nut M3 6x10

80x15mm

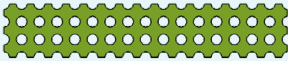

2x

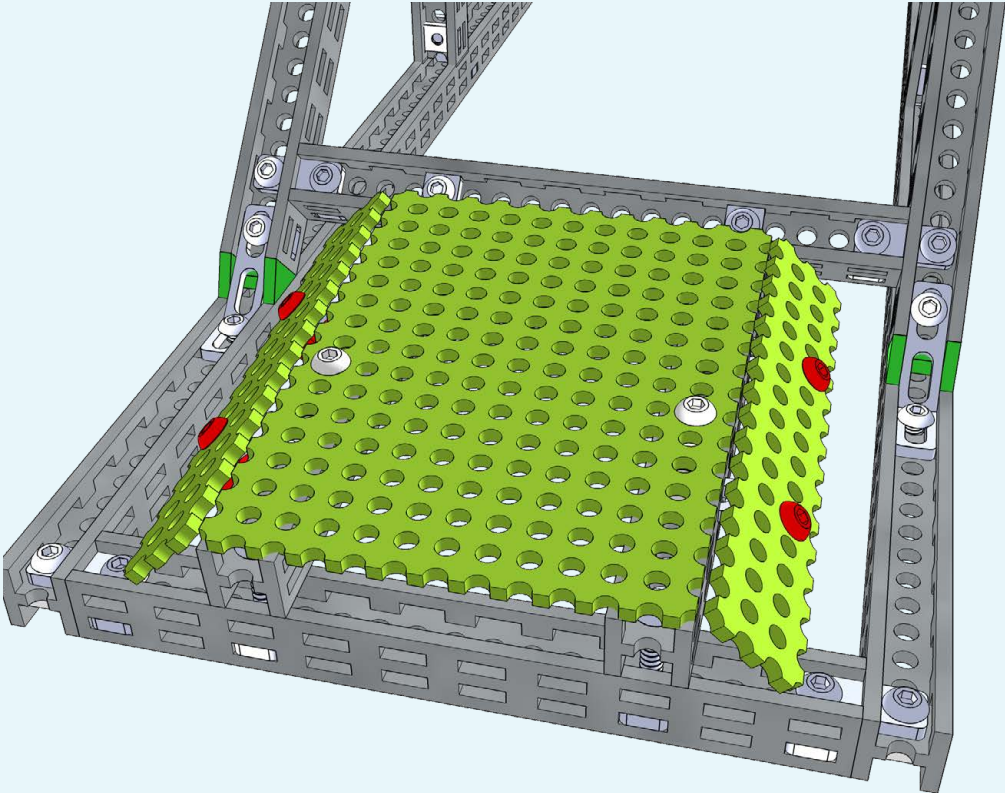
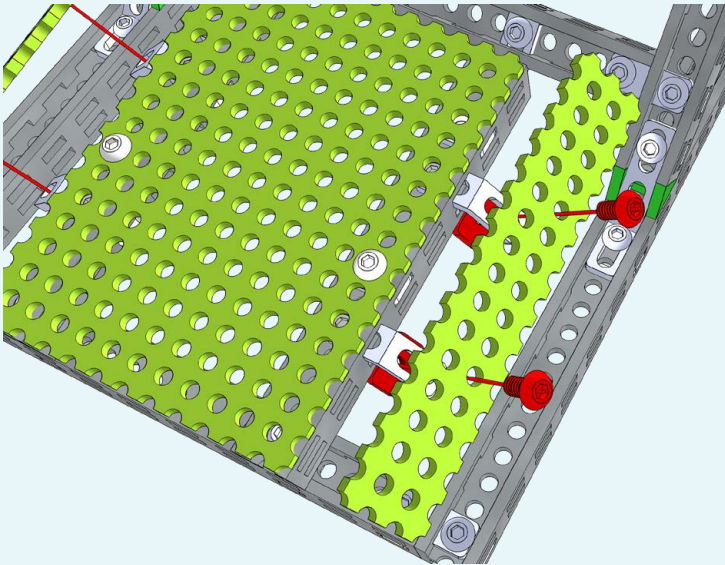

6

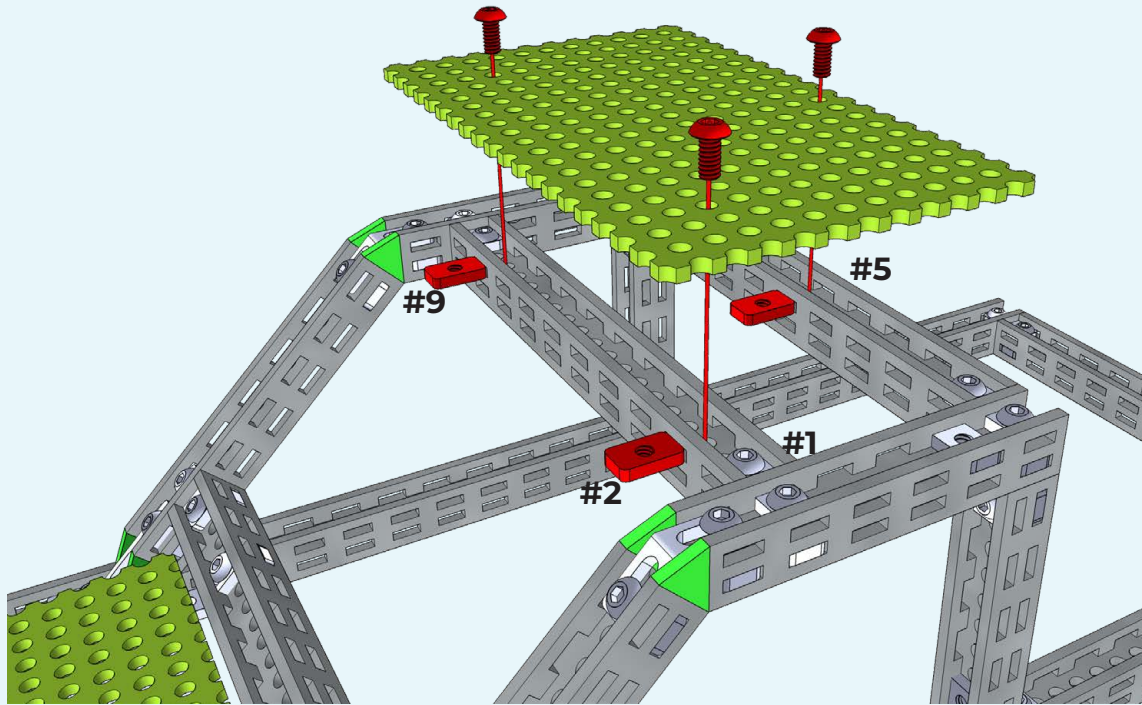

100x60mm

1x

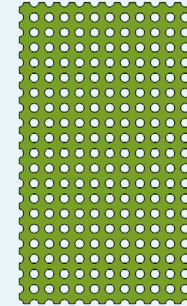

3x



Bolt M3x6

3x

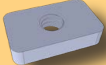

Nut M3 6x10

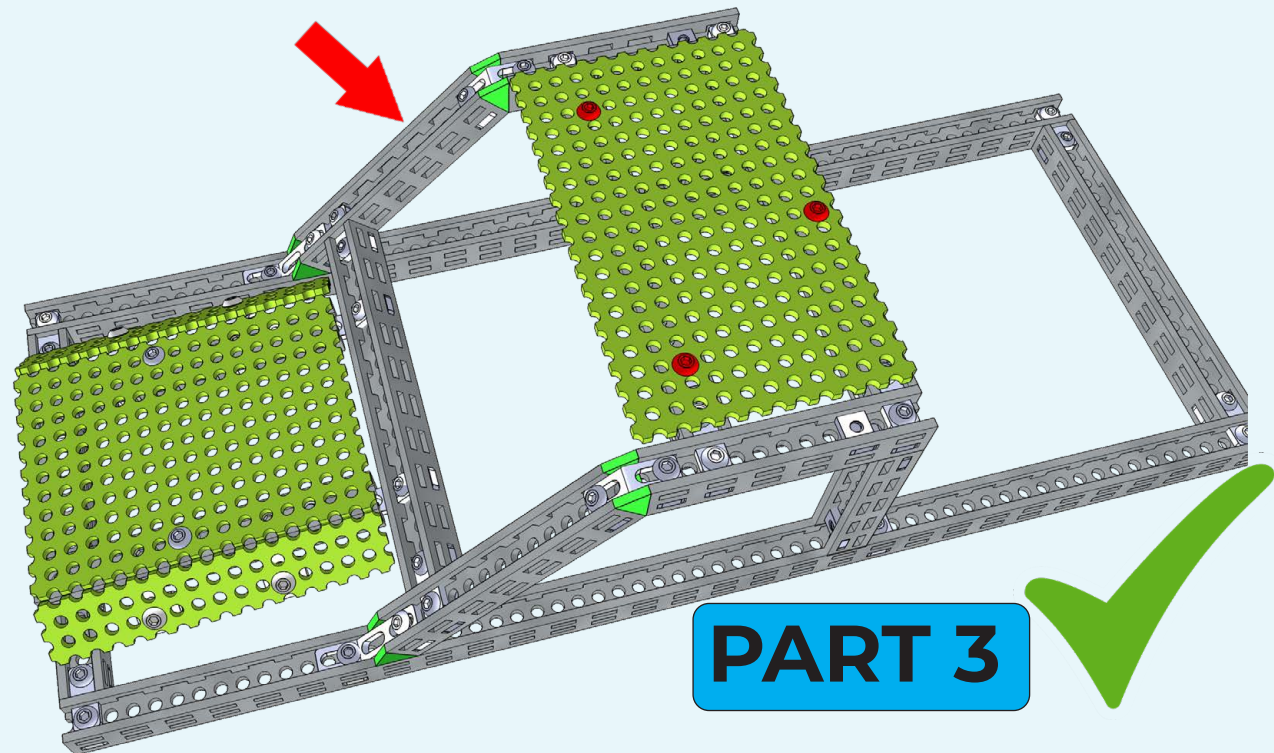

PART 3

PART 4

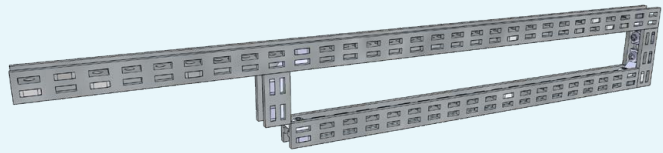

2x

16x	34x	4x	8x
Bolt M3x6	Nut M3 6x10	Nut M3 5.5x5.5	C-Bracket

	2x
	2x
	2x
	2x

1

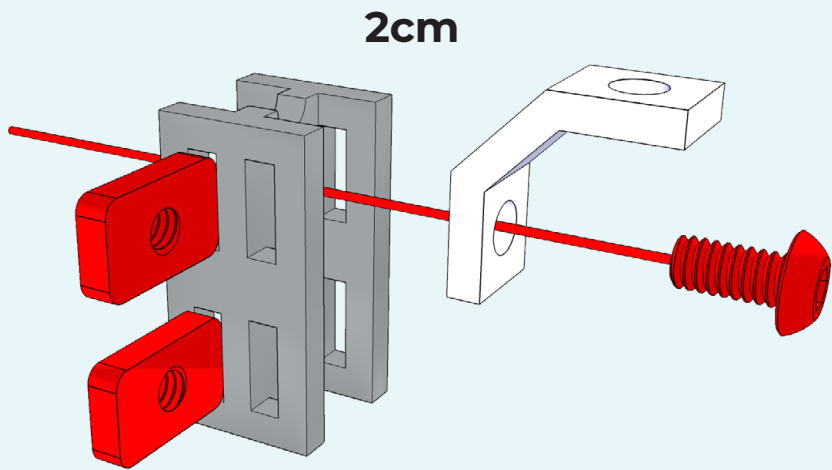

2x

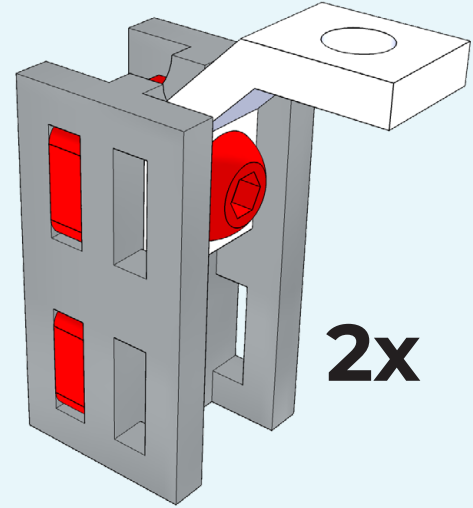

2x	4x	2x
Bolt M3x6	Nut M3 6x10	C-Bracket

	2x
	2x

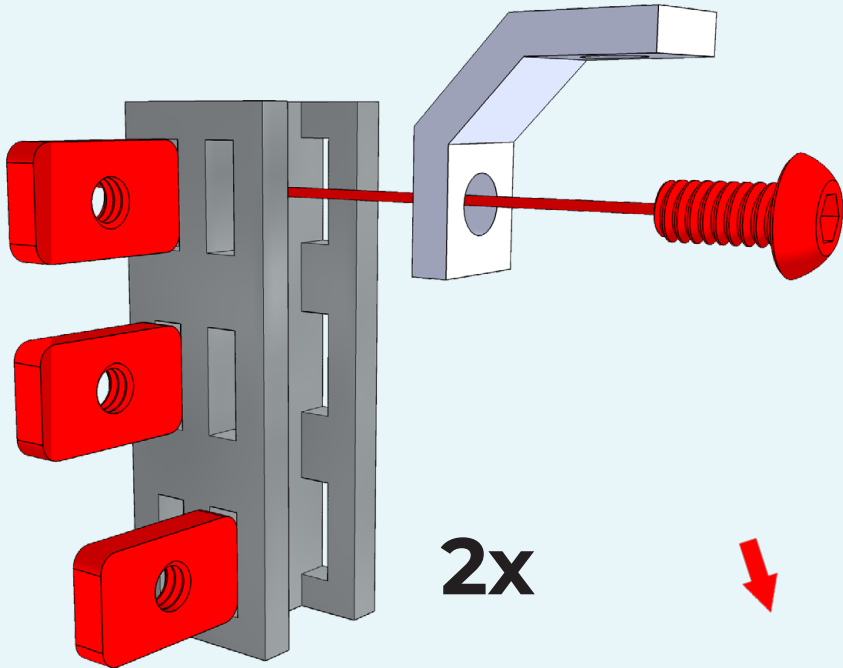

2x

3cm

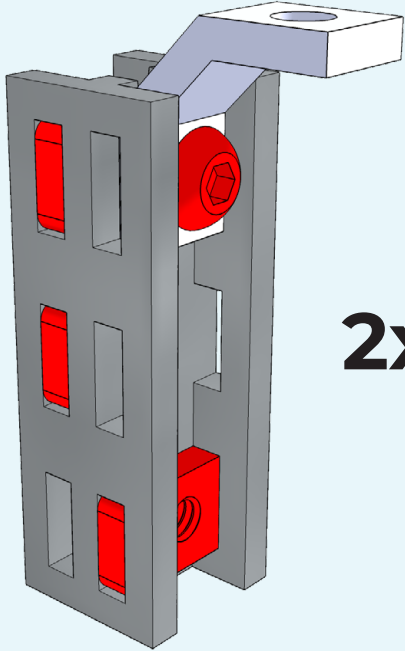

2x

2x Bolt M3x6 6x Nut M3 6x10 2x C-Bracket

3

29cm

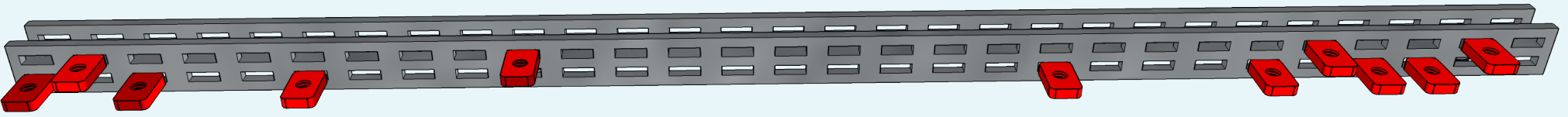

2x

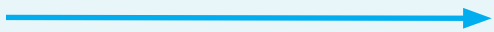

#1 #2 #3 #6 #10 #10 #6 #5 #4 #3 #2



2x

4

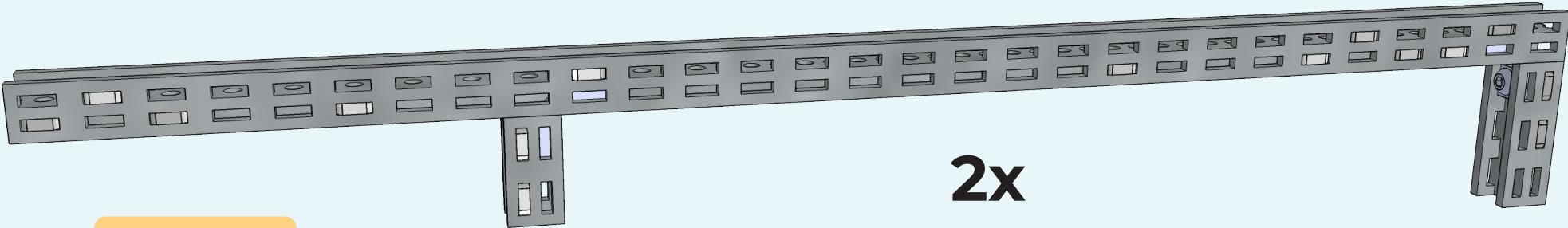
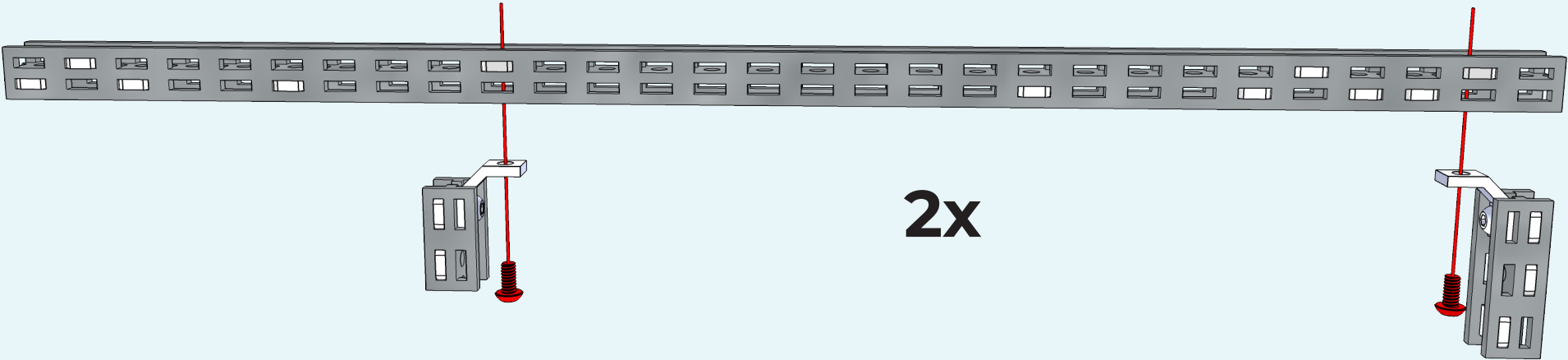

5

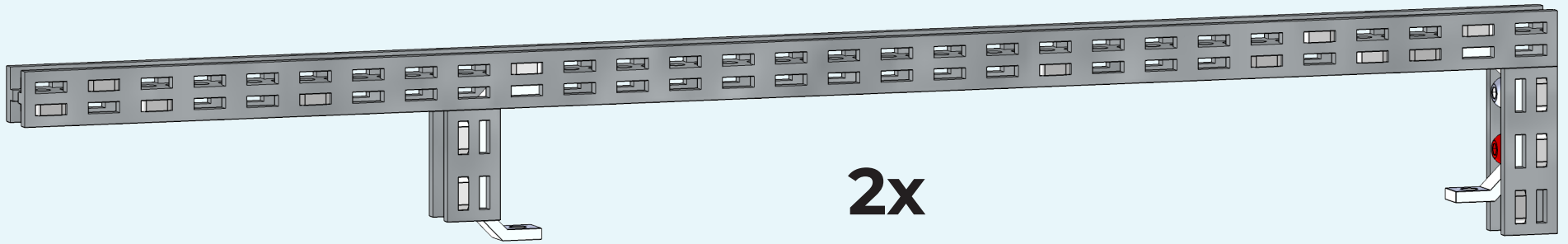
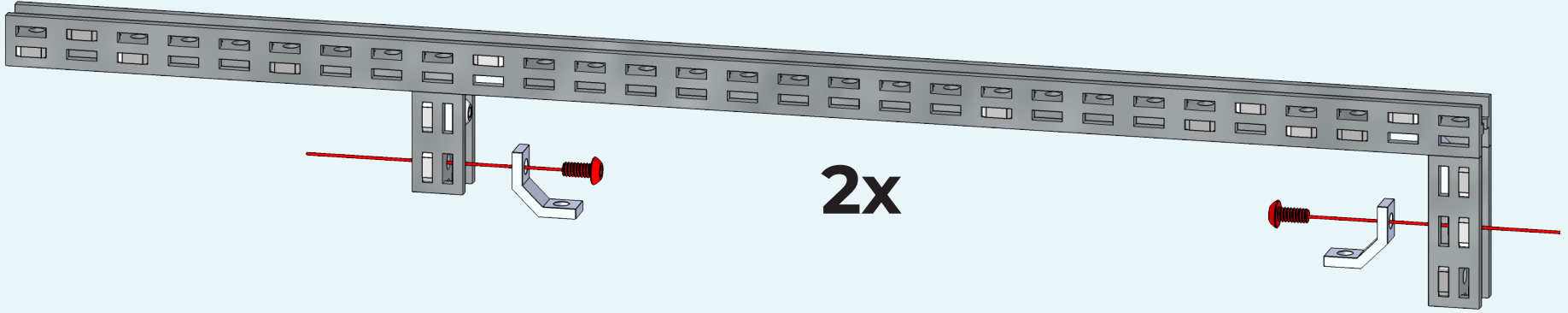

4x



Bolt M3x6

4x



C-Bracket

6

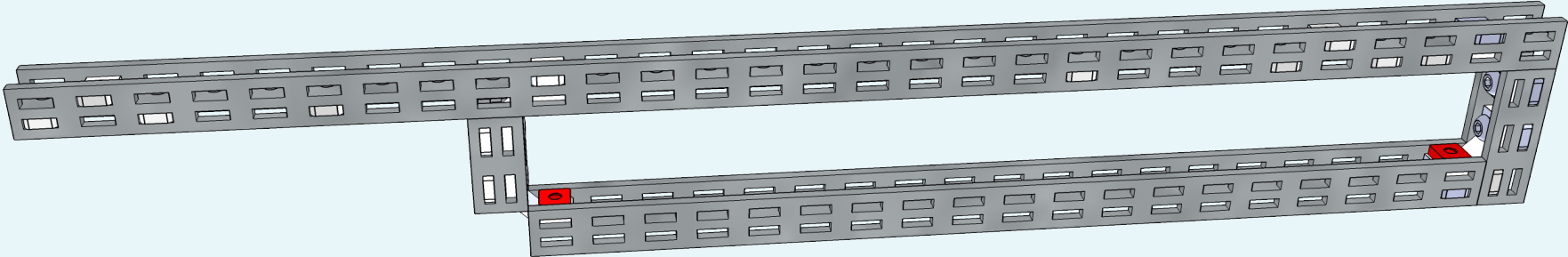
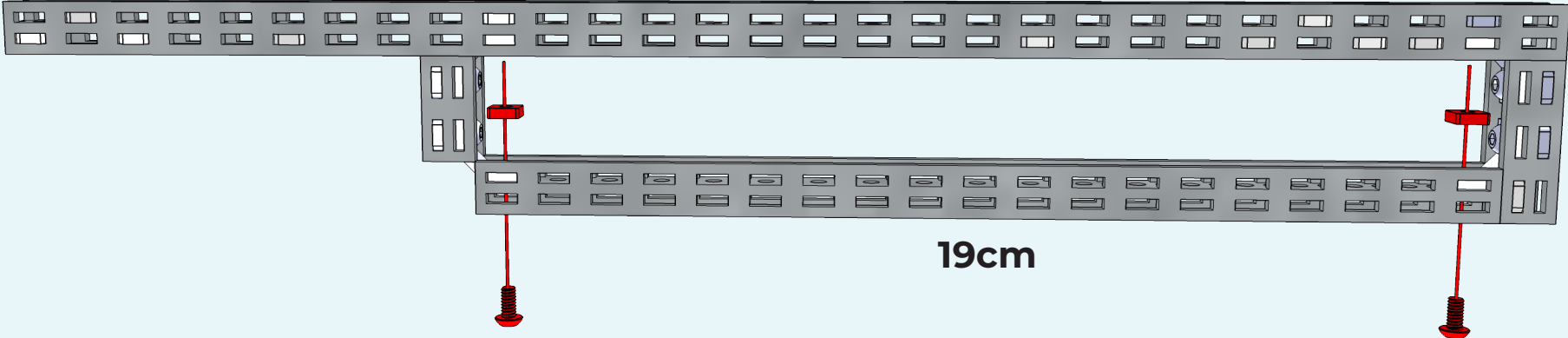

4x



Bolt M3x6

4x



Nut M3 5.5x5.5

7

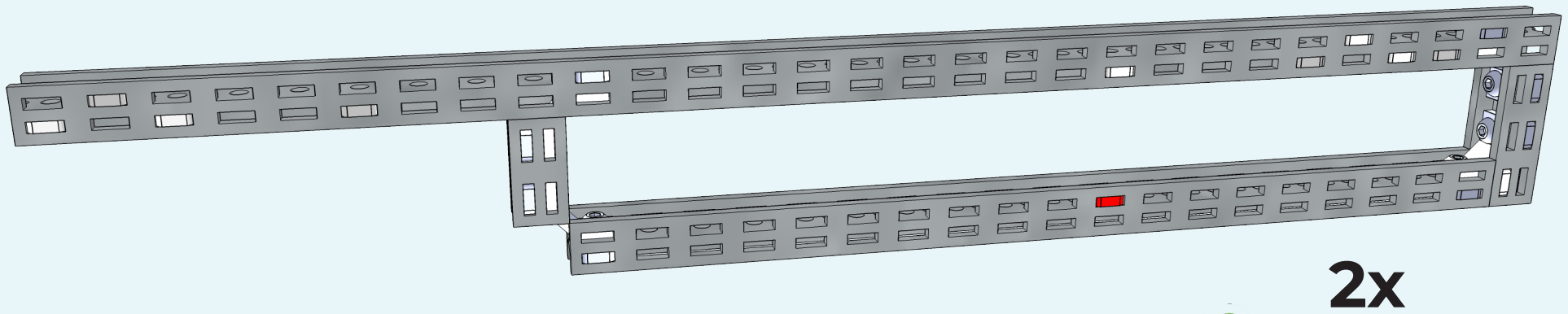
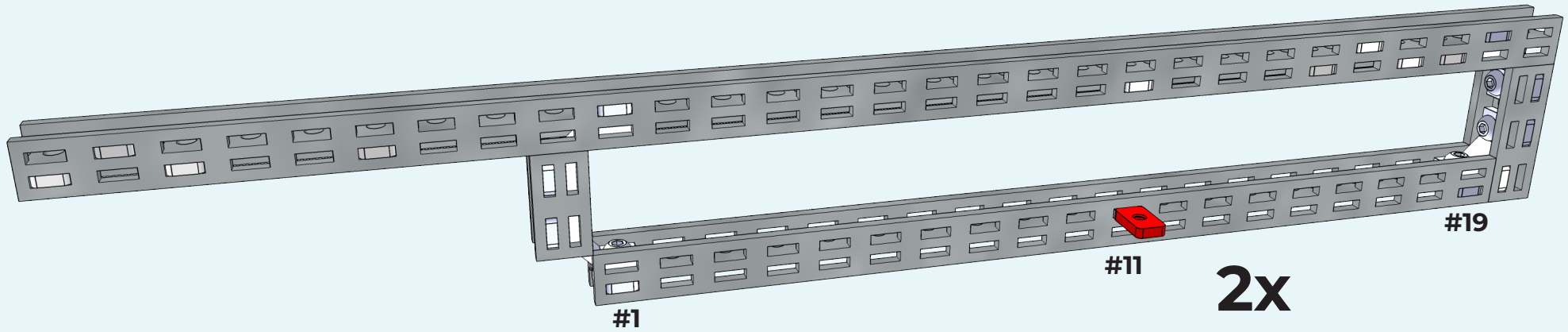

PART 4



PART 5

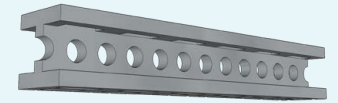
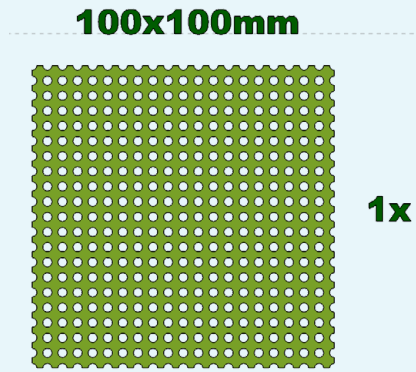

10 cm	2x
12 cm	2x

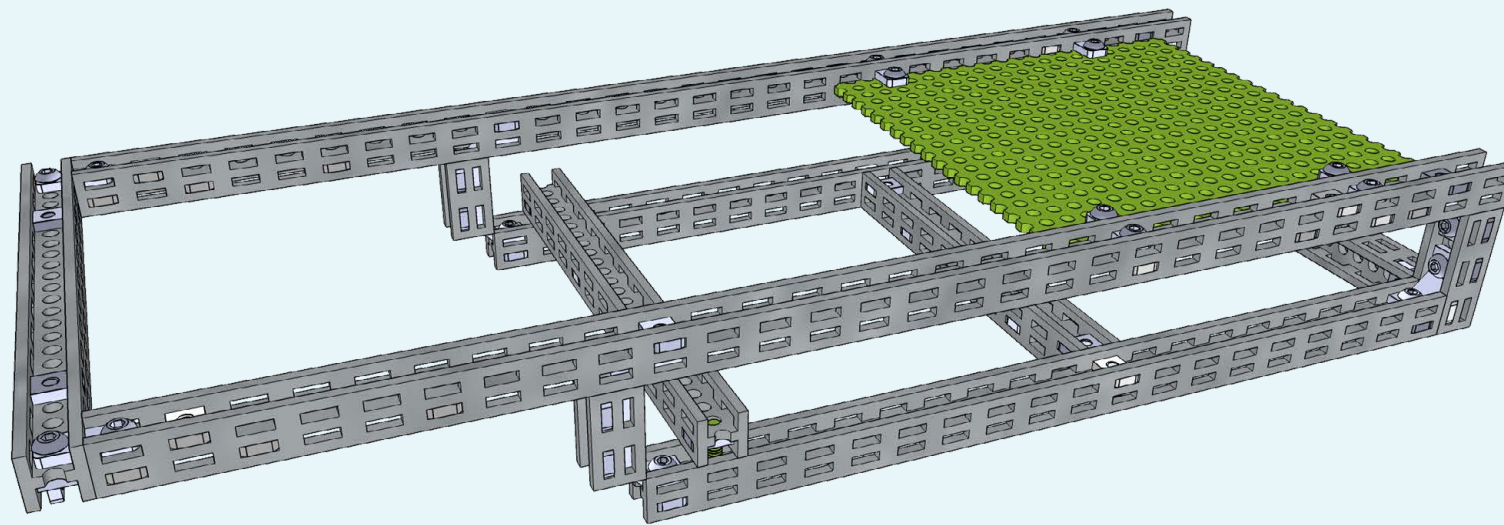

22x



Bolt M3x6

2x

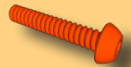

Bolt M3x16

18x

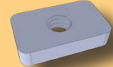

Nut M3 6x10

10x



2-hole simple bracket

1x



L-twisted bracket

1x



L-twisted mirror bracket

1

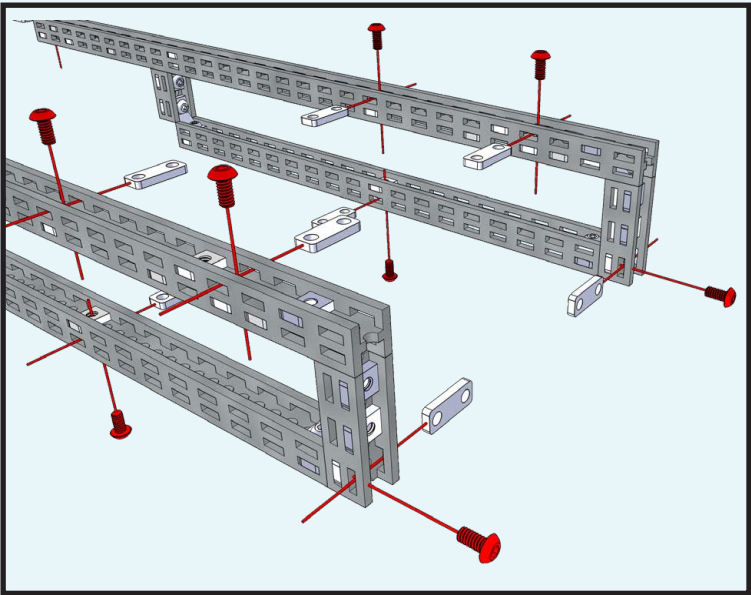
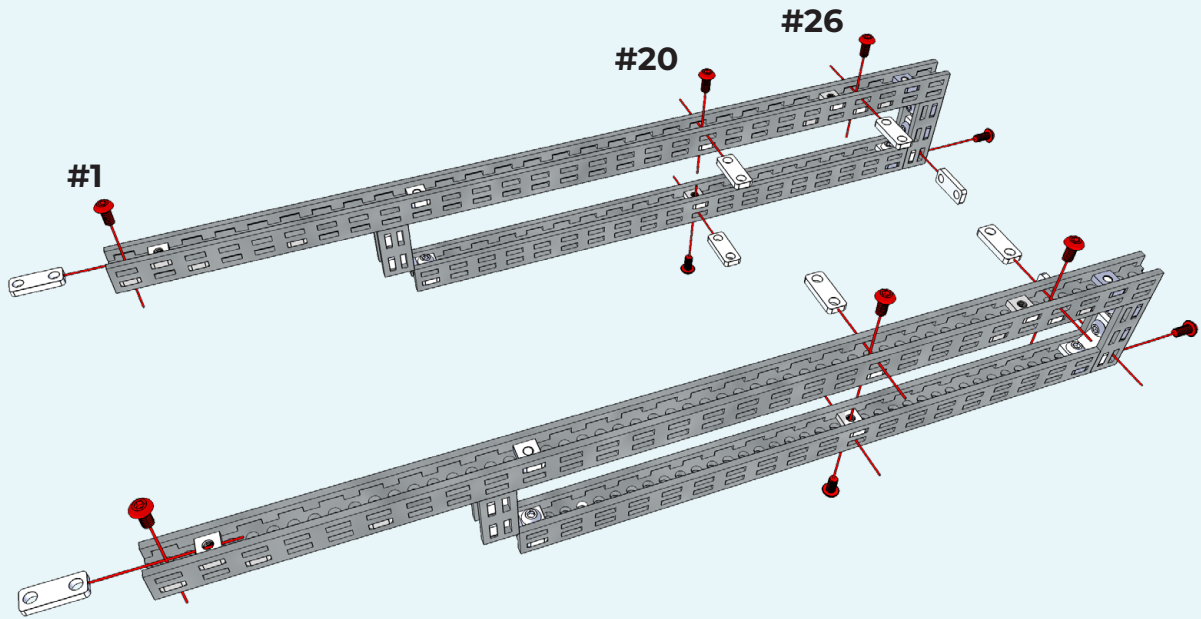

10x
Bolt M3x6

10x
2-hole simple bracket

This block contains the parts list for the assembly: 10 bolts (M3x6) and 10 2-hole simple brackets. It includes small images of each component.

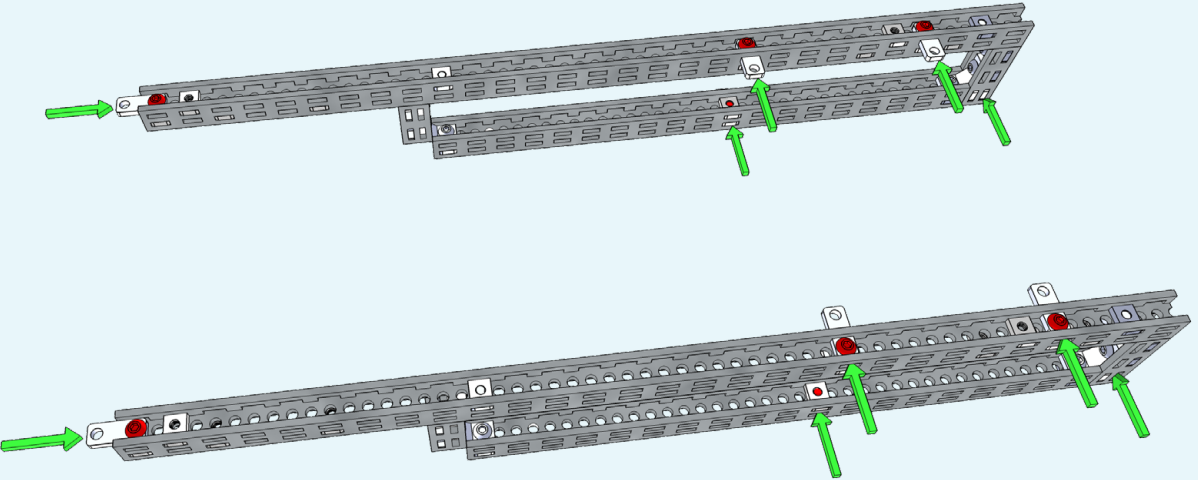
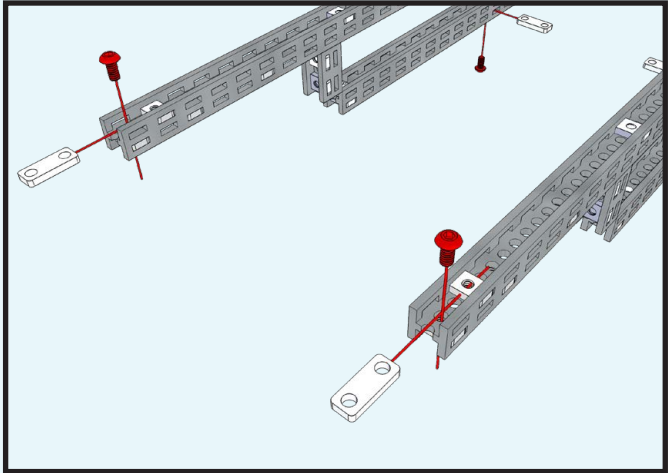

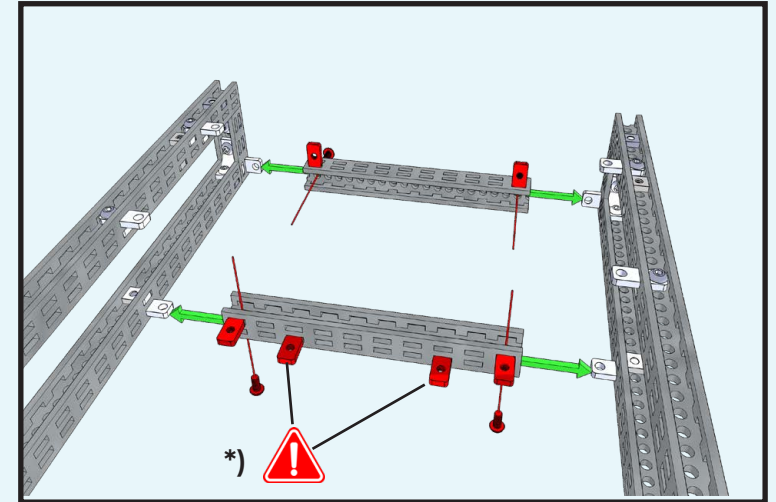
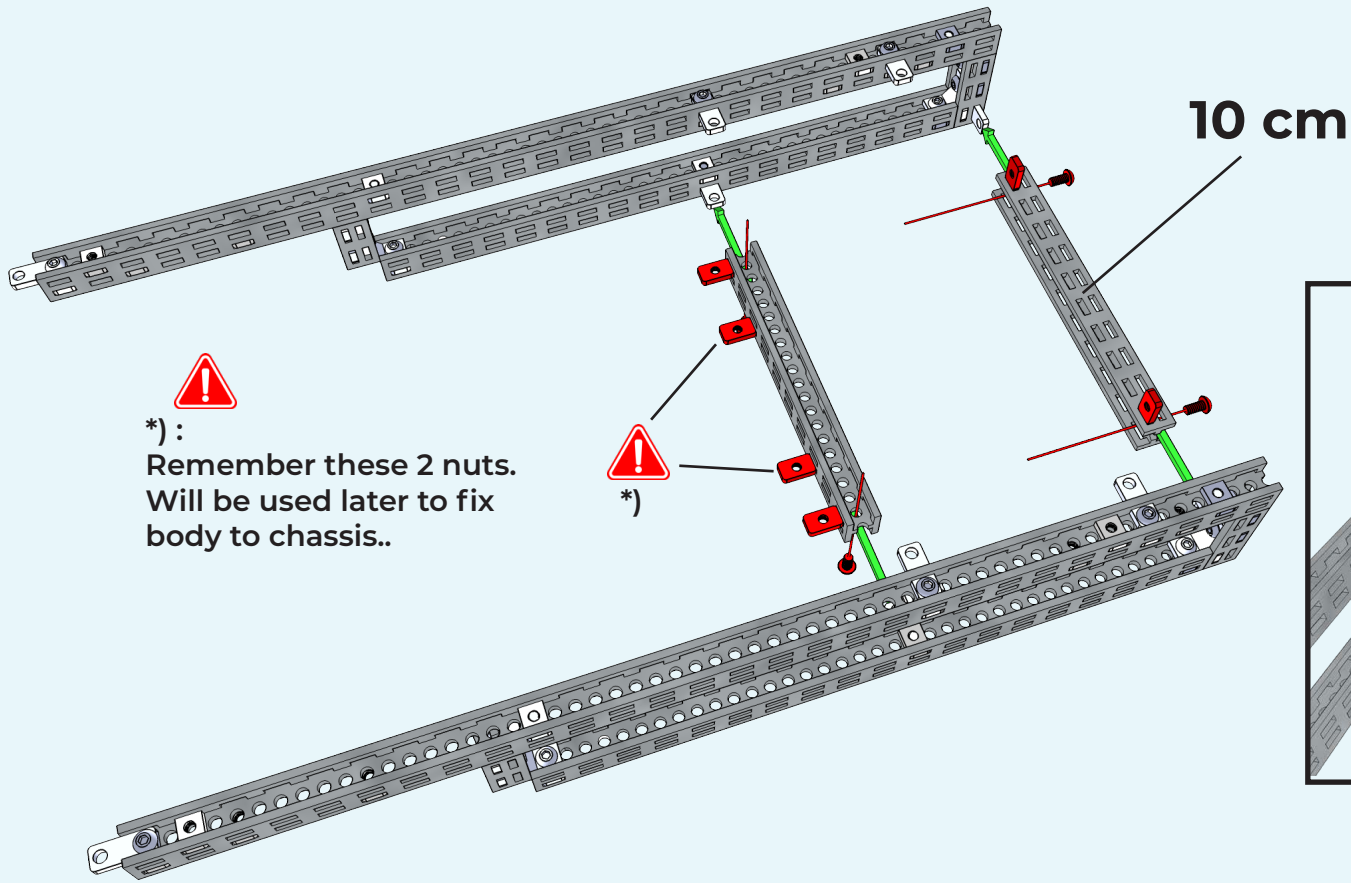

4x
Bolt M3x6

6x
Nut M3 6x10

10 cm 2x

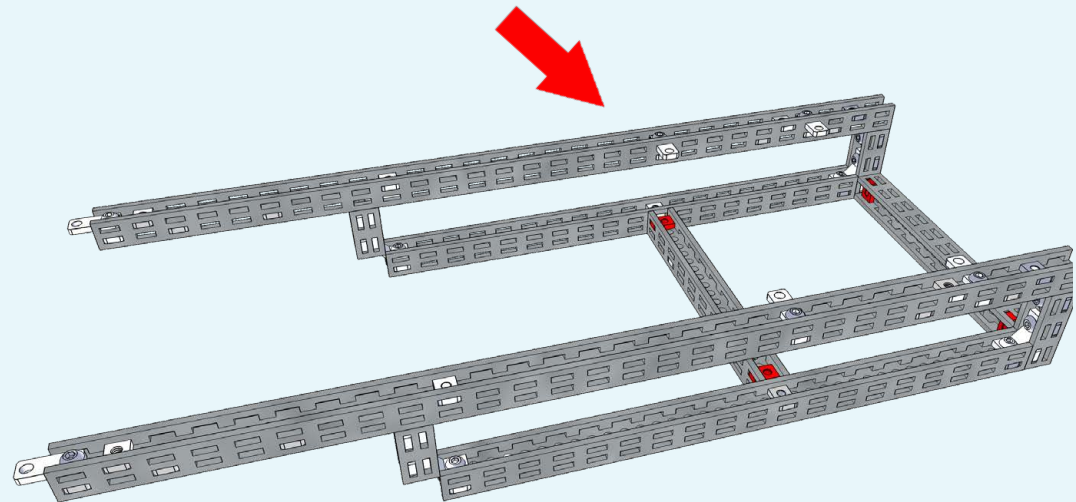

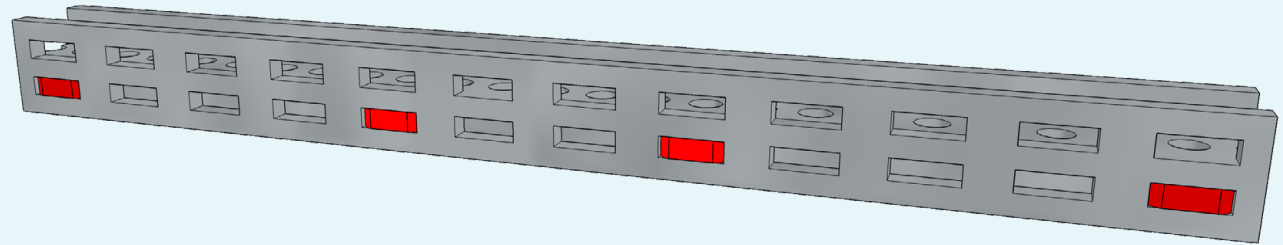
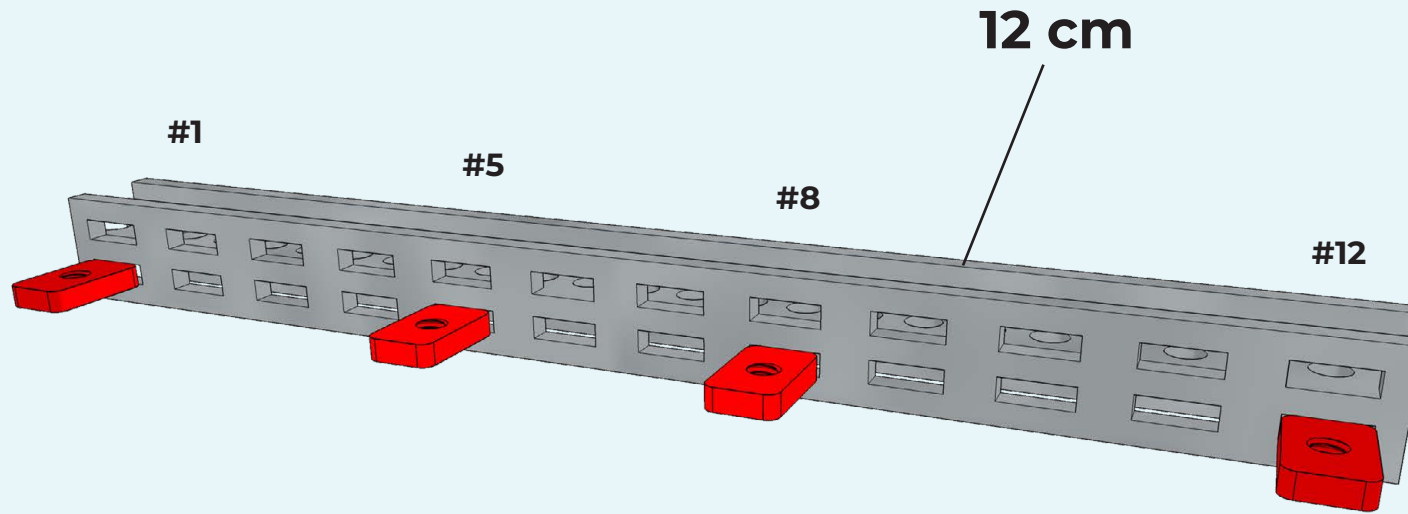

4x



Nut M3 6x10

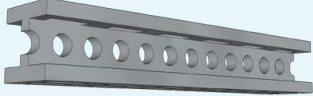

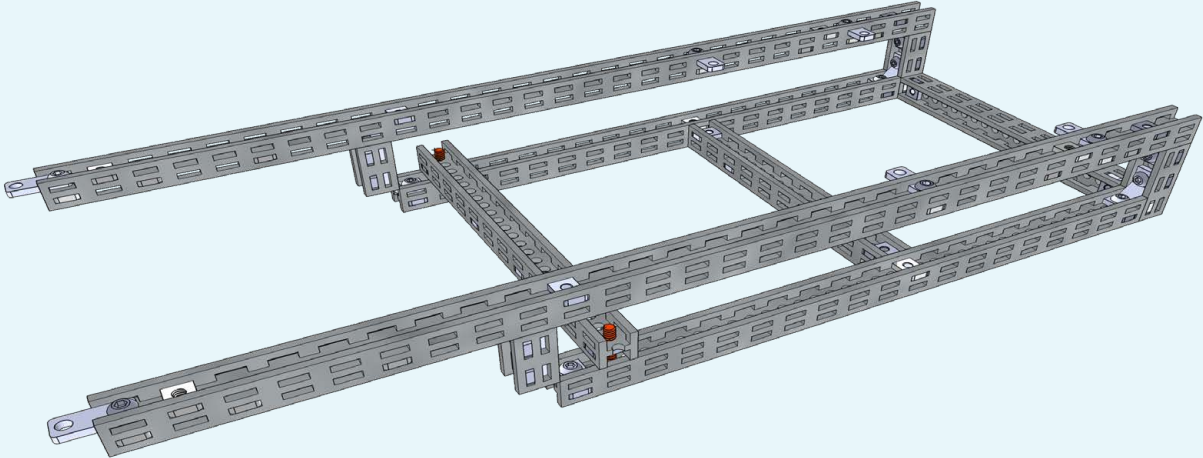
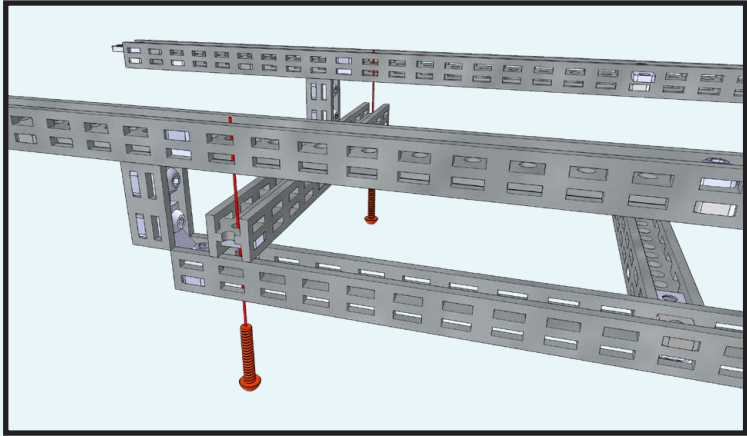
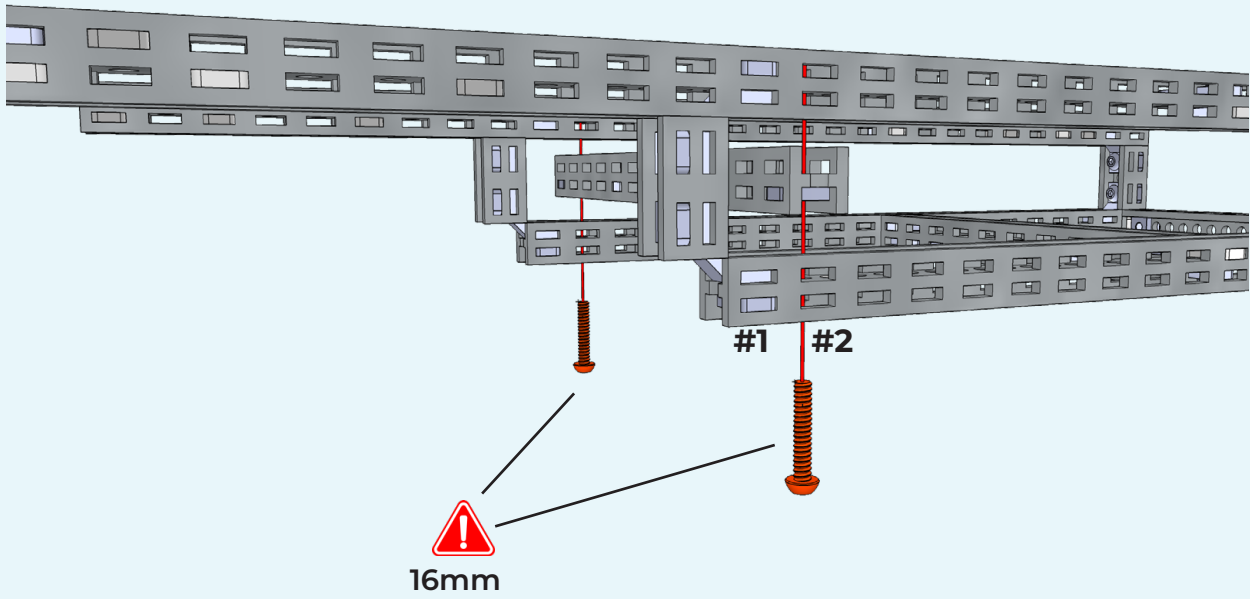

12 cm	1x
-------	----

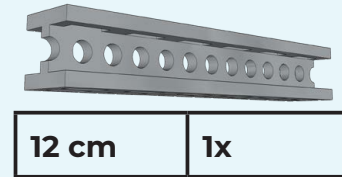
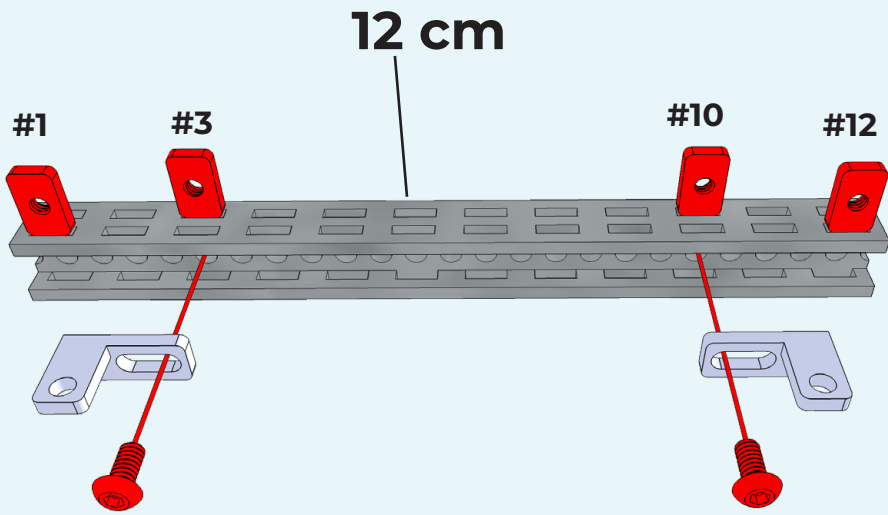

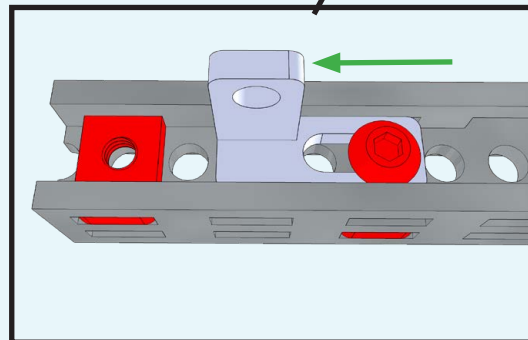
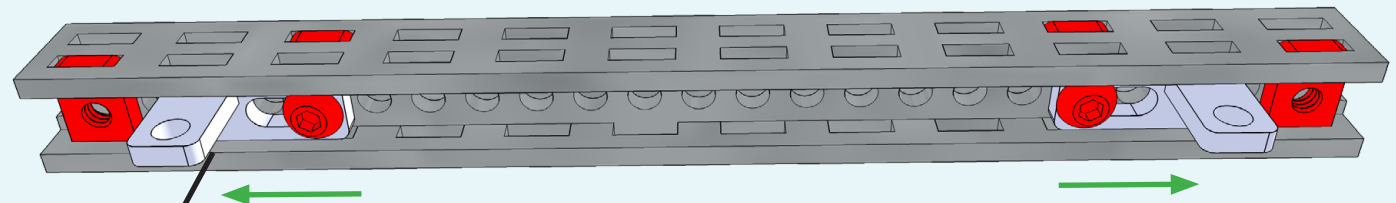

- 4x Bolt M3x6
- 4x Nut M3 6x10
- 1x L-twisted bracket
- 1x L-twisted mirror bracket



 The L-brackets should be placed as far to the sides as they can.

6

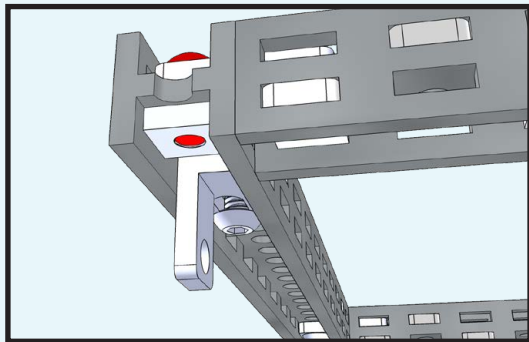
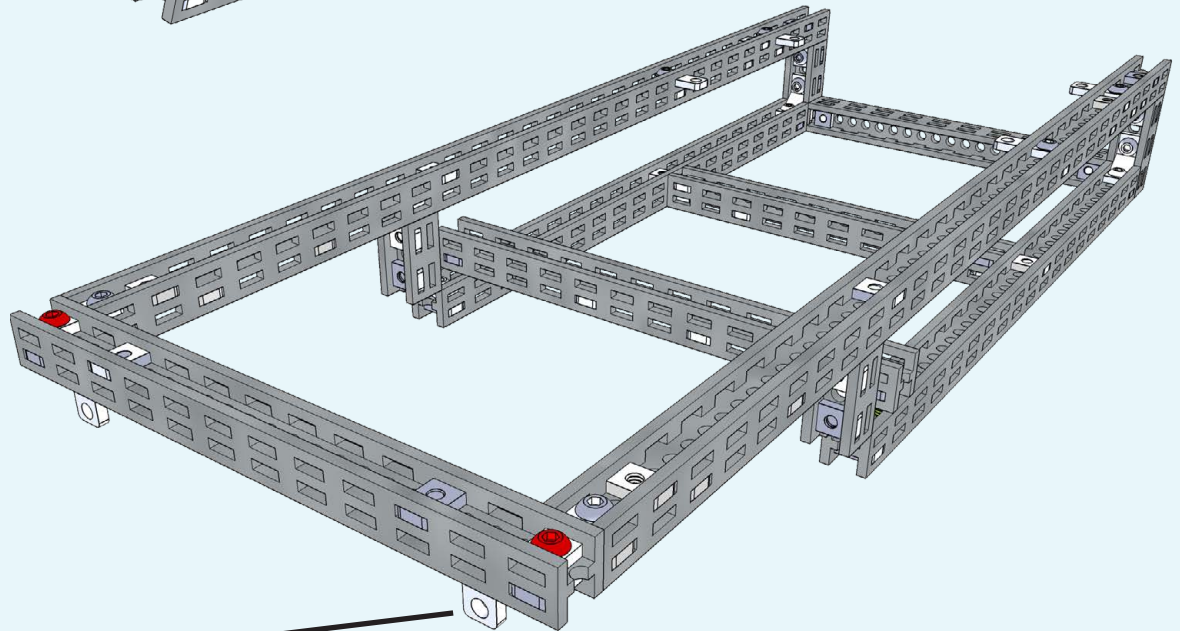
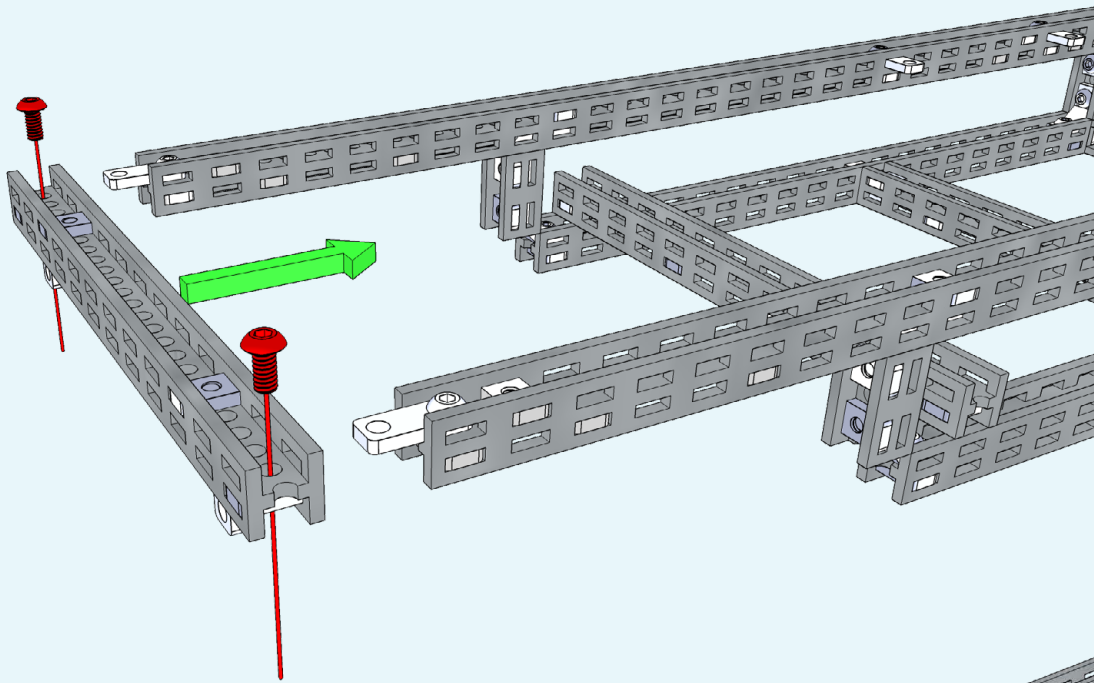

7

100x100mm

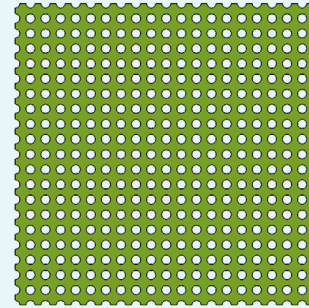

1x

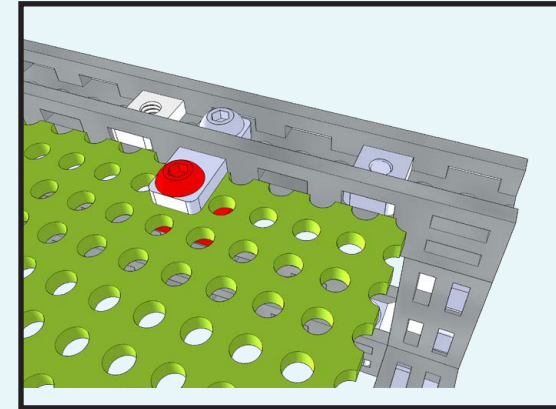
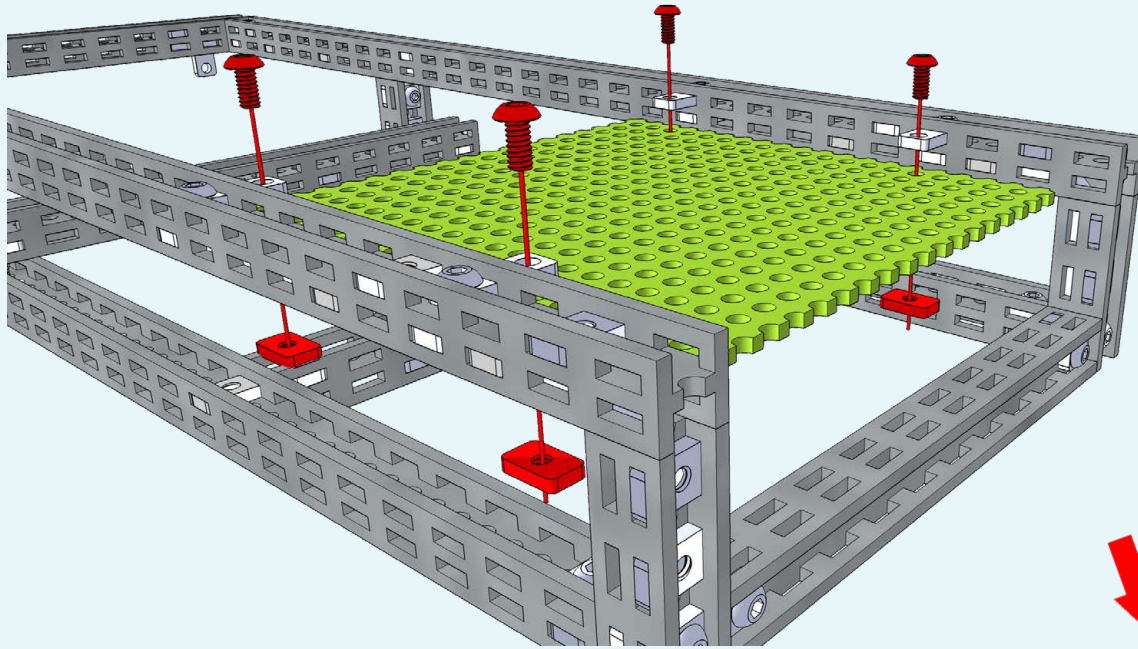

4x



Bolt M3x6

4x

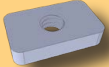

Nut M3 6x10

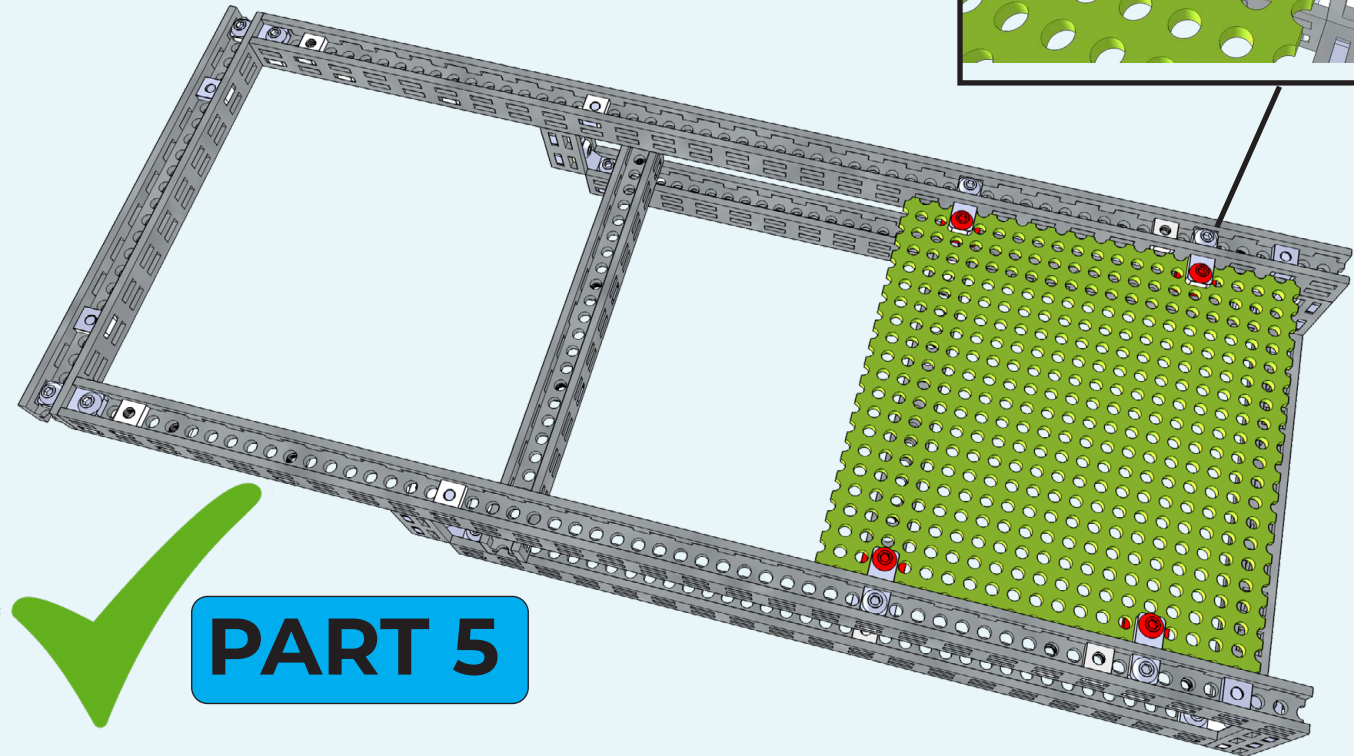

PART 5

PART 6

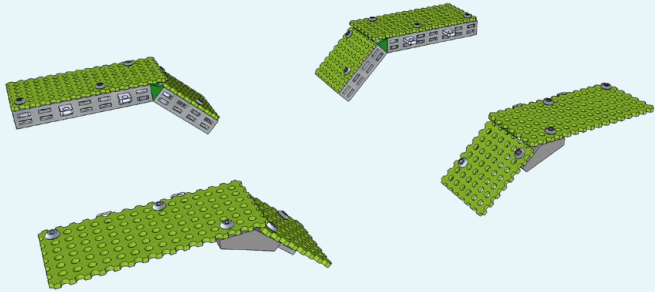

36x Bolt M3x6

28x Nut M3 6x10

8x 2-hole simple bracket

4x 2-hole 45 bracket

4x Double side filler

4x 45 degree plastic bracket

80x35mm

40x35mm

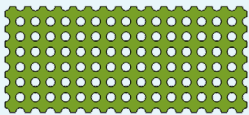

4x

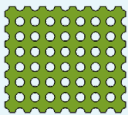

4x



4 cm	4x
7 cm	4x

8x Bolt M3x6

4x Double side filler

28x Nut M3 6x10

4x 2-hole 45 bracket



4 cm	4x
7 cm	4x

1

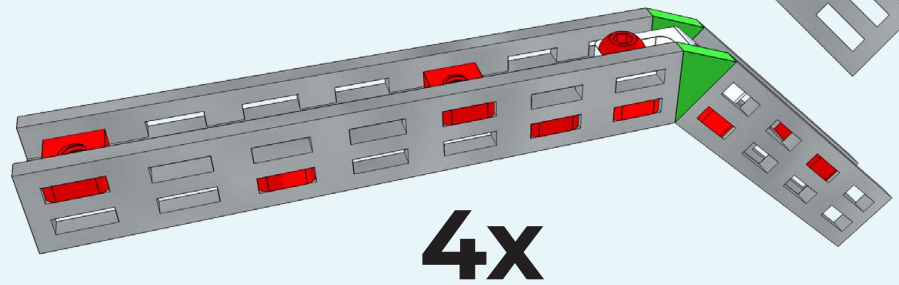
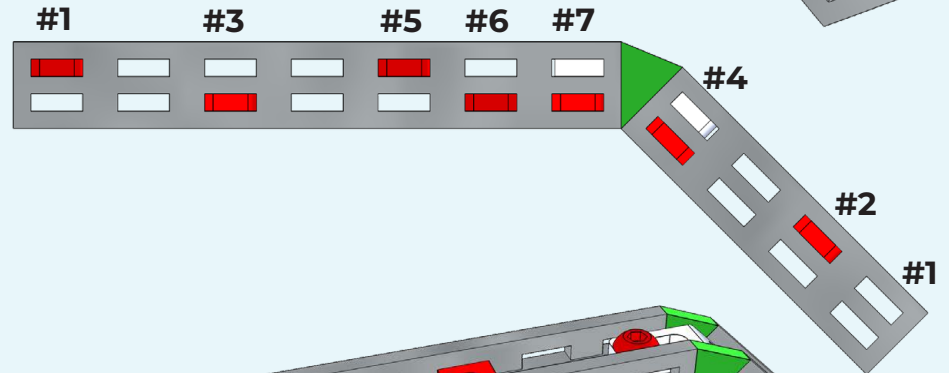
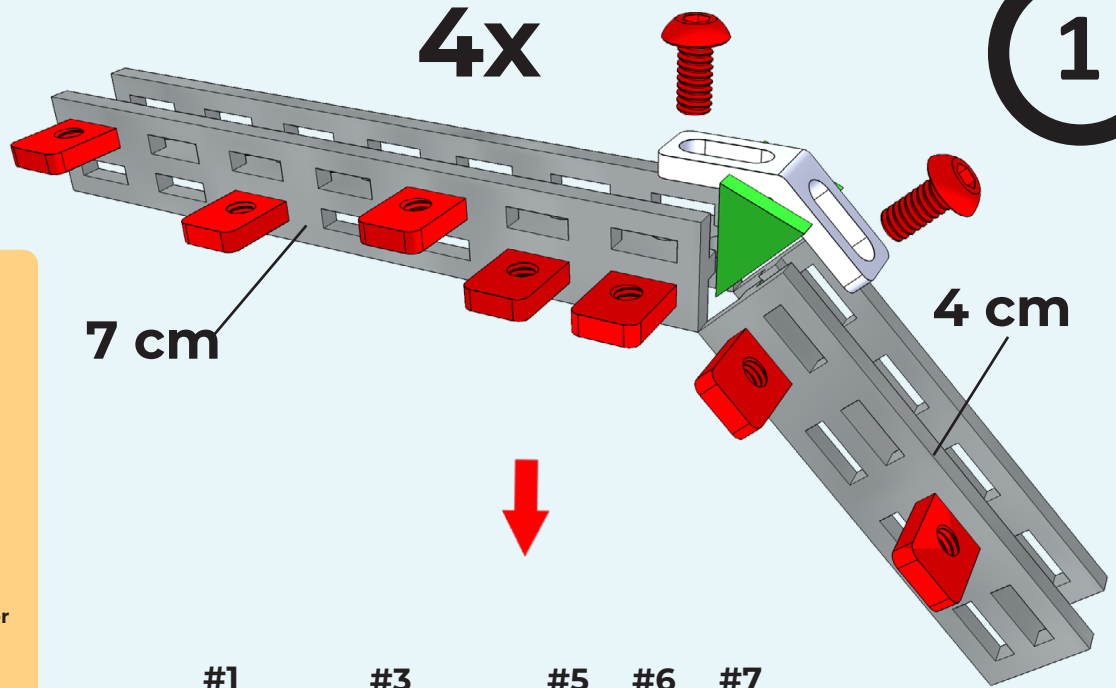

4x

2

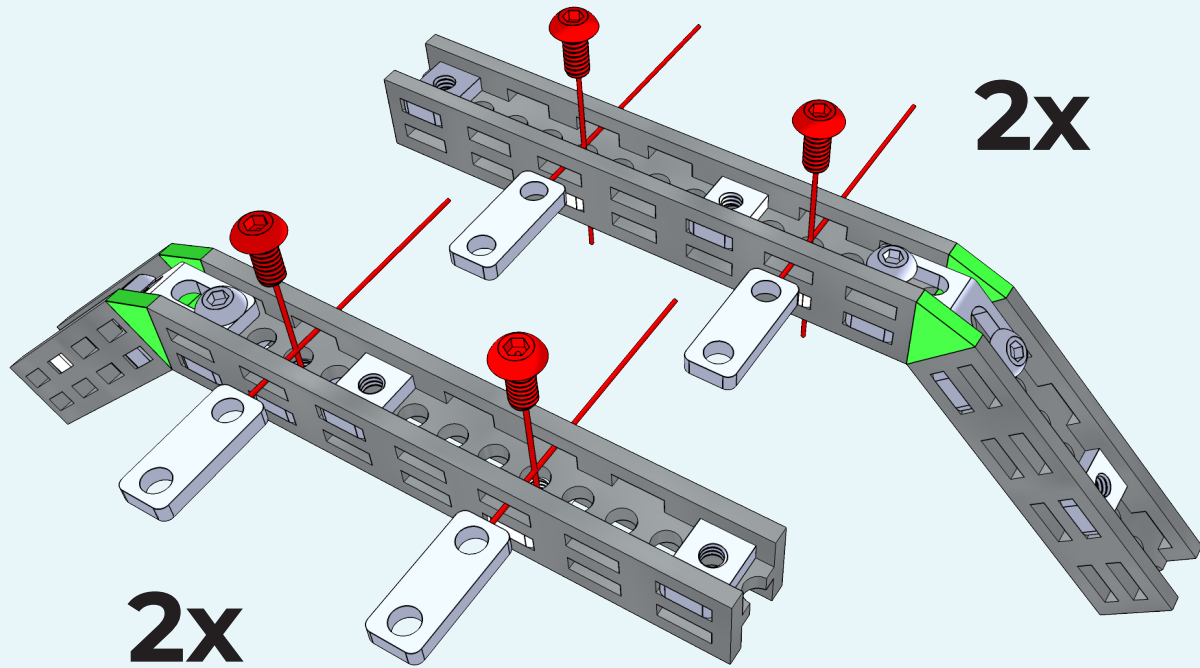

8x



Bolt M3x6

8x



2-hole simple bracket

This block lists the required parts for step 2: 8x Bolt M3x6 and 8x 2-hole simple bracket. Each part is accompanied by a small image of the component.

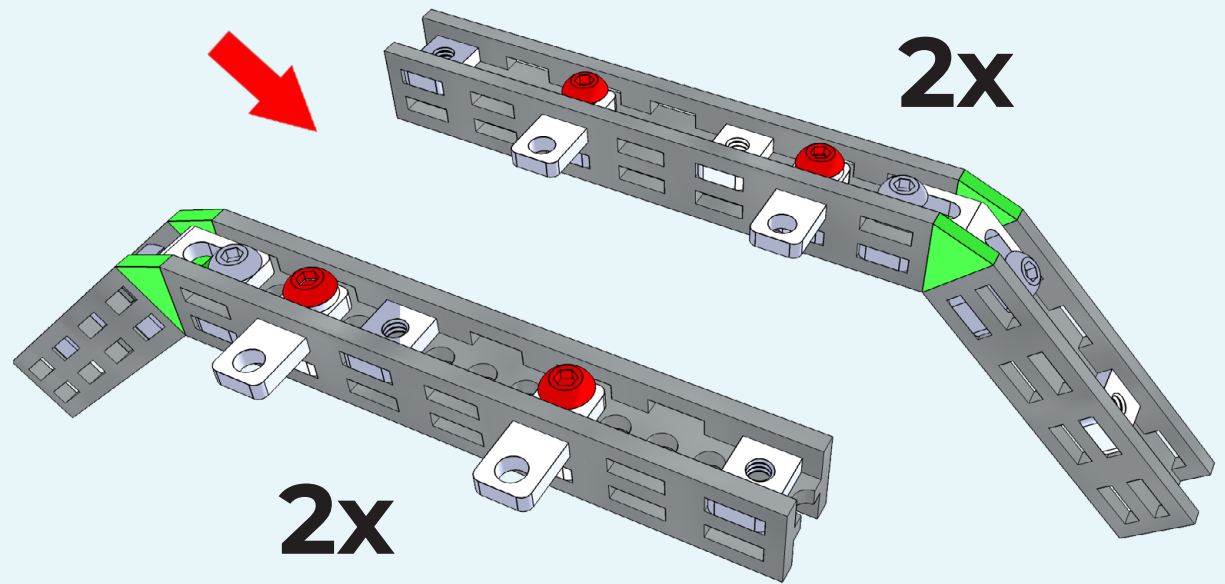

3

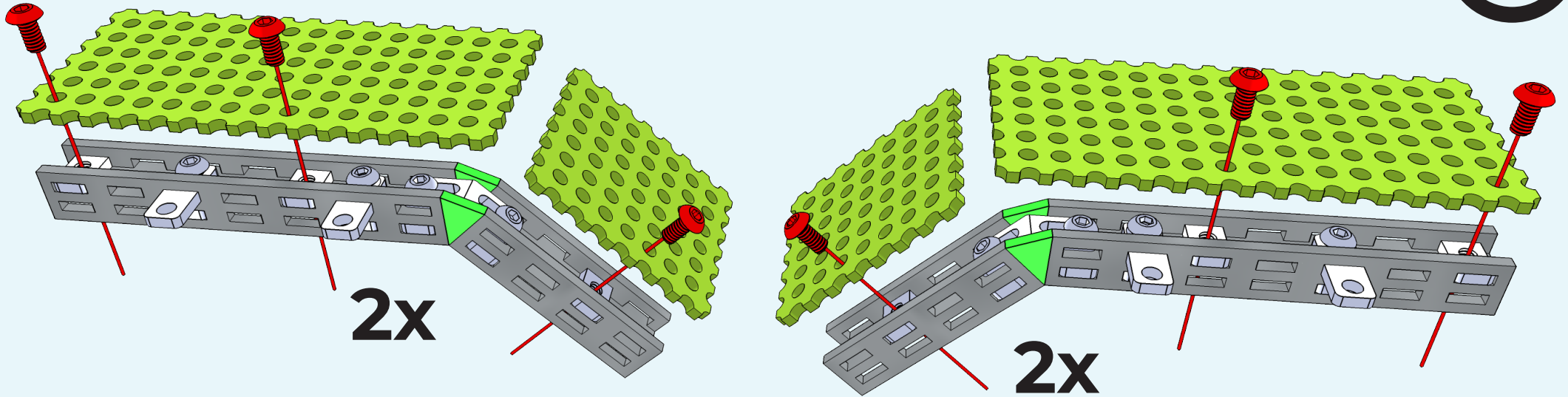

80x35mm

40x35mm

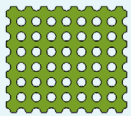
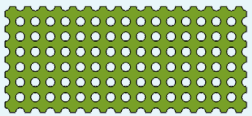

4x

4x

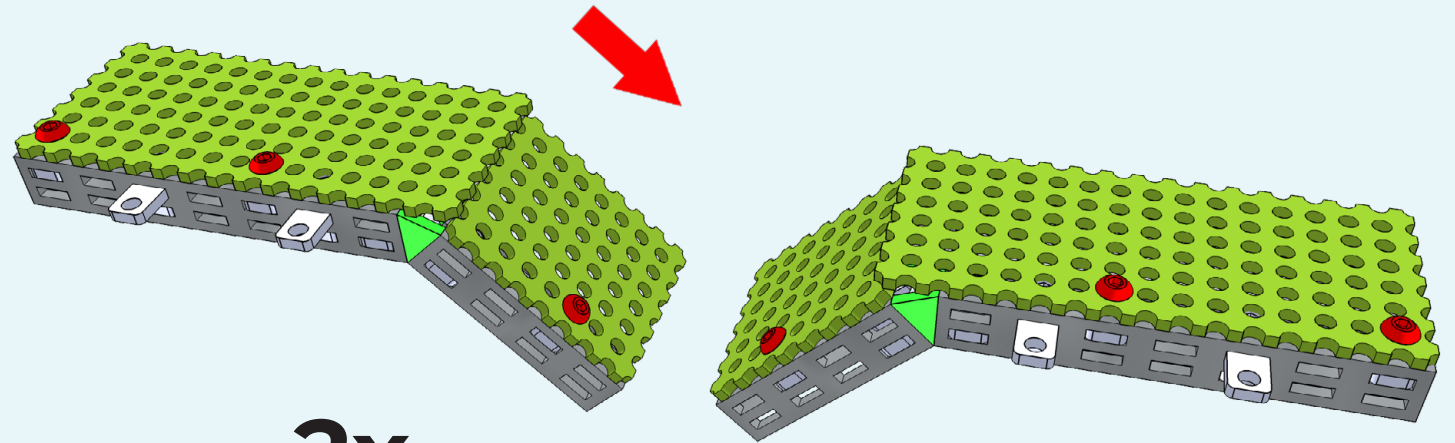

2x

2x

4

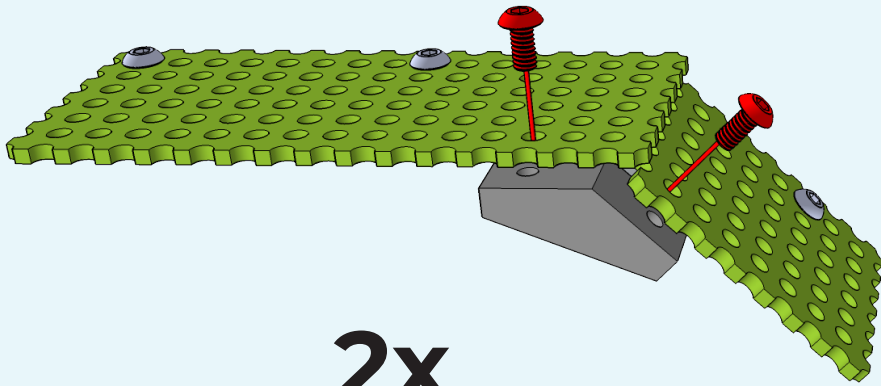

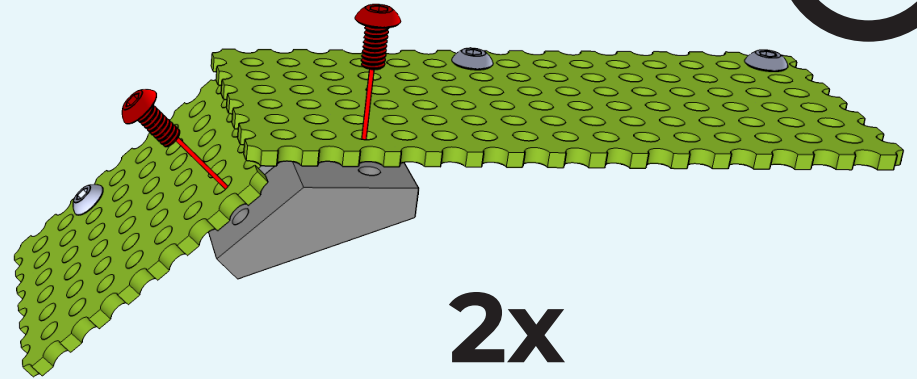

2x



2x



8x

Bolt M3x6

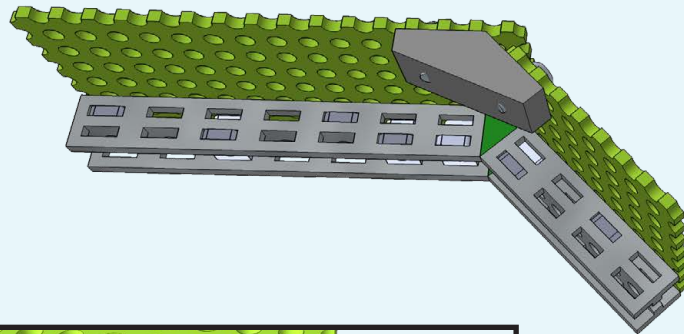
4x

45 degree plastic bracket

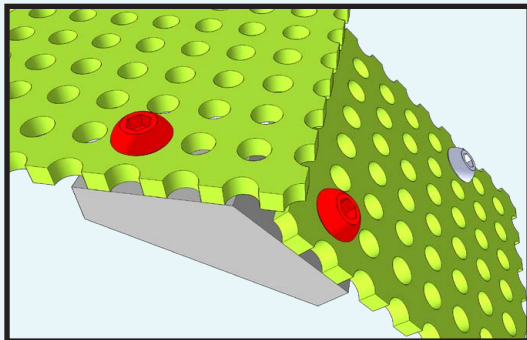
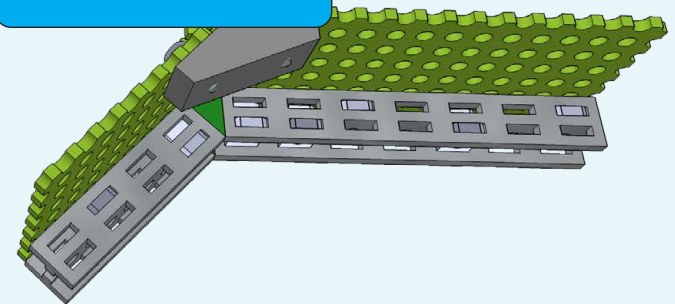

PART 6



PART 6



PART 7

1

8x

Bolt M3x6

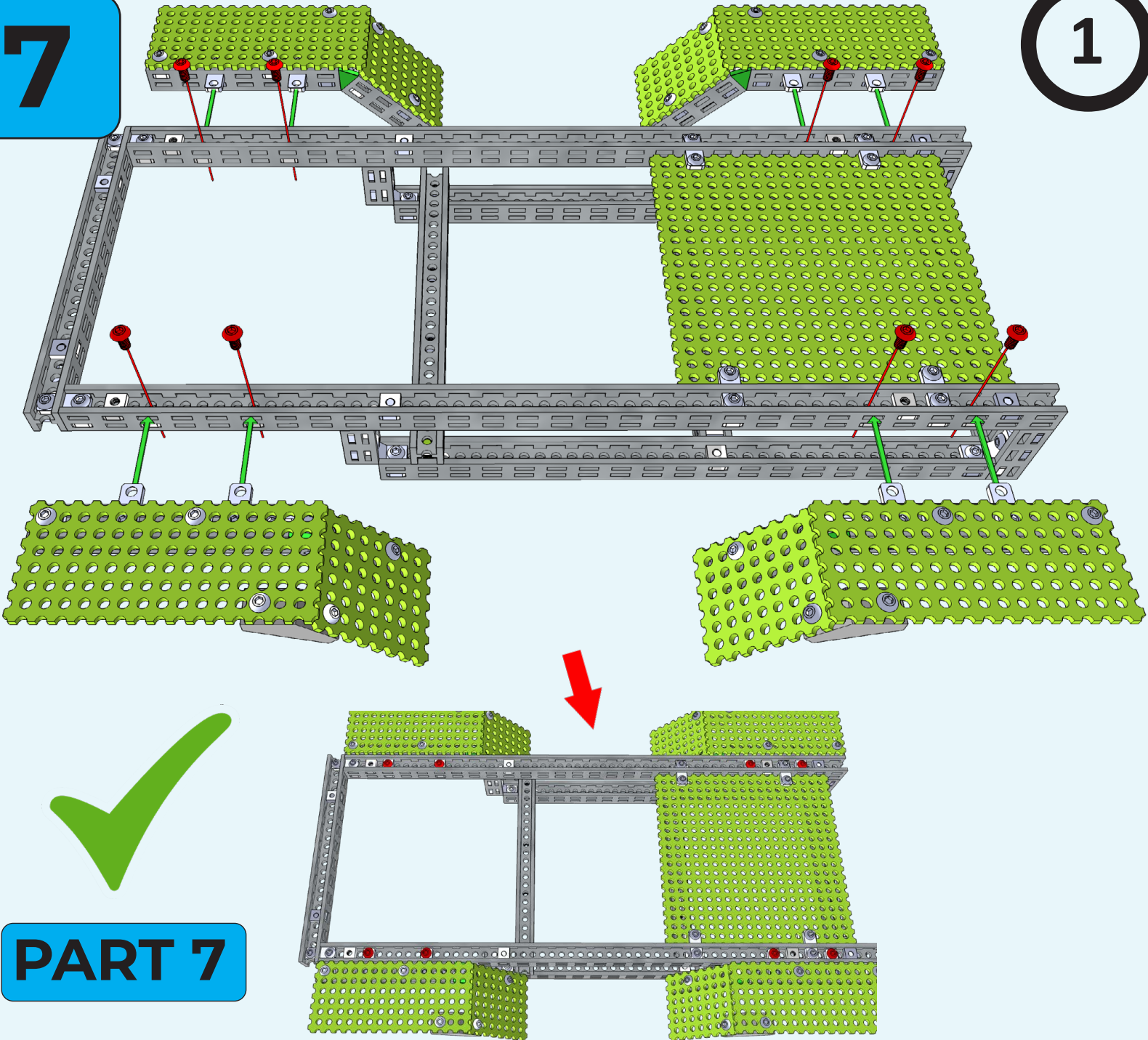

PART 7

PART 8

1

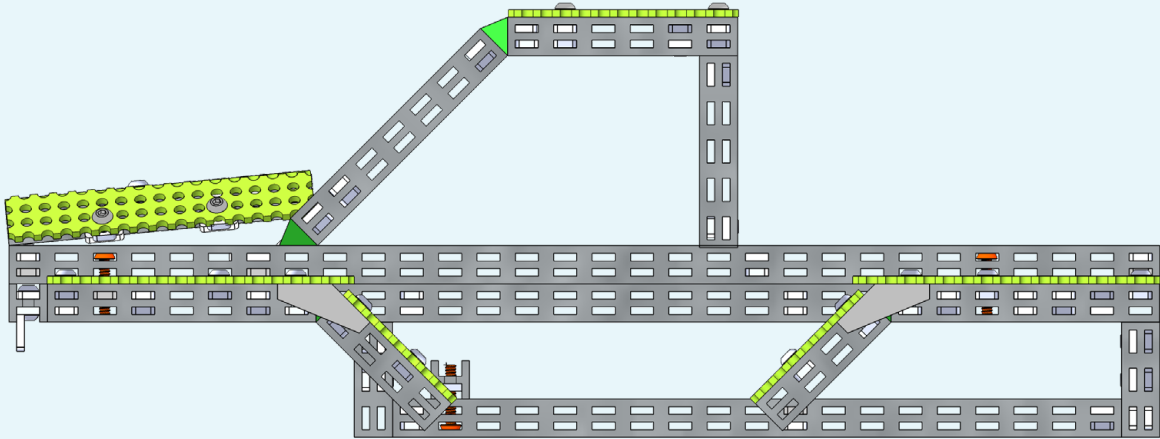
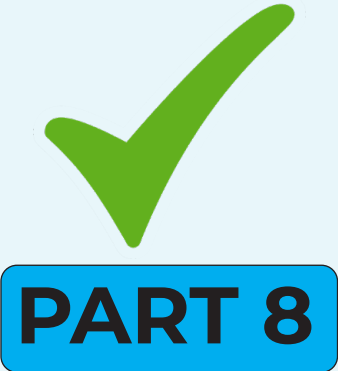
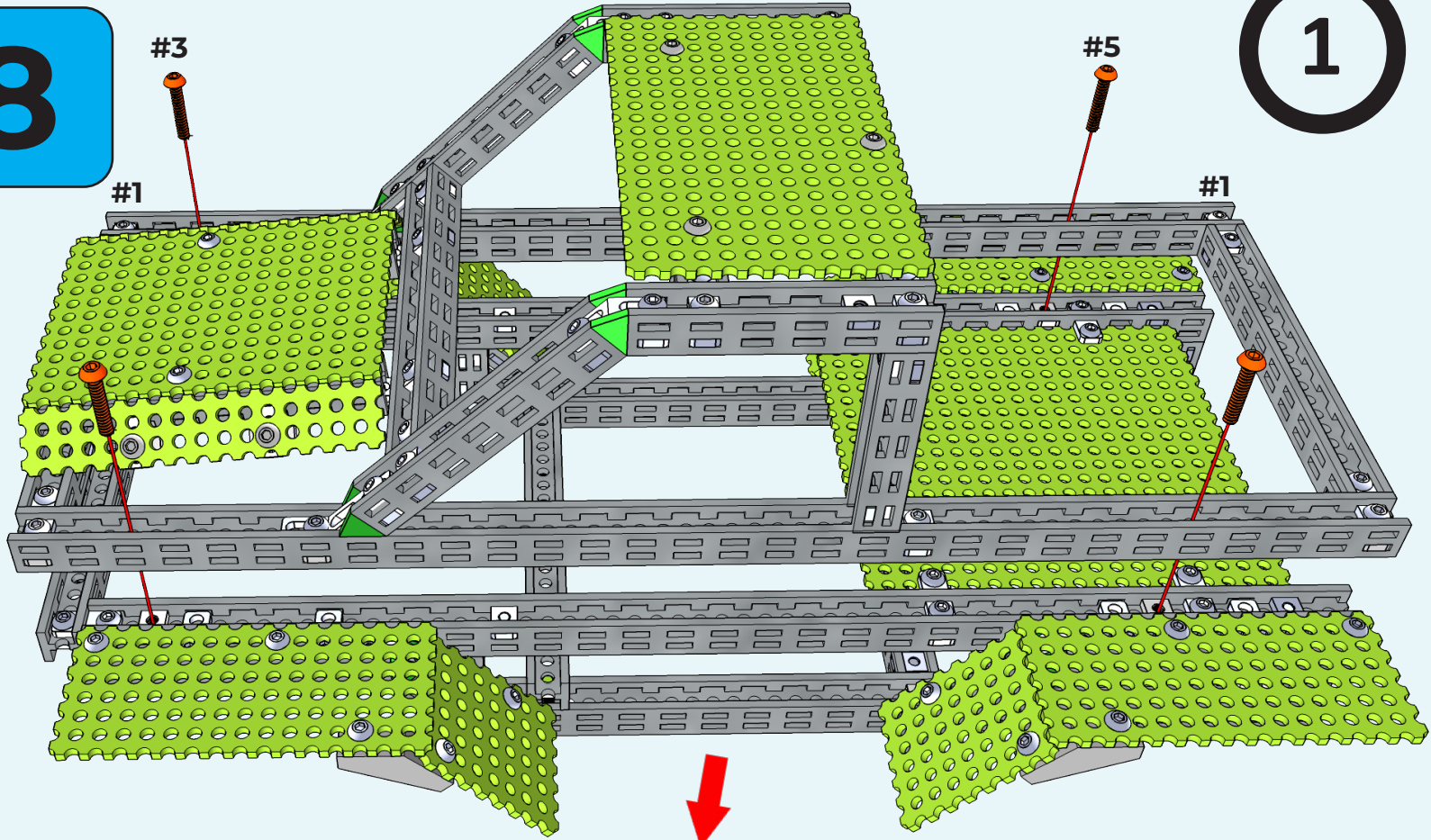
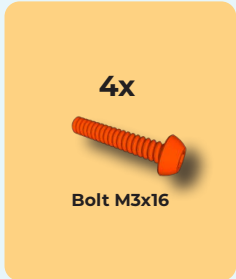

PART 9

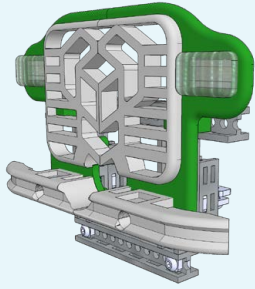

14x	2x	2x	16x
Bolt M3x6	Bolt M3x10	Bolt M3x25	Nut M3 6x10

4x	2x	1x
2-hole simple bracket	C-Bracket	Bumper

1x	1x	2x
Outer Grill	Inner Grill	Headlight

3 cm	2x
4 cm	2x
6 cm	1x
10 cm	1x

1

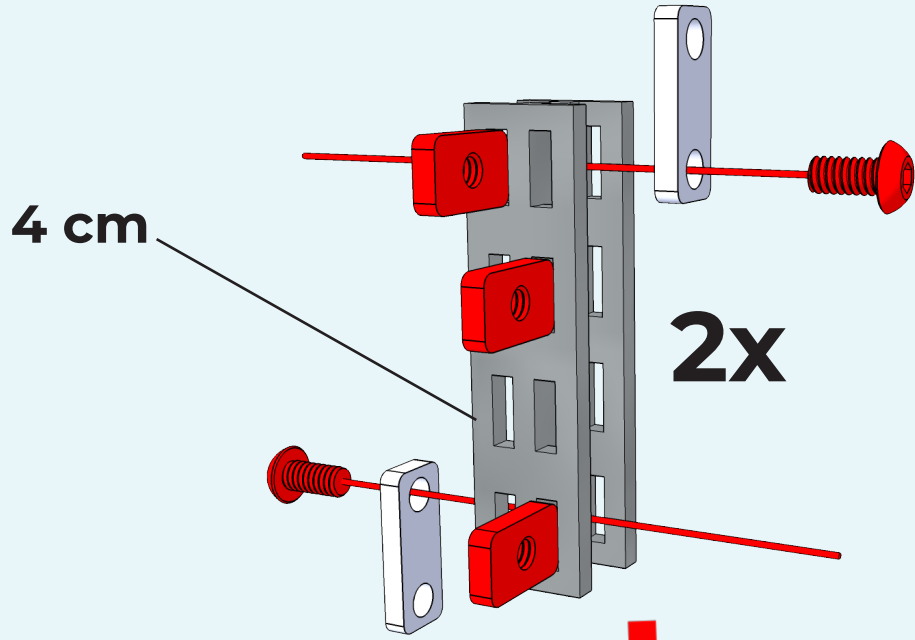

4 cm	2x

4x
Bolt M3x6
6x
Nut M3 6x10
4x
2-hole simple bracket

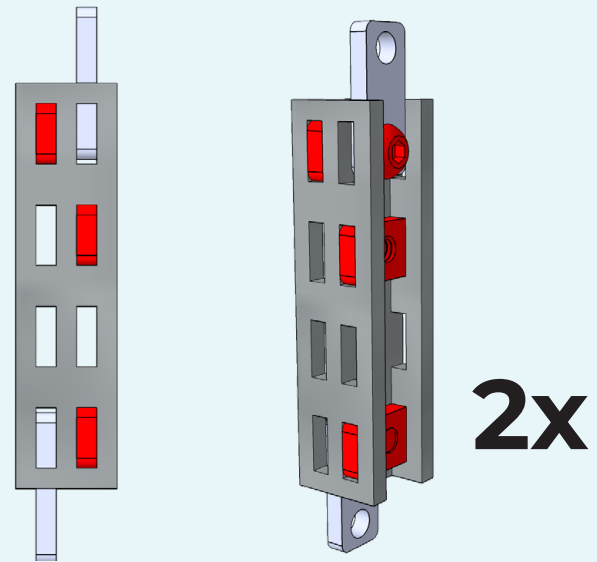

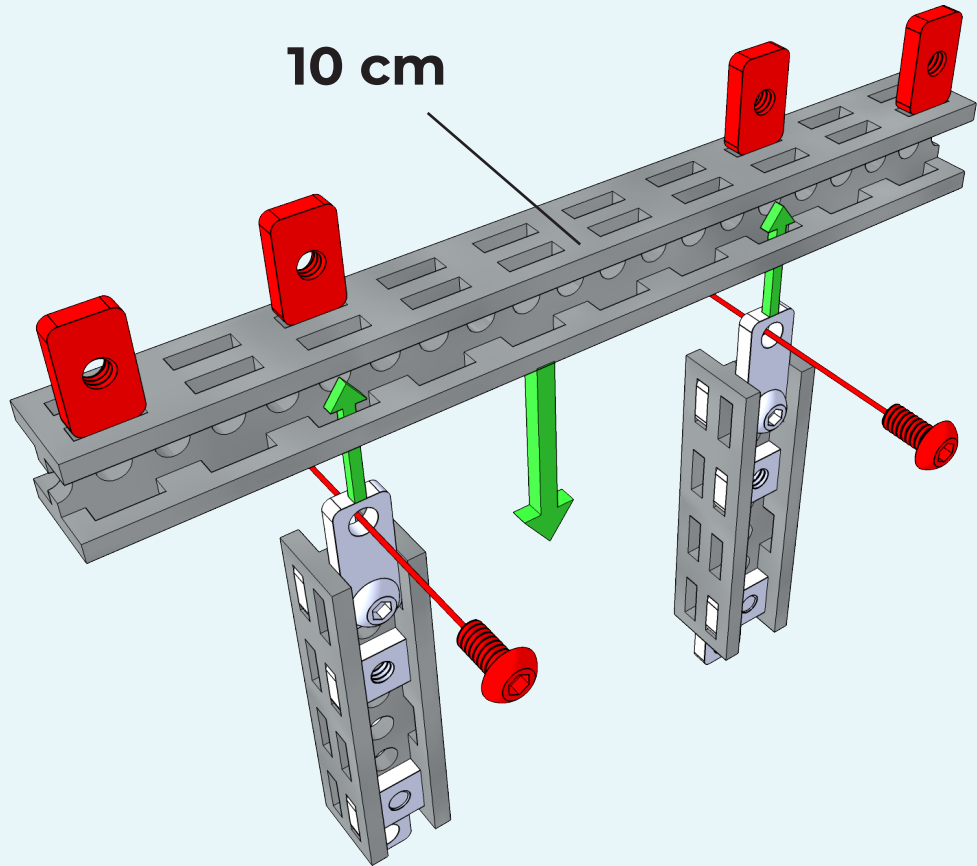

10 cm

- 2x Bolt M3x6
- 4x Nut M3 6x10

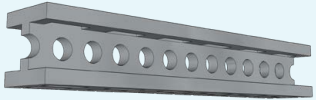

10 cm 1x

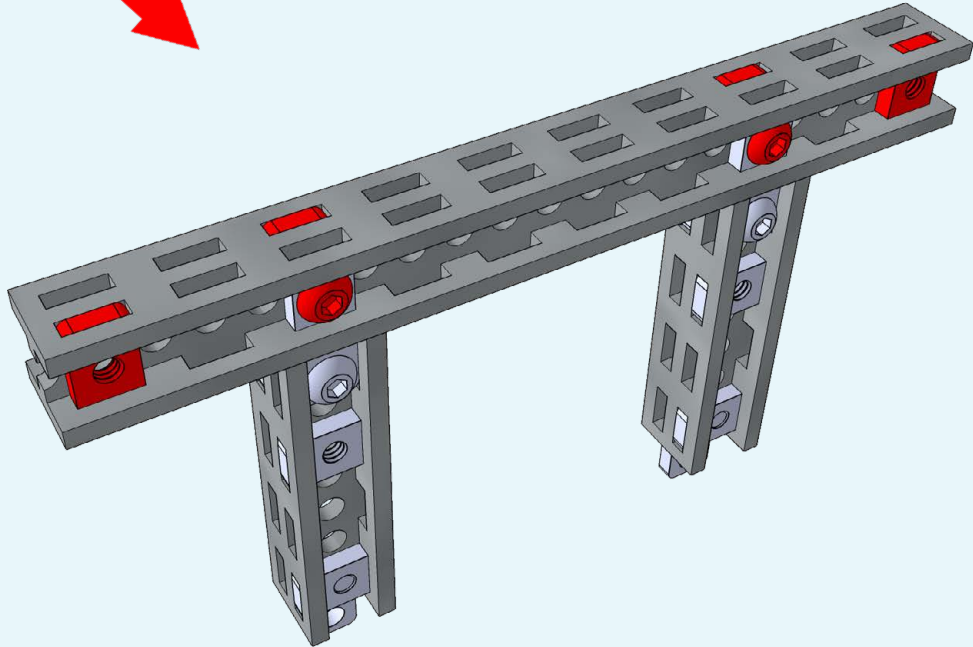
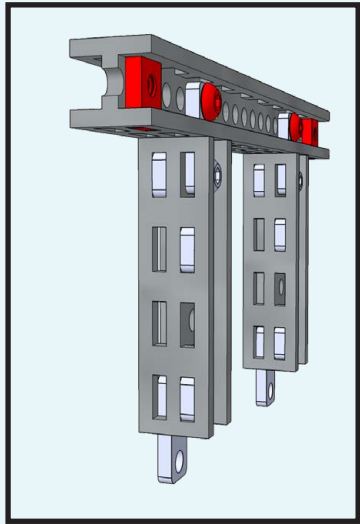

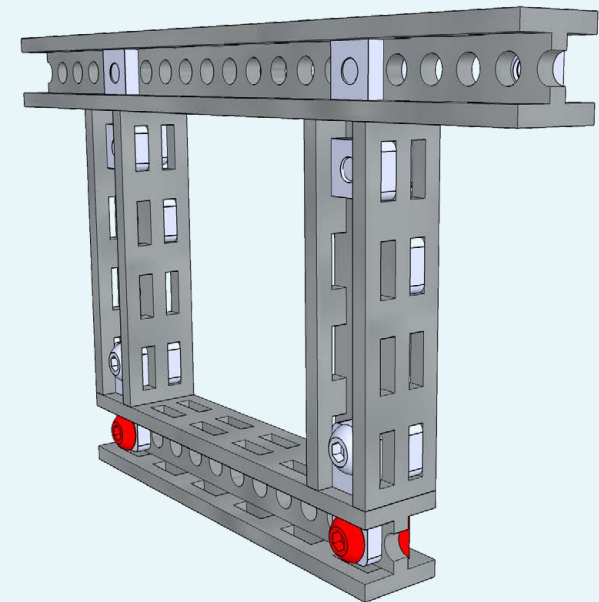
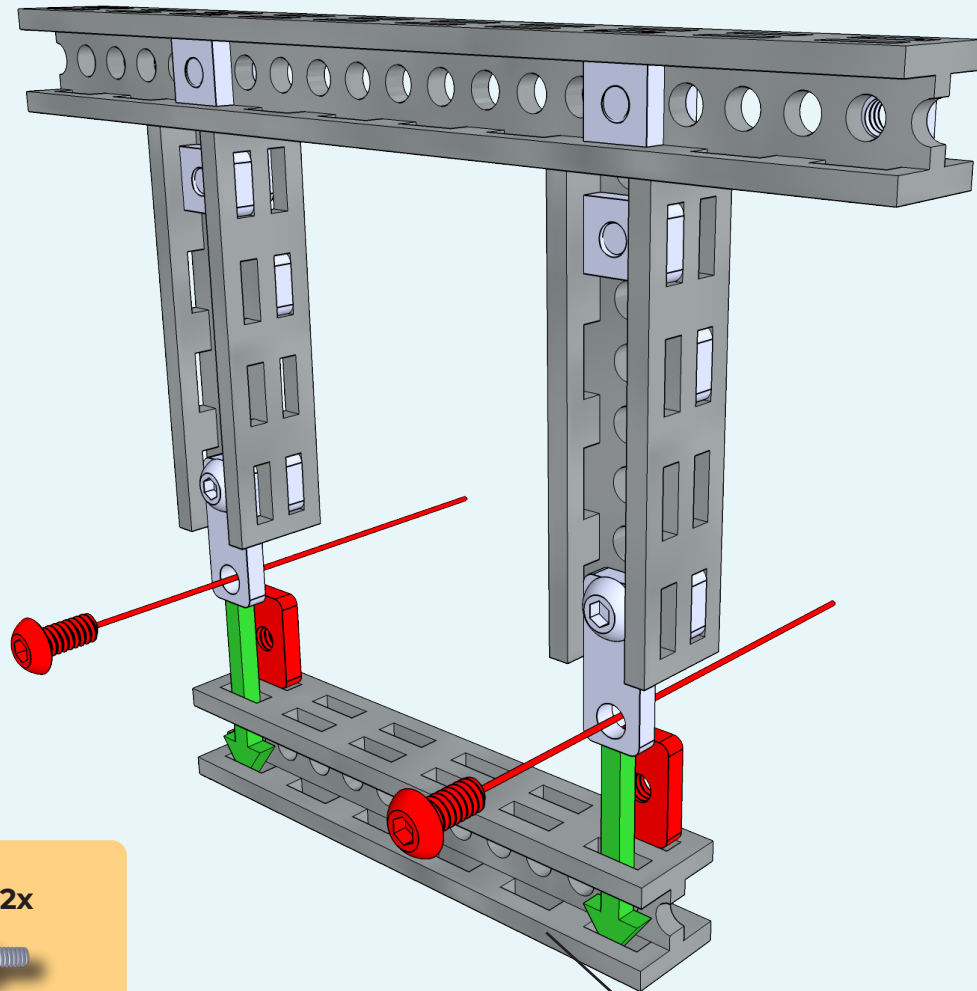

2x



Bolt M3x6

2x

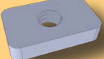

Nut M3 6x10



6 cm

6 cm	1x
------	----

6 cm

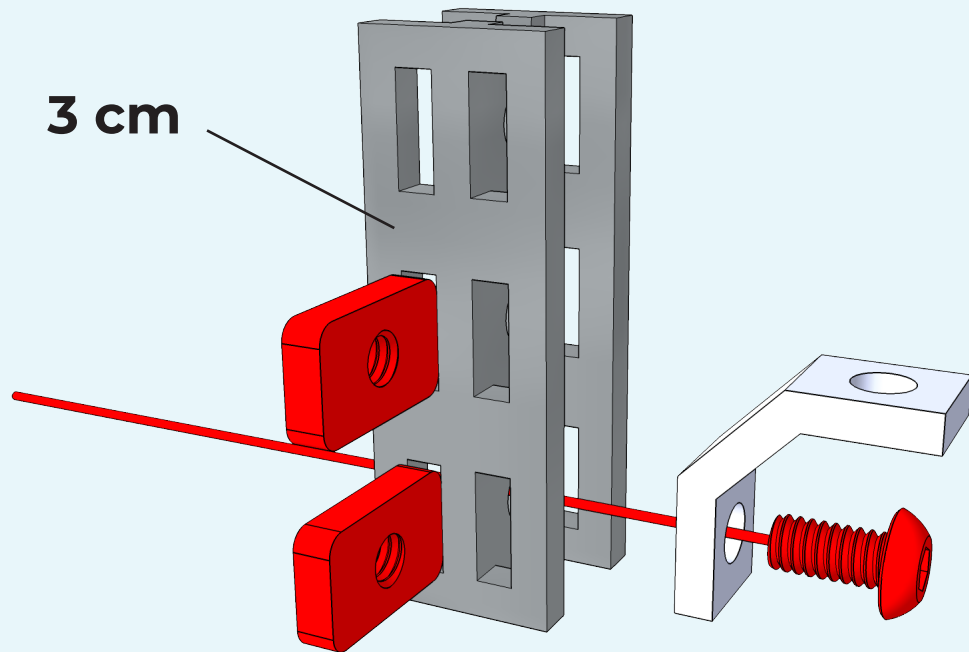

2x

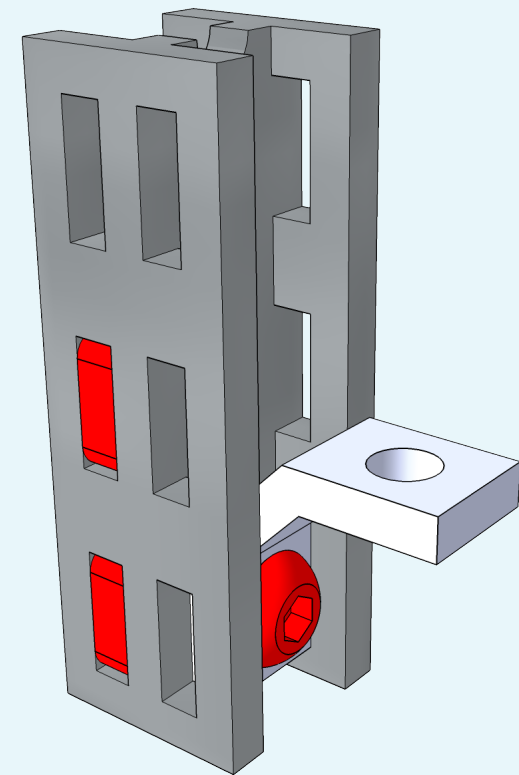

- 2x Bolt M3x6
- 4x Nut M3 6x10
- 2x C-Bracket

3 cm	2x
------	----

5

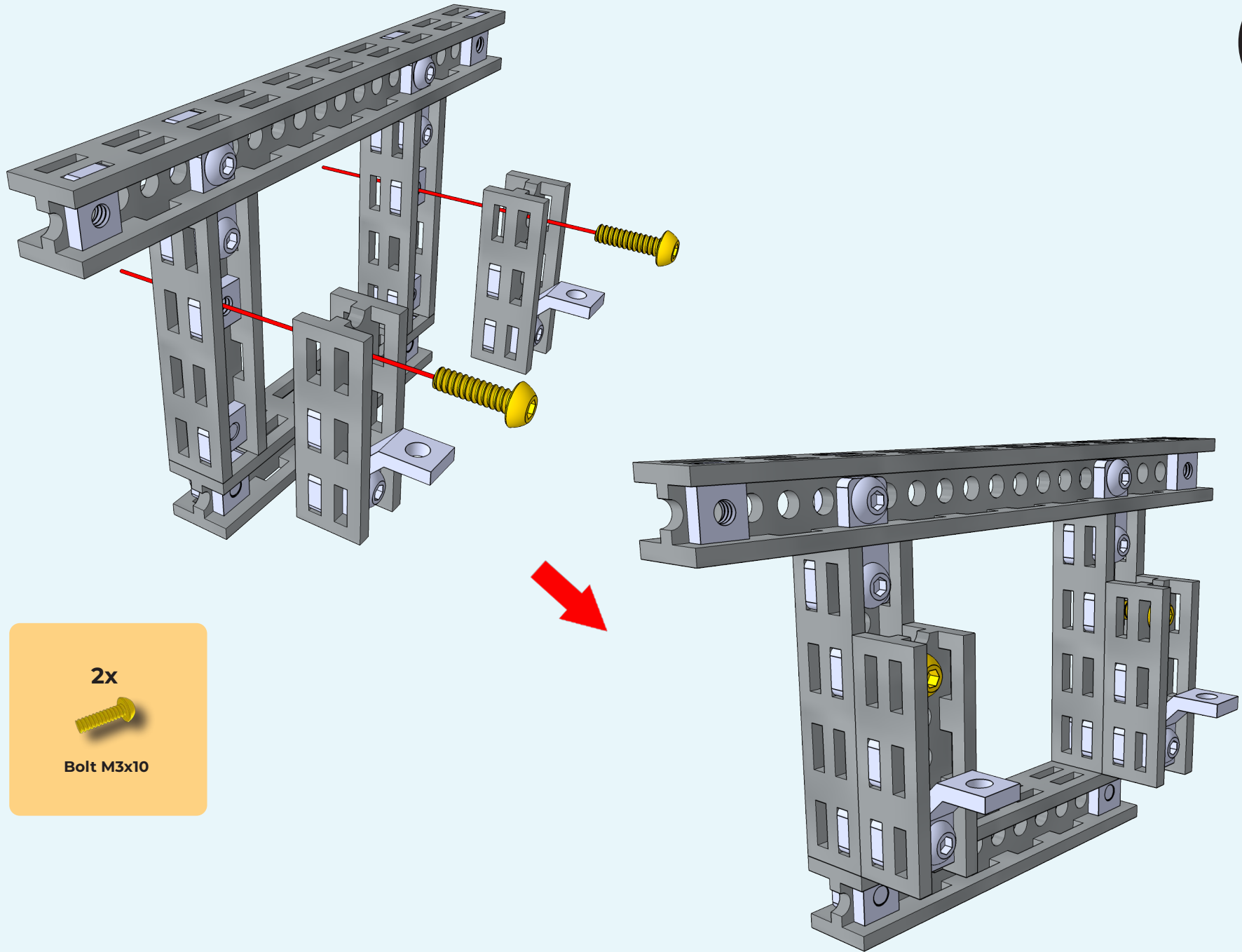



2x

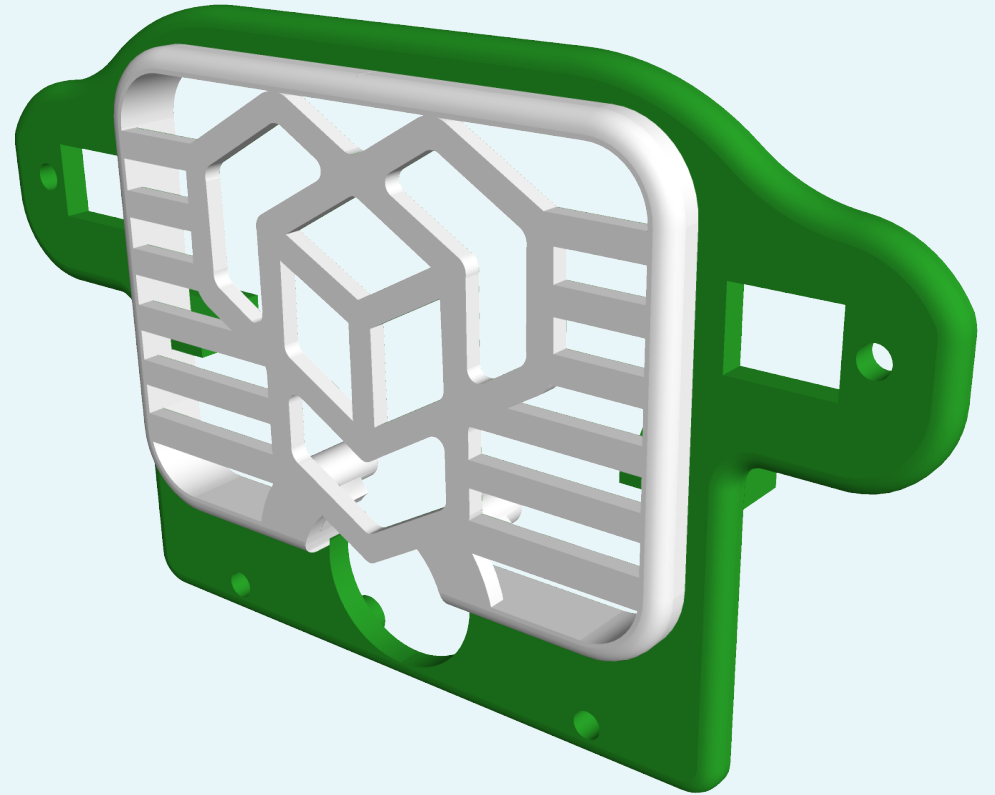
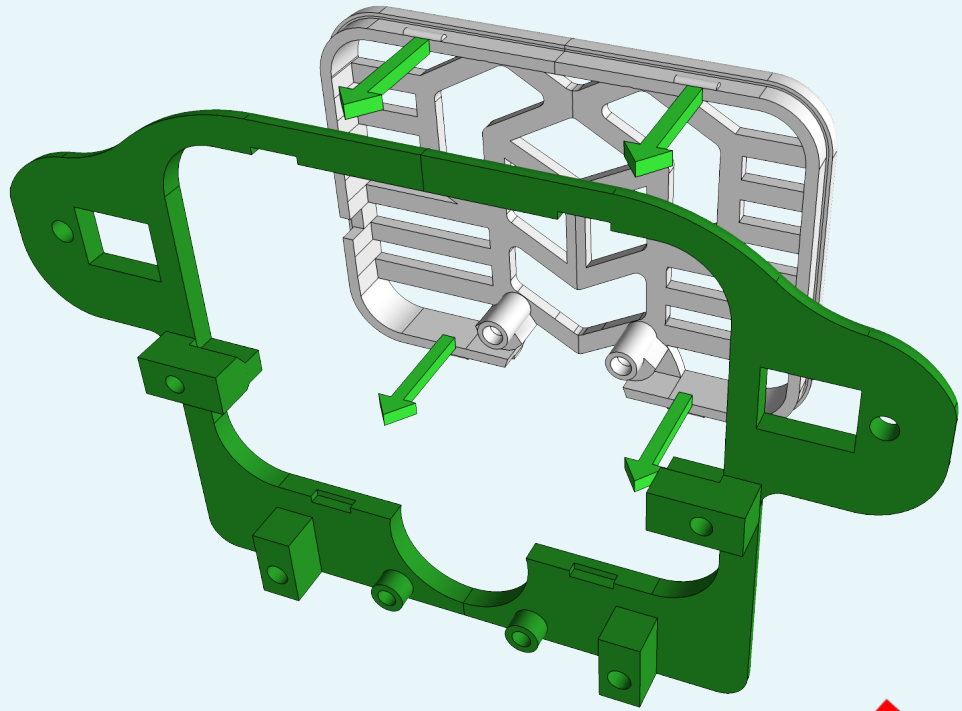

Bolt M3x10

6



1x	1x
	
Outer Grill	Inner Grill

7

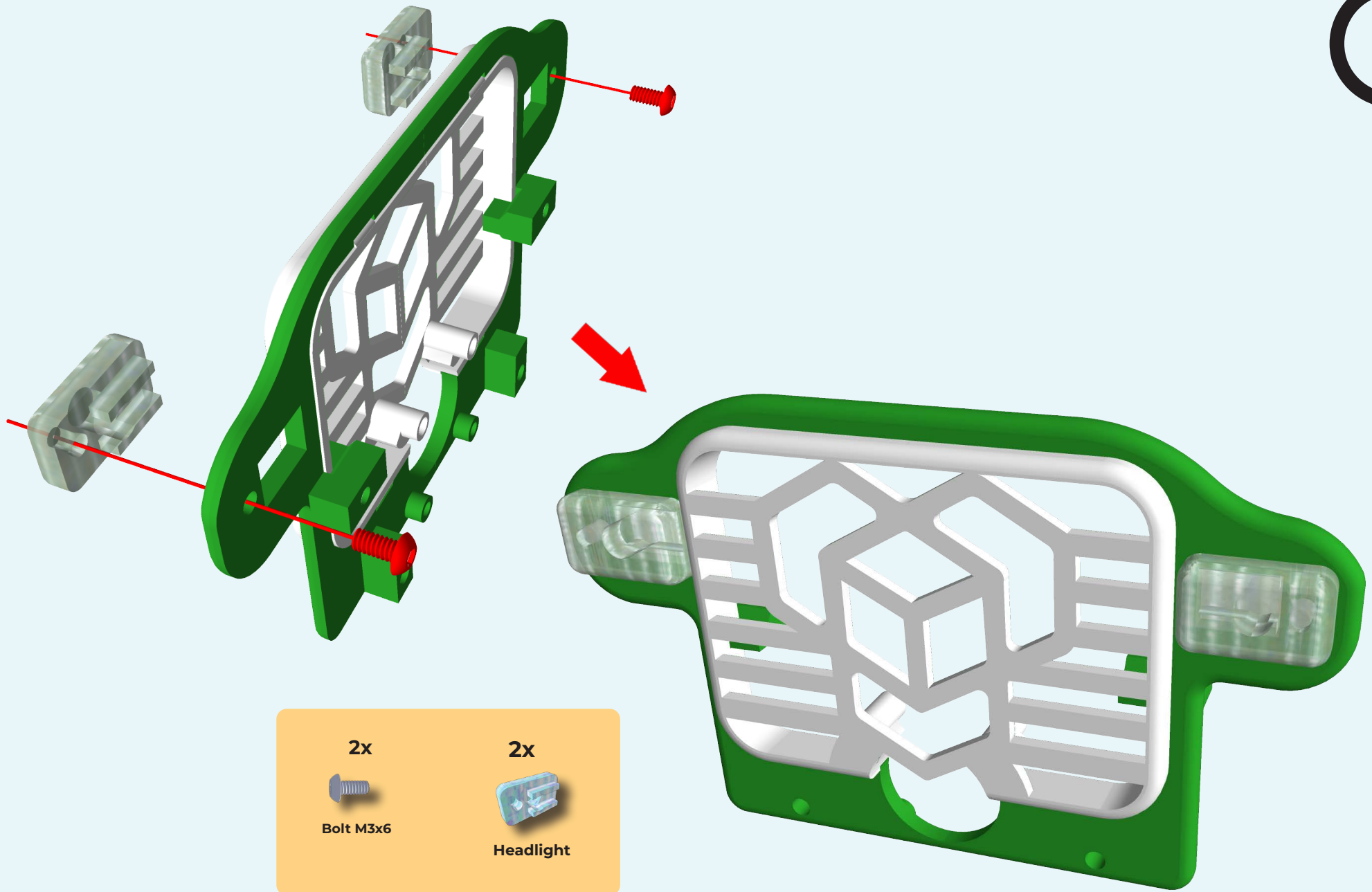

2x



Bolt M3x6

2x



Headlight

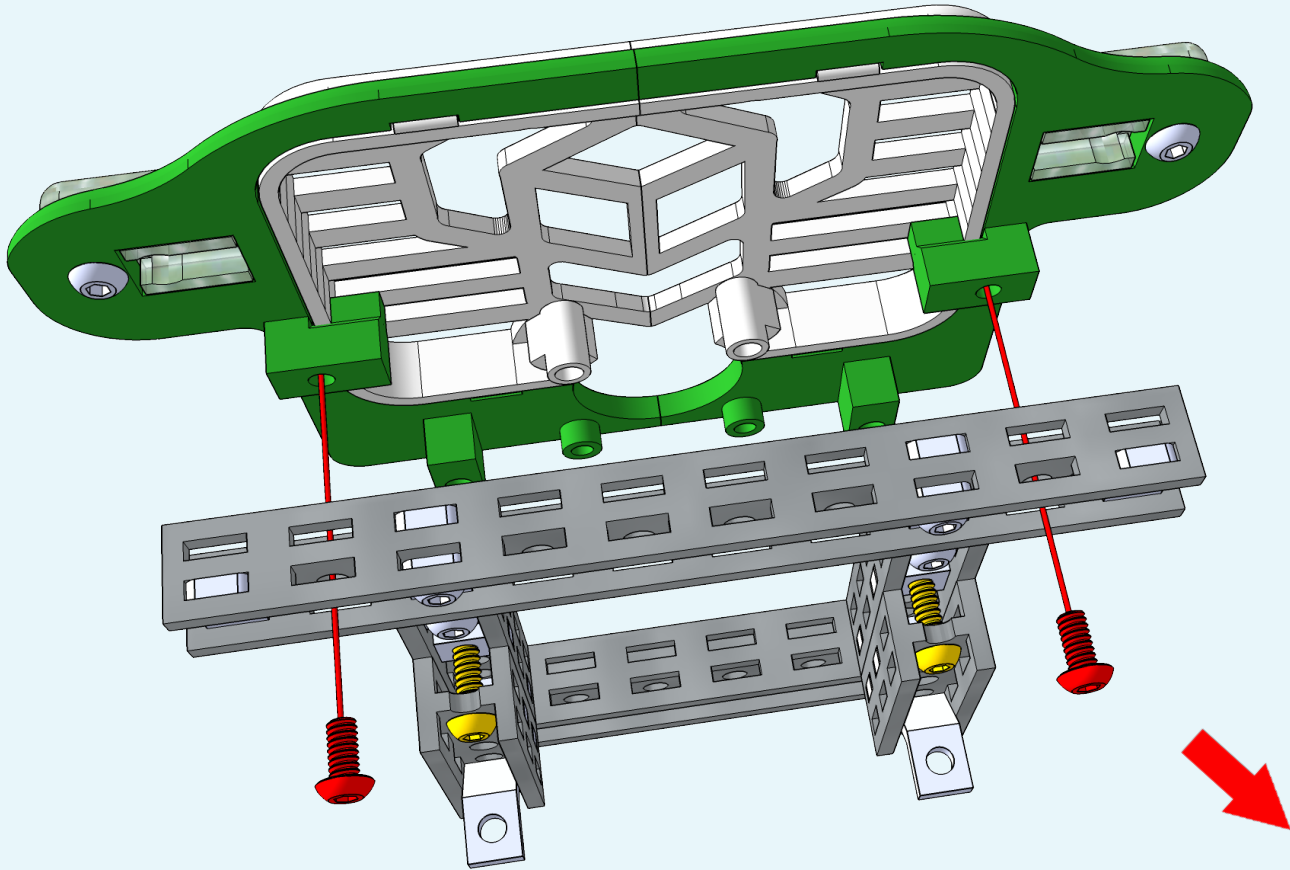

2x



Bolt M3x6

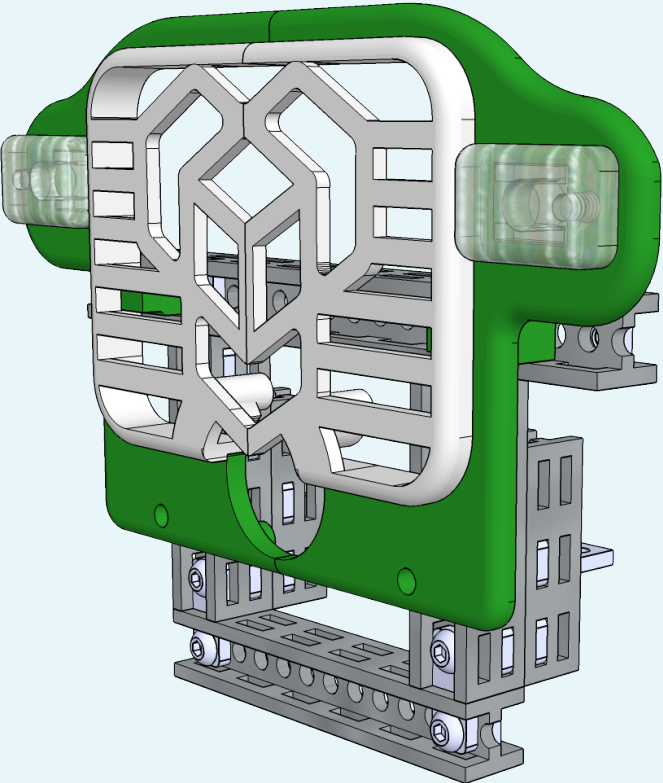

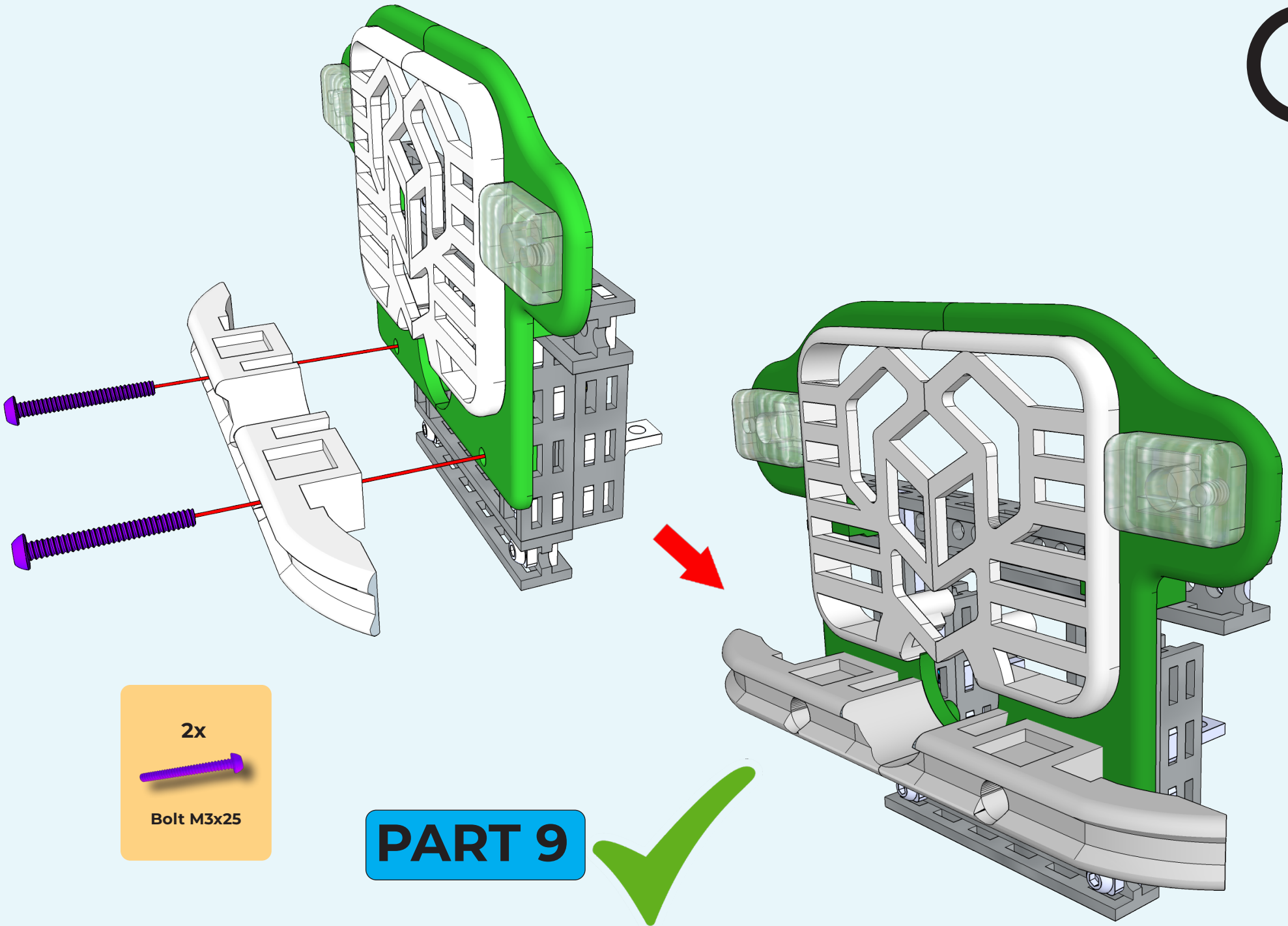

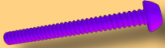
2x

Bolt M3x25

PART 9

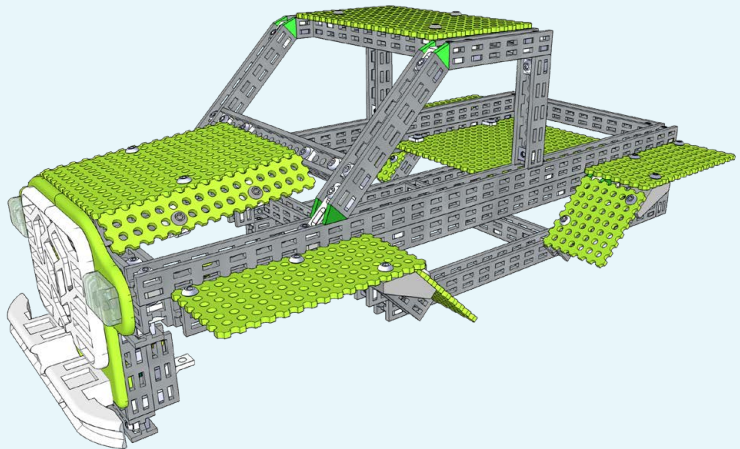

PART 10



2x



Bolt M3x6

1

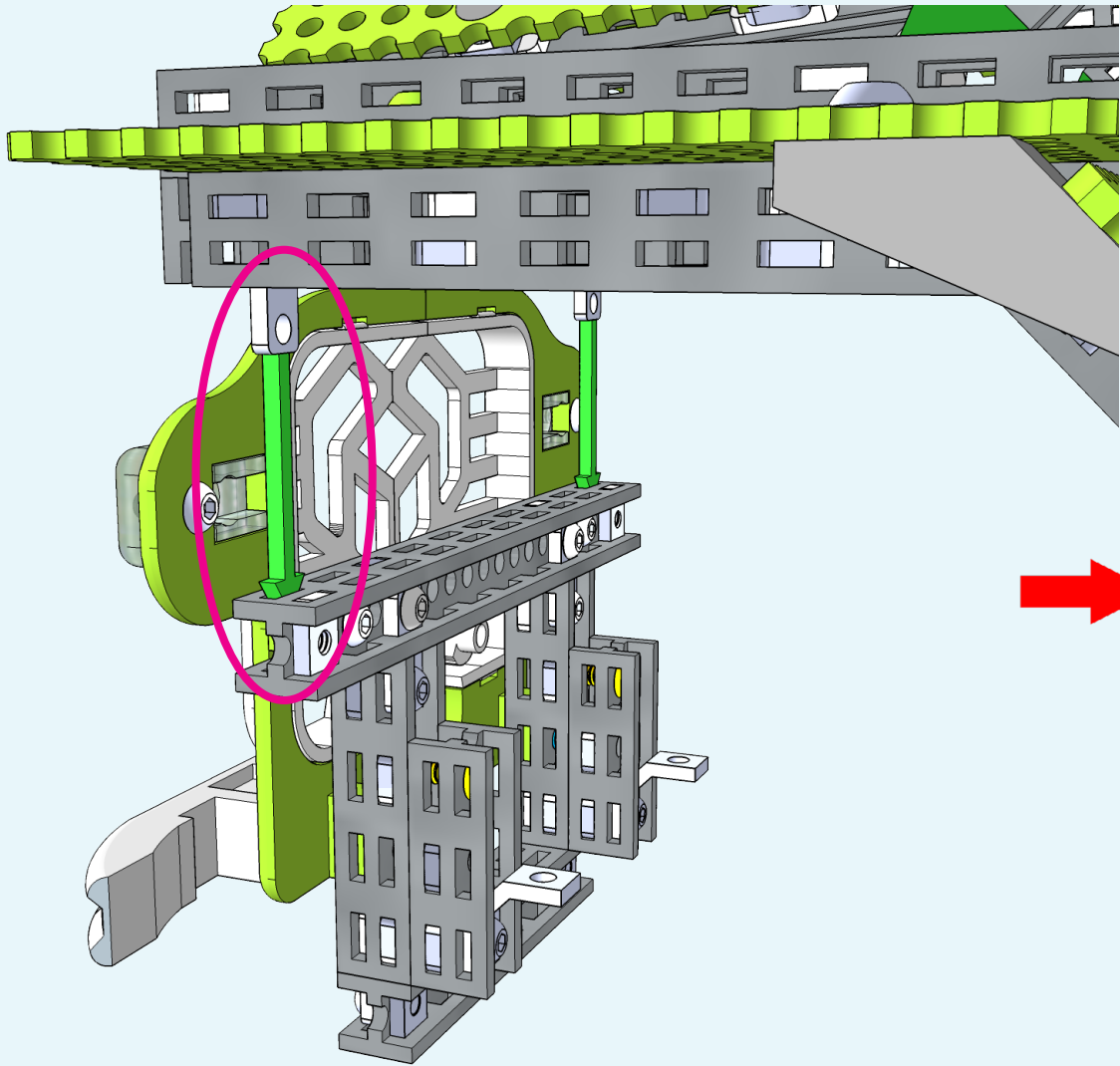

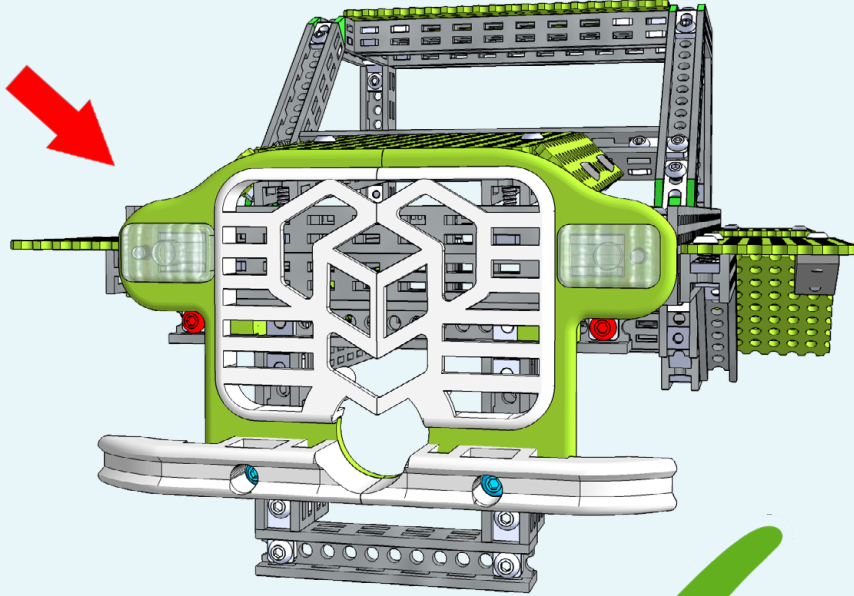
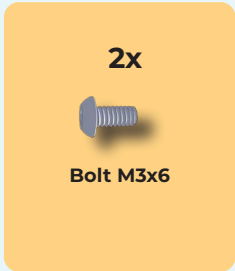
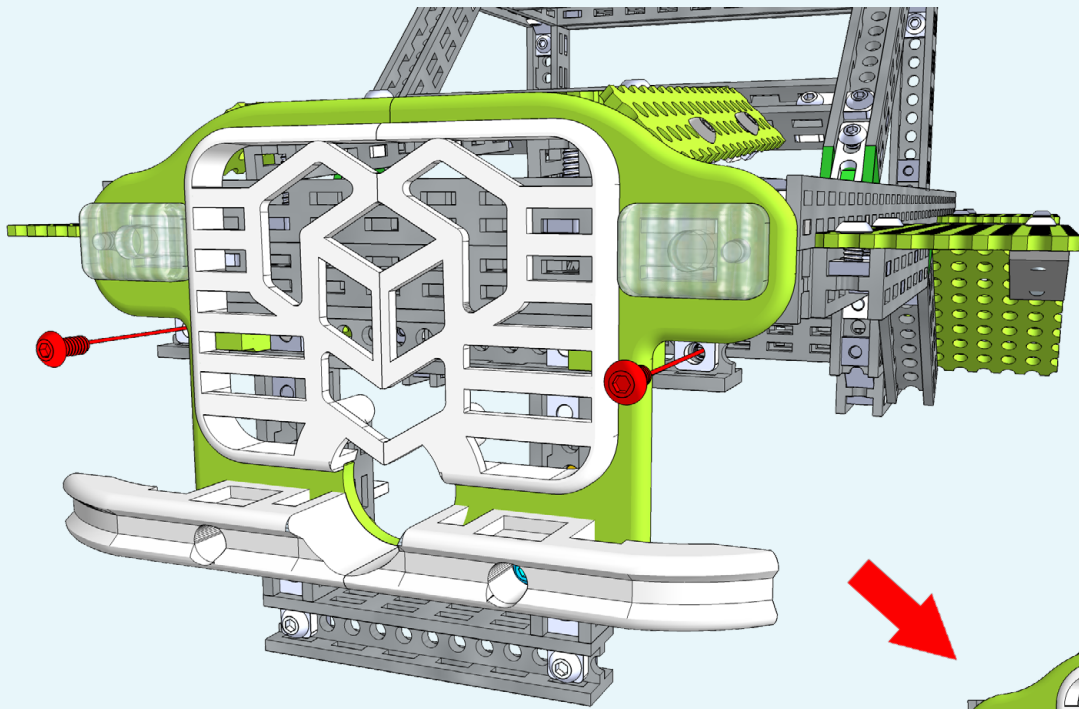

PART 10

PART 11

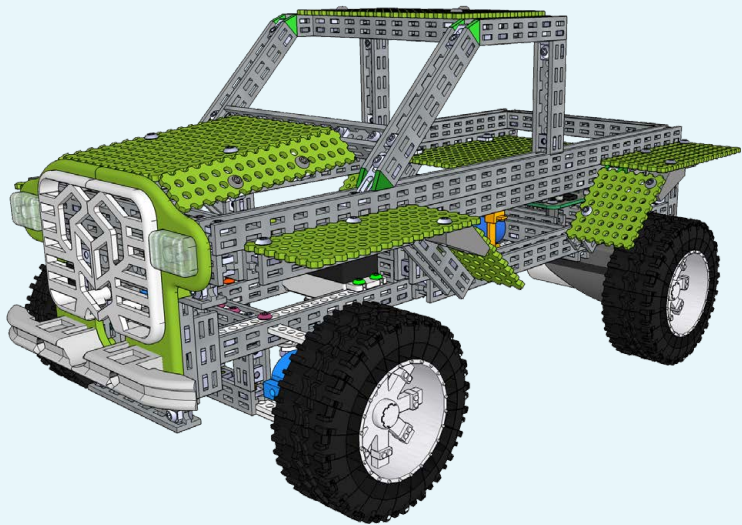

1

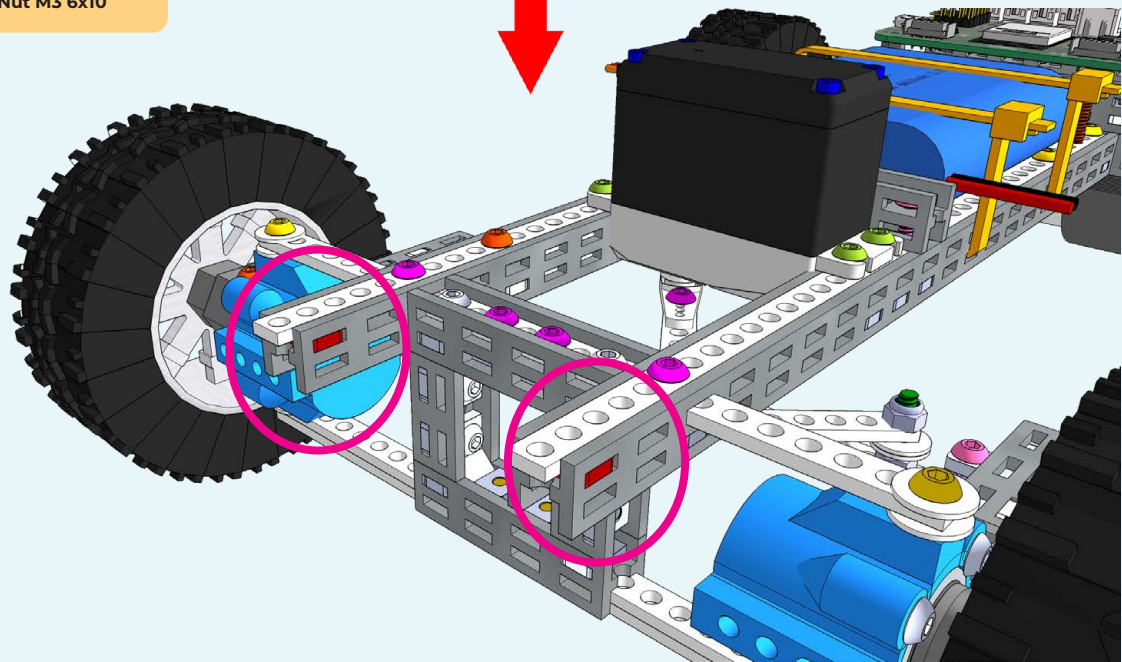
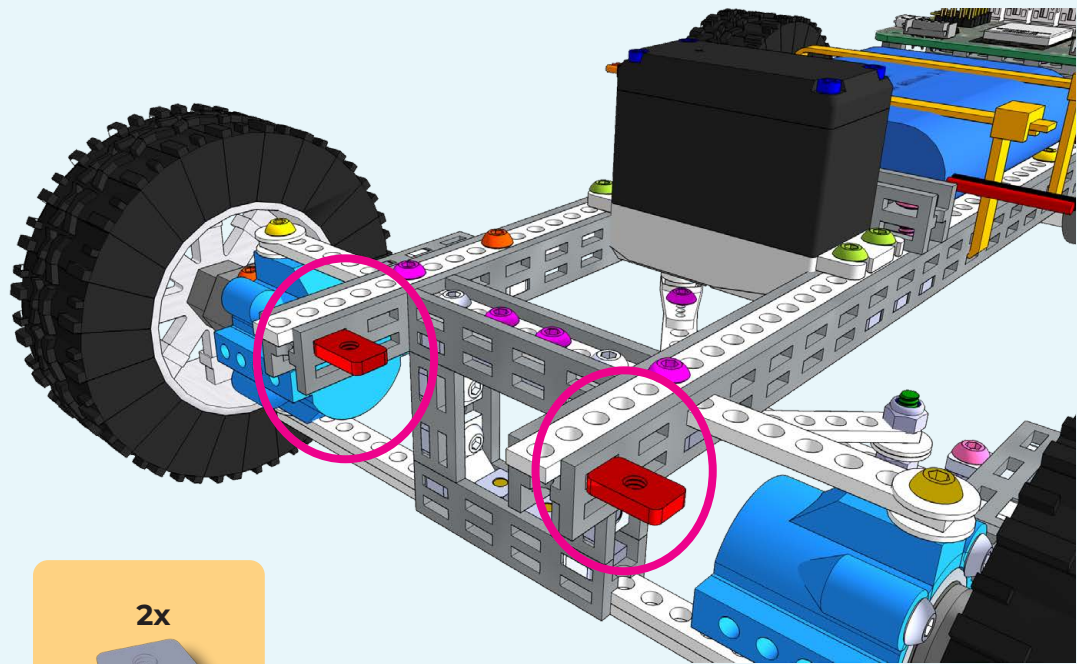

2

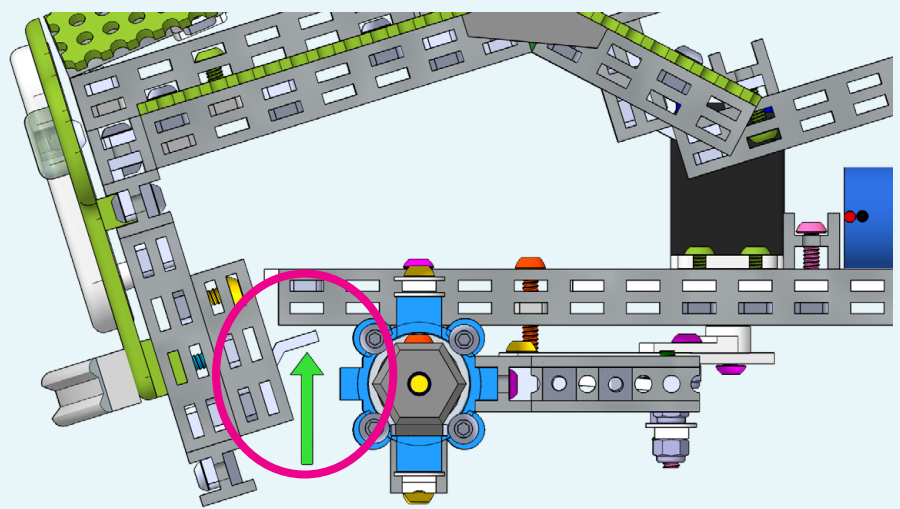
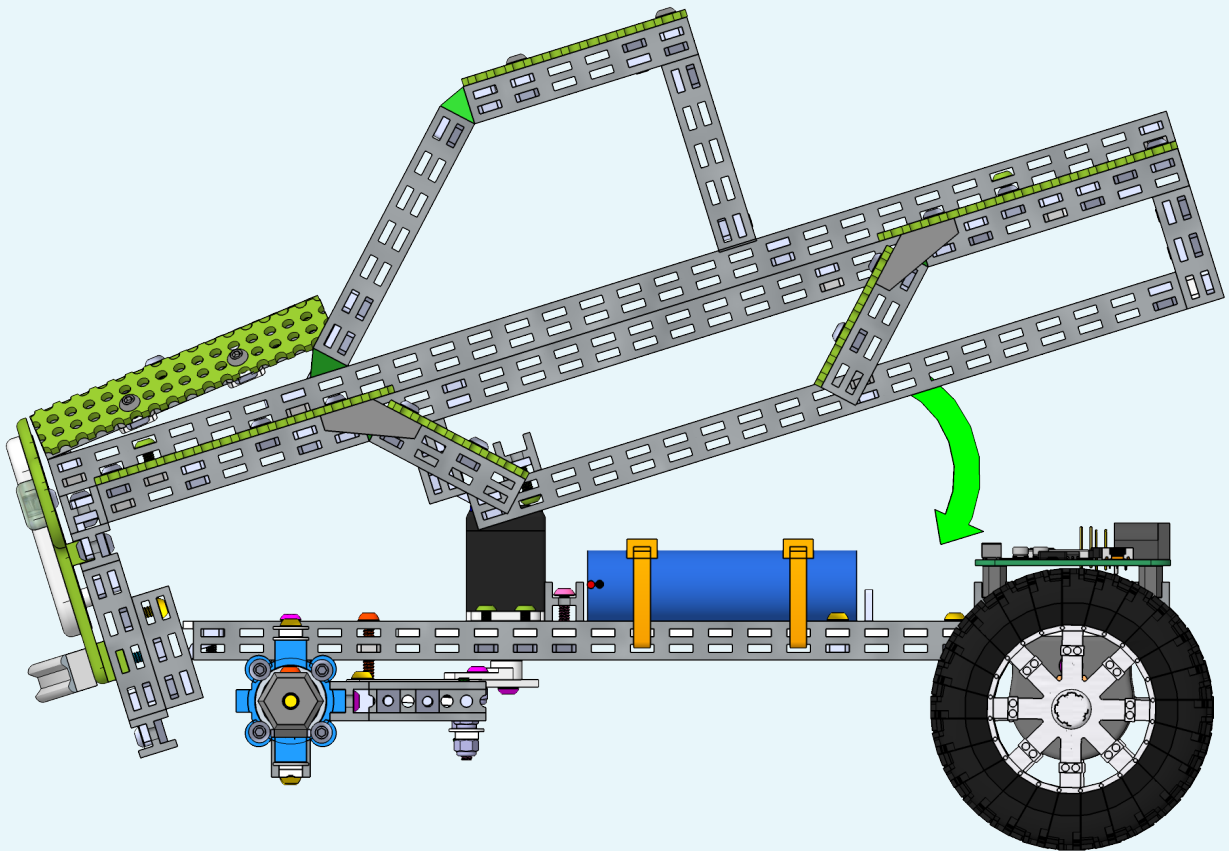

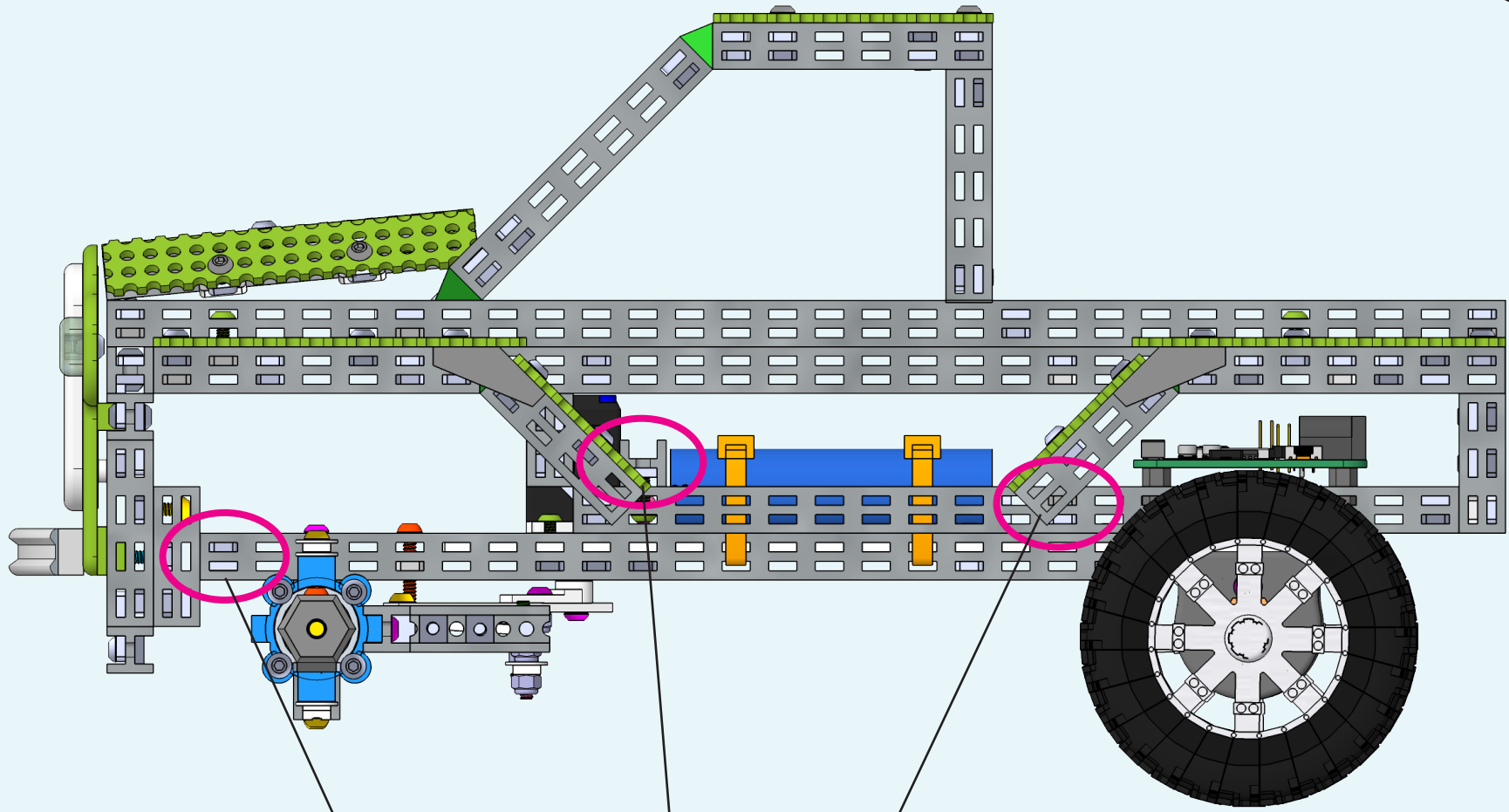

Contact points between chassis and body-top.

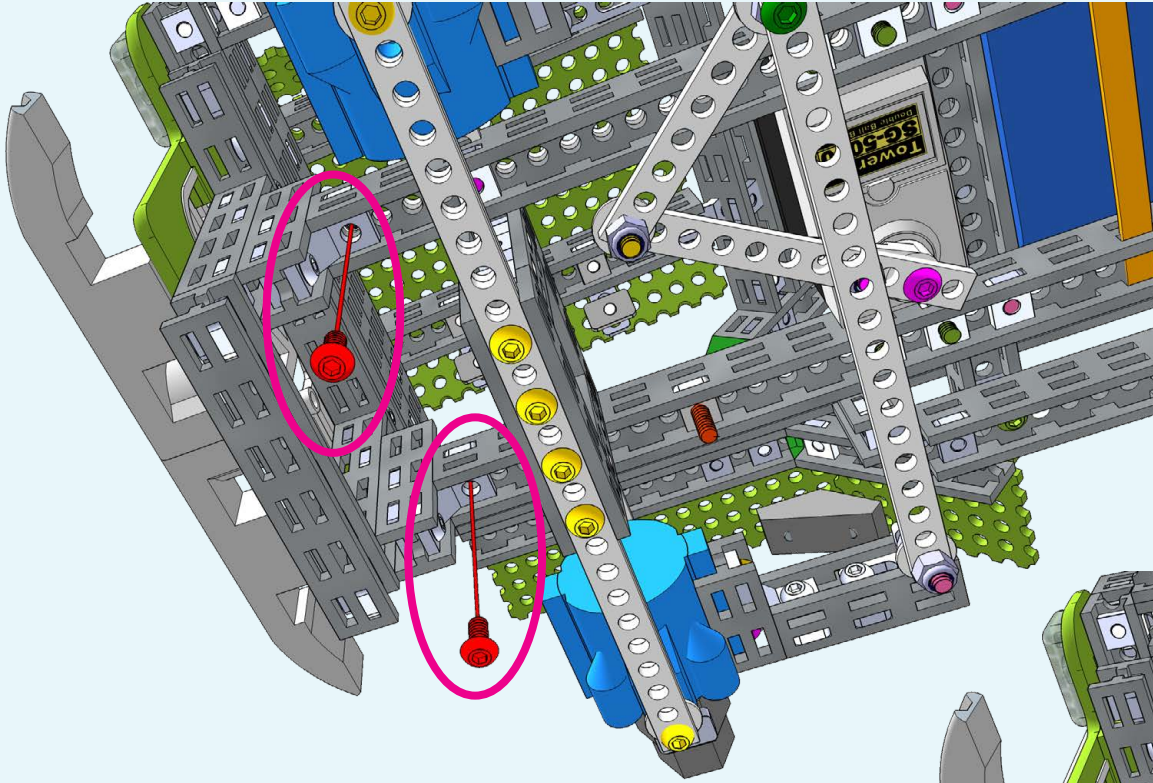

2x



Bolt M3x6

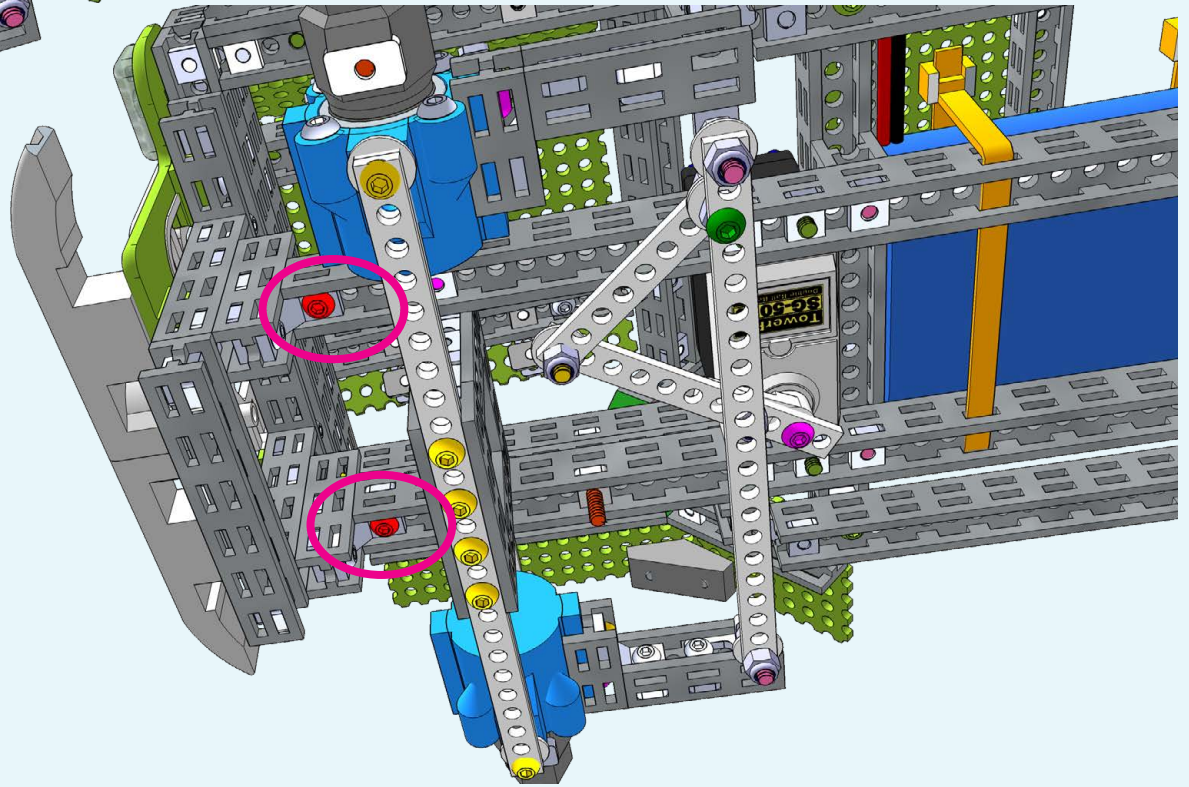

5

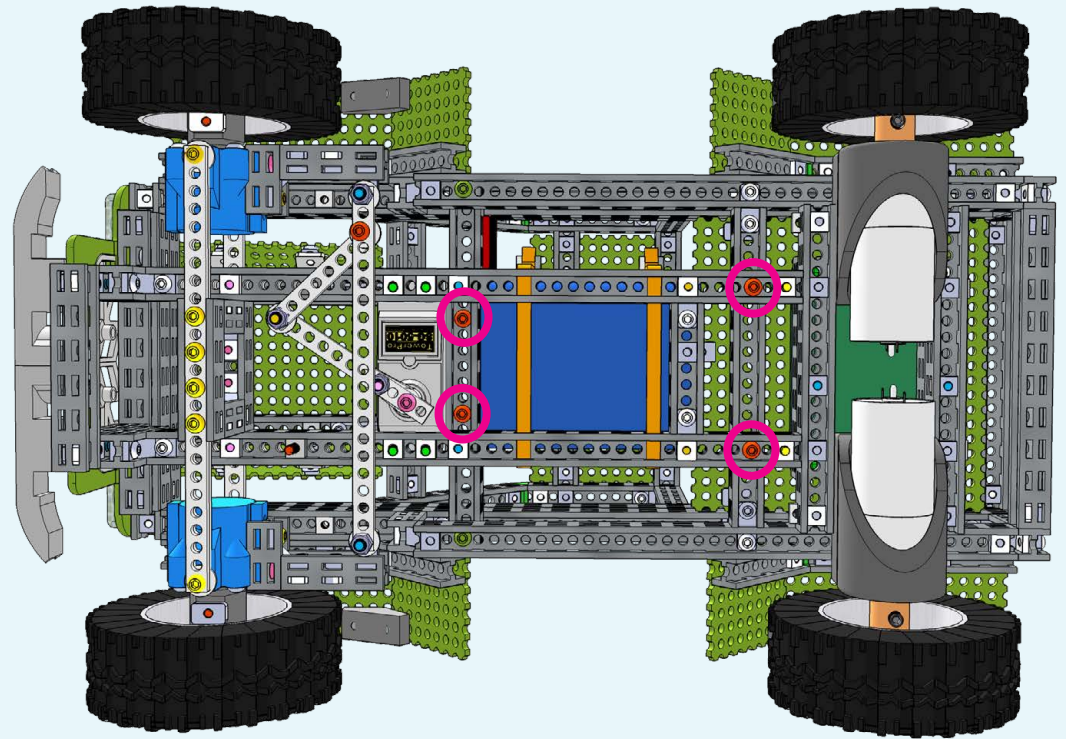
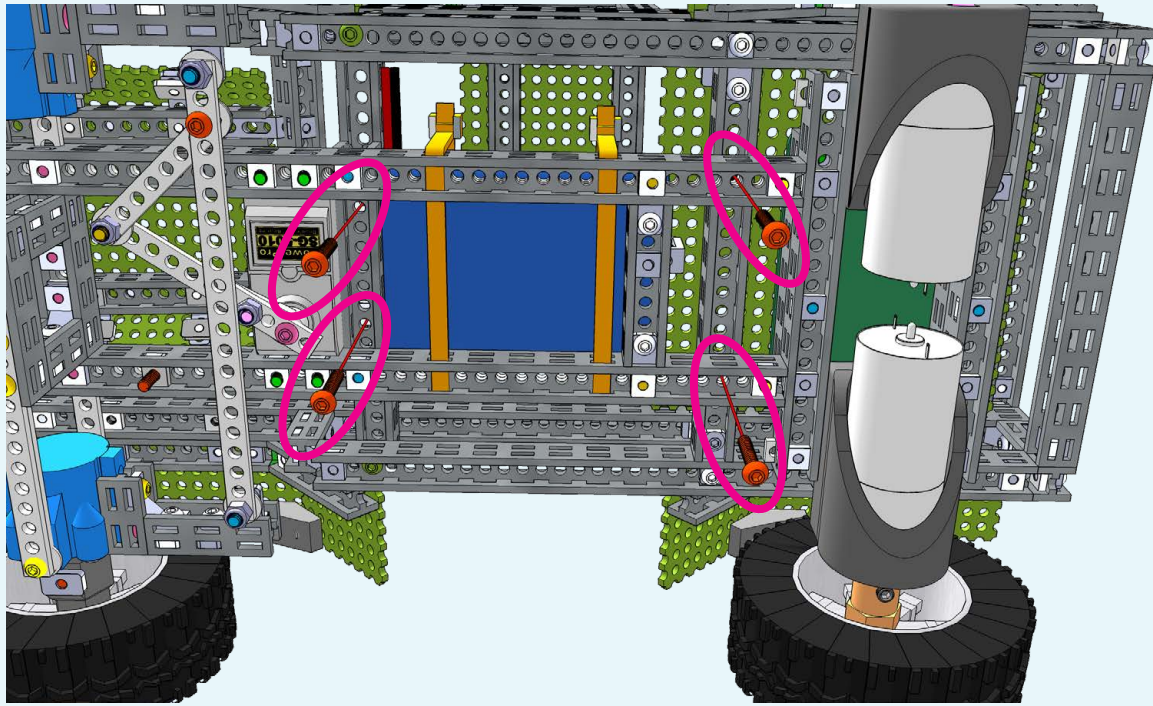

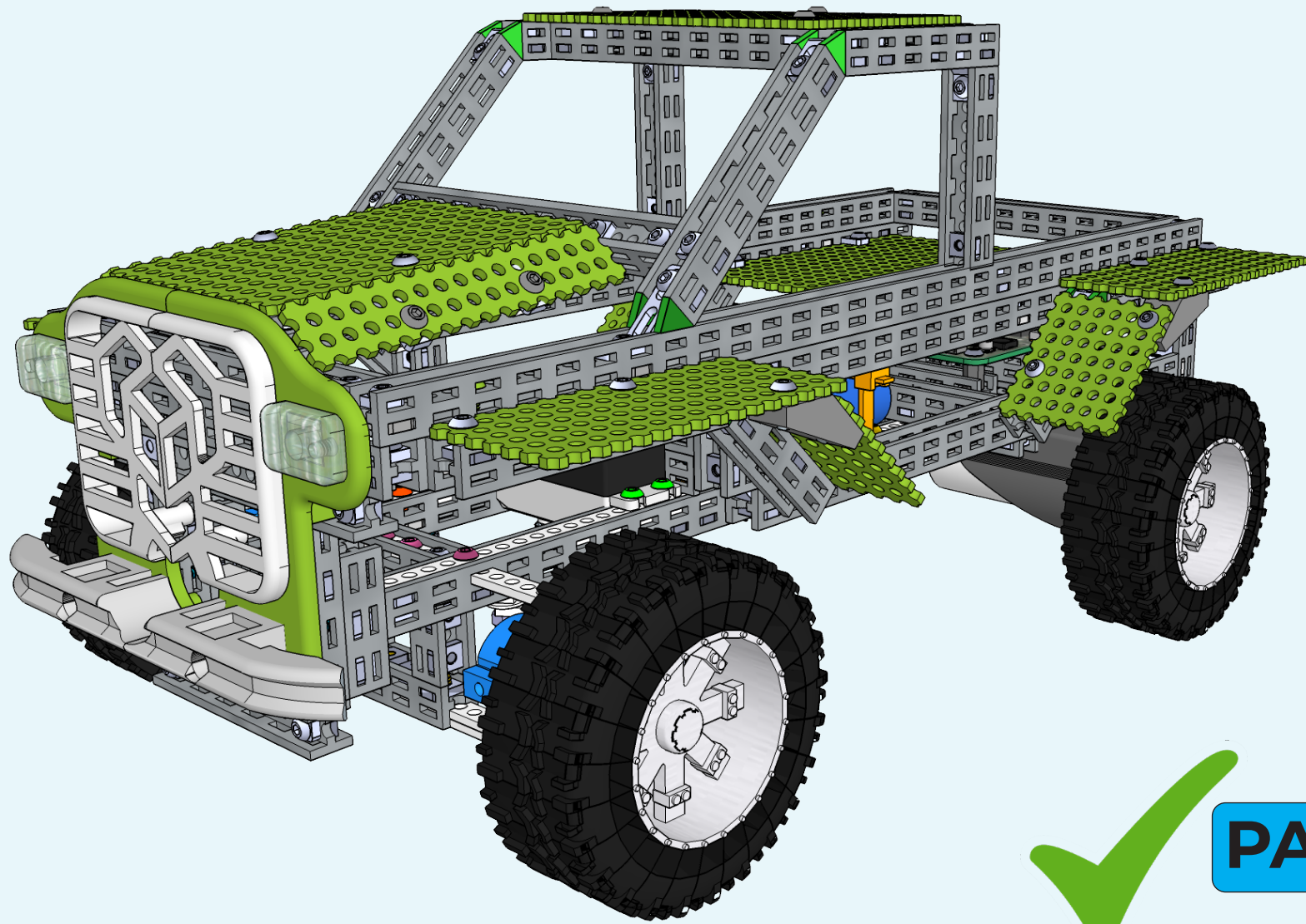

PART 11